Contents

Introduction	2
In brief	6
Keys, doors and windows	18
Seats, restraints	38
Storage	58
Instruments and controls	72
Lighting	108
Climate control	118
Driving and operating	127
Vehicle care	156
Service and maintenance	195
Technical data	199
Customer information	255
Index	256

Introduction

Fuel	Designation	<input type="text"/>		
Engine oil	Grade	<input type="text"/>		
	Viscosity	<input type="text"/>		
Tyre pressure		Tyre size	Front	Rear
	Summer tyres	<input type="text"/>	<input type="text"/>	<input type="text"/>
	Winter tyres	<input type="text"/>	<input type="text"/>	<input type="text"/>
Weights	Gross vehicle weight rating	<input type="text"/>		
	- Kerb weight, basic model	<input type="text"/>		
	= Loading	<input type="text"/>		

Vehicle specific data

Please enter your vehicle's data on the previous page to keep it easily accessible. This information is available in the sections "Service and maintenance" and "Technical data" as well as on the identification plate.

Introduction

Your vehicle is a designed combination of advanced technology, safety, environmental friendliness and economy.

This Owner's Manual provides you with all the necessary information to enable you to drive your vehicle safely and efficiently.

Make sure your passengers are aware of the possible risk of accident and injury which may result from improper use of the vehicle.

You must always comply with the specific laws and regulations of the country that you are in. These laws may differ from the information in this Owner's Manual.

When this Owner's Manual refers to a workshop visit, we recommend your Vauxhall Authorised Repairer.

All Vauxhall Authorised Repairers provide first-class service at reasonable prices. Experienced mechanics trained by Vauxhall work according to specific Vauxhall instructions.

The customer literature pack should always be kept ready to hand in the vehicle.

Using this manual

- This manual describes all options and features available for this model. **Certain descriptions, including those for display and menu functions, may not apply to your vehicle due to model variant, country specifications, special equipment or accessories.**
- The "In brief" section will give you an initial overview.
- The table of contents at the beginning of this manual and within each section shows where the information is located.

- The index will enable you to search for specific information.
- This Owner's Manual depicts left-hand drive vehicles. Operation is similar for right-hand drive vehicles.
- The Owner's Manual uses the factory engine designations. The corresponding sales designations can be found in the section "Technical data".
- Directional data, e.g. left or right, or front or back, always relate to the direction of travel.
- The vehicle display screens may not support your specific language.
- Display messages and interior labelling are written in **bold** letters.

Danger, Warnings and Cautions

Danger

Text marked  **Danger** provides information on risk of fatal injury. Disregarding this information may endanger life.

⚠ Warning

Text marked **⚠ Warning** provides information on risk of accident or injury. Disregarding this information may lead to injury.

Caution

Text marked **Caution** provides information on possible damage to the vehicle. Disregarding this information may lead to vehicle damage.

Symbols

Page references are indicated with ⇨. ⇨ means "see page".

Thank you for choosing a Vauxhall.

We wish you many hours of pleasurable driving.

Your Vauxhall Team

In brief

Initial drive information

Vehicle unlocking



Press button  to lock the doors and load compartment. Open the doors by pulling the handles. To open the tailgate, pull the button under the tailgate moulding.

Press button ; only the load compartment is unlocked and opens.

Radio remote control ⇨ 19, Central locking system ⇨ 20, Load compartment ⇨ 23.

Seat adjustment

Seat positioning



Pull handle, slide seat, release handle.

Seat position ⇨ 39, Seat adjustment ⇨ 40.

Danger

Do not sit nearer than 25 cm from the steering wheel, to permit safe airbag deployment.

Seat backrests



Pull lever, adjust inclination and release lever. Allow the seat to engage audibly.

Seat position ⇨ 39, Seat adjustment ⇨ 40.

Seat height

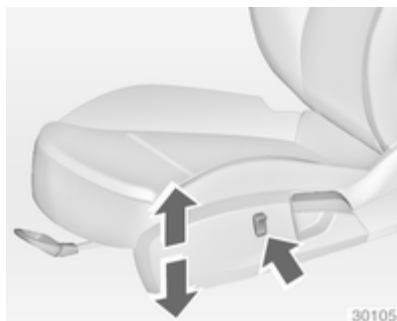

Press switch

top = seat higher
bottom = seat lower

Seat position ⇨ 39, Seat adjustment ⇨ 40.

Seat inclination

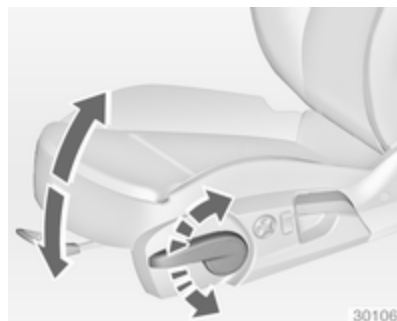

Lever pumping motion

up = front end higher
down = front end lower

Seat position ⇨ 39, Seat adjustment ⇨ 40.

Power seat adjustment



Operate switches.

- positioning = move switch (1)
forwards/backwards
- height = move switch (1)
upwards/downwards
- inclination = move switch (1)
upwards/downwards
at front
- backrest = turn switch (2)
forwards/backwards

Head restraint adjustment

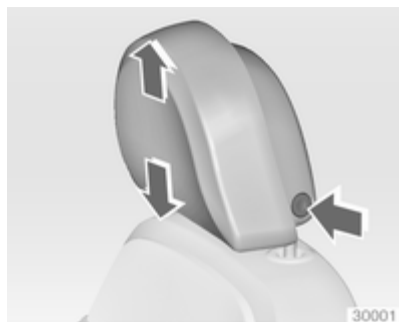

Press release button, adjust height, engage.

Head restraints ⇨ 38.

Seat belt



Pull out the seat belt and engage in belt buckle. The seat belt must not be twisted and must fit close against the body. The backrest must not be tilted back too far (maximum approx. 25°).

To release belt, press red button on belt buckle.

Seat position ⇨ 39, Seat belts
⇨ 45, Airbag system ⇨ 48.

Mirror adjustment

Interior mirror



Adjust the lever on the underside to reduce dazzle.

Interior mirror ⇨ 32, Automatic anti-dazzle interior mirror ⇨ 32.

Exterior mirrors



Select the relevant exterior mirror and adjust.

Convex exterior mirrors ⇨ 30, Electric adjustment ⇨ 30, Folding exterior mirrors ⇨ 31, Heated exterior mirrors ⇨ 31.

Steering wheel adjustment

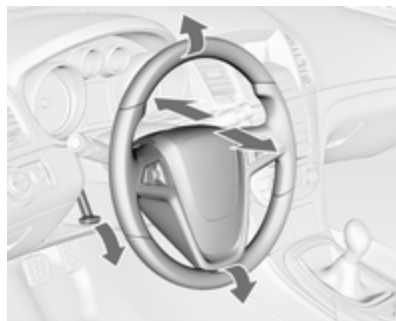

Unlock lever, adjust steering wheel, then engage lever and ensure it is fully locked. Do not adjust steering wheel unless vehicle is stationary and steering wheel lock has been released.

Airbag system ⇨ 48, Ignition positions ⇨ 128.

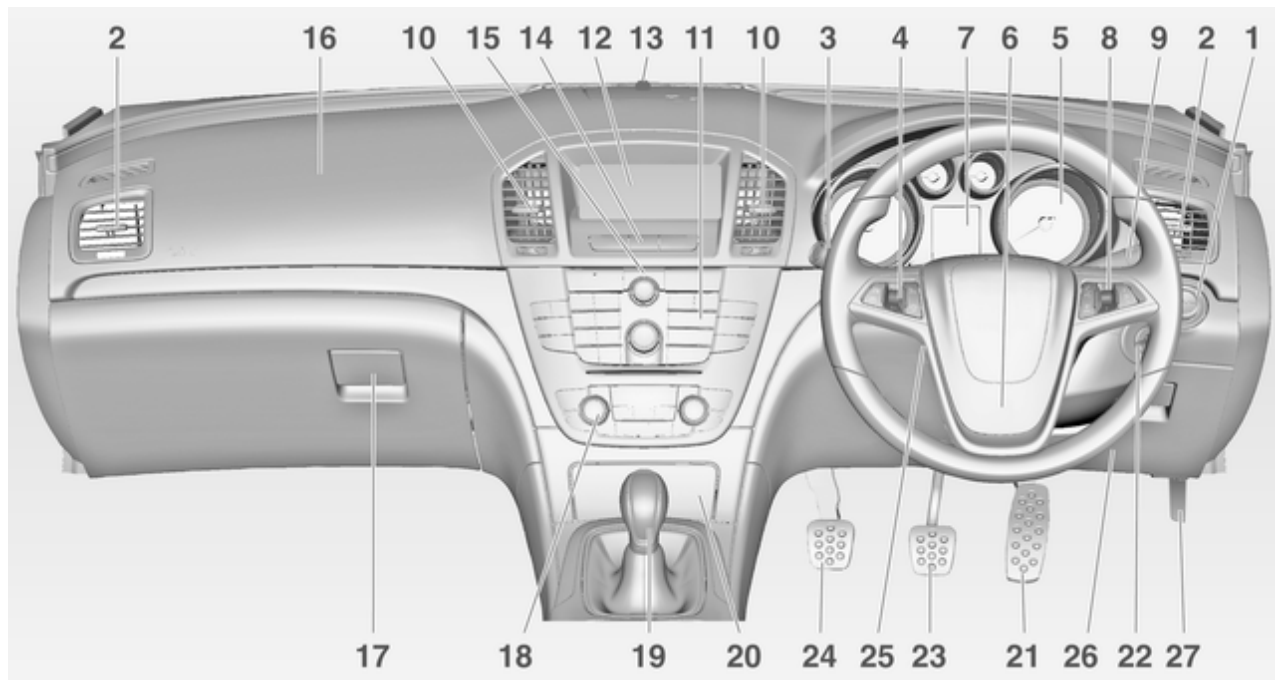

Instrument panel overview

- | | | | | | | | | |
|-----------|---|-----|-----------|---|-----|-----------|--|-----|
| 1 | Light switch | 108 | 11 | Infotainment system | 10 | 22 | Ignition switch with steering wheel lock | 128 |
| | Headlight range adjustment | 110 | 12 | Info-Display | 92 | 23 | Brake pedal | 136 |
| | Front fog lights | 113 | 13 | Anti-theft alarm system status LED | 28 | 24 | Clutch pedal | 127 |
| | Rear fog light | 114 | 14 | Central locking system | 20 | 25 | Steering wheel adjustment ... | 72 |
| | Instrument illumination | 115 | | Hazard warning flashers | 113 | 26 | Storage compartment, fuse box | 174 |
| 2 | Side air vents | 124 | | Control indicator for airbag deactivation | 85 | 27 | Bonnet release lever | 157 |
| 3 | Turn and lane-change signals, headlight flash, low beam and high beam ... | 113 | | Control indicator for front passenger seat belt | 84 | | | |
| | Exit lighting | 116 | 15 | Sport mode | 140 | | | |
| | Parking lights | 114 | | Tour mode | 140 | | | |
| | Driver Information Center | 89 | | Traction Control system | 139 | | | |
| 4 | Cruise control | 142 | | Electronic stability control . | 140 | | | |
| 5 | Instruments | 79 | | Parking assist | 143 | | | |
| 6 | Horn | 73 | | Advanced parking aid | 143 | | | |
| | Driver airbag | 49 | | Lane departure warning | 148 | | | |
| 7 | Driver Information Center | 89 | 16 | Front passenger airbag | 49 | | | |
| 8 | Steering wheel controls | 72 | 17 | Glovebox | 58 | | | |
| 9 | Windscreen wiper, windscreen washer system, headlight washer system, rear wiper | 73 | 18 | Climate control system | 118 | | | |
| 10 | Centre air vents | 124 | 19 | Selector lever, manual transmission | 135 | | | |
| | | | | Automatic transmission | 131 | | | |
| | | | 20 | Ashtray | 78 | | | |
| | | | 21 | Accelerator pedal | 127 | | | |

Exterior lighting



Turn light switch

- AUTO** = automatic light control:
Headlights are switched on and off automatically
- ⦿ = activation or deactivation of the automatic light control
- O** = off
- ⦿⦿ = sidelights
- ⦿D = headlights

Press light switch

- ⦿D = front fog lights
- ⦿# = rear fog light

Lighting ↗ 108.

Headlight flash, high beam and low beam

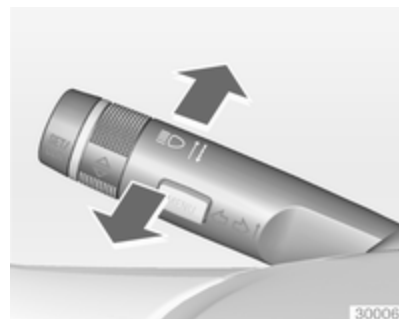

- headlight flash = pull lever
- high beam = push lever
- low beam = push or pull lever

Automatic light control ↗ 109, High beam ↗ 109, Headlight flash ↗ 109.

Turn and lane-change signals

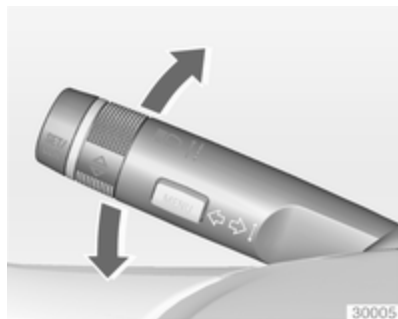

right = lever up
left = lever down

Turn and lane-change signals
↻ 113, Parking lights ↻ 114.

Hazard warning flashers



Operated with the  button.
Hazard warning flashers ↻ 113.

Horn



Press .

Washer and wiper systems

Windscreen wiper



2 = fast

1 = slow

 = interval wiping or automatic wiping with rain sensor

O = off

For a single wipe when the windscreen wiper is off, press the lever down.

Windscreen wiper ⇨ 73, Wiper blade replacement ⇨ 161.

Windscreen and headlight washer systems

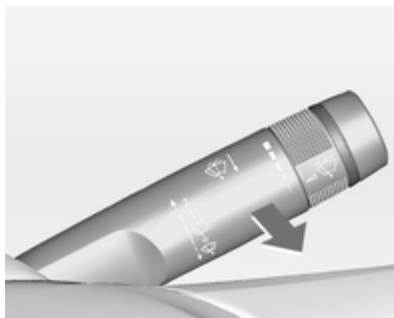

Pull lever.

Windscreen and headlight washer system ⇨ 73, Washer fluid ⇨ 160.

Rear window wiper and washer systems

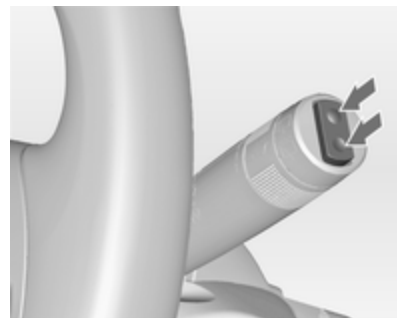

Push the rocker switch to activate the rear window wiper:

top = continuous operation
bottom = intermittent operation

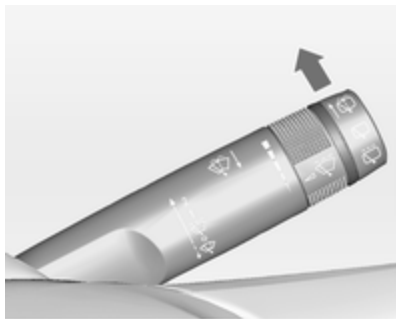

Push lever.

Washer fluid is sprayed on the rear window and the wiper wipes for a few strokes.

Climate control

Heated rear window, heated exterior mirrors



Heating is operated by pressing the  button.

Heated rear window  34.

Demisting and defrosting the windows

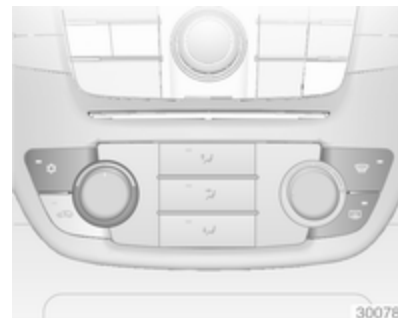

Press button .

Set temperature control to warmest level.

Cooling  on.

Heated rear window  on.

Climate control system  118.

Transmission

Manual transmission



Reverse: with the vehicle stationary, depress clutch pedal, press the release button on the selector lever and engage the gear.

If the gear does not engage, set the lever in neutral, release the clutch pedal and depress again; then repeat gear selection.

Manual transmission ↪ 135.

Automatic transmission



P = park
R = reverse
N = neutral
D = drive

Manual mode: move selector lever from **D** to the left.

+ = higher gear
- = lower gear

The selector lever can only be moved out of **P** when the ignition is on and the brake pedal is applied. To engage **P** or **R**, press the release button.

Automatic transmission ↪ 131.

Starting off

Check before starting off

- Tyre pressure and condition
 ↪ 178, ↪ 216.
- Engine oil level and fluid levels
 ↪ 158.
- All windows, mirrors, exterior lighting and number plates are free from dirt, snow and ice and are operational.
- Proper position of mirrors, seats, and seat belts ↪ 30, ↪ 39, ↪ 46.
- Brake function at low speed, particularly if the brakes are wet.

Starting the engine

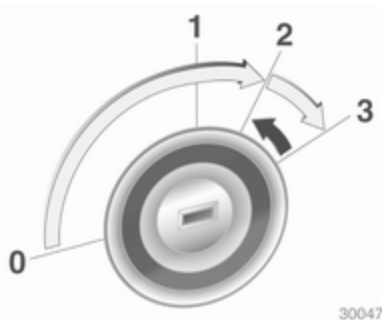

- Turn key to position 1
- move the steering wheel slightly to release the steering wheel lock
- operate clutch and brake
- automatic transmission in **P** or **N**
- do not operate accelerator pedal
- diesel engines: turn the key to position 2 for preheating and wait until control indicator  goes out
- turn key to 3 and release

Starting the engine ⇨ 128.

Parking

- Always apply the parking brake. Activate the manual parking brake without pushing the release button. Apply as firmly as possible on a downhill slope or uphill slope. Depress foot brake at the same time to reduce operating force. For vehicles with electrical parking brake pull switch .

- Switch off the engine. Turn the ignition key to 0 and remove it. Turn the steering wheel until the steering wheel lock is felt to engage.

For vehicles with automatic transmission, the key can only be removed when the selector lever is in the **P** position.

- If the vehicle is on a level surface or uphill slope, engage first gear or set the selector lever to **P** before switching off the ignition. On an uphill slope, turn the front wheels away from the kerb.

If the vehicle is on a downhill slope, engage reverse gear or set the selector lever to **P** before switching

off the ignition. Turn the front wheels towards the kerb.

- Lock the vehicle with button  on the radio remote control. Activate the anti-theft alarm system ⇨ 28.
- Do not park the vehicle on an easily ignitable surface. The high temperature of the exhaust system could ignite the surface.
- Close the windows and the sunroof.
- The engine cooling fans may run after the engine has been switched off ⇨ 157.
- After running at high engine speeds or with high engine loads, operate the engine briefly at a low load or run in neutral for approx. 30 seconds before switching off, in order to protect the turbocharger.

Keys, locks ⇨ 18, Laying the vehicle up for a long period of time ⇨ 156.

Keys, doors and windows

Keys, locks	18
Doors	23
Vehicle security	28
Exterior mirrors	30
Interior mirrors	32
Windows	33
Roof	35

Keys, locks

Keys

Replacement keys

The key number is specified in the Car Pass or on a detachable tag.

The key number must be quoted when ordering replacement keys as it is a component of the immobiliser system.

Locks ⇨ 192.

Lock cylinders

Designed to free-wheel if they are forcefully rotated without the correct key or if the correct key is not fully inserted. To reset, turn cylinder with the correct key until its slot is vertical, remove key and then re-insert it. If the cylinder still free-wheels, turn the key through 180° and repeat operation.

Key with foldaway key section



Press button to extend. To fold the key, first press the button.

Car Pass

The Car Pass contains security related vehicle data and should therefore be kept in a safe place.

When the vehicle is taken to a workshop, this vehicle data is needed in order to perform certain operations.

Radio remote control



Used to operate:

- Central locking system
- Anti-theft locking system
- Anti-theft alarm system
- Load compartment
- Power windows
- Sunroof

The radio remote control has an approximate range of up to 164 ft. It can be restricted by external influences. The hazard warning flashers confirm operation.

Handle with care, protect from moisture and high temperatures and avoid unnecessary operation.

Fault

If the central locking system cannot be operated with the radio remote control, it may be due to the following:

- Range exceeded
- Battery voltage too low
- Frequent, repeated operation of the radio remote control while not in range, which will require re-synchronisation
- Overload of the central locking system by operating at frequent intervals, the power supply is interrupted for a short time
- Interference from higher-power radio waves from other sources

Unlocking ⇨ 20.

Basic settings

Some settings can be changed in the menu **Settings** in the Info-Display. Vehicle personalisation ⇨ 102.

Radio remote control battery replacement

Replace the battery as soon as the range reduces.



Batteries do not belong in household waste. They must be disposed of at an appropriate recycling collection point.

Key with foldaway key section

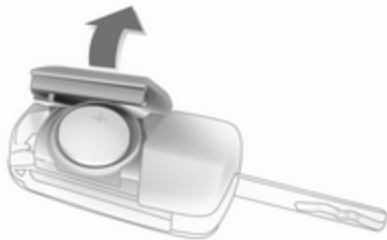

Extend the key and open the unit. Replace the battery (battery type CR 2032), paying attention to the installation position. Close the unit and synchronise.

Radio remote control synchronisation

After replacing the battery, unlock the door with the key in the driver's door lock. The radio remote control will be synchronised when you switch on the ignition.

Memorised settings

Whenever the key is removed from the ignition lock the following settings are automatically memorised by the key:

- Electronic climate control
- Lighting
- Infotainment system
- Power seats
- Power mirrors
- Central locking system
- Sport mode settings
- Comfort settings

The saved settings are automatically used the next time the memorised key is inserted into the ignition lock and switched to position 1.

Power seats already move in the saved position when unlocking and opening the driver's door with the memorised key.

Precondition is, that **Personalization by driver**, or depending on the display type, **Personalization by remote control** in the personal settings of the

Info-Display is activated. This must be set for each used key. Vehicle personalisation ⇨ 102.

Central locking system

Unlocks and locks doors, load compartment and fuel filler flap.

A pull on an interior door handle unlocks the respective door. Pulling the handle once more opens the door.

Notice



In the event of an accident in which airbags or belt pretensioners are deployed, the vehicle is automatically unlocked.

Unlocking



Press button .

Two settings are selectable:

- To unlock only the driver's door, load compartment and fuel filler flap, press button  once. To unlock all doors, press button  twice
- or
- press button  once to unlock all doors, load compartment and fuel filler flap

The setting can be changed in the menu **Settings** in the Info-Display. Vehicle personalisation ⇨ 102.

The setting can be saved for the key being used. Memorised settings ⇨ 20.

Locking

Close doors, load compartment and fuel filler flap.



Press button .

If the driver's door is not closed properly, the central locking system will not work. Vehicle personalisation ⇨ 102.

Unlocking and opening the tailgate
5-door Hatchback, Estate



Press button  when the ignition is off. The tailgate is released to be unlocked and opened by pushing the touchpad switch under the tailgate moulding.

4-door Saloon, Estate with power tailgate



Press button  when the ignition is off until tailgate opens automatically. All other doors remain locked.

Power tailgate ⇨ 23.

Central locking buttons

Locks or unlocks all doors, the load compartment and fuel filler flap from the passenger compartment.





Press the  button to lock.

Press the  button to unlock.

Fault in radio remote control system

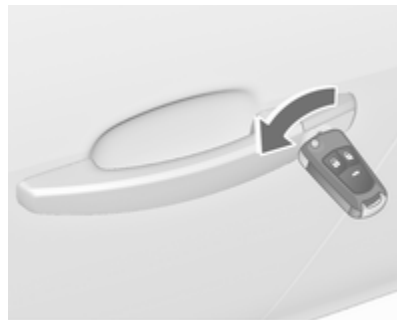
Unlocking



Manually unlock the driver's door by turning the key in the lock. Switch on the ignition and press the central locking button  to unlock all doors, load compartment and fuel filler flap. To deactivate the anti-theft locking system, switch on the ignition.

Locking

Manually lock the driver's door by turning the key in the lock.

Fault in central locking system

Unlocking

Manually unlock the driver's door by turning the key in the lock. The other doors can be opened by pulling the interior handle twice. The load compartment and fuel filler flap cannot be opened. To deactivate the anti-theft locking system, switch on the ignition ⇨ 28.

Locking

Push inside locking knob of all doors except driver's door. Then close the driver's door and lock it from the outside with the key. The fuel filler flap and tailgate cannot be locked.

Child locks



⚠ Warning

Use the child locks whenever children are occupying the rear seats.

Using a key or suitable screwdriver, turn the child lock in the rear door to the horizontal position. The door cannot be opened from the inside. For deactivation turn the child lock to the vertical position.

Doors

Load compartment

Tailgate

Opening

5-door Hatchback, Estate

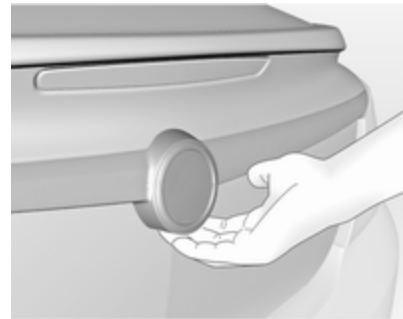

After unlocking pull the button under the tailgate moulding and open the tailgate manually.

4-door saloon



With radio remote control press button  until the tailgate is opened automatically. Or pull the button under the tailgate moulding after unlocking.

Central locking system ⇨ 20.

Closing

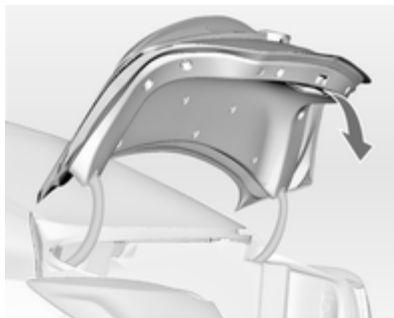

Use the interior handle.

Do not pull the button under the moulding whilst closing as this will unlock the tailgate again.

Central locking system ⇨ 20.



Power tailgate

Warning

Take care when operating the power tailgate. Risk of injury, particularly to children.

Keep a close watch on the movable tailgate when operating. Ensure that nothing becomes trapped during operating and no one is standing within the moving area.

The power tailgate is operated by:

- Radio remote control button 
- Switch  in the door panel of the driver's door
- Touchpad switch and button  in the tailgate.

On vehicles with automatic transmission the tailgate can only be operated when vehicle is stationary with applied parking brake and automatic transmission in **P**.

The taillights flash and a chime sounds when the power tailgate is operating.

Notice

Operating the power tailgate does not operate the central locking system. To open the tailgate with the remote control, it is not necessary to unlock the vehicle. Unlock the vehicle first, when operating with the touchpad switch or the switch in the driver's door. Lock the vehicle after closing.

Central locking system ⇨ 20.

Operation with radio remote control

Press and hold button  until the tailgate starts to open or close.

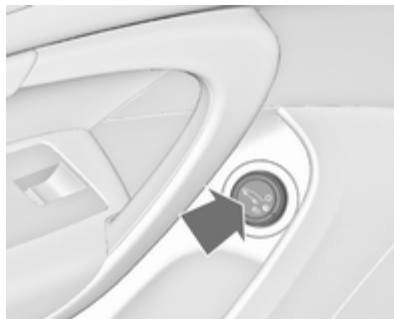
Operation with the switch in the driver's door

Press and hold button  until the tailgate starts to open or close.



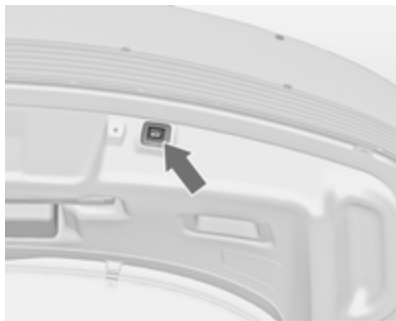

Operation with switches in the tailgate

To open the tailgate, push and hold the touchpad switch under the tailgate moulding until the tailgate starts to move.



To close, press the button  in the open tailgate until it starts to move.



Stop or change direction of movement

Pressing button  or  or the touchpad switch whilst moving, the tailgate will stop in the current position. Pressing button  or  again will reverse the direction of movement.

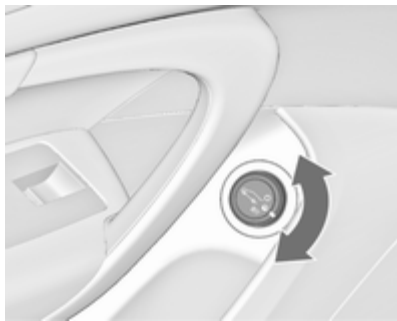

Operation modes

The power tailgate has three modes of operation, which are controlled by the switch in the driver's door. To change the mode turn the switch:



- Normal mode : power tailgate opens to full height
- Intermediate mode : power tailgate opens to a reduced height that can be adjusted
- Mode **Off**: tailgate can only be operated manually.

Adjust reduced opening height in intermediate mode

1. Turn operation mode switch to  or 
2. Open power tailgate with any operation switch

3. Stop movement at the desired height by pressing any operation switch. If required, manually move the stopped tailgate to the desired position
4. Press and hold the button on the inside of the open tailgate for 3 seconds.



A chime sound indicates the new setting.

When turning the adjuster wheel in the driver's door to intermediate mode , the power tailgate will stop opening at the newly set position.

The tailgate can only be held open if a minimum height is exceeded. The opening height cannot be programmed below that height.

Safety function

If the power tailgate encounters an obstacle during opening or closing, the direction of movement will automatically be reversed slightly. Multiple obstacles in one power cycle will deactivate the function. In this case close or open the tailgate manually.

The power tailgate has pinch sensors on the side edges. If the sensors detect obstacles between tailgate and chassis, the tailgate will open, until it is activated again or closed manually.

The safety function is indicated by a warning chime.

Remove all obstacles for resuming normal power operation.

If the vehicle is equipped with a factory-fitted towing equipment and a trailer is electrically connected, the power tailgate can only be opened with the touchpad switch or closed

with the button  in the open tailgate. Ensure that there are no obstacles in the moving area.

General hints for operating tailgate

Warning

Do not drive with the tailgate open or ajar, e.g. when transporting bulky objects, since toxic exhaust gases, which can not be seen or smelled, could enter the vehicle. This can cause unconsciousness and even death.

Caution

Before opening the tailgate check overhead obstructions, such as a garage door, to avoid damage of the tailgate. Always check the moving area above and behind the tailgate.

Notice

Power tailgate: if the hydraulic lifters of the open tailgate lose pressure, the taillights will flash and a chime will sound. The tailgate will remain open for a while and then close slowly. Seek the assistance of a workshop.

Notice

The operation of the power tailgate is disabled under low battery condition. In this case the tailgate can be operated manually.

Notice

With the power tailgate disabled and all doors unlocked, the tailgate can be manually operated. In this case, manually closing the tailgate requires significantly greater force.

Notice

The installation of certain heavy accessories onto the tailgate may affect its ability to remain open.

Vehicle security

Anti-theft locking system

Warning

Do not use the system if there are people in the vehicle! The doors cannot be unlocked from the inside.

The system deadlocks all the doors. All doors must be closed or the system cannot be activated.

If the ignition was on, the driver's door must be opened and closed once so that the vehicle can be secured.

Unlocking the vehicle disables the mechanical anti-theft locking system. This is not possible with the central locking button.

Activating



Press  on the radio remote control twice within 15 seconds.

Anti-theft alarm system

The anti-theft alarm system is operated in conjunction with the central locking system.

It monitors:

- Doors, tailgate, bonnet
- Passenger compartment including adjoining load compartment
- Vehicle inclination, e.g. if it is raised
- Ignition

Activation

- Self-activated 30 seconds after locking the vehicle (initialisation of the system)
- Directly by pressing  on the radio remote control once more after locking

Notice

Changes to the vehicle interior such as the use of seat covers, and open windows or sunroof, could impair the function of passenger compartment monitoring.

Activation without monitoring of passenger compartment and vehicle inclination



Switch off the monitoring of passenger compartment and vehicle inclination when animals are being left in the vehicle, because of high volume ultrasonic signals or movements triggering the alarm. Switch off as well when the vehicle is on a ferry or train.

1. Close tailgate, bonnet, windows and sunroof.
2. Press button . LED in the button illuminates for a maximum of 10 minutes.
3. Close doors.
4. Activate the anti-theft alarm system.

Status message is displayed in the Driver Information Center.

Status LED



Status LED is integrated in the sensor on top of the instrument panel.

Status during the first 30 seconds of anti-theft alarm system activation:

LED = test, arming delay.
illuminates
LED flashes = doors, tailgate or quickly bonnet not completely closed, or system fault.

Status after system is armed:

LED flashes = system is armed.
slowly
LED flashes = system is disarmed.
quickly
3 times after
unlocking

Seek the assistance of a workshop in the event of faults.

Deactivation

Unlocking the vehicle deactivates anti-theft alarm system.

Alarm

When triggered, the alarm sounds via a separate battery-backed power sounder, and the hazard warning

lights flash simultaneously. The number and duration of alarm signals are stipulated by legislation.

The alarm can be silenced by pressing any button of the radio remote control or by switching on the ignition.

The anti-theft alarm system can be deactivated only by pressing button  or by switching on the ignition.

If the vehicle's battery is to be disconnected (e.g. for maintenance work), the alarm siren must be deactivated as follows: switch the ignition on then off, then disconnect the vehicle's battery within 15 seconds.

Immobiliser



The system is part of the ignition lock and checks whether the vehicle is allowed to be started with the key being used.

The immobiliser is going to be activated automatically after the key has been removed from the ignition lock.

If the control indicator  flashes when the ignition is on, there is a fault in the system; the engine cannot be started. Switch off the ignition and then repeat the start attempt.

If the control indicator continues flashing, attempt to start the engine using the spare key and seek the assistance of a workshop.

Notice

The immobiliser does not lock the doors. You should always lock the vehicle after leaving it and switch on the anti-theft alarm system  20,  28.

Control indicator   88.

Exterior mirrors

Convex shape

The convex exterior mirror reduces blind spots. The shape of the mirror makes objects appear smaller, which will affect the ability to estimate distances.

Electric adjustment



Select the relevant exterior mirror by turning the control to left (L) or right (R). Swivel the control to adjust the mirror.

In position 0 no mirror is selected.

Folding



For pedestrian safety, the exterior mirrors will swing out of their normal mounting position if they are struck with sufficient force. Reposition the mirror by applying slight pressure to the mirror housing.

Electric folding



Turn control to **0**, then push the control down. Both exterior mirrors will fold.

Push the control down again; both exterior mirrors return to their original position.

If an electrically folded mirror is manually extended, pressing down the control will only electrically extend the other mirror.

Heated



Operated by pressing the  button. Heating works with the engine running and is switched off automatically after a short time.

Parking assist

The exterior mirror on the passenger side is automatically aimed at the rear tyres as a parking aid when reverse gear is selected, except during trailer operation.

Activation or deactivation of this function can be changed in the menu **Settings** in the Info-Display. Vehicle personalisation ↻ 102.

Interior mirrors

Manual anti-dazzle

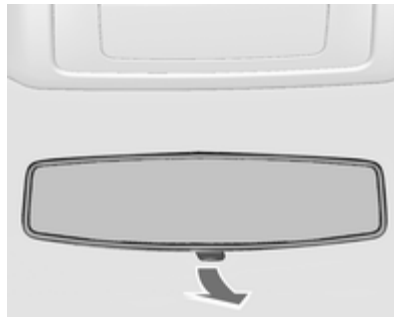

To reduce dazzle, adjust the lever on the underside of the mirror housing.

Automatic anti-dazzle



Dazzle from following vehicles at night is automatically reduced.

Windows

Manual windows

The door windows can be opened or closed with the window winders.

Power windows

Warning

Take care when operating the power windows. Risk of injury, particularly to children.

If there are children on the rear seats, switch on the child safety system for the power windows.

Keep a close watch on the windows when closing them. Ensure that nothing becomes trapped in them as they move.

Switch on ignition to operate power windows.



Operate the switch for the respective window by pushing to open or pulling to close.

Pushing or pulling gently to the first detent: window moves up or down as long as the switch is operated.

Pushing or pulling firmly to the second detent and then releasing: window moves up or down automatically with enabled safety function. To stop movement, operate the switch once more in the same direction.

Safety function



If the window glass encounters resistance above the middle of the window during automatic closing, it is immediately stopped and opened again.

Override safety function

In the event of closing difficulties due to frost or the like, pull and hold the switch. The window moves up without safety function. To stop movement, release and pull the switch once more.

Child safety system for rear windows



Press switch  to deactivate rear door power windows, the LED illuminates. To activate, press  again.

Operating windows from outside

The windows can be operated remotely from outside the vehicle.



Press and hold  button to open windows.

Press and hold  button to close windows.

Release button to stop window movement.

Overload

If the windows are repeatedly operated within short intervals, the window operation is disabled for some time.

Initialising the power windows

If the windows cannot be closed automatically (e.g. after disconnecting the vehicle battery), a warning message or a warning code is displayed in the Driver Information Center.

Vehicle messages  94.

Activate the window electronics as follows:

1. Close doors.
2. Switch on ignition.
3. Pull switch until the window is closed and keep pulling for additional 2 seconds.
4. Repeat for each window.

Heated rear window



Operated by pressing the  button.

Heating works with the engine running and is switched off automatically after a short time.

Depending on the engine type, the heated rear window comes on automatically when the diesel particle filter is being cleaned.

Sun visors

The sun visors can be folded down or swivelled to the side to prevent dazzling.

Sun visors swivelled to the side can be adjusted in length.

If the sun visors have integral mirrors, the mirror covers should be closed when driving.

Roller blinds

To reduce sunlight at the rear seats, pull the blind upwards using the grip and engage it at the top of the door frame.

Roof

Sunroof

⚠ Warning



Take care when operating the sunroof. Risk of injury, particularly to children.



Keep a close watch on the movable parts when operating them. Ensure that nothing becomes trapped in them as they move.

Sunroof, Saloon/Hatchback





Open or close

Press  or  gently to the first detent: sunroof is opened or closed with enabled safety function as long as the switch is operated.

Press  or  firmly to the second detent and then release: the sunroof is opened or closed automatically with enabled safety function. To stop movement, operate the switch once more.

Raise or close

Press  or : sunroof is raised or closed automatically with enabled safety function.

If the sunroof is raised, it can be opened in one step by pushing .

Sunblind

The sunblind is manually operated.

Close or open the sunblind by sliding. When the sunroof is open, the sunblind is always open.

Sunroof, Estate





Open

Press  gently to the first detent: sunroof is opened to the spoiler position.

Press  firmly to the second detent and then release: the sunroof is opened automatically with enabled safety function. To stop movement, operate the switch once more.

Close



Press  gently to the first detent: sunroof is closed from fully open or spoiler position with enabled safety function as long as the switch is operated.

Press  firmly to the second detent and then release: the sunroof is completely closed automatically with enabled safety function. To stop movement, operate the switch once more.

Sunblind

The sunblind is power operated.



Close or open the sunblind by pressing button  or .

Safety function

If the sunblind encounters resistance during automatic closing, it is immediately stopped and opened again.

General hints

Function standby

Switch on ignition to operate the sunroof.

Safety function

If the sunroof encounters resistance during automatic closing, it is immediately stopped and opened again.

Override safety function

In the event of closing difficulties due to frost or the like, hold the switch  pressed to the second detent. The sunroof closes without safety function. To stop movement, release the switch.

Closing sunroof from outside

The sunroof can be closed remotely from outside the vehicle.

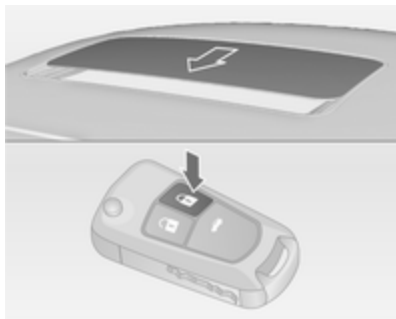



Press and hold  button to close the sunroof.

Release the button to stop the movement.



Initialising of the roof

If the sunroof cannot be closed (e.g. after disconnecting the vehicle battery), activate the sunroof electronics as follows:



- If sunroof is closed, keep the switch  pressed for 10 seconds.
- If sunroof is open, keep the switch  pressed until sunroof is fully closed. Then release switch shortly and press it again for 10 seconds.

Relearning of safety function

If the sunroof does not close correctly after initialising:

1. Open sunroof fully by pressing switch .
2. Release switch and then press switch  again gently to the first detent for approx. 30 seconds. Then close sunroof by pressing switch  until the sunroof is fully closed.

Initialising and relearning of the power operated sun blind

Repeat the previous steps using the switches  for closing and  for opening.

Seats, restraints

Head restraints	38
Front seats	39
Rear seats	45
Seat belts	45
Airbag system	48
Child restraints	52

Head restraints

Position

Warning

Only drive with the head restraint set to the proper position.

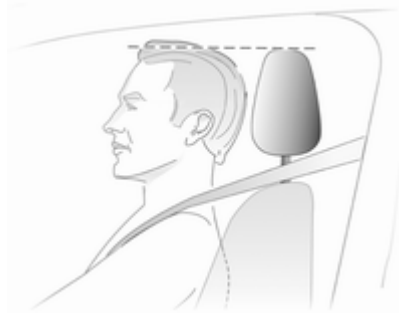

The upper edge of the head restraint should be at upper head level. If this is not possible for extremely tall people, set to highest position, and set to lowest position for small people.

Adjustment

Head restraints on front seats

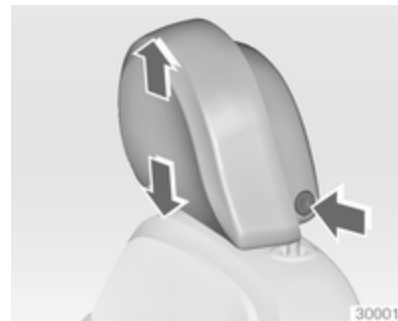

Height adjustment

Press the button, adjust height and engage.



Inclination adjustment

Swivel the bottom edge of the head restraint forwards or rearwards.

Active head restraints on front seats

In the event of a rear-end impact, the front parts of the active head restraints are moved slightly forwards. Thus the head is supported so that the risk of whiplash injury is reduced.

Notice

Approved accessories may only be attached, if the seat is not in use.

Head restraints on rear seats



Height adjustment

Pull the head restraint upwards or press the catch to release and push the head restraint downwards.

Front seats

Seat position

⚠ Warning

Only drive with the seat correctly adjusted.



- Sit with buttocks as far back against the backrest as possible. Adjust the distance between the seat and the pedals so that legs are slightly angled when pressing the pedals. Slide the front passenger seat as far back as possible.

- Sit with shoulders as far back against the backrest as possible. Set the backrest rake so that it is possible to easily reach the steering wheel with arms slightly bent. Maintain contact between shoulders and the backrest when turning the steering wheel. Do not angle the backrest too far back. We recommend a maximum angle of approx. 25°.
- Adjust the steering wheel ⇨ 72.
- Set seat height high enough to have a clear field of vision on all sides and of all display instruments. There should be at least one hand of clearance between head and the roof frame. Your thighs should rest lightly on the seat without pressing into it.
- Adjust the head restraint ⇨ 38.
- Adjust the height of the seat belt ⇨ 46.
- Adjust the thigh support so that there is a space approx. two fingers wide between the edge of the seat and the hollow of the knee.

- Adjust the lumbar support so that it supports the natural shape of the spine.

Seat adjustment

⚠ Danger

Do not sit nearer than 25 cm from the steering wheel, to permit safe airbag deployment.

⚠ Warning

Never adjust seats while driving as they could move uncontrollably.

Seat positioning



Pull handle, slide seat, release handle.

Seat backrests



Pull lever, adjust inclination and release lever. Allow the backrest to engage audibly.

Seat height

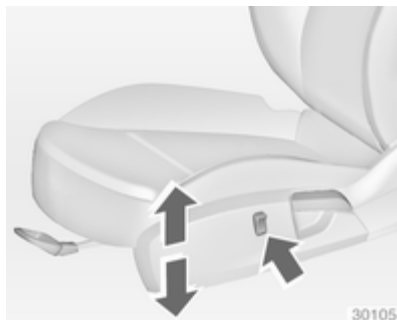

Press switch

top = seat higher
bottom = seat lower

Seat inclination

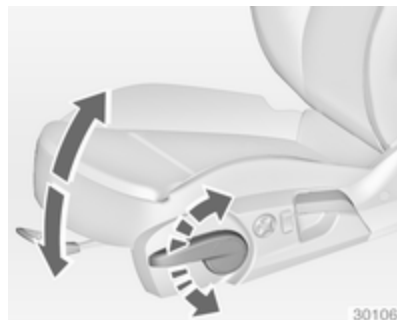

Lever pumping motion

up = front end higher
down = front end lower

Lumbar support



Adjust lumbar support using the four-way switch to suit personal requirements.

Moving support up and down: push switch up or down. Increasing and decreasing support: push switch forwards or backwards.

Adjustable thigh support

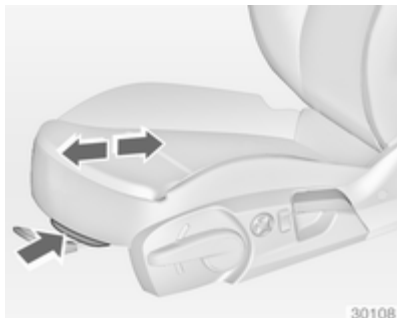

Pull the lever and slide the thigh support.

Power seat adjustment

Warning

Care must be taken when operating the power seats. There is a risk of injury, particularly for children. Articles could become trapped.

Keep a close watch on the seats when adjusting them. Vehicle passengers should be informed accordingly.

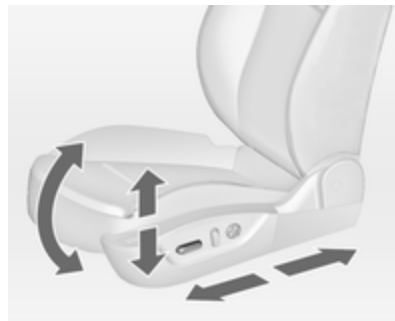

Seat positioning

Move front of switch forwards/backwards.

Seat height

Move switch upwards/downwards.

Seat inclination

Move switch upwards/downwards at front.

Seat backrests



Turn switch forwards/backwards.

Memory function for power seat adjustment and exterior mirrors

Two different seat and mirror settings can be stored.

Memorised settings ⇨ 20, Vehicle personalisation ⇨ 102.



Storing settings

- Adjust driver seat first and then exterior mirrors.
- Keep memory button **MEM** pressed and then press position button to be used (**1** or **2**). Storage is acknowledged by an acoustic signal.

Retrieving settings

- Keep position button **1** or **2** pressed until the stored seat and mirror positions have been reached.

Easy exit function

For easy exit from the vehicle, the power driver seat moves rearwards when vehicle is stationary, the key is out of the ignition switch and the driver's door is opened.

Activation or deactivation of this function can be changed in the menu **Settings** in the Info-Display. Vehicle personalisation ⇨ 102.

Overload

If the seat setting is electrically overloaded, the power supply is automatically cut-off for a short time.

Notice

After an accident in which airbags have been deployed, the position buttons will be deactivated.

Armrest

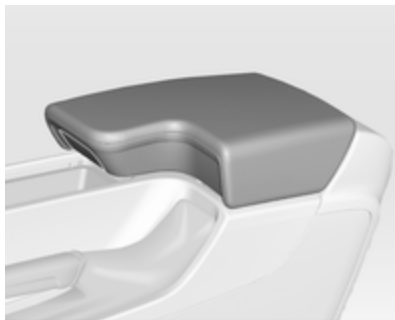

Push button and fold armrest upwards. Under the armrest there is a storage compartment.

Auxiliary devices, see description for Infotainment system.

Heating

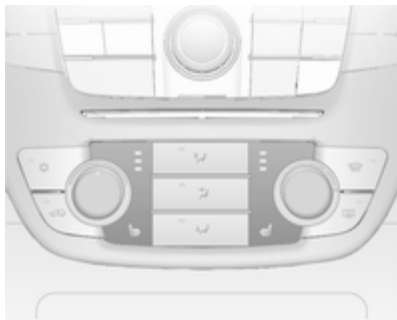

Adjust heating to the desired setting by pressing the  button for the respective seat one or more times with the ignition on. The control indicator in the button or in the display indicates the setting.

Prolonged use of the highest setting for people with sensitive skin is not recommended.

Seat heating is operational when engine is running.

Ventilating



Adjust ventilation to the desired setting by pressing the  button for the driver seat one or more times with the ignition on.

The control indicator in the display indicates the setting.

Ventilated driver seat is operational when engine is running.

Rear seats

Armrest



Fold armrest down. The armrest contains cupholders and a storage box.

Seat belts



The seat belts are locked during heavy acceleration or deceleration of the vehicle holding the occupants in the sitting position. The risk of injury is considerably reduced.

⚠ Warning

Fasten seat belt before each trip.
In the event of an accident, people not wearing seat belts endanger their fellow occupants and themselves.

Seat belts are designed to be used by only one person at a time. They are not suitable for people smaller than 5 ft (150 cm). Child restraint system ⇨ 52.

Periodically check all parts of the belt system for damage and proper functionality.

Have damaged components replaced. After an accident, have the belts and triggered belt pretensioners replaced by a workshop.

Notice

Make sure that the belts are not damaged by shoes or sharp-edged objects or are trapped. Prevent dirt from getting into the belt retractors.

Seat belt reminder 🚨 ⇨ 84.

Belt force limiters

On the front seats, stress on the body is reduced by the gradual release of the belt during a collision.

Belt pretensioners

In the event of a head-on or rear-end collision of a certain severity, the front seat belts are tightened.

⚠ Warning

Incorrect handling (e.g. removal or fitting of belts) can trigger the belt pretensioners.

Deployment of the belt pretensioners is indicated by continuous illumination of control indicator  ↻ 84.

Triggered belt pretensioners must be replaced by a workshop. Belt pretensioners can only be triggered once.

Notice

Do not affix or install accessories or other objects that may interfere with the operation of the belt pretensioners. Do not make any modifications to belt pretensioner components as this will invalidate the vehicle type approval.

Three-point seat belt**Fastening**

Withdraw the belt from the retractor, guide it untwisted across the body and insert the latch plate into the buckle. Tighten the lap belt regularly whilst driving by pulling the shoulder belt. Seat belt reminder ↻ 84



Loose or bulky clothing prevents the belt from fitting snugly. Do not place objects such as handbags or mobile phones between the belt and your body.

⚠ Warning

The belt must not rest against hard or fragile objects in the pockets of your clothing.

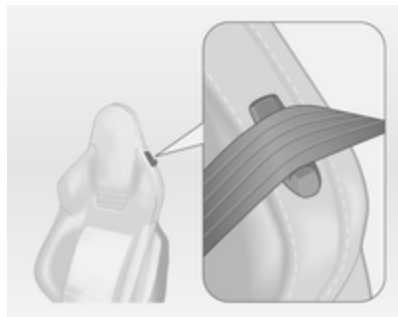
Insignia VXR

Feed seat belt through belt mount on backrest when fastening seat belt.

Height adjustment

1. Pull belt out slightly.
2. Press button.
3. Adjust height and engage.



Adjust the height so that the belt lies across the shoulder. It must not lie across the throat or upper arm.

Do not adjust while driving.

Removing



30054

To release belt, press red button on belt buckle.

Insignia VXR

Feed seat belt through belt mount on backrest after releasing.

Seat belts on the rear seats

The seat belt for the rear centre seat can only be withdrawn from the retractor if the backrest is in the rear position.

Using the seat belt while pregnant



⚠ Warning

The lap belt must be positioned as low as possible across the pelvis to prevent pressure on the abdomen.

Airbag system

The airbag system consists of a number of individual systems depending on the scope of equipment.

When triggered the airbags inflate within milliseconds. They also deflate so quickly that it is often unnoticeable during the collision.

⚠ Warning

If handled improperly the airbag systems can be triggered in an explosive manner.

Notice



The airbag systems and belt pretensioner control electronics are located in the centre console area. Do not put any magnetic objects in this area.

Do not stick anything on the airbag covers and do not cover them with other materials.

Each airbag is triggered only once. Have deployed airbags replaced by a workshop. Furthermore, it might be necessary to have the steering wheel, the instrument panel, parts of the panelling, the door seals, handles and the seats replaced.

Do not make any modifications to the airbag system as this will invalidate the vehicle type approval.

When the airbags inflate, escaping hot gases may cause burns.

Control indicator  for airbag systems  84.

Front airbag system

The front airbag system consists of one airbag in the steering wheel and one in the instrument panel on the front passenger side. These can be identified by the word **AIRBAG**.



There is also a warning label on the side of the instrument panel, visible when the front passenger door is open.

The front airbag system is triggered in the event of a front-end impact of a certain severity. The ignition needs to be switched on.

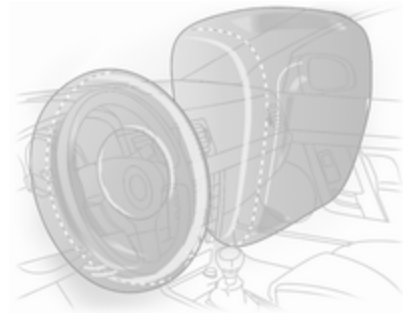

The inflated airbags cushion the impact, thereby reducing the risk of injury to the upper body and head of the front seat occupants considerably.

⚠ Warning

Optimum protection is only provided when the seat is in the proper position ⇨ 39.

Keep the area in which the airbag inflates clear of obstructions.

Fit the seat belt correctly and engage securely. Only then the airbag is able to protect.

Side airbag system



The side airbag system consists of an airbag in each front seat backrest and in the rear outboard seat backrests. This can be identified by the word **AIRBAG**.

The side airbag system is triggered in the event of a side impact of a certain severity. The ignition needs to be switched on.

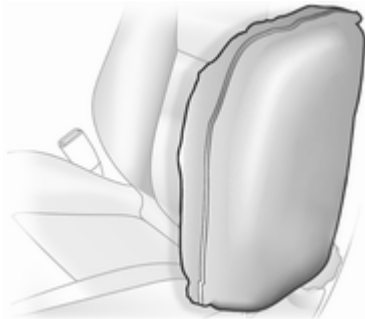

The inflated airbags cushion the impact, thereby reducing the risk of injury to the upper body and pelvis in the event of a side-on collision considerably.

⚠ Warning

Keep the area in which the airbag inflates clear of obstructions.

Notice

Only use protective seat covers that have been approved for the vehicle. Be careful not to cover the airbags.

Curtain airbag system

The curtain airbag system consists of an airbag in the roof frame on each side. This can be identified by the word **AIRBAG** on the roof pillars.

The curtain airbag system is triggered in the event of a side-on impact of a certain severity. The ignition needs to be switched on.

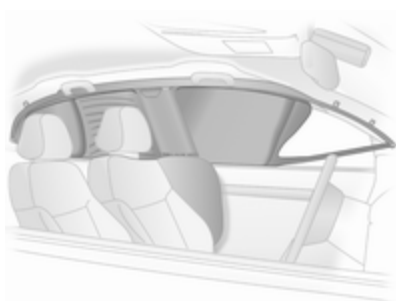

The inflated airbags cushion the impact, thereby reducing the risk of injury to the head in the event of a side-on impact considerably.

⚠ Warning

Keep the area in which the airbag inflates clear of obstructions.

The hooks on the handles in the roof frame are only suitable for hanging up light articles of clothing, without coat hangers. Do not keep any items in these clothes.



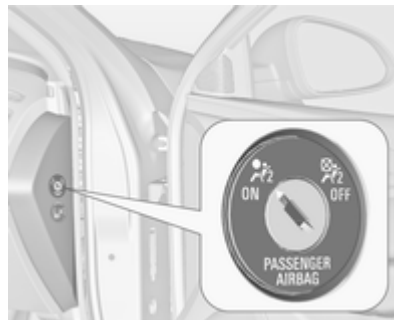

Airbag deactivation

Front airbag and side airbag systems for the front passenger seat have to be deactivated if a child restraint system is to be fitted on this seat. The curtain airbag system, the belt pretensioners and all driver airbag systems will remain active.



The front passenger airbag system can be deactivated via a key-operated switch on the right side of the instrument panel.

Use the ignition key to choose the position:

-  = front passenger airbags are deactivated and will not inflate in the event of a collision. Control indicator  illuminates continuously. A child restraint system can be installed in accordance with the chart Child restraint installation locations  54. No adult person is allowed to occupy the front passenger seat.
-  = front passenger airbags are active. A child restraint system must not be installed.

⚠ Danger

Risk of fatal injury for a child using a child restraint system on a seat with activated front passenger airbag.

Risk of fatal injury for an adult person on a seat with deactivated front passenger airbag.



Status remains until the next change.

Control indicator for airbag deactivation ↻ 85.

As long as the control indicator  is not illuminated, the airbag systems for the front passenger seat will inflate in the event of a collision.

If both control indicators are illuminated at the same time, there is a system failure. The status of the system is not discernible, therefore no person is allowed to occupy the front passenger seat. Contact a workshop immediately.

Consult a workshop immediately, if none of the two control indicators is illuminated.

Change status only when the vehicle is stopped with the ignition off.

Child restraints

Child restraint systems

We recommend the Vauxhall child restraint system which is tailored specifically to the vehicle.

When a child restraint system is being used, pay attention to the following usage and installation instructions and also those supplied with the child restraint system.

Always comply with local or national regulations. In some countries, the use of child restraint systems is forbidden on certain seats.

⚠ Danger

When using a child restraint system on the front passenger seat, the airbag systems for the front passenger seat must be deactivated; if not, the triggering of the airbags poses a risk of fatal injury to the child.

This is especially the case if rear-facing child restraint systems are used on the front passenger seat.

Selecting the right system

Children should travel facing rearwards in the vehicle as long as possible. This makes sure that the child's backbone, which is still very weak, is under less strain in the event of an accident.

Children under the age of 12 years that are smaller than 5 ft are only allowed to travel in a restraint system that is suitable for the child. Suitable are restraint systems that comply with ECE 44-03 or ECE 44-04. Since a proper position of the belt is rarely possible with a child that is smaller

than 5 ft, we strongly advise to use an appropriate child restraint system, even though this might due to the age of the child no longer be legally binding.

Ensure that the child restraint system to be installed is compatible with the vehicle type.

Ensure that the mounting location of the child restraint system within the vehicle is correct.

Allow children to enter and exit the vehicle only on the side facing away from the traffic.

When the child restraint system is not in use, secure the seat with a seat belt or remove it from the vehicle.

Notice

Do not stick anything on the child restraint systems and do not cover them with any other materials.

A child restraint system which has been subjected to stress in an accident must be replaced.

Child restraint installation locations

Permissible options for fitting a child restraint system

Weight and age class	On front passenger seat		On rear outboard seats	On rear centre seat
	activated airbag	deactivated airbag		
Group 0: up to 10 kg or approx. 10 months	X	U ¹	U ²	U ²
Group 0+: up to 13 kg or approx. 2 years	X	U ¹	U ²	U ²
Group I: 9 to 18 kg or approx. 8 months to 4 years	X	U ¹	U ²	U ²
Group II: 15 to 25 kg or approx. 3 to 7 years	X	X	U	U
Group III: 22 to 36 kg or approx. 6 to 12 years	X	X	U	U

¹ = Only if front passenger seat airbag systems are deactivated. If the child restraint system is being secured using a three-point seat belt, move seat height adjustment to uppermost position and ensure that vehicle safety belt runs forwards from the upper anchorage point.

² = Seat available with ISOFIX and Top-Tether mounting brackets.

U = Universal suitability in conjunction with three-point seat belt.

X = No child restraint system permitted in this weight class.

Permissible options for fitting an ISOFIX child restraint system

Weight class	Size class	Fixture	On front passenger seat	On rear outboard seats	On rear centre seat
Group 0: up to 10 kg	E	ISO/R1	X	IL	IL
Group 0+: up to 13 kg	E	ISO/R1	X	IL	IL
	D	ISO/R2	X	IL	IL
	C	ISO/R3	X	IL	IL
Group I: 9 to 18 kg	D	ISO/R2	X	IL	IL
	C	ISO/R3	X	IL	IL
	B	ISO/F2	X	IL, IUF	IL, IUF
	B1	ISO/F2X	X	IL, IUF	IL, IUF
	A	ISO/F3	X	IL, IUF	IL, IUF

IL = Suitable for particular ISOFIX restraint systems of the 'specific-vehicle', 'restricted' or 'semi-universal' categories. The ISOFIX restraint system must be approved for the specific vehicle type.

IUF = Suitable for ISOFIX forward-facing child restraint systems of universal category approved for use in this weight class.

X = No ISOFIX child restraint system approved in this weight class.

ISOFIX size class and seat device

- A – ISO/F3 = Forward-facing child restraint system for children of maximum size in the weight class 9 to 18 kg.
- B – ISO/F2 = Forward-facing child restraint system for smaller children in the weight class 9 to 18 kg.
- B1 – ISO/F2X = Forward-facing child restraint system for smaller children in the weight class 9 to 18 kg.
- C – ISO/R3 = Rear-facing child restraint system for children of maximum size in the weight class up to 13 kg.
- D – ISO/R2 = Rear-facing child restraint system for smaller children in the weight class up to 13 kg.
- E – ISO/R1 = Rear-facing child restraint system for young children in the weight class up to 13 kg.

ISOFIX child restraint systems



Fasten vehicle-approved ISOFIX child restraint systems to the ISOFIX mounting brackets. Specific vehicle ISOFIX child restraint system positions are marked in the table by IL.

Either two ISOFIX child restraint systems can be installed on the outboard rear seats at the same time or one on the centre rear seat. They cannot be installed right next to each other.

ISOFIX mounting brackets are indicated by a label on the backrest.

Top-tether fastening eyes

Top-Tether fastening eyes for a child restraint system are marked with the symbol .



Open the flap of the required fastening eye marked with the symbol .



In addition to the ISOFIX mounting, fasten the Top-Tether strap to the Top-Tether fastening eyes. The strap must run between the two guide rods of the head restraint.

ISOFIX child restraint systems of universal category positions are marked in the table by IUF.

Storage

Storage compartments	58
Load compartment	60
Roof rack system	70
Loading information	70

Storage compartments

Glovebox



The glovebox features a pen holder and a coin holder.

The glovebox should be closed whilst driving.

Cupholders



Cupholders are located in the centre console.



Additional cupholders are located in the rear armrest. Fold down armrest.

Front storage

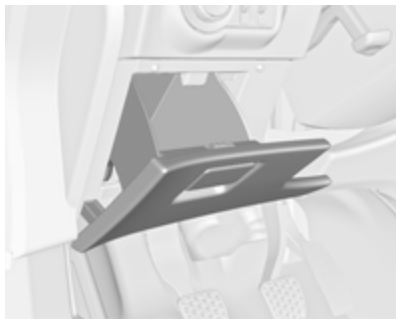

A storage compartment is located next to the steering wheel.

Sunglasses storage

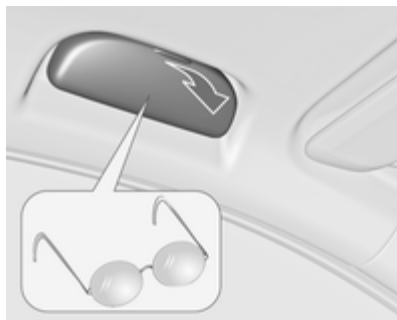

Fold down and open.
Do not use for storing heavy objects.

Armrest storage

Storage in the front armrest

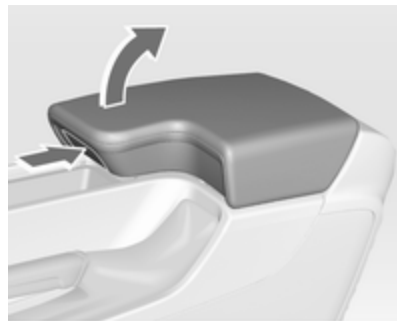

Push button to fold up the armrest.

Storage in the rear armrest



Fold down armrest and open cover.
Close cover before folding the
armrest up.

Load compartment

Folding down rear seat backrests

The rear seat backrest is divided into two parts. Both parts can be folded down.

Remove the load compartment cover if necessary.

Press and hold the catch, then push the head restraints down.

Fold up the rear armrest.



Put the seat belts of the outboard seats into the belt guides.

Pull the release lever on one or both sides and fold down the backrests onto the seat cushion.

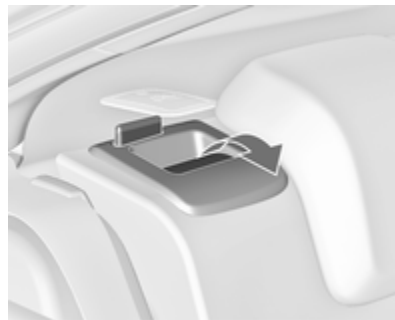

To fold up, raise backrests and guide them into an upright position until they engage audibly.

Ensure that the seat belts of the outboard seats are placed in the corresponding belt guides.



The backrests are properly engaged when both red marks on the side near the release lever are no longer visible.

⚠ Warning

Only drive the vehicle if the backrests are securely locked into position. Otherwise there is a risk of personal injury or damage to the load or vehicle in the event of heavy braking or a collision.

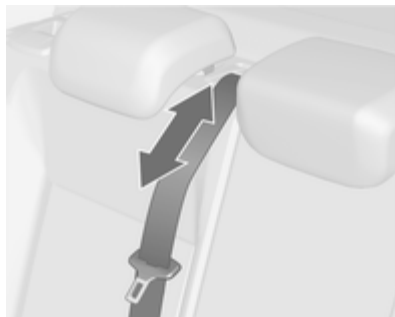

The seat belt of the centre seat could be blocked when the backrest is folded up too quickly. To unlock the retractor, push in the seat belt or pull it out by approximately 20 millimetres and then let go.

Opening the pass-through in the rear centre backrest

Fold down rear armrest.



Pull grip and open the cover.
Suitable for loading long, narrow objects.
Ensure the cover engages after folding up.



The closed cover can be secured from the side of the load compartment. Turn knob by 90°:

knob = cover secured from
horizontal the side of
the passenger room

knob = cover not secured
vertical

Storage in the load compartment

Depending on the equipment, there are storage boxes under the load compartment cover.

Load compartment cover

Do not place any objects on the cover.

5-door Hatchback

Removing



Unhook retaining straps from tailgate.

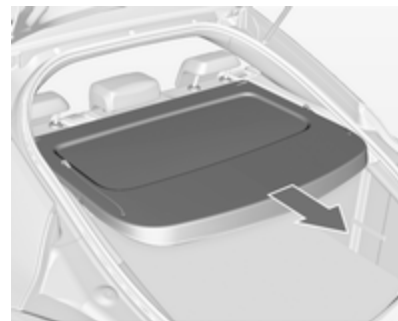

Pull cover from the side guides.

Fitting

Engage cover in side guides and fold downwards. Attach the retaining straps to the tailgate.

Estate

Closing

Pull the cover towards the rear using the handle until it engages in the sideward retainers.

Opening

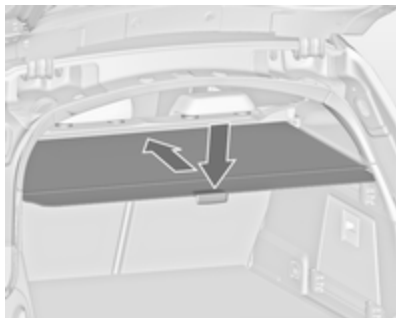

Push down the handle at the end of the cover. It rolls up automatically.

Removing

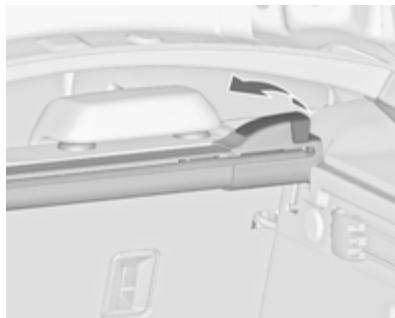

Open the load compartment cover. Pull the release lever on the right side up and hold it. Lift the cover first on the right side and remove from retainers.

The removed cover can be stored under the load compartment floor
↪ 66.

Installation

Insert the left side of the load compartment cover in the recess, pull the release lever up and hold it, insert the right side of the load compartment cover and engage.

Blind at the tailgate



To cover the load compartment completely, mount the blind at four fixing points on the inside of the tailgate.

Lashing eyes

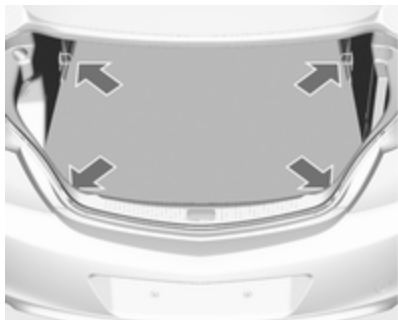

The lashing eyes are designed to secure items against slippage, e.g. using lashing straps or luggage net.

Cargo management system

The FlexOrganizer is a flexible system for dividing up the load compartment.

The system consists of

- adapters,
- mesh pockets,
- hooks,

- service box,
- strap set.

The components are fitted in rails on both side panels using adapters and hooks.

Installation of adapters in the rails

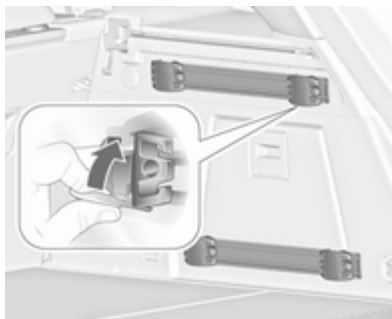

Fold open the handle plate, insert the adapter into the upper and lower groove of the rail and move to the required position. Turn the handle plate upwards to lock the adapter. To remove, turn the handle plate down and move out of the rail.

Variable partition net

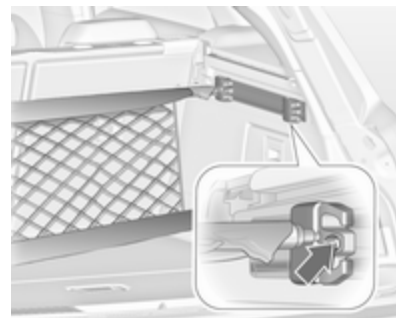

Insert adapters into the required position in the rails. Stick together the halves of the net rods.

To install, push rods together a little and insert into the relevant openings in the adapters.

To remove, press the net rods together and remove from the adapters.

Net pocket

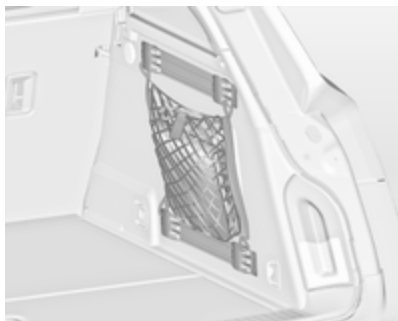

Insert adapters into the required position in the rails. The net pocket can be suspended from the adapters.

Installation of hooks in the rails



Insert the hook in the desired position first in the upper groove of the rail and then press in the lower groove. To remove, first pull out of the upper groove.

Service box

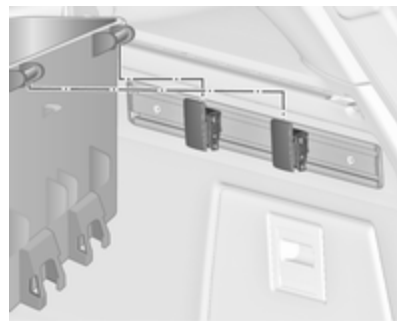

Install two hooks in the upper rail. Insert the upper brackets of the box from above into the hooks.

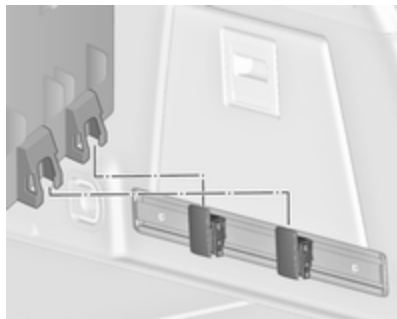

Alternatively install both hooks in the lower rail. Plug in the lower brackets of the box from above into the lower hooks.

Strap set

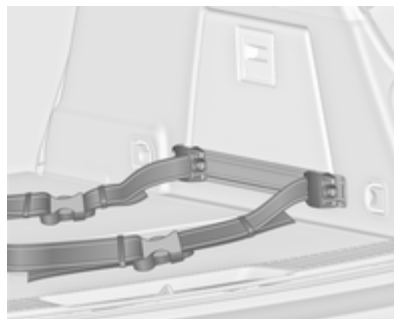

Insert the adapters of the strap set in a rail. Make sure that the belt is not twisted.

The strap set has two locks to open. The belt can be tightened.

Safety net

Two different safety nets can be installed behind the front seats or the rear seats.

Passengers must not be transported behind the safety net.

Safety net behind the front seats

Push head restraints of the rear seats down and fold down rear seat backrests ↷ 60.

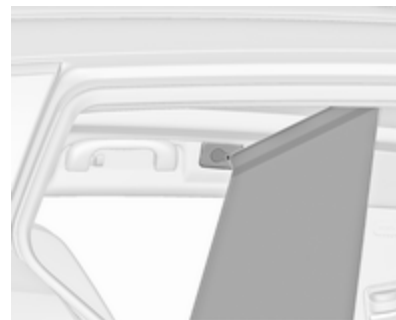

Front installation openings in the roof frame: latch rod of the net at one side, compress rod and latch at the other side.

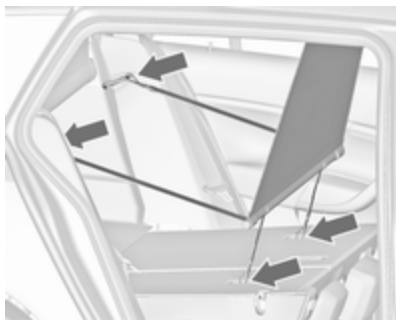

Fit the hooks of the small belts into the Top-Tether mounting loops on the back side of the folded rear seat backrests.

Fit the hooks of the wider belts into the locking devices of the rear seat backrests.

Safety net cassette behind the rear seats

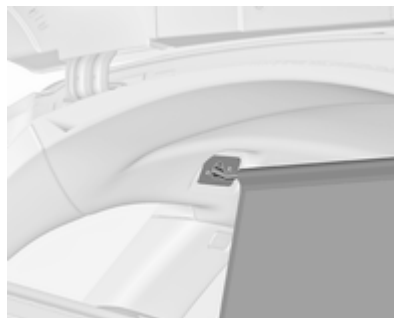

Pull out the net from the cassette and latch the rod of the net at one side into the rear installation opening in the roof frame. Compress the rod and latch at the other side.

Removal of the cassette

Roll up safety net.

Remove load compartment cover
⇨ 62.

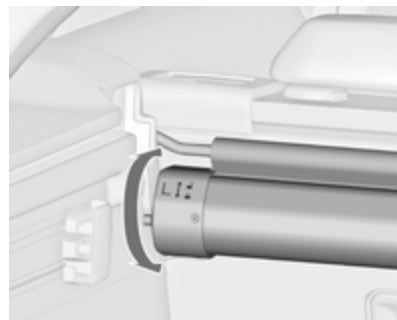

To unlock, turn cassette slightly backwards and remove it upwards from the retainers.

Installation of the cassette

Remove load compartment cover.

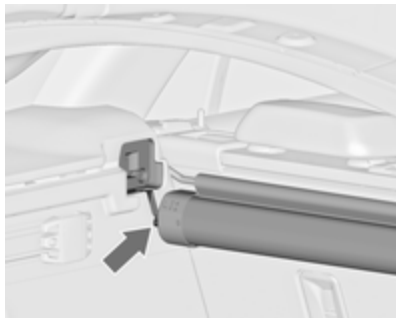

Insert the cassette into the retainers on left and right side. Note the signs **L** (left side) and **R** (right side) on the cassette as an installation hint.

Turn cassette slightly forwards to lock.

Storage of safety nets and load compartment cover

Rear safety net cassette can be placed, together with the load compartment cover and the coiled up safety net, under the load compartment floor.

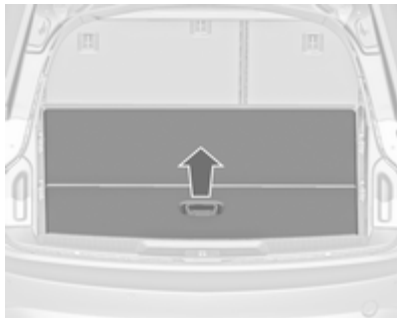

Open the load compartment floor by pulling the handle. Fold and place the floor behind the rear seats.

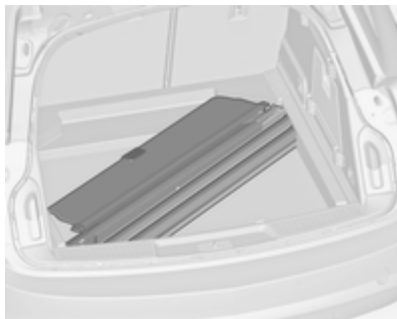

Put the load compartment cover into the hollow with the upper side downwards and with the release lever in the front right edge.

Warning triangle

Saloon/Hatchback

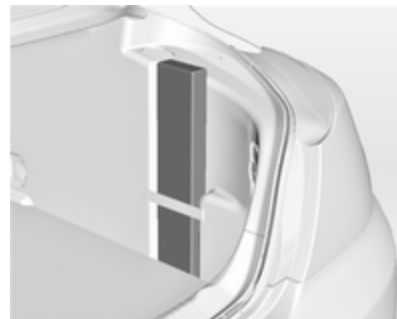

Stow the warning triangle in the space behind the strap on the right side of the load compartment.

Estate

Stow the warning triangle in the space behind the straps on the inside of the tailgate.

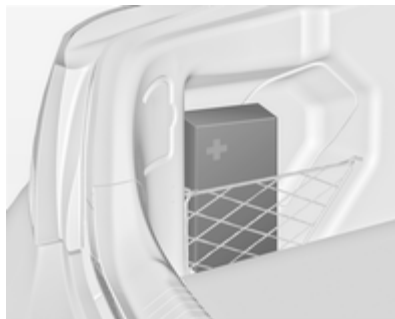
First aid kit**Saloon/Hatchback**

Stow the first aid kit in the space behind the mesh net on the left side of the load compartment.

Estate

Stow the first aid kit in the space behind a strap on the inside of the tailgate.

Roof rack system

Roof rack

For safety reasons and to avoid damage to the roof, the vehicle approved roof rack system is recommended.

Follow the installation instructions and remove the roof rack when not in use.

Mounting roof rack

Saloon/Hatchback

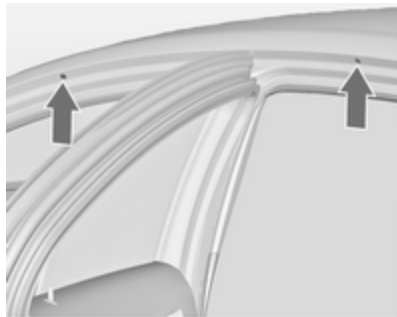

Open all doors.

Mounting points are located in each door frame of the vehicle body.

Detach the cover from each mounting point and fasten the roof rack with the attached screws.

Estate with roof railing

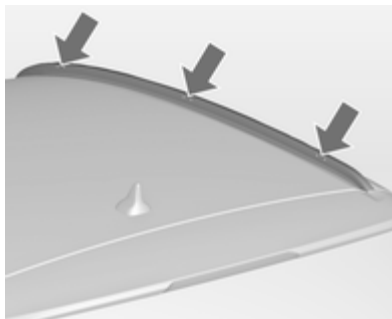

To fasten the roof rack, insert the mounting bolts in the holes indicated in the figure.

Loading information

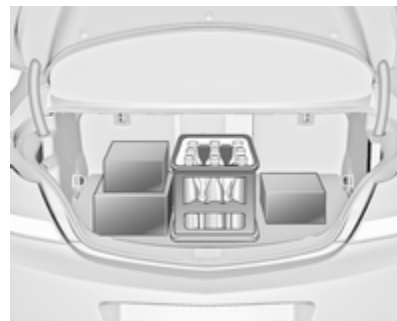

- Heavy objects in the load compartment should be placed against the seat backrests. Make sure that the backrests are securely engaged, hence no longer showing the red markings on the side near the release lever. If objects can be stacked, heavier objects should be placed at the bottom.
- Secure objects with lashing straps attached to lashing eyes ↪ 64.

- Secure loose objects in the load compartment to prevent from sliding.
- When transporting objects in the load compartment, the backrests of the rear seats must not be angled forward.
- Do not allow the load to protrude above the upper edge of the backrests.
- Do not place any objects on the load compartment cover or the instrument panel, and do not cover the sensor on top of the instrument panel.
- The load must not obstruct the operation of the pedals, parking brake and gear selector, or hinder the freedom of movement of the driver. Do not place any unsecured objects in the interior.

- Do not drive with an open load compartment.

Warning

Always make sure that the load in the vehicle is securely stowed. Otherwise objects can be thrown around inside the vehicle and cause personal injury or damage to the load or car.

- The payload is the difference between the permitted gross vehicle weight (see identification plate ⇨ 199) and the EC kerb weight.

To calculate the payload, enter the data for your vehicle in the Weights table at the front of this manual.

The EC kerb weight includes weights for the driver (68 kg), luggage (7 kg) and all fluids (tank 90 % full).

Optional equipment and accessories increase the kerb weight.

- Driving with a roof load increases the sensitivity of the vehicle to cross-winds and has a detrimental effect on vehicle handling due to the vehicle's higher centre of gravity. Distribute the load evenly and secure it properly with retaining straps. Adjust the tyre pressure and vehicle speed according to the load conditions. Check and retighten the straps frequently.

The permissible roof load is 100 kg. The roof load is the combined weight of the roof rack and the load.

Instruments and controls

Controls	72
Warning lights, gauges and indicators	79
Information displays	89
Vehicle messages	94
Trip computer	101
Vehicle personalisation	102

Controls

Steering wheel adjustment

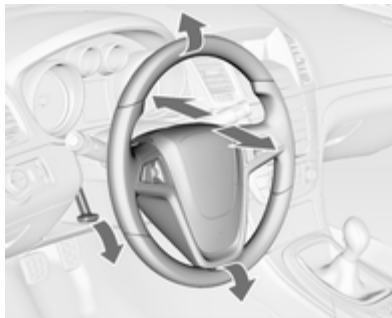

Unlock lever, adjust steering wheel, then engage lever and ensure it is fully locked.

Do not adjust steering wheel unless vehicle is stationary and steering wheel lock has been released.

Steering wheel controls



The Infotainment system and the cruise control can be operated via the controls on the steering wheel.

Further information is available in the Infotainment system manual.

Cruise control ↗ 142.

Horn





Press .

Windscreen wiper/washer

Windscreen wiper



- 2** = fast
- 1** = slow
-  = interval wiping
-  = off

For a single wipe when the windscreen wiper is off, press the lever down.

Do not use if the windscreen is frozen.

Switch off in car washes.

Adjustable wiper interval

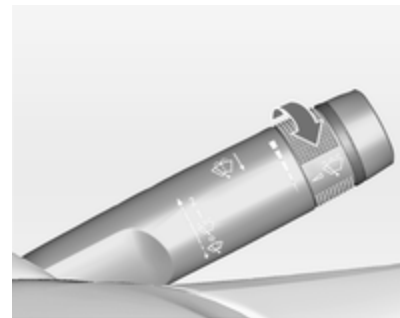



Wiper lever in position .

Turn the adjuster wheel to adjust the desired wiper interval:

- short interval = turn adjuster wheel upwards
- long interval = turn adjuster wheel downwards

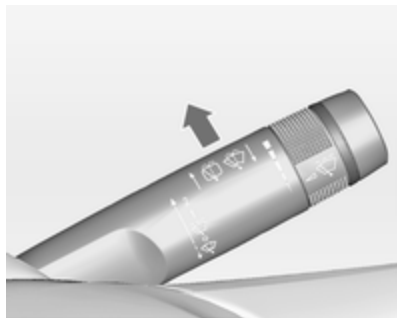
Automatic wiping with rain sensor



 = automatic wiping with rain sensor

The rain sensor detects the amount of water on the windscreen and automatically regulates the frequency of the windscreen wiper.

Adjustable sensitivity of the rain sensor

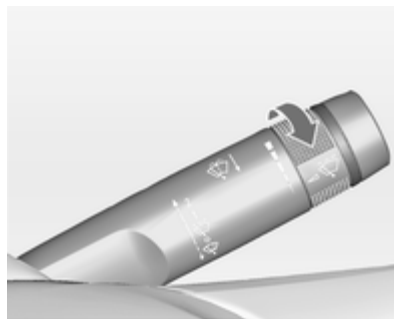

Turn the adjuster wheel to adjust the sensitivity:

low sensitivity = turn adjuster wheel downwards
high sensitivity = turn adjuster wheel upwards

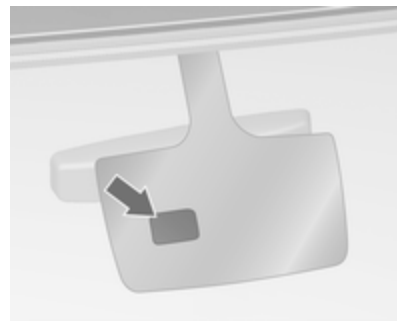

Keep the sensor free from dust, dirt and ice.

Windscreen and headlight washer



Pull lever. Washer fluid is sprayed onto the windscreen and the wiper wipes a few times.

If the headlights are on, washer fluid is also sprayed onto the headlights. Afterwards the headlight washer system is inoperative for 2 minutes .

Rear window wiper/washer

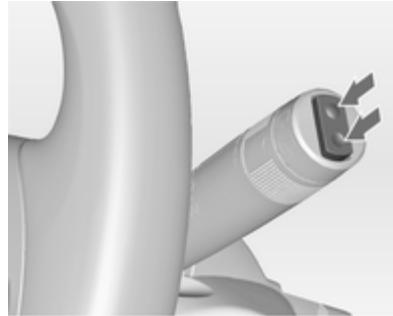

Push the rocker switch to activate the rear window wiper:

upper position	= continuous operation
lower position	= intermittent operation
middle position	= off

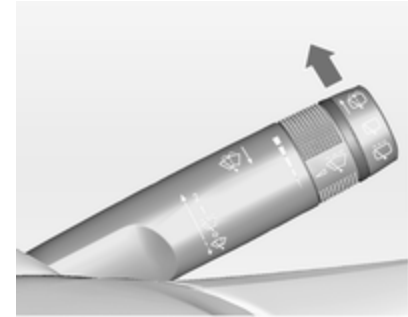

Push lever. Washer fluid is sprayed onto the rear window and the wiper wipes a few times.

The rear window wiper comes on automatically when the windscreen wiper is switched on and reverse gear is engaged.

Activation or deactivation of this function can be changed in the menu **Settings** in the Info-Display.

Vehicle personalisation ⇨ 102.



The rear window washer system is deactivated when the fluid level is low.

Outside temperature



20153

A drop in temperature is indicated immediately and a rise in temperature after a time delay.

If outside temperature drops to 3 °C, the symbol  illuminates in the Driver Information Center with Uplevel-Display or in the Info-Display as a warning for icy road conditions.  remains illuminated until temperatures reach at least 5 °C.



Additionally a warning message is displayed in the Driver Information Center with Uplevel-Display.

Warning

The road surface may already be icy even though the display indicates a few degrees above 0 °C.

Clock

Date and time are shown in the Info-Display.

Set date and time

Press the **CONFIG** button. The menu **Settings** is displayed.

Select **Time & Date**.

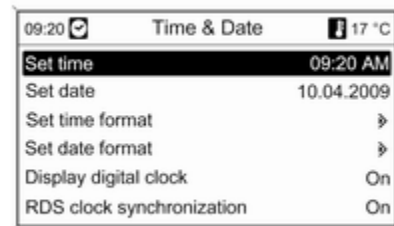

Selectable setting options:

- **Set time:** Changes the time shown on the display.
- **Set date:** Changes the date shown on the display.
- **Set time format:** Changes indication of hours between **12 hours** and **24 hours**.

- **Set date format:** Changes indication of date between **MM/DD/YYYY** and **DD.MM.YYYY**.
- **Display digital clock:** Switches on/off indication of time on the display.
- **RDS clock synchronization:** The RDS signal of most VHF transmitters automatically sets the time. RDS time synchronisation can take a few minutes. Some transmitters do not send a correct time signal. In such cases, it is recommended to switch off automatic time synchronisation.

Vehicle personalisation ⇨ 102.

Power outlets



12 V power outlets are located in the front and rear centre console.



Do not exceed the maximum power consumption of 120 watts.



A 230 V power outlet is located in the rear centre console. If ignition is on and a device is plugged in, an LED in the outlet illuminates green.

Do not exceed the maximum power consumption of 150 watts.

⚠ Danger

Power outlet works under high electrical voltage!

With ignition off the power outlets are deactivated. Additionally the power outlets are deactivated in the event of low battery voltage.

Electrical accessories that are connected must comply with the electromagnetic compatibility requirements laid down in DIN VDE 40 839.

Do not connect any current-delivering accessories, e.g. electrical charging devices or batteries.

Do not damage the outlets by using unsuitable plugs.

Cigarette lighter



The cigarette lighter is located behind the ashtray cover.

Press ashtray cover to open.



Press in cigarette lighter. It switches off automatically once the element is glowing. Pull out lighter.

Ashtrays

Caution
To be used only for ash and not for combustible rubbish.



Press ashtray cover to open.



To empty, grip both sides of the ashtray insert and remove.

Warning lights, gauges and indicators

Speedometer



Indicates vehicle speed.

Odometer



The bottom line displays the recorded distance.

Trip odometer

The top line displays the recorded distance since the last reset.

To reset, hold the reset knob depressed for a few seconds with the ignition on.

Tachometer



Displays the engine speed.

Drive in a low engine speed range for each gear as much as possible.

Caution

If the needle is in the red warning zone, the maximum permitted engine speed is exceeded. Engine at risk.

Fuel gauge



Displays the fuel level in the tank.

Control indicator ● illuminates if the level in the tank is low. Refuel immediately.

Never run the tank dry.

Because of the fuel remaining in the tank, the top-up quantity may be less than the specified tank capacity.

Engine coolant temperature gauge



Displays the coolant temperature.

left area = engine operating temperature not yet reached

central area = normal operating temperature

right area = temperature too high

Caution

If engine coolant temperature is too high, stop vehicle, switch off engine. Danger to engine. Check coolant level.

Service display

The engine oil life system lets you know when to change the engine oil and filter. Based on driving conditions, the interval at which an engine oil and filter change will be indicated can vary considerably.

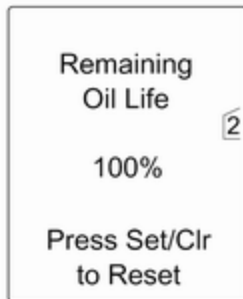

In the Uplevel-Display the remaining oil life duration is displayed in the **Vehicle Information Menu**.

In the Midlevel-Display the remaining engine oil life duration is displayed by the control indicator , thereby the ignition has to be switched on, but engine not running.

The menu and function can be selected via the buttons on the turn signal lever.

To display the remaining engine oil life duration:

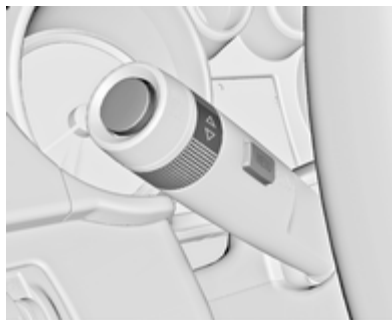

Press the **MENU** button to select the **Vehicle Information Menu**.

Turn the adjuster wheel to select **Remaining Oil Life**.

The system must be reset every time the engine oil is changed to allow proper functionality. Seek the assistance of a workshop.

Press the **SET/CLR** button to reset while applying the brake pedal. Thereby the ignition has to be switched on but engine not running.

When the system has calculated that engine oil life has been diminished, **Change Engine Oil Soon** or a warning code appears in the Driver Information Center. Have engine oil and filter changed by a workshop within one week or 300 miles (whichever occurs first).

Driver Information Center  89.

Service information  195.

Control indicators

The control indicators described are not present in all vehicles. The description applies to all instrument versions. When the ignition is

switched on, most control indicators will illuminate briefly as a functionality test.

The control indicator colours mean:

red = danger, important
reminder

yellow = warning, information, fault

green = confirmation of activation

blue = confirmation of activation

white = confirmation of activation

Control indicators in the instrument cluster

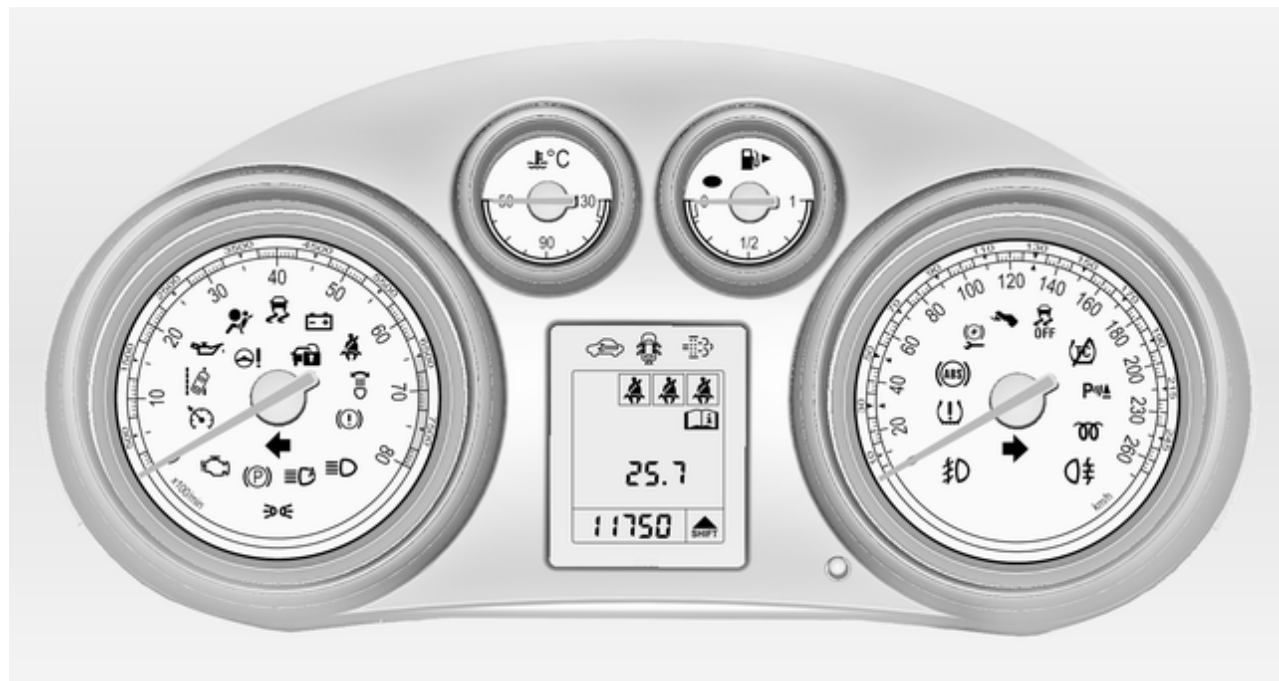

Control indicators in the centre console



Turn signal

↔ illuminates or flashes green.

Illuminates briefly

The parking lights are switched on.

Flashes

A turn signal or the hazard warning flashers are activated.

Rapid flashing: failure of a turn signal light or associated fuse, failure of turn signal light on trailer.

Bulb replacement ↪ 162, Fuses ↪ 171.

Turn signals ↪ 113.

Seat belt reminder

Seat belt reminder on front seats

🚗 for driver's seat illuminates or flashes red.

🚗² for front passenger seat illuminates or flashes red, when seat is occupied.

Illuminates

After the ignition has been switched on until the seat belt has been fastened.

Flashes

After having started the engine for a maximum of 100 seconds until the seat belt has been fastened.

Seat belt status on rear seats

🚗 flashes or illuminates.

Illuminates

After the ignition has been switched on when the seat belt has been fastened.

Flashes

After starting off when the seat belt is unfastened.

Fastening the seat belt ↪ 46.

Airbag and belt tensioners

🚗 illuminates red.

When the ignition is switched on, the control indicator illuminates for approx. 4 seconds. If it does not illuminate, does not extinguish after 4 seconds or illuminates whilst driving, there is a fault in the airbag system. Seek the assistance of a workshop. The airbags and belt pretensioners may fail to trigger in the event of an accident.

Deployment of the belt pretensioners or airbags is indicated by continuous illumination of 🚗.

Warning

Have the cause of the fault remedied immediately by a workshop.

Belt pretensioners, airbag system
 ⇨ 45, ⇨ 48.

Airbag deactivation

 illuminates yellow.

The front passenger airbag is activated.

 illuminates yellow.

The front passenger airbag is deactivated ⇨ 51.

Danger

Risk of fatal injury for a child using a child restraint system together with activated front passenger airbag.

Risk of fatal injury for an adult person with deactivated front passenger airbag.

Charging system

 illuminates red.

Illuminates when the ignition is switched on and extinguishes shortly after the engine starts.

Illuminates when the engine is running

Stop, switch off engine. Battery is not charging. Engine cooling may be interrupted. The brake servo unit may cease to be effective. Seek the assistance of a workshop.

Malfunction indicator light

 illuminates or flashes yellow.

Illuminates when the ignition is switched on and goes out shortly after the engine starts.

Illuminates when the engine is running

Fault in the emission control system. The permitted emission limits may be exceeded. Seek the assistance of a workshop immediately.

Flashes when the engine is running

Fault that could lead to catalytic converter damage. Ease up on the accelerator until the flashing stops. Seek the assistance of a workshop immediately.

Service vehicle soon

 illuminates yellow.

Additionally a warning message or a warning code is displayed.

The vehicle needs a service.

Seek the assistance of a workshop.

Vehicle messages ⇨ 94.

Brake and clutch system

 illuminates red.

Illuminates when the manual parking brake is released if the brake and clutch fluid level is too low ⇨ 160.

Warning

Stop. Do not continue your journey. Consult a workshop.

Illuminates after the ignition is switched on if the manual parking brake is applied ⇨ 137.

Electrical parking brake

Ⓢ illuminates or flashes red.

Illuminates

Electrical parking brake is applied ⇨ 137.

Flashes

Electrical parking brake is not fully applied or released. Depress the foot brake pedal and attempt to reset the system by first releasing and then applying the electrical parking brake. If Ⓢ remains flashing, do not drive and seek the assistance of a workshop.

Electrical parking brake fault

Ⓢ illuminates or flashes yellow.

Illuminates

Electrical parking brake is operating with reduced performance ⇨ 137.

Flashes

Electrical parking brake is in service mode. Stop vehicle, apply and release the electrical parking brake to reset.

Warning

Have the cause of the fault remedied immediately by a workshop.

Antilock brake system (ABS)

Ⓢ(ABS) illuminates yellow.

Illuminates for a few seconds after the ignition is switched on. The system is ready for operation when the control indicator extinguishes.

If the control indicator does not extinguish after a few seconds, or if it illuminates while driving, there is

a fault in the ABS. The brake system remains operational but without ABS regulation.

Antilock brake system ⇨ 136.

Upshift

Ⓢ illuminates green.

Upshifting is recommended for fuel saving.

Variable effort steering

Ⓢ(!) illuminates yellow.

Fault in variable effort steering system. This may lead to a higher or lower steering effort. Consult a workshop.

Lane departure warning

Ⓢ(LD) illuminates green or yellow or flashes yellow.

Illuminates green

The system is switched on and ready to operate.

Flashes yellow

The system recognizes an unintended lane change.

Illuminates yellow

No lane marking is detected.

Ultrasonic parking assist

 illuminates yellow.

Fault in system

or

Fault due to sensors that are dirty or covered by ice or snow

or

Interference due to external sources of ultrasound. Once the source of interference is removed, the system will operate normally.

Have the cause of the fault in the system remedied by a workshop.

Ultrasonic parking assist ⇨ 143.

Electronic Stability Control

 illuminates or flashes yellow.

Illuminates

A fault in the system is present. Continued driving is possible. Driving stability, however, may deteriorate depending on road surface conditions.

Have the cause of the fault remedied by a workshop.

Flashes

The system is actively engaged. Engine output may be reduced and the vehicle may be braked automatically to a small degree. Electronic Stability Control ⇨ 140.

Electronic Stability Control off

 illuminates yellow.

The system is deactivated.

Traction Control system off

 illuminates yellow.

The system is deactivated.

Preheating

 illuminates yellow.

Preheating is activated. Only activates when outside temperature is low.

Diesel particle filter

 illuminates or flashes yellow.

The diesel particle filter requires cleaning.

Continue driving until  extinguishes. If possible do not allow engine speed to drop below 2000 rpm.

Illuminates

The diesel particle filter is full. Start cleaning process as soon as possible.

Flashes

The maximum filling level of the filter is reached. Start cleaning process immediately to avoid damage to the engine.

Diesel particle filter ⇨ 129.

Tyre pressure monitoring system

 illuminates or flashes yellow.

Illuminates

Tyre pressure loss. Stop immediately and check tyre pressure.

Flashes

Fault in system or tyre without pressure sensor mounted (e.g. spare wheel). After 60 - 90 seconds the control indicator illuminates continuously. Consult a workshop.

Engine oil pressure

 illuminates red.

Illuminates when the ignition is switched on and extinguishes shortly after the engine starts.

Illuminates when the engine is running

Caution

Engine lubrication may be interrupted. This may result in damage to the engine and/or locking of the drive wheels.

1. Move out of the flow of traffic as quickly as possible without impeding other vehicles.
2. Depress clutch.
3. Select neutral gear, set selector lever to **N**.
4. Switch off ignition.

Warning

When the engine is off, considerably more force is needed to brake and steer.

Do not remove key until vehicle is stationary, otherwise the steering wheel lock could engage unexpectedly.

Check oil level before seeking assistance of a workshop ⇨ 158.

Low fuel

 illuminates yellow.

Level in fuel tank is too low.

Catalytic converter ⇨ 130.

Bleeding the diesel fuel system ⇨ 161.

Immobiliser

 flashes yellow.

Fault in the immobiliser system. The engine cannot be started.

Apply footbrake

 illuminates yellow.

Brake pedal needs to be depressed to release the electrical parking brake ⇨ 137.

Exterior light

 illuminates green.

The exterior lights are on ⇨ 108.

☰☐ illuminates green.

The automatic light control is switched on ⇨ 109.

High beam

☰☐ illuminates blue.

Illuminated when high beam is on and during headlight flash ⇨ 109.

Adaptive forward lighting

☸ illuminates or flashes yellow.

Illuminates

Fault in system.

Seek the assistance of a workshop.

Flashes

System switched to asymmetrical low beam.

Control indicator ☸ flashes for approx. 4 seconds after the ignition is switched on as a reminder that the system has been activated ⇨ 110.

Automatic light control ⇨ 109.

Fog light

☸☐ illuminates green.

The front fog lights are on ⇨ 113.

Rear fog light

☐☸ illuminates yellow.

The rear fog light is on ⇨ 114.

Cruise control

☸☐ illuminates white or green.

Illuminates white

The system is on.

Illuminates green

A certain speed is stored.

Cruise control ⇨ 142

Door open

☸ illuminates red.

A door or the tailgate is open.

Information displays

Driver Information Center



The Driver Information Center (DIC) is located in the instrument cluster between speedometer and tachometer. It is available as Midlevel-Display or Uplevel-Display.

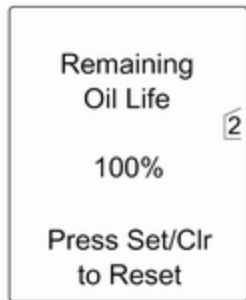

The following main menus, depending on the vehicle configuration, can be selected:

- **Vehicle Information Menu**
- **Trip/Fuel Information Menu**
- **Performance Menu**

Some of the displayed functions differ between vehicle driving and standstill and some functions are only active when the vehicle is driving.

Vehicle personalisation ⇨ 102.

Memorised settings ⇨ 20

Selecting menus and functions

The menus and functions can be selected via the buttons on the turn signal lever.



Press the **MENU** button to switch between the menus or to return from a submenu to the next higher menu level.



Turn the adjuster wheel to highlight a menu option or to set a numeric value.

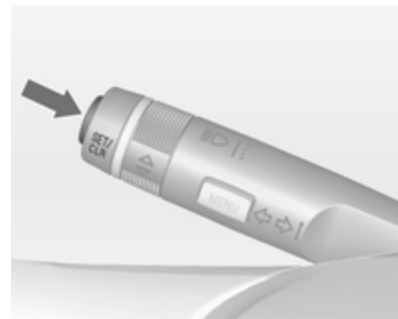

Press the **SET/CLR** button to select a function or to confirm a message.

Vehicle Information Menu

Press the **MENU** button to select the **Vehicle Information Menu**.

Turn the adjuster wheel to select one of the submenus. Press the **SET/CLR** button to confirm.

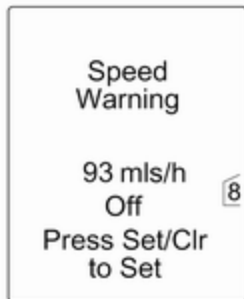

Follow the instructions given in the submenus.

Possible submenus:

- **Unit:** Displayed units can be changed.
- **Tire Pressure:** ⇨ 179.

- **Remaining Oil Life:** ⇨ 81
- **Speed Warning:** If exceeding the preset speed, a warning chime will be activated.
- **Language:** Displayed language can be changed.

Selection and indication can be different between Midlevel- and Uplevel-Display.

Trip/Fuel Information Menu

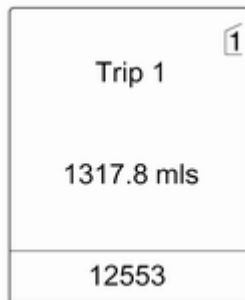

Trip/Fuel Information Menu, Trip Computer ⇨ 101.

Traffic sign assistant ⇨ 98.

Tyre pressure monitoring system ⇨ 179.

Advanced parking aid system ⇨ 143.

Performance Menu



Submenus are:

- **Oil Temp.:** Display of oil temperature.
- **Oil Pres.:** Display of oil pressure.
- **Boost Pres.:** Display of turbo boost pressure.

- **Lap timer:** Display of lap times, top speed, average speed and average time. Follow the instructions given in the submenu.
- **Coolant Temp.:** Display of coolant temperature.
- **Battery Volt.:** Display of battery voltage.

Graphic-Info-Display, Colour-Info-Display

Depending on the vehicle configuration the vehicle has a Graphic- or Colour-Info-Display. The Info-Display is located in the instrument panel above the Infotainment system.

Graphic-Info-Display

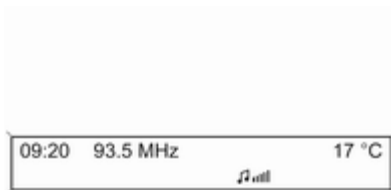

Depending on the Infotainment system, the Graphic-Info-Display is available in two versions.



20153

Graphic-Info-Display indicates:

- time ↻ 76
- outside temperature ↻ 76
- date ↻ 76
- Infotainment system, see description for Infotainment system
- settings for vehicle personalisation ↻ 102

Colour-Info-Display



The Colour-Information-Display indicates in colour:

- time ↻ 76
- outside temperature ↻ 76
- date ↻ 76
- Infotainment system, see description for Infotainment system
- navigation, see description for Infotainment system
- system settings

- vehicle messages ↻ 94
- settings for vehicle personalisation ↻ 102

The type of information and how it is displayed depends on the equipment of the vehicle and the settings made.

Selecting menus and settings

Menus and settings are accessed via the display.



Selections are made via:

- menus
- function buttons and multifunction knob of the Infotainment system
- function buttons and multifunction knob of the multifunction unit in the centre console.

Selecting with the Infotainment system



Select a function via the Infotainment system buttons. The menu of the selected function is displayed.

The multifunction knob is used to select an item and to confirm.

Selecting with the multifunction unit



Select a function via the buttons of the multifunction unit. The menu of the selected function is displayed.

The multifunction knob is used to select an item and to confirm.

Multifunction knob

The multifunction knob is the central control element for the menus:

Turn

- To mark a menu option
- To set a numeric value or to display a menu option

Press (the outer ring)

- To select or activate the marked option
- To confirm a set value
- To switch a system function on/off

BACK button

Press button to:

- exit a menu without changing settings
- return from a submenu to a higher menu level
- delete a last character in a character sequence

Press and hold the button for a few seconds to delete the entire entry.

Vehicle personalisation ↻ 102,
Memorised settings ↻ 20.

Vehicle messages

Messages are indicated mainly in the Driver Information Center (DIC), in some cases together with a warning and signal buzzer.

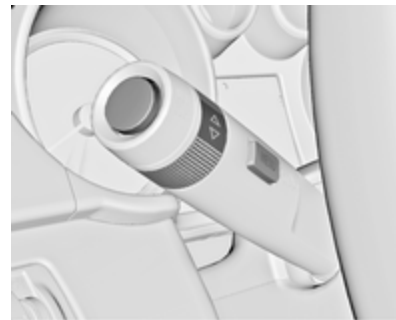

Press the **SET/CLR** button, the **MENU** button or turn the adjuster wheel to confirm a message.

Vehicle messages on the Midlevel-Display



The vehicle messages are displayed as code numbers.

No. Vehicle message

- 1 Change engine oil
- 2 No radio remote control detected, depress clutch pedal for a restart
- 3 Engine coolant level low
- 4 Air conditioning off

No. Vehicle message

- 5 Steering wheel is locked
- 6 Depress brake pedal to release electrical parking brake
- 7 Turn steering wheel, switch ignition off and then on
- 8 Switch ignition off and then on, repeat breath test
- 9 Turn steering wheel, start engine again
- 11 Brake pads worn
- 12 Vehicle overloaded
- 13 Compressor overheated
- 15 Centre high-mounted brake light failure
- 16 Brake light failure
- 17 Headlight levelling malfunction
- 18 Left low beam failure
- 19 Rear fog light failure

No. Vehicle message

- 20 Right low beam failure
- 21 Left front sidelight failure
- 22 Right front sidelight failure
- 23 Reversing light failure
- 24 Number plate light failure
- 25 Left front turn signal failure
- 26 Left rear turn signal failure
- 27 Right front turn signal failure
- 28 Right rear turn signal failure
- 29 Check trailer brake light
- 30 Check trailer reversing light
- 31 Check left trailer turn signal
- 32 Check right trailer turn signal
- 33 Check trailer rear fog light
- 34 Check trailer rear light
- 35 Replace battery in radio remote control

No. Vehicle message

- 48 Clean side blind zone alert system
- 49 Lane departure warning unavailable
- 50 Activated pedestrian protection system, reset bonnet
- 51 Compass unavailable
- 53 Tighten gas cap
- 54 Water in diesel fuel filter
- 55 Diesel particle filter is full
↻ 129
- 56 Tyre pressure imbalance on front axle
- 57 Tyre pressure imbalance on rear axle
- 58 Tyres without TPMS sensors detected
- 59 Open and then close driver window

No. Vehicle message

- 60 Open and then close front passenger window
- 61 Open and then close rear left window
- 62 Open and then close rear right window
- 65 Theft attempted
- 66 Service theft alarm system
- 67 Service steering wheel lock
- 68 Service power steering
- 69 Service suspension system
- 70 Service level control system
- 71 Service rear axle
- 73 Service All-wheel drive system
- 74 Service AFL
- 75 Service air conditioning
- 76 Service side blind zone alert system

No. Vehicle message

- 77 Service lane departure warning
- 78 Service pedestrian protection system
- 79 Top up engine oil
- 80 Change transmission fluid
- 81 Service transmission
- 82 Change engine oil soon
- 83 Service adaptive cruise control
- 84 Engine power is reduced
- 95 Service Airbag

Vehicle messages on the Uplevel-Display



The vehicle messages are displayed as text. Follow the instructions given in the messages.

The system displays messages regarding the following topics:

- Fluid levels
- Anti-theft alarm system
- Brakes
- Drive systems
- Ride control systems
- Cruise control

- Object detection systems
- Lighting, bulb replacement
- Wiper/washer system
- Doors, windows
- Radio remote control
- Seat belts
- Airbag systems
- Engine and transmission
- Tyre pressure
- Diesel particle filter

Vehicle messages on the Colour-Info-Display

Some important messages appear additionally in the Colour-Info-Display. Press the multifunction knob to confirm a message. Some messages only pop up for a few seconds.

Warning chimes

When starting the engine or whilst driving

- If seat belt is not fastened.
- If a door or the tailgate is not fully closed when starting off.
- If a certain speed is exceeded with parking brake applied.
- If a programmed speed is exceeded.
- If a warning message or a warning code appears in the Driver Information Center.
- If the parking assist detects an object.

When the vehicle is parked and/or the driver's door is opened

- When the key is in the ignition switch.
- With exterior lights on.
- If the trailer hitch is not engaged.

Traffic sign assistant

Functionality

The traffic sign assistant system detects designated traffic signs via a front camera and displays them in the Driver Information Center.

Traffic signs, which will be detected, are

- speed limit
- no passing
- end of speed limit
- end of no passing

Speed limit signs are displayed in the Driver Information Center until the next speed limit sign or end of speed limit is detected.

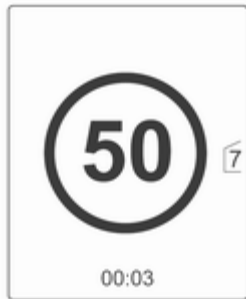

No passing signs have priority above speed limits.

Combinations of both signs in the display are possible.

The time since detection is displayed in hours and minutes below the traffic sign.



The system is active at an indicated speed above 9 mph and is active up to a speed of 124 mph depending on the lighting conditions. At night the system is active up to a speed of 99 mph.

As soon as the speed becomes slower than 22 mph the display will be reset and the content of the traffic sign page will be cleared. The next recognized speed indication will be displayed.

Display indication



Traffic signs are displayed on the page **Traffic sign detection** in the **Trip/Fuel Information Menu**, chosen via the adjuster wheel on the turn signal lever ↻ 89.

When another function on the Driver Information Center menu was selected and then **Traffic sign detection** page is chosen again, the last recognized traffic sign will be displayed.

If the system is deactivated, the content of the traffic sign page is cleared, indicated by the following symbol:

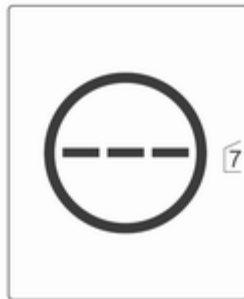

The content of the traffic sign page is also cleared during driving by pushing the **SET/CLR** button on the turn signal lever.

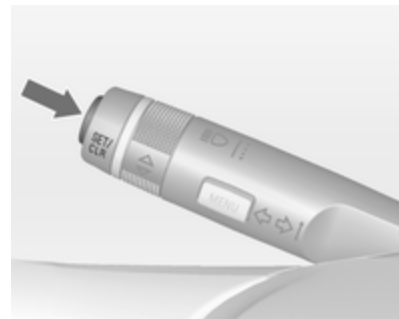

Speed limits and no passing signs are displayed as pop-ups on each page of the menu.

Pop-up function

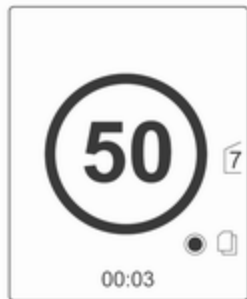

The pop-up function can be selected by pushing the **SET/CLR** button on the turn signal lever. Activation will be indicated by the icon in the display.

Pop-up indication is displayed for approx. 8 seconds in the Driver Information Center.

Fault

The traffic sign assistant system may not operate correctly when:

- the area of the windscreen, where the front camera is located, is not clean
- traffic signs are completely or partially covered or difficult to discern
- there are adverse environmental conditions like heavy rain, snow, direct sunlight or shadows. In this case **No Traffic Sign Detection due to Weather** is indicated on the display
- traffic signs are incorrectly mounted or damaged
- traffic signs do not comply with the Wiener Übereinkommen über Straßenverkehrszeichen (Vienna Convention on traffic signs)

Caution

The system is intended to help the driver within a defined speed range to discern certain traffic signs. Do not ignore traffic signs which are not displayed by the system.

The system does not discern any other than the conventional traffic signs that might give or end a speed limit.

Do not let this special feature tempt you into taking risks when driving.

Always adapt speed to the road conditions.

The driver assistance systems do not relieve the driver from full responsibility for vehicle operation.

Trip computer

The menus and functions can be selected via the buttons on the turn signal lever.



Press the **MENU** button to select the **Trip/Fuel Information Menu**.



Turn the adjuster wheel to select one of the submenus:

- Trip odometer 1
- Trip odometer 2
- Range
- Average consumption
- Instantaneous consumption
- Average speed
- Digital speed
- Traffic sign assistant



The information of the two trip computers can be reset separately, making it possible to display different trip distances.

To reset, press the **reset knob** or press the **SET/CLR** button for a few seconds.



Range

Range is calculated from current fuel tank content and current consumption. The display shows average values.

After refuelling, the range is updated automatically after a brief delay.

When the fuel level in the tank is low, a message appears in the Driver Information Center and in the Info-Display.

Additionally the control indicator ● in the fuel gauge illuminates.

Average consumption

Display of average consumption. The measurement can be reset at any time.

To reset, press the **SET/CLR** button for a few seconds.

Instantaneous consumption

Display of the instantaneous consumption.

Average speed

Display of average speed. The measurement can be reset at any time.

To reset, press the **SET/CLR** button for a few seconds.

Digital speed

Digital display of the instantaneous speed.

Traffic sign assistant

Indicates detected traffic signs for the current route section, ↗ 98.

Vehicle personalisation

The vehicle's behaviour can be personalised via changing the settings in the Info-Display.

Some of the personal settings for different drivers can be memorised individually for each vehicle key. Memorised settings ↗ 20

Depending on vehicle equipment and country-specific regulations some of the functions described below might not be available.

Some functions are only displayed or active when the engine is running.

Personal settings in the Graphic-Info-Display



Press the **CONFIG** button. The menu **Settings** is displayed.

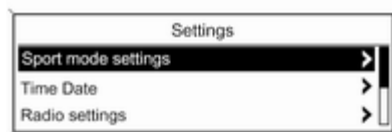

20325

The following settings can be selected by turning and pushing the multifunction knob:

- **Sport mode settings**
- **Time Date**
- **Radio settings**
- **Phone settings**
- **Vehicle settings**
- **Restore factory settings**

In the corresponding submenus the following settings can be changed:

Sport mode settings

The driver can select the functions which will be activated in Sport mode ↻ 140.

- **Sport suspension:** Damping becomes harder.
- **Sport powertrain performance:** Accelerator pedal and gear change characteristics become more responsive.
- **Sport steering:** Steering support is reduced.
- **Sport All-Wheel-Drive:** Engine torque is distributed to a greater extent to the rear axle.
- **Swap backlight colour main instr.:** Change of instrument illumination colour.
- **Restore factory settings:** Reset all functions to factory settings.

Time Date

See Clock ↻ 76.

Radio settings

See description for Infotainment system.

Phone settings

See description for Infotainment system.

Vehicle settings

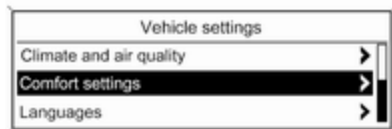

20326

- **Climate and air quality**

Auto fan speed: Modifies the fan regulation.

Climate control mode: Activate or deactivate cooling or select previous settings.

Temperature zone at start: Change between single zone or dual zone temperature setting.

Auto cooled/vented seats: Activate or deactivate automatic seat ventilating.

Auto heated seats: Activate or deactivate automatic seat heating.

Auto demist: Supports windscreen dehumidification by automatically selecting the necessary settings and auto air conditioning mode.

Auto rear demist: Automatic activation of rear heated window.

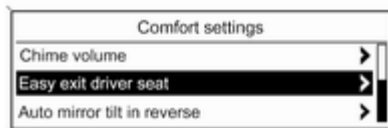

20327

- **Comfort settings**

Chime volume: Change the volume of warning chimes.

Easy exit driver seat: Activate or deactivate easy exit function of the power seat.

Auto mirror tilt in reverse: Activate or deactivate the parking assist function of the exterior mirror on the passenger side.

Personalization by driver: Activate or deactivate the personalisation function.

Rear auto wipe in reverse: Activate or deactivate automatically switching on of the rear window wiper when reverse gear is engaged.

- **Languages**

Selection of the desired language.

- **Park assist / Collision detection**

Park assist: Activate or deactivate the ultrasonic parking assist.

- **Exterior ambient lighting**

- **Exterior lighting by unlocking:**

- Activate or deactivate the welcome lighting.

- **Duration upon exit of vehicle:**

- Activate or deactivate and change the duration of exit lighting.

- **Remote locking, unlocking, starting**

- **Remote unlock feedback:** Activate or deactivate the hazard warning flasher feedback whilst unlocking.

- **Remote door unlock:** Change the configuration to unlock only the driver's door or the whole vehicle whilst unlocking.

- **Auto relock doors:** Activate or deactivate the automatic relock function after unlocking without opening the vehicle.

- **Restore factory settings**

- **Restore factory settings:** Reset all settings to the default settings.

Personal settings in the Colour-Info-Display



Press the **CONFIG** button. The menu **Settings** is displayed.



The following settings can be selected by turning and pushing the multifunction knob:

- **Sport mode settings**
- **Time & Date**
- **Radio settings**
- **Phone settings**
- **Navigation settings**
- **Vehicle settings**
- **Display settings**
- **Restore factory settings**

In the corresponding submenus the following settings can be changed:

Sport mode settings

The driver can select the functions which will be activated in Sport mode ↗ 140.

- **Sport suspension:** Damping becomes harder.
- **Sport powertrain performance:** Accelerator pedal and gear change characteristics become more responsive.
- **Sport steering:** Steering support reduced.
- **Sport All-Wheel-Drive:** Engine torque is distributed to a greater extent to the rear axle.
- **Swap backlight colour main instr.:** Change of instrument illumination colour.
- **Restore factory settings:** Reset all functions to factory settings.

Time & Date

See Clock ↗ 76.

Radio settings

See description for Infotainment system.

Phone settings

See description for Infotainment system.

Navigation settings

See description for Infotainment system.

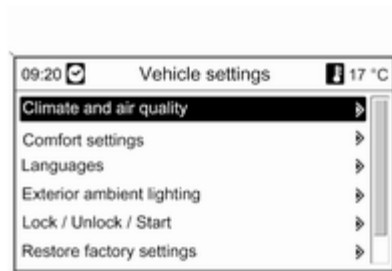
Vehicle settings

- **Climate and air quality**

Auto fan speed: Modifies the fan regulation.

Climate control mode: Activate or deactivate cooling or select previous settings.

Temperature zone at start: Change between single zone or dual zone temperature setting.

Auto cooled/vented seats: Activate or deactivate automatic seat ventilating.

Auto heated seats: Activate or deactivate automatic seat heating.

Auto demist: Supports windscreen dehumidification by automatically selecting the necessary settings and auto air conditioning mode.

Auto rear demist: Automatic activation of rear heated window.

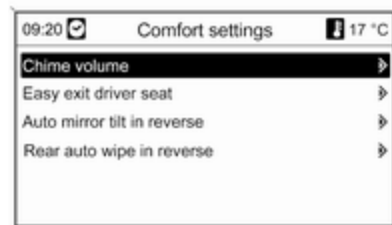

■ Comfort settings

Chime volume: Change the volume of warning chimes.

Easy exit driver seat: Activate or deactivate easy exit function of the power seat.

Auto mirror tilt in reverse: Activate or deactivate the parking assist function of the exterior mirror on the passenger side.

Rear auto wipe in reverse: Activate or deactivate automatically switching on of the rear window wiper when reverse gear is engaged.

■ Languages

Selection of the desired language.

■ Park assist / Collision detection

Park assist: Activate or deactivate the ultrasonic parking assist .

■ Exterior ambient lighting

Exterior lighting by unlocking: Activate or deactivate the welcome lighting.

Duration upon exit of vehicle:

Activate or deactivate and change the duration of exit lighting.

■ Lock / Unlock / Start

Remote unlock feedback: Activate or deactivate the hazard warning flasher feedback whilst unlocking.

Remote door unlock: Change the configuration to unlock only the driver's door or the whole vehicle whilst unlocking.

Auto relock doors: Activate or deactivate the automatic relock function after unlocking without opening the vehicle.

Personalization by remote control:

Activate or deactivate the personalisation function.

■ Restore factory settings

Restore factory settings: Reset all settings to the default settings.

Display settings

Selectable display settings:

■ **Day mode:** Optimisation for daylight conditions.

■ **Night mode:** Optimisation for darkness.

■ **Automatic mode:** The display changes mode when the vehicle lights are switched on/off.

Lighting



Exterior lighting	108
Interior lighting	115
Lighting features	116

Exterior lighting

Light switch



Turn light switch:

- AUTO** = automatic light control: Headlights are switched on and off automatically depending on external lighting conditions.
-  = activation or deactivation of the automatic light control. Switch turns back to **AUTO**.
- O** = off
-  = sidelights
-  = headlights

In the Driver Information Center with Uplevel-Display, the current status of the automatic light control is displayed.

When switching on the ignition, automatic light control is active.

Control indicator  88, Automatic light control indicator  88.

Tail lights

Tail lights are shining together with headlights and sidelights.

Tail lights on Estate

Additional tail light assemblies, existing of tail lights and hazard warning flash lights, are located in the tailgate frame. They are shining, when they are activated and the tailgate is open. Additional tail lights are only intended as position lights when the tailgate is open and not to be used when driving.

Automatic light control



Automatic light control function

When the automatic light control function is switched on and the engine is running, the system switches between daytime running light and headlight in dependence of the lighting conditions.

Daytime running light

Daytime running light increases visibility of the vehicle during daylight.



Tail lights are not on.

Automatic headlight activation

During poor lighting conditions the headlights are switched on.

Tunnel detection

When a tunnel is entered the headlights are switched on without delay.

Adaptive forward lighting ↗ 111.

High beam

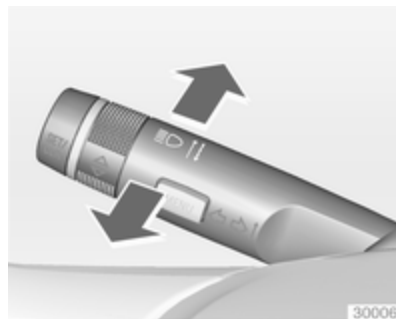

To switch from low to high beam, push lever.

To switch to low beam, push lever again or pull.

Headlight flash

To activate the headlight flash, pull lever.

Headlight range adjustment

Manual headlight range adjustment



To adapt headlight range to the vehicle load to prevent dazzling: turn thumb wheel  to required position.

- 0 = front seats occupied
- 1 = all seats occupied
- 2 = all seats occupied and load compartment laden
- 3 = driver's seat occupied and load compartment laden.

Dynamic automatic headlight levelling  111.

Headlights when driving abroad

The asymmetrical headlight beam extends visibility at the edge of the road at the passenger side.

However, when driving in countries where traffic drives on the opposite side of the road, adjust the headlights to prevent dazzling of oncoming traffic.

Vehicles with halogen headlight system

Have the headlights adjusted by a workshop.

Vehicles with Xenon headlight system

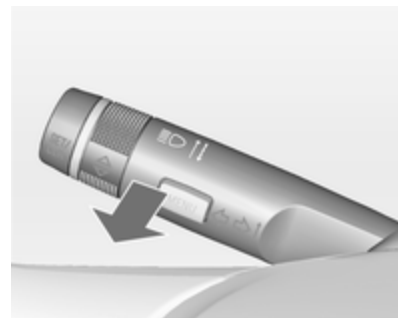

Adapting the distribution of the headlight beam:

1. Pull headlight flash lever.
2. Switch on ignition.
3. Hold headlight flash lever. After approx. 5 seconds the control indicator  starts flashing and an acoustic signal sounds.

Control indicator  89.

Every time the ignition is switched on,  flashes as a reminder for approx. 4 seconds.

For deactivation operate the same procedure as described above.  will not flash when the function is deactivated.

Adaptive forward lighting

The Adaptive forward lighting functions are only available with Bi-Xenon headlights. Light range, light distribution and intensity of light are variably triggered depending on the light conditions, weather and road type.

With the light switch in position  **AUTO** all lighting functions are available.

With the light switch in position  the following functions are available:

- Dynamic curve lighting
- Corner lighting
- Reversing function
- Dynamic automatic headlight levelling

are also available in light switch position .

Playstreet lighting

Activated automatically at low speed up to approx. 20 mph. The light beam is turned at an angle of 8° to the roadside.

Town lighting

Activated automatically at a speed range between approx. 25 and 34 mph and when street lights are detected by the light sensor. The light range is reduced by an extended light distribution.

Country lighting

Activated automatically at a speed range between approx. 34 and 70 mph. The beam of light and the brightness is different between the left and the right side.

Motorway lighting

Activated automatically at a speed above approx. 70 mph and minimal steering movements. It switches on delayed or directly when the vehicle is powerfully accelerated. The light beam is longer and brighter.

Adverse weather lighting

Activated automatically up to a speed of approx. 43 mph, when the rain sensor recognizes condensation or the wiper operates continuously. The range, distribution and light intensity is regulated variably depending on visibility.

Dynamic curve lighting

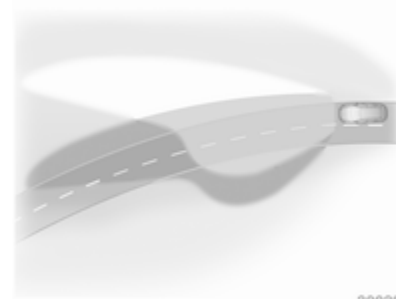

30039

The light beam pivots based on steering wheel angle and speed, improving lighting in curves.

Control indicator   89.

Corner lighting

On tight bends or when turning off, depending on the steering angle or the turn signal light, an additional left or right reflector is switched on which illuminates the road at an right angle to the direction of travel. It is activated up to a speed of 25 mph.

Control indicator  ↷ 89.

Reversing function

If the headlights are on and reverse gear is engaged, both corner lights are switched on. They remain illuminated for 20 seconds after disengaging reverse gear or driving faster than 10 mph forward.



High Beam Assist

This feature allows high beam as main driving light by night and when vehicle speed is faster than 25 mph. It switches to low beam when:

- the camera in the windscreen detects the lights of oncoming or preceding vehicles
- the vehicle speed is slower than 12 mph

- it is foggy or snowy
- driving in urban areas

If there are no restrictions detected, the system switches back to high beam.

The green control indicator  illuminates continuously when the assist is activated, the blue one  illuminates when high beam is on.

Control indicator  ↷ 89.

The high beam assist is activated by pushing the indicator lever twice.

To deactivate push indicator lever once. It is also deactivated, when front or rear fog lights are switched on.

If a headlight flash is activated when the high beam is on, the high beam assist will be deactivated.

If a headlight flash is activated when the high beam is off, the high beam assist will stay activated.

The latest setting of the high beam assist will remain after the ignition is switched on again.

Dynamic automatic headlight levelling

To prevent oncoming traffic from dazzle, headlight levelling is automatically adjusted based on inclination information measured by front and rear axle, acceleration or deceleration and vehicle speed.

Fault in Adaptive forward lighting system

When the system detects a failure in the Adaptive forward lighting system, the system moves to a preset position to avoid dazzling of oncoming traffic. If this is not possible the affected headlight will be automatically switched off. In any case one headlight will stay on. A warning is displayed in the Driver Information Center.

Hazard warning flashers



Operated with the  button.

In the event of an accident with airbag deployment the hazard warning flashers are activated automatically.

Turn and lane-change signals

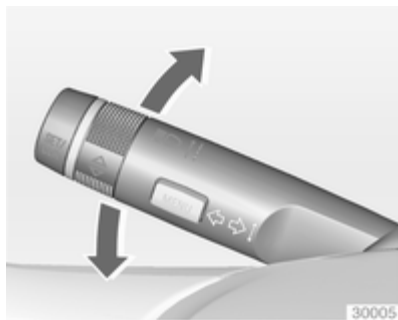

lever up = right turn signal
 lever down = left turn signal

If the lever is moved past the resistance point, the turn signal is switched on constantly. When the steering wheel moves back, the turn signal is automatically deactivated.

For three flashes, e.g. when changing lanes, press the lever until resistance is felt and then release.

With a trailer connected, turn signal flashes six times when the lever is pressed until resistance is felt, then released.

Move the lever to the resistance point and hold for longer indication.

Switch the turn signal off manually by moving the lever to its original position.

Front fog lights



Operated with the  button.

Light switch in position **AUTO**: switching on front fog lights will switch headlights on automatically.

Rear fog lights



Operated with the  button.

Light switch in position **AUTO**: switching on rear fog light will switch headlights on automatically.

Light switch in position : rear fog light can only be switched on with front fog lights.

The vehicle rear fog light is deactivated when towing.

Parking lights



When the vehicle is parked, the parking lights on one side can be activated:

1. Switch off ignition.
2. Move turn signal lever all the way up (right parking lights) or down (left parking lights).

Confirmed by a signal and the corresponding turn signal control indicator.

Reversing lights

The reversing lights come on when the ignition is on and reverse gear is selected.

Misted light covers

The inside of the light housing may mist up briefly in poor, wet and cold weather conditions, in heavy rain or after washing. The mist disappears quickly by itself; to help switch on the headlights.

Interior lighting

Instrument panel illumination control



Brightness of the following lights can be adjusted when the exterior lights are on:

- Instrument panel illumination
- Steering wheel controls
- Info-Display
- Infotainment system operation elements
- Climate control operation elements
- Illuminated switches

Turn thumb wheel  and hold until the desired brightness is obtained.

Interior lights

During entry and exit of the vehicle, the front and rear courtesy lights automatically switch on and then off after a delay.

Notice

In the event of an accident with airbag deployment the courtesy lights are turned on automatically.

Front courtesy light



Operate rocker switch:

 = automatic switching on and off.

press  = on.

press  = off.

Rear courtesy lights



Illuminate in conjunction with the front courtesy light depending on rocker switch position.

Reading lights



Operated with  and  buttons in front and rear courtesy lights.

Sunvisor lights

Illuminates when the cover is opened.

Lighting features

Centre console lighting

Spotlight incorporated in the interior lighting comes on when headlights are switched on.

Entry lighting

Welcome lighting

Headlights, tail lights, reversing lights, number plate lights, instrument panel light, interior lights and puddle lights are switched on for a short time by unlocking the vehicle with the radio remote control. This function facilitates locating the vehicle when it is dark.

The lighting switches off immediately when the ignition key is turned to position 1.

Activation or deactivation of this function can be changed in the menu **Settings** in the Info-Display. Vehicle personalisation ↷ 102.

The settings can be saved for the key being used ↷ 20.

The following lights will additionally switch on when the driver's door is opened:

- All switches
- Driver Information Center
- Door pocket lights

Exit lighting

The following lights switch on if the key is removed from the ignition switch:

- Interior lights
- Instrument panel light
- Puddle lights

They will switch off automatically after a delay. Theatre lighting is activated if the driver's door is opened during this time.



Headlights, tail lights, reversing lights and number plate lights illuminate the surrounding area for an adjustable time after leaving the vehicle.

Switching on

1. Switch off ignition.
2. Remove ignition key.
3. Open driver's door.
4. Pull turn signal lever.
5. Close driver's door.

If the driver's door is not closed the lights switch off after two minutes.

Exit lighting is switched off immediately if the turn signal lever is pulled while the driver's door is open. Activation, deactivation and duration of this function can be changed in the menu **Settings** in the Info-Display. Vehicle personalisation ⇨ 102.

The settings can be saved for the key being used ⇨ 20.

Battery discharge protection

Battery state of charge function

The function guarantees longest battery life via a generator with controllable power output and optimised power distribution.

To prevent discharge of the battery when driving, the following systems are reduced automatically in two stages and finally switched off:

- Auxiliary heater
- Heated rear window and mirrors
- Heated seats
- Fan

In the second stage a message which confirms the activation of the battery discharge protection will be displayed in the Driver Information Center.

Switching off electric lights

To prevent discharge of the battery when the ignition is switched off, some interior lights are switched off automatically after some time.

Climate control

Climate control systems	118
Air vents	124
Maintenance	125

Climate control systems

Heating and ventilation system

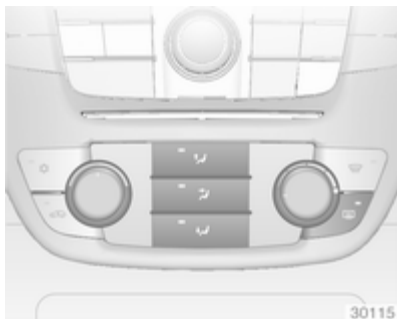

Controls for:

- Temperature
- Air distribution
- Fan speed



Heated rear window  ↗ 34.

Temperature

red = warm
blue = cold

Heating will not be fully effective until the engine has reached normal operating temperature.

Air distribution

-  = to windscreen and front door windows
-  = to head area via adjustable air vents
-  = to foot well

All combinations are possible.



Fan speed



Adjust the air flow by switching the fan to the desired speed.

Air conditioning system



In addition to the heating and ventilation system, the air conditioning system has:

-  = cooling
-  = air recirculation
-  = demisting and defrosting

Heated seats  44, Ventilated seats  44.

Cooling

Operated with the  button and is functional only when the engine and fan are running.

The air conditioning system cools and dehumidifies (dries) as soon as the outside temperature is slightly above freezing point. Therefore condensation may form and drip from under the vehicle.

If no cooling or drying is required, switch the cooling system off to save fuel.

Air recirculation system

Operated with the  button.



Warning

The exchange of fresh air is reduced in air recirculation mode. In operation without cooling the air humidity increases, so the windows may mist up. The quality of the passenger compartment air deteriorates, which may cause the vehicle occupants to feel drowsy.

Air distribution to : Air recirculation is deactivated.



Maximum cooling

Briefly open the windows so that hot air can disperse quickly.

- Cooling  on.
- Air circulation system  on.
- Press air distribution switch .
- Set temperature control to coldest level.
- Set fan speed to highest level.
- Open all vents.

Demisting and defrosting the windows



- Press button : fan automatically switches to higher speed, the air distribution is directed towards the windscreen,
- Switch cooling  on.
- Set temperature control to warmest level.
- Switch on heated rear window .
- Open side air vents as required and direct them towards the door windows.



Electronic climate control system

Two versions of climate control: single zone or dual zone temperature setting. The dual zone climate control allows different climatization temperatures for driver and front passenger side.



Single zone controls:



- Temperature
- Air distribution
- Fan speed

AUTO = automatic mode
 = air recirculation
 = demisting and defrosting



Dual zone controls:

- Temperature on driver side
- Air distribution
- Fan speed
- Temperature on front passenger side

AUTO = automatic mode
 = air recirculation
 = demisting and defrosting

Heated rear window  ↪ 34.

The preselected temperature is automatically regulated. In the automatic mode the fan speed and air distribution automatically regulate the air flow.

The system can be manually adapted by the use of air distribution and air flow controls.



Data is shown on the climate display. It may appear differently depending on single zone or dual zone climate control.

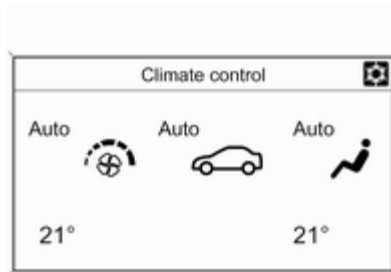

Each change of settings is shown in the Info-Display for a few seconds.

Climate control system settings are saved in the key used to lock the vehicle.

The electronic climate control system is only fully operational when the engine is running.

For correct operation do not cover the sensor on the instrument panel.

Automatic mode AUTO



Basic setting for maximum comfort:

- Press **AUTO** button, the air conditioning is activated automatically.
- Open all air vents.
- Single zone climate control: Set preselected temperature using left rotary knob.
- Recommended comfort setting is 22 °C.



- Dual zone climate control: Set the preselected temperatures for driver and front passenger using the left and right rotary knob.

The fan speed regulation in automatic mode can be changed in the menu **Settings**.

Vehicle personalisation ⇨ 102.

All air vents are actuated automatically in automatic mode. The air vents should therefore always be open.

Temperature preselection





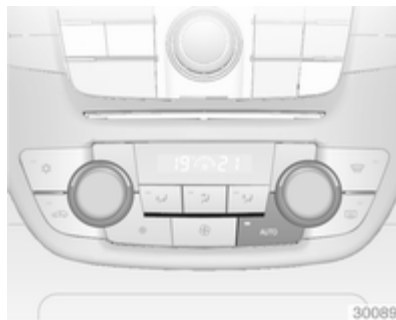

Temperatures can be set to the desired value.



Dual zone climate control: for a common temperature setting use the menu **Settings**.

Demisting and defrosting the windows

- Press button .
- Press cooling button .
- Temperature and air distribution are set automatically and the fan runs at high speed.
- Switch on heated rear window .
- To return to previous mode: press button .

Manual settings

Climate control system settings can be changed by activating the buttons and rotary knobs as follows. Changing a setting will deactivate the automatic mode.

Fan speed single zone climate control

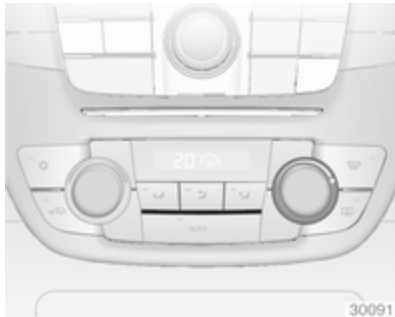



Turn right rotary knob. The selected fan speed is indicated by the number of segments in the display.

If the fan is switched off the air conditioning is also deactivated.

To return to automatic mode: Press **AUTO** button.

Fan speed dual zone climate control



Press left button  to decrease or right button  to increase fan speed. The fan speed is indicated by the number of segments in the display.

Pressing the left button for longer, fan and cooling are switched off.

Pressing the right button for longer, the fan runs at maximum speed.

To return to automatic mode: Press **AUTO** button.

Air distribution

Press ,  or  for desired adjustment. Activation is indicated by the LED in the button.

 = to windscreen and front door windows.

 = to head area via adjustable air vents.

 = to foot well.

Combinations are possible.

Return to automatic air distribution: Deactivate corresponding setting or press button **AUTO**.

Cooling

Activate or deactivate with the  button.

The air conditioning system cools and dehumidifies (dries) when outside temperature is above freezing point. Therefore condensation may form and drip from under the vehicle.

If no cooling or drying is required, switch the cooling system off to save fuel.

Automatic air recirculation on dual zone climate control

The automatic air recirculation system has an air humidity sensor which switches automatically to external air if internal air humidity is too high.

Manual air recirculation mode

Operated with the  button.

Warning

The exchange of fresh air is reduced in air recirculation mode. In operation without cooling the air humidity increases, so the windows may mist up. The quality of the passenger compartment air deteriorates, which may cause the vehicle occupants to feel drowsy.

Basic settings

Some settings can be changed in the menu **Settings** in the Info-Display. Vehicle personalisation ⇨ 102.

Auxiliary heater

Air heater

Quickheat is an electric auxiliary air heater which automatically warms up the passenger compartment more quickly.

Air vents

Adjustable air vents



To open the vent, turn the adjuster wheel to I. Adjust the air amount at the vent outlet by turning the adjuster wheel.



Direct the flow of air by tilting and swivelling the slats.

To close the vent, turn the adjuster wheel to **O**.

⚠ Warning

Do not attach any objects to the slats of the air vents. Risk of damage and injury in case of an accident.

Fixed air vents

Additional air vents are located beneath the windscreen and door windows and in the foot wells.

Maintenance

Air intake

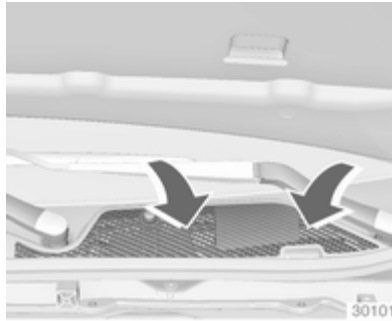

The air intake in front of the windscreen in the engine compartment must be kept clear to allow air intake. Remove any leaves, dirt or snow.

Pollen filter

Cabin air filtration

A particle filter cleans the cabin air from dust, soot, pollen and spores.

Active carbon filter

In addition to the particle filter the active carbon filter reduces odours.

Filter replacement has to be done during regular service.

Air conditioning regular operation

In order to ensure continuously efficient performance, cooling must be operated for a few minutes once a month, irrespective of the weather and time of year. Operation with cooling is not possible when outside temperature is too low.

Service

For optimal cooling performance, it is recommended to annually check the climate control system, starting three years after initial vehicle registration, including:

- Functionality and pressure test
- Heating functionality
- Leakage check
- Check of drive belts

- Cleaning of condenser and evaporator drainage
- Performance check

Driving and operating

Driving hints	127
Starting and operating	127
Engine exhaust	129
Automatic transmission	131
Manual transmission	135
Drive systems	136
Brakes	136
Ride control systems	139
Cruise control	142
Object detection systems	143
Fuel	149
Towing	151

Driving hints

Control of the vehicle

Never coast with engine not running

Many systems will not function in this situation (e.g. brake servo unit, power steering). Driving in this manner is a danger to yourself and others.

Pedals

To ensure the pedal travel is uninhibited, there must be no mats in the area of the pedals.

Starting and operating

New vehicle running-in

Do not brake unnecessarily hard for the first few journeys.

During the first drive, smoke may occur because of wax and oil evaporating off the exhaust system. Park the vehicle in the open for a while after the first drive and avoid inhaling the fumes.

During the running-in period fuel and engine oil consumption may be higher and the cleaning process of the diesel particle filter may take place more often.

Diesel particle filter ⇨ 129.

Ignition switch positions

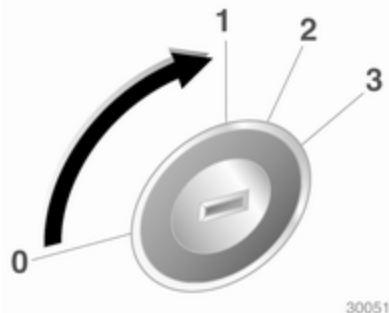

- 0 = Ignition off
- 1 = Steering wheel lock released, ignition off
- 2 = Ignition on, for diesel engine: preheating
- 3 = Starting

Starting the engine

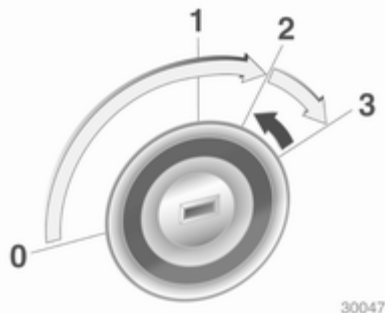

Manual transmission: operate clutch.
Automatic transmission: operate brake and move selector lever to **P** or **N**.

Do not operate accelerator pedal.

Diesel engine: turn the key to position **2** for preheating until control indicator  goes out.

Turn key briefly to position **3** and release: an automatic procedure operates the starter with a short delay until the engine is running, see Automatic Starter Control.

Before restarting or to switch off the engine, turn key back to **0**.

Automatic Starter Control

This function controls the engine starting procedure. The driver does not have to hold the key in position **3**. Once applied, the system will go on starting automatically until the engine is running. Because of the checking procedure, the engine starts running after a short delay.

Possible reasons for a non-starting engine:

- Clutch pedal not operated (manual transmission)
- Brake pedal not operated or selector lever not in **P** or **N** (automatic transmission)
- Timeout occurred

Overrun cut-off

The fuel supply is automatically cut-off during overrun, i.e. when the vehicle is driven with a gear engaged but accelerator pedal is released.

Parking

- Do not park the vehicle on an easily ignitable surface. The high temperature of the exhaust system could ignite the surface.
- Always apply parking brake. Apply manual parking brake without pressing release button. Apply as firmly as possible on downhill or uphill slopes. Depress the foot brake at the same time to reduce operating force.

For vehicles with electrical parking brake pull switch (P).

- Switch off the engine and ignition. Turn the steering wheel until the steering wheel lock engages.
- If the vehicle is on a level surface or uphill slope, engage first gear or set the selector lever to **P** before switching off the ignition. On an uphill slope, turn the front wheels away from the kerb.

If the vehicle is on a downhill slope, engage reverse gear or set the selector lever to **P** before switching

off the ignition. Turn the front wheels towards the kerb.

- Lock the vehicle and activate the anti-theft alarm system.

Notice

In the event of an accident with airbag deployment, the engine is turned off automatically if the vehicle comes to a standstill within a certain time.

Engine exhaust

Danger

Engine exhaust gases contain poisonous carbon monoxide, which is colourless and odourless and could be fatal if inhaled.

If exhaust gases enter the interior of the vehicle, open the windows. Have the cause of the fault rectified by a workshop.

Avoid driving with an open load compartment, otherwise exhaust gases could enter the vehicle.

Diesel particle filter

The diesel particle filter system filters harmful soot particles out of the exhaust gases. The system includes a self-cleaning function that runs automatically during driving without any notification. The filter is cleaned by periodically burning off the soot particles at high temperature. This process takes place automatically under set driving conditions and may

take up to 25 minutes. Typically it needs between 7 and 12 minutes. Fuel consumption may be higher during this period. The emission of smells and smoke during this process is normal.



Under certain driving conditions, e.g. short distances, the system cannot clean itself automatically.

If the cleaning of the filter is required and if previous driving conditions did not enable automatic cleaning, it will be indicated by the control indicator  and **CodE 55** in the Driver

Information Center. In vehicles with Uplevel-Display a warning message appears in the display.

 illuminates when diesel particle filter is full. Start cleaning process as soon as possible.

 flashes when diesel particle filter has reached the maximum filling level. Start cleaning process immediately to avoid damage to the engine.

Cleaning process

To activate cleaning process, continue driving, keep engine speed above 2000 revolutions per minute. Shift down if necessary. Diesel particle filter cleaning is then started.

If  illuminates additionally or a warning message appears in the Uplevel-Display, cleaning is not possible, seek the assistance of a workshop.

Caution

If the cleaning process is interrupted, there is a risk of provoking severe engine damage.

Cleaning takes place quickest at high engine speeds and loads.

Do not switch off the engine until the cleaning process is complete. This is indicated by the extinguished control indicator .

Catalytic converter

The catalytic converter reduces the amount of harmful substances in the exhaust gases.

Caution

Fuel grades other than those listed on pages ⇨ 149, ⇨ 201 could damage the catalytic converter or electronic components.

Unburnt petrol will overheat and damage the catalytic converter. Therefore avoid excessive use of the starter, running the fuel tank dry and starting the engine by pushing or towing.

In the event of misfiring, uneven engine running, a reduction in engine performance or other unusual problems, have the cause of the fault rectified by a workshop as soon as possible. In an emergency, driving can be continued for a short period, keeping vehicle speed and engine speed low.

Automatic transmission

The automatic transmission permits automatic gearshifting (automatic mode) or manual gearshifting (manual mode).

Transmission display

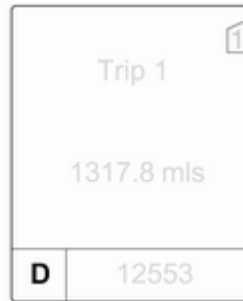

The mode or selected gear is shown in the transmission display.

Selector lever

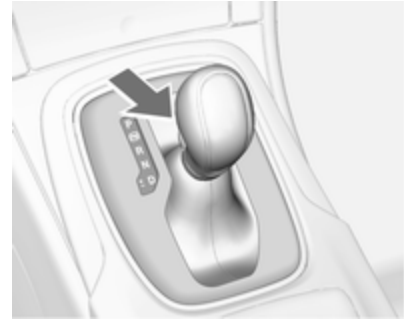

- P** = park position, wheels are locked, engage only when the vehicle is stationary and the parking brake is applied
- R** = reverse gear, engage only when vehicle is stationary
- N** = neutral
- D** = automatic mode with all gears

The selector lever is locked in **P** and can only be moved when the ignition is on and the brake pedal is applied.



Without applied brake pedal the control indicator (Ⓢ) illuminates.

If the selector lever is not in **P** when the ignition is switched off, control indicator (Ⓢ) and **P** flash.

To engage **P** or **R**, press the release button.

The engine can only be started with lever in position **P** or **N**. When position **N** is selected, press brake pedal or apply parking brake before starting.

Do not do not operate accelerator pedal while engaging a gear. Never depress the accelerator pedal and brake pedal at the same time.

When a gear is engaged, the vehicle slowly begins to creep when the brake is released.

Engine braking

To utilise the engine braking effect, select a lower gear in good time when driving downhill, see manual mode.

Rocking the vehicle

Rocking the vehicle is only permissible if the vehicle is stuck in sand, mud or snow. Move the selector lever between **D** and **R** in a repeat pattern. Do not race the engine and avoid sudden acceleration.

Parking

Apply the parking brake and engage **P**.

The ignition key can only be removed when the selector lever is in position **P**.

Manual mode

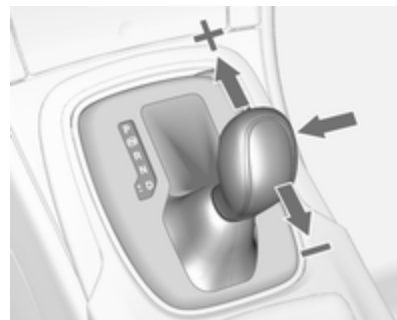

Move selector lever out of position **D** towards the left and then forwards or backwards.

+ = Shift to a higher gear.

- = Shift to a lower gear.

If a higher gear is selected when vehicle speed is too low, or a lower gear when vehicle speed is too high, the shift is not executed. This can cause a message in the Driver-Info-Display.

In manual mode no automatic shifting to a higher gear takes place at high engine revolutions.

Electronic driving programmes

- Following a cold start, the operating temperature programme increases engine speed to quickly bring the catalytic converter to the required temperature.
- The automatic neutral shift function automatically shifts to idling when the vehicle is stopped with a forward gear engaged and the brake pedal is pressed.
- When Sport mode is engaged, the vehicle shifts at higher engine speeds (unless cruise control is on). Sport mode ⇨ 140.
- Special programmes automatically adapt the shifting points when driving up inclines or down hills.

Kickdown

If the accelerator pedal is pressed down completely in automatic mode, the transmission shifts to a lower gear depending on engine speed.

Fault

In the event of a fault,  illuminates. Additionally a code number or a vehicle message is displayed in the Driver Information Center. Vehicle messages ⇨ 94.

The transmission no longer shifts automatically. Continued travel is possible with manual shifting.

Only the highest gear is available. Depending on the fault, 2nd gear may also be available in manual mode. Shift only when vehicle is stationary. Have the cause of the fault remedied by a workshop.

Interruption of power supply

In the event of an interruption of power supply, the selector lever cannot be moved out of the **P** position. The ignition key cannot be removed from the ignition lock.

If the battery is discharged, start the vehicle using jump leads ⇨ 188.

If the battery is not the cause of the fault, release the selector lever and remove the ignition key from the ignition lock.

Release selector lever

1. Apply parking brake.

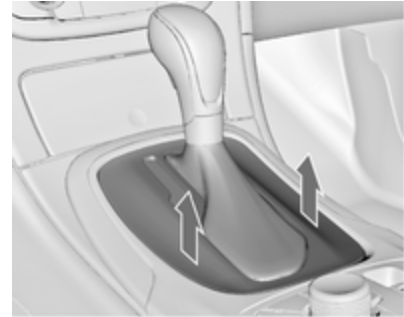

2. Release selector lever trim from centre console at rear, fold upwards and rotate to the left.

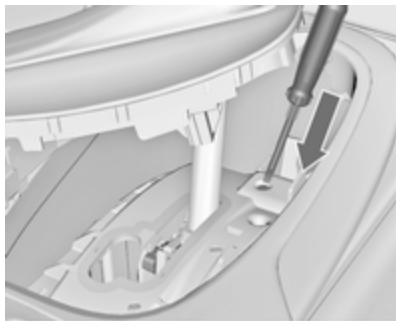

3. Insert a screwdriver into the opening as far as it will go and move the selector lever out of **P** or **N**. If **P** or **N** is engaged again, the selector lever will be locked in position again. Have the cause of the power supply interruption remedied by a workshop.
4. Mount the selector lever trim on the centre console and refit.

Remove ignition key from ignition switch

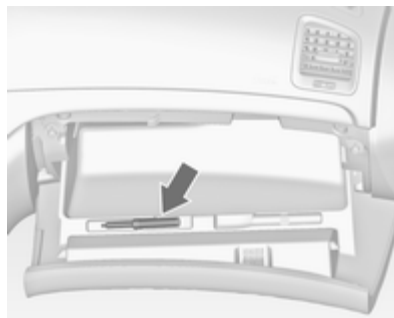

Take the special tool from the inside of the glove box cover.

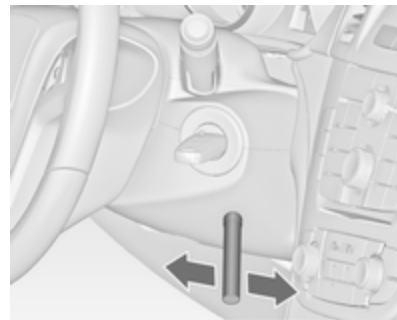

Insert the special tool into the opening below the ignition lock as far as it will go and swivel it slightly.

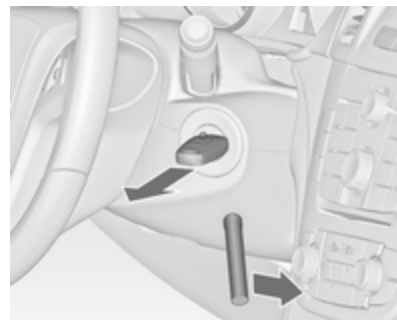

Turn special tool to the front and remove key from the ignition lock. Several attempts may be required to successfully remove the key.

Manual transmission

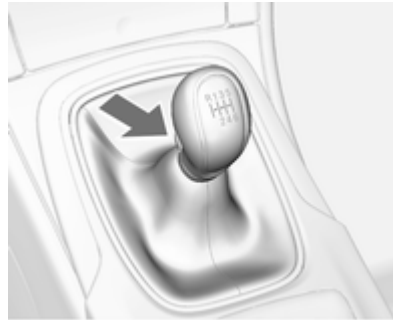

To engage reverse, with the vehicle stationary press the release button on the selector lever and engage the gear.

If the gear does not engage, set the lever to neutral, release the clutch pedal and depress again; then repeat gear selection.

Do not grind the clutch unnecessarily.

When operating, depress the clutch pedal completely. Do not use the pedal as a foot rest.

Caution

It is not advisable to drive with the hand resting on the selector lever.

Drive systems

All-wheel drive

The All-wheel drive system enhances driving characteristics and stability, and helps to achieve the best possible driveability regardless of ground surface. The system is always active and cannot be deactivated.

The torque is distributed steplessly between the front and rear wheels, depending on the driving conditions.

For optimum system performance, the vehicle's tyres should not have varying degrees of wear.

If a service message is displayed in the Driver Information Center, the system may have limited functionality (or be completely disabled in some cases, i.e. the vehicle switches to front-wheel drive). Seek the assistance of a workshop.

Towing the vehicle ⇨ 190.

Brakes

The brake system comprises two independent brake circuits.

If a brake circuit fails, the vehicle can still be braked using the other brake circuit. However, braking effect is achieved only when the brake pedal is depressed firmly. Considerably more force is needed for this. The braking distance is extended. Seek the assistance of a workshop before continuing your journey.

When the engine is not running, the support of the brake servo unit disappears once the brake pedal has been depressed once or twice. Braking effect is not reduced, but braking requires significantly greater force. It is especially important to bear this in mind when being towed.

Control indicator  ⇨ 85.

Antilock brake system

Antilock brake system (ABS) prevents the wheels from locking.

ABS starts to regulate brake pressure as soon as a wheel shows a tendency to lock. The vehicle remains steerable, even during hard braking.

ABS control is made apparent through a pulse in the brake pedal and the noise of the regulation process.

For optimum braking, keep the brake pedal fully depressed throughout the braking process, despite the fact that the pedal is pulsating. Do not reduce the pressure on the pedal.

Control indicator  ⇨ 86.

Adaptive brake light

During full braking, all three brake lights flash for the duration of ABS control.

Fault

Warning

If there is a fault in the ABS, the wheels may be liable to lock due to braking that is heavier than normal. The advantages of ABS are no longer available. During hard braking, the vehicle can no longer be steered and may swerve.

Have the cause of the fault remedied by a workshop.

Parking brake

Manual parking brake



Always apply parking brake firmly without operating the release button, and apply as firmly as possible on a downhill or uphill slope.

To release the parking brake, pull the lever up slightly, press the release button and fully lower the lever.



To reduce the operating forces of the parking brake, depress the foot brake at the same time.

Control indicator  ↷ 85.

Electrical parking brake



Applying when vehicle is stationary

Pull switch , the electrical parking brake operates automatically with an adequate force. For maximum force, e.g. parking with trailer or on inclines, pull switch  twice.

The electrical parking brake can always be activated, even if the ignition is off.

Do not operate electrical parking brake system too often without engine running because this will discharge the battery.

Before leaving the vehicle, check the electrical parking brake status.

Control indicator (P) ⇨ 85.

Releasing

Switch on ignition. Keep foot brake pedal depressed and then push switch (P).

Drive away function

Depressing clutch pedal (manual transmission) or engaging drive gear (automatic transmission) and then depressing the accelerator pedal releases the electrical parking brake automatically. This is not possible when the switch is pulled at the same time.

This function also helps driving away on inclines.

Aggressive drive away may reduce life time of wear parts.

Dynamic braking when vehicle is moving

When the vehicle is moving and the switch (P) is kept pulled, the electrical parking brake system will decelerate the vehicle, but will not apply statically.

As soon as the switch (P) is released, dynamic braking will be stopped.

Fault

Failure mode of electrical parking brake is indicated by a control indicator (P) and by a code number or a vehicle message which is displayed in the Driver Information Center. Vehicle messages ⇨ 94.

Apply electrical parking brake: pull and hold the switch (P) for more than 5 seconds. If control indicator (P) illuminates, electrical parking brake is applied.

Release electrical parking brake: push and hold the switch (P) for more than 2 seconds. If control indicator (P) goes out, electrical parking brake is released.

Control indicator (P) flashes: electrical parking brake is not fully applied or released. When continuously flashing, release electrical parking brake and retry applying.

Brake assist

If the brake pedal is depressed quickly and forcefully, maximum brake force is automatically applied (full braking).

The operation of the brake assist might become apparent by a pulse in the brake pedal and a larger resistance when depressing the brake pedal.

Maintain steady pressure on the brake pedal for as long as full braking is required. Maximum brake force is automatically reduced when the brake pedal is released.

Hill start assist

The system helps driving away on inclines at a constant speed by holding the vehicle. After the parking brake is disengaged and the foot brake pedal is released, the brakes are released after a 2 second delay.

Ride control systems

Traction Control system

The Traction Control system (TC) is a component of the Electronic Stability Control.

TC improves driving stability when necessary, regardless of the type of road surface or tyre grip, by preventing the drive wheels from spinning.

As soon as the drive wheels starts to spin, engine output is reduced and the wheel spinning the most is braked individually. This considerably improves the driving stability of the vehicle on slippery road surfaces.

TC is operational as soon as the control indicator  extinguishes.

When TC is active  flashes.

Warning

Do not let this special safety feature tempt you into taking risks when driving.

Adapt speed to the road conditions.

Control indicator  ⇨ 87.

Deactivation



TC can be switched off when spinning of drive wheels is required: press button  shortly.

Control indicator  illuminates.

TC is reactivated by pressing the  button again.

TC is also reactivated the next time the ignition is switched on.

Electronic Stability Control

Electronic Stability Control (ESC) improves driving stability when necessary, regardless of the type of road surface or tyre grip. It also prevents the drive wheels from spinning.

As soon as the vehicle starts to swerve (understeer/oversteer), engine output is reduced and the wheels are braked individually. This considerably improves the driving stability of the vehicle on slippery road surfaces.

ESC is operational as soon as the control indicator  extinguishes.

When ESC is active  flashes.

Warning

Do not let this special safety feature tempt you into taking risks when driving.

Adapt speed to the road conditions.

Control indicator   87.

Deactivation



For very high-performance driving ESC can be deactivated: hold button  depressed for approx. 7 seconds.

Control indicator  illuminates.

ESC is reactivated by pressing the  button again. If the TC system was previously disabled, both TC and ESC are reactivated.

ESC is also reactivated the next time the ignition is switched on.

Interactive driving system

Flex Ride

Flex Ride driving system allows the driver to select between three driving modes:

- SPORT mode: press button **SPORT**, LED illuminates.
- TOUR mode: press button **TOUR**, LED illuminates.
- Normal mode: neither the **SPORT** nor the **TOUR** button are pressed, no LED illuminates.

Deactivate SPORT mode and TOUR mode by pressing corresponding button once more.

In each driving mode Flex Ride networks the following electronic systems:

- Continuous Damping Control.
- Accelerator Pedal Control.
- Steering Control.
- All-wheel drive.
- Automatic transmission.



SPORT mode

The settings of the systems are adapted to a sportier driving style:

- Damping of shock absorbers reacts more stiffly to provide better contact with the road surface.
- The engine reacts more quickly to the accelerator pedal.
- Steering support is reduced.
- Engine torque of All-wheel drive is distributed more to the rear axle.
- Shift points of automatic transmission occur later.
- With SPORT mode activated, the illumination of main instruments changes from white to red.

TOUR mode

The settings of the systems are adapted to a comfort driving style:

- Damping of shock absorbers reacts more softly.
- Accelerator pedal reacts with standard settings.
- Steering support is in standard mode.

- Engine torque of All-wheel drive is distributed mainly to the front axle.
- Shift points of automatic transmission occur in a comfort mode.
- Illumination of main instruments is white.

Normal mode

All settings of the systems are adapted to standard values.

Drive mode control

Within each manually selected driving mode (SPORT, TOUR or Normal), the Drive Mode Control (DMC) detects and continuously analyses the real driving characteristics, responses by the driver, and the active dynamic state of the vehicle. If necessary the control unit of DMC automatically changes the settings within the selected driving mode or, when recognising greater variations, the driving mode is changed for the length of variation.

If, for example, **Normal** mode is selected and DMC detects a sporty driving behaviour, DMC changes

several settings of the Normal mode into sporty settings. The DMC changes to **Sport** mode in case of very sporty driving behaviour.

If, for example, TOUR mode is selected and whilst driving on a winding road a sudden hard brake is necessary, DMC will detect the dynamic vehicle condition and changes the settings for suspension to SPORT mode to increase vehicle stability.

When the driving characteristics or the dynamic vehicle state return to their former state, DMC will change the settings to the preselected driving mode.

Personalised settings in the Sport mode

The driver can select the functions of the SPORT mode when **SPORT** button is pushed. These settings can be changed in the menu **Settings** in the Info-Display. Vehicle personalisation ↷ 102

Cruise control

The cruise control can store and maintain speeds of approx. 20 to 120 mph. Deviations from the stored speeds may occur when driving uphill or downhill.

For safety reasons the cruise control cannot be activated until the foot brake has been operated once. Activating in first gear is not possible.





Do not use the cruise control if it is not advisable to maintain a constant speed.

With automatic transmission, only activate cruise control in automatic mode.

Control indicator  ↷ 89.

Switching on

Press rocker switch  at the upper end, control indicator  illuminates white.

Activation

Accelerate to the desired speed and turn thumb wheel to **SET/-**, the current speed is stored and maintained. Control indicator  illuminates green. Accelerator pedal can be released.

Vehicle speed can be increased by depressing the accelerator pedal. When the accelerator pedal is released, the previously stored speed is resumed.

Increase speed



With cruise control active, hold thumb wheel turned to **RES/+** or briefly turn to **RES/+** repeatedly: speed increases continuously or in small increments.

Alternatively accelerate to the desired speed and store by turning to **RES/+**.

Reduce speed

With cruise control active, hold thumb wheel turned to **SET/-** or briefly turn to **SET/-** repeatedly: speed decreases continuously or in small increments.

Deactivation

Press button , control indicator  illuminates white. Cruise control is deactivated. The stored speed is maintained.



Automatic deactivation:

- vehicle speed below approx. 20 mph,
- the brake pedal is depressed,
- the clutch pedal is depressed,
- selector lever in **N**,
- the Traction Control system or Electronic Stability Control is operating.

Resume stored speed

Turn thumb wheel to **RES/+** at a speed above 20 mph. The stored speed will be obtained.

Switching off

Press rocker switch  at the lower end, control indicator  is off. The stored speed is deleted. Switching off the ignition deletes also the stored speed.

Object detection systems

Parking assist



The parking assist makes parking easier by measuring the distance between the vehicle and obstacles, and giving acoustic signals. It is the driver, however, who bears full responsibility for the parking manoeuvre.

The system consists of four ultrasonic parking sensors in each of the front and rear bumpers.

Control indicator   87.

Activation

When reverse gear is engaged, the system is activated automatically.

The front parking assist can also be activated at a low speed by pressing the **P** button.

An illuminated LED in the parking assist button indicates that the system is ready to operate.

An obstacle is indicated by a buzzing sound. The interval between the sounds becomes shorter as the vehicle gets closer to the obstacle. When the distance is less than 1 ft, the buzzing is continuous.

Deactivation

Deactivate the system by pressing the **P** button.

The LED in the button will go out and **Park Assist Off** will be displayed in the Driver Information Center.

The system is deactivated automatically when the vehicle is driven above a certain speed.

Fault

In the event of a fault in the system, **P** illuminates and a message is displayed in the Driver Information Center.

If the system does not work due to temporary conditions like snow covered sensors, **P** illuminates or a message is displayed in the Driver Information Center.

Vehicle messages ⇨ 94.

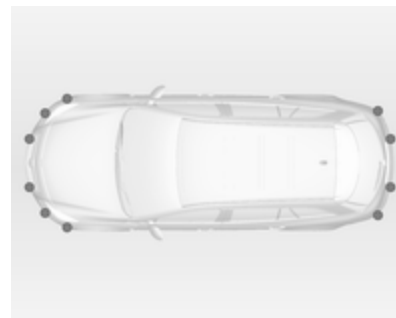
Advanced parking aid

The advanced parking aid system manoeuvres the driver into a parking slot by giving instructions on the Driver Information Center and acoustic signals. It is the driver, however, who bears full responsibility for accepting the parking slot suggested by the system and the parking manoeuvre.

The system uses the sensors of the parking assist system in combination with two additional sensors on both sides of the front bumper.

Activation



When looking for a parking slot, the system has to be activated by pressing the **P+** button.

The system only operates at a speed up to 18 mph.

The maximum allowed parallel distance between the vehicle and a row of parking cars is 1.8 m.

Functionality

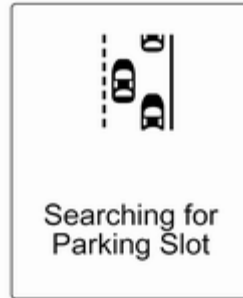

When the vehicle passes a row of cars and the system is activated, the advanced parking aid system begins looking for a suitable parking slot. When a suitable slot is detected, a visual feedback and acoustic signals are given on the Driver Information Center.

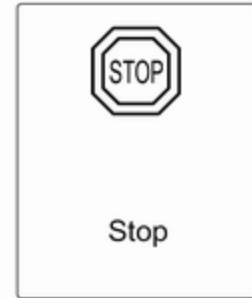

The suggestion of the system is accepted when the vehicle is stopped by the driver within approx. 30 ft after the message is given. The system calculates the optimal route into the parking slot. Then it manoeuvres the driver into the slot by giving detailed instructions.



The instructions show:

- a hint when driving faster than 18 mph,
- the demand to stop the vehicle, when a parking slot is detected,
- the direction of driving during the parking manoeuvre,
- the steering wheel position during parking,
- for some of the instructions a progress bar is shown.

A successful parking manoeuvre is indicated by the target symbol.



If the driver does not stop the vehicle within approx. 30 ft after a parking slot is proposed, the system starts to search for another suitable parking slot.

Changing the parking side

The system is configured to detect parking slots on the passenger side. To detect parking slots on the driver side, push button  for approx. 2 seconds.

Display priorities

After activating the advanced parking aid, a message appears on the Driver Information Center. Indication of

messages with higher priority like Vehicle Messages  94 will be displayed. After approving the message by pressing the **SET/CLR** button, parking aid messages appear again and parking can be continued.

Deactivation

The system is deactivated by:

- pushing the  button
- parking manoeuvre successfully ended
- driving faster than 18 mph
- switching off the ignition

Deactivation by the driver or by the system during manoeuvring will be indicated by **Parking Deactivated** in the Driver Information Center.

Fault

A message appears in the Driver Information Center when:

- there is a fault in the system
- the driver did not successfully complete the parking manoeuvre
- the system is not operational



If an object is detected during parking instructions, **STOP** is indicated in the Driver Information Center. Removing the object will resume the parking manoeuvre. If the object is not removed, the system will be deactivated. Push button  to activate the system and search for a new parking slot.

Important hints for using the parking assist systems

Warning

Under certain circumstances, various reflective surfaces on objects or clothing as well as external noise sources may cause the system to fail to detect obstacles.

Caution

Performance of the sensor can be reduced when sensors are covered, e.g. by ice or snow.

Performance of the parking assist systems can be reduced due to heavy loading.

Special conditions apply if there are taller vehicles involved (e.g. off-road vehicles, mini vans, vans). Object identification in the upper part of these vehicles cannot be guaranteed.

Objects with a very small reflection cross section, like objects of narrow size or soft materials, may not be detected by the system.

Parking assist will not avoid a collision with objects which are out of the detection range of the sensors.

Notice

The parking assist system automatically detects factory-fitted towing equipment. It is deactivated when the connector is plugged in.

It is possible that the sensor detects a non-existing object (echo disturbance) caused by external acoustical or mechanic disturbances.

Advanced parking aid system may not respond to changes in the parking space after initiating a parallel parking manoeuvre.

Lane departure warning

The lane departure warning system observes the lane markings between which the vehicle is driving via a front camera. The system detects lane changes and warns the driver in the event of an unintended lane change by visual and acoustic signals.

Criteria for the detection of an unintended lane change are

- no operation of turn signals
- no brake pedal operation

- no active accelerator operation or speeding-up

- no active steering

If the driver is active, no warning will be issued.

Activation

The lane departure warning system is activated by pressing the  button.

The illuminated LED in the button indicates that the system is switched on. When the control indicator  in the instrument cluster illuminates green, the system is ready to operate.

The system is only operable at vehicle speeds above 37 mph and if lane markings are available.



When the system recognizes an unintended lane change, the control indicator  changes to yellow and flashes. Simultaneously a chime sound is activated.



Deactivation

The system is deactivated by pushing  button. Deactivation is indicated by a message in the Driver Information Center.

At speeds below 37 mph the system is inoperable.

Fault

The lane departure warning system may not operate properly when:

- the windscreen is not clean
- there are adverse environmental conditions like heavy rain, snow, direct sunlight or shadows
- no lane marking can be detected

If the lane departure warning system detects one of these conditions, the control indicator  illuminates yellow.

Additionally a warning code or a warning message is displayed in the Driver Information Center.

Fuel

Fuel for petrol engines

Only use unleaded fuel that complies with DIN EN 228.

Equivalent standardised fuels with an ethanol content of max. 10 % by volume may be used. In this case only use fuel that complies with DIN 51625.

Use fuel with the recommended octane rating  201. Use of fuel with too low an octane rating can reduce engine power and torque and slightly increases fuel consumption.

Caution
Use of fuel with too low an octane rating could lead to uncontrolled combustion and engine damage.

Fuel for diesel engines

Only use diesel fuel that complies with DIN EN 590. The fuel must have low sulphur content (max. 10 ppm). Equivalent standardised fuels with

a biodiesel (= FAME according to EN14214) content of max. 7% by volume (like DIN 51628 or equivalent standards) may be used.

Country-specific exception for Morocco: use Diesel 50 ppm only.

Do not use marine diesel oils, heating oils or entirely or partially plant-based diesel fuels, such as rape seed oil or bio diesel, Aquazole and similar diesel-water emulsions. Diesel fuels must not be diluted with fuels for petrol engines.

Refuelling



Danger

Before refuelling, switch off engine and any external heaters with combustion chambers. Switch off any mobile phones.

Follow the operating and safety instructions of the filling station when refuelling.

Danger

Fuel is flammable and explosive. No smoking. No naked flames or sparks.

If you can smell fuel in your vehicle, have the cause of this remedied immediately by a workshop.

Fuel filler flap is located at right rear side of vehicle.



The fuel filler flap can only be opened if the vehicle is unlocked. Release the fuel filler flap by pushing the flap.

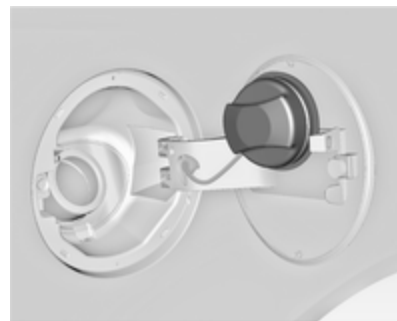

The fuel filler cap can be retained in the bracket on the fuel filler flap.

Caution

Wipe off any overflowing fuel immediately.

Fuel filler cap

Only use genuine fuel filler caps. Diesel-engined vehicles have special fuel filler caps.

Fuel consumption - CO₂-Emissions

The determination of fuel consumption is regulated by European directive 715/2007 692/2008 A.

The directive is oriented to actual driving practices: Urban driving is rated at approx. $\frac{1}{3}$ and extra urban driving at approx. $\frac{2}{3}$. Cold starts and acceleration phases are also taken into consideration.

The specification of CO₂ emission is also a constituent of the directive.

The figures given must not be taken as a guarantee for the actual fuel consumption of a particular vehicle. Furthermore, fuel consumption is dependent on personal driving style as well as road and traffic conditions.

All values are based on the EU base model with standard equipment.

The calculation of fuel consumption takes into account the vehicle's kerb weight, ascertained in accordance with the regulations. Optional equipment may result in slightly higher fuel consumption and CO₂ emission levels and a lower maximum speed.

Fuel consumption, CO₂ emissions
⇨ 205.

Towing

General information

The factory-fitted towing equipment is folded up under the rear bumper fascia.

Entrust fitting of towing equipment at a later date to a workshop. It may be necessary to make changes that affect the cooling system, heat shields or other equipment. Only use towing equipment that has been approved for your vehicle.

To avoid vehicle damage, the power tailgate cannot be operated with the radio remote control when a trailer is electrically connected.

Fitting of towing equipment could cover the opening of the towing eye. If this is the case use the coupling ball bar for towing.

Installation dimensions of factory-fitted towing equipment ⇨ 253.

Driving characteristics and towing tips

Before attaching a trailer, lubricate the coupling ball. However, do not do so if a stabiliser, which acts on the coupling ball, is being used to reduce snaking movements.

For trailers with low driving stability and trailers with a permitted gross vehicle weight of more than 1400 kg the use of a stabiliser is strongly recommended when driving above 50 mph (80 km/h).

If the trailer starts snaking, drive more slowly, do not attempt to correct the steering and brake sharply if necessary.

When driving downhill, drive in the same gear as if driving uphill and drive at a similar speed.

Adjust tyre pressure to the value specified for full load ⇨ 216.

Trailer towing

Trailer loads

The permissible trailer loads are vehicle and engine-dependent maximum values which must not be exceeded. The actual trailer load is the difference between the actual gross weight of the trailer and the actual coupling socket load with the trailer coupled.

The permissible trailer loads are specified in the vehicle documents. In general, they are valid for gradients up to max. 12 %.

The permitted trailer load applies up to the specified incline and up to an altitude of 3300 ft above sea level. Since engine power decreases as altitude increases due to the air becoming thinner, therefore reducing climbing ability, the permissible gross train weight also decreases by 10 % for every 3300 ft of additional altitude. The gross train weight does not have to be reduced when driving on roads with slight inclines (less than 8 %, e.g. motorways).

The permissible gross train weight must not be exceeded. This weight is specified on the identification plate ⇨ 199.

Vertical coupling load

The vertical coupling load is the load exerted by the trailer on the coupling ball. It can be varied by changing the weight distribution when loading the trailer.

The maximum permissible vertical coupling load (85 kg) is specified on the towing equipment identification plate and in the vehicle documents. Always aim for the maximum load, especially in the case of heavy trailers. The vertical coupling load should never fall below 25 kg.

Rear axle load

When the trailer is coupled and the towing vehicle fully loaded, the permissible rear axle load (see identification plate or vehicle documents) may be exceeded by 90 kg for the Hatchback and 85 kg for the Estate, the gross vehicle weight rating may be exceeded by 65 kg for the Hatchback and 60 kg for the Estate. If the permissible rear axle load is exceeded, a maximum speed of 60 mph applies.

Towing equipment

Caution

The folding coupling ball bar cannot be removed from the vehicle. When driving without a trailer, fold in the coupling ball bar.

⚠ Warning

Make sure that no one is in the pivot zone of the coupling ball bar. Risk of body injury.

When releasing the stowed coupling ball bar, make sure to stand left of the grip.

Release stowed coupling ball bar

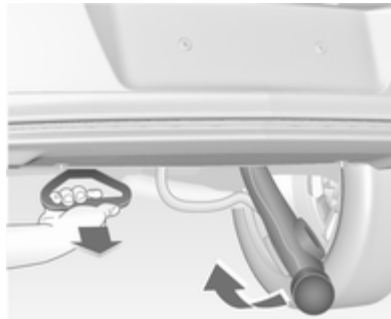

Pull the grip under the rear bumper fascia at an angle of approx. 45° to the ground.

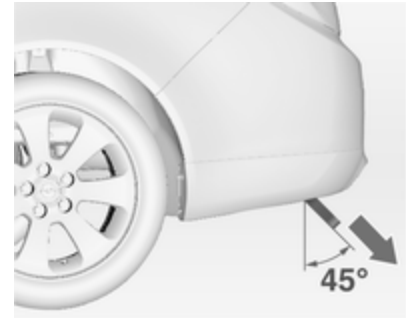

A buzzing tone sounds as a warning when the release handle is pulled out and the ball neck is disengaged.

Take the released coupling ball bar and raise it up until it engages.

Be sure to have the coupling ball bar correctly engaged and the released handle guided back to its hidden initial position, otherwise the buzzing tone will not stop.

Stow/hide coupling ball bar

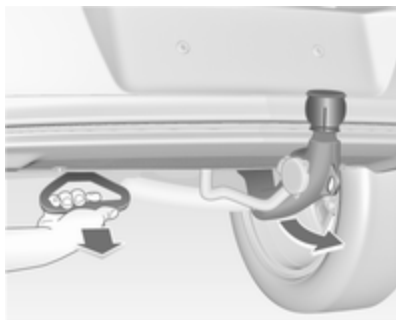

Pull the grip under the rear bumper fascia at an angle of approx. 45° to the ground.

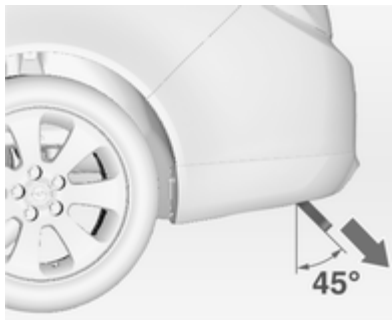

A buzzing tone sounds as a warning when the release handle is pulled out and the ball neck is disengaged.



With the flat of the hand, swivel the released coupling ball bar to the right until it engages under the floor. Make sure that the release handle is back in its hidden initial position, otherwise the buzzing tone will not stop.

⚠ Warning

Towing a trailer is permitted only when the coupling ball bar is fitted correctly. If the coupling ball bar does not engage correctly or if the release handle is impossible to guide to its hidden initial position in the housing or if the buzzing tone sounds after engaging the coupling ball bar, seek the assistance of a workshop.

Eye for break-away stopping cable

Attach break-away stopping cable to eye.

Trailer stability assist

If the system detects snaking movements, engine power is reduced and the vehicle/trailer combination is

selectively braked until the snaking ceases. While system is working keep steering wheel as still as possible.

Trailer stability assist (TSA) is a function of the Electronic Stability Control ⇨ 140.

Vehicle care

General Information	156
Vehicle checks	157
Bulb replacement	162
Electrical system	171
Vehicle tools	177
Wheels and tyres	178
Jump starting	188
Towing	190
Appearance care	192

General Information

Accessories and vehicle modifications

We recommend using genuine parts and accessories and factory approved parts specific for your vehicle type. We cannot assess or guarantee reliability of other products - even if they have a regulatory or otherwise granted approval.

Do not make any modifications to the electrical system, e.g. changes of electronic control units (chip tuning).

Vehicle storage

Storage for a long period of time

If the vehicle is to be stored for several months:

- Wash and wax the vehicle.
- Have the wax in the engine compartment and underbody checked.
- Clean and preserve rubber seals.
- Change engine oil.

- Drain washer fluid reservoir.
- Check coolant antifreeze and corrosion protection.
- Adjust tyre pressure to the value specified for full load.
- Park vehicle in dry, well ventilated place. Engage first or reverse gear or set selector lever to **P**. Prevent the vehicle from rolling.
- Do not apply parking brake.
- Open bonnet, close all doors and lock the vehicle.
- Disconnect the clamp from the negative terminal of the vehicle battery. Beware that all systems are not functional, e.g. anti-theft alarm system.

Putting back into operation

When the vehicle is to be put back into operation:

- Connect the clamp to the negative terminal of the vehicle battery. Activate the electronics of the power windows.
- Check tyre pressure.
- Fill up the washer fluid reservoir.

- Check the engine oil level.
- Check the coolant level.
- Fit the number plate if necessary.

End-of-life vehicle recovery

Information on end-of-life vehicle recovery centres and the recycling of end-of-life vehicles is available on our website. Only entrust this work to an authorised recycling centre.

Vehicle checks

Performing work

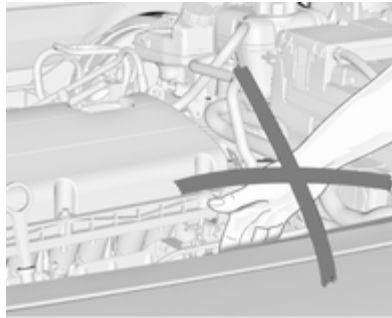

Warning

Only perform engine compartment checks when the ignition is off.
The cooling fan may start operating even if the ignition is off.

Danger

The ignition system and Xenon headlights use extremely high voltage. Do not touch.

Bonnet

Opening



Pull the release lever and return it to its original position.



Push the safety catch to the right and open the bonnet.

The bonnet is held open automatically.

Air intake ⇨ 125.

Closing

Lower the bonnet and allow it to drop into the catch. Check that the bonnet is engaged.

Engine oil

Engine oil level is checked automatically, Vehicle messages ⇨ 94. However check the engine oil

manually on a regular basis to prevent damage to the engine. Ensure that the correct specification of oil is used. Recommended fluids and lubricants ⇨ 196.

Check with the vehicle on a level surface. The engine must be at operating temperature and switched off for at least 5 minutes.

Pull out the dipstick, wipe it clean, insert it to the stop on the handle, pull out and read the engine oil level.

Insert dipstick to the stop on the handle and make half a turn.

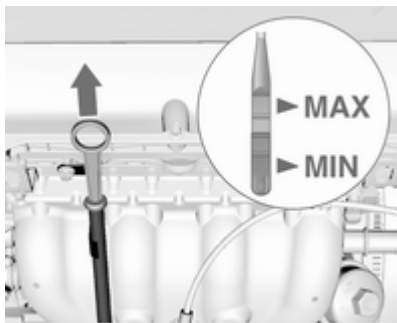

Different dipsticks are used depending on engine variant.

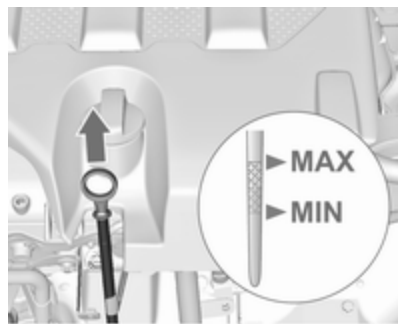

When the engine oil level has dropped to the **MIN** mark, top up engine oil.

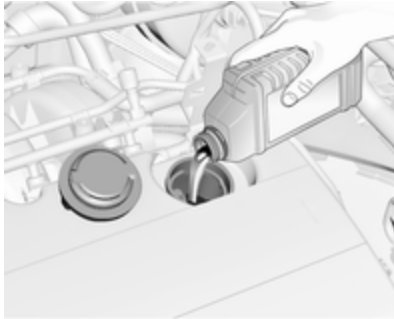

We recommend the use of the same grade of engine oil that was used at last change.

The engine oil level must not exceed the **MAX** mark on the dipstick.

Caution

Overfilled engine oil must be drained or suctioned out.

Capacities ⇨ 214, Engine oil quality/viscosity ⇨ 196.

Fit the cap on straight and tighten it.

Engine coolant

The coolant provides freeze protection down to approx. -28 °C.

Caution

Only use approved antifreeze.

Coolant level

Caution

Too low a coolant level can cause engine damage.

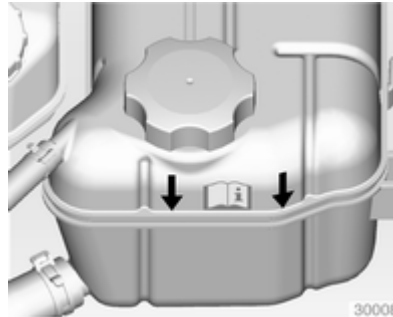

If the cooling system is cold, the coolant level should be above the filling line mark. Top up if the level is low.



On another version the filling line mark is inside the filler opening. To check open the cap.

Warning

Allow the engine to cool before opening the cap. Carefully open the cap, relieving the pressure slowly.

To top up use a 1:1 mixture of approved coolant concentrate mixed with clean tap water. If no coolant concentrate is available, use clean tap water. Install the cap tightly. Have the coolant concentration checked and have the cause of the coolant loss remedied by a workshop.

Washer fluid



Fill with clean water mixed with a suitable quantity of washer fluid which contains antifreeze. For the correct mixing ratio refer to the washer fluid container.

Caution

Only washer fluid with a sufficient antifreeze concentration provides protection at low temperatures or a sudden drop in temperature.

Brakes

In the event of minimum thickness of the brake lining, control indicator  illuminates. Additionally a code number or a vehicle message is displayed in the Driver Information Center. Vehicle messages ⇨ 94.

Continued driving is possible but have the brake lining replaced as soon as possible.

Once new brake linings are installed, do not brake unnecessarily hard for the first few journeys.

Brake fluid

Warning

Brake fluid is poisonous and corrosive. Avoid contact with eyes, skin, fabrics and painted surfaces.

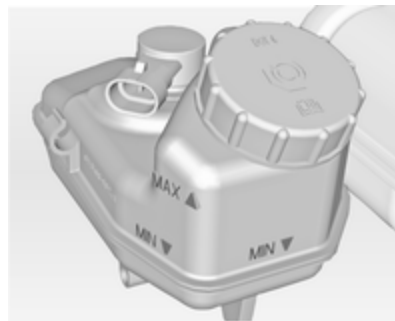

The brake fluid level must be between the **MIN** and the **MAX** marks.

When topping up, ensure maximum cleanliness as contamination of the brake fluid can lead to brake system malfunctions. Have the cause of the loss of brake fluid remedied by a workshop.

Only use high-performance brake fluid approved for the vehicle, Brake and clutch fluid ↗ 196.

Battery

The vehicle battery is maintenance-free provided that the driving profile allows sufficient charging of the battery. Short-distance-driving and frequent engine starts can discharge the battery. Avoid the use of unnecessary electrical consumers.



Batteries do not belong in household waste. They must be disposed of at an appropriate recycling collection point.

Laying up the vehicle for more than 4 weeks can lead to battery discharge. Disconnect the clamp from the negative terminal of the vehicle battery.

Ensure the ignition is switched off before connecting or disconnecting the vehicle battery.

The anti-theft alarm siren must be deactivated as follows: Switch the ignition on then off, disconnect the vehicle's battery within 15 seconds.

Battery discharge protection ↗ 117.

Diesel fuel system bleeding

If the tank has been run dry, the diesel fuel system must be bled. Switch on the ignition three times for 15 seconds at a time. Then start the engine for a maximum of 40 seconds. Repeat this process after no less than 5 seconds. If the engine fails to start, seek the assistance of a workshop.

Wiper blade replacement

Wiper blades on the windscreen

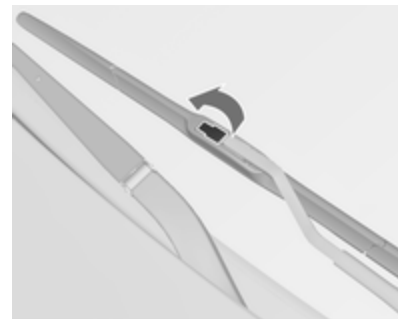

Lift the wiper arm, open the retaining clip.

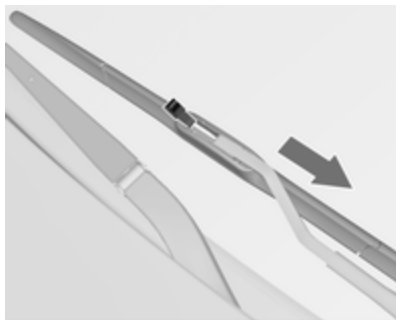

Lift the wiper arm, press the two catches on the arm, disengage the wiper blade and remove.

Disengage the wiper blade and remove.

Wiper blade on the rear window

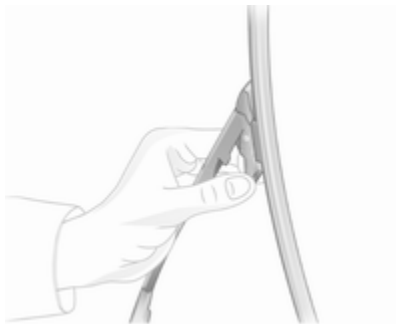

Bulb replacement

Switch off the ignition and switch off the relevant switch or close the doors.

Only hold a new bulb at the base! Do not touch the bulb glass with bare hands.

Use only the same bulb type for replacement.

Replace headlight bulbs from within the engine compartment.

Halogen headlights

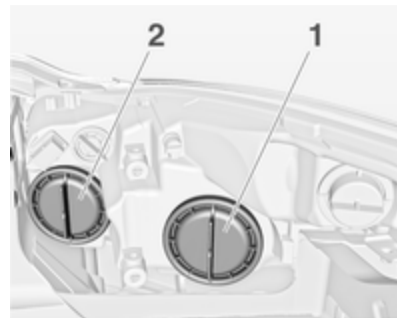

Headlights have separate systems for high beam **2** (inner bulbs) and low beam **1** (outer bulbs).

Low beam/daytime running lights



1. Rotate cap **1** anti-clockwise and remove.



2. Rotate bulb holder anti-clockwise to disengage. Withdraw the bulb holder from the reflector housing.

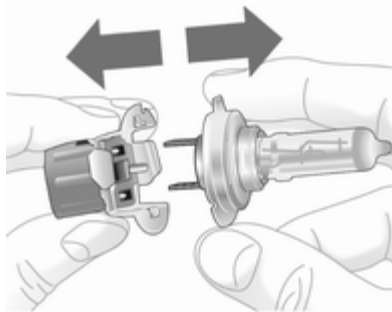

3. Detach bulb from bulb holder and renew the bulb.
4. Insert the bulb holder, engaging the two lugs in the reflector housing and rotate clockwise to secure.
5. Rotate bulb holder clockwise as far as it will go.
6. Fit cap and rotate clockwise.

High beam



1. Rotate cap **2** anti-clockwise and remove.
2. Detach wiring connector from bulb.



3. Disengage spring clip from retainer by pressing forward and then swing downwards.
4. Withdraw bulb from reflector housing.
5. When installing the new bulb, insert lugs in the reflector housing recesses and engage the spring clip.
6. Reattach the wiring connector onto bulb.
7. Fit cap and rotate clockwise.

Front turn signal



1. Rotate cap anti-clockwise and remove.

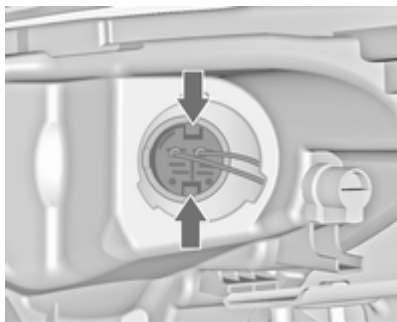

2. Press latches and withdraw bulb holder from reflector housing.

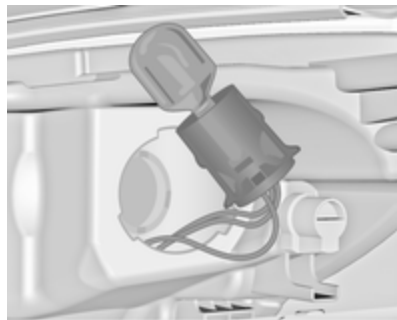

3. Remove bulb from socket and renew bulb.
4. Insert bulb holder in reflector housing. Fit cap and rotate clockwise.

Sidelights



1. Rotate bulb holder anti-clockwise and disengage.

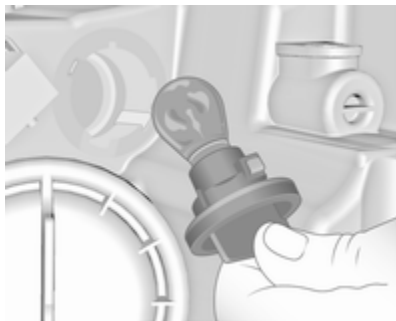

2. Push bulb into socket slightly, rotate anti-clockwise, remove and renew bulb.
3. Insert bulb holder in reflector housing, rotate clockwise to engage.

Xenon headlights

⚠ Danger

Xenon headlights work under extremely high electrical voltage. Do not touch. Have bulbs replaced by a workshop.

Fog lights

Have bulbs replaced by a workshop.

Tail lights

Saloon/Hatchback

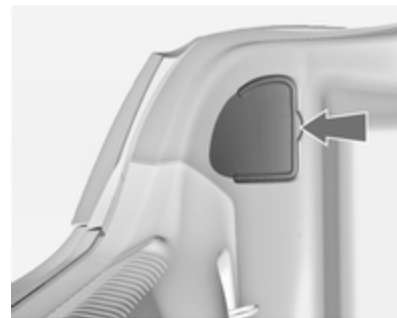

1. Release cover and remove.



2. Unscrew two plastic securing nuts from the inside by hand.

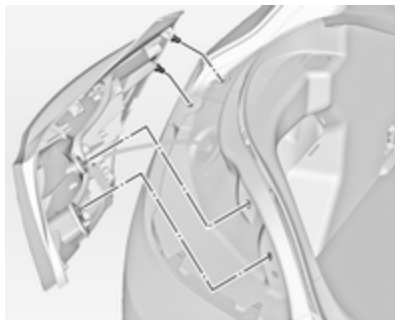

3. Remove tail light assembly. Take care that the cable duct remains in position.

Detach wiring plug from bulb holder.

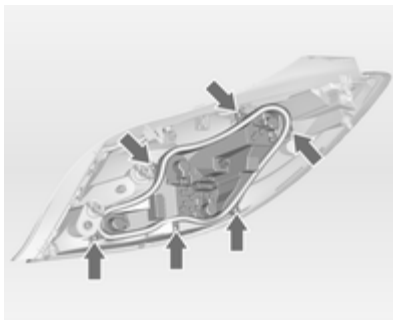

4. Unscrew the screws and remove bulb holder.

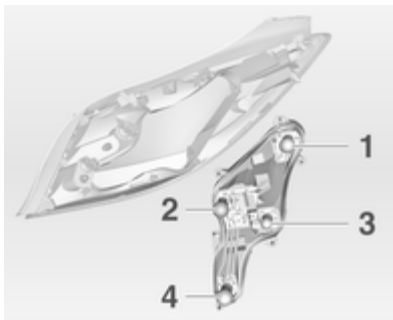

5. Push bulb into socket slightly, rotate anti-clockwise, remove and renew bulb.

Tail light/brake light (1)

Turn signal light (2)

Tail light (3)

Reverse light / Rear fog light, may be only on one side (4)

6. Insert bulb holder into the tail light assembly and screw into place. Connect wiring plug. Install tail light assembly in body and tighten securing nuts. Close cover and engage.
7. Switch on ignition, operate and check all lights.

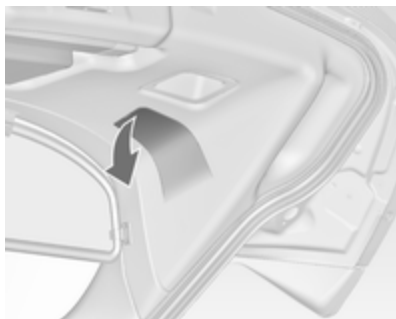
Estate

1. Release and open the cover in the tailgate.



2. Unscrew three plastic securing nuts by hand.



3. Remove tail light assembly. Take care that the cable duct remains in position.
Detach wiring plug from bulb holder.

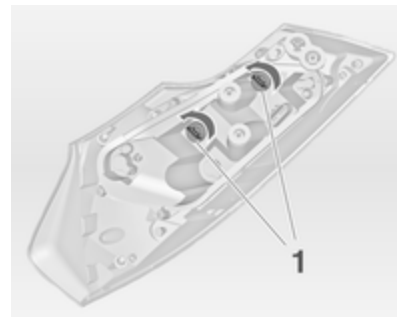

4. To change only the tail light (1), rotate plastic nut anticlockwise and remove it from the bulb holder.

Push bulb into socket slightly, rotate anti-clockwise, remove and renew bulb. Insert plastic nut into bulb holder and rotate clockwise.

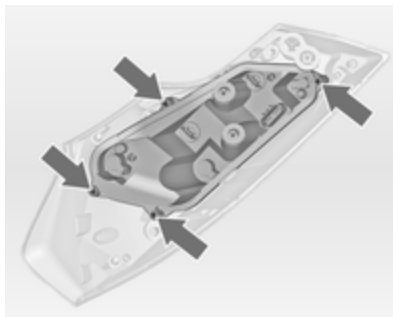

5. To change the other lights, unscrew the screws and remove bulb holder.

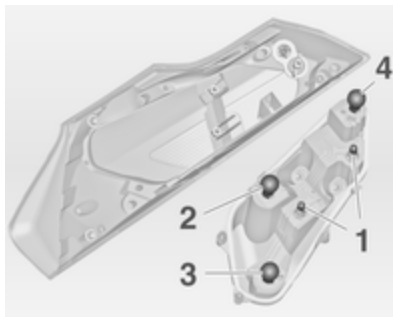

6. Push bulb into socket slightly, rotate anti-clockwise, remove and renew bulb.

Tail light (1)

Turn signal light (2)

Brake light (3)

Reverse light / Rear fog light, may be only on one side (4)

7. Insert bulb holder into the tail light assembly and screw into place. Connect wiring plug. Install tail light assembly in tailgate and tighten securing nuts. Close cover and engage.

8. Switch on ignition, operate and check all lights.

Additional tail lights in the tailgate frame

1. Open tailgate.



2. Release cover in side trim panel and remove.

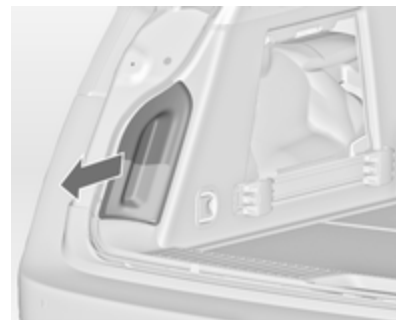

3. Press out lamp housing from the inside of the side trim panel.

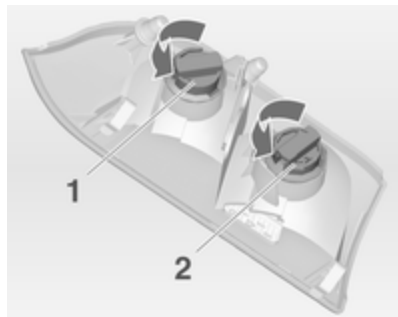

4. Rotate plastic nut anticlockwise and remove from the bulb holder.
5. Push bulb into socket slightly, rotate anti-clockwise, remove and renew bulb. Insert plastic nut into bulb holder by rotating clockwise.

Tail light (1)

Turn signal light (2)

6. Insert bulb holder into the tailgate frame. Close cover in the side trim panel.

Side turn signal lights

Have bulbs replaced by a workshop.

Number plate light

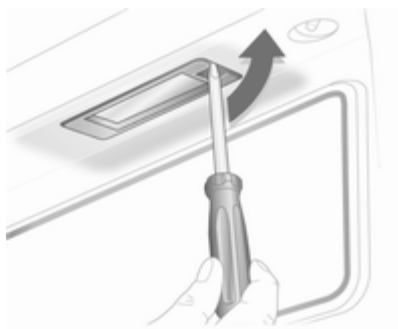

1. Insert screwdriver in bulb housing, press to the side and release spring.

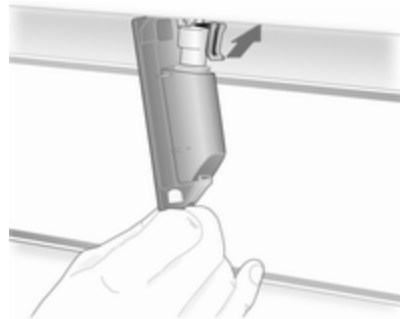

2. Remove bulb housing downwards, taking care not to pull on the cable.
3. Lift flap and disconnect wiring plug from bulb holder.

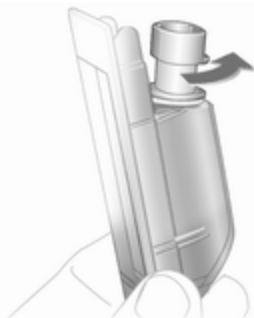

4. Rotate bulb holder anti-clockwise to disengage.
5. Remove bulb from holder and renew bulb.
6. Insert bulb holder in bulb housing and rotate clockwise.
7. Connect wiring plug to bulb holder.
8. Insert and engage bulb housing.

Interior lights

Courtesy light, reading lights

Have bulbs replaced by a workshop.

Load compartment light



1. Prise the lamp out with a screwdriver.



2. Press bulb slightly towards spring clip and remove.
3. Insert new bulb.
4. Install lamp.

Instrument panel illumination

Have bulbs replaced by a workshop.

Electrical system

Fuses

Data on the replacement fuse must match the data on the defective fuse.

There are three fuse boxes in the vehicle:

- in the front left of the engine compartment,
- in the interior behind the storage compartment, or, in right-hand drive vehicles, behind the glovebox,
- behind a cover on the left side of the load compartment.

Before replacing a fuse, turn off the respective switch and the ignition.

A blown fuse can be recognized by its melted wire. Do not replace the fuse until the cause of the fault has been remedied.

Some functions are protected by several fuses.

Fuses may also be inserted without existence of a function.

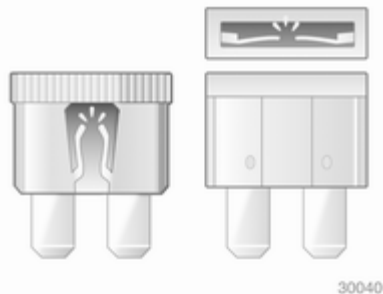

Fuse extractor

A fuse extractor may be located in the fuse box in the engine compartment.

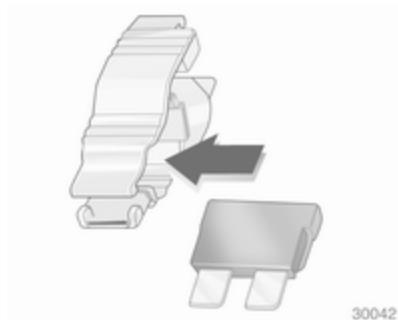
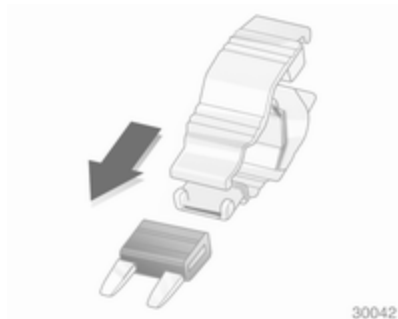



30044

Place the fuse extractor on the various types of fuse from the top or side, and withdraw fuse.

Engine compartment fuse box

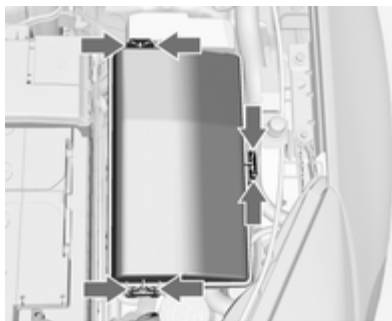

The fuse box is in the front left of the engine compartment.

Disengage the cover, lift it upwards and remove.



No. Circuit

- 1 Transmission control module
- 2 Engine control module
- 3 –
- 4 –
- 5 Ignition, Transmission control module, Engine control module
- 6 Windscreen wiper
- 7 –
- 8 Fuel injection, ignition system
- 9 Fuel injection, ignition system
- 10 Engine control module
- 11 Lambda probe
- 12 Starter
- 13 Sensor throttle heating
- 14 Lighting
- 15 Rear window wiper

No. Circuit

- 16 Vacuum pump, compass module
- 17 Ignition, Airbag
- 18 Adaptive forward lighting
- 19 Adaptive forward lighting
- 20 Ignition
- 21 Rear power windows
- 22 ABS
- 23 Variable effort steering
- 24 Front power windows
- 25 Power outlets
- 26 ABS
- 27 Electrical parking brake
- 28 Heated rear window
- 29 Left power seat
- 30 Right power seat
- 31 Air conditioning system

No. Circuit

- 32 Body control module
- 33 Heated front seats
- 34 Sunroof
- 35 Infotainment system
- 36 –
- 37 Right high beam
- 38 Left high beam
- 39 –
- 40 After boil pump
- 41 Vacuum pump
- 42 Radiator fan
- 43 –
- 44 Headlamp washer system
- 45 Radiator fan
- 46 Terminal 87, main relay
- 47 Lambda probe
- 48 Fog lights

No. Circuit

- 49 Right low beam
- 50 Left low beam
- 51 Horn
- 52 Ignition
- 53 Ignition, ventilated front seats
- 54 Ignition
- 55 Power windows, mirror folding
- 56 Windscreen washer
- 57 Ignition
- 58 –
- 59 Diesel fuel heating
- 60 Mirror heating
- 61 Mirror heating
- 62 Canister Vent Solenoid
- 63 Rear window sensor
- 64 Adaptive forward lighting
- 65 Horn

No. Circuit

- 66 Rear window washer system
- 67 Fuel system control module
- 68 –
- 69 Battery sensor
- 70 Rain sensor
- 71 Body electronic supply

After changing of defective fuses close the fuse box cover and press until it engages.

If the fuse box cover is not closed correctly, malfunctions may occur.

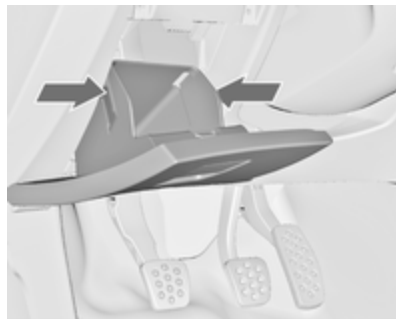
Instrument panel fuse box

The fuse box is behind the storage compartment in the instrument panel.

Open compartment, compress the locking tabs, fold compartment down and remove.

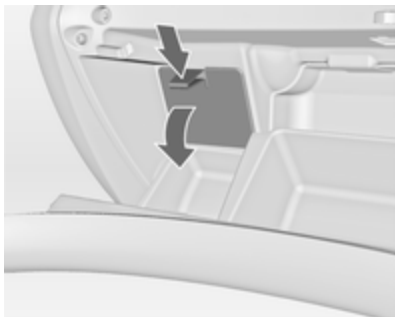

In right-hand drive vehicles, the fuse box is located behind a cover in the glovebox. Open the glovebox and remove the cover.



No. Circuit

- | No. | Circuit |
|-----|-----------------------------------|
| 1 | Infotainment system, info display |
| 2 | Body control unit |
| 3 | Body control unit |
| 4 | Infotainment system, info display |
| 5 | Infotainment system, info display |
| 6 | Cigarette lighter |
| 7 | Power outlet |

No. Circuit

- | | |
|----|-----------------------------------|
| 8 | Body control unit |
| 9 | Body control unit |
| 10 | Body control unit |
| 11 | Interior fan |
| 12 | Power seats |
| 13 | Power seats |
| 14 | Diagnostic connector |
| 15 | Airbag |
| 16 | Central locking system, tailgate |
| 17 | Air conditioning system |
| 18 | Transportation fuse |
| 19 | Memory |
| 20 | Automatic occupant sensing system |
| 21 | Instrument |
| 22 | Ignition |
| 23 | Body control unit |

No. Circuit

- 24 Body control unit
- 25 Ignition switch
- 26 Load compartment power outlet

Power seats, pos. 12 and 13, have an overload protection. The circuit will be closed again after cooling down.

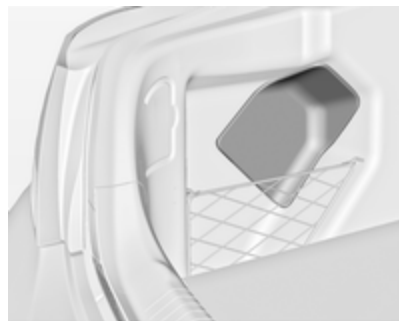
Load compartment fuse box

The fuse box is on the left side of the load compartment behind a cover. Remove the cover.

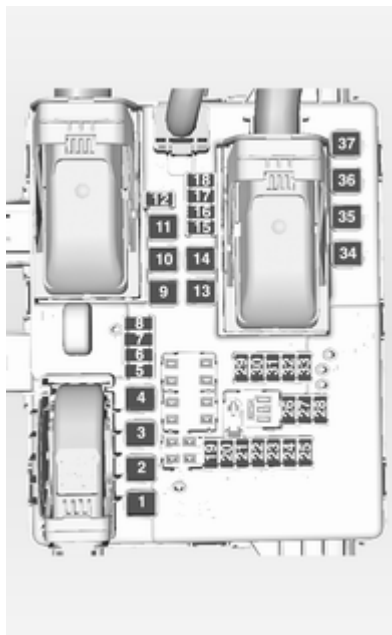
**No. Circuit**

- 1 Central locking system, power tailgate
- 2 Air conditioning system
- 3 Trailer module
- 4 –
- 5 Trailer socket
- 6 –
- 7 –
- 8 Trailer outlet
- 9 –
- 10 Coolant heater
- 11 Power seats
- 12 Memory seat
- 13 Level control system
- 14 –
- 15 –
- 16 –

No. Circuit

- 17 Seat heating
- 18 Power tailgate lock
- 19 Sunshade switch
- 20 Cooling fan driver seat
- 21 Ignition
- 22 Sunshade
- 23 Anti-theft alarm system
- 24 Sidelight left
- 25 Sidelight right
- 26 Lighting, cornering light
- 27 Lighting, cornering light
- 28 –
- 29 Transportation fuse
- 30 Transportation fuse
- 31 Active damping system, high beam assist, cruise control, traffic sign assistant, lane departure warning

No. Circuit

- 32 Side obstacle detector
- 33 All-wheel drive
- 34 Sunroof
- 35 Central locking system
- 36 Power seats
- 37 –

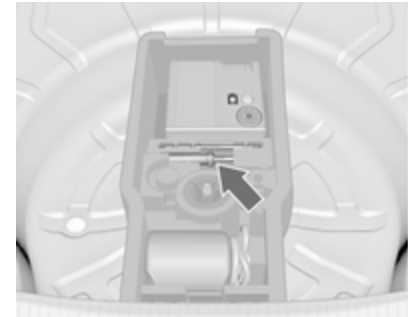
Vehicle tools**Tools****Vehicles with tyre repair kit**

The vehicle tools and tyre repair kit are in a storage compartment below the floor cover in the load compartment.

Vehicles with spare wheel

The jack and vehicle tools are in a stowage compartment in the load compartment below the spare wheel. Spare wheel ↪ 187.

Wheels and tyres

Tyre condition, wheel condition

Drive over edges slowly and at right angles if possible. Driving over sharp edges can cause tyre and wheel damage. Do not trap tyres on the kerb when parking.

Regularly check the wheels for damage. Seek the assistance of a workshop in the event of damage or unusual wear.

Tyres

Tyres of size:

205/60 R 16, 215/55 R 17,
225/50 R 17, 225/45 R 18 and
235/45 R 18 are only to be used as
winter tyres.

Winter tyres

Winter tyres improve driving safety at temperatures below 7 °C and should therefore be fitted on all wheels.

Tyres of size 245/45 R 18, 245/40 R 19¹⁾ and 245/35 R 20 must not be used as winter tyres.

In accordance with country-specific regulations, affix the speed sticker in the driver's field of view.

Tyre designations

E.g. **215/60 R 16 95 H**

- 215** = Tyre width, mm
- 60** = Cross-section ratio (tyre height to tyre width), %
- R** = Belt type: Radial
- RF** = Type: RunFlat
- 16** = Wheel diameter, inches
- 95** = Load index e.g. 95 is equivalent to 690 kg
- H** = Speed code letter

Speed code letter:

- Q** = up to 100 mph (160 km/h)
- S** = up to 112 mph (180 km/h)
- T** = up to 118 mph (190 km/h)
- H** = up to 130 mph (210 km/h)
- V** = up to 150 mph (240 km/h)
- W** = up to 168 mph (270 km/h)

Tyre pressure

Check the pressure of cold tyres at least every 14 days and before any long journey. Do not forget the spare wheel. This also applies to vehicles with tyre pressure monitoring system.

Unscrew the valve cap.

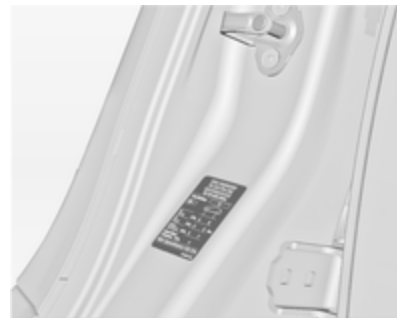

Tyre pressure ⇨ 216 and on the label on the front left door frame.

The tyre pressure data refers to cold tyres. It applies to summer and winter tyres.

¹⁾ Insignia OPC: Permitted as winter tyres without tyre chains.

Always inflate the spare tyre to the pressure specified for full load.

The ECO tyre pressure serves to achieve the smallest amount of fuel consumption possible.

Incorrect tyre pressures will impair safety, vehicle handling, comfort and fuel economy and will increase tyre wear.

Warning

If the pressure is too low, this can result in considerable tyre warm-up and internal damage, leading to tread separation and even to tyre blow-out at high speeds.

If the tyre pressure must be reduced or increased on a vehicle with tyre pressure monitoring system, switch off ignition.

Tyre pressure monitoring system

The tyre pressure monitoring system checks the pressure of all four wheels once a minute when vehicle speed exceeds a certain limit.

All wheels must be equipped with pressure sensors and the tyres must have the prescribed pressure.

The current tyre pressures can be shown in the **Vehicle Information Menu** in the Driver Information Center.

The menu can be selected by the buttons on the turn signal lever.

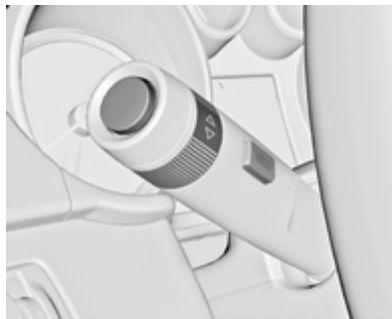

Press the **MENU** button to select the **Vehicle Information Menu**.

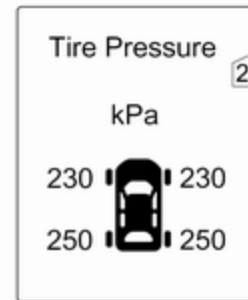

Turn the adjuster wheel to select the tyre pressure monitoring system.

System status and small pressure differences are displayed by a warning message with the corresponding tyre flashing in the Driver Information Center.

Furthermore considerable pressure differences between the tyres on one axle are displayed by a warning message in the Driver Information Center.

Major pressure differences are indicated additionally by the control indicator (U).

Control indicator (U) ⇨ 88.

Vehicle messages ⇨ 94.

If the tyre pressure shall be reduced or increased, switch off ignition.

If a complete set of wheels without sensors is mounted (e.g. four winter tyres), a message is displayed in the Driver Information Center. The tyre pressure monitoring system is not operational. Retrofitting of sensors is possible.

A spare wheel or temporary spare wheel is not equipped with pressure sensors. The tyre pressure monitoring system is not operational for these wheels. Control indicator (U) illuminates. For the further three wheels the system remains operational.

The use of commercially available liquid tyre repair kits can impair the function of the system. Factory approved repair kits can be used.

External high-power radio equipment could disrupt the tyre pressure monitoring system.

The tyre pressure monitoring system valve cores and sealing rings must be replaced each time the tyres are changed.

Adaptive threshold function

The tyre pressure monitoring system automatically detects if the vehicle is driven with a tyre pressure appropriate for a load of up to 3 people or for a full load.

If the tyre pressure shall be reduced, switch off ignition before reducing.

Auto learn function

After changing wheels the vehicle has to be stationary for approx. 20 minutes, before the system recalculates. The following relearn process takes up to 10 minutes of driving with a speed of minimum 12 mph. In this case -- can be displayed or pressure values can swap in the Driver Information Center.

If problems occur during the relearn process a warning message is displayed in the Driver Information Center.

Temperature compensation

Cold tyres decrease the tyre pressure, warm tyres increase the tyre pressure. The tyre pressure monitoring system considers this effect for the warning messages.

The tyre pressure value displayed in the Driver Information Center shows the actual tyre pressure. Therefore it is important to check tyre pressure with cold tyres.

Tread depth

Check tread depth at regular intervals.

Tyres should be replaced for safety reasons at a tread depth of 2-3 mm (4 mm for winter tyres).



The legally permissible minimum tread depth (1.6 mm) has been reached when the tread has worn down as far as one of the tread wear indicators (TWI). Their position is indicated by markings on the sidewall.

If there is more wear at the front than the rear, swap round front wheels and rear wheels. Ensure that the direction of rotation of the wheels is the same as before.

Tyres age, even if they are not used. We recommend tyre replacement every 6 years.

Changing tyre and wheel size

If tyres of a different size than those fitted at the factory are used, it may be necessary to reprogramme the speedometer as well as the nominal tyre pressure and make other vehicle modifications.

After converting to a different tyre size, have the label with tyre pressures replaced.

⚠ Warning

Use of unsuitable tyres or wheels may lead to accidents and will invalidate the vehicle type approval.

Wheel covers

Wheel covers and tyres that are factory approved for the respective vehicle and comply with all of the relevant wheel and tyre combination requirements must be used.

If the wheel covers and tyres used are not factory approved, the tyres must not have a rim protection ridge.

Wheel covers must not impair brake cooling.

⚠ Warning

Use of unsuitable tyres or wheel covers could lead to sudden pressure loss and thereby accidents.

Wheel caps

Tyres of size 245/35 R20 have a specific wheel cap. To remove the cap from the dismantled wheel first disengage the arms one by one. Then press the cap in the middle area from behind and remove it.

To assemble first adjust the wheel cap in order that the positioning leg fits into the recess.

Tyre chains

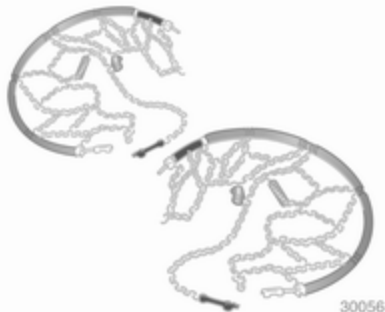

Tyre chains are only permitted on the front wheels.

Always use fine mesh chains that add no more than 10 mm to the tyre tread and the inboard sides (including chain lock).

⚠ Warning

Damage may lead to tyre blowout.

Tyre chains are not permitted on tyres of size 225/55 R 17, 245/45 R 18, 245/40 R 19, 245/35 R 20 and 255/35 R 20.

The use of tyre chains is not permitted on the temporary spare wheel.

Tyre repair kit

Minor damage to the tyre tread or sidewall can be repaired with the tyre repair kit.

Do not remove foreign bodies from the tyres.

Tyre damage exceeding 4 mm or that is at tyre's side wall near the rim cannot be repaired with the tyre repair kit.

⚠ Warning

Do not drive faster than 50 mph.
Do not use for a lengthy period.
Steering and handling may be affected.

If you have a flat tyre:

Apply the parking brake and engage first gear, reverse gear or **P**.

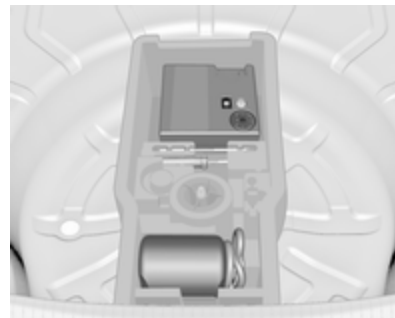

The tyre repair kit is in a compartment under the floor cover in the load compartment.

1. Take the tyre repair kit from the compartment.
2. Remove the compressor.



30057

3. Remove the electrical connection cable and air hose from the stowage compartments on the underside of the compressor.



30058

4. Screw the compressor air hose to the connection on the sealant bottle.
5. Fit the sealant bottle into the retainer on the compressor.
- Set the compressor near the tyre in such a way that the sealant bottle is upright.

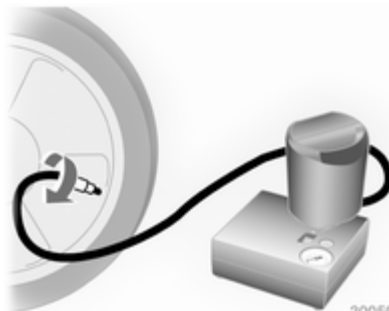

30059

6. Unscrew valve cap from defective tyre.
7. Screw the filler hose to the tyre valve.
8. The switch on the compressor must be set to O.

9. Connect the compressor plug to the power outlet or cigarette lighter socket.
- To avoid discharging the battery, we recommend running the engine.

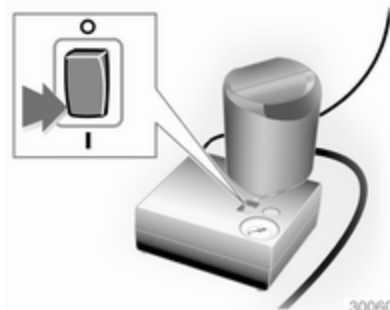

30060

10. Set the rocker switch on the compressor to I. The tyre is filled with sealant.
11. The compressor pressure gauge briefly indicates up to 6 bar whilst the sealant bottle is emptying (approx. 30 seconds). Then the pressure starts to drop.

12. All of the sealant is pumped into the tyre. Then the tyre is inflated.
13. The prescribed tyre pressure should be obtained within 10 minutes. Tyre pressure ↗ 216. When the correct pressure is obtained, switch off the compressor.

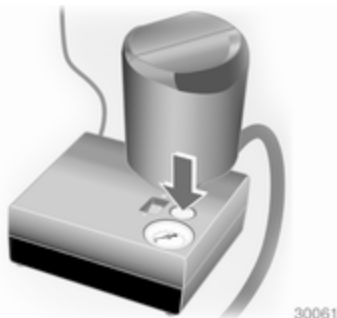

If the prescribed tyre pressure is not obtained within 10 minutes, remove the tyre repair kit. Move the vehicle one tyre rotation. Reattach the tyre repair kit and continue the filling procedure for 10 minutes. If the prescribed tyre pressure is still not obtained, the

tyre is too badly damaged. Seek the assistance of a workshop.

Drain excess tyre pressure with the button over the pressure indicator.

Do not run the compressor longer than 10 minutes.

14. Detach the tyre repair kit. Push catch on bracket to remove sealant bottle from bracket. Screw tyre inflation hose to the free connection of sealant bottle. This prevents sealant from escaping. Stow tyre repair kit in load compartment.
15. Remove any excess sealant using a cloth.
16. Take the label indicating maximum permitted speed from the sealant bottle and affix in the driver's field of view.
17. Continue driving immediately so that sealant is evenly distributed in the tyre. After driving approx. 6 miles (but no more than 10 minutes), stop and check tyre pressure. Screw compressor air

hose directly onto tyre valve and compressor when doing this.

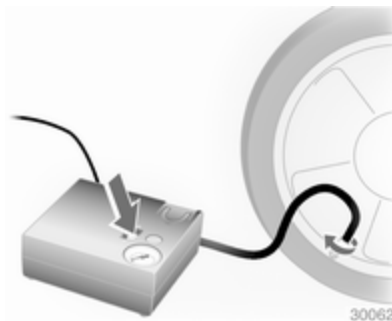

If tyre pressure is more than 1.3 bar, set it to the correct value. Repeat the procedure until there is no more loss of pressure.

If the tyre pressure has fallen below 1.3 bar, the vehicle must not be used. Seek the assistance of a workshop.

18. Stow away tyre repair kit in load compartment.

Notice

The driving characteristics of the repaired tyre is severely affected, therefore have this tyre replaced.

If unusual noise is heard or the compressor becomes hot, turn compressor off for at least 30 minutes.

The built-in safety valve opens at a pressure of 7 bar.

Note the expiry date of the kit. After this date its sealing capability is no longer guaranteed. Pay attention to storage information on sealant bottle.

Replace the used sealant bottle. Dispose of the bottle as prescribed by applicable laws.

The compressor and sealant can be used from approx. -30 °C.

The adapters supplied can be used to pump up other items e.g. footballs, air mattresses, inflatable dinghies etc. They are located on the underside of the compressor. To remove, screw on compressor air hose and withdraw adapter.

Wheel changing

Some vehicles are equipped with a tyre repair kit instead of a spare wheel ⇨ 182.

Make the following preparations and observe the following information:

- Park the vehicle on a level, firm and non-skid surface. The front wheels must be in the straight-ahead position.
- Apply the parking brake and engage first gear, reverse gear or **P**.
- Remove the spare wheel ⇨ 187.
- Never change more than one wheel at once.
- Use the jack only to change wheels in case of puncture, not for seasonal winter or summer tyre change.
- If the ground on which the vehicle is standing is soft, a solid board (max. 0.4 inches thick) should be placed under the jack.
- No people or animals may be in the vehicle when it is jacked-up.

- Never crawl under a jacked-up vehicle.
- Do not start the vehicle when it is raised on the jack.
- Clean wheel nuts and thread before mounting the wheel.



1. Disengage wheel nut caps with a screwdriver and remove. Pull off the wheel cover with the hook. Vehicle tools ⇨ 177.

Alloy wheels: Disengage wheel nut caps with a screwdriver and remove. To protect the wheel, place a soft cloth between the screwdriver and the alloy wheel.

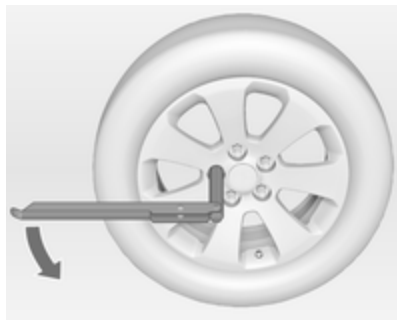

2. Fold out the wheel wrench and install ensuring that it locates securely and loosen each wheel nut by half a turn.

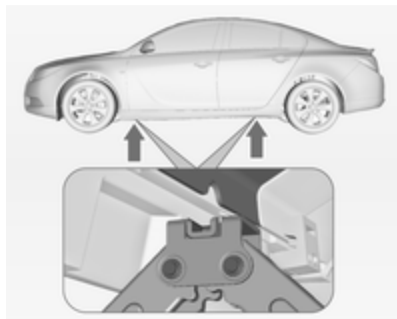

3. Ensure the jack is positioned correctly with the vehicle jacking points.

Lifting the vehicle onto a lifting platform:

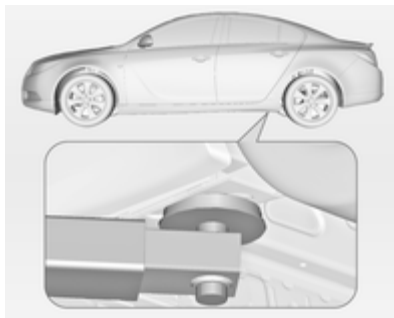

Position the rear arm of the lifting platform at the underbody.

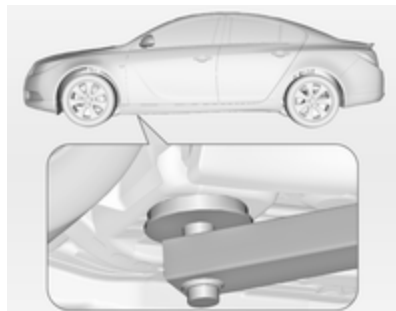

Position the front arm of the lifting platform at the underbody.

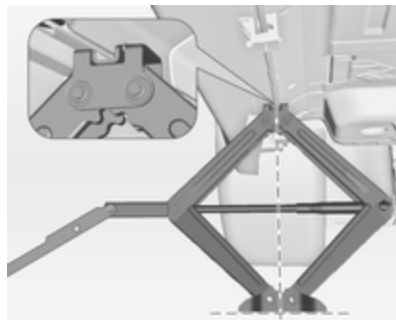



4. Set the jack to the necessary height. Position it directly below the jacking point in a manner that prevents it from slipping.
5. Unscrew the wheel nuts.
6. Change the wheel.
7. Screw on the wheel nuts.
8. Lower vehicle.
9. Install the wheel wrench ensuring that it locates securely and tighten each nut in a crosswise sequence. Tightening torque is 150 Nm.

10. Align the valve hole in the wheel cover with the tyre valve before installing.

Install wheel nut caps.

11. Stow the replaced wheel ↻ 182 and the vehicle tools ↻ 177.
12. Check the tyre pressure of the installed tyre and also the wheel nut torque as soon as possible.

Have the defective tyre renewed or repaired.

Spare wheel

Some vehicles are equipped with a tyre repair kit instead of a spare wheel.

The spare wheel can be classified as a temporary spare wheel depending on the size compared to the other mounted wheels and country regulations.

The spare wheel has a steel rim.

Use of a spare wheel that is smaller than the other wheels or together with winter tyres could affect driveability. Have the defective tyre replaced as soon as possible.



The spare wheel is located in the load compartment beneath the floor covering. It is secured with a wing nut.

The spare wheel well is not designed for all permitted tyre sizes. If a wheel wider than the spare must be stowed in the spare wheel well after changing wheels, the floor cover can be placed on the projecting wheel.

Temporary spare wheel

Use of the temporary spare wheel could affect driveability. Have the defective tyre renewed or repaired as soon as possible.

Only mount one temporary spare wheel. Do not drive faster than 50 mph. Take curves slowly. Do not use for a long period of time.

Tyre chains ⇨ 182.

Directional tyres

Fit directional tyres such that they roll in the direction of travel. The rolling direction is indicated by a symbol (e.g. an arrow) on the sidewall.

The following applies to tyres fitted opposing the rolling direction:

- Driveability may be affected. Have the defective tyre renewed or repaired as soon as possible.
- Do not drive faster than 50 mph.
- Drive particularly carefully on wet and snow-covered road surfaces.

Jump starting

Do not start with quick charger.

A vehicle with a discharged battery can be started using jump leads and the battery of another vehicle.

Warning

Be extremely careful when starting with jump leads. Any deviation from the following instructions can lead to injuries or damage caused by battery explosion or damage to the electrical systems of both vehicles.

Warning

Avoid contact of the battery with eyes, skin, fabrics and painted surfaces. The fluid contains sulphuric acid which can cause injuries and damage in the event of direct contact.

- Never expose the battery to naked flames or sparks.

- A discharged battery can already freeze at a temperature of 0 °C. Defrost the frozen battery before connecting jump leads.
- Wear eye protection and protective clothing when handling a battery.
- Use a booster battery with the same voltage (12 Volts). Its capacity (Ah) must not be much less than that of the discharged battery.
- Use jump leads with insulated terminals and a cross section of at least 16 mm² (25 mm² for diesel engines).
- Do not disconnect the discharged battery from the vehicle.
- Switch off all unnecessary electrical consumers.
- Do not lean over the battery during jump starting.
- Do not allow the terminals of one lead to touch those of the other lead.

- The vehicles must not come into contact with each other during the jump starting process.
- Apply the parking brake, transmission in neutral, automatic transmission in **P**.

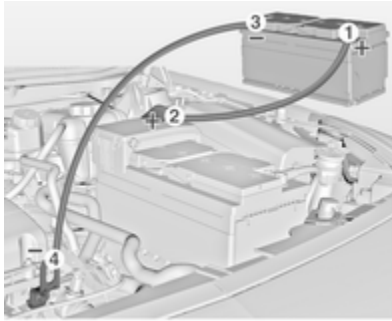

Lead connection order:

1. Connect the red lead to the positive terminal of the booster battery.
2. Connect the other end of the red lead to the positive terminal of the discharged battery.
3. Connect the black lead to the negative terminal of the booster battery.
4. Connect the other end of the black lead to a vehicle grounding point, such as the engine block or an engine mounting bolt. Connect as far away from the discharged battery as possible, however at least 2 ft.

Route the leads so that they cannot catch on rotating parts in the engine compartment.

To start the engine:

1. Start the engine of the vehicle providing the jump.
2. After 5 minutes, start the other engine. Start attempts should be made for no longer than 15 seconds at an interval of 1 minute.
3. Allow both engines to idle for approx. 3 minutes with the leads connected.
4. Switch on electrical consumers (e.g. headlights, heated rear window) of the vehicle receiving the jump start.
5. Reverse above sequence exactly when removing leads.

Towing

Towing the vehicle



Disengage cap at bottom and remove downwards.



Insignia VXR: Insert screwdriver in the slot at the upper bend of the cap. Release the cap by carefully moving the screwdriver downwards. To prevent damage it is recommended to place a cloth between the screwdriver and the frame.

The towing eye is stowed with the vehicle tools ↗ 177.



Screw in the towing eye as far as it will go until it stops in a horizontal position.

Attach a tow rope – or better still a tow rod – to the towing eye.

The towing eye must only be used for towing and not for recovering the vehicle.

Switch on ignition to release steering wheel lock and to permit operation of brake lights, horn and windscreen wiper.

Transmission in neutral.

Caution

Drive slowly. Do not drive jerkily. Excessive tractive force can damage the vehicle.

When the engine is not running, considerably more force is needed to brake and steer.

To prevent the entry of exhaust gases from the towing vehicle, switch on the air recirculation and close the windows.

Vehicles with manual transmission and All-wheel drive: If the vehicle is towed with all four wheels on the ground then there are no technical limitations for speed and distance. If only one axle has been raised, the maximum speed is 30 mph. There is no distance limitation.

Vehicles with automatic transmission and Front-wheel drive: The vehicle must be towed facing forwards, not faster than 50 mph nor further than 60 miles. In all other cases and when the transmission is defective, the front axle must be raised off the ground.

Vehicles with automatic transmission and All-wheel drive: The vehicle must be towed facing forwards. If the vehicle is towed with all four wheels on the ground, the maximum speed is 30 mph and for a maximum of 30 miles. If the front axle has been raised, the maximum speed is 30 mph. There is no distance limitation.

Seek the assistance of a workshop. After towing, unscrew the towing eye.

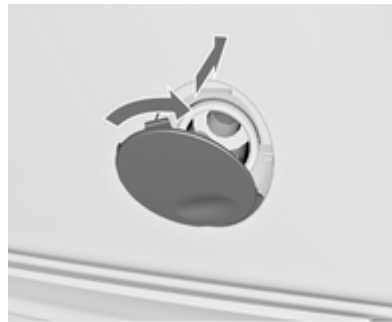

Insert cap at the bottom, turn slightly clockwise and close cap.

Insignia VXR: Insert cap with the lower flange into the recess. Press the cap into the bumper.

Towing another vehicle



Disengage cap at bottom and remove downwards.

The towing eye is stowed with the vehicle tools ⇨ 177.



Screw in the towing eye as far as it will go until it stops in a horizontal position.

The lashing eye at the rear underneath the vehicle must never be used as a towing eye.

Attach a tow rope – or better still a tow rod – to the towing eye.

The towing eye must only be used for towing and not for recovering a vehicle.

Caution

Drive slowly. Do not drive jerkily. Excessive tractive force can damage the vehicle.

After towing, unscrew the towing eye.

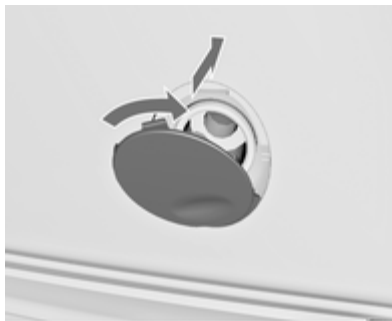

Insert cap at the bottom, turn slightly clockwise and engage cap.

Appearance care

Exterior care

Locks

The locks are lubricated at the factory using a high quality lock cylinder grease. Use de-icing agent only when absolutely necessary, as this has a degreasing effect and impairs lock function. After using de-icing agent, have the locks regreased by a workshop.

Washing

The paintwork of your vehicle is exposed to environmental influences. Wash and wax your vehicle regularly. When using automatic vehicle washes, select a programme that includes waxing.

Bird droppings, dead insects, resin, pollen and the like should be cleaned off immediately, as they contain aggressive constituents which can cause paint damage.

If using a vehicle wash, comply with the vehicle wash manufacturer's instructions. The windscreen wipers

and rear window wiper must be switched off. Remove antenna and external accessories such as roof racks etc.

If you wash your vehicle by hand, make sure that the insides of the wheel housings are also thoroughly rinsed out.

Clean edges and folds on opened doors and the bonnet as well as the areas they cover.

Have the door hinges of all doors greased by a workshop.

Do not clean the engine compartment with a steam-jet or high-pressure jet cleaner.

Thoroughly rinse and leather-off the vehicle. Rinse leather frequently. Use separate leathers for painted and glass surfaces: remnants of wax on the windows will impair vision.

Exterior lights

Headlight and other light covers are made of plastic. Do not use any abrasive or caustic agents, do not use an ice scraper, and do not clean them dry.

Polishing and waxing

Wax the vehicle regularly (at the latest when water no longer beads). Otherwise, the paintwork will dry out.

Polishing is necessary only if the paint has become dull or if solid deposits have become attached to it.

Paintwork polish with silicone forms a protective film, making waxing unnecessary.

Plastic body parts must not be treated with wax or polishing agents.

Windows and windscreen wiper blades

Use a soft lint-free cloth or chamois leather together with window cleaner and insect remover.

When cleaning the rear window, make sure the heating element inside is not damaged.

For mechanical removal of ice, use a sharp-edged ice scraper. Press the scraper firmly against the glass so that no dirt can get under it and scratch the glass.

Clean smearing wiper blades with a soft cloth and window cleaner.

Sunroof

Never clean with solvents or abrasive agents, fuels, aggressive media (e.g. paint cleaner, acetone-containing solutions etc.), acidic or highly alkaline media or abrasive pads. Do not apply wax or polishing agents to the sunroof.

Wheels and tyres

Do not use high-pressure jet cleaners.

Clean rims with a pH-neutral wheel cleaner.

Rims are painted and can be treated with the same agents as the body.

Paintwork damage

Rectify minor paintwork damage with a touch-up pen before rust forms. Have more extensive damage or rust areas repaired by a workshop.

Underbody

Some areas of the vehicle underbody have a PVC undercoating while other critical areas have a durable protective wax coating.

After the underbody is washed, check the underbody and have it waxed if necessary.

Bitumen/rubber materials could damage the PVC coating. Have underbody work carried out by a workshop.

Before and after winter, wash the underbody and have the protective wax coating checked.

Towing equipment

Do not clean the coupling ball bar with a steam-jet or high-pressure jet cleaner.

Interior care

Interior and upholstery

Only clean the vehicle interior, including the instrument panel fascia and panelling, with a dry cloth or interior cleaner.

The instrument panel should only be cleaned using a soft damp cloth.

Clean fabric upholstery with a vacuum cleaner and brush. Remove stains with an upholstery cleaner.

Clean seat belts with lukewarm water or interior cleaner.

Caution
Close Velcro fasteners as open Velcro fasteners on clothing could damage seat upholstery. The same applies to clothing with sharp-edged objects, like zips or belts or studded jeans.

Plastic and rubber parts

Plastic and rubber parts can be cleaned with the same cleaner as used to clean the body. Use interior cleaner if necessary. Do not use any other agent. Avoid solvents and petrol in particular. Do not use high-pressure jet cleaners.

Service and maintenance

General information	195
Recommended fluids, lubricants and parts	196

General information

Service information

In order to ensure economical and safe vehicle operation and to maintain the value of your vehicle, it is of vital importance that all maintenance work is carried out at the proper intervals as specified.

The detailed, up-to-date service schedule for your vehicle is available at the workshop.

Service display ⇨ 81.

European service intervals

Maintenance of your vehicle is required every 20,000 miles or after 1 year, whichever occurs first, unless otherwise indicated in the service display.

The european service intervals are valid for the following countries:

Andorra, Austria, Belgium, Bosnia-Herzegovina, Bulgaria, Croatia, Cyprus, Czech Republic, Denmark, Estonia, Finland, France, Germany, Greece, Greenland, Hungary, Iceland, Ireland, Italy, Latvia,

Lithuania, Luxembourg, Macedonia, Malta, Montenegro, Netherlands, Norway, Poland, Portugal, Romania, Serbia, Slovakia, Slovenia, Spain, Sweden, Switzerland, United Kingdom.

Service display ⇨ 81.

International service intervals

Maintenance of your vehicle is required every 10,000 miles or after 1 year, whichever occurs first, unless otherwise indicated in the service display.

The international service intervals are valid for the countries which are not listed at the european service intervals.

Service display ⇨ 81.

Confirmations

Confirmation of service is recorded in the Service and Warranty Booklet. The date and mileage is completed with the stamp and signature of the servicing workshop.

Make sure that the Service and Warranty Booklet is completed correctly as continuous proof of service is essential if any warranty or goodwill claims are to be met, and is also a benefit when selling the vehicle.

Service interval with remaining engine oil life duration

The service interval is based on several parameters depending on usage.

The service display lets you know when to change the engine oil.

Service display ⇨ 81.

Recommended fluids, lubricants and parts

Recommended fluids and lubricants

Only use products that have been tested and approved. Damage resulting from the use of non-approved materials will not be covered by the warranty.

Warning

Operating materials are hazardous and could be poisonous. Handle with care. Pay attention to information given on the containers.

Engine oil

Engine oil is identified by its quality and its viscosity. Quality is more important than viscosity when selecting which engine oil to use. The oil quality ensures e.g. engine cleanliness, wear protection and oil

aging control, whereas viscosity grade gives information on the oil's thickness over a temperature range.

The new engine oil quality Dexos 2™ is the newest oil quality and combines gasoline and diesel performance. If it is unavailable, engine oils of other listed qualities have to be used.

Engine oil quality for European service schedules

Dexos 2™ = All petrol and diesel engines

Alternative qualities if Dexos 2™ is not available:

GM-LL-A-025 = Petrol engines
GM-LL-B-025 = Diesel engines

Engine oil quality for international service schedules

Dexos 2™ = All petrol and diesel engines

Alternative qualities if Dexos 2™ is not available:

GM-LL-A-025 = Petrol engines
GM-LL-B-025 = Diesel engines

Alternative qualities if GM-LL-A-025 or GM-LL-B-025 are not available:

ACEA-A3/B3 or = Petrol engines
A3/B4

ACEA-A3/B4 = Diesel engines
without Diesel
Particle Filter
(DPF)

ACEA-C3 = Diesel engines
with DPF

Engine oil for engine A20DTR

Use exclusively engine oil with the quality Dexos 2™ or GM-LL-B-025 and with the viscosity 0W-40. Use of engine oil with other quality and viscosity is expressly forbidden.

Topping up engine oil

Engine oils of different manufacturers and brands can be mixed as long as they comply with the required engine oil quality and viscosity.

If engine oil of the required quality is not available, a maximum of 1 litre of ACEA C3 grade may be used (only once between each oil change). The viscosity should be of one of the below listed viscosity grades.

Use of engine oil with only ACEA A1/B1 or only A5/B5 quality is explicitly prohibited, since it can cause long-term engine damage under certain operating conditions.

Additional engine oil additives

The use of additional engine oil additives could cause damage and invalidate the warranty.

Engine oil viscosity grades

Use only engine oil viscosity grades SAE 5W-30 or 5W-40, 0W-30 or 0W-40.

The SAE viscosity grade gives information of the thickness of the oil.

Multigrade oil is indicated by two figures. The first figure, followed by a W, indicates the low temperature viscosity and the second figure the high temperature viscosity. Please select the appropriate viscosity grade depending on your minimum ambient temperature.

- down to -25°C:
SAE 5W-30 or SAE 5W-40
- below -25°C:
SAE 0W-30 or SAE 0W-40

Coolant and antifreeze

Use only silicate-free long life coolant (LLC) antifreeze.

The system is factory filled with coolant designed for excellent corrosion protection and frost protection down to approx. -28 °C. This concentration should be maintained all year round. The use of additional coolant additives that intend to give additional corrosion protection or seal against minor leaks can cause function problems. Liability for consequences resulting from the use of additional coolant additives will be rejected.

Brake and clutch fluid

Use only brake fluid which exceeds DOT4 requirements.

Over time, brake fluid absorbs moisture which will reduce braking effectiveness. The brake fluid should therefore be replaced at the specified interval.

Brake fluid should be stored in a sealed container to avoid water absorption.

Ensure brake fluid does not become contaminated.

Technical data

Vehicle identification 199

Vehicle data 201

Vehicle identification

Vehicle Identification Number



The Vehicle Identification Number is visible through the windscreen.

Identification plate



The identification label is located on the front left door frame.



Information on identification plate:

- 1 = Manufacturer
- 2 = Type approval number
- 3 = Vehicle Identification Number
- 4 = Permissible gross vehicle weight rating
- 5 = Permissible gross train weight
- 6 = Maximum permissible front axle load
- 7 = Maximum permissible rear axle load
- 8 = Vehicle-specific or country specific data

The combined total of front and rear axle loads must not exceed the permissible gross vehicle weight. For example, if the front axle is bearing its maximum permissible load, the rear axle can only bear a load that is equal to the gross vehicle weight minus the front axle load.

The technical data is determined in accordance with European Community standards. We reserve the right to make modifications. Specifications in the vehicle documents always have priority over those given in this manual.

Vehicle data

Engine data

Sales designation	1.6	1.6 Turbo	1.8	2.0 Turbo	2.8 V6 Turbo	VXR
Engine identifier code	A16XER	A16LET	A18XER	A20NHT	A28NET	A28NER
Number of cylinders	4	4	4	4	6	6
Piston displacement [cm ³]	1598	1598	1796	1998	2792	2792
Engine power [kW]	85	132	103	162	191	239
at rpm	6000	5500	6300	5300	5500	5250
Torque [Nm]	155	230	175	350	350	435
at rpm	4000	2200-5500	3800	2000-4000	1900-4500	5250
Fuel type	Petrol	Petrol	Petrol	Petrol	Petrol	Petrol
Octane rating RON						
recommended	95	95	95	95	95	98
possible	98	98	98	98	98	95
possible	91	91 ¹⁾	91	91	91	91
Oil consumption [l/1000 km]	0.6	0.6	0.6	0.6	0.6	0.6

¹⁾ Possible only if high engine load, full load or driving in mountainous terrain with a caravan/trailer or high payload is avoided.

202 Technical data

Sales designation	2.0 CDTI	2.0 CDTI	ecoFlex 96kW	2.0 CDTI	ecoFlex 118kW	2.0 CDTI
Engine identifier code	A20DTC	A20DTJ	A20DTH	A20DTH	A20DTH	A20DTR
Number of cylinders	4	4	4	4	4	4
Piston displacement [cm ³]	1956	1956	1956	1956	1956	1956
Engine power [kW]	81	96	96	118	118	140
at rpm	4000	4000	4000	4000	4000	4500
Torque [Nm]	260	300	300	350	350	400
at rpm	1750-2500	1750-2500	1750-2500	1750-2500	1750-2500	2000
Fuel type	Diesel	Diesel	Diesel	Diesel	Diesel	Diesel
Oil consumption [l/1000 km]	0.6	0.6	0.6	0.6	0.6	0.6

Performance

Saloon/Hatchback

Engine	A16XER	A16LET	A18XER	A20NHT	A20NHT AWD ²⁾	A28NET	A28NER
Maximum speed ³⁾ [mph]							
Manual transmission	120	139	129	150	149	155	155
Automatic transmission	–	–	–	149	147	155	–

Engine	A20DTC	A20DTJ	A20DTH ecoFlex 96kW	A20DTH	A20DTH ecoFlex 118kW	A20DTR
Maximum speed ³⁾ [mph]						
Manual transmission	118	127	129	135	137	4)
Automatic transmission	–	127	–	134	–	4)

2) All-wheel drive.

3) The maximum speed indicated is achievable at kerb weight (without driver) plus 200 kg payload. Optional equipment could reduce the specified maximum speed of the vehicle.

4) Value was not available at time of printing.

Station wagon

Engine	A16XER	A16LET	A18XER	A20NHT	A20NHT - AWD ²⁾	A28NET	A28NER
Maximum speed ³⁾ [mph]							
Manual transmission	116	137	126	147	145	155	155
Automatic transmission	–	–	–	145	144	154	–

Engine	A20DTC	A20DTJ	A20DTH ecoFlex 96kW	A20DTH	A20DTH ecoFlex 118kW	A20DTR
Maximum speed ³⁾ [mph]						
Manual transmission	115	124	126	132	134	4)
Automatic transmission	–	123	–	130	–	4)

2) All-wheel drive.

3) The maximum speed indicated is achievable at kerb weight (without driver) plus 200 kg payload. Optional equipment could reduce the specified maximum speed of the vehicle.

4) Value was not available at time of printing.

Estate

Engine	A16XER	A16LET	A18XER	A20NHT	A20NHT - AWD ²⁾	A28NET	A28NER
Maximum speed ³⁾ [mph]							
Manual transmission	116	137	126	147	145	155	155
Automatic transmission	–	–	–	145	144	154	–

Engine	A20DTC	A20DTJ	A20DTH ecoFlex 96kW	A20DTH	A20DTH ecoFlex 118kW	A20DTR
Maximum speed ³⁾ [mph]						
Manual transmission	115	124	126	132	134	4)
Automatic transmission	–	123	–	130	–	4)

Fuel consumption - CO₂-emissions
Saloon/Hatchback

To convert l/100 km into mpg, divide 282 by number of litres/100 km.

2) All-wheel drive.

3) The maximum speed indicated is achievable at kerb weight (without driver) plus 200 kg payload. Optional equipment could reduce the specified maximum speed of the vehicle.

4) Value was not available at time of printing.

Manual transmission / automatic transmission.

Engine	A16XER	A16LET	A18XER	A20NHT	A20NHT AWD ⁵⁾	A28NET	A28NER
urban [l/100 km]	10.3/-	10.6/-	10.5/-	12.8/14.2	13.1/14.4	16.2/16.6	16.6/-
extra-urban [l/100 km]	5.7/-	6.0/-	5.9/-	6.5/6.9	6.9/7.1	7.8/7.7	8.4/-
total [l/100 km]	7.4/-	7.7/-	7.6/-	8.8/9.6	9.2/9.8	10.9/11.0	11.4/-
CO ₂ [g/km]	174/-	179/-	178/-	208/225	215/229	256/258	268/-

Engine	A20DTC	A20DTJ	A20DTH ecoFlex 96kW	A20DTH	A20DTH ecoFlex 118kW	A20DTR
urban [l/100 km]	7.7/-	7.7/9.3	6.8/-	7.7/9.3	6.8/-	⁶⁾
extra-urban [l/100 km]	4.7/-	4.7/5.3	4.2/-	4.7/5.3	4.2/-	⁶⁾
total [l/100 km]	5.8/-	5.8/6.8	5.2/-	5.8/6.8	5.2/-	⁶⁾
CO ₂ [g/km]	154/-	154/179	136/-	154/179	136/-	⁶⁾

⁵⁾ All-wheel drive

⁶⁾ Value was not available at time of printing.

Estate

Manual transmission / automatic transmission.

Engine	A16XER	A16LET	A18XER	A20NHT	A20NHT AWD ⁵⁾	A28NET	A28NER
urban [l/100 km]	10.5/-	10.9/-	10.6/-	12.9/14.3	13.2/14.5	16.7/17.1	17.0/-
extra-urban [l/100 km]	6.1/-	6.2/-	6.2/-	6.6/7.0	7.0/7.2	8.0/7.9	8.6/-
total [l/100 km]	7.7/-	7.9/-	7.8/-	8.9/9.7	9.3/9.9	11.2/11.3	11.7/-
CO ₂ [g/km]	182/-	186/-	183/-	209/228	219/233	263/265	274/-

Engine	A20DTC	A20DTJ	A20DTH ecoFlex 96kW	A20DTH ecoFlex 118kW	A20DTH ecoFlex 118kW	A20DTR
urban [l/100 km]	7.9/-	7.9/9.5	6.9	7.9/9.5	6.9	⁶⁾
extra-urban [l/100 km]	4.9/-	4.9/5.4	4.3	4.9/5.4	4.3	⁶⁾
total [l/100 km]	6.0/-	6.0/6.9	5.3	6.0/6.9	5.3	⁶⁾
CO ₂ [g/km]	159/-	159/182	139	159/182	139	⁶⁾

⁵⁾ All-wheel drive

⁶⁾ Value was not available at time of printing.

Vehicle weight

Kerb weight, basic model without any optional equipment

Insignia Saloon 4-door	Engine	Manual transmission	Automatic transmission
without/with air conditioning [kg]	A16XER, A18XER	1503/-	-
	A16LET	-/1570	-
	A20DTC	-/1613	-
	A20DTH ecoFlex 96kW	1613/-	-
	A20DTH	1613/-	1613/-
	A20DTH ecoFlex 118kW	1613/-	-
	A20DTJ	-/1613	1613/-
	A20DTR	-/1665	-/1690
	A20DTR - All-wheel drive	-/1780	-/1805
	A20NHT	-/1613	-/1655
	A20NHT - All-wheel drive	-/1733	-/1770
	A28NET	-/1810	-/1835
	A28NER	-/1810	-

Kerb weight, basic model without any optional equipment

Insignia Hatchback 5-door	Engine	Manual transmission	Automatic transmission
without/with air conditioning [kg]	A16XER, A18XER	1503/-	-
	A16LET	-/1585	-
	A20DTC	-/1613	-
	A20DTH ecoFlex 96kW	1613/-	-
	A20DTH	1613/-	1655/-
	A20DTH ecoFlex 118kW	1613/-	-
	A20DTJ	-/1613	1655/-
	A20DTR	-/1680	-/1705
	A20DTR - All-wheel drive	-/1795	-/1820
	A20NHT	-/1645	-/1670
	A20NHT - All-wheel drive	-/1733	-/1785
	A28NET	-/1825	-/1843
	A28NER	-/1825	-

Kerb weight, basic model without any optional equipment

Insignia Estate	Engine	Manual transmission	Automatic transmission
without/with air conditioning [kg]	A16XER	-/1610	-
	A16LET	-/1660	-
	A18XER	-/1613	-
	A20DTC	-/1730	-
	A20DTH ecoFlex 96kW	-/1733	-
	A20DTH	-/1733	1733/1743
	A20DTH ecoFlex 118kW	-/1733	-
	A20DTJ	-/1730	-/1733
	A20DTR	-/1733	-/1775
	A20DTR - All-wheel drive	-/1843	-/1900
	A20NHT	-/1725	-/1733
	A20NHT - All-wheel drive	-/1843	-/1843
	A28NET	-/1940	-/1953
	A28NER	-/1940	-

Kerb weight, basic model with all optional equipment

Insignia Saloon 4-door	Engine	Manual transmission	Automatic transmission
without/with air conditioning [kg]	A16XER	-/1672	-
	A16LET	-/1729	-
	A18XER	-/1692	-
	A20DTC	-/1778	-
	A20DTH ecoFlex 96kW	-/1806	-
	A20DTH	-/1806	-/1829
	A20DTH ecoFlex 118kW	-/1806	-
	A20DTJ	-/1793	-/1819
	A20DTR	-/1822	-/1846
	A20DTR - All-wheel drive	-/1938	-/1962
	A20NHT	-/1789	-/1813
	A20NHT - All-wheel drive	-/1905	-/1929
	A28NET	-/1968	-/1992
	A28NER	-/1968	-

Kerb weight, basic model with all optional equipment

Insignia Hatchback 5-door	Engine	Manual transmission	Automatic transmission
without/with air conditioning [kg]	A16XER	-/1687	-
	A16LET	-/1744	-
	A18XER	-/1707	-
	A20DTC	-/1793	-
	A20DTH ecoFlex 96kW	-/1821	-
	A20DTH	-/1821	-/1844
	A20DTH ecoFlex 118kW	-/1821	-
	A20DTJ	-/1808	-/1834
	A20DTR	-/1837	-/1861
	A20DTR - All-wheel drive	-/1953	-/1977
	A20NHT	-/1804	-/1828
	A20NHT - All-wheel drive	-/1920	-/1944
	A28NET	-/1983	-/2007
	A28NER	-/1983	-

Kerb weight, basic model with all optional equipment

Insignia Estate	Engine	Manual transmission	Automatic transmission
without/with air conditioning [kg]	A16XER	-/1784	-
	A16LET	-/1837	-
	A18XER	-/1799	-
	A20DTC	-/1899	-
	A20DTH ecoFlex 96kW	-/1918	-
	A20DTH	-/1918	-/1942
	A20DTH ecoFlex 118kW	-/1918	-
	A20DTJ	-/1908	-/1941
	A20DTR	-/1932	-/1956
	A20DTR - All-wheel drive	-/2053	-/2077
	A20NHT	-/1899	-/1923
	A20NHT - All-wheel drive	-/2021	-/2045
	A28NET - All-wheel drive	-/2074	-/2098
	A28NER	-/2074	-

Vehicle dimensions

	Saloon 4-door	Hatchback 5-door	Estate
Length [mm]	4830	4830	4908
Width without exterior mirrors [mm]	1856	1856	1856
Width with two exterior mirrors [mm]	2084	2084	2084
Height (without antenna) [mm]	1498	1498	1520
Length of load compartment floor [mm]	1003	1003	1086
Length of load compartment with folded rear seats [mm]	1895	1895	1908
Load compartment width [mm]	1027	1027	1030
Load compartment height [mm]	356	436	677
Wheelbase [mm]	2737	2737	2737
Turning circle diameter [m]	11.4	11.4	11.4

Capacities

Engine oil

Engine	A16LET	A18XER	A20NHT	A28NET	A28NER
including filter [l]	4.5	4.5	6.0	6.3	6.3
between MIN and MAX [l]	1.0	1.0	1.0	1.0	1.0

Engine	A20DTC	A20DTJ	A20DTH ecoFlex 96kW	A20DTH	A20DTH ecoFlex 118kW	A20DTR
including filter [l]	4.5	4.5	4.5	4.5	4.5	4.5
between MIN and MAX [l]	1.0	1.0	1.0	1.0	1.0	1.0
Fuel tank						
Petrol/diesel, nominal capacity [l]						70

Tyre pressures

Tyre pressures for vehicles with front-wheel drive

Saloon/Hatchback

Engine	Tyres	Comfort with up to 3 people		ECO with up to 3 people		With full load	
		front	rear	front	rear	front	rear
		[kPa/bar] ([psi])	[kPa/bar] ([psi])	[kPa/bar] ([psi])	[kPa/bar] ([psi])	[kPa/bar] ([psi])	[kPa/bar] ([psi])
A16XER	205/60 R16 ⁷⁾ , 215/60 R16, 215/55 R17 ⁷⁾ , 245/35 R20 ⁸⁾ , 225/50 R17 ⁷⁾⁸⁾ , 245/45 R18, 245/40 R19 ⁸⁾	220/2.2 (32)	200/2.0 (29)	270/2.7 (39)	260/2.6 (38)	220/2.2 (32)	270/2.7 (39)
	225/55 R17	220/2.2 (32)	200/2.0 (29)	300/3.0 (43)	300/3.0 (43)	220/2.2 (32)	270/2.7 (39)

⁷⁾ Only permitted as winter tyres.

⁸⁾ Reinforced variant (XL).

Engine	Tyres	Comfort with up to 3 people		ECO with up to 3 people		With full load	
		front	rear	front	rear	front	rear
		[kPa/bar] ([psi])	[kPa/bar] ([psi])	[kPa/bar] ([psi])	[kPa/bar] ([psi])	[kPa/bar] ([psi])	[kPa/bar] ([psi])
A16 LET	225/50 R17 ⁷⁾ ⁸⁾ , 220/2.2 (32)	200/2.0 (29)	–	–	–	220/2.2 (32)	270/2.7 (39)
	225/45 R18 ⁷⁾ ⁸⁾						
	215/55 R17 ⁷⁾ , 220/2.2 (32)	200/2.0 (29)	270/2.7 (39)	260/2.6 (38)	220/2.2 (32)	270/2.7 (39)	
	235/45 R18 ⁷⁾ ,						
	245/45 R18,						
	245/40 R19 ⁸⁾ ,						
245/35 R20 ⁸⁾							
	225/55 R17	220/2.2 (32)	200/2.0 (29)	300/3.0 (43)	300/3.0 (43)	220/2.2 (32)	270/2.7 (39)

⁷⁾ Only permitted as winter tyres.

⁸⁾ Reinforced variant (XL).

Engine	Tyres	Comfort with up to 3 people		ECO with up to 3 people		With full load	
		front	rear	front	rear	front	rear
		[kPa/bar] ([psi])	[kPa/bar] ([psi])	[kPa/bar] ([psi])	[kPa/bar] ([psi])	[kPa/bar] ([psi])	[kPa/bar] ([psi])
A18XER	205/60 R16 ⁷⁾ , 215/60 R16, 215/55 R17 ⁷⁾ , 245/35 R20 ⁸⁾ 225/50 R17 ⁷⁾⁸⁾ , 225/45 R18 ⁷⁾⁸⁾ , 235/45 R18 ⁷⁾ , 245/45 R18, 245/40 R19 ⁸⁾ 225/55 R17	220/2.2 (32)	200/2.0 (29)	270/2.7 (39)	260/2.6 (38)	220/2.2 (32)	270/2.7 (39)

⁷⁾ Only permitted as winter tyres.

⁸⁾ Reinforced variant (XL).

Engine	Tyres	Comfort with up to 3 people		ECO with up to 3 people		With full load	
		front	rear	front	rear	front	rear
		[kPa/bar] ([psi])	[kPa/bar] ([psi])	[kPa/bar] ([psi])	[kPa/bar] ([psi])	[kPa/bar] ([psi])	[kPa/bar] ([psi])
A20NHT with manual transmission	225/50 R17 ⁷⁾ ⁸⁾ , 240/2.4 (35)	220/2.2 (32)	–	–	–	250/2.5 (36)	300/3.0 (43)
	225/45 R18 ⁷⁾ ⁸⁾						
	215/55 R17 ⁷⁾ , 220/2.2 (32)	200/2.0 (29)	270/2.7 (39)	260/2.6 (38)	220/2.2 (32)	270/2.7 (39)	
	235/45 R18 ⁷⁾ ,						
	245/45 R18,						
	245/40 R19 ⁸⁾						
	225/55 R17	220/2.2 (32)	200/2.0 (29)	300/3.0 (43)	300/3.0 (43)	220/2.2 (32)	270/2.7 (39)
245/35 R20 ⁸⁾	230/2.3 (33)	210/2.1 (30)	270/2.7 (39)	260/2.6 (38)	250/2.5 (36)	300/3.0 (43)	

⁷⁾ Only permitted as winter tyres.

⁸⁾ Reinforced variant (XL).

Engine	Tyres	Comfort with up to 3 people		ECO with up to 3 people		With full load	
		front	rear	front	rear	front	rear
		[kPa/bar] ([psi])	[kPa/bar] ([psi])	[kPa/bar] ([psi])	[kPa/bar] ([psi])	[kPa/bar] ([psi])	[kPa/bar] ([psi])
A20NHT with automatic transmission	225/50 R17 ⁷⁾ ⁸⁾ , 240/2.4 (35)	220/2.2 (32)	–	–	–	250/2.5 (36)	300/3.0 (43)
	225/45 R18 ⁷⁾ ⁸⁾	–	–	–	–	–	–
	215/55 R17 ⁷⁾ , 220/2.2 (32)	200/2.0 (29)	270/2.7 (39)	260/2.6 (38)	220/2.2 (32)	270/2.7 (39)	
	235/45 R18 ⁷⁾ ,						
	245/45 R18,						
	245/40 R19 ⁸⁾						
	225/55 R17	220/2.2 (32)	200/2.0 (29)	300/3.0 (43)	300/3.0 (43)	220/2.2 (32)	270/2.7 (39)
	245/35 R20 ⁸⁾	240/2.4 (35)	220/2.2 (32)	270/2.7 (39)	260/2.6 (38)	250/2.5 (36)	300/3.0 (43)

⁷⁾ Only permitted as winter tyres.

⁸⁾ Reinforced variant (XL).

Engine	Tyres	Comfort with up to 3 people		ECO with up to 3 people		With full load	
		front	rear	front	rear	front	rear
		[kPa/bar] ([psi])	[kPa/bar] ([psi])	[kPa/bar] ([psi])	[kPa/bar] ([psi])	[kPa/bar] ([psi])	[kPa/bar] ([psi])
A20DTC	225/50 R17 ⁷⁾ ⁸⁾ , 220/2.2 (32)	200/2.0 (29)	–	–	–	220/2.2 (32)	270/2.7 (39)
	225/45 R18 ⁷⁾ ⁸⁾						
	205/60 R16 ⁷⁾ , 220/2.2 (32)	200/2.0 (29)	270/2.7 (39)	260/2.6 (38)	220/2.2 (32)	270/2.7 (39)	
	215/60 R16,						
	215/55 R17 ⁷⁾ ,						
	235/45 R18 ⁷⁾ ,						
	245/45 R18,						
	245/40 R19 ⁸⁾ ,						
245/35 R20 ⁸⁾							
	225/55 R17	220/2.2 (32)	200/2.0 (29)	280/2.8 (41)	280/2.8 (41)	220/2.2 (32)	270/2.7 (39)

⁷⁾ Only permitted as winter tyres.

⁸⁾ Reinforced variant (XL).

Engine	Tyres	Comfort with up to 3 people		ECO with up to 3 people		With full load	
		front	rear	front	rear	front	rear
		[kPa/bar] ([psi])	[kPa/bar] ([psi])	[kPa/bar] ([psi])	[kPa/bar] ([psi])	[kPa/bar] ([psi])	[kPa/bar] ([psi])
A20DTJ with manual transmission	215/60 R16,	220/2.2 (32)	200/2.0 (29)	270/2.7 (39)	260/2.6 (38)	230/2.3 (33)	280/2.8 (41)
	225/50 R17 ⁷⁾ ⁸⁾ ,						
	225/45 R18 ⁷⁾ ⁸⁾						
	205/60 R16 ⁷⁾ ,	220/2.2 (32)	200/2.0 (29)	270/2.7 (39)	260/2.6 (38)	220/2.2 (32)	270/2.7 (39)
	215/55 R17 ⁷⁾ ,						
	235/45 R18 ⁷⁾ ,						
	245/45 R18,						
	245/40 R19 ⁸⁾						
	225/55 R17	220/2.2 (32)	200/2.0 (29)	280/2.8 (41)	280/2.8 (41)	220/2.2 (32)	270/2.7 (39)
	245/35 R20 ⁸⁾	230/2.3 (33)	210/2.1 (30)	270/2.7 (39)	260/2.6 (38)	230/2.3 (33)	280/2.8 (41)

⁷⁾ Only permitted as winter tyres.

⁸⁾ Reinforced variant (XL).

Engine	Tyres	Comfort with up to 3 people		ECO with up to 3 people		With full load	
		front	rear	front	rear	front	rear
		[kPa/bar] ([psi])	[kPa/bar] ([psi])	[kPa/bar] ([psi])	[kPa/bar] ([psi])	[kPa/bar] ([psi])	[kPa/bar] ([psi])
A20DTJ with automatic transmission	215/60 R16,	230/2.3 (33)	210/2.1 (30)	270/2.7 (39)	260/2.6 (38)	230/2.3 (33)	280/2.8 (41)
	225/50 R17 ⁷⁾ ⁸⁾ ,						
	225/45 R18 ⁷⁾ ⁸⁾						
	205/60 R16 ⁷⁾ ,	220/2.2 (32)	200/2.0 (29)	270/2.7 (39)	260/2.6 (38)	220/2.2 (32)	270/2.7 (39)
	215/55 R17 ⁷⁾ ,						
	235/45 R18 ⁷⁾ ,						
	245/45 R18, 245/40 R19 ⁸⁾						
225/55 R17	220/2.2 (32)	200/2.0 (29)	280/2.8 (41)	280/2.8 (41)	220/2.2 (32)	270/2.7 (39)	
245/35 R20 ⁸⁾	230/2.3 (33)	210/2.1 (30)	270/2.7 (39)	260/2.6 (38)	230/2.3 (33)	280/2.8 (41)	

⁷⁾ Only permitted as winter tyres.

⁸⁾ Reinforced variant (XL).

Engine	Tyres	Comfort with up to 3 people		ECO with up to 3 people		With full load	
		front	rear	front	rear	front	rear
		[kPa/bar] ([psi])	[kPa/bar] ([psi])	[kPa/bar] ([psi])	[kPa/bar] ([psi])	[kPa/bar] ([psi])	[kPa/bar] ([psi])
A20DTH with manual transmission	215/60 R16	230/2.3 (33)	210/2.1 (30)	270/2.7 (39)	260/2.6 (38)	240/2.4 (35)	290/2.9 (42)
	225/50 R17 ⁷⁾ 8),	240/2.4 (35)	220/2.2 (32)	–	–	240/2.4 (35)	290/2.9 (42)
	225/45 R 18 ⁷⁾ 8)						
	215/55 R 17 ⁷⁾ ,	220/2.2 (32)	200/2.0 (29)	270/2.7 (39)	260/2.6 (38)	220/2.2 (32)	270/2.7 (39)
	235/45 R18 ⁷⁾ ,						
	245/45 R18,						
	245/40 R19 ⁸⁾						
	225/55 R17	220/2.2 (32)	200/2.0 (29)	280/2.8 (41)	280/2.8 (41)	220/2.2 (32)	270/2.7 (39)
245/35 R20 ⁸⁾	220/2.2 (32)	200/2.0 (29)	270/2.7 (39)	260/2.6 (38)	230/2.3 (33)	280/2.8 (41)	

7) Only permitted as winter tyres.

8) Reinforced variant (XL).

Engine	Tyres	Comfort with up to 3 people		ECO with up to 3 people		With full load	
		front	rear	front	rear	front	rear
		[kPa/bar] ([psi])	[kPa/bar] ([psi])	[kPa/bar] ([psi])	[kPa/bar] ([psi])	[kPa/bar] ([psi])	[kPa/bar] ([psi])
A20DTH with automatic transmission	225/50 R17 ⁷⁾ ⁸⁾ , 240/2.4 (35)	220/2.2 (32)	220/2.2 (32)	–	–	240/2.4 (35)	290/2.9 (42)
	225/45 R18 ⁷⁾ ⁸⁾						
	215/55 R17 ⁷⁾ ,	220/2.2 (32)	200/2.0 (29)	270/2.7 (39)	260/2.6 (38)	220/2.2 (32)	270/2.7 (39)
	235/45 R18 ⁷⁾ ,						
	245/45 R18,						
	245/40 R19 ⁸⁾						
	225/55 R17	220/2.2 (32)	200/2.0 (29)	280/2.8 (41)	280/2.8 (41)	220/2.2 (32)	270/2.7 (39)
	245/35 R20 ⁸⁾	220/2.2 (32)	200/2.0 (29)	270/2.7 (39)	260/2.6 (38)	230/2.3 (33)	280/2.8 (41)

⁷⁾ Only permitted as winter tyres.

⁸⁾ Reinforced variant (XL).

Engine	Tyres	Comfort with up to 3 people		ECO with up to 3 people		With full load	
		front	rear	front	rear	front	rear
		[kPa/bar] ([psi])	[kPa/bar] ([psi])	[kPa/bar] ([psi])	[kPa/bar] ([psi])	[kPa/bar] ([psi])	[kPa/bar] ([psi])
A20DTH ECOFlex with manual transmission	225/50 R17 ⁷⁾ ⁸⁾ , 240/2.4 (35)	220/2.2 (32)	–	–	–	240/2.4 (35)	290/2.9 (42)
	225/45 R18 ⁷⁾ ⁸⁾						
	215/60 R16	230/2.3 (33)	210/2.1 (30)	270/2.7 (39)	260/2.6 (38)	240/2.4 (35)	290/2.9 (42)
	215/55 R17 ⁷⁾	220/2.2 (32)	200/2.0 (29)	270/2.7 (39)	260/2.6 (38)	220/2.2 (32)	270/2.7 (39)
	235/45 R18 ⁷⁾ ,						
	245/40 R19 ⁸⁾ ,						
	245/45 R18						
	225/55 R17	220/2.2 (32)	200/2.0 (29)	300/3.0 (43)	300/3.0 (43)	220/2.2 (32)	270/2.7 (39)
245/35 R20 ⁸⁾	220/2.2 (32)	200/2.0 (29)	270/2.7 (39)	260/2.6 (38)	230/2.3 (33)	280/2.8 (41)	

⁷⁾ Only permitted as winter tyres.

⁸⁾ Reinforced variant (XL).

Engine	Tyres	Comfort with up to 3 people		ECO with up to 3 people		With full load	
		front	rear	front	rear	front	rear
		[kPa/bar] ([psi])	[kPa/bar] ([psi])	[kPa/bar] ([psi])	[kPa/bar] ([psi])	[kPa/bar] ([psi])	[kPa/bar] ([psi])
A20DTR	215/55 R17 ⁷⁾ , 235/45 R18 ⁷⁾ , 245/45 R18, 245/40 R19 ⁸⁾	220/2.2 (32)	200/2.0 (29)	270/2.7 (39)	260/2.6 (38)	230/2.3 (33)	280/2.8 (41)
	225/55 R17	220/2.2 (32)	200/2.0 (29)	280/2.8 (41)	280/2.8 (41)	230/2.3 (33)	280/2.8 (41)
	225/50 R17 ⁷⁾⁸⁾ , 225/45 R18 ⁷⁾⁸⁾	240/2.4 (34)	220/2.2 (32)	–	–	250/2.5 (36)	300/3.0 (43)
	245/35 R20 ⁸⁾	230/2.3 (33)	210/2.1 (30)	270/2.7 (39)	260/2.6 (38)	240/2.4 (34)	290/2.9 (41)
	Temporary spare wheel	420/4.2 (61)	420/4.2 (61)	–	–	420/4.2 (61)	420/4.2 (61)

⁷⁾ Only permitted as winter tyres.

⁸⁾ Reinforced variant (XL).

Estate		Comfort with up to 3 people		ECO with up to 3 people		With full load	
Engine	Tyres	front	rear	front	rear	front	rear
		[kPa/bar] ([psi])	[kPa/bar] ([psi])	[kPa/bar] ([psi])	[kPa/bar] ([psi])	[kPa/bar] ([psi])	[kPa/bar] ([psi])
A16XER	205/60 R16 ⁷⁾ ,	220/2.2	240/2.4	270/2.7	290/2.9	220/2.2	290/2.9
		(32)	(34)	(39)	(41)	(32)	(42)
	215/60 R16,						
	215/55 R17, ⁷⁾						
	225/55 R17,						
	225/50 R17 ⁹⁾ ,						
	225/45 R18 ⁷⁾⁸⁾ ,						
	235/45 R18 ⁷⁾ ,						
	245/45 R18,						
245/40 R19 ⁸⁾ ,							
245/35 R20 ⁸⁾							

⁷⁾ Only permitted as winter tyres.

⁹⁾ Only reinforced variant permitted as winter tyre.

⁸⁾ Reinforced variant (XL).

Engine	Tyres	Comfort with up to 3 people		ECO with up to 3 people		With full load	
		front	rear	front	rear	front	rear
		[kPa/bar] ([psi])	[kPa/bar] ([psi])	[kPa/bar] ([psi])	[kPa/bar] ([psi])	[kPa/bar] ([psi])	[kPa/bar] ([psi])
A18XER	205/60 R16 ⁷⁾ , 215/60 R16, 215/55 R17 ⁷⁾ , 225/55 R17, 225/50 R17, 225/45 R18 ⁷⁾ , 235/45 R18 ⁷⁾ , 245/45 R18, 245/40 R19 ⁸⁾ , 245/35 R20 ⁸⁾	220/2.2 (32)	240/2.4 (34)	270/2.7 (39)	290/2.9 (41)	220/2.2 (32)	290/2.9 (42)

⁷⁾ Only permitted as winter tyres.

⁸⁾ Reinforced variant (XL).

Engine	Tyres	Comfort with up to 3 people		ECO with up to 3 people		With full load	
		front	rear	front	rear	front	rear
		[kPa/bar] ([psi])	[kPa/bar] ([psi])	[kPa/bar] ([psi])	[kPa/bar] ([psi])	[kPa/bar] ([psi])	[kPa/bar] ([psi])
A16 LET	215/55 R17 ⁷⁾ ,	220/2.2 (32)	240/2.4 (34)	270/2.7 (39)	290/2.9 (42)	220/2.2 (32)	290/2.9 (42)
	225/55 R17, 225/50 R17, 235/45 R18 ⁷⁾ , 245/45 R18, 245/40 R19 ⁸⁾ , 245/35 R20 ⁸⁾						
	225/45 R18 ⁷⁾⁸⁾	230/2.3 (33)	250/2.5 (36)	–	–	240/2.4 (34)	310/3.1 (45)

⁷⁾ Only permitted as winter tyres.

⁸⁾ Reinforced variant (XL).

Engine	Tyres	Comfort with up to 3 people		ECO with up to 3 people		With full load	
		front	rear	front	rear	front	rear
		[kPa/bar] ([psi])	[kPa/bar] ([psi])	[kPa/bar] ([psi])	[kPa/bar] ([psi])	[kPa/bar] ([psi])	[kPa/bar] ([psi])
A20NHT	225/50 R17,	240/2.4 (34)	260/2.6 (38)	270/2.7 (39)	290/2.9 (42)	250/2.5 (36)	320/3.2 (46)
	235/45 R18 ⁷⁾ ,						
	245/35 R20 ⁸⁾						
	225/45 R18 ⁷⁾⁸⁾	270/2.7 (39)	290/2.9 (42)	–	–	280/2.8 (40)	350/3.5 (51)
	215/55 R17 ⁷⁾	230/2.3 (33)	250/2.5 (36)	270/2.7 (39)	290/2.9 (42)	250/2.5 (36)	320/3.2 (46)
	225/55 R17,	220/2.2 (32)	240/2.4 (34)	270/2.7 (39)	290/2.9 (42)	220/2.2 (32)	290/2.9 (42)
	245/40 R19 ⁸⁾						
	245/45 R18	220/2.2 (32)	240/2.4 (34)	270/2.7 (39)	290/2.9 (42)	230/2.3 (33)	300/3.0 (43)

⁷⁾ Only permitted as winter tyres.

⁸⁾ Reinforced variant (XL).

Engine	Tyres	Comfort with up to 3 people		ECO with up to 3 people		With full load	
		front	rear	front	rear	front	rear
		[kPa/bar] ([psi])	[kPa/bar] ([psi])	[kPa/bar] ([psi])	[kPa/bar] ([psi])	[kPa/bar] ([psi])	[kPa/bar] ([psi])
A20DTC	225/50 R17,	220/2.2 (32)	240/2.4 (34)	270/2.7 (39)	290/2.9 (42)	230/2.3 (33)	300/3.0 (43)
	215/55 R17 ⁷⁾ ,						
	235/45 R18 ⁷⁾						
	225/45 R18 ⁷⁾⁸⁾	250/2.5 (36)	270/2.7 (39)	–	–	250/2.5 (36)	320/3.2 (46)
	245/45 R18,	220/2.2 (32)	240/2.4 (35)	270/2.7 (39)	290/2.9 (42)	220/2.2 (32)	290/2.9 (42)
245/40 R19 ⁸⁾ ,							
245/35 R20 ⁸⁾							
	225/55 R17	220/2.2 (32)	240/2.4 (35)	290/2.9 (42)	320/3.2 (46)	220/2.2 (32)	290/2.9 (42)

⁷⁾ Only permitted as winter tyres.

⁸⁾ Reinforced variant (XL).

Engine	Tyres	Comfort with up to 3 people		ECO with up to 3 people		With full load	
		front	rear	front	rear	front	rear
		[kPa/bar] ([psi])	[kPa/bar] ([psi])	[kPa/bar] ([psi])	[kPa/bar] ([psi])	[kPa/bar] ([psi])	[kPa/bar] ([psi])
A20DTJ with manual transmission	225/45 R18 ⁷⁾⁸⁾	250/2.5 (36)	270/2.7 (39)	–	–	250/2.5 (36)	320/3.2 (46)
	215/55 R17 ⁷⁾ ,	220/2.2 (32)	240/2.4 (35)	270/2.7 (39)	290/2.9 (42)	230/2.3 (33)	300/3.0 (43)
	225/50 R17, 235/45 R18 ⁷⁾						
	225/55 R17	220/2.2 (32)	240/2.4 (35)	290/2.9 (42)	320/3.2 (46)	220/2.2 (32)	290/2.9 (42)
	245/45 R18,	220/2.2 (32)	240/2.4 (35)	270/2.7 (39)	290/2.9 (42)	220/2.2 (32)	290/2.9 (42)
	245/40 R19 ⁸⁾ , 245/35 R20 ⁸⁾						

⁷⁾ Only permitted as winter tyres.

⁸⁾ Reinforced variant (XL).

Engine	Tyres	Comfort with up to 3 people		ECO with up to 3 people		With full load	
		front	rear	front	rear	front	rear
		[kPa/bar] ([psi])	[kPa/bar] ([psi])	[kPa/bar] ([psi])	[kPa/bar] ([psi])	[kPa/bar] ([psi])	[kPa/bar] ([psi])
A20DTJ with automatic transmission	225/45 R18 ⁷⁾⁸⁾	250/2.5 (36)	270/2.7 (39)	–	–	250/2.5 (36)	320/3.2 (46)
	215/55 R17 ⁷⁾ ,	230/2.3 (33)	250/2.5 (36)	270/2.7 (39)	290/2.9 (42)	230/2.3 (33)	300/3.0 (43)
	225/50 R17, 245/35 R20 ⁸⁾ , 235/45 R18 ⁷⁾						
	225/55 R17	220/2.2 (32)	240/2.4 (35)	290/2.9 (42)	320/3.2 (46)	220/2.2 (32)	290/2.9 (42)
	245/45 R18, 245/40 R19 ⁸⁾	220/2.2 (32)	240/2.4 (35)	270/2.7 (39)	290/2.9 (42)	220/2.2 (32)	290/2.9 (42)

⁷⁾ Only permitted as winter tyres.

⁸⁾ Reinforced variant (XL).

Engine	Tyres	Comfort with up to 3 people		ECO with up to 3 people		With full load	
		front	rear	front	rear	front	rear
		[kPa/bar] ([psi])	[kPa/bar] ([psi])	[kPa/bar] ([psi])	[kPa/bar] ([psi])	[kPa/bar] ([psi])	[kPa/bar] ([psi])
A20DTH, A20DTH ECOFlex with manual transmission	225/45 R 18 ⁷⁾ ⁸⁾	250/2.5 (36)	270/2.7 (39)	–	–	250/2.5 (36)	320/3.2 (46)
	215/55 R 17 ⁷⁾ ,	230/2.3 (33)	250/2.5 (36)	270/2.7 (39)	290/2.9 (42)	240/2.4 (35)	310/3.1 (45)
	225/50 R17						
	225/55 R 17	220/2.2 (32)	240/2.4 (35)	290/2.9 (42)	320/3.2 (46)	220/2.2 (32)	290/2.9 (42)
	235/45 R18 ⁷⁾	230/2.3 (33)	250/2.5 (36)	270/2.7 (39)	290/2.9 (42)	230/2.3 (33)	300/3.0 (43)
	245/45 R18,	220/2.2 (32)	240/2.4 (35)	270/2.7 (39)	290/2.9 (42)	220/2.2 (32)	290/2.9 (42)
	245/40 R19 ⁸⁾						
245/35 R20 ⁸⁾	220/2.2 (32)	240/2.4 (35)	270/2.7 (39)	290/2.9 (42)	230/2.3 (33)	300/3.0 (43)	

7) Only permitted as winter tyres.

8) Reinforced variant (XL).

Engine	Tyres	Comfort with up to 3 people		ECO with up to 3 people		With full load	
		front	rear	front	rear	front	rear
		[kPa/bar] ([psi])	[kPa/bar] ([psi])	[kPa/bar] ([psi])	[kPa/bar] ([psi])	[kPa/bar] ([psi])	[kPa/bar] ([psi])
A20DTH with automatic transmission	225/45 R18 ⁷⁾ ⁸⁾	260/2.6 (38)	280/2.8 (41)	–	–	260/2.6 (38)	330/3.3 (48)
	215/55 R17 ⁷⁾ ,	230/2.3 (33)	250/2.5 (36)	270/2.7 (39)	290/2.9 (42)	240/2.4 (35)	310/3.1 (45)
	225/50 R17, 235/45 R18 ⁷⁾						
	225/55 R17	220/2.2 (32)	240/2.4 (35)	290/2.9 (42)	320/3.2 (46)	220/2.2 (32)	290/2.9 (42)
	245/45 R18,	220/2.2 (32)	240/2.4 (35)	270/2.7 (39)	290/2.9 (42)	220/2.2 (32)	290/2.9 (42)
	245/40 R19 ⁸⁾						
	245/35 R20 ⁸⁾	230/2.3 (33)	250/2.5 (36)	270/2.7 (39)	290/2.9 (42)	230/2.3 (33)	300/3.0 (43)

⁷⁾ Only permitted as winter tyres.

⁸⁾ Reinforced variant (XL).

Engine	Tyres	Comfort with up to 3 people		ECO with up to 3 people		With full load	
		front	rear	front	rear	front	rear
		[kPa/bar] ([psi])	[kPa/bar] ([psi])	[kPa/bar] ([psi])	[kPa/bar] ([psi])	[kPa/bar] ([psi])	[kPa/bar] ([psi])
A20DTR with manual transmission	215/55 R17 ⁷⁾ ,	240/2.4 (35)	260/2.6 (38)	270/2.7 (39)	290/2.9 (42)	240/2.4 (35)	310/3.1 (45)
	225/50 R17						
	235/45 R18 ⁷⁾	240/2.4 (35)	260/2.6 (38)	270/2.7 (39)	290/2.9 (42)	250/2.5 (36)	320/3.2 (46)
	245/45 R18,	220/2.2 (32)	240/2.4 (35)	270/2.7 (39)	290/2.9 (42)	220/2.2 (32)	290/2.9 (42)
	245/40 R19 ⁸⁾						
	225/55 R17	220/2.2 (32)	240/2.4 (35)	290/2.9 (42)	320/3.2 (46)	220/2.2 (32)	290/2.9 (42)
	225/45 R18 ⁷⁾⁸⁾	250/2.5 (36)	270/2.7 (39)	–	–	260/2.6 (38)	330/3.3 (48)
	245/35 R20 ⁸⁾	230/2.3 (33)	250/2.5 (36)	270/2.7 (39)	290/2.9 (42)	230/2.3 (33)	300/3.0 (43)

⁷⁾ Only permitted as winter tyres.

⁸⁾ Reinforced variant (XL).

Engine	Tyres	Comfort with up to 3 people		ECO with up to 3 people		With full load	
		front	rear	front	rear	front	rear
		[kPa/bar] ([psi])	[kPa/bar] ([psi])	[kPa/bar] ([psi])	[kPa/bar] ([psi])	[kPa/bar] ([psi])	[kPa/bar] ([psi])
A20DTR with automatic transmission	215/55 R17 ⁷⁾ ,	240/2.4 (35)	260/2.6 (38)	270/2.7 (39)	290/2.9 (42)	250/2.5 (36)	320/3.2 (46)
	225/50 R17, 235/45 R18 ⁷⁾						
	245/45 R18,	220/2.2 (32)	240/2.4 (35)	270/2.7 (39)	290/2.9 (42)	220/2.2 (32)	290/2.9 (42)
	245/40 R19 ⁸⁾						
	225/55 R17	220/2.2 (32)	240/2.4 (35)	290/2.9 (42)	320/3.2 (46)	220/2.2 (32)	290/2.9 (42)
	225/45 R18 ⁷⁾⁸⁾	260/2.6 (38)	280/2.8 (41)	–	–	260/2.6 (38)	330/3.3 (48)
	245/35 R20 ⁸⁾	230/2.3 (33)	250/2.5 (36)	270/2.7 (39)	290/2.9 (42)	240/2.4 (35)	310/3.1 (45)

⁷⁾ Only permitted as winter tyres.

⁸⁾ Reinforced variant (XL).

Engine	Tyres	Comfort with up to 3 people		ECO with up to 3 people		With full load	
		front	rear	front	rear	front	rear
		[kPa/bar] ([psi])	[kPa/bar] ([psi])	[kPa/bar] ([psi])	[kPa/bar] ([psi])	[kPa/bar] ([psi])	[kPa/bar] ([psi])
All	Temporary spare wheel	420/4.2 (61)	420/4.2 (61)	–	–	420/4.2 (61)	420/4.2 (61)

Tyre pressures for vehicles with all-wheel drive

Saloon/Hatchback

Engine	Tyres	Comfort with up to 3 people		ECO with up to 3 people		With full load	
		front	rear	front	rear	front	rear
		[kPa/bar] ([psi])	[kPa/bar] ([psi])	[kPa/bar] ([psi])	[kPa/bar] ([psi])	[kPa/bar] ([psi])	[kPa/bar] ([psi])
A20NHT with manual transmission	225/50 R17 ⁷⁾⁸⁾ ,	250/2.5 (36)	230/2.3 (33)	–	–	250/2.5 (36)	300/3.0 (43)
	225/45 R18 ⁷⁾⁸⁾						
	215/55 R17 ⁷⁾ ,	230/2.3 (33)	210/2.1 (30)	270/2.7 (39)	260/2.6 (38)	240/2.4 (35)	290/2.9 (42)
	225/55 R17,						
	235/45 R18 ⁷⁾ ,						
	245/45 R18,						
	245/40 R19						
	245/35 R20 ⁸⁾	240/2.4 (35)	220/2.2 (32)	270/2.7 (39)	260/2.6 (38)	250/2.5 (36)	300/3.0 (43)

7) Only permitted as winter tyres.

8) Reinforced variant (XL).

Engine	Tyres	Comfort with up to 3 people		ECO with up to 3 people		With full load	
		front	rear	front	rear	front	rear
		[kPa/bar] ([psi])	[kPa/bar] ([psi])	[kPa/bar] ([psi])	[kPa/bar] ([psi])	[kPa/bar] ([psi])	[kPa/bar] ([psi])
A20NHT with automatic transmission	225/50 R17 ⁷⁾⁸⁾ ,	260/2.6 (38)	240/2.4 (35)	–	–	260/2.6 (38)	310/3.1 (45)
	225/45 R18 ⁷⁾⁸⁾						
	215/55 R17 ⁷⁾ ,	230/2.3 (33)	210/2.1 (30)	270/2.7 (39)	260/2.6 (38)	240/2.4 (35)	290/2.9 (42)
	225/55 R17,						
	235/45 R18 ⁷⁾ ,						
	245/45 R18,						
	245/40 R19						
	245/35 R20 ⁸⁾	250/2.5 (36)	230/2.3 (33)	270/2.7 (39)	260/2.6 (38)	250/2.5 (36)	300/3.0 (43)

⁷⁾ Only permitted as winter tyres.

⁸⁾ Reinforced variant (XL).

Engine	Tyres	Comfort with up to 3 people		ECO with up to 3 people		With full load	
		front	rear	front	rear	front	rear
		[kPa/bar] ([psi])	[kPa/bar] ([psi])	[kPa/bar] ([psi])	[kPa/bar] ([psi])	[kPa/bar] ([psi])	[kPa/bar] ([psi])
A20DTR with manual transmission	225/50 R17 ⁷⁾⁸⁾ ,	250/2.5 (36)	230/2.3 (33)	–	–	260/2.6 (38)	310/3.1 (45)
	225/45 R18 ⁷⁾⁸⁾						
	215/55 R17 ⁷⁾ ,	220/2.2 (32)	200/2.0 (29)	270/2.7 (39)	260/2.6 (38)	230/2.3 (33)	280/2.8 (41)
	225/55 R17,						
	235/45 R18 ⁷⁾ ,						
	245/45 R18,						
	245/40 R19						
	245/35 R20 ⁸⁾	240/2.4 (35)	220/2.2 (32)	270/2.7 (39)	260/2.6 (38)	250/2.5 (36)	300/3.0 (43)

⁷⁾ Only permitted as winter tyres.

⁸⁾ Reinforced variant (XL).

Engine	Tyres	Comfort with up to 3 people		ECO with up to 3 people		With full load	
		front	rear	front	rear	front	rear
		[kPa/bar] ([psi])	[kPa/bar] ([psi])	[kPa/bar] ([psi])	[kPa/bar] ([psi])	[kPa/bar] ([psi])	[kPa/bar] ([psi])
A20DTR with automatic transmission	225/50 R17 ⁷⁾⁸⁾ ,	250/2.5 (36)	230/2.3 (33)	–	–	260/2.6 (38)	310/3.1 (45)
	225/45 R18 ⁷⁾⁸⁾						
	215/55 R17 ⁷⁾ ,	230/2.3 (33)	210/2.1 (30)	270/2.7 (39)	260/2.6 (38)	240/2.4 (35)	290/2.9 (42)
	225/55 R17,						
	235/45 R18 ⁷⁾ ,						
	245/45 R18,						
	245/40 R19						
	245/35 R20 ⁸⁾	240/2.4 (35)	220/2.2 (32)	270/2.7 (39)	260/2.6 (38)	250/2.5 (36)	300/3.0 (43)

⁷⁾ Only permitted as winter tyres.

⁸⁾ Reinforced variant (XL).

Engine	Tyres	Comfort with up to 3 people		ECO with up to 3 people		With full load	
		front	rear	front	rear	front	rear
		[kPa/bar] ([psi])	[kPa/bar] ([psi])	[kPa/bar] ([psi])	[kPa/bar] ([psi])	[kPa/bar] ([psi])	[kPa/bar] ([psi])
A28NET with manual transmission	225/50 R17 ⁷⁾⁸⁾ ,	270/2.7 (39)	250/2.5 (36)	–	–	270/2.7 (39)	320/3.2 (46)
	225/45 R18 ⁷⁾⁸⁾						
	215/55 R17 ⁷⁾ ,	260/2.6 (38)	240/2.4 (35)	–	–	270/2.7 (39)	320/3.2 (46)
	225/55 R17, 235/45 R18 ⁷⁾ ,						
	245/45 R18, 245/40 R19						
	245/35 R20 ⁸⁾	270/2.7 (39)	250/2.5 (36)	–	–	280/2.8 (41)	330/3.3 (48)

⁷⁾ Only permitted as winter tyres.

⁸⁾ Reinforced variant (XL).

Engine	Tyres	Comfort with up to 3 people		ECO with up to 3 people		With full load	
		front	rear	front	rear	front	rear
		[kPa/bar] ([psi])	[kPa/bar] ([psi])	[kPa/bar] ([psi])	[kPa/bar] ([psi])	[kPa/bar] ([psi])	[kPa/bar] ([psi])
A28NET with automatic transmission	225/50 R17 ⁷⁾ ⁸⁾ ,	270/2.7 (39)	250/2.5 (36)	–	–	280/2.8 (41)	330/3.3 (48)
	225/45 R18 ⁷⁾ ⁸⁾ , 215/55 R17 ⁷⁾ , 225/55 R17, 235/45 R18 ⁷⁾ , 245/45 R18, 245/40 R19						
	245/35 R20 ⁸⁾	260/2.6 (38)	240/2.4 (35)	–	–	270/2.7 (39)	320/3.2 (46)
A28 NER	235/45 R18 ⁷⁾ ,	250/2.5 (36)	230/2.3 (33)	–	–	260/2.6 (38)	320/3.2 (46)
	245/40 R19 ⁸⁾						

⁷⁾ Only permitted as winter tyres.

⁸⁾ Reinforced variant (XL).

Engine	Tyres	Comfort with up to 3 people		ECO with up to 3 people		With full load	
		front	rear	front	rear	front	rear
		[kPa/bar] ([psi])	[kPa/bar] ([psi])	[kPa/bar] ([psi])	[kPa/bar] ([psi])	[kPa/bar] ([psi])	[kPa/bar] ([psi])
	255/35 R20 ⁸⁾	270/2.7 (39)	250/2.5 (36)	–	–	280/2.8 (41)	330/3.3 (48)
All	Temporary spare wheel	420/4.2 (61)	420/4.2 (61)	–	–	420/4.2 (61)	420/4.2 (61)

⁸⁾ Reinforced variant (XL).

Estate

Engine	Tyres	Comfort with up to 3 people		ECO with up to 3 people		With full load	
		front	rear	front	rear	front	rear
		[kPa/bar] ([psi])	[kPa/bar] ([psi])	[kPa/bar] ([psi])	[kPa/bar] ([psi])	[kPa/bar] ([psi])	[kPa/bar] ([psi])
A20NHT with manual transmission	225/50 R17 ⁸⁾ , 215/55 R17 ⁷⁾	250/2.5 (36)	250/2.5 (36)	270/2.7 (39)	290/2.9 (42)	250/2.5 (36)	320/3.2 (46)
	225/55 R17	220/2.2 (32)	220/2.2 (32)	270/2.7 (39)	290/2.9 (42)	220/2.2 (32)	290/2.9 (42)
	225/45 R18 ⁷⁾⁸⁾	270/2.7 (39)	270/2.7 (39)	–	–	280/2.8 (41)	340/3.4 (49)
	235/45 R18 ⁷⁾	250/2.5 (36)	250/2.5 (36)	270/2.7 (39)	290/2.9 (42)	260/2.6 (38)	330/3.3 (48)
	245/45 R18	220/2.2 (32)	220/2.2 (32)	270/2.7 (39)	290/2.9 (42)	230/2.3 (33)	300/3.0 (43)
	245/40 R19 ⁸⁾	220/2.2 (32)	220/2.2 (32)	270/2.7 (39)	290/2.9 (42)	220/2.2 (32)	290/2.9 (42)
	245/35 R20 ⁸⁾	240/2.4 (35)	240/2.4 (35)	270/2.7 (39)	290/2.9 (42)	240/2.4 (35)	310/3.1 (45)

⁸⁾ Reinforced variant (XL).

⁷⁾ Only permitted as winter tyres.

Engine	Tyres	Comfort with up to 3 people		ECO with up to 3 people		With full load	
		front	rear	front	rear	front	rear
		[kPa/bar] ([psi])	[kPa/bar] ([psi])	[kPa/bar] ([psi])	[kPa/bar] ([psi])	[kPa/bar] ([psi])	[kPa/bar] ([psi])
A20NHT with automatic transmission	225/50 R17 ⁸⁾⁷⁾ , 215/55 R17 ⁷⁾	250/2.5 (36)	250/2.5 (36)	270/2.7 (39)	290/2.9 (42)	260/2.6 (38)	330/3.3 (48)
	225/55 R17	220/2.2 (32)	220/2.2 (32)	270/2.7 (39)	290/2.9 (42)	220/2.2 (32)	290/2.9 (42)
	225/45 R18 ⁷⁾⁸⁾	270/2.7 (39)	270/2.7 (39)	–	–	280/2.8 (41)	340/3.4 (49)
	235/45 R18 ⁷⁾	250/2.5 (36)	250/2.5 (36)	270/2.7 (39)	290/2.9 (42)	260/2.6 (38)	330/3.3 (48)
	245/45 R18	220/2.2 (32)	220/2.2 (32)	270/2.7 (39)	290/2.9 (42)	230/2.3 (33)	300/3.0 (43)
	245/40 R19 ⁸⁾	220/2.2 (32)	220/2.2 (32)	270/2.7 (39)	290/2.9 (42)	220/2.2 (32)	290/2.9 (42)
	245/35 R20 ⁸⁾	240/2.4 (35)	240/2.4 (35)	270/2.7 (39)	290/2.9 (42)	250/2.5 (36)	320/3.2 (46)

⁸⁾ Reinforced variant (XL).

⁷⁾ Only permitted as winter tyres.

Engine	Tyres	Comfort with up to 3 people		ECO with up to 3 people		With full load	
		front	rear	front	rear	front	rear
		[kPa/bar] ([psi])	[kPa/bar] ([psi])	[kPa/bar] ([psi])	[kPa/bar] ([psi])	[kPa/bar] ([psi])	[kPa/bar] ([psi])
A20DTR	215/55 R17 ⁷⁾⁸⁾ , 225/50 R17 ⁸⁾⁷⁾ , 235/45 R18 ⁷⁾⁸⁾ , 245/35 R20 ⁸⁾	240/2.4 (35)	240/2.4 (35)	270/2.7 (39)	290/2.9 (42)	250/2.5 (36)	320/3.2 (46)
	225/55 R17	220/2.2 (32)	220/2.2 (32)	270/2.7 (39)	290/2.9 (42)	220/2.2 (32)	290/2.9 (42)
	245/40 R19 ⁸⁾						
	245/45 R18	220/2.2 (32)	220/2.2 (32)	270/2.7 (39)	290/2.9 (42)	230/2.3 (33)	300/3.0 (43)
	225/45 R 18 ⁷⁾⁸⁾	270/2.7 (39)	270/2.7 (39)	–	–	280/2.8 (41)	340/3.4 (49)

7) Only permitted as winter tyres.

8) Reinforced variant (XL).

Engine	Tyres	Comfort with up to 3 people		ECO with up to 3 people		With full load	
		front	rear	front	rear	front	rear
		[kPa/bar] ([psi])	[kPa/bar] ([psi])	[kPa/bar] ([psi])	[kPa/bar] ([psi])	[kPa/bar] ([psi])	[kPa/bar] ([psi])
A28NET with manual transmission	215/55 R17 ⁷⁾⁸⁾ ,	280/2.8 (41)	280/2.8 (41)	–	–	300/3.0 (43)	340/3.4 (49)
	225/50 R17 ⁸⁾⁷⁾ ,						
	235/45 R18 ⁷⁾						
	225/55 R17	250/2.5 (36)	250/2.5 (36)	270/2.7 (39)	290/2.9 (42)	270/2.7 (39)	340/3.4 (49)
	225/45 R18 ⁷⁾⁸⁾ ,	270/2.7 (39)	270/2.7 (39)	–	–	280/2.8 (41)	340/3.4 (49)
	245/35 R20 ⁸⁾						
	245/45 R18	260/2.6 (38)	260/2.6 (38)	–	–	280/2.8 (41)	340/3.4 (49)
245/40 R19 ⁸⁾	240/2.4 (35)	240/2.4 (35)	–	–	250/2.5 (36)	320/3.2 (46)	

7) Only permitted as winter tyres.

8) Reinforced variant (XL).

Engine	Tyres	Comfort with up to 3 people		ECO with up to 3 people		With full load	
		front	rear	front	rear	front	rear
		[kPa/bar] ([psi])	[kPa/bar] ([psi])	[kPa/bar] ([psi])	[kPa/bar] ([psi])	[kPa/bar] ([psi])	[kPa/bar] ([psi])
A28NET with automatic transmission	215/55 R17 ⁷⁾ ,	280/2.8 (41)	280/2.8 (41)	–	–	300/3.0 (43)	340/3.4 (49)
	225/50 R17 ⁸⁾⁷⁾ ,						
	235/45 R18 ⁷⁾						
	225/55 R17	260/2.6 (38)	260/2.6 (38)	270/2.7 (39)	290/2.9 (42)	270/2.7 (39)	340/3.4 (49)
	225/45 R18 ⁷⁾⁸⁾ ,	270/2.7 (39)	270/2.7 (39)	–	–	280/2.8 (41)	340/3.4 (49)
	245/35 R20 ⁸⁾						
	245/45 R18	270/2.7 (39)	270/2.7 (39)	–	–	280/2.8 (41)	340/3.4 (49)
	245/40 R19 ⁸⁾	240/2.4 (35)	240/2.4 (35)	–	–	260/2.6 (38)	330/3.3 (48)
A28 NER	235/45 R18 ⁷⁾ ,	250/2.5 (36)	230/2.3 (33)	–	–	260/2.6 (38)	330/3.3 (48)
	245/40 R19 ⁸⁾						

⁷⁾ Only permitted as winter tyres.

⁸⁾ Reinforced variant (XL).

Engine	Tyres	Comfort with up to 3 people		ECO with up to 3 people		With full load	
		front	rear	front	rear	front	rear
		[kPa/bar] ([psi])	[kPa/bar] ([psi])	[kPa/bar] ([psi])	[kPa/bar] ([psi])	[kPa/bar] ([psi])	[kPa/bar] ([psi])
	255/35 R20 ⁸⁾	270/2.7 (39)	250/2.5 (36)	–	–	280/2.8 (41)	340/3.4 (49)
All	Temporary spare wheel	420/4.2 (61)	420/4.2 (61)	–	–	420/4.2 (61)	420/4.2 (61)

⁸⁾ Reinforced variant (XL).

Towing hitch installation dimensions

Saloon/Hatchback

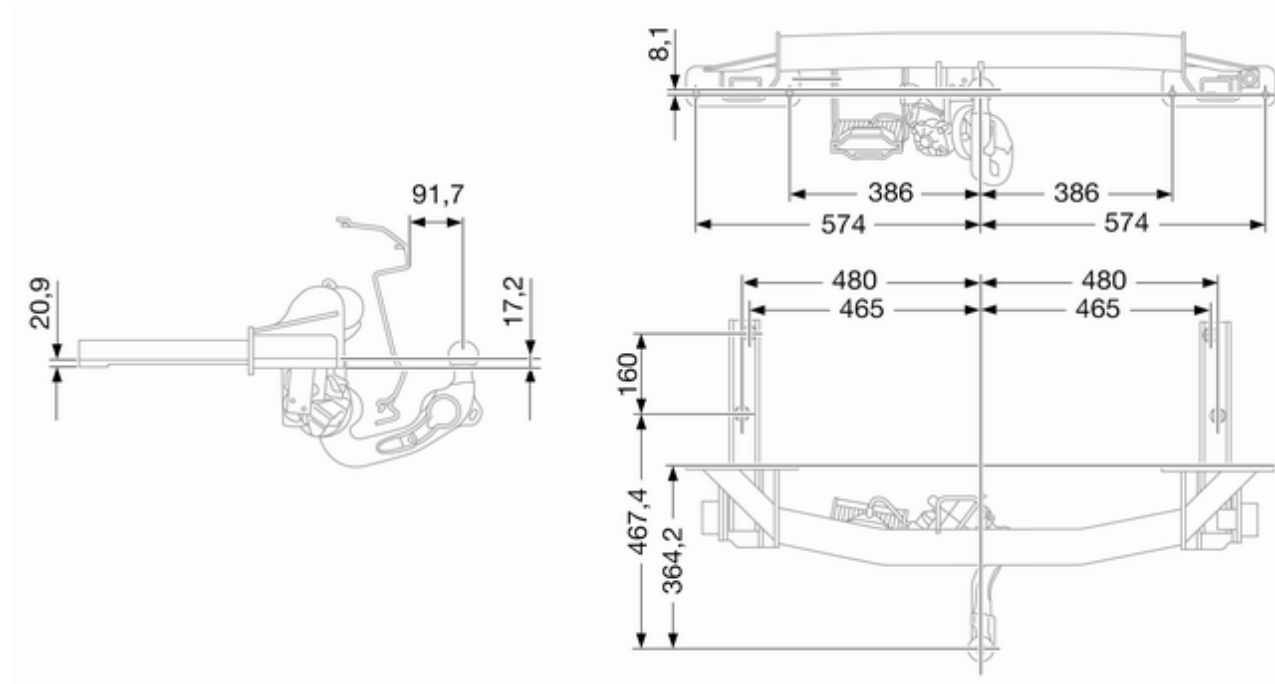

Estate

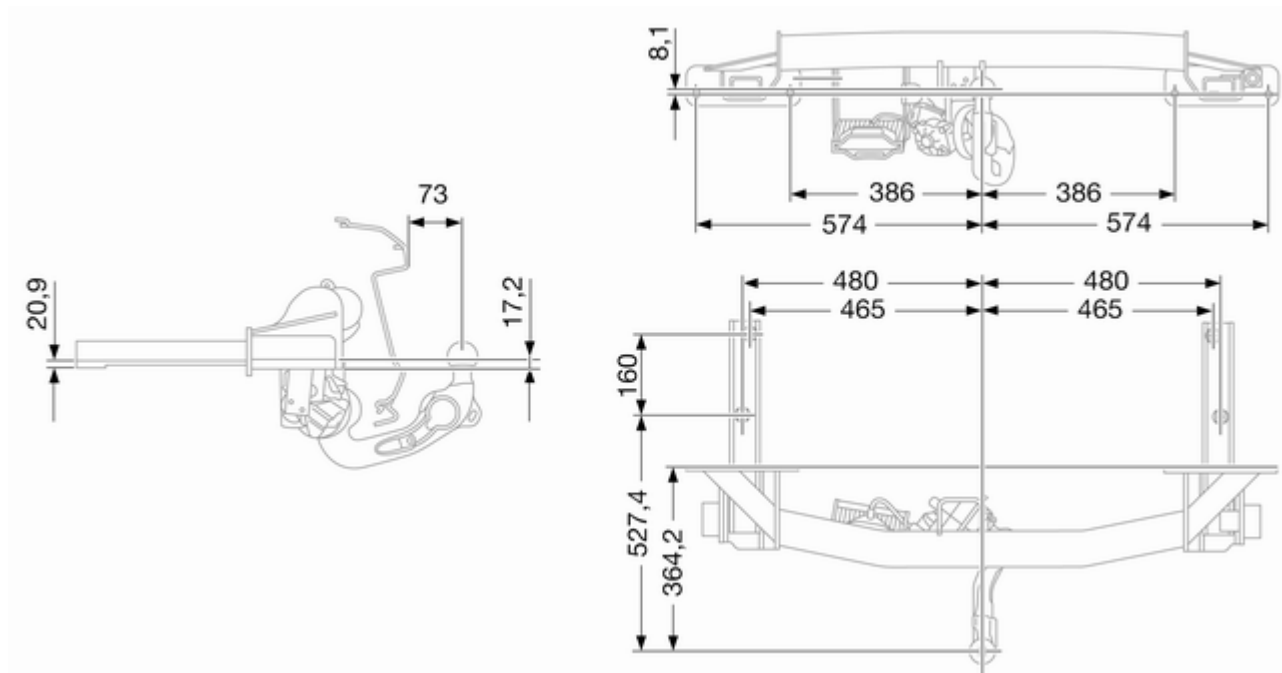

Customer information

Vehicle data recording and privacy 255

Vehicle data recording and privacy

Event data recorders

The vehicle has a number of sophisticated systems that monitor and control several vehicle data. Some data may be stored during regular operation to facilitate repair of detected malfunctions, other data is stored only in a crash or near crash event by systems commonly called event data recorders (EDR).

The systems may record data about the condition of the vehicle and how it was operated (e.g. engine speed, brake application, seat belt usage). To read this data special equipment and access to the vehicle is required. This will take place when the vehicle is serviced in a workshop. Some data is electronically fed into GM global diagnostic systems. The manufacturer will not access information about a crash event or share it with others except

- with the consent of the vehicle owner or, if the vehicle is leased, with the consent of the lessee,
- in response to an official request of police or similar government office,
- as part of the manufacturer's defense in case of legal proceedings,
- as required by law.

In addition, the manufacturer may use the collected or received data

- for the manufacturer's research needs,
- to make it available for research needs where appropriate confidentiality is maintained and need is shown,
- to share summary data which is not tied to a specific vehicle with other organisations for research purposes.

Index

A

Accessories and vehicle modifications	156
Adaptive forward lighting	89, 111
Adjustable air vents	124
Airbag and belt tensioners	84
Airbag deactivation	51, 85
Airbag system	48
Air conditioning regular operation	125
Air conditioning system	119
Air intake	125
Air quality sensor.....	120
All-wheel drive	136
Antilock brake system	136
Antilock brake system (ABS)	86
Anti-theft alarm system	28
Anti-theft locking system	28
Apply footbrake	88
Armrest.....	44, 45
Armrest storage	59
Ashtrays	78
Automatic anti-dazzle	32
Automatic light control	109
Automatic transmission	131
Auxiliary heater.....	124

B

Battery	161
Battery discharge protection	117
Bonnet	157
Brake and clutch system	85
Brake assist	138
Brake fluid	160
Brakes	136, 160
Bulb replacement	162

C

Capacities	214
Cargo management system	64
Car Pass	18
Catalytic converter	130
Central locking system	20
Centre console lighting	116
Changing tyre and wheel size ..	181
Charging system	85
Child locks	23
Child restraint installation locations	54
Child restraint systems	52
Cigarette lighter	78
Climate control	15
Clock.....	76
Control indicators.....	81
Control of the vehicle	127
Convex shape	30

Cruise control	89, 142
Cupholders	58
Curtain airbag system	50

D

Danger, Warnings and Cautions ...	3
Diesel fuel system bleeding	161
Diesel particle filter.....	87, 129
Door open	89
Driver Information Center.....	89
Driving characteristics and towing tips	152

E

Electric adjustment	30
Electrical parking brake.....	86
Electrical parking brake fault.....	86
Electronic climate control system	120
Electronic driving programmes ..	133
Electronic Stability Control . .	87, 140
Electronic Stability Control off.....	87
End-of-life vehicle recovery	157
Engine compartment fuse box ...	172
Engine coolant	159
Engine coolant temperature gauge	80
Engine data	201
Engine exhaust	129
Engine oil	158

Engine oil pressure	88
Entry lighting	116
Event data recorders.....	255
Exit lighting	116
Exterior care	192
Exterior light	88
Exterior lighting	12

F

Fault	133
First aid kit	69
Fixed air vents	125
Fog light	89
Fog lights	165
Folding	31
Front airbag system	49
Front fog lights	113
Front storage.....	59
Fuel consumption - CO ₂ - Emissions	151, 205
Fuel for diesel engines	149
Fuel for petrol engines	149
Fuel gauge	80
Fuses	171

G

General information	151
Glovebox	58
Graphic-Info-Display, Colour- Info-Display	92

H

Halogen headlights	162
Hand brake.....	137
Hazard warning flashers	113
Headlight flash	109
Headlight range adjustment	110
Headlights when driving abroad	110
Head restraint adjustment	8
Head restraints	38
Heated	31
Heated rear window	34
Heating	44
Heating and ventilation system .	118
High beam	89, 109
Hill start assist	139
Horn	13, 73

I

Identification plate	199
Ignition switch positions	128
Immobiliser	30, 88
Instrument panel fuse box	174
Instrument panel illumination	170
Instrument panel illumination control	115
Instrument panel overview	11
Interactive driving system.....	140
Interior care	194
Interior lights	115, 170

Interruption of power supply	133
Introduction	3
ISOFIX child restraint systems	57

J

Jump starting	188
---------------------	-----

K

Keys	18
------------	----

L

Lane departure warning.....	86, 148
Lashing eyes	64
Light switch	108
Load compartment	23, 60
Load compartment cover	62
Load compartment fuse box	176
Loading information	70
Low fuel	88

M

Malfunction indicator light	85
Manual anti-dazzle	32
Manual mode	132
Manual transmission	135
Manual windows	33
Memorised settings.....	20
Mirror adjustment	9
Misted light covers	114

N

New vehicle running-in	127
Number plate light	169

O

Odometer	79
Outside temperature	76
Overrun cut-off	128

P

Parking	17, 129
Parking assist	31, 143
Parking brake	137
Parking lights	114
Performance	203
Performing work	157
Pollen filter	125
Power outlets	77
Power seat adjustment.....	42
Power windows	33
Preheating	87

Q

Quickheat.....	124
----------------	-----

R

Radio remote control	19
Reading lights	116
Rear fog light	89
Rear fog lights	114

Rear window wiper/washer	75
Recommended fluids and lubricants	196
Refuelling	150
Reversing lights	114
Roller blinds	35
Roof rack	70

S

Safety net	66
Seat adjustment	6, 40
Seat belt	8
Seat belt reminder	84
Seat belts	45
Seat position	39
Selector lever	131
Service	125, 195
Service display	81
Service information	195
Service vehicle soon	85
Side airbag system	50
Side turn signal lights	169
Spare wheel	187
Speedometer	79
Starting off	16
Starting the engine	128
Steering wheel adjustment	9, 72
Steering wheel controls	72
Sunglasses storage	59
Sunroof	35

Sunvisor lights	116
Sun visors	34
Symbols	4
T	
Tachometer	80
Tail lights	165
Three-point seat belt	46
Tools	177
Top-tether fastening eyes	57
Towing another vehicle	191
Towing equipment	153
Towing hitch installation dimensions	253
Towing the vehicle	190
Traction Control system	139
Traction Control system off.....	87
Traffic sign assistant.....	98
Trailer stability assist	154
Trailer towing	152
Transmission	16
Transmission display	131
Tread depth	180
Trip computer	101
Trip odometer	79
Turn and lane-change signals ...	113
Turn signal	84
Tyre chains	182
Tyre designations	178
Tyre pressure	178

Tyre pressure monitoring system.....	88, 179
Tyre pressures	216
Tyre repair kit	182
Tyres	178

U

Ultrasonic parking assist	87
Upshift.....	86
Using this manual	3

V

Variable effort steering.....	86
Vehicle dimensions	214
Vehicle Identification Number	199
Vehicle messages	94
Vehicle personalisation	102
Vehicle specific data	3
Vehicle storage.....	156
Vehicle unlocking	6
Vehicle weight	208
Ventilating.....	44
Ventilation.....	118

W

Warning chimes	97
Warning triangle	68
Washer and wiper systems	14
Washer fluid	160
Wheel changing	185

Wheel covers	181
Wheels and tyres	178
Windscreen wiper/washer	73
Winter tyres	178
Wiper blade replacement	161

X

Xenon headlights	165
------------------------	-----

