



# CORSA

Owner's Manual



# Contents

| <b>Emergency numbers</b>                                        |                             |                                       |
|-----------------------------------------------------------------|-----------------------------|---------------------------------------|
| <b>For emergency service call the Vauxhall Incident Manager</b> |                             | <b>0800 55 33 88 (Free Linkline)*</b> |
| <b>Vauxhall Assistance General Enquiries</b>                    |                             | <b>0845 7565 565</b>                  |
| <b>You will need to provide:</b>                                | Vehicle registration number | Model and colour of your Vauxhall     |
|                                                                 | Contact telephone number    | Details of your precise location      |

\* Calls may be chargeable from mobile phones

|                                |     |
|--------------------------------|-----|
| Introduction .....             | 2   |
| Keys, doors and windows .....  | 6   |
| Seats, restraints .....        | 26  |
| Storage .....                  | 45  |
| Instruments and controls ..... | 51  |
| Lighting .....                 | 83  |
| Climate control .....          | 92  |
| Driving and operating .....    | 102 |
| Vehicle care .....             | 186 |
| Service and maintenance .....  | 228 |
| Technical data .....           | 233 |
| Customer information .....     | 240 |
| Index .....                    | 248 |

# Introduction

|               |                             |                      |                      |                      |
|---------------|-----------------------------|----------------------|----------------------|----------------------|
| Fuel          | Designation                 | <input type="text"/> |                      |                      |
| Engine oil    | Grade                       | <input type="text"/> |                      |                      |
|               | Viscosity                   | <input type="text"/> |                      |                      |
| Tyre pressure | Tyre size                   |                      | Front                | Rear                 |
|               | Summer tyres                | <input type="text"/> | <input type="text"/> | <input type="text"/> |
|               | Winter tyres                | <input type="text"/> | <input type="text"/> | <input type="text"/> |
| Weights       | Gross vehicle weight rating | <input type="text"/> |                      |                      |
|               | - Kerb weight, basic model  | <input type="text"/> |                      |                      |
|               | = Loading                   | <input type="text"/> |                      |                      |



## Vehicle specific data

Please enter your vehicle's data on the previous page to keep it easily accessible.

Please refer to the sections "Service and maintenance", "Technical data", the vehicle's identification plate and national registration documents.

## Introduction

Your vehicle is a designed combination of advanced technology, safety, environmental friendliness and economy.

This Owner's Manual provides you with all the necessary information to enable you to drive your vehicle safely and efficiently.

Some functions are only operational when ignition is switched on, when combustion engine is running or when electric engine is ready.

Make sure your passengers are aware of the possible risk of accident and injury which may result from improper use of the vehicle.

You must always comply with the specific laws and regulations of the country that you are in. These laws may differ from the information in this Owner's Manual.

Disregarding the description given in this manual may affect your warranty.

When this Owner's Manual refers to a workshop visit, we recommend your Vauxhall Authorised Repairer.

All Vauxhall Authorised Repairers provide first-class service at reasonable prices. Experienced mechanics trained by Vauxhall work according to specific Vauxhall instructions.

The customer literature pack should always be kept ready to hand in the vehicle.

## Using this manual

- This manual describes all options and features available for this model. **Certain descriptions, including those for display and menu functions, may not apply to your vehicle due to model**

**variant, country specifications, special equipment or accessories.**

- The table of contents at the beginning of this manual and within each section shows where the information is located.
- The index will enable you to search for specific information.
- This Owner's Manual depicts left-hand drive vehicles. Operation is similar for right-hand drive vehicles.
- The Owner's Manual uses the engine identifier code. The corresponding sales designation and engineering code can be found in the section "Technical data".
- Directional data, e.g. left or right, or front or back, always relate to the direction of travel.
- Displays may not support your specific language.
- Display messages and interior labelling are written in **bold** letters.

## Danger, Warnings and Cautions

### **⚠ Danger**

Text marked **⚠ Danger** provides information on risk of fatal injury. Disregarding this information may endanger life.

### **⚠ Warning**

Text marked **⚠ Warning** provides information on risk of accident or injury. Disregarding this information may lead to injury.

### **Caution**

Text marked **Caution** provides information on possible damage to the vehicle. Disregarding this information may lead to vehicle damage.

## Symbols

Page references are indicated with ⇨. ⇨ means "see page".

Page references and index entries refer to the indented headings given in the section table of content.

Thank you for choosing a Vauxhall.

We wish you many hours of pleasurable driving.

**Your Vauxhall Team**



## Keys, doors and windows

|                                 |           |
|---------------------------------|-----------|
| <b>Keys, locks</b> .....        | <b>6</b>  |
| Keys .....                      | 6         |
| Radio remote control .....      | 7         |
| Electronic key system .....     | 8         |
| Central locking system .....    | 10        |
| Automatic locking .....         | 15        |
| Child locks .....               | 15        |
| <b>Doors</b> .....              | <b>16</b> |
| Load compartment .....          | 16        |
| <b>Vehicle security</b> .....   | <b>17</b> |
| Anti-theft locking system ..... | 17        |
| Anti-theft alarm system .....   | 18        |
| Immobiliser .....               | 19        |
| <b>Exterior mirrors</b> .....   | <b>20</b> |
| Convex shape .....              | 20        |
| Electric adjustment .....       | 20        |
| Folding mirrors .....           | 20        |
| Heated mirrors .....            | 21        |
| <b>Interior mirrors</b> .....   | <b>22</b> |
| Manual anti-dazzle .....        | 22        |
| Automatic anti-dazzle .....     | 22        |
| <b>Windows</b> .....            | <b>23</b> |
| Windscreen .....                | 23        |

|                          |           |
|--------------------------|-----------|
| Power windows .....      | 23        |
| Heated rear window ..... | 24        |
| Sun visors .....         | 25        |
| <b>Roof</b> .....        | <b>25</b> |
| Glass panel .....        | 25        |

## Keys, locks

### Keys

#### Caution

Do not attach heavy or bulky items to the ignition key.

#### ⚠ Danger

Never remove the key from ignition switch during driving as this will cause, depending on version, steering wheel lock.

### Replacement keys

The key number is specified on a detachable tag.

The key number must be quoted when ordering replacement keys as it is a component of the immobiliser system.

Locks ⇨ 224.

Central locking ⇨ 10.

Starting the engine ⇨ 106.

Radio remote control ⇨ 7.

Electronic key ⇨ 8.

The code number of the adapter for the locking wheel nuts is specified on a card. It must be quoted when ordering a replacement adapter.

Wheel changing ⇨ 216.

### Key with foldaway key section



Press button to extend. To fold the key, first press the button.



### Lock cylinders

Designed to free-wheel if they are forcefully rotated without the correct key or if the correct key is not fully inserted. To reset, insert the correct

key only half way and turn cylinder until its slot is vertical, remove key then re-insert it. If the cylinder still free-wheels, insert the key only half way and turn the key through 180° and repeat operation.

### Radio remote control



-  : unlocks the vehicle
-  : locks the vehicle
-  : long press unlocks and opens the tailgate

Enables operation of the following functions via the use of the remote control buttons:

- central locking system ⇨ 10
- anti-theft locking system ⇨ 17
- anti-theft alarm system ⇨ 18
- tailgate unlocking
- power windows ⇨ 23
- mirrors folding ⇨ 20
- vehicle locator lighting ⇨ 91

The remote control has a range of up to 50 m, but may also be much less due to external influences. The hazard warning flashers confirm operation.

Handle with care, protect from moisture and high temperatures and avoid unnecessary operation.

### Replacing battery in radio remote control

Replace the battery as soon as the system no longer operates properly or the range is reduced.

In the event of a discharged battery,  illuminates in the instrument cluster and a warning message is displayed in the Driver Information Centre.

Driver Information Centre ⇨ 79.



Batteries do not belong in household waste. They must be disposed of at an appropriate recycling collection point.

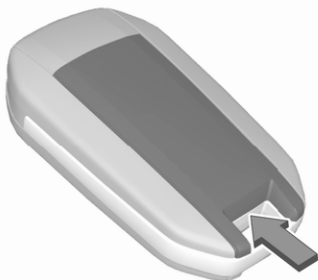

1. Remove the back cover from the remote control.
2. Extract the flat battery from its location.
3. Replace battery with a battery of the same type. Pay attention to the installation position.
4. Clip the back cover in place.

### Fault

If the central locking system cannot be operated with the radio remote control, the cause may be one of the following:

- Fault in radio remote control.
- The battery voltage is too low.
- Overload of the central locking system by operating at frequent intervals, the power supply is interrupted for a short time.
- Interference from higher-power radio waves from other sources.

Manual unlocking ⇨ 10.

## Electronic key system

### Warning

The electronic key can affect a pacemaker.

Keep the electronic key away from the breast.



Enables a keyless operation of the following functions:

- central locking system ⇨ 10
- ignition switching on and starting the engine ⇨ 106

The electronic key simply needs to be on the driver's person.

For reasons of security, the electronic key may be equipped with a motion sensor. If so, starting of the vehicle is not possible when the electronic key has not been moved for a certain time. When trying to start the vehicle, a corresponding message appears in the Driver Information Centre. Move the electronic key and try to start the vehicle again.

Additionally, the electronic key includes the functionality of the radio remote control ↗ 7.

Handle with care, protect from moisture and high temperatures and avoid unnecessary operation.

### Replacing battery in electronic key

Replace the battery as soon as the system no longer operates properly or the range is reduced.

In the event of a discharged battery,  illuminates in the instrument cluster and a warning message is displayed in the Driver Information Centre.

Driver Information Centre ↗ 79.



Batteries do not belong in household waste. They must be disposed of at an appropriate recycling collection point.



1. Remove the back cover.
2. Extract the flat battery from its location.
3. Replace battery with a battery of the same type. Insert the battery by pushing it against the contact

located in the corner and then pressing it down. Pay attention to the installation position.

4. Clip the back cover in place.

### Fault

If the central locking cannot be operated or the engine cannot be started, the cause may be one of the following:

- Fault in electronic key.
- Electronic key is out of reception range.
- The battery voltage is too low.
- Overload of the central locking system by operating at frequent intervals, the power supply is interrupted for a short time.
- Interference from higher-power radio waves from other sources.

To rectify the cause of the fault, change the position of the electronic key.

Manual unlocking ↗ 10.

## Central locking system

Unlocks and locks doors, load compartment and fuel filler flap.

A pull on an interior door handle unlocks and opens the respective door.

When the driver's door only function is activated in the vehicle personalisation settings, only the driver's door unlocks when its interior handle is pulled. When the function is deactivated all doors will be unlocked.

Regardless of the vehicle personalisation setting, all doors will be unlocked when the interior handle of any other door than the driver's door is pulled.

Vehicle personalisation ⇨ 80.

### Notice

In the event of an accident in which airbags or belt pretensioners are deployed, the vehicle is automatically unlocked.

## Remote control operation

### Unlocking





Press .

### Notice

A short time after unlocking the vehicle with the remote control, the doors are locked automatically if no door has been opened.

Unlocking mode can be set in the vehicle personalisation menu in the Info Display. Following settings are selectable:

- All doors, load compartment and fuel filler flap will be unlocked by pressing  once.
- Only the driver's door and fuel filler flap will be unlocked by pressing  once. To additionally unlock all doors and the load compartment, press  twice.

Select the relevant setting in the Vehicle personalisation.

Vehicle personalisation ⇨ 80.

### Locking

Close doors, load compartment and fuel filler flap.





Press .

If the vehicle is not closed properly, the central locking system will not work.



Operation of the central locking system is confirmed by the hazard warning flashers.

### Load compartment



Press and hold  to unlock.

Unlocking settings for the load compartment can be set in the vehicle personalisation:

- Only the load compartment will be unlocked by pressing  once.
- All doors, load compartment and fuel filler flap will be unlocked by pressing  once.

Depending on the chosen setting in the vehicle personalisation, the load compartment can be locked:

- by simply closing the opened tailgate.
- by pressing  once on the remote control with the tailgate closed.

Select the relevant setting in the vehicle personalisation.

Vehicle personalisation ↻ 80.

Unlocking the tailgate ↻ 16.

### Confirmation

Operation of the central locking system is confirmed by the hazard warning flashers.

### Electronic key system operation

The electronic key must be outside the vehicle, within a range of approx. 1 m of the relevant door side.

This system allows automatic vehicle locking and unlocking simply by detection of the electronic key. The electronic key must be outside the vehicle.

**Notice**

If the vehicle is not closed properly or the electronic key remains in the vehicle, locking will not be permitted. If the vehicle is equipped with an anti-theft alarm system, a warning chime sounds after a few seconds.

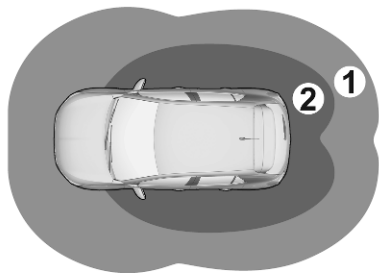

**Notice**

The electronic key may not operate if placed close to electronic devices such as mobile phones or laptop computers.



- Zone 1: automatic locking on leaving the vehicle
- Zone 2: automatic unlocking on approaching the vehicle



**Notice**



If the electronic key remains for more than 15 minutes in zone 1, automatic unlocking is deactivated. Unlock the vehicle by pressing  or  on the remote control or touch the sensor of the driver's door handle to unlock the vehicle. Automatic locking and unlocking is activated again.

**Notice**

A short time after automatic unlocking, the vehicle is relocked if no door has been opened.

**Notice**

If the ignition is switched off for more than 9 days or the vehicle battery has no sufficient charging, the automatic function is disabled. Press  or  on the remote control or touch the sensor of the driver's door handle to unlock the vehicle.

In the event that the ignition is switched off for more than 21 days, the only way to unlock the vehicle is by pressing  or  on the remote control.

**Unlocking / locking**

Unlocking / locking mode can be set in the vehicle personalisation menu in the Info Display. Following settings are selectable:

- Only the driver's door and fuel filler flap will be unlocked / locked.
- All doors, load compartment and fuel filler flap will be unlocked / locked.
- Only the load compartment will be unlocked / locked.

Vehicle personalisation ⇨ 80.

Load compartment ⇨ 16.

### Operation with buttons on the electronic key



The central locking system can also be operated with the buttons on the electronic key.

Press  or  to unlock.

Press  to lock.

Remote control operation ⇨ 10.

### Driver's door handle

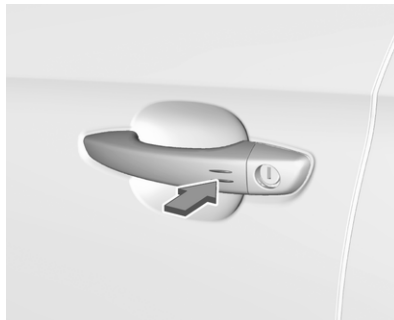

The central locking system can also be operated by touching on the sensor of the driver's door handle.

Touch the sensor of the drivers's door handle to unlock or to lock.

#### Confirmation

Operation of central locking system is confirmed by the hazard warning flashers.

#### Central locking button

Locks or unlocks all doors, the load compartment and fuel filler flap from inside the passenger compartment.



Press  to lock. The LED in the button illuminates.

Press  again to unlock. The LED in the button extinguishes.

### Operation with the key in case of a central locking system fault

In case of a fault, e.g. vehicle battery or remote control / electronic key battery is discharged, the front door can be locked or unlocked with the mechanical key.

### Manual unlocking



Electronic key: push the latch to extract the integral key.

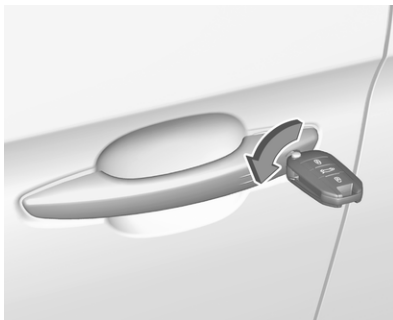

Manually unlock the front door by inserting and turning the key in the lock cylinder.

The other doors can be opened by pulling the interior handle. The load compartment and fuel filler flap will possibly not be unlocked.

By switching on the ignition, the anti-theft locking system is deactivated.

### Manual locking

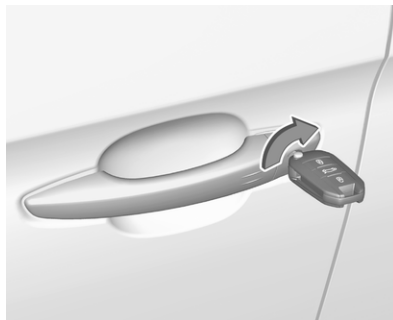

Manually lock the front door by inserting and turning the key in the lock cylinder.

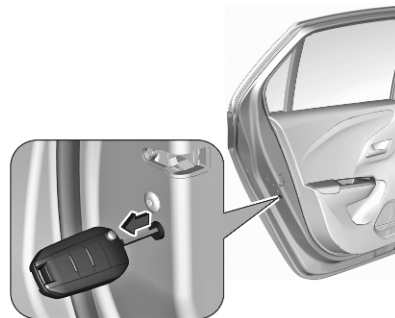

To lock the other doors, remove the black cover by using a key.

Insert key carefully and move it to the inner side of the door without turning the key.

Then, remove key and attach black cover again.

Close the doors.

The fuel filler flap and tailgate are possibly not locked.

## Automatic locking

### Automatic locking after driving off

This system allows automatic locking of the doors and tailgate as soon as the speed of the vehicle exceeds a certain speed.

If one of the doors or the tailgate is open, the automatic central locking does not take place. This is signalled by the sound of the locks rebounding, accompanied by illumination of  in the instrument cluster, an audible signal and the display of an alert message.



This function can be activated or deactivated at any time. With the ignition on, press  until an audible signal starts and a corresponding message is displayed.

The state of the system stays in memory when switching off the ignition.

### Automatic relock after unlocking

This feature automatically relocks the vehicle a short time after unlocking with the remote control or electronic key, provided vehicle has not been opened.

## Child locks

### Warning

Use the child locks whenever children are occupying the rear seats.

## Mechanical child locks

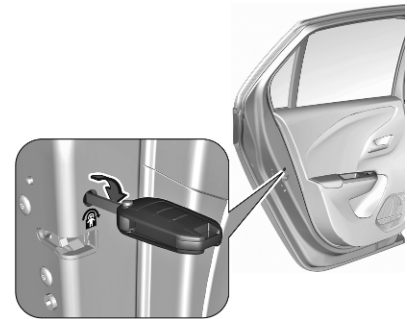

Turn the red child lock in the rear door inwards to the horizontal position by using a key. The door cannot be opened from the inside.

To deactivate, turn the child lock to the vertical position.

## Electric child locks

Remotely operated system to prevent opening of the rear doors via the interior door handles and the use of the rear power windows.

Two versions are available.

## Switching on



Press . The LED in the button is illuminated, accompanied by a confirmation message. This LED remains illuminated until the child lock is switched off again.

Or



Press .

**Switching off**

Press  again. The LED in the button is extinguished, accompanied by a confirmation message.

Or

Press .

Power windows ⇨ 23.

## Doors

## Load compartment

## Tailgate

## Opening

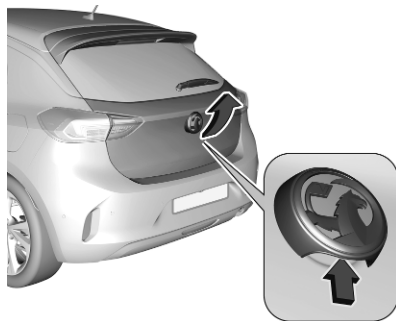

Press the tailgate button below the brand emblem or press long  on the radio remote control and open the tailgate.

## Closing



Use the interior handle.

Do not push the touchpad whilst closing as this will open the tailgate again.

Central locking system ⇨ 10.

## General hints for operating tailgate

### **⚠ Danger**

Do not drive with the tailgate open or ajar, e.g. when transporting bulky objects, since toxic exhaust

gases, which cannot be seen or smelled, could enter the vehicle. This can cause unconsciousness and even death.

### **Caution**

Before opening the tailgate, check overhead obstructions, e.g. a garage door, to avoid damage to the tailgate. Always check the moving area above and behind the tailgate.

### **Notice**

The installation of certain heavy accessories onto the tailgate may affect its ability to remain open.

### **Notice**

At low outside temperatures the tailgate may not open fully by itself. In this case lift the tailgate manually to its normal end position.

## Vehicle security

### Anti-theft locking system

#### **⚠ Warning**

Do not use the system if there are people in the vehicle! The doors cannot be unlocked from the inside.

The system deadlocks all the doors. All doors must be closed otherwise the system cannot be activated.

Unlocking the vehicle disables the mechanical anti-theft locking system. This is not possible with the central locking button.

## Activating



Press  on the radio remote control or touch the sensor of the driver's door handle twice within 3 seconds.

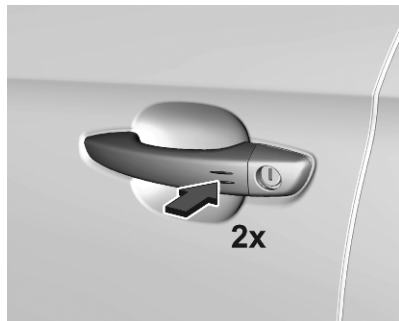

## Anti-theft alarm system

The anti-theft alarm system is combined with the central locking system.

It monitors:

- doors, tailgate, bonnet
- passenger compartment including adjoining load compartment
- ignition

## Activation

All doors, the load compartment and the engine compartment must be closed.

The electronic key must not remain in the vehicle.

The system is self-activated 45 seconds after locking the vehicle.

If a door, the tailgate or the bonnet is not properly closed, the vehicle is not locked. However, the anti-theft alarm is self-activated after 45 seconds.

## Notice

The automatic vehicle locking function does not activate the anti-theft alarm system.

To activate the anti-theft alarm system, lock the vehicle by using the radio remote control or by touching the sensor on the driver's door handle.

Central locking system ⇨ 10.

## Notice



Changes to the vehicle interior such as the use of seat covers and open windows, could impair the function of passenger compartment monitoring.

## Activation without monitoring of passenger compartment





Switch off the monitoring of passenger compartment when animals are being left in the vehicle, because of high volume ultrasonic signals or movements triggering the alarm. Also, switch off when the vehicle is on a ferry or train.

1. Close tailgate, bonnet, windows.
2. Switch off ignition and press  within 10 seconds until the LED in the button  illuminates.
3. Leave the vehicle and close the doors.
4. Activate the anti-theft alarm system.

### Indication

LED in the  button flashes if the anti-theft alarm system is activated. The hazard warning lights illuminate for a few seconds.

### Deactivation

Unlocking the vehicle deactivates the anti-theft alarm system.

The system is not deactivated by unlocking the front door with the key or with the central locking button in the passenger compartment.

### Alarm

When triggered, the alarm siren sounds and the hazard warning lights flash simultaneously. The number and duration of alarm signals are stipulated by legislation.

The anti-theft alarm can be deactivated by pressing  or switching on the ignition.

A triggered alarm, which has not been interrupted by the driver, will be indicated by the LED in the button . The LED will flash quickly the next time the vehicle is unlocked.

If the vehicle battery has been reconnected (e.g. after maintenance work), wait for 10 minutes to restart the engine.

### Fault

If the LED in the button  illuminates permanently when switching on the ignition, seek the assistance of a workshop.

### Locking the vehicle without activation of the anti-theft alarm

Lock the vehicle by locking the front door with the key.

### Immobiliser

The system is part of the ignition switch and checks whether the vehicle is allowed to be started with the key being used.

The immobiliser is activated automatically.

### Notice

Radio Frequency Identification (RFID) tags may cause interference with the key. Do not have it placed near the key when starting the vehicle.

**Notice**

The immobiliser does not lock the doors. Always lock the vehicle after leaving it ↪ 10.

Switch on the anti-theft alarm system ↪ 18.

Emergency operation of electronic key ↪ 104.

**Exterior mirrors****Convex shape**

The shape of the mirror makes objects appear smaller, which will affect the ability to estimate distances.

Side blind spot alert ↪ 159.

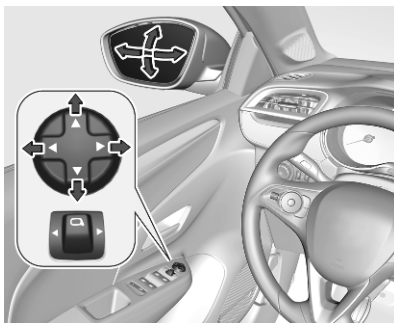
**Electric adjustment**

Select the relevant exterior mirror by pushing  to the left or right.

Then swivel the control to adjust the mirror.

**Folding mirrors**

For pedestrian safety, the exterior mirrors will swing out of their normal mounting position if they are struck with sufficient force. Reposition the mirror by applying slight pressure to the mirror housing.

## Manual electric folding

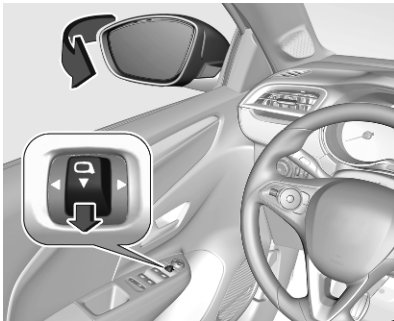

Move  to the centre position.

Pull  rearwards. Both exterior mirrors are folded.

Pull  rearwards again. Both exterior mirrors return to their original position.

If an electrically folded mirror is manually unfolded, pulling  rearwards will only unfold the other mirror electrically.

## Automatic electric folding

When the vehicle is unlocked, the mirrors swing to their normal mounting position. When the vehicle is locked, the mirrors are folded down.

To enable or disable automatic folding of the exterior mirrors, consult a workshop.

## Heated mirrors



Operated by pressing  REAR.

Depending on climate control system,  REAR is located at a different position.

Heating is switched off automatically after a short time.

Heated rear window  24.

## Interior mirrors

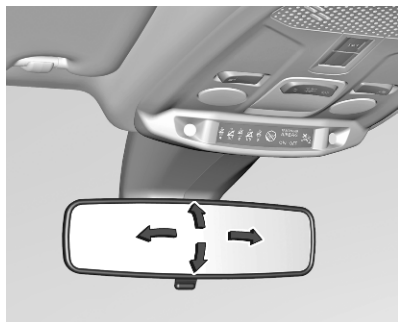

To adjust the mirror, move the mirror housing in the desired direction.

## Manual anti-dazzle



To reduce dazzle, adjust the lever on the underside of the mirror housing.

## Automatic anti-dazzle



Dazzle from following vehicles is automatically reduced, when driving in the dark.

## Windows

### Windscreen

#### Windscreen stickers

Do not attach stickers such as toll road stickers or similar on the windscreen in the area of the interior mirror. Otherwise the detection zone of the sensor and the view area of the camera in the mirror housing could be restricted.

#### Windscreen replacement

##### Caution

If the vehicle has a front-looking camera sensor for the driver assistance systems, it is very important that any windscreen replacement is performed accurately according to Vauxhall specifications. Otherwise, these systems may not work properly and there is a risk of unexpected behaviour and / or messages from these systems.

### Power windows

##### ⚠ Warning

Take care when operating the power windows. Risk of injury, particularly to children.

If there are children on the rear seats, switch on the child safety system for the power windows.

Keep a close watch on the windows when closing them. Ensure that nothing becomes trapped in them as they move.

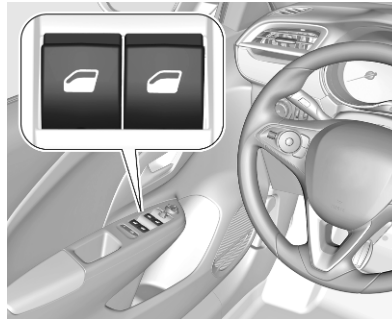

Operate the switch for the respective window by pushing to open or pulling to close.

Pushing or pulling gently to the first detent: window moves up or down as long as the switch is operated.



Pushing or pulling firmly to the second detent then releasing: window moves up or down automatically with safety function enabled. To stop movement, operate the switch once more in the same direction.

#### Safety function

If the window glass encounters resistance of the window during automatic closing, it is immediately stopped and opened again.

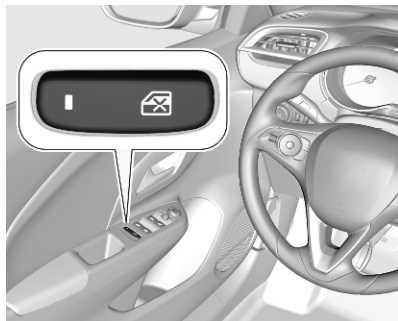
## Child safety system for rear windows





Press  to deactivate rear door power windows; the LED illuminates. To activate, press  again.

Depending on version, additionally operation of electric child locks ⇨ 15.

## Closing windows from outside

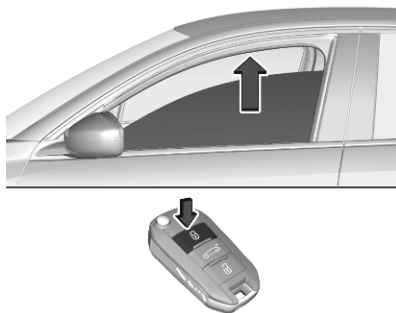
The windows can be closed remotely from outside the vehicle.



Press and hold  to close windows. If the windows are fully closed, the hazard warning lights will flash twice.

## Overload

If the windows are repeatedly operated within short intervals, the window operation is disabled for some time.

## Initialising the power windows

Activate the window electronics as follows:

1. Close doors.
2. Switch on ignition.

3. Open the window completely by using the switch.
4. Pull the switch repeatedly until the window is completely closed and keep pulling for additional 1 second. Note that the window closes only a few centimetres after each pull of the switch.
5. Repeat for each window.

## Heated rear window



Operated by pressing  REAR.

Depending on climate control system,  REAR is located at a different position.

Heating is switched off automatically after a short time.

Heated mirrors ⇨ 21.

## Sun visors

The sun visors can be folded down or swivelled to the side to prevent dazzling.

If the sun visors have integral mirrors, the mirror covers should be closed when driving.

A ticket holder is located on the backside of the sun visor.

## Roof

### Glass panel

### Sunblind

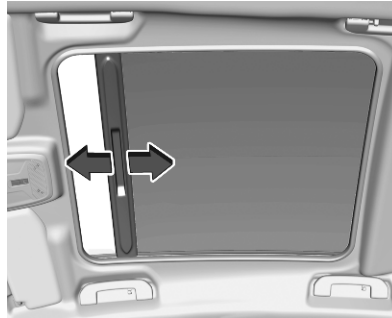

The sunblind is operated manually.  
Slide the sunblind to the desired position.

## Seats, restraints

|                                                 |           |
|-------------------------------------------------|-----------|
| <b>Head restraints</b> .....                    | <b>26</b> |
| <b>Front seats</b> .....                        | <b>27</b> |
| Seat position .....                             | 27        |
| Manual seat adjustment .....                    | 28        |
| Power seat adjustment .....                     | 29        |
| Armrest .....                                   | 30        |
| Heating .....                                   | 30        |
| Massage .....                                   | 31        |
| <b>Seat belts</b> .....                         | <b>31</b> |
| Three-point seat belt .....                     | 32        |
| <b>Airbag system</b> .....                      | <b>33</b> |
| Front airbag system .....                       | 37        |
| Side airbag system .....                        | 37        |
| Curtain airbag system .....                     | 38        |
| Airbag deactivation .....                       | 38        |
| <b>Child restraints</b> .....                   | <b>39</b> |
| Child restraint systems .....                   | 39        |
| Child restraint installation<br>locations ..... | 43        |

## Head restraints

### Position

#### ⚠ Warning

Only drive with the head restraint set to the proper position.

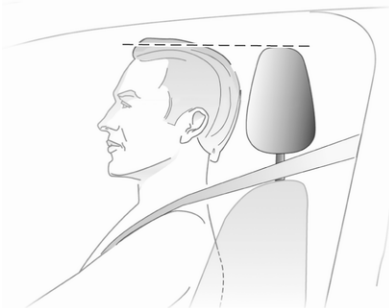

The upper edge of the head restraint should be at upper head level. If this is not possible for extremely tall people, set to highest position, and set to lowest position for small people.

## Height adjustment

### Head restraints on front seats

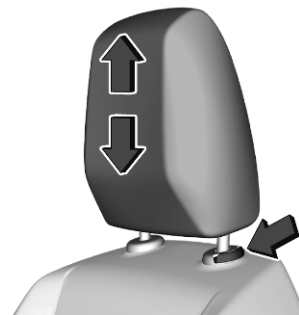

Pull the head restraint upwards or press the catch to release and push the head restraint downwards.



### Head restraints on rear seats

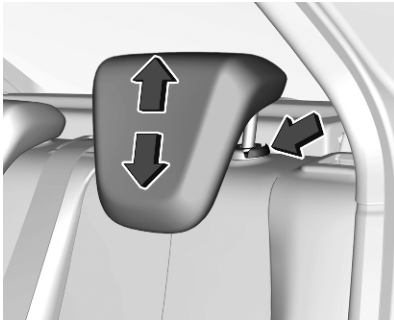

Pull the head restraint upwards or press the catch to release and push the head restraint downwards.

#### Removal

Press catch, pull the respective head restraint upwards and remove.

## Front seats

### Seat position

#### ⚠ Warning

Only drive with the seat correctly adjusted.

#### ⚠ Warning

Never adjust seats while driving as they could move uncontrollably.

#### ⚠ Danger

Do not sit closer than 25 cm to the steering wheel, to permit safe airbag deployment.

#### ⚠ Warning

Never store any objects under the seats.



- Sit with buttocks as far back against the backrest as possible. Adjust the distance between the seat and the pedals so that legs are slightly angled when pressing the pedals. Slide the front passenger seat as far back as possible.
- Set seat height high enough to have a clear field of vision on all sides and of all display instruments. There should be at least one hand of clearance between head and the roof frame. Your thighs should rest lightly on the seat without pressing into it.

- Adjust the head restraint so that its upper edge is at upper head level.
- Sit with shoulders as far back against the backrest as possible. Set the backrest rake so that it is possible to easily reach the steering wheel with arms slightly bent. Maintain contact between shoulders and the backrest when turning the steering wheel. Do not angle the backrest too far back. We recommend a maximum rake of approx. 25°.
- Adjust seat and steering wheel in a way that the wrist rests on top of the steering wheel while the arm is fully extended and shoulders are on the backrest.
- Adjust the lumbar support so that it supports the natural shape of the spine.

Head restraint adjustment ⇨ 26.

Steering wheel adjustment ⇨ 54.

## Manual seat adjustment

Drive only with engaged seats and backrests.

### Longitudinal adjustment



Pull handle, slide seat, release handle. Try to move the seat back and forth to ensure that the seat is locked in place.

### Backrest inclination



Turn handwheel. Do not lean on backrest when adjusting.

## Seat height



Lever pumping motion  
 up : seat higher  
 down : seat lower

## Power seat adjustment

### ⚠ Warning

Care must be taken when operating the power seats. There is a risk of injury, particularly for children. Objects could become trapped.

Keep a close watch on the seats when adjusting them. Vehicle passengers should be informed accordingly.

## Longitudinal adjustment



Move switch forwards / backwards.

## Backrest inclination



Turn switch forwards / backwards.

## Seat height and inclination



Move switch upwards / downwards.

### Lumbar support



Press  or .

 : more lumbar support

 : less lumbar support

### Armrest

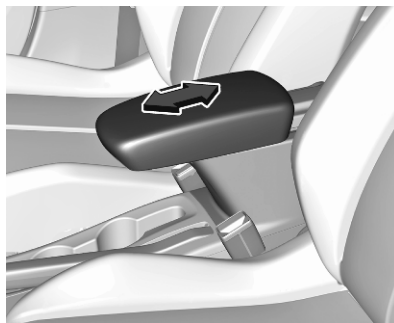

The armrest can be adjusted.

Storage compartment ⇨ 46.

### Heating



Adjust heating to the desired setting by pressing  for the respective seat one or more times. The control indicator in the button indicates the setting.

Prolonged use of the highest setting for people with sensitive skin is not recommended.

Stop-start system ⇨ 107.

## Massage



Activate the back massage function by pressing . The LED in the button illuminates to indicate activation.

The massage function is activated for a period of 1 hour. During this time, massage is performed in six cycles with breaks in between.

Pressing once more deactivates massage function. The LED goes off. Stop-start system ⇨ 107.

## Seat belts



The seat belts are locked during heavy acceleration or deceleration of the vehicle, holding the occupants in the seat position. Therefore the risk of injury is considerably reduced.

### Warning

Fasten seat belt before each trip.

In the event of an accident, people not wearing seat belts endanger their fellow occupants and themselves.

Seat belts are designed to be used by only one person at a time.

Child restraint system ⇨ 39.

Periodically check all parts of the belt system for damage, soiling and proper functionality.

Have damaged components replaced. After an accident, have the seat belts and triggered belt pretensioners replaced by a workshop.

### Notice

Make sure that the belts are not damaged by shoes or sharp-edged objects or are trapped. Prevent dirt from getting into the belt retractors.

### Notice

Use the belt buckle intended for the respective seat belt when fastening in order to ensure proper functionality.

### Seat belt reminder

Each seat is equipped with a seat belt reminder, indicated by a control indicator for the respective seat in the roof console ⇨ 67.

### Belt force limiters



Stress on the body is reduced by the gradual release of the belt during a collision.

### Belt pretensioners

In the event of a head-on, rear-end or side-on collision of a certain severity, the front seat belts and the outer rear seat belts are tightened.

#### ⚠ Warning

Incorrect handling (e.g. removal or fitting of belts) can trigger the belt pretensioners.

Deployment of the belt pretensioners is indicated by continuous illumination of control indicator   68.

Triggered belt pretensioners must be replaced by a workshop. Belt pretensioners can only be triggered once.

#### Notice

Do not affix or install accessories or other objects that may interfere with the operation of the belt

pretensioners. Do not make any modifications to belt pretensioner components as this will invalidate the operating permit of your vehicle.

### Three-point seat belt

#### Fasten

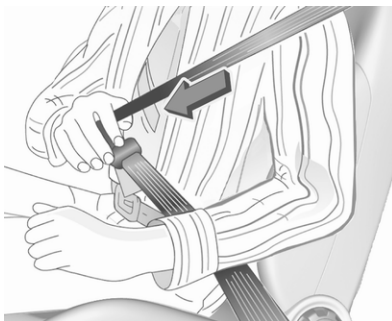

Withdraw the belt from the retractor, guide it untwisted across the body and insert the latch plate into the buckle. Make sure the belt fits tightly to the body while driving.

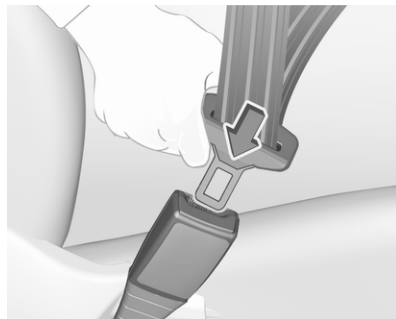

Loose or bulky clothing prevents the belt from fitting snugly. Do not place objects such as handbags or mobile phones between the belt and your body.

#### ⚠ Warning

The belt must not rest against hard or fragile objects in the pockets of your clothing.

Seat belt reminder   67.

## Unfasten

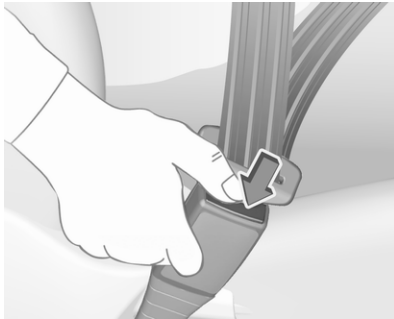

To release belt, press red button on belt buckle.

## Using seat belts while pregnant



### **⚠ Warning**

The lap belt must be positioned as low as possible across the pelvis to prevent pressure on the abdomen.

## Airbag system

The airbag system consists of a number of individual systems.

When triggered, the airbags inflate within milliseconds. They also deflate so quickly that it is often unnoticeable during the collision.

### **⚠ Warning**

The airbag system deploys in an explosive manner, repairs must be performed by skilled personnel only.

### **⚠ Warning**

Adding accessories that change the vehicle's frame, bumper system, height, front end or side sheet metal, may keep the airbag system from working properly. The operation of the airbag system can also be affected by changing any parts of the front seats, seat belts, airbag sensing and diagnostic module, steering wheel,

instrument panel, inner door seals including the speakers, any of the airbag modules, ceiling or pillar trim, front sensors, side impact sensors or airbag wiring.

### ⚠ Warning

Keep the area in which the airbag inflates clear of obstructions.



### Notice

The airbag systems and belt pretensioner control electronics are located in the centre console area. Do not put any magnetic objects in this area.

Do not affix any objects onto the airbag covers and do not cover them with other materials. Have damaged covers replaced by a workshop.

Each airbag is triggered only once. Have deployed airbags replaced by a workshop. Furthermore, it may be necessary to have the steering wheel, the instrument panel, parts of the panelling, the door seals, handles and the seats replaced.

Do not make any modifications to the airbag system as this will invalidate the vehicle operating permit.

Control indicator  for airbag systems  68.

### Child restraint systems on front passenger seat with airbag systems



**EN:** NEVER use a rearward-facing child restraint on a seat protected by an ACTIVE AIRBAG in front of it; DEATH or SERIOUS INJURY to the CHILD can occur.

**DE:** Nach hinten gerichtete Kindersitze NIEMALS auf einem Sitz verwenden, der durch einen davor befindlichen AKTIVEN AIRBAG geschützt ist, da dies den TOD oder SCHWERE VERLETZUNGEN DES KINDES zur Folge haben kann.

**FR:** NE JAMAIS utiliser un siège d'enfant orienté vers l'arrière sur un siège protégé par un COUSSIN GONFLABLE ACTIF placé devant lui, sous peine d'infliger des BLESSURES GRAVES, voire MORTELLES à L'ENFANT.

**ES:** NUNCA utilice un sistema de retención infantil orientado hacia atrás en un asiento protegido por un AIRBAG FRONTAL ACTIVO. Peligro de MUERTE o LESIONES GRAVES para el NIÑO.

**RU:** ЗАПРЕЩАЕТСЯ устанавливать детское удерживающее устройство лицом назад на сиденье автомобиля, оборудованном фронтальной подушкой безопасности, если ПОДУШКА НЕ ОТКЛЮЧЕНА! Это



может привести к СМЕРТИ или СЕРЬЕЗНЫМ ТРАВМАМ РЕБЕНКА.

**NL:** Gebruik NOOIT een achterwaarts gericht kinderzitje op een stoel met een ACTIEVE AIRBAG ervoor, om DODELIJK of ERNSTIG LETSEL van het KIND te voorkomen.

**DA:** Brug ALDRIG en bagudvendt autostol på et forsæde med AKTIV AIRBAG, BARNET kan komme i LIVSFARE eller komme ALVORLIGT TIL SKADE.

**SV:** Använd ALDRIG en bakåtvänd barnstol på ett säte som skyddas med en framförvarande AKTIV AIRBAG. DÖDSFALL eller ALLVARLIGA SKADOR kan drabba BARNET.

**FI:** ÄLÄ KOSKAAN sijoita taaksepäin suunnattua lasten turvaistuinta istuimelle, jonka edessä on AKTIIVINEN TURVATYYNY, LAPSI VOI KUOLLA tai VAMMAUTUA VAKAVASTI.

**NO:** Bakovervendt barnesikringsutstyr må ALDRI brukes på et sete med AKTIV KOLLISJONSPUTE foran, da det kan

føre til at BARNET utsettes for LIVSFARE og fare for ALVORLIGE SKADER.

**PT:** NUNCA use um sistema de retenção para crianças voltado para trás num banco protegido com um AIRBAG ACTIVO na frente do mesmo, poderá ocorrer a PERDA DE VIDA ou FERIMENTOS GRAVES na CRIANÇA.

**IT:** Non usare mai un sistema di sicurezza per bambini rivolto all'indietro su un sedile protetto da AIRBAG ATTIVO di fronte ad esso: pericolo di MORTE o LESIONI GRAVI per il BAMBINO!

**EL:** ΠΟΤΕ μη χρησιμοποιείτε παιδικό κάθισμα ασφαλείας με φορά προς τα πίσω σε κάθισμα που προστατεύεται από μετωπικό ΕΝΕΡΓΟ ΑΕΡΟΣΑΚΟ, διότι το παιδί μπορεί να υποστεί ΘΑΝΑΣΙΜΟ ή ΣΟΒΑΡΟ ΤΡΑΥΜΑΤΙΣΜΟ.

**PL:** NIE WOLNO montować fotelika dziecięcego zwróconego tyłem do kierunku jazdy na fotelu, przed którym znajduje się WŁĄCZONA PODUSZKA POWIETRZNA. Niezastosowanie się do tego

zalecenia może być przyczyną ŚMIERCI lub POWAŻNYCH OBRAŻEŃ u DZIECKA.

**TR:** Arkaya bakan bir çocuk emniyet sistemini KESİNLİKLE önünde bir AKTİF HAVA YASTIĞI ile korunmakta olan bir koltukta kullanmayınız. ÇOCUK ÖLEBİLİR veya AĞIR ŞEKİLDE YARALANABİLİR.

**UK:** НІКОЛІ не використовуйте систему безпеки для дітей, що встановлюється обличчям назад, на сидінні з УВІМКНЕНОЮ ПОДУШКОЮ БЕЗПЕКИ, інакше це може призвести до СМЕРТІ чи СЕРЬОЗНОГО ТРАВМУВАННЯ ДИТИНИ.

**HU:** SOHA ne használjon hátrafelé néző biztonsági gyerekléssel előlről AKTÍV LÉGZSÁKKAL védett ülésen, mert a GYERMEK HALÁLÁT vagy KOMOLY SÉRÜLÉSÉT okozhatja.

**HR:** NIKADA nemojte koristiti sustav zadržavanja za djecu okrenut prema natrag na sjedalu s AKTIVNIM ZRAČNIM JASTUKOM ispred njega, to bi moglo dovesti do SMRTI ili OZBILJNJIH OZLJEDA za DIJETE.

**SL:** NIKOLI ne nameščajte otroškega varnostnega sedeža, obrnjenega v nasprotni smeri vožnje, na sedež z AKTIVNO ČELNO ZRAČNO BLAZINO, saj pri tem obstaja nevarnost RESNIH ali SMRTNIH POŠKODB za OTROKA.

**SR:** NIKADA ne koristiti bezbednosni sistem za decu u kome su deca okrenuta unazad na sedištu sa AKTIVNIM VAZDUŠNIM JASTUKOM ispred sedišta zato što DETE može da NASTRADA ili da se TEŠKO POVREDI.

**MK:** НИКОГАШ не користете детско седиште свртено наназад на седиште заштитено со АКТИВНО ВОЗДУШНО ПЕРНИЧЕ пред него, затоа што детето може ДА ЗАГИНЕ или да биде ТЕШКО ПОВРЕДЕНО.

**BG:** НИКОГА не използвайте детска седалка, гледаща назад, върху седалка, която е защитена чрез АКТИВНА ВЪЗДУШНА ВЪЗГЛАВНИЦА пред нея - може да се стигне до СМЪРТ или СЕРИОЗНО НАРАНЯВАНЕ на ДЕТЕТО.

**RO:** Nu utilizați NICIODATĂ un scaun pentru copil îndreptat spre partea din spate a mașinii pe un scaun protejat de un AIRBAG ACTIV în fața sa; acest lucru poate duce la DECESUL sau VĂTĂMAREA GRAVĂ a COPILULUI.

**CS:** NIKDY nepoužívejte dětský zádržný systém instalovaný proti směru jízdy na sedadle, které je chráněno před sedadlem AKTIVNÍM AIRBAGEM. Mohlo by dojít k VÁŽNĚMU PORANĚNÍ nebo ÚMRTÍ DÍTĚTE.

**SK:** NIKDY nepoužívajte detskú sedačku otočenú vzad na sedadle chránenom AKTÍVNÝM AIRBAGOM, pretože môže dôjsť k SMRTI alebo VÁŽNÝM ZRANENIAM DIĎAŤA.

**LT:** JOKIU BŪDU nemontuokite atgal atgręžtos vaiko tvirtinimo sistemas sėdynėje, prieš kurią įrengta AKTYVI ORO PAGALVĖ, nes VAIKAS GALI ŽŪTI arba RIMTAI SUSIŽALOTI.

**LV:** NEKĀDĀ GADĪJUMĀ neizmantojiet uz aizmuguri vērstu bērnu sēdekļiņi sēdvietā, kas tiek aizsargāta ar tās priekšā uzstādītu

AKTĪVU DROŠĪBAS SPILVENU, jo pretējā gadījumā BĒRNS var gūt SMAGAS TRAUMAS vai IET BOJĀ.

**ET:** ÄRGE kasutage tahapoole suunatud lapseturvaistet istmel, mille ees on AKTIIVSE TURVAPADJAGA kaitstud iste, sest see võib põhjustada LAPSE SURMA või TÕSISE VIGASTUSE.

**MT:** QATT tuża trażżin għat-tfal li jħares lejn in-naħa ta' wara fuq sit protett b'AIRBAG ATTIV quddiemu; dan jista' jikkawża l-MEWT jew ĠRIEHI SERJI lit-TFAL.

**GA:** Ná húsáid srian sábháilteachta linbh cúil RIAMH ar shuíochán a bhfuil mála aeir ag feidhmiú os a chomhair. Tá baol BÁIS nó GORTÚ DONA don PHÁISTE ag baint leis.

Additionally, for safety reasons a forward-facing child restraint system must only be used subject to the instructions and restrictions in the table ⇨ 43.

The airbag label is located on both sides of the front passenger sun visor.

Airbag deactivation ⇨ 38.

## Front airbag system

The front airbag system consists of one airbag in the steering wheel and one in the instrument panel on the front passenger side. These can be identified by the word **AIRBAG**.

The front airbag system is triggered in the event of a front-end impact of a certain severity. The ignition must be switched on.

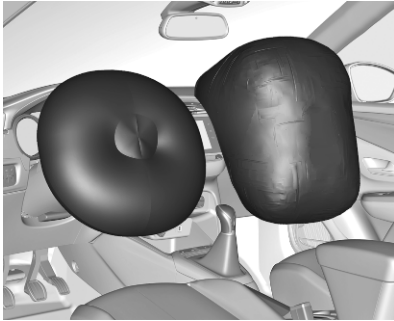

The inflated airbags cushion the impact, thereby reducing the risk of injury to the upper body and head of the front seat occupants considerably.

### ⚠ Warning

Optimum protection is only provided when the seat is in the proper position.

Seat position ⇨ 27.

Fasten the seat belt correctly and engage securely. Only then is the airbag able to protect.

## Side airbag system



The side airbag system consists of an airbag in each front seat backrest. This can be identified by the word **AIRBAG**.

The side airbag system is triggered in the event of a side impact of a certain severity. The ignition must be switched on.



The inflated airbags cushion the impact, thereby reducing the risk of injury to the upper body and pelvis in the event of a side-on collision considerably.

### Notice

Only use protective seat covers that have been approved for the vehicle. Be careful not to cover the airbags.

## Curtain airbag system

The curtain airbag system consists of an airbag in the roof frame on each side. This can be identified by the word **AIRBAG** on the roof pillars.

The curtain airbag system is triggered in the event of a side-on impact of a certain severity. The ignition must be switched on.

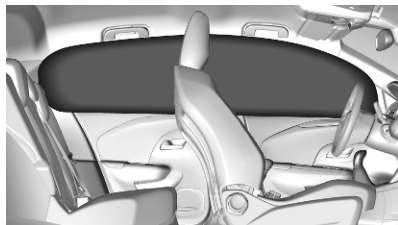

The inflated airbags cushion the impact, thereby reducing the risk of injury to the head in the event of a side-on impact considerably.

### ⚠ Warning

The hooks on the handles in the roof frame are only suitable for hanging up light articles of clothing, without coat hangers. Do not keep any items in these clothes.

## Airbag deactivation



The front passenger airbag system must be deactivated for child restraint system on the passenger seat according to the instructions in the table ↗ 43.

The side airbag and curtain airbag systems, the belt pretensioners and all driver airbag systems will remain active.



The front passenger airbag system can be deactivated via a key-operated switch in the glovebox.

Use the ignition key to choose the position:

- OFF  : front passenger airbag is deactivated and will not inflate in the event of a collision, control indicator OFF  illuminates continuously in the centre console.
- ON  : front passenger airbag is active.

**Notice**

After turning the key-operated switch to position OFF , keep on turning towards this position until key is removed.

**⚠ Danger**

Deactivate passenger airbag only in combination with the use of a child restraint system, subject to the instructions and restrictions in the table ⇨ 43.

Otherwise, there is a risk of fatal injury for a person occupying a seat with a deactivated front passenger airbag.



If the control indicator  illuminates for approx. 60 seconds after the ignition is switched on, the front passenger airbag system will inflate in the event of a collision.

If the control indicator  illuminates after the ignition is switched on, the front passenger airbag system is deactivated. It stays on while the airbag is deactivated.

If both control indicators are illuminated at the same time, there is a system failure. The status of the system is not discernible, therefore no person is allowed to occupy the front passenger seat. Contact a workshop immediately.

Consult a workshop immediately if neither of the two control indicators are illuminated.

Change status only when the vehicle is stopped with the ignition off.

Status remains until the next change.

Control indicator for airbag deactivation ⇨ 68.

**Child restraints****Child restraint systems****⚠ Danger**

Make sure that children below sufficient size and weight are protected using a suitable child restraint system. Never place a child on the lap.

**⚠ Danger**

If using a rear-facing child restraint system on the front passenger seat, the airbag system for the front passenger seat must be deactivated. This also applies to certain forward-facing child restraint systems as indicated in the tables ⇨ 43.

Airbag deactivation ⇨ 38.

Airbag label ⇨ 33.

We recommend a child restraint system which is tailored specifically to the vehicle. For further information, contact your workshop.

In case of any interference of the child restraint system with vehicle seat head restraint, adjust or remove the corresponding head restraint ↗ 26.

When a child restraint system is being used, pay attention to the following usage and installation instructions and also those supplied with the child restraint system. The given restrictions in the table refer to a test body, which is the maximum envelope of all existing child restraint systems. Make sure that the front seats do not interfere with the used child restraint system.

Always comply with local or national regulations. In some countries, the use of child restraint systems is forbidden on certain seats.

Only drive with the driver seat correctly adjusted ↗ 27.

Child restraint systems can be fastened with:

- Three-point seat belt
- ISOFIX brackets
- Top-tether

### Three-point seat belt

Child restraint systems can be fastened by using a three-point seat belt. After fastening the child restraint system the seat belt has to be tightened.

### ISOFIX brackets



Fasten vehicle-approved ISOFIX child restraint systems to the ISOFIX brackets. Specific vehicle ISOFIX child restraint system positions are marked in the ISOFIX table ↗ 43.

ISOFIX brackets are indicated by a label on the backrest. To get access to the ISOFIX brackets, first pull the zipper.

When fastening ISOFIX child restraint systems on adjustable passenger seats, such as the front passenger seat, first incline the backrest as far as necessary backwards in order to get access to the ISOFIX brackets. After the proper fastening of the ISOFIX child restraint system, incline the backrest forward again.

An i-Size child restraint system is an universal ISOFIX child restraint system according UN Regulation No. 129.

All i-Size child restraint systems can be used on any vehicle seat suitable for i-Size, i-Size table ↗ 43.

Either a Top-tether strap or a support leg must be used in addition to the ISOFIX brackets.



i-Size child seats and vehicle seats with i-Size approval are marked with i-Size symbol, see illustration.

### Top-tether anchors

Top-tether anchors are marked with the symbol  for a child seat.



In addition to the ISOFIX brackets, fasten the Top-tether strap to the Top-tether anchors.

ISOFIX child restraint systems of universal category positions are marked in the table by IUF ⇨ 43.

### Selecting the right system

The rear seats are the most convenient location to fasten a child restraint system.

Children should travel facing rearwards in the vehicle as long as possible. This makes sure that the child's backbone, which is still very weak, is under less strain in the event of an accident. Do not use forward facing child restraint system at all seats when child's weight is below 13 kg.

Suitable are child restraint systems that comply with valid UN ECE regulations. Check local laws and regulations for mandatory use of child restraint systems.

The following child restraints are recommended for the following weight classes:

- **Group 0, Group 0+:** Maxi Cosi Cabriofix with or without ISOFIX base for children up to 13 kg
- **Group I:** Duo Plus with ISOFIX and Top-tether for children from 9 kg to 18 kg
- **Group II, Group III:** Kidfix XP with or without ISOFIX for children from 15 kg to 36 kg

Ensure that the child restraint system to be installed is compatible with the vehicle type.

Child seat at the front: Adjust the front passenger seat to the highest and fully back longitudinal position with the backrest straightened.

Child seat at the rear: Move the vehicle's front seat forward and straighten the backrest so that the legs of the child in the forward facing or the rearward facing child seat do not touch the vehicle's front seat.

Do not use forward facing child restraints system when child's weight is below 13 kg at all seats.

Follow child restraint system manufacturer's instructions to install corresponding child restraint systems in vehicle.

For semi-universal or vehicle specific child restraint system (ISOFIX or belted child restraint system), see the vehicle list provided in the user manual of the child restraint system.

Ensure that the mounting location of the child restraint system within the vehicle is correct, see following table.

Allow children to enter and exit the vehicle only on the side facing away from the traffic.

When the child restraint system is not in use, secure the seat with a seat belt or remove it from the vehicle.

**Notice**

Do not affix anything on the child restraint systems and do not cover them with any other materials.

A child restraint system which has been subjected to stress in an accident must be replaced.



## Child restraint installation locations

### Installation of universal, ISOFIX and i-Size child seats

As required by European regulations, this table gives the options for installing child seats secured using the seat belt and universally approved as well as the larger ISOFIX and i-Size child seats on seat positions equipped with ISOFIX mountings in the vehicle.

Yes : Suitable for fitment of the designated category of the child restraint system.

No : Not suitable for fitment of the designated category of the child restraint system.

| Child restraint system categories                                                                  | Front passenger seat with activated airbag ON | Front passenger seat with deactivated airbag OFF | Rear outer seats     | Rear centre seat |
|----------------------------------------------------------------------------------------------------|-----------------------------------------------|--------------------------------------------------|----------------------|------------------|
| Universal belted child restraint system <sup>1)</sup>                                              | Yes <sup>2) 3)</sup>                          | Yes <sup>3) 4)</sup>                             | Yes                  | Yes              |
| i-size child restraint system                                                                      | NO <sup>5)</sup>                              | NO <sup>5)</sup>                                 | Yes                  | NO <sup>5)</sup> |
| Position equipped with a Top-tether fixing                                                         | NO <sup>5)</sup>                              | NO <sup>5)</sup>                                 | Yes                  | NO <sup>5)</sup> |
| Carry-cot (ISOFIX lateral facing child restraint system)<br>ISOFIX child restraint fixture: L1, L2 | NO <sup>5)</sup>                              | NO <sup>5)</sup>                                 | NO                   | NO               |
| ISOFIX rearward facing child restraint system<br>ISOFIX child restraint fixture: R3                | NO <sup>5)</sup>                              | NO <sup>5)</sup>                                 | Yes <sup>6) 7)</sup> | NO <sup>5)</sup> |

## 44 Seats, restraints

| Child restraint system categories                                                  | Front passenger seat with activated airbag ON | Front passenger seat with deactivated airbag OFF | Rear outer seats     | Rear centre seat  |
|------------------------------------------------------------------------------------|-----------------------------------------------|--------------------------------------------------|----------------------|-------------------|
| ISOFIX forward facing child restraint system<br>ISOFIX child restraint fixture: F3 | NO <sup>5)</sup>                              | NO <sup>5)</sup>                                 | Yes <sup>6) 7)</sup> | NO <sup>5)</sup>  |
| Booster seat - full width: B3                                                      | Yes <sup>5) 8)</sup>                          | NO                                               | Yes <sup>6) 7)</sup> | Yes <sup>5)</sup> |

- 1) Universal child seat: child seat that can be installed in all vehicles using the seat belt. Applies to all stature and mass groups.
- 2) Only forward facing child restraint system
- 3) For a seat with height adjustment, set it to the highest and fully back longitudinal position. For a seat without height adjustment, move the seat fully back, with the backrest straightened.
- 4) Only rearward facing child restraint system.
- 5) Seats not fitted with ISOFIX / i-Size compliant mountings.
- 6) Adjust the driver seat ahead of the child restraint system to the longitudinal middle and maximum height position. If necessary, adjust the driver's seat backrest angle. Ensure that inclination angle of the backrest does not exceed the corresponding torso angle of 15°.
- 7) Move the passenger seat ahead of the child restraint system forwards as far as necessary.
- 8) Move the passenger seat fully back.

Size of child restraint fixture (1, 2, 3):

- R1 means rearward facing child restraint fixture for mass group 0 up to 10 kg and mass group 0+ up to 13 kg, age around 0-1 year.
- R2 means reduced size of rearward facing child restraint fixture for mass group 0+ up to 13 kg and mass group 1 from 9 to 18 kg, age around 2-4 years.
- R3 means full size of rearward facing child restraint fixture for mass group 0+ up to 13 kg and mass group 1 from 9 to 18 kg, age around 2-4 years.
- F2, F2X mean reduced height of forward facing child restraint fixture for mass group 1 from 9 to 18 kg, age around 6-7 years.
- F3 means full height of forward facing child restraint fixture for mass group 1 from 9 to 18 kg, age around 7-10 years.

## Storage

|                                   |           |
|-----------------------------------|-----------|
| <b>Storage compartments</b> ..... | <b>45</b> |
| Glovebox .....                    | 45        |
| Cupholders .....                  | 45        |
| Door panel storage .....          | 46        |
| Centre console storage .....      | 46        |
| <b>Load compartment</b> .....     | <b>47</b> |
| Load compartment cover .....      | 48        |
| Rear floor storage cover .....    | 48        |
| Lashing eyes .....                | 49        |
| <b>Roof rack system</b> .....     | <b>49</b> |
| Roof rack .....                   | 49        |
| <b>Loading information</b> .....  | <b>50</b> |

## Storage compartments

### ⚠ Warning

Do not store heavy or sharp objects in the storage compartments.

## Glovebox

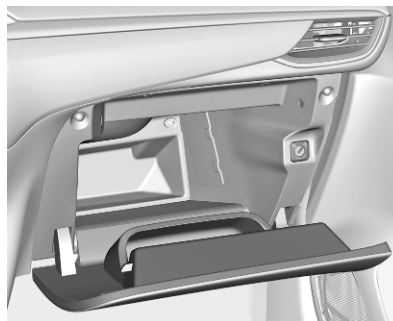

Pull lever to open the glovebox.  
The glovebox should be closed whilst driving.

## Cupholders

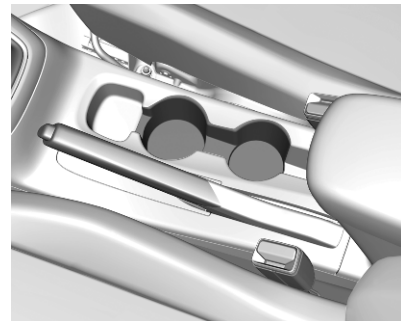

Cupholders are located in the centre console.

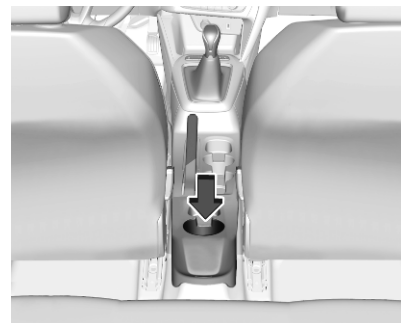

Depending on the version, additional cupholder is located in the centre console.

### Door panel storage

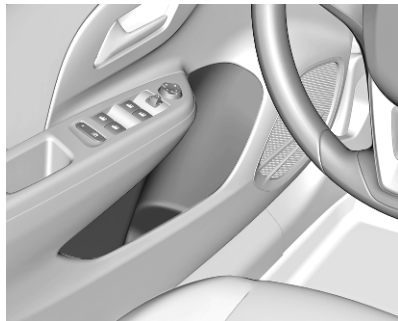

A storage compartment is located in the front and rear door panels.

### Centre console storage

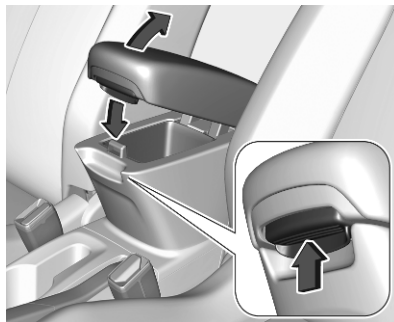

Slide armrest backwards, push button and fold upwards. Under the armrest there is a storage compartment.



A storage compartment is located in the centre console.

## Load compartment

The rear seat backrest is divided into 2/3 to 1/3 parts. Both parts can be folded down individually to increase the size of the load compartment.

Before folding rear seat backrests, execute the following if necessary:

- Move front seats forward if necessary.
- Remove the load compartment cover ↷ 48.
- Press and hold the catch to push the head restraints down ↷ 26.

### Folding down/up rear backrests

- Check that the seat belts are not engaged in the seat belt buckles, so that the backrests can be moved.



- Pull the release lever on one or both outer sides and fold down the backrests onto the seat cushion.
- To fold up, raise the backrests and guide them into an upright position until they engage audibly. Make sure that the belts are positioned correctly and stay clear of the folding area.

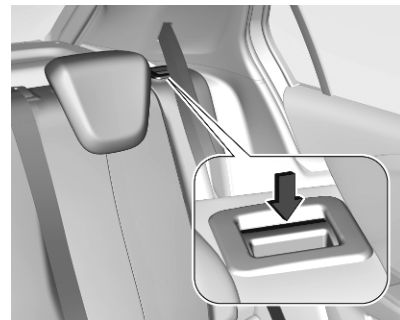

The backrests are properly engaged when the red marks near the release levers are no longer visible.

### **⚠ Warning**

When folding up, ensure that backrests are securely locked in position before driving. Failure to do so may result in personal injury or damage to the load or vehicle in the event of hard braking or a collision.



The seat belt of the centre seat could be blocked when the backrest is folded up too quickly. To unlock the retractor, push in the seat belt or pull it out by approx. 20 mm then release.

### Load compartment cover

Do not place any objects on the cover.

### Removing cover



Unhook retaining straps from tailgate.

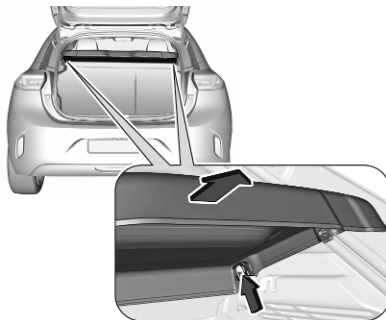

Lift cover at the front and push it upwards at the rear.

Remove the cover.

### Fitting cover

Engage cover in side guides and fold downwards. Attach the retaining straps to the tailgate.

### Rear floor storage cover

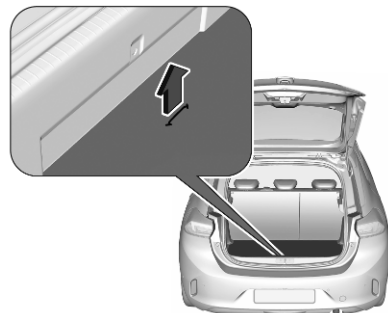

The rear floor cover can be lifted and removed. Use opening to raise the rear floor cover and then remove it.

## Lashing eyes



The lashing eyes are designed to secure items against slippage, e.g. using lashing straps or luggage net.

## Roof rack system

### Roof rack

For safety reasons and to avoid damage to the roof, the vehicle approved roof rack system is recommended. For further information, contact your workshop.



Open all doors.

Mounting points are located in each door frame of the vehicle body.

Fasten the roof rack according to the installation instructions delivered with the roof rack.

Remove the roof rack when not in use.

## Loading information

### ⚠ Warning

Always make sure that the load in the vehicle is securely stowed. Otherwise objects can be thrown around inside the vehicle and cause personal injury or damage to the load or car.



- Heavy objects in the load compartment should be placed against the seat backrests. Make sure that the backrests are

securely engaged. If objects can be stacked, heavier objects should be placed at the bottom.

- Prevent sliding of loose objects by securing them with straps attached to the lashing eyes ⇨ 49.
- Do not allow the load to protrude above the upper edge of the backrests.
- Do not place any objects on the load compartment cover or the instrument panel, and do not cover the sensor on top of the instrument panel.
- The load must not obstruct the operation of the pedals, parking brake and gear selector, or hinder the freedom of movement of the driver. Do not place any unsecured objects in the interior.
- Do not drive with an open load compartment.
- The payload is the difference between the permitted gross vehicle weight (see identification plate ⇨ 233) and the EC kerb weight.

To calculate the payload, enter the data for your vehicle in the weights table at the front of this manual.

The EC kerb weight includes weights for the driver (68 kg), luggage (7 kg) and all fluids (fuel tank 90% full).

Optional equipment and accessories increase the kerb weight.

- Driving with a roof load increases the sensitivity of the vehicle to cross-winds and has a detrimental effect on vehicle handling due to the vehicle's higher centre of gravity. Distribute the load evenly and secure it properly with retaining straps. Adjust the tyre pressure and vehicle speed according to the load conditions. Check and retighten the straps frequently.

Do not drive faster than 75 mph.

The permissible roof load is 70 kg. Do not exceed a loading height of 40 cm. The roof load is the combined weight of the roof rack and the load.



# Instruments and controls

|                                                    |           |
|----------------------------------------------------|-----------|
| <b>Instrument panel overview</b> .....             | <b>52</b> |
| <b>Controls</b> .....                              | <b>54</b> |
| Steering wheel adjustment .....                    | 54        |
| Steering wheel controls .....                      | 54        |
| Heated steering wheel .....                        | 54        |
| Horn .....                                         | 55        |
| Pedestrian safety alert .....                      | 55        |
| Windscreen wiper and washer ..                     | 55        |
| Rear window wiper and washer .....                 | 57        |
| Outside temperature .....                          | 57        |
| Clock .....                                        | 58        |
| Power outlets .....                                | 58        |
| Inductive charging .....                           | 59        |
| <b>Warning lights, gauges and indicators</b> ..... | <b>60</b> |
| Speedometer .....                                  | 60        |
| Odometer .....                                     | 61        |
| Trip odometer .....                                | 61        |
| Tachometer .....                                   | 62        |
| Fuel gauge .....                                   | 63        |
| High voltage battery gauge .....                   | 63        |
| Power indicator gauge .....                        | 63        |

|                                                                |    |
|----------------------------------------------------------------|----|
| Engine coolant temperature gauge .....                         | 64 |
| Engine oil level monitor .....                                 | 64 |
| Service display .....                                          | 64 |
| Control indicators .....                                       | 65 |
| Turn lights .....                                              | 67 |
| Seat belt reminder .....                                       | 67 |
| Airbag and belt tensioners .....                               | 68 |
| Airbag deactivation .....                                      | 68 |
| Charging system .....                                          | 68 |
| Malfunction indicator light .....                              | 68 |
| Service vehicle soon .....                                     | 69 |
| Stop engine .....                                              | 69 |
| System check .....                                             | 69 |
| Brake and clutch system .....                                  | 69 |
| Parking brake .....                                            | 69 |
| Electric parking brake fault .....                             | 70 |
| Automatic operation of electric parking brake off .....        | 70 |
| Antilock brake system (ABS) .....                              | 70 |
| Gear shifting .....                                            | 70 |
| Lane keep assist .....                                         | 70 |
| Advanced lane keep assist .....                                | 71 |
| Parking assist .....                                           | 71 |
| Electronic Stability Control and Traction Control system ..... | 71 |
| Engine coolant temperature .....                               | 71 |
| Preheating .....                                               | 71 |
| Exhaust filter .....                                           | 72 |
| AdBlue .....                                                   | 72 |

|                                      |           |
|--------------------------------------|-----------|
| Deflation detection system .....     | 72        |
| Engine oil pressure .....            | 72        |
| Low fuel .....                       | 73        |
| Charging cable connected .....       | 73        |
| Vehicle ready .....                  | 73        |
| Reduced engine power .....           | 73        |
| Autostop .....                       | 73        |
| Exterior light .....                 | 73        |
| Low beam .....                       | 73        |
| High beam .....                      | 73        |
| High beam assist .....               | 73        |
| Front fog lights .....               | 74        |
| Rear fog light .....                 | 74        |
| Rain sensor .....                    | 74        |
| Pedestrian safety alert fault .....  | 74        |
| Active emergency braking .....       | 74        |
| Door open .....                      | 74        |
| <b>Displays</b> .....                | <b>74</b> |
| Driver Information Centre .....      | 74        |
| Info Display .....                   | 77        |
| <b>Vehicle messages</b> .....        | <b>79</b> |
| Warning chimes .....                 | 79        |
| <b>Vehicle personalisation</b> ..... | <b>80</b> |
| <b>Telematics services</b> .....     | <b>81</b> |
| Emergency call .....                 | 81        |
| Vauxhall Connect .....               | 82        |

## Instrument panel overview

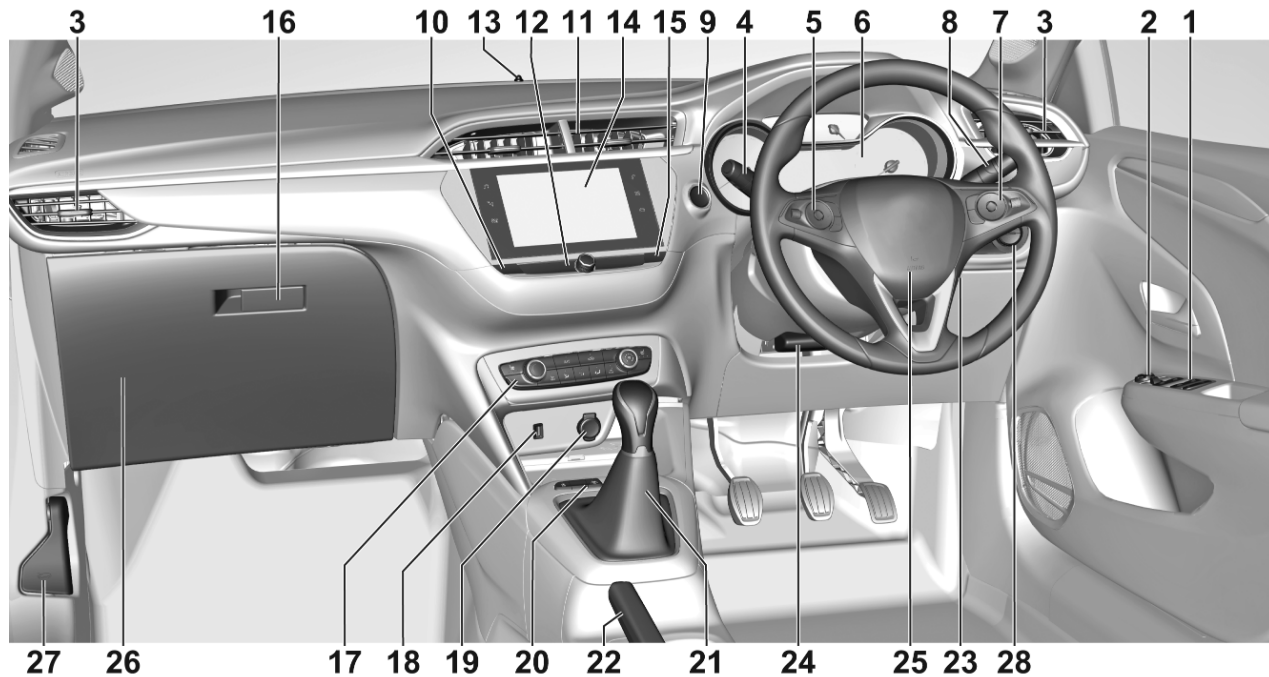

|    |                                                                |     |    |                                             |     |                                        |    |
|----|----------------------------------------------------------------|-----|----|---------------------------------------------|-----|----------------------------------------|----|
| 1  | Power windows .....                                            | 23  | 13 | Anti-theft alarm system<br>status LED ..... | 18  | Front fog lights .....                 | 88 |
| 2  | Exterior mirrors .....                                         | 20  | 14 | Info Display .....                          | 77  | Rear fog light .....                   | 89 |
| 3  | Side air vents .....                                           | 100 | 15 | Hazard warning flashers .....               | 88  | Instrument panel<br>illumination ..... | 90 |
| 4  | Turn lights, headlight<br>flash, low / high beam .....         | 88  | 16 | Glovebox .....                              | 45  |                                        |    |
|    | Parking lights .....                                           | 89  | 17 | Climate control system .....                | 92  |                                        |    |
|    | Buttons for Driver<br>Information Centre .....                 | 74  | 18 | USB port .....                              | 58  |                                        |    |
| 5  | Cruise control .....                                           | 132 | 19 | Power outlet .....                          | 58  |                                        |    |
|    | Speed limiter .....                                            | 135 | 20 | Child locks .....                           | 15  |                                        |    |
|    | Adaptive cruise control .....                                  | 137 |    | Parking assist .....                        | 149 |                                        |    |
|    | Heated steering wheel .....                                    | 54  |    | Lane keep assist .....                      | 166 |                                        |    |
| 6  | Instruments .....                                              | 60  |    | Stop start system .....                     | 107 |                                        |    |
|    | Driver Information Centre .....                                | 74  |    | Sport mode .....                            | 131 |                                        |    |
| 7  | Infotainment controls                                          |     |    | Anti-theft alarm system .....               | 18  |                                        |    |
| 8  | Windscreen wiper and<br>washer, rear wiper and<br>washer ..... | 55  | 21 | Selector .....                              | 119 |                                        |    |
| 9  | Power button .....                                             | 104 | 22 | Parking brake .....                         | 127 |                                        |    |
| 10 | Central locking system .....                                   | 10  | 23 | Ignition switch .....                       | 104 |                                        |    |
| 11 | Centre air vents .....                                         | 100 | 24 | Steering wheel adjustment ..                | 54  |                                        |    |
| 12 | Controls for Info Display<br>operation .....                   | 77  | 25 | Horn .....                                  | 55  |                                        |    |
|    |                                                                |     | 26 | Fuse box .....                              | 205 |                                        |    |
|    |                                                                |     | 27 | Bonnet release lever .....                  | 191 |                                        |    |
|    |                                                                |     | 28 | Light switch .....                          | 83  |                                        |    |
|    |                                                                |     |    | Headlight range<br>adjustment .....         | 85  |                                        |    |

## Controls

### Steering wheel adjustment

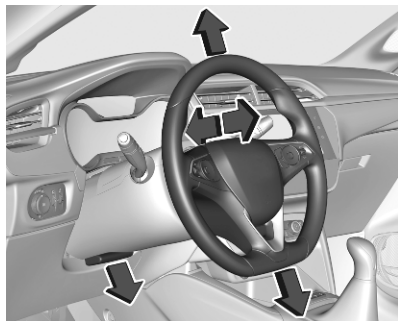

Unlock lever, adjust steering wheel, then engage lever and ensure it is fully locked.

Do not adjust steering wheel unless vehicle is stationary and, depending on version, the steering wheel lock has been released.

### Steering wheel controls

Some driver assistance systems, Infotainment system and a connected mobile phone can be operated via the controls on the steering wheel.



Further information is available in the Infotainment manual.

Cruise control ↗ 132.

Speed limiter ↗ 135.

Adaptive cruise control ↗ 137.

### Heated steering wheel



Activate heating by pressing . Activation is indicated by the LED in the button.

Stop-start system ↗ 107.

## Horn

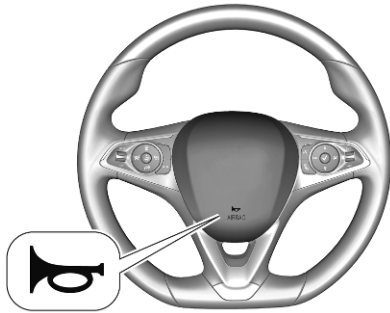

Press .

## Pedestrian safety alert

The sound of the pedestrian safety alert is generated to indicate the vehicle presence to pedestrians. It is active up to 19 mph.

## Windscreen wiper and washer

### Windscreen wiper with adjustable wiper frequency

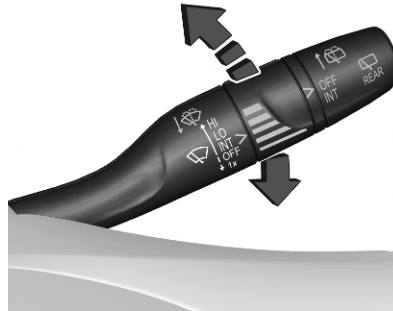

- HI** : fast
- LO** : slow
- INT** : interval wiping
- OFF** : off
- 1x** : single wipe

Do not use if the windscreen is frozen.  
Switch off in car washes.

To activate interval wiping mode the next time ignition is switched on, press the lever downwards to position **OFF** and back to **INT**.

### Adjustable wiper frequency

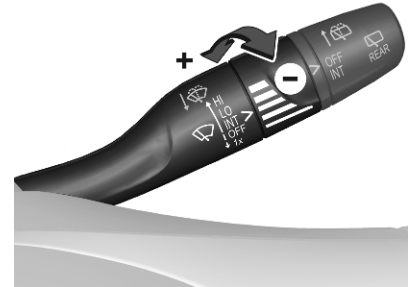

Wiper lever in position **INT**.

Turn the adjuster wheel to adjust the desired wipe frequency.

### Windscreen wiper with rain sensor

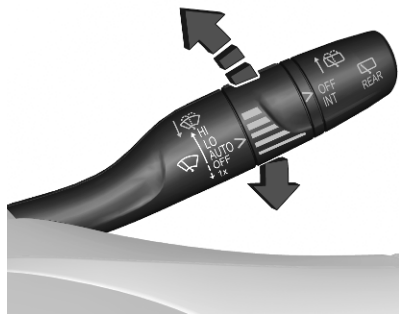

- HI** : fast  
**LO** : slow  
**AUTO** : automatic wiping with rain sensor  
**OFF** : off  
**1x** : single wipe

In **AUTO** position, the rain sensor detects the amount of water on the windscreen and automatically regulates the frequency of the windscreen wiper. If ignition is switched off for more than one minute, automatic wiping mode is deactivated. To activate automatic

wiping mode the next time ignition is switched on, press the lever downwards to position **OFF** and back to **AUTO**.

Do not use if the windscreen is frozen.  
 Switch off in car washes.



Keep the sensor free from dust, dirt and ice.

Control indicator  → 55.

### Adjustable sensitivity of the rain sensor

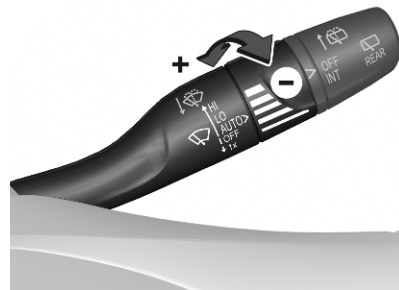

Turn the adjuster wheel to adjust the sensitivity.

## Windscreen washer



Pull lever. Washer fluid is sprayed onto the windscreen and the wiper wipes a few times.

Washer fluid ⇨ 193.

## Rear window wiper and washer

### Rear window wiper



**OFF** : off  
**INT** : intermittent operation

Do not use if the rear window is frozen.

Switch off in car washes.

The rear window wiper comes on automatically when the windscreen wiper is switched on and reverse gear is engaged.

Activation or deactivation of this function can be changed in the Vehicle personalisation menu ⇨ 80.

### Rear window washer

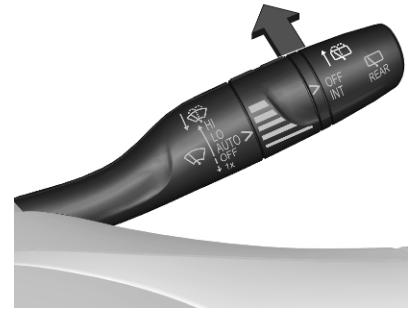

Push lever.

Washer fluid is sprayed onto the rear window and the wiper wipes a few times.

Washer fluid ⇨ 193.

## Outside temperature

A drop in temperature is indicated immediately and a rise in temperature after a time delay.



Illustration shows an example. If outside temperature drops to a certain temperature, a warning message is displayed in the Driver Information Centre.

### **⚠ Warning**

The road surface may already be icy even though the display indicates a few degrees above 0 °C.

### **Clock**

Date and time are shown in the Info Display.

The adjustment of date and time is described in the Infotainment Manual.

### **Power outlets**



Do not exceed the maximum power consumption of 120 W.

The 12 V power outlet is deactivated in the event of low vehicle battery voltage.

Electrical accessories that are connected must comply with the electromagnetic compatibility requirements laid down in DIN VDE 40 839.

Do not connect any current-delivering accessories, e.g. electrical charging devices or batteries.

Do not damage the outlet by using unsuitable plugs.

Stop-start system ↪ 107.

### **USB ports**



The USB port provides 5 V.





Location depends on Infotainment system.

#### Notice

The sockets must always be kept clean and dry.

#### Rear USB ports

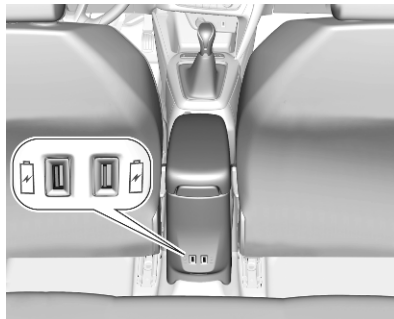

The slot below the USB ports on the rear side of the storage container is intended to attach an accessory cupholder.

#### Inductive charging

##### ⚠ Warning

Inductive charging can affect the operation of implanted pacemakers or other medical devices. If applicable, seek medical advice before using the inductive charging device.

##### ⚠ Warning

Remove any metal objects from the charging device before charging a mobile device, as these objects could become very hot.

To charge a mobile device:

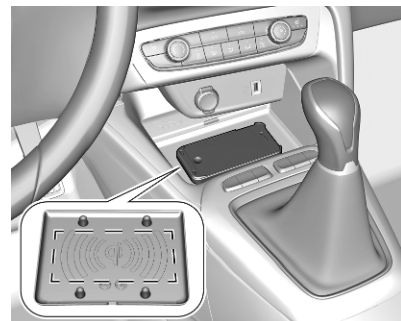

1. Remove all objects from the charging device.
2. Place the mobile device with the display facing upwards on the charging area. Note that the mobile device must be placed between the positioning aids.

Qi compatible mobile devices can be charged inductively.

On some mobile devices, a back cover with an integrated coil or a jacket may be required to use inductive charging.

Protective cover for the mobile device could have impact on the inductive charging.

In the event that the mobile device is not charging properly, rotate it 180° and place it on the charging device again.

### Status LED

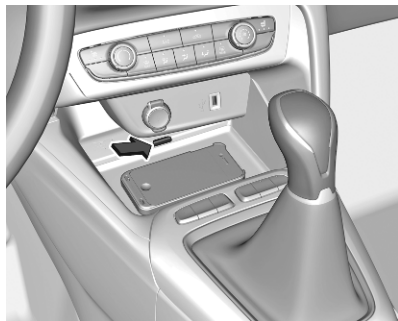

The LED indicates the current charging status.

#### **Illuminates green**

The mobile device is charging.

#### **Flashes yellow**

The mobile device has not been centred properly in the charging zone or an unknown object has been detected in the charging zone.

#### **Illuminates yellow**

There is a problem with the mobile device's battery or a fault of the inductive charger has been detected.

If the problem persists, seek the assistance of a workshop.

## Warning lights, gauges and indicators

### Speedometer

#### Midlevel instrument cluster



## Uplevel instrument cluster



Indicates vehicle speed.

## Odometer

The total recorded distance is displayed in miles.

## Midlevel instrument cluster

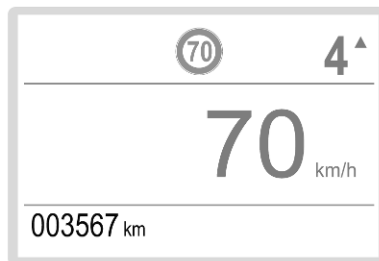

## Uplevel instrument cluster

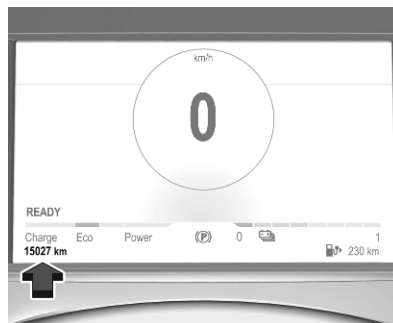

## Trip odometer

## Midlevel instrument cluster

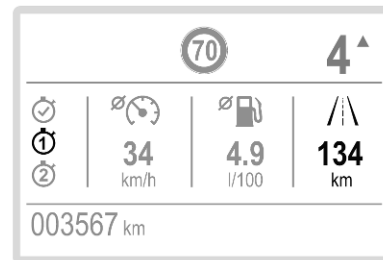

## Uplevel instrument cluster



The recorded distance since the last reset is displayed.

Two trip odometer pages are selectable in the trip / fuel information menu for different trips.

Trip odometer counts up to 9,999 miles.



Press **SET / CLR** for 2 seconds to reset the trip odometer.

Driver Information Centre ↗ 74.

## Tachometer

### Midlevel instrument cluster

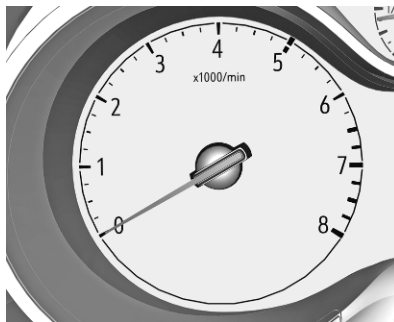

### Uplevel instrument cluster

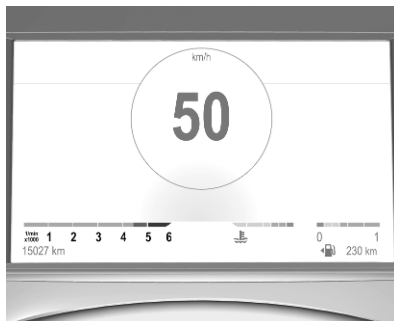

Displays the engine speed.

Drive in a low engine speed range for each gear as much as possible.

A red marker indicates the beginning of the warning zone of excessive revolutions. For Diesel engines, the warning zone starts at 5000 revolutions per minute. For petrol engines, the warning zone starts at 6500 revolutions per minute.

### Caution

If the indicator is in the red warning zone, the maximum permitted engine speed is exceeded. The engine can be damaged.

## Fuel gauge

### Midlevel instrument cluster



### Uplevel instrument cluster

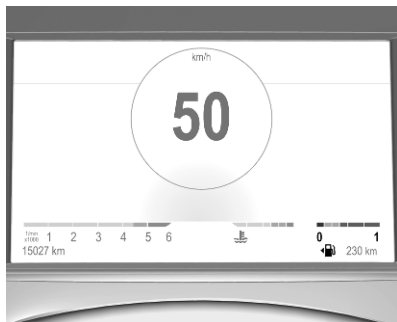

Control indicator ● or  illuminates yellow if the fuel level is low.

Never run the fuel tank dry.

The top-up quantity may be less than the specified fuel tank capacity, due to the remaining fuel in the tank.

## High voltage battery gauge

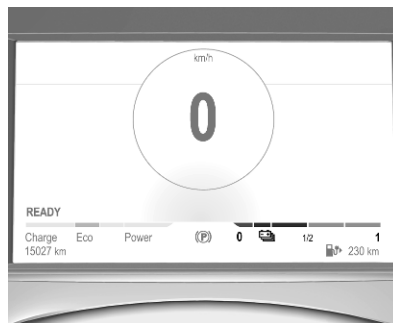

Displays the high voltage battery state of charge.

## Power indicator gauge

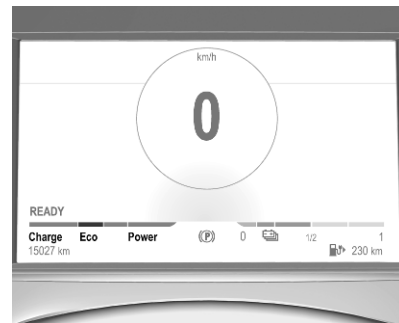

The power indicator gauge informs about the current energy situation of the vehicle.

**Charge** : Battery is being charged with energy resulting from braking or deceleration of the vehicle

**Eco** : An optimum in energy is accessible in all driving modes

**Power** : Vehicle is driven in a dynamic driving style with focus on performance

## Engine coolant temperature gauge

### Midlevel instrument cluster

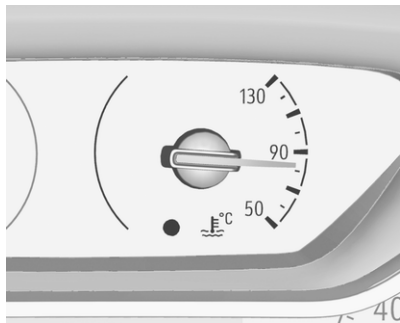

### Uplevel instrument cluster

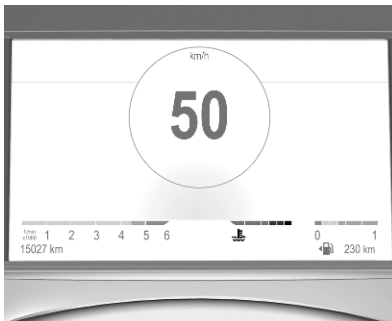

Displays the coolant temperature.

The red zone indicates that the operating temperature of the engine is too high.

Control indicator ● or  illuminates red if coolant temperature is too high.



### Caution

If engine coolant temperature is too high, stop vehicle, switch off engine. Danger to engine. Check coolant level.

## Engine oil level monitor

The state of the engine oil level is displayed in the Driver Information Centre for a few seconds following the service information after switching on the ignition.

A proper state of engine oil level is indicated by a message.

If engine oil level is low,  flashes and a message is indicated, accompanied by the  indicator. Confirm engine oil level by using the dipstick and top up engine oil respectively.

Engine oil ⇨ 191.

A fault of measurement is indicated by a message. Check engine oil level manually by using the dipstick.

## Service display

The service system informs when to change the engine oil and filter or a vehicle service is required. Based on driving conditions, the interval at which an engine oil and filter change are required can vary considerably.

Service information ⇨ 228.

A required service due is displayed in the Driver Information Centre for several seconds after switching on the ignition.

If no service is required for the next 1800 miles or more, no service information appears in the display.

If service is required within the next 1800 miles, the remaining distance to the next service due, the distance travelled since the last service due or the time period that remains to the next service due is indicated for several seconds. Simultaneously symbol  illuminates temporary as reminder.

If service is required in less than 600 miles, the remaining distance to the next service due, the distance travelled since the last service due or the time period that remains to the next service due is indicated for several seconds. Simultaneously  illuminates permanently as reminder.

Overdue service is indicated by a message in the Driver Information Centre which indicates the overdue

distance.  flashes and then illuminates permanently until service is executed.

### Reset of service interval

After each service, the service indicator must be reset to ensure proper functionality. It is recommended to seek the assistance of a workshop.

If service is executed by yourself, operate as following:

- switch off ignition



- press and hold **SET / CLR**

- switch on ignition, the distance indication begins a countdown
- when the display indicates =0, release **SET / CLR**

The symbol  disappears.

### Retrieving service information

The status of the service information can be retrieved at any time via the Info Display. Press **Check** in the vehicle settings menu. The service information is displayed for a few seconds.

Info Display ⇨ 77.

Service information ⇨ 228.

### Control indicators

The control indicators described are not present in all vehicles. The description applies to all instrument versions. Depending on the equipment, the position of the control indicators may vary. When the ignition is switched on, most control indicators will illuminate briefly as a functionality test.

The control indicator colours mean:

- red : danger, important reminder
- yellow : warning, information, fault
- green : confirmation of activation
- blue : confirmation of activation
- white : confirmation of activation
- grey : system paused, at least one system limitation has been detected

Control indicators are located in the Driver Information Centre.









Driver Information Centre ⇨ 74.











### Overview

The numbers in the overview table indicate what to do, when a control indicator illuminates or flashes.















- 1 : only for information
- 2 : information and warning
- 3 : seek the assistance of a workshop
- 4 : stop engine and seek the assistance of a workshop





- 5 : have the cause of the fault remedied immediately by a workshop
- 6 : stop vehicle, do not continue the journey and seek the assistance of a workshop

-  1 Turn lights ⇨ 67
-  2 Seat belt reminder ⇨ 67
-  5 Airbag and belt tensioners ⇨ 68
-  1 Airbag deactivation ⇨ 68
-  4 Charging system ⇨ 68
-  5 Malfunction indicator light ⇨ 68
-  5 Service vehicle soon ⇨ 69
-  4 Stop engine ⇨ 69
-  4 System check ⇨ 69

-  6 Brake and clutch system ⇨ 69
-  1 / Parking brake ⇨ 69
-  2 Automatic operation of electric parking brake off ⇨ 70
-  5 Electric parking brake fault ⇨ 70
-  2 Antilock brake system (ABS) ⇨ 70
-  1 Gear shifting ⇨ 70
-  2 Lane keep assist ⇨ 70
-  2 Advanced lane keep assist ⇨ 71
-  2 Parking assist ⇨ 71
-  2 / 5 Electronic Stability Control and Traction Control system ⇨ 71
-  4 Engine coolant temperature high ⇨ 71



|                                                                                   |       |                                 |
|-----------------------------------------------------------------------------------|-------|---------------------------------|
|  | 1     | Preheating ⇨ 71                 |
|  | 2 / 3 | Exhaust filter ⇨ 72             |
|  | 1     | AdBlue ⇨ 72                     |
|  | 2 / 3 | Deflation detection system ⇨ 72 |
|  | 4     | Engine oil pressure ⇨ 72        |
|  | 2     | Low fuel ⇨ 73                   |
|  | 1     | Autostop ⇨ 73                   |
|  | 1     | Exterior light ⇨ 73             |
|  | 1     | Low beam ⇨ 73                   |
|  | 1     | High beam ⇨ 73                  |
|  | 1     | High beam assist ⇨ 73           |
|  | 1     | Front fog lights ⇨ 74           |
|  | 1     | Rear fog light ⇨ 74             |
|  | 1     | Rain sensor ⇨ 74                |
|  | 2 / 3 | Active emergency braking ⇨ 74   |

|                                                                                   |   |                                    |
|-----------------------------------------------------------------------------------|---|------------------------------------|
|  | 2 | Door open ⇨ 74                     |
|  | 5 | Service vehicle soon ⇨ 69          |
|  | 2 | Charging cable connected ⇨ 73      |
| <b>READY</b>                                                                      | 1 | Vehicle ready ⇨ 73                 |
|  | 2 | Reduced engine power ⇨ 73          |
|  | 3 | Pedestrian safety alert fault ⇨ 74 |

## Turn lights

⇨ ⇨ illuminates or flashes green.

## Illuminates briefly

The parking lights are switched on.

## Flashes

Turn lights or the hazard warning flashers are activated.

Rapid flashing: failure of a turn light or associated fuse.

Bulb replacement ⇨ 198.

Turn lights ⇨ 88.

## Seat belt reminder

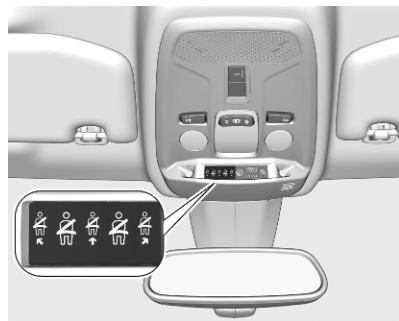

### Seat belt reminder on all seats

 illuminates or flashes red in the instrument cluster together with the indication in the overhead console for each seat belt.



- When the ignition is switched on,  in the instrument cluster and the symbol for the respective seat in the overhead console come on, if a seat belt is not

fastened. The front passenger seat is only displayed when occupied.

- After driving off,  in the instrument cluster and the symbol for the respective seat in the overhead console flash for a certain time together with a chime. After a certain time of driving  illuminates constantly until the seat belt of the respective seat has been fastened or if any passenger has unfastened the seat belt.

Seat belts ⇨ 31.

## Airbag and belt tensioners

 illuminates red.

When the ignition is switched on, the control indicator illuminates for some seconds. If it does not illuminate, does not extinguish after some seconds or illuminates whilst driving, there is a fault in the airbag system. Seek the assistance of a workshop. The airbags and belt pretensioners may fail to trigger in the event of an accident.

Deployment of the belt pretensioners or airbags is indicated by continuous illumination of .

### Warning

Have the cause of the fault remedied immediately by a workshop.

Belt pretensioners ⇨ 31.

Airbag system ⇨ 33.

## Airbag deactivation



 illuminates yellow.

The front passenger airbag is activated.

 illuminates yellow.

The front passenger airbag is deactivated.

Airbag deactivation ⇨ 38.

## Charging system

 illuminates red.

Illuminates when the ignition is switched on and extinguishes shortly after the engine starts.

## Illuminates when the engine is running

Stop, switch off engine. Vehicle battery is not charging. Engine cooling may be interrupted. The brake servo unit may cease to be effective. Seek the assistance of a workshop.

## Malfunction indicator light

 illuminates or flashes yellow.

Illuminates when the ignition is switched on and extinguishes shortly after the engine starts.

### Illuminates when the engine is running

Fault in the emission control system. The permitted emission limits may be exceeded. Seek the assistance of a workshop immediately.

### Flashes when the engine is running

Fault that could lead to catalytic converter damage. Ease up on the accelerator until the flashing stops. Seek the assistance of a workshop immediately.

### Service vehicle soon



/ illuminates yellow.

Illuminates briefly when the ignition is switched on.

May illuminate together with other control indicators and a corresponding message in the Driver Information Centre.

Seek the assistance of a workshop immediately.



Illuminates permanently when the ignition is switched on.

A fault of the electric engine or the high voltage battery has been detected.

Seek the assistance of a workshop immediately.

### Stop engine

illuminates red.

Illuminates briefly when the ignition is switched on.

Illuminates together with other control indicators, accompanied by a warning chime and a corresponding message in the Driver Information Centre.

Stop engine immediately and seek the assistance of a workshop.

### System check

illuminates yellow or red.

### Illuminates yellow

A minor engine fault has been detected.

### Illuminates red

A major engine fault has been detected.

Stop engine as soon as possible and seek the assistance of a workshop.

### Brake and clutch system

illuminates red.

The brake and clutch fluid level is too low.

#### Warning

Stop. Do not continue your journey. Consult a workshop.

Brake fluid ↻ 194.

### Parking brake

illuminates or flashes red.

**Illuminates**

Parking brake is applied ⇨ 127.

**Flashes**

Electric parking brake is not applied automatically. The application or the release are faulty.

**⚠ Warning**

Have the cause of the fault remedied immediately by a workshop.

**Electric parking brake fault**

(P)! illuminates yellow.

**Illuminates**

Electric parking brake has a fault ⇨ 127.

**⚠ Warning**

Have the cause of the fault remedied immediately by a workshop.

**Automatic operation of electric parking brake off**

 illuminates yellow.

**Illuminates**

Automatic operation is deactivated or faulty. In the event of a fault,  illuminates together with other control indicators or it is accompanied by a corresponding message in the Driver Information Centre.

Activate automatic operation again or have the cause remedied by a workshop in the event of a fault.

Automatic operation ⇨ 127.

**Antilock brake system (ABS)**

 illuminates yellow.

Illuminates for a few seconds after the ignition is switched on. The system is ready for operation when the control indicator extinguishes.

If the control indicator does not extinguish after a few seconds, or if it illuminates while driving, there is a

fault in the ABS. The brake system remains operational but without ABS regulation.

Antilock brake system ⇨ 126.

**Gear shifting**

▲ or ▼ with the number of a higher or lower gear is indicated, when upshifting or downshifting is recommended for fuel saving reasons.

On vehicles with automatic transmission, the system is only active in manual mode.

Manual mode ⇨ 122.

**Lane keep assist**

 illuminates or flashes yellow.

**Illuminates yellow**

A fault has been detected.

**Flashes yellow**

The system is correcting the unintended lane change.

Lane keep assist ⇨ 166.

## Advanced lane keep assist

 illuminates grey, green or yellow.

### Illuminates grey

The system is paused. At least one system limitation has been detected.

### Illuminates green

The system is active and ready to operate.

### Illuminates yellow

The system has a fault.

Advanced lane keep assist ⇨ 168.

## Parking assist

 illuminates yellow.

The system has been deactivated.

Additionally, a warning message is displayed in the Driver Information Centre accompanied by a warning chime.

Parking assist ⇨ 149.



## Electronic Stability Control and Traction Control system

 illuminates or flashes yellow.

### Illuminates

A fault in the system is present. Continued driving is possible. Driving stability, however, may deteriorate depending on road surface conditions.

Have the cause of the fault remedied by a workshop.

After reconnecting the vehicle battery, (e.g. after maintenance work),  is illuminated for several seconds. After this time period,  extinguishes. This is a normal procedure, the vehicle does not need any assistance.

### Flashes

The system is actively engaged. Engine output may be reduced and the vehicle may be braked automatically to a small degree.

Electronic Stability Control and Traction Control system ⇨ 130.

## Engine coolant temperature

 or  illuminates red.

### Illuminates when the engine is running

Stop, switch off engine.

#### Caution

Coolant temperature too high.

Check coolant level immediately ⇨ 193.

If there is sufficient coolant, consult a workshop.

## Preheating

 illuminates yellow.

Preheating of diesel engine is activated. Only activates when outside temperature is low. Start the engine when control indicator extinguishes.

Starting the engine ⇨ 106.

## Exhaust filter

 illuminates yellow.

The exhaust filter requires cleaning.

Continue driving until the control indicator extinguishes.

## Illuminates temporarily

Start of saturation of the exhaust filter.

Start cleaning process as soon as possible by driving at a vehicle speed of at least 40 mph.

## Illuminates constantly

Indication of a low additive level. Seek the assistance of a workshop.

Exhaust filter  110.

## AdBlue

 flashes or illuminates yellow.

## Illuminates yellow

The remaining driving range is between 500 miles and 1500 miles.

## Flashes yellow

The remaining driving range is between 0 and 500 miles.

AdBlue level is low. Refill AdBlue soon to avoid prevention of the engine start.

AdBlue  111.

## Deflation detection system

 illuminates or flashes yellow.

## Illuminates

Tyre pressure loss in one or more wheels. Stop immediately and check tyre pressure.

## Flashes

Fault in system. Consult a workshop.

Deflation detection system  210.

## Engine oil pressure

 illuminates red.

Illuminates when the ignition is switched on and extinguishes shortly after the engine starts.

## Illuminates when the engine is running

### Caution

Engine lubrication may be interrupted. This may result in damage to the engine and / or locking of the drive wheels.

1. Select neutral gear.
2. Move out of the flow of traffic as quickly as possible without impeding other vehicles.
3. Switch off ignition.

**⚠ Warning**

When the engine is off, considerably more force is needed to brake and steer. During an Autostop the brake servo unit will still be operational.

Do not remove key until vehicle is stationary, otherwise the steering wheel lock could, depending on version, engage unexpectedly.

Keep engine turned off and let the vehicle be towed to a workshop.

**Low fuel**

● or  illuminates yellow.

Level in fuel tank is too low.

Refuelling ⇨ 182.

Bleeding the diesel fuel system  
⇨ 197.

**Charging cable connected**

 illuminates red.

The vehicle plug of the charging cable is still connected to the charge port. The vehicle cannot be started.

Disconnect the vehicle plug from the charge port and close the charge port flap.

Charging ⇨ 173.

**Vehicle ready**

**READY** illuminates green. The vehicle is ready to be driven.

**Reduced engine power**

 illuminates yellow.

The charging level of the high voltage battery is low. Only reduced engine power is available.

**Autostop**

 illuminates or flashes green.

**Illuminates green**

Engine is in an Autostop.

**Flashes green**

Autostop is temporarily unavailable, or Autostop mode is invoked automatically.

Stop-start system ⇨ 107.

**Exterior light**

 illuminates green.

The exterior lights are on ⇨ 83.

**Low beam**

 illuminates green.

Illuminated when low beam is on.

**High beam**

 illuminates blue.

Illuminates when high beam is on or during headlight flash ⇨ 84.

**High beam assist**

 illuminates green.

The high beam assist is activated  
⇨ 84.

## Front fog lights

 illuminates green.

The front fog lights are on ⇨ 88.

## Rear fog light

 illuminates yellow.

The rear fog light is on ⇨ 89.

## Rain sensor

 illuminates green.

Illuminated when rain sensor position on wiper lever is selected.

Windscreen wiper and washer ⇨ 55.

## Pedestrian safety alert fault

 illuminates yellow.

The pedestrian safety alert is not working.

## Active emergency braking

 illuminates or flashes yellow.

## Illuminates

The system has been deactivated or a fault has been detected.

Additionally, a warning message is displayed in the Driver Information Centre.

Check the reason of the deactivation ⇨ 145 and in case of a system fault, seek the assistance of a workshop.

### Notice

 also illuminates if the seat belts of the front passengers are not fastened. In this case, active emergency braking is deactivated.

## Flashes

The system is actively engaged and brakes automatically the vehicle.

Active emergency braking ⇨ 145.

Forward collision alert ⇨ 144.

Front pedestrian protection ⇨ 148.

## Door open

 illuminates red.

A door or the tailgate is open.

## Displays

### Driver Information Centre

The Driver Information Centre is located in the instrument cluster.

Depending on the version, two instrument clusters are available.

Midlevel instrument cluster

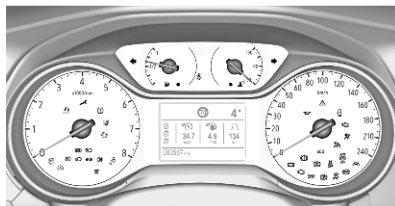

Uplevel instrument cluster



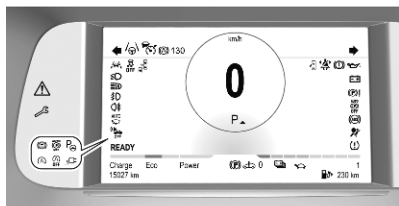

Driver Information Centre indicates:

- overall and trip odometer
- digital speed indication
- trip / autonomy information menu
- gear shift indication
- service information
- vehicle and warning messages
- driver assistance systems
- pop-up messages

### Selecting menus and functions

The menus and functions can be selected via the buttons on the indicator lever.

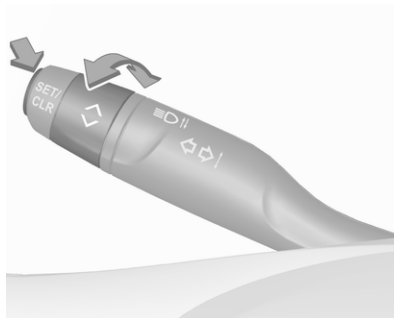

Turn the adjuster wheel to select a page.

Press **SET / CLR** to select, confirm or reset a function.

Vehicle and service messages are popped up in the Driver Information Centre, if required. Scroll messages by turning the adjuster wheel. Confirm messages by pressing **SET / CLR**.

Vehicle messages ⇨ 79.

### Trip / autonomy information menu Midlevel instrument cluster

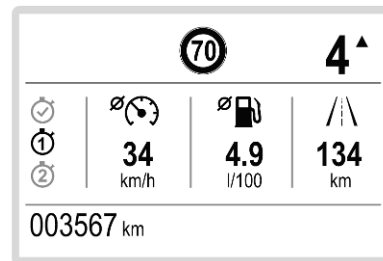

### Uplevel instrument cluster

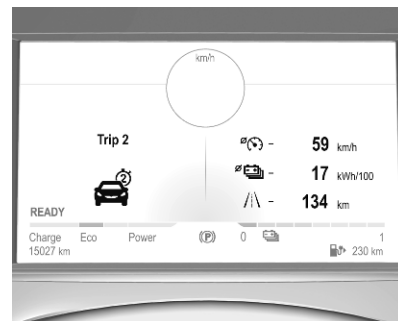

Different pages with combined information can be selected.

Turn the adjuster wheel to select a page.

#### **Information page:**

##### **Fuel range**

Range is calculated from current fuel level and current consumption. The display shows average values.

After refuelling, the range is updated automatically after a brief delay.

When the fuel level is low, a message appears on the display and the control indicator ● or  in the fuel gauge illuminates ⇨ 73.

##### **Instantaneous Fuel Consumption**

Display of the instantaneous consumption.

##### **Electric autonomy**

The electric autonomy is calculated from current charging status of the high voltage battery and current consumption. The display shows average values.

After recharging, the range is updated automatically after a brief delay.

High voltage battery gauge ⇨ 73.

##### **High voltage battery charge level**

The current charge level of the high voltage battery is displayed in percent.

The display shows average values.

After recharging, the high voltage battery charge level is updated automatically after a brief delay.

##### **Autostop time counter**

A time counter calculates the time spent in Autostop during a journey. It resets to zero every time the ignition is switched on.

##### **Trip 1 / Trip 2 page:**

##### **Average speed**

Display of average speed. The measurement can be reset at any time.

##### **Average fuel consumption**

Display of average fuel consumption. The measurement can be reset at any time and starts with a default value.

##### **Average consumption of electric energy**

Display of average consumption of electric energy. The measurement can be reset at any time and starts with a default value.

##### **Distance travelled**

Displays the current distance for the respective trip since the reset.

The values of the respective trip page can be reset by pressing **SET / CLR** for a few seconds.

##### **Personalised view**

Personalised views can be selected by turning the adjuster wheel.

The personalised views can be adjusted in the settings menu in the Info Display.

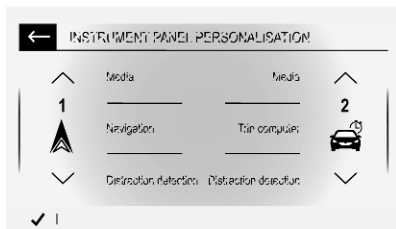

Choose the content, e.g. the navigation map or current trip information, and confirm the settings.

## Info Display



The Info Display can indicate:

- time ↻ 58
- outside temperature ↻ 57
- date ↻ 58
- Infotainment system, see description in the Infotainment Manual
- indication of rear view camera ↻ 164

- indication of panoramic view system ↻ 161
- navigation, see description in the Infotainment Manual
- vehicle and system messages ↻ 79
- settings for vehicle personalisation ↻ 80
- AdBlue range ↻ 111

## Radio (Infotainment system)



Press  to switch on the display.  
Touch  to select system settings (units, language, time and date).

Touch  to select vehicle settings or driving functions.

Confirm a required function or selection by touching.

Touch  on the display to return to the previous page.

## Multimedia / Multimedia Navi / Multimedia Navi Pro



The illustrations show different variants of the infotainment system.



### Selecting menus and settings

There are three options to operate the display:

- via buttons next to the display
- by touching the touchscreen with the finger
- via speech recognition

### Button and touch operation

Press to switch on the display.

Press to select system settings (units, language, time and date).

Press to select vehicle settings or driving functions.

Touch required menu display icon or a function with the finger.

Confirm a required function or selection by touching.

Touch or on the display to exit a menu without changing a setting.

For further information, see Infotainment Manual.

### Speech recognition

Description see Infotainment Manual.

### Flow

#### Notice

On vehicles equipped with the **Multimedia** infotainment system, this menu can only be used via the MyVauxhall App.

This menu displays the current energy flow within the electric system.



1. Press .
2. Select **Flow**.

Different colours show the energy flow.

- green: electric engine operating
- blue: regenerating energy

### Average consumption

#### Notice

On vehicles equipped with the **Multimedia** infotainment system, this menu can only be used via the MyVauxhall App.

This menu displays the average power consumption during the current trip.

- green: electric energy consumed
- blue: electric energy generated from the braking and deceleration phases of the vehicle used to recharge the battery

The current trip is subdivided into time steps. For each time step, the average consumption is displayed. The time steps can be modified.



1. Press .
2. Select **Statistics**.
3. Press + and - to modify the time steps.

Vehicle personalisation ⇨ 80.

## Vehicle messages

Messages are indicated in the Driver Information Centre, in some cases together with a warning chime.

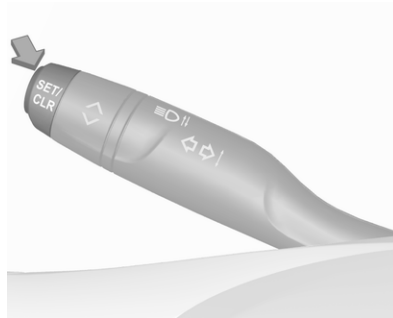

Press **SET / CLR** to confirm a message.

## Vehicle and service messages

The vehicle messages are displayed as text. Follow the instructions given in the messages.

## Messages in the Info Display

Some important messages may appear additionally in the Info Display. Some messages only pop-up for a few seconds.

## Warning chimes

The warning chime regarding not fastened seat belts has priority over any other warning chime.

Whenever a warning chime sounds, pay attention to the messages displayed and the warning lights in the Driver Information Centre.

## When starting the engine or whilst driving

A warning chime will sound when

- a seat belt is not fastened
- a door or the tailgate is not fully closed
- a certain speed is exceeded with parking brake applied
- cruise control deactivates automatically

- a programmed speed or speed limit is exceeded
- a warning message appears in the Driver Information Centre
- the electronic key is not in the passenger compartment
- the parking assist detects an object
- an unintended lane change occurs
- hands-off driving is recognised
- the exhaust filter has reached the maximum filling level

If several warnings appear at the same time, only one warning chime will sound.

### When the vehicle is parked and / or the driver's door is opened

- With exterior lights on.

### During an Autostop

- If the driver's door is opened.
- If any condition for a restart of the engine is not fulfilled.

## Vehicle personalisation

The vehicle's behaviour can be personalised by changing the settings in the Info Display.

Some functions are only displayed or active when the engine is running.

### Radio (Infotainment system)



Touch  to display the vehicle personalisation menu.

Parking, lighting, comfort and safety settings are adjustable.

## Multimedia / Multimedia Navi / Multimedia Navi Pro



The illustrations show different variants of the infotainment system.



Touch  to display the vehicle personalisation menu.

Lighting, comfort and safety settings are adjustable.

## Telematics services

### Emergency call

#### Notice

In order to be available and operational, the system requires functioning vehicle electrics, mobile service and GPS or GLONASS satellite link. Depending on equipment, a backup battery is used.

#### Notice

The service is only available for markets where it is legally required. Furthermore, it depends on the availability of the emergency centres and the infrastructure in the country.

### Status LED in the overhead console

Illuminates green and red and extinguishes after a short time, when the ignition is switched on: the system works properly.

Illuminates red: fault in the system. Contact a workshop.

Flashes red: backup battery needs replacement. Contact a workshop.

### Emergency call

The emergency call function will establish a connection to the nearest public safety answering point (PSAP). A minimum set of data including vehicle and location information will be sent to the PSAP.

In case of an emergency, press the red **SOS** button in the overhead console for more than two seconds. The LED flashes green to confirm that a connection to the nearest PSAP is being established. The LED illuminates steadily as long as the call is active.

Pressing the **SOS** button immediately a second time will terminate the call. The LED switches off.

### Automatic crash notification

In case of an accident with airbag deployment and without damage of needed hardware, an automatic emergency call is established and an automatic crash notification will be transmitted to the next PSAP.

## Vauxhall Connect

Vauxhall Connect comprises multiple connected services accessible via app, online or within the vehicle.

### Notice

Full functionality of

Vauxhall Connect is subject to registration and proper activation.

Connected services may include live navigation such as online traffic information and vehicle status and information such as maintenance alerts.

Services accessible within the vehicle also include emergency call and breakdown call. These functions are automatically activated. Terms and conditions apply.

Emergency call ⇨ 81.

### Breakdown call

Pressing the  button in the overhead console for more than two seconds connects to a roadside assistance service provider.

For information about coverage and scope of services of the roadside assistance, please refer to the Service and warranty booklet.

### Privacy settings

Privacy settings of Vauxhall Connect can be configured. This will impact the set of data being sent, e.g., in case a breakdown call is triggered. The emergency call function will not be impacted.

Depending on version, the privacy settings can be changed by simultaneously pressing  and **SOS** in the overhead console or via the system settings menu in the Info Display.



## Lighting

|                                                |           |
|------------------------------------------------|-----------|
| <b>Exterior lighting</b> .....                 | <b>83</b> |
| Light switch .....                             | 83        |
| Automatic light control .....                  | 84        |
| High beam .....                                | 84        |
| High beam assist .....                         | 84        |
| Headlight flash .....                          | 85        |
| Headlight range adjustment .....               | 85        |
| Headlights when driving<br>abroad .....        | 86        |
| Daytime running lights .....                   | 86        |
| Matrix-LED headlights .....                    | 86        |
| Hazard warning flashers .....                  | 88        |
| Turn lights .....                              | 88        |
| Front fog lights .....                         | 88        |
| Rear fog light .....                           | 89        |
| Parking lights .....                           | 89        |
| Reversing lights .....                         | 89        |
| Misted light covers .....                      | 89        |
| <b>Interior lighting</b> .....                 | <b>90</b> |
| Instrument panel illumination<br>control ..... | 90        |
| Interior lights .....                          | 90        |
| Reading lights .....                           | 90        |
| <b>Lighting features</b> .....                 | <b>91</b> |
| Entry lighting .....                           | 91        |

|                                    |    |
|------------------------------------|----|
| Exit lighting .....                | 91 |
| Vehicle locator lighting .....     | 91 |
| Battery discharge protection ..... | 91 |

## Exterior lighting

### Light switch



Turn light switch:

**AUTO** : automatic light control  
switches automatically  
between daytime running  
light and headlight

☞☞ : sidelights

☞☞☞ : headlights

Control indicator ☞☞☞ 73.

## Automatic light control



When the automatic light control function is switched on, the system switches between daytime running lights and headlights automatically depending on the external lighting conditions and information given by the wiper system.

Daytime running light ⇨ 86.

## Automatic headlight activation

During poor lighting conditions the headlights are switched on.

Additionally, headlights are switched on if the windscreen wipers have been activated for several wipes.

## Tunnel detection

When a tunnel is entered, headlights are switched on immediately.

## High beam



Push to switch from low to high beam.  
Push again to deactivate high beam.

## High beam assist

The system switches from low beam to high beam and vice versa to prevent glaring. Once activated, high beam assist remains active and switches high beam on and off depending on surrounding

conditions. The latest setting of the high beam assist will remain after the ignition is switched on again.

Glare-free high beam for Matrix-LED headlights ⇨ 86.



## Activation

The high beam assist can be activated via the vehicle settings menu in the Info Display.

On vehicles equipped with the Radio infotainment system, it is not possible to alterate the high beam assist settings.

Info Display ⇨ 77.

High beam is switched on automatically in dark surroundings at a speed above 28 mph. High beam is switched off at a speed below 22 mph, but high beam assist remains active.

The green control indicator  illuminates continuously when the high beam assist is activated, the blue  illuminates when high beam is on.

Control indicator  ⇨ 73,  ⇨ 73.

High beam assist switches automatically to low beam when:

- Driving in urban areas.
- Camera detects heavy fog.
- Rear fog light is switched on.
- Oncoming or preceding vehicles are detected by the camera.

If there are no restrictions detected, the system switches back to high beam.

### Deactivation

The system can be deactivated via the vehicle settings menu in the Info Display.

On vehicles equipped with the Radio infotainment system, it is not possible to alterate the high beam assist settings.

Info Display ⇨ 77.

### Headlight flash

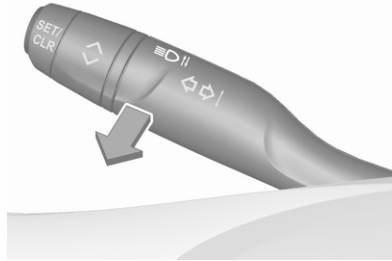

Pull to activate the headlight flash.

### Headlight range adjustment



To adapt headlight range to the vehicle load to prevent dazzling, turn thumb wheel  to required position.

#### Non-electric vehicle

- 0 : front seats occupied
- 1 : all seats occupied
- 2 : all seats occupied and load compartment laden
- 3 : driver's seat occupied and load compartment laden

**Electric vehicle**

- 0 : front seats occupied
- 1 : all seats occupied with or without load compartment laden
- 2 : driver's seat occupied and load compartment laden
- 3 : not used

**Headlights when driving abroad**

When driving in countries where traffic drives on the opposite side of the road, the headlights do not have to be adjusted.

**Daytime running lights**

Daytime running lights increase visibility of the vehicle during daylight.

Automatic light control ⇨ 84.

**Matrix-LED headlights**

The Matrix-LED headlight system contains a variety of particular LEDs in each headlight which enables the control of the adaptive forward lighting functions.

Light distribution and intensity of light are variably triggered depending on the lighting conditions, road type and driving situation. The vehicle adapts the headlights automatically to the situation to enable optimal light performance for the driver.

The adaptive forward lighting and the Matrix-LED headlights functions can be deactivated or activated in the vehicle personalisation menu.

Vehicle personalisation ⇨ 80.

Info Display ⇨ 77.

The glare-free high beam function of the Matrix-LED headlights are only available with light switch in position **AUTO**.

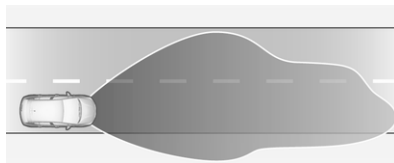
**Country light**

Activated automatically at a speed above 30 mph when driving in rural areas. The illumination of the current

lane and the side of the road is adapted. Oncoming and preceding vehicles are not dazzled.

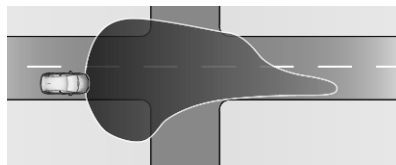
**Town light**

Activated automatically at a speed up to approx. 30 mph. The light is wide and symmetrical.

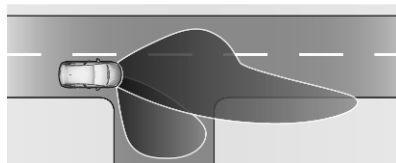
**Cornering light**

Activated at a speed of up to 25 mph when turning off. The light consists of particular LEDs which illuminate the direction of travel. These LEDs are

triggered depending on the steering angle or the activation of the turn lights.

### Curve light

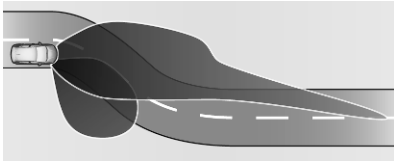

Particular LEDs, based on steering angle and speed, are additionally triggered to improve lighting in curves. This function is activated at speeds from 25 mph to 43 mph.

### Glare-free high beam

#### Warning

The glare-free high beam function may dazzle other road users when the vehicle is driven in countries where traffic moves on the opposite side of the road. E.g. when the vehicle was designed for

left hand drive traffic and it is driven in a country with right hand drive traffic.

Switch off glare-free high beam function whenever you are driving in countries mentioned above!

The system enables a glare-free high beam when driving in dark surroundings.



Each LED on right or left side is triggered or faded out particularly according to the traffic situation. This gives the best light distribution without dazzling other road users.

Glare-free high beam is switched on automatically at a speed above 31 mph. It is switched off at a speed below 22 mph, but the system remains active.

### Motorway mode

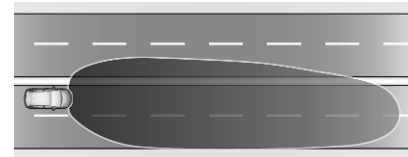

Activated automatically at a speed above 65 mph. Illumination is adapted to the higher speed driven on motorways. If there is no oncoming traffic, the visibility on the side of the vehicle is increased. When following vehicles ahead or passing, dazzling for these vehicles is reduced.

### Fault in LED headlight system

When the system detects a failure in the LED headlight system, it selects a preset position to avoid dazzling of oncoming traffic. A warning is displayed in the Driver Information Centre.

## Hazard warning flashers

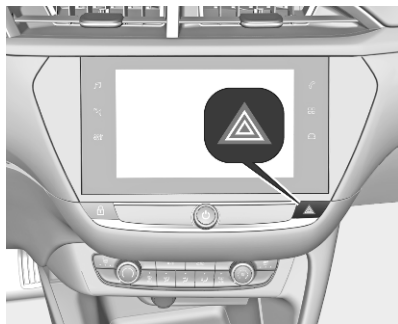

Operated by pressing .

When braking in an emergency, the hazard warning flashers are switched on automatically, depending on the force of deceleration. They are switched off automatically, as soon as the vehicle is accelerated again.

## Turn lights

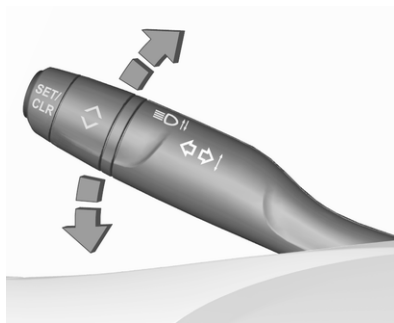

up : right turn lights  
down : left turn lights

A resistance point can be felt when moving the indicator lever.

Constant flashing is activated when the indicator lever is being moved beyond the resistance point. It is deactivated when the steering wheel is moved in the opposite direction or indicator lever is manually moved back to its neutral position.

After 20 seconds the volume of the audible signal will increase if the speed is above 50 mph.

Activate temporary flashing by holding the indicator lever just before the resistance point. Turn lights will flash until indicator lever is being released.

To activate three flashes, tap the indicator lever briefly without passing the resistance point.

## Front fog lights



Operated by pressing .

Light switch in position **AUTO**: switching on front fog lights will switch headlights on automatically.

## Rear fog light



Operated by pressing ☹.

Light switch in position **AUTO**: switching on rear fog light will switch headlights on automatically.

Light switch in position ☹: rear fog light can only be switched on with front fog lights.

The vehicle rear fog light is deactivated when a plug is connected to the power outlet of the trailer hitch.

## Parking lights

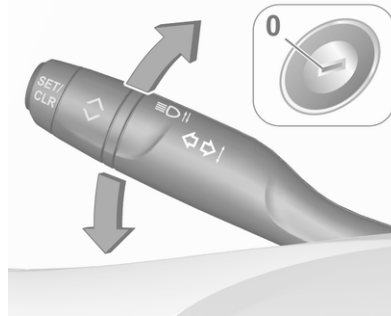

When the vehicle is parked, the parking lights on one side can be activated:

1. Switch off ignition.
2. Move the lever all the way up (right parking lights) or down (left parking lights).

Confirmed by a signal and the corresponding turn lights control indicator.

## Reversing lights

The reversing light comes on when reverse gear is selected.

## Misted light covers

The inside of the light housing may mist up briefly in poor, wet and cold weather conditions, in heavy rain or after washing. The mist disappears quickly by itself. To help, switch on the headlights.

## Interior lighting

### Instrument panel illumination control



Brightness of the following lights can be adjusted when the exterior lights are on:

- instrument panel illumination
- Info Display
- illuminated switches and operation elements

Turn thumb wheel  and hold until the desired brightness is obtained.

## Interior lights

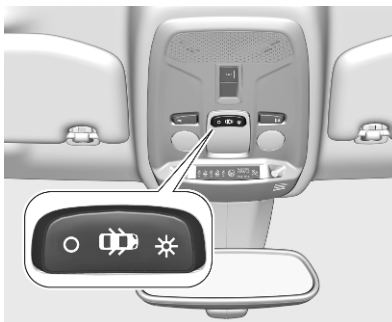

Operate rocker switch:

 : automatic switching on and off

press  : on

press  : off

### Notice

In the event of an accident with airbag deployment the courtesy lights are turned on automatically.

## Reading lights

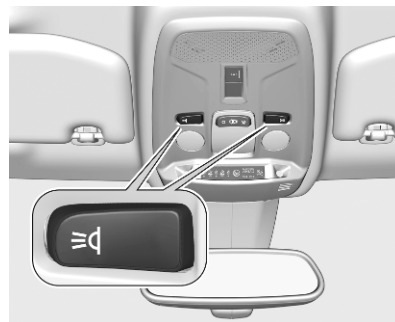

Operated by pressing .



## Lighting features

### Entry lighting

#### Welcome lighting

Some or all of the following lights are switched on for a short time by unlocking the vehicle with the radio remote control:

- headlights
- interior lights

The number of activated lights depends on the surrounding light conditions.

The lighting switches off immediately when the ignition is switched on.

Starting off ⇨ 104.

This function can be activated or deactivated in the vehicle personalisation.

Vehicle personalisation ⇨ 80.

The following lights will additionally switch on when the driver's door is opened:

- illumination of some switches
- Driver Information Centre
- door pocket lights

### Exit lighting

The following lights are switched on when the ignition is switched off:

- headlights
- interior lights
- centre console lighting

They will switch off automatically after a delay. This function works only in the dark.

### Vehicle locator lighting

This function allows to locate the vehicle, e.g., in weak lighting conditions using the remote control. The headlights come on and the turn lights flash for 10 seconds.

Press  on the remote control.

## Battery discharge protection

To prevent discharge of the vehicle battery when the ignition is switched off, some interior lights are switched off automatically after some time.

## Climate control

|                                          |            |
|------------------------------------------|------------|
| <b>Climate control systems</b> .....     | <b>92</b>  |
| Heating and ventilation system .         | 92         |
| Air conditioning system .....            | 93         |
| Electronic climate control system .....  | 95         |
| Auxiliary heater .....                   | 99         |
| Temperature preconditioning ....         | 99         |
| <b>Air vents</b> .....                   | <b>100</b> |
| Adjustable air vents .....               | 100        |
| Fixed air vents .....                    | 101        |
| <b>Maintenance</b> .....                 | <b>101</b> |
| Air intake .....                         | 101        |
| Air conditioning regular operation ..... | 101        |
| Service .....                            | 101        |

## Climate control systems

### Heating and ventilation system



Controls for:

- temperature ( / \ )
- air distribution ( 🌀, 🌀, and 🌀 )
- fan speed ( ⚙ )
- demisting and defrosting ( 🌫 MAX )
- heated rear window and exterior mirrors ( 🌞 REAR )
- heated seats ( 🪑 )

Heated rear window ⇨ 24.

Heated exterior mirrors ⇨ 21.

Heated seats ⇨ 30.

### Temperature

Adjust the temperature by turning ( / \ ) to the desired temperature.

red area : warmer

blue area : colder

Heating will not be fully effective until the engine has reached normal operating temperature.

### Air distribution

🌀 : to windscreen and front door windows

🌀 : to head area via adjustable air vents

🌀 : to foot well and windscreen

All combinations are possible.

### Fan speed

Adjust the air flow by turning ⚙ to the desired speed.

clockwise : increase

anticlockwise : decrease

## Demisting and defrosting



- Press : the air distribution is directed towards the windscreen.
- Set temperature controller to warmest level.
- Set fan speed to highest level.
- Switch on heated rear window REAR.
- Open side air vents as required and direct them towards the door windows.

## Air conditioning system



Controls for:

- temperature
- air distribution , and
- fan speed
- demisting and defrosting
- cooling **A/C**
- air recirculation
- heated rear window and exterior mirrors REAR
- heated seats

Heated rear window ⇨ 24.

Heated exterior mirrors ⇨ 21.

Heated seats ⇨ 30.

Some setting changes are indicated briefly in the Info Display. Activated functions are indicated by the LED in the respective button.

## Temperature

Adjust the temperature by turning to the desired temperature.

red area : warmer  
blue area : colder

Heating will not be fully effective until the engine has reached normal operating temperature.

## Air distribution

: to windscreen and front door windows

: to head area via adjustable air vents

: to foot well and windscreen

All combinations are possible.

## Fan speed

Adjust the air flow by turning to the desired speed.

clockwise : increase

anticlockwise : decrease

## Cooling A/C



Press **A/C** to switch on cooling. The LED in the button illuminates to indicate activation. Cooling is only functional when the engine is running and fan is switched on.

Press **A/C** again to switch off cooling. The air conditioning system cools and dehumidifies (dries) as soon as the outside temperature is slightly above the freezing point. Therefore, condensation may form and drip from under the vehicle.

If no cooling or drying is required, switch off the cooling system for fuel saving reasons.

Activated cooling may inhibit Autostops.

Stop-start system ↗ 107.

## Air recirculation system



Press  to activate air recirculation mode. The LED in the button illuminates to indicate activation.

Press  again to deactivate air recirculation mode.

### ⚠ Warning



The exchange of fresh air is reduced in air recirculation mode. In operation without cooling the air humidity increases, so the windows may mist up from inside. The quality of the passenger compartment air deteriorates, which may cause the vehicle occupants to feel drowsy.

In warm and very humid ambient air conditions, the windscreen may mist up from outside when cold air is directed towards it. If windscreen mists up from outside, activate windscreen wiper and deactivate .

## Maximum cooling



Briefly open the windows so that hot air can disperse quickly.

- Switch on cooling **A/C**.
- Press  for air recirculation system on.
- Press  for air distribution.
- Set temperature control ( / \ ) to coldest level.
- Set fan speed  to highest level.
- Open all vents.

Heated rear window  24.

Heated exterior mirrors  21.



### Demisting and defrosting the windows



- Press  the air distribution is directed towards the windscreen.
- Set temperature controller ( / \ ) to warmest level.
- Switch on cooling **A/C**, if required.

- Switch on heated rear window .
- Open side air vents as required and direct them towards the door windows.

#### Notice

If  is pressed while the engine is running, an Autostop will be inhibited until  is pressed again.

If  is pressed while the engine is in an Autostop, the engine will restart automatically.





Stop-start system  107.

### Electronic climate control system



Controls for:

- temperature ( / \ )
- **MENU** enters the Climate setting menu in the Info Display

- fan speed 
- automatic mode **AUTO**
- cooling **A/C**
- manual air recirculation 
- demisting and defrosting 
- heated rear window and exterior mirrors 
- heated seats 

Heated rear window  24.

Heated exterior mirrors  21.

Heated seats  30.

In automatic mode, temperature, fan speed and air distribution are regulated automatically.





Activated functions are indicated by the LED in the respective control.

The electronic climate control system is only fully operational when the engine is running.

## Climate control settings menu



Press **MENU** to manually set the following climate control functions:

- air distribution ,  and 
- fan speed 
- temperature ( / \ )
- cooling **A/C**
- automatic mode **AUTO**

Climate setting menu can also be displayed in the Info Display.

Info Display ⇨ 77.

## Automatic mode AUTO



Basic setting for maximum comfort:

- Press **AUTO**, the air distribution and fan speed are regulated automatically.
- Open all air vents to allow optimised air distribution in automatic mode.
- Air conditioning must be activated for optimal cooling and demisting. Press **A/C** to switch on air conditioning. The LED in the button indicates activation.
- Set the preselected temperature using the left or right rotary knob. Recommended temperature is 22 °C.

## Manual settings

Climate control system settings can be changed by activating the following functions:

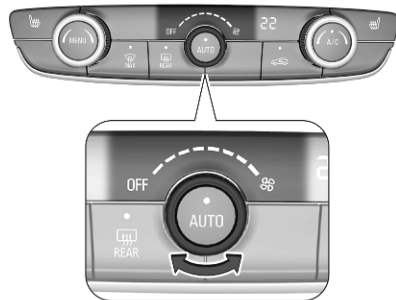
Fan speed 

Adjust the air flow by turning rotary knob to the desired speed. Fan speed can also be changed in the climate settings menu. Press **MENU** to enter the menu.

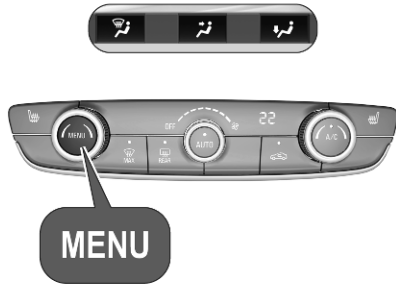

Turn rotary knob anticlockwise as far as it will go: fan and cooling are switched off.

To return to automatic mode, press **AUTO**.

Air distribution   

Press **MENU** to enter the menu.

Touch in the Info Display:

-  : to windscreen and front door windows
-  : to head area and rear seats via adjustable air vents
-  : to front and rear foot well and windscreen

To return to automatic air distribution, press **AUTO**.

Temperature preselection  

Set the preselected temperature to the desired value using the left or the right rotary knob.

Recommended temperature is 22 °C. The temperature is indicated in the display and in the climate settings menu.

If the minimum temperature **Lo** is set, the climate control system runs at maximum cooling, if cooling **A/C** is switched on.

If the maximum temperature **Hi** is set, the climate control system runs at maximum heating.

**Notice**

If **A/C** is switched on, reducing the set cabin temperature can cause the engine to restart from an Autostop or inhibit an Autostop.

Stop-start system ⇨ 107.

## Air conditioning A/C

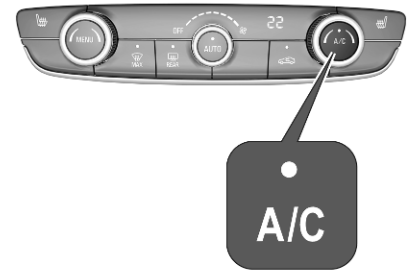



Press **A/C** to switch on cooling. The LED in the button illuminates to indicate activation. Cooling is only functional when the engine is running and climate control fan is switched on. Press **A/C** again to switch off cooling.

The air conditioning system cools and dehumidifies (dries) when outside temperature is above a specific level. Therefore, condensation may form and drip from under the vehicle.

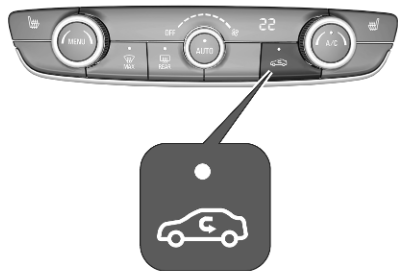
If no cooling or drying is required, switch off the cooling system for fuel saving reasons.

Manual air recirculation 

Press  to activate the air recirculation mode. The LED in the button illuminates to indicate activation.

Press  again to deactivate recirculation mode.

### Warning

The exchange of fresh air is reduced in air recirculation mode. In operation without cooling, the air humidity increases, so the windows may mist up from inside.



The quality of the passenger compartment air deteriorates, which may cause the occupants to feel drowsy.

In warm and very humid ambient air conditions, the windscreen may mist up from outside, when cold air is directed towards it. If windscreen mists up from outside, activate windscreen wiper and deactivate .

### Demisting and defrosting the windows





- Press . The LED in the button illuminates to indicate activation.
- Temperature and air distribution are set automatically and the fan runs at high speed.
- Switch on air conditioning by pressing **A/C**, if required.

- Switch on heated rear window .
- To return to previous mode, press  again. To return to automatic mode, press **AUTO**.

Heated rear window ⇨ 24.

Heated exterior mirrors ⇨ 21.

### Notice

If  is pressed while the engine is running, an Autostop will be inhibited until  is pressed again.

If  is pressed while the engine is in an Autostop, the engine will restart automatically.

Stop-start system ⇨ 107.

### Deactivation of electronic climate control system

Cooling, fan and automatic mode can be switched off by turning one of the rotary knobs anticlockwise.

Activation by switching on the fan or pressing **AUTO**.



## Auxiliary heater

### Air heater

Quickheat is an electric auxiliary air heater which automatically warms up the passenger compartment more quickly.

## Temperature preconditioning

The temperature preconditioning allows to heat or to ventilate the vehicle's interior with ambient air.

The temperature preconditioning can be programmed via the Info Display or the MyVauxhall App.

### Notice

On vehicles equipped with the **Multimedia** infotainment system, temperature preconditioning can only be used via the MyVauxhall App.

### Notice

The temperature preconditioning is only activated if the ignition is off and the vehicle is locked.

If the charging level of the high voltage battery is below 30%, the temperature preconditioning is not activated.

When the vehicle is plugged in, battery charging takes precedence over pre-conditioning. Consequently, it can only be activated if the battery is charged above a threshold fixed at 80%.

If a recurrent heating / ventilation is programmed and two heating / ventilation procedures are carried out without operating the vehicle, the programming is deactivated.

## Setting timer

### Notice

Several timers can be programmed and saved. It is recommended to programme temperature preconditioning with the vehicle plugged in, in order to optimise the long-term performance of the high voltage battery.



**MENU**

Press **MENU** .  
Touch **OPTIONS**.

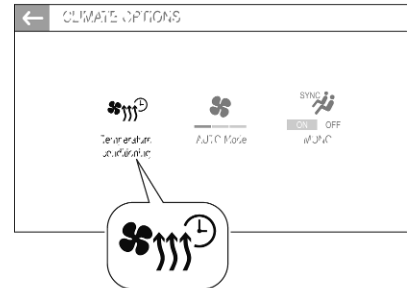

Select .

Touch **+** to define a new timer.

Touch **-:--**.

Enter time and day.

Press **✓** to confirm the settings.

Press **ON** to activate the timer.

To delete a timer, press  at the top of the Info Display and delete the desired timer.

Confirm the deletion.

The heating / ventilation procedure starts approx. 45 minutes before the programmed time, and is maintained ten minutes after it.

## Air vents

### Adjustable air vents

#### Centre air vents in the instrument panel

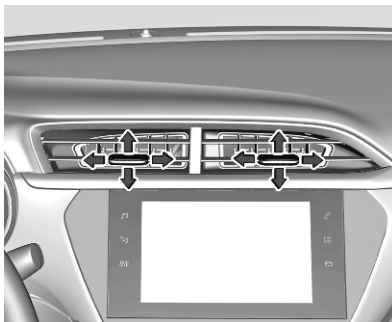

Direct the flow of air by tilting and swivelling the slats.

To close the vent, swivel the slats inwards.

#### Outer air vents in the instrument panel

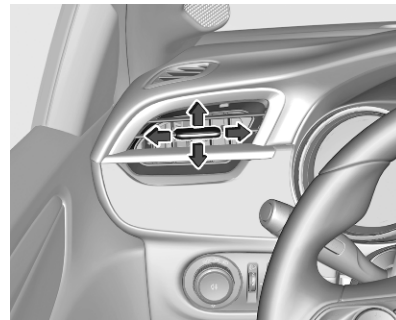

Direct the flow of air by tilting and swivelling the slats.

To close the vent, swivel the slats outwards.

At least two air vents must be open while cooling is on.

#### Warning

Do not attach any objects to the slats of the air vents. Risk of damage and injury in case of an accident.

## Fixed air vents

Additional air vents are located beneath the windscreen and door windows and in the foot wells.

## Maintenance

### Air intake

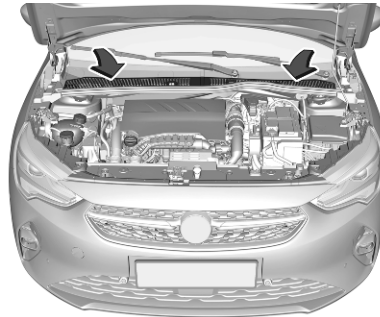

The air intake in front of the windscreen in the engine compartment must be kept clear to allow air intake. Remove any leaves, dirt or snow.

## Air conditioning regular operation

In order to ensure continuously efficient performance, cooling must be operated for a few minutes once a month, irrespective of the weather and time of year. Operation with cooling is not possible when the outside temperature is too low.

## Service

For optimal cooling performance, it is recommended to annually check the climate control system, starting three years after initial vehicle registration, including:

- functionality and pressure test
- heating functionality
- leakage check
- check of drive belts
- cleaning of condenser and evaporator drainage
- performance check

# Driving and operating

|                                     |            |
|-------------------------------------|------------|
| <b>Driving hints</b> .....          | <b>103</b> |
| Control of the vehicle .....        | 103        |
| Steering .....                      | 103        |
| Emergencies .....                   | 103        |
| <b>Starting and operating</b> ..... | <b>104</b> |
| New vehicle running-in .....        | 104        |
| Ignition switch positions .....     | 104        |
| Power button .....                  | 104        |
| Starting the engine .....           | 106        |
| Overrun cut-off .....               | 107        |
| Stop-start system .....             | 107        |
| Parking .....                       | 109        |
| <b>Engine exhaust</b> .....         | <b>110</b> |
| Exhaust filter .....                | 110        |
| Catalytic converter .....           | 111        |
| AdBlue .....                        | 111        |
| <b>Electric drive unit</b> .....    | <b>114</b> |
| Operation .....                     | 114        |
| <b>Automatic transmission</b> ..... | <b>118</b> |
| Transmission display .....          | 118        |
| Gear selection .....                | 119        |
| Manual mode .....                   | 122        |
| Electronic driving programmes       | 123        |

|                                                                   |            |
|-------------------------------------------------------------------|------------|
| Fault .....                                                       | 124        |
| Interruption of power supply ....                                 | 124        |
| <b>Manual transmission</b> .....                                  | <b>124</b> |
| <b>Drive systems</b> .....                                        | <b>125</b> |
| Drive modes .....                                                 | 125        |
| <b>Brakes</b> .....                                               | <b>126</b> |
| Antilock brake system .....                                       | 126        |
| Parking brake .....                                               | 127        |
| Brake assist .....                                                | 129        |
| Hill start assist .....                                           | 130        |
| Regenerative braking .....                                        | 130        |
| <b>Ride control systems</b> .....                                 | <b>130</b> |
| Electronic Stability Control and<br>Traction Control system ..... | 130        |
| Sport mode .....                                                  | 131        |
| <b>Driver assistance systems</b> .....                            | <b>132</b> |
| Cruise control .....                                              | 132        |
| Speed limiter .....                                               | 135        |
| Adaptive cruise control .....                                     | 137        |
| Forward collision alert .....                                     | 144        |
| Active emergency braking .....                                    | 145        |
| Front pedestrian protection ....                                  | 148        |
| Parking assist .....                                              | 149        |
| Advanced parking assist .....                                     | 154        |
| Side blind spot alert .....                                       | 159        |
| Panoramic view system .....                                       | 161        |
| Rear view camera .....                                            | 164        |
| Traffic sign assistant .....                                      | 165        |
| Lane keep assist .....                                            | 166        |

|                                                         |            |
|---------------------------------------------------------|------------|
| Advanced lane keep assist .....                         | 168        |
| Driver alert .....                                      | 170        |
| <b>Charging</b> .....                                   | <b>171</b> |
| General information .....                               | 171        |
| Charging types .....                                    | 172        |
| Charging cable .....                                    | 173        |
| Programmable charging .....                             | 178        |
| Charging status .....                                   | 179        |
| <b>Fuel</b> .....                                       | <b>180</b> |
| Fuel for petrol engines .....                           | 180        |
| Fuel for diesel engines .....                           | 181        |
| Refuelling .....                                        | 182        |
| Fuel consumption - CO <sub>2</sub> -<br>Emissions ..... | 183        |
| <b>Trailer hitch</b> .....                              | <b>184</b> |
| General information .....                               | 184        |
| Driving characteristics and<br>towing tips .....        | 184        |
| Trailer towing .....                                    | 184        |

## Driving hints

### Control of the vehicle

#### Never coast with engine not running

Many systems will not function in this situation (e.g. brake servo unit, power steering). Driving in this manner is a danger to yourself and others.

All systems function during an Autostop.

Stop-start system ⇨ 107.

#### Pedals

To ensure the pedal travel is uninhibited, there must be no mats in the area of the pedals.

Use only floor mats, which fit properly and are fixed by the retainers on the driver side.

### Steering

If power steering assist is lost because the engine stops or due to a system malfunction, the vehicle can be steered but may require increased effort.

### Emergencies

#### Warning

Damage to the high voltage battery or high voltage system can create a risk of electric shock, overheating, or fire.

If the vehicle has been damaged or affected by a moderate to severe crash, it must be inspected as soon as possible by qualified personnel. Until the technical inspection has been carried out, the vehicle must be stored outside at a minimum distance of 5 metres from any structure or other flammable objects.

If the vehicle has been damaged or affected by flood or fire, it must not be moved at all and has to be inspected by qualified personnel as soon as possible.

## Starting and operating

### New vehicle running-in

Do not brake unnecessarily hard for the first few journeys.

During the first drive, smoke may occur because of wax and oil evaporating off the exhaust system. Park the vehicle in the open for a while after the first drive and avoid inhaling the fumes.

During the running-in period, fuel and engine oil consumption may be higher.

Additionally, the cleaning process of the exhaust filter may take place more often.

Exhaust filter ↪ 110.

### Ignition switch positions

Turn key:

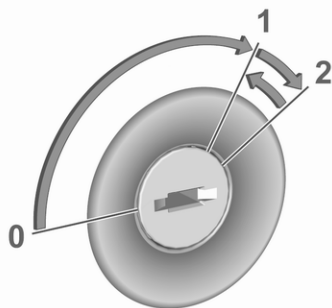

- 0 : ignition off: some functions remain active until key is removed or driver's door is opened, provided the ignition was on previously
- 1 : ignition on power mode: ignition is on, diesel engine is preheating, control indicators illuminate and most electrical functions are operable
- 2 : engine start: release key after engine has been started

### Steering wheel lock

Depending on version, the vehicle may be equipped with a steering wheel lock.

In this case, remove key from ignition switch and turn steering wheel until it engages.

#### **⚠ Danger**

Never remove the key from ignition switch during driving as this will cause, depending on version, steering wheel lock.

### Power button

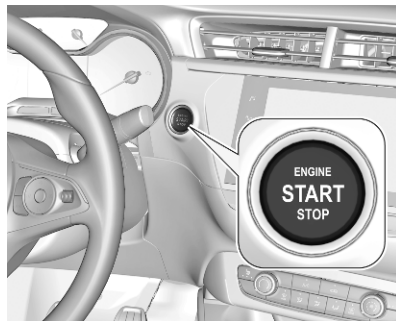

The electronic key must be inside the vehicle.

### Engine start

Operate the clutch pedal (manual transmission), the brake pedal and press **Start/Stop**.

### Ignition on power mode without starting the engine

Press **Start/Stop** without operating any pedal. Control indicators illuminate and most electrical functions are operable.

### Engine and ignition off

Press **Start/Stop** briefly in each mode or when engine is running and vehicle is stationary. Some functions remain active until driver's door is opened.

### Emergency shut off during driving

Press **Start/Stop** for 5 seconds ↷ 106. Depending on version, steering wheel locks as soon as vehicle is stationary.

### Steering wheel lock

Depending on version, the vehicle may be equipped with a steering wheel lock.

In this case, the steering wheel lock activates automatically when:

- the vehicle is stationary.
- the ignition has been switched off.

To release steering wheel lock, open and close driver's door and switch the ignition on power mode or start the engine directly.

### ⚠ Warning

If the vehicle battery is discharged, the vehicle must not be towed or tow-started as the steering wheel lock cannot be disengaged.

### Operation in case of failure

If either the electronic key fails or the battery of the electronic key is weak, a message may be displayed in the Driver Information Centre.

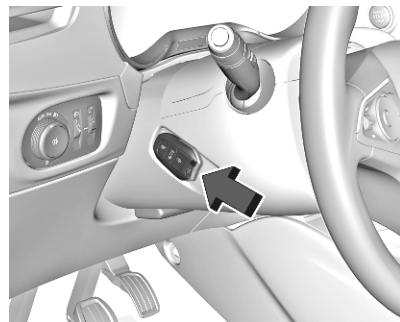

Hold the electronic key at the marking on the steering column cover as shown in the illustration.

On vehicles with manual transmission, select neutral gear, operate the clutch pedal, the brake pedal and press **Start/Stop**.

On vehicles with automatic transmission, set the selector lever to position **P**, operate the brake pedal and press **Start/Stop**.

This option is intended for emergencies only. Replace the electronic key battery as soon as possible ↷ 8.

For unlocking or locking the doors, see fault in radio remote control unit or electronic key system ⇨ 10.

## Starting the engine

### Vehicles with ignition switch

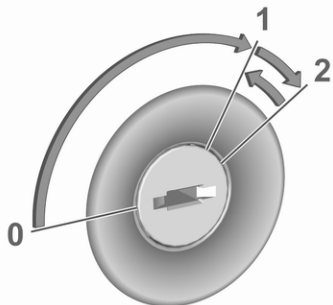

Depending on version, turn key to position 1 to release the steering wheel lock.

Manual transmission: operate clutch and brake pedal.

Automatic transmission: operate brake pedal and move selector lever to **P** or **N**.

Do not operate accelerator pedal.

Diesel engines: wait until control indicator  extinguishes.

Turn key briefly to position 2 and release after engine has been started.

Manual transmission: during an Autostop, the engine can be started by depressing the clutch pedal ⇨ 107.

Automatic transmission: during an Autostop, the engine can be started by releasing the brake pedal ⇨ 107.

### Vehicles with power button



- Manual transmission: select neutral gear, operate clutch and brake pedal.
- Automatic transmission: operate brake pedal and move selector lever to **P** or **N**.
- Do not operate accelerator pedal.
- Press **Start/Stop** button.
- Release button after starting procedure begins. Diesel engine starts after control indicator  for preheating extinguishes.
- Before restarting or to switch off the engine when vehicle is stationary, press **Start/Stop** once more briefly.

Manual transmission: during an Autostop, the engine can be started by depressing the clutch pedal ⇨ 107.

Automatic transmission: during an Autostop, the engine can be started by releasing the brake pedal ⇨ 107.

### Emergency shut off during driving

If the engine needs to be switched off during driving in case of emergency, press **Start/Stop** for 5 seconds.



**⚠ Danger**

Switching off the engine during driving may cause loss of power support for brake and steering systems. Assistance systems and airbag systems are disabled. Lighting and brake lights will extinguish. Therefore power down the engine and ignition while driving only when required in case of emergency.

**Starting the vehicle at low temperatures**

Starting the engine without additional heaters is possible down to -25 °C for diesel engines and -30 °C for petrol engines. Required is an engine oil with the correct viscosity, the correct fuel, performed services and a sufficiently charged vehicle battery.

With temperatures below -30 °C the automatic transmission requires a warming phase of approx. 5 minutes. The selector lever must be in position **P**.

**Turbo engine warm-up**

Upon start-up, engine available torque may be limited for a short time, especially when the engine temperature is cold. The limitation is to allow the lubrication system to fully protect the engine.

**Overrun cut-off**

The fuel supply is automatically cut off during overrun, i.e. when the vehicle is driven with a gear engaged but accelerator pedal is released.

Depending on driving conditions, the overrun cut-off may be deactivated.

**Stop-start system**

The stop-start system helps to save fuel and to reduce the exhaust emissions. When conditions allow, it switches off the engine as soon as the vehicle is at a low speed or at a standstill, e.g. at a traffic light or in a traffic jam.

**Activation**

The stop-start system is available as soon as the engine is started, the vehicle starts-off and the conditions as stated below in this section are fulfilled.



The system is ready to operate when the LED in the button **A OFF** is not illuminated. To activate the system when the system is deactivated, press **A OFF**.

If the stop-start system is temporarily not available and the button **A OFF** is pressed, the LED in the button flashes.

## Deactivation

Deactivate the stop-start system manually by pressing . The deactivation is indicated when the LED in the button illuminates.

## Autostop

### Vehicles with manual transmission

Activate an Autostop as follows:

- Set the selector lever to neutral.
- Release the clutch pedal.

The engine will be switched off while the ignition stays on.

### Vehicles with automatic transmission

If the vehicle is at a standstill with depressed brake pedal, Autostop is activated automatically.

The engine will be switched off while the ignition stays on.

The stop-start system will be disabled on steep inclines.

## Indication



An Autostop is indicated by control indicator .

During an Autostop, the heating and brake performance will be maintained.

### Conditions for an Autostop

The stop-start system checks if each of the following conditions is fulfilled.

- The stop-start system is not manually deactivated.
- The driver's door is closed or the driver's seat belt is fastened.
- The vehicle battery is sufficiently charged and in good condition.
- The engine is warmed up.
- The engine coolant temperature is not too high.

- The engine exhaust temperature is not too high, e.g. after driving with high engine load.
- The ambient temperature is not too low or too high.
- The climate control system allows an Autostop.
- The brake vacuum is sufficient.
- The self-cleaning function of the exhaust filter is not active.
- The vehicle was driven at least at walking speed since the last Autostop.

Otherwise an Autostop will be inhibited.

### Notice

The Autostop may be inhibited for several hours after a battery replacement or reconnection.

Certain settings of the climate control system may inhibit an Autostop.

Climate control ⇨ 93.

Immediately after higher speed driving an Autostop may be inhibited.

New vehicle running-in ⇨ 104.

**Vehicle battery discharge protection**

To ensure reliable engine restarts, several vehicle battery discharge protection features are implemented as part of the stop-start system.

**Power saving measures**

During an Autostop, several electrical features such as auxiliary electric heater or rear window heating are disabled or switched to a power saving mode. The fan speed of the climate control system is reduced to save power.

**Restart of the engine by the driver****Vehicles with manual transmission**

Depress the clutch pedal without depressing the brake pedal to restart the engine.

**Vehicles with automatic transmission**

The engine is restarted in the following cases:

- brake pedal released while the selector lever in position **D** or **M**
- brake pedal released or selector lever in position **N** when selector lever is moved to position **D** or **M**
- selector lever moved to position **R**

**Restart of the engine by the stop-start system**

Vehicles with manual transmission: The selector lever must be in neutral to enable an automatic restart.

If one of the following conditions occurs during an Autostop, the engine will be restarted automatically by the stop-start system:

- stop-start system manually deactivated
- driver's seat belt unfastened and driver's door opened
- engine temperature too low

- charging level of vehicle battery below a defined level
- brake vacuum not sufficient
- vehicle is driven or rolls at least at walking speed
- climate control system requests engine start
- air conditioning manually switched on

If an electrical accessory, e.g. a portable CD player, is connected to the power outlet, a brief power drop during the restart might be noticeable.

**Parking****⚠ Warning**

- Do not park the vehicle on an easily ignitable surface. The high temperature of the exhaust system could ignite the surface.
- Always apply the parking brake. Activate the parking brake without pressing the release button. Apply as firmly

as possible on a downhill slope or uphill slope. Depress brake pedal at the same time to reduce operating force.

- If the vehicle is on a level surface or uphill slope, engage first gear or set the selector to position **P**. On an uphill slope, turn the front wheels away from the kerb.

If the vehicle is on a downhill slope, engage reverse gear or set the selector to position **P**. Turn the front wheels towards the kerb.

- Close the windows.
- Switch off the engine.
- Remove the ignition key from the ignition switch or switch off ignition on vehicles with power button. Depending on version, turn the steering wheel until the steering wheel lock is felt to engage.

- Lock the vehicle.
- Activate the anti-theft alarm system.
- The engine cooling fans may run after the engine has been switched off ⇨ 190.

### Caution

After running at high engine speeds or with high engine loads, operate the engine briefly at a low load or run in neutral for approx. 30 seconds before switching off, in order to protect the turbocharger.

### Notice

In the event of an accident with airbag deployment, the engine is switched off automatically if the vehicle comes to a standstill within a certain time.

In countries with extremely low temperatures it may be necessary to park the vehicle without applied parking brake. Make sure to park the vehicle on a level surface.

Parking brake ⇨ 127.

## Engine exhaust

### ⚠ Danger

Engine exhaust gases contain poisonous carbon monoxide, which is colourless and odourless and could be fatal if inhaled.



If exhaust gases enter the interior of the vehicle, open the windows. Have the cause of the fault rectified by a workshop.

Avoid driving with an open load compartment, otherwise exhaust gases could enter the vehicle.

## Exhaust filter

### Automatic cleaning process

The exhaust filter system filters soot particles out of the exhaust gases.



The start of saturation of the exhaust filter is indicated by the temporary illumination of  or , accompanied by a message in the Driver Information Centre.

As soon as the traffic conditions permit, regenerate the filter by driving at a vehicle speed of at least 40 mph until the control indicator extinguishes.

### Notice

On a new vehicle, the first exhaust filter regeneration operations may be accompanied by a burning smell, which is normal. Following prolonged operation of the vehicle at very low speed or at idle, water vapour can be emitted at the exhaust on acceleration. This does not affect the behaviour of the vehicle or the environment.

### Cleaning process not possible

If  or  stays on, accompanied by an audible signal and a message, this indicates that the exhaust filter additive level is too low.

The reservoir must be topped-up without delay. Seek the assistance of a workshop.

## Catalytic converter

The catalytic converter reduces the amount of harmful substances in the exhaust gases.

### Caution

Fuel grades other than those listed on pages ⇨ 180, ⇨ 236 could damage the catalytic converter or electronic components.

Unburnt petrol will overheat and damage the catalytic converter. Therefore avoid excessive use of the starter, running the fuel tank dry and starting the engine by pushing or towing.

In the event of misfiring, uneven engine running, a reduction in engine performance or other unusual problems, have the cause of the fault rectified by a workshop as soon as possible. In an emergency, driving can be continued for a short period, keeping vehicle speed and engine speed low.

## AdBlue

### General information

The selective catalytic reduction (BlueInjection) is a method to substantially reduce the nitrogen oxides in the exhaust emission. This is achieved by injecting a Diesel Exhaust Fluid (DEF) into the exhaust system. The ammonia released by the fluid reacts with nitrous gases (NO<sub>x</sub>) from the exhaust and turns it into nitrogen and water.

The designation of this fluid is AdBlue®. It is a non-toxic, non-flammable, colourless and odourless fluid which consists of 32% urea and 68% water.

### Warning

Avoid contact of your eyes or skin with AdBlue.

In case of eye or skin contact, rinse off with water.

**Caution**

Avoid contact of the paintwork with AdBlue.

In case of contact, rinse off with water.

AdBlue freezes at a temperature of approx. -11 °C. As the vehicle is equipped with an AdBlue pre-heater, the emissions reduction at low temperatures is ensured. The AdBlue pre-heater works automatically.

In some circumstances below the mentioned temperature, an error message appears in the Driver Information Centre. In this event, park the vehicle in a space with a higher ambient temperature until AdBlue is liquefied.

**Notice**

Frozen and again liquefied AdBlue is usable without quality loss.

The typical AdBlue consumption is approx. 2 l per 600 miles, but can also be higher depending on driving behaviour (e.g. high load or towing).

**Level warnings**

Depending on the calculated range of AdBlue, different messages are displayed in the Driver Information Centre. The messages and the restrictions are a legal requirement.

1. The first warning level is entered when the estimated AdBlue range is between 1500 miles and 500 miles.

When switching on the ignition, this warning will show up once briefly with the calculated range. Additionally, control indicator  will illuminate and a chime will sound. Driving is possible without any restrictions.

2. The next warning level is entered when the estimated AdBlue range is below 500 miles. The message with the current range will always be displayed when ignition is switched on. Additionally, control indicator  will flash and a chime will sound. Refill AdBlue before entering the next warning level.

3. The next warning level is entered with a range below 60 miles. The message with the current range will always be displayed when ignition is switched on. Additionally, control indicator  will flash and a chime will sound. Refill AdBlue as soon as possible before the AdBlue tank is completely empty. Otherwise, a restart of the engine will not be possible.



4. The last warning level is entered when the AdBlue tank is empty. Restart of the engine is not possible.

A message appears in the Driver Information Centre. Additionally, control indicator  will flash and a chime will sound.

Refill the tank to a level of at least 5 l of AdBlue, otherwise restarting of the engine is not possible.

**High emission warnings**

In the event of a fault with the emissions control system, different messages are displayed in the Driver Information Centre.

The messages and the restrictions are a legal requirement. The warning messages are accompanied by the control indicators ,  and . Additionally, a chime will sound.

Follow the instructions of the warning messages. If starting is prevented, seek the assistance of a workshop.

## Refilling AdBlue

### Caution

Only use AdBlue that complies with European standards DIN 70 070 and ISO 22241-1.

Do not use additives.

Do not dilute AdBlue.

Otherwise the selective catalytic reduction system could be damaged.

### Notice

Whenever a filling pump with a nozzle for passenger cars is not available at a filling station, use only AdBlue bottles or canisters with a sealed refill adapter for refilling, to prevent splashback and overspill,

and in order to ensure that the fumes from the tank are captured and do not emerge. AdBlue in bottles or canisters is available in many filling stations and can be purchased e.g. at Vauxhall dealers and other retail outlets.

Since AdBlue has a limited durability, check the date of expiry before refilling.

### Notice

Refill the tank to a level of at least 5 l to ensure that the new AdBlue level is being detected.

In case AdBlue refill is not successfully detected:

1. Continuously drive the vehicle for 10 min making sure that vehicle speed is always higher than 12 mph.
2. If AdBlue refill is detected successfully, AdBlue supply-driven warnings or limitations will disappear.

If AdBlue refill is still not detected, seek the assistance of a workshop.

If AdBlue must be refilled at temperatures below  $-11^{\circ}\text{C}$ , the refilling of AdBlue may not be detected by the system. In this event, park the vehicle in a space with a higher ambient temperature until AdBlue is liquified.

### Notice

When unscrewing the protective cap from the filler neck, ammonia fumes may emerge. Do not inhale as the fumes have a pungent smell. The fumes are not harmful by inhalation.

The AdBlue tank should be filled completely. This must be done if the warning message regarding prevention of an engine restart is already displayed.

AdBlue refilling quantity  $\rightarrow$  237.

The vehicle must be parked on a level surface.

The filler neck for AdBlue is located behind the fuel filler flap.

The fuel filler flap can only be opened if the vehicle is unlocked.

1. Switch off the ignition.

2. Close all doors to avoid ammonia fumes entering the interior of the vehicle.
3. Release the fuel filler flap by pushing the flap ↗ 182.

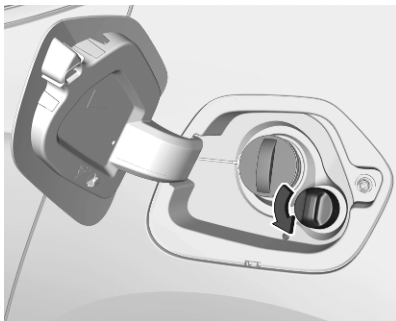

4. Unscrew protective cap from the filler neck.
5. Open AdBlue canister.
6. Mount one end of the hose on the canister and screw the other end on the filler neck.
7. Lift the canister until it is empty, or until the flow from the canister has stopped.

8. Place the canister on the ground to empty the hose, wait 15 seconds.
9. Unscrew the hose from the filler neck.
10. Mount the protective cap and turn clockwise until it engages.

**Notice**

Dispose of AdBlue canister according to environmental requirements. Hose can be reused after flushing with clear water before AdBlue dries out.

## Electric drive unit

### Operation

The vehicle uses an electric drive unit with a 1-gear transmission.

|                                                                                                                                                                                                     |
|-----------------------------------------------------------------------------------------------------------------------------------------------------------------------------------------------------|
| <b>Caution</b>                                                                                                                                                                                      |
| If the vehicle seems to accelerate slowly or not respond when you try to go faster, do not continue your journey. The electric drive unit could be damaged. Consult a workshop as soon as possible. |

|                                                                                                                                                                                                                                                      |
|------------------------------------------------------------------------------------------------------------------------------------------------------------------------------------------------------------------------------------------------------|
| <b>Caution</b>                                                                                                                                                                                                                                       |
| Spinning the tyres or holding the vehicle in one place on a hill using only the accelerator pedal may damage the electric drive unit. If you are stuck, do not spin the tyres. When stopping on a hill, use the brakes to hold the vehicle in place. |

There are two different selector types.



## Type A

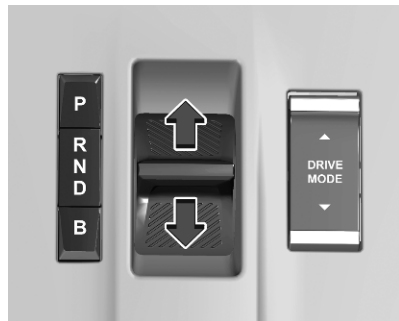

- P** : park position  
**R** : reverse gear  
**N** : neutral  
**D** : automatic mode  
**B** : automatic mode with one-pedal driving

After selecting a mode, the selector will return to the centre position. The selected mode is indicated in the Driver Information Centre.

Do not accelerate while engaging a mode. Never depress the accelerator pedal and brake pedal at the same time.

When **D** or **R** is selected, the vehicle slowly begins to creep when the brake is released.

### Park position P

#### ⚠ Warning

Do not leave the vehicle when the propulsion system is running, the vehicle may move suddenly. You or others can be injured. To be sure the vehicle will not move, even if you are on even ground, make sure the parking brake is applied and **P** is selected.

To shift into **P**, press button **P** when vehicle is stationary. In **P**, the front wheels of the vehicle are blocked.

To shift out of **P**, depress the brake pedal and select the desired mode.

The vehicle shifts automatically into **P** when

- the ignition is switched off
- the driver's door is opened while the vehicle's speed is below 1 mph

### Reverse gear R

To shift into and out of **R**, the vehicle must be at standstill and the brake pedal has to be depressed.

#### Caution

Shifting into **R** while the vehicle is moving forwards could damage the electric drive unit. Only shift into **R** after the vehicle has been stopped.

### Neutral N

In this position, the propulsion system does not transfer torque to the wheels. To restart the propulsion system when the vehicle is already moving, use **D** only.

### Automatic mode D

This mode is for normal driving.

### Automatic mode B with one-pedal driving

In this mode, vehicle speed is significantly reduced by releasing the accelerator pedal, without operating the brake pedal.

Use **B** when driving down steep hills, in deep snow, in mud or in stop-and-go traffic.

**Warning**

In the case of extreme temperatures or if the high voltage battery is almost fully charged, the brake force of the engine braking may be temporarily reduced. If the braking force is not sufficient, the driver has to be prepared to use the brake pedal.



**B** can only be activated if **D** is selected. Press button **B**.

To deactivate **B**, press button **B**.  
Regenerative braking ⇨ 130.

**Type B**

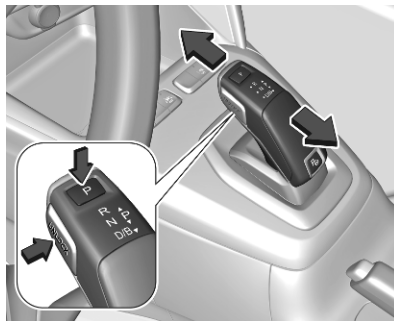

- P** : park position
- R** : reverse gear
- N** : neutral
- D** : automatic mode
- B** : automatic mode with one-pedal driving

The selected mode is indicated in the Driver Information Centre.

Do not accelerate while engaging a mode. Never depress the accelerator pedal and brake pedal at the same time.

When **D** or **R** is selected, the vehicle slowly begins to creep when the brake is released.

**Park position P**

This position locks the front wheels. It is the recommended position when starting the propulsion system because the vehicle cannot move easily.

**Warning**

It is dangerous to get out of the vehicle if the selector lever is not fully in **P** with the parking brake firmly applied. The vehicle can roll.

Do not leave the vehicle when the propulsion system is running, the vehicle may move suddenly. You or others can be injured. To be sure the vehicle will not move, even if you are on even ground, always apply the parking brake and move the selector lever to **P**.

The **UNLOCK** button is designed to prevent inadvertent shifting out of **P** unless the vehicle has been started, the brake pedal is depressed, and the release button is pressed.

When the vehicle is stopped, press **START/STOP** to switch off the vehicle. The electric drive unit will shift to **P** automatically.

The vehicle will not shift into **P** if it is moving too fast. Stop the vehicle and shift into **P**.

To shift into **P**, press the **P** button on the selector lever.

To shift out of **P**:

1. Depress the brake pedal and press the **UNLOCK** button.
2. Shift into the desired gear.

### Reverse gear R

To shift in to **R**, the vehicle must be at standstill and the brake pedal has to be depressed. Press **UNLOCK** if necessary and move the selector lever to **R**.

### Caution

Shifting into **R** while the vehicle is moving forward could damage the electric drive unit. Only shift into **R** after the vehicle has been stopped.

### Neutral N

In this position, the propulsion system does not transfer torque to the wheels.

The vehicle is not designed to stay in **N** for extended periods of time. It will automatically shift into **P**.

### Automatic mode D

This mode is for normal driving.

### Automatic mode with one-pedal driving B

In this mode, the vehicle speed is significantly reduced by releasing the accelerator pedal without operating the brake pedal.

Use **B** when driving down steep hills, in deep snow, in mud or in stop-and-go traffic.

### ⚠ Warning

In the case of extreme temperatures or if the high voltage battery is almost fully charged, the brake force of the engine braking may be temporarily reduced. If the braking force is not sufficient, the driver has to be prepared to use the brake pedal.

To activate **B**, select **D** and push the selector backwards. To shift out of **B**, push the selector again.

### Free wheeling

In certain situations, e.g., in an automatic car wash etc., it is necessary that the wheels can move freely when the engine is switched off.

To enable free wheeling, the vehicle has to be stationary, the engine has to be running and the driver's door has to be closed.

### Selector type A

1. Depress the brake pedal and select **N**.
2. Within 5 seconds, depress and hold the brake pedal, switch off ignition and move the selector forwards or backwards.
3. Release the brake pedal and switch on ignition.
4. Depress and hold the brake pedal and push the switch (P).
5. Release the brake pedal and switch off ignition.

### Selector type B

1. Select **N** and switch off ignition.
2. Within 5 seconds, switch on ignition, depress and hold the brake pedal and move the selector forwards or backwards.
3. Still hold the brake pedal and push the switch (P).
4. Release the brake pedal and switch off ignition.

A message is displayed in the Driver Information Centre indicating that the wheels are unblocked for the next 15 minutes.

To revert to normal operation, depress the brake pedal, switch on the engine and select **P**.

Parking brake ↪ 127.

## Automatic transmission

The automatic transmission permits automatic gearshifting (automatic mode) or manual gearshifting (manual mode).

Manual mode ↪ 122.

## Transmission display

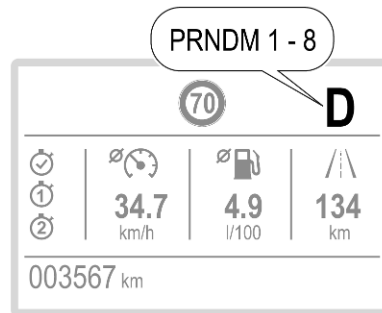

The mode or selected gear is shown in the Driver Information Centre.

In automatic mode, the driving programme is indicated by **D**.

In manual mode, **M** and the number of the selected gear is indicated.

- R** indicates reverse gear.  
**N** indicates neutral position.  
**P** indicates park position.

## Gear selection

### ⚠ Warning

Do not leave the vehicle when the engine is running, the vehicle may move suddenly. You or others can be injured. To be sure the vehicle will not move, even if you are on even ground, make sure the parking brake is applied and **P** is selected.

Depending on version, there are three different selector types:

### Type A (8-gear automatic transmission)

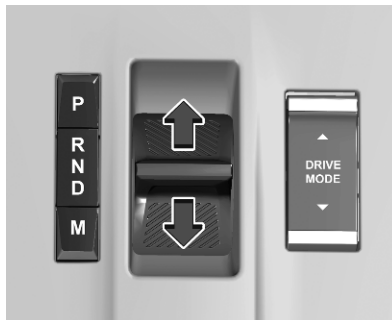

- P** : park position  
**R** : reverse gear  
**N** : neutral  
**D** : automatic mode  
**M** : manual mode

After selecting a mode, the selector will return to the centre position. The selected mode is indicated in the Driver Information Centre.

Do not accelerate while engaging a mode. Never depress the accelerator pedal and brake pedal at the same time.

When **D** or **R** is selected, the vehicle slowly begins to creep when the brake is released.

### Park position **P**

This position locks the front wheels. **P** is automatically engaged when ignition is switched off.

The vehicle automatically shifts into **P** if

- the vehicle is stopped
- the driver's door is opened while the vehicle's speed is below 1 mph

The vehicle will not shift into **P** if it is moving too fast. Stop the vehicle and shift into **P**.

To shift into **P**, press button **P**.

To shift out of **P**: Depress the brake pedal and select the desired mode.

### Reverse gear **R**

To shift into and out of **R**, the vehicle must be at standstill and the brake pedal has to be depressed.

**Caution**

Shifting into **R** while the vehicle is moving forwards could damage the automatic transmission. Only shift into **R** after the vehicle has been stopped.

**Neutral N**

In this mode, the propulsion system does not transfer torque to the wheels.

When **N** is selected and ignition is switched off, **P** is engaged after a short time.

**Automatic mode D**

This mode is for normal driving.

**Manual mode M**

In this mode, it is possible to change gears manually using steering the wheel paddles.

Manual mode ⇨ 122.

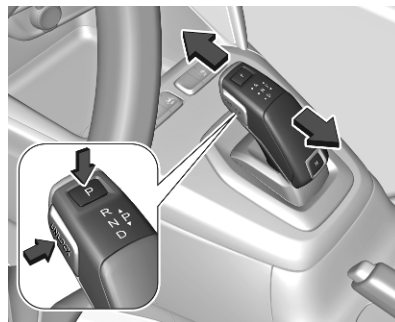
**Type B (8-gear automatic transmission)**

- P** : park position
- R** : reverse gear
- N** : neutral
- D** : automatic mode
- M** : manual mode

The engine can only be started with the selector lever in **P** or **N**. When position **N** is selected, press the brake pedal or apply the parking brake before starting.

The selected mode is indicated in the Driver Information Centre.

Do not accelerate while engaging a mode. Never depress the accelerator pedal and brake pedal at the same time.

When **D** or **R** is selected, the vehicle slowly begins to creep when the brake is released.

**Park position P**

This position locks the front wheels. **P** is automatically engaged when ignition is switched off.

To shift into **P**, apply the parking brake and press button **P**.

**UNLOCK button**

The selector lever is locked in **P**. Before unlocking, ensure that the ignition is on. Apply the brake pedal, press **UNLOCK** if necessary and move the selector lever to the desired mode.

Before engaging the reverse gear, come to a total stop. Apply the brake pedal, press **UNLOCK** and move the selector lever to **R**.

## Type C (6-gear automatic transmission)

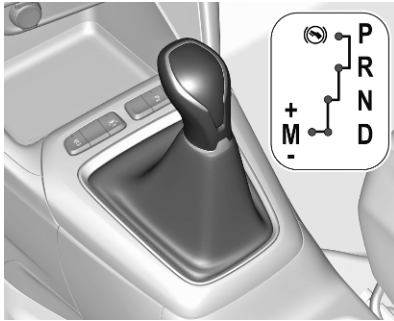

**P** : park position  
**R** : reverse gear  
**N** : neutral  
**D** : automatic mode  
**M** : manual mode

With **P** or **N** selected, the parking brake and the brake pedal applied, start the engine.

With the engine running, depress the brake pedal, release the parking brake and select the respective gear to move off.

### Caution

Never select **N** while the vehicle is moving.

If **N** is selected unintentionally while driving, allow the engine to idle and then select **D** to accelerate.

Before switching off the engine, come to a stop, apply the parking brake, unless it is set to automatic mode, and select **P** or **N**.

### Caution

If the selector is not in **P** when the driver's door is opened or approx. 45 seconds after the ignition has been switched off, a warning message is displayed in the Driver Information Centre accompanied by an audible signal.

Set the selector to **P**.

### Manual mode **M**

In this mode, it is possible to change gears manually using steering the wheel paddles.

Manual mode ⇨ 122.

### Engine braking

To utilise the engine braking effect, select a lower gear in good time when driving downhill.

Manual mode ⇨ 122.

### Free wheeling

In certain situations, e.g., in an automatic car wash etc., it is necessary that the wheels can move freely when the engine is switched off.

To enable free wheeling, the vehicle has to be stationary, the engine has to be running and the driver's door has to be closed.

### Selector type **A**

1. Depress the brake pedal and select **N**.
2. Within 5 seconds, depress and hold the brake pedal, switch off ignition and move the selector forwards or backwards.
3. Release the brake pedal and switch on ignition.

4. Depress and hold the brake pedal and push the switch (P).
5. Release the brake pedal and switch off ignition.

To revert to normal operation, depress and hold the brake pedal, switch on the engine and press **P**.

#### **Selector type B and electric parking brake**

1. Select **N** and switch off ignition.
2. Within 5 seconds, switch on ignition, depress and hold the brake pedal and move the selector forwards or backwards.
3. Still hold the brake pedal and push the switch (P).
4. Release the brake pedal and switch off ignition.

To revert to normal operation, depress and hold the brake pedal, switch on the engine and press **P**.

#### **Selector type B and manual parking brake**

1. Select **N** and switch off ignition.
2. Within 5 seconds, switch on ignition, depress and hold the brake pedal and move the selector forwards or backwards.
3. Switch off ignition.

To revert to normal operation, press **P**.

#### **Selector type C**

1. Depress and hold the brake pedal.
2. Select **N** and switch off ignition.
3. Release brake pedal and switch on ignition.
4. Depress and hold the brake pedal and push the switch (P).
5. Release the brake pedal and switch off ignition.

To revert to normal operation, depress the brake pedal, switch on the engine and apply the parking brake.

A message is displayed in the Driver Information Centre indicating that the wheels are unblocked for the next 15 minutes.

Parking brake ⇨ 127.

### **Manual mode**

Manual mode **M** can be activated from position **D** in each driving situation and speed.

The selected gear is indicated in the Driver Information Centre.

If a higher gear is selected when vehicle speed is too low, or a lower gear when vehicle speed is too high, the shift is not executed. This can cause a message in the Driver Information Centre.

In manual mode, no automatic shifting to a higher gear takes place at high engine revolutions.



### 6-gear automatic transmission

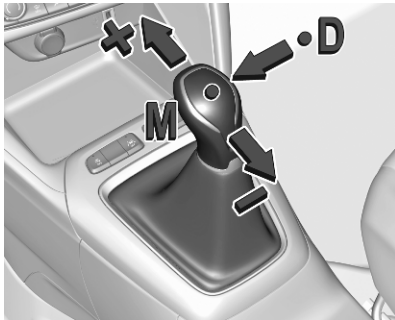

Move selector lever out of position **D** towards the left in position **M**.

Move selector lever to the front **+** to shift to a higher gear.

Move selector lever to the rear **-** to shift to a lower gear.

### 8-gear automatic transmission

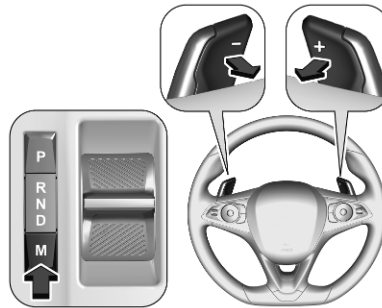

Type A

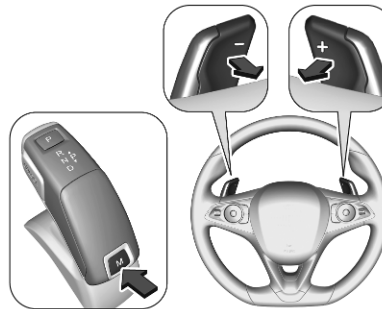

Type B

Press button **M**.

Pull steering wheel paddles to select gears manually.

Pull right paddle **+** to shift to a higher gear.

Pull left paddle **-** to shift to a lower gear.

Multiple pulls allow gears to be skipped.

### Gear shift indication

The symbol ▲ or ▼ with a number beside it is indicated when gearshifting is recommended for fuel saving reasons.

Shift indication appears only in manual mode.

### Electronic driving programmes

Following a cold start, the operating temperature programme increases engine speed to quickly bring the catalytic converter to the required temperature.

Special programmes automatically adapt the shifting points when driving up inclines or down hills.

In snowy or icy conditions or on other slippery surfaces, the electronic transmission control enables the driver to select manually first, second or third gear for starting off.

### Kickdown

Pressing down the accelerator pedal beyond the kickdown detent will lead to maximum acceleration independent of selected driving mode. The transmission shifts to a lower gear depending on engine speed.

### Fault

In the event of a fault,  illuminates a message is displayed in the Driver Information Centre.

Vehicle messages ⇨ 79.

Electronic transmission control enables only third gear. The transmission no longer shifts automatically.

Do not drive faster than 62 mph.

Have the cause of the fault remedied by a workshop.

### Interruption of power supply

In the event of an interruption of power supply, the selector lever cannot be moved out of the **P** position.

Towing the vehicle ⇨ 222.

If the vehicle battery is discharged, start the vehicle using jump leads ⇨ 221.

If the vehicle battery is not the cause of the fault, seek the assistance of a workshop.

## Manual transmission

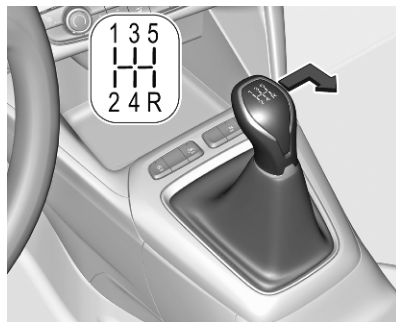

To engage reverse on 5-speed transmission, with the vehicle stationary and engine at idle, depress the clutch pedal and move the selector lever to the right and rear.



To engage reverse on 6-speed transmission, with the vehicle stationary and engine at idle, depress the clutch pedal, pull the ring under the selector lever and move the selector lever quite to the left and front.

If the gear does not engage, set the selector lever to neutral, release the clutch pedal and depress again. Then repeat gear selection.

Do not slip the clutch unnecessarily. When operating, depress the clutch pedal completely. Do not use the pedal as a foot rest.

When clutch slip is detected for a specific time, the engine power will be reduced. A warning is displayed in the Driver Information Centre. Release the clutch.

### Caution

It is not advisable to drive with the hand resting on the selector lever.

Gear shift indication ↗ 70.

Stop-start system ↗ 107.

## Drive systems

### Drive modes

Following drive modes are selectable:

- Normal mode
- Sport mode
- Eco mode

Each drive mode corresponds to a different vehicle setting.



To select the respective drive mode, use the shown toggle switch.

### Normal mode

The settings in this mode are set by default. Everytime the ignition is switched on, this mode is selected.

Electric vehicle: To optimise range, electric engine power output is reduced.

### Sport mode

The settings in this mode allow more dynamic driving. The vehicle's dynamic parameters can be displayed in the Driver Information Centre.

Electric vehicle: This mode allows maximum electric engine power output.

### Eco mode

Reduces fuel consumption by optimising the operation of the climate control system and, depending on version, the accelerator pedal, the automatic transmission and the gear shifting indicator.

While coasting the vehicle, the engine is idling with reduced engine brake.

Electric vehicle: To optimise range, electric engine power output is reduced and heating is switched off.

## Brakes

### Antilock brake system

Antilock brake system (ABS) prevents the wheels from locking.

ABS starts to regulate brake pressure as soon as a wheel shows a tendency to lock. The vehicle remains steerable, even during hard braking.

ABS control is made apparent through a pulse in the brake pedal and the noise of the regulation process.

For optimum braking, keep the brake pedal fully depressed throughout the braking process, despite the fact that the pedal is pulsating. Do not reduce the pressure on the pedal.

When braking in an emergency, the hazard warning flashers are switched on automatically depending on the force of deceleration. They are switched off automatically the first time you accelerate.

After starting off, the system performs a self-test which may be audible.



Control indicator (ABS) ⇨ 70.

### Fault

#### ⚠ Warning

If there is a fault in the ABS, the wheels may be liable to lock due to braking that is heavier than normal. The advantages of ABS are no longer available. During hard braking, the vehicle can no longer be steered and may swerve.

Have the cause of the fault remedied by a workshop.

### Parking brake

#### ⚠ Warning

Before leaving the vehicle, check parking brake status. Control indicator (P) illuminate constantly when electric parking brake is applied.

### Manual parking brake

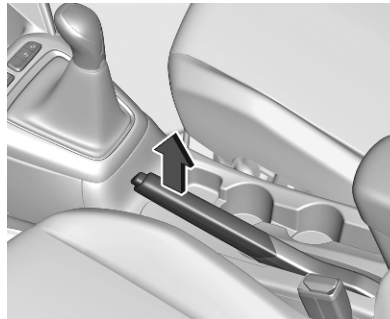

#### ⚠ Warning

Always apply parking brake firmly without operating the release button, and apply as firmly as possible on a downhill or uphill slope.

To release the parking brake, pull the lever up slightly, press the release button and fully lower the lever.

To reduce the operating forces of the parking brake, depress the foot brake at the same time.

Control indicator (!) ⇨ 69.

## Electric parking brake



### Applying when vehicle is stationary

#### **⚠ Warning**

Pull switch (P) for a minimum of 1 second until control indicator (P) illuminates constantly and electric parking brake is applied. The electric parking brake operates automatically with adequate force.

Before leaving the vehicle, check the electric parking brake status.

Control indicator (P) → 69.

The electric parking brake can always be activated, even if the ignition is off.

Do not operate electric parking brake system too often without engine running as this will discharge the vehicle battery.

#### **Releasing**

Switch on ignition. Keep foot brake pedal depressed and then push switch (P).

#### **Drive away function**

Vehicles with manual transmission: Depressing the clutch pedal and then slightly releasing the clutch pedal and slightly depressing the accelerator pedal releases the electric parking brake automatically. This is only possible if the automatic operation of the electric parking brake is activated. It is not possible when switch (P) is pulled at the same time.

Vehicles with automatic transmission: Engaging **R**, **D** or **M** and then depressing the accelerator pedal releases the electric parking brake automatically. This is only possible if the automatic operation of the electric

parking brake is activated. It is not possible when switch (P) is pulled at the same time.

#### **Braking when vehicle is moving**

When the vehicle is moving and the switch (P) is kept pulled, the electric parking brake system will decelerate the vehicle. As soon as the switch (P) is released, braking will be stopped.

The antilock brake system and the Electronic Stability Control stabilise the vehicle while the switch (P) is kept pulled. If an error of the electric parking brake occurs, a warning message is displayed in the driver information centre. If the antilock brake system and the Electronic Stability Control fail, one or both indicators (ABS) and  illuminate in the instrument cluster. In this case, stability during deceleration of the vehicle can only be maintained with repeated short pulls of the switch until the vehicle is immobilised.

### Automatic operation

Automatic operation includes automatic application and automatic release of the electric parking brake.

The electric parking brake can also be applied or released manually by using the switch (P).

Automatic application:

- The electric parking brake is automatically applied when the vehicle is stationary and the ignition is switched off.
- (P) illuminates in the instrument cluster and a display message pops up to confirm the application.

Automatic release:

#### Notice

The automatic release of the electric parking brake is inhibited as long as the driver's door is open.

- Parking brake releases automatically on driving off.
- (P) extinguishes in the instrument cluster and a display message pops up to confirm the release.

### Deactivation of automatic operation

In certain situations, e.g. in very cold weather conditions, when being towed etc., it may be necessary that the automatic operation of the electric parking brake is deactivated.

1. Start the engine.
2. If the parking brake is released, apply the parking brake pulling the switch (P).
3. Release the brake pedal.
4. Press the switch (P) for at least 10 seconds and maximum 15 seconds.
5. Release the switch (P).
6. Depress and hold the brake pedal.
7. Pull the switch (P) for 2 seconds.

The deactivation of the automatic operation of the electric parking brake is confirmed by  illuminating in the Driver Information Centre ⇨ 70. The electric parking brake can only be applied and released manually.

To reactivate the automatic operation, repeat the steps described above.

### Fault

Failure mode of electric parking brake is indicated by a control indicator (P)! and by a message displayed in the Driver Information Centre.

Vehicle messages ⇨ 79.

Control indicator (P) flashes: electric parking brake is not fully applied or released. When continuously flashing, release electric parking brake and retry applying.

### Brake assist

If brake pedal is depressed quickly and forcefully, maximum brake force is automatically applied.

Operation of brake assist might become apparent by a pulse in the brake pedal and a greater resistance when depressing the brake pedal.

Maintain steady pressure on the brake pedal as long as full braking is required. Maximum brake force is automatically reduced when brake pedal is released.

## Hill start assist

The system helps prevent unintended movement when driving away on inclines.

When releasing the brake pedal after stopping on an incline, brakes remain on for further 2 seconds. The brakes release automatically as soon as the vehicle begins to accelerate.

## Regenerative braking

### ⚠ Warning

In the case of extreme temperatures or if the high voltage battery is almost fully charged, the brake force of the engine braking may be temporarily reduced. If the braking force is not sufficient, the driver has to be prepared to use the brake pedal.

### ⚠ Warning

Depending on the engine braking force the brake lights are illuminated.

Regenerative braking generates electrical energy resulting from engine braking to charge the high voltage battery.

Electric drive unit ⇨ 114.

## Ride control systems

### Electronic Stability Control and Traction Control system

Electronic Stability Control improves driving stability when necessary, regardless of the type of road surface or tyre grip.

As soon as the vehicle starts to swerve (understeer / oversteer), engine output is reduced and the wheels are braked individually.

Electronic Stability Control operates in combination with the Traction Control system. It prevents the driven wheels from spinning.

The Traction Control system is a component of the Electronic Stability Control.

The Traction Control system improves driving stability when necessary, regardless of the type of road surface or tyre grip, by preventing the driven wheels from spinning.



As soon as the driven wheels starts to spin, engine output is reduced and the wheel spinning the most is braked individually. This considerably improves the driving stability of the vehicle on slippery road surfaces.



Electronic Stability Control and the Traction Control system are operational after each engine start as soon as the control indicator  extinguishes.

When Electronic Stability Control or the Traction Control system operates,  flashes.

On some occasions, e.g. after disconnecting the vehicle battery, the control indicator  may illuminate during some seconds accompanied by a message in the Driver Information Centre. This may be caused by the reset of the steering angle sensor.

### Warning

Do not let this special safety feature tempt you into taking risks when driving.

Adapt speed to the road conditions.

Control indicator  ⇨ 71.

### Deactivation

The Traction Control system can be deactivated in the Info Display.

Info Display ⇨ 77.

Deactivation is confirmed by a message in the Driver Information Centre.

Traction Control system is reactivated everytime the ignition has been switched on again or in the case that the vehicle is driven faster than 30 mph. It can also be reactivated via the Info Display.

### Fault

If there is a fault in the system, the control indicator  illuminates continuously, a message appears in the Driver Information Centre and a warning chime sounds. The system is not operational.

Have the cause of the fault remedied by a workshop.

### Sport mode



Sport mode adapts the settings of some vehicle systems to a sportier driving style:

- The engine reacts more quickly to accelerator pedal changes.
- Steering support is sportier.

### Activation

Press **SPORT** when engine is running.

The LED in the button illuminates when sport mode is active.

### Deactivation

Briefly press **SPORT**. The LED in the button extinguishes when sport mode is deactivated.

## Driver assistance systems

### ⚠ Warning

Driver assistance systems are developed to support the driver and not to replace the driver's attention.

The driver accepts full responsibility when driving the vehicle.

When using driver assistance systems, always take care regarding the current traffic situation.

### ⚠ Warning

Do not use a license plate support on the front bumper to ensure proper radar unit functionality.

## Cruise control

The cruise control can store and maintain speeds above 25 mph.

Additionally, at least the third gear must be engaged on some manual transmissions.

On automatic transmission, position **D** or the second or a higher gear in position **M** must be selected.

Deviations from the stored speeds may occur when driving uphill or downhill.

The system maintains the vehicle speed at the preset speed by the driver, without any action on the accelerator pedal.

The preset speed can be exceeded temporarily by pressing the accelerator pedal firmly.

The status and preset speed is displayed in the Driver Information Centre.

Do not use the cruise control if it is not advisable to maintain a constant speed.

## Switching on the system

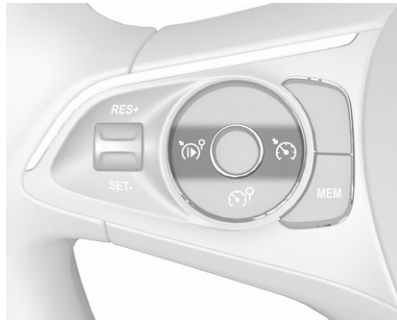

Press .

Symbol  and a message are displayed in the Driver Information Centre. The system is still not active.

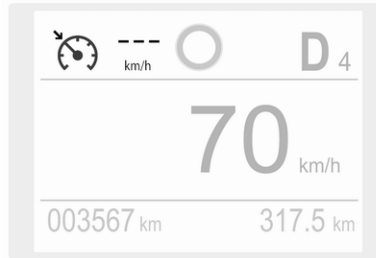

## Activation of the functionality

### Setting speed by the driver

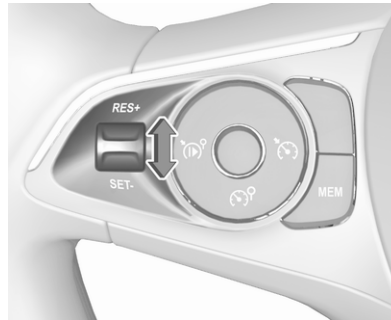

Accelerate to the desired speed and move thumb wheel once briefly to **SET/-**. The current speed is stored and maintained. Accelerator pedal can be released.

The preset speed can then be changed by moving thumb wheel to **RES/+** to increase or **SET/-** to decrease the speed. Move thumb wheel repeatedly to change speed in small steps, move and hold to change speed in large steps.

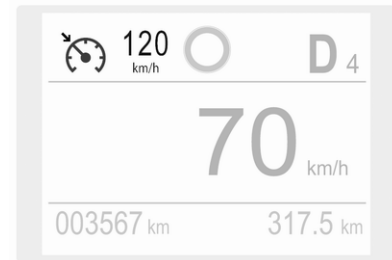

Speed value is indicated in the Driver Information Centre.

**Adopting speed by the speed limit recognition**

The intelligent speed adaptation informs the driver when a speed limit is detected by the speed limit recognition. The detected speed limit can be used as new value for the cruise control.

Using the camera at the top of the windscreen, this system detects and reads speed limit and end of speed limit signs.

With active cruise control the recognised speed limit will be displayed in the Driver Information Centre and **MEM** illuminates if the difference between set speed and speed limit is more than 6 mph.

Press **MEM** on the steering wheel to request saving of the suggested speed.

Press **MEM** on the steering wheel once more to confirm and save the new speed setting.

This speed is the new value for the cruise control.

The function can be deactivated or activated in the vehicle personalisation ↷ 80.

**Exceeding the set speed**

Vehicle speed can be increased by depressing the accelerator pedal. When the accelerator pedal is released, the previously stored speed is resumed.

**Deactivation of the functionality**

Press , cruise control is in pause mode and a message is displayed. The vehicle is driven without cruise control.

Cruise control is deactivated, but not switched off. Last stored speed remains in memory for later speed resume.

Cruise control is deactivated automatically in the following cases:

- The brake pedal is depressed.
- Vehicle speed is below 25 mph.
- The traction control system or electronic stability control is operating.

- The selector lever is in **N** (automatic transmission) or the first or second gear (on some manual transmissions) is engaged.
- The clutch pedal has been depressed for a few seconds (depending on the manual transmission).

**Resume stored speed**

Move thumb wheel to **RES/+** at a speed above 25 mph. The stored speed will be obtained.

**Switching off the system**

Press , the cruise control mode is deselected and the cruise control indication extinguishes in the Driver Information Centre.

Pressing  to activate the speed limiter deactivates cruise control.

Switching off the ignition cancels any programmed speed value.

## Fault

In the event of a cruise control fault, the speed is cleared resulting in flashing of the dashes.

The speed limit recognition may not operate correctly if traffic signs do not comply with the Vienna Convention on Road Signs and Signals.

## Speed limiter

The speed limiter prevents the vehicle from exceeding a preset maximum speed.

The maximum speed can be set at speeds above 18 mph.

The driver can accelerate the vehicle up to the preset speed. Deviations from the limited speed may occur when driving downhill.

The preset speed can be exceeded temporarily by pressing the accelerator pedal firmly.

The status and preset speed limit are displayed in the Driver Information Centre.

## Switching on the system



Press .

 and a message are displayed in the Driver Information Centre. The system is still not active.

## Activation of the functionality

### Setting speed by the driver

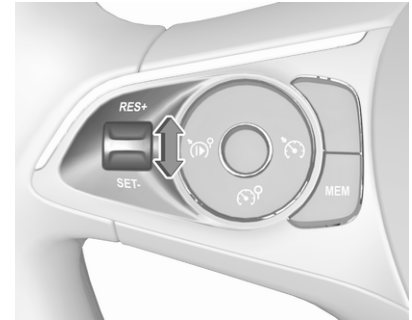

The preset maximum speed can be set by pressing thumb wheel to **RES/+** to increase or **SET/-** to decrease the desired maximum speed. Move thumb wheel repeatedly to change speed in small steps, move and hold to change speed in large steps.

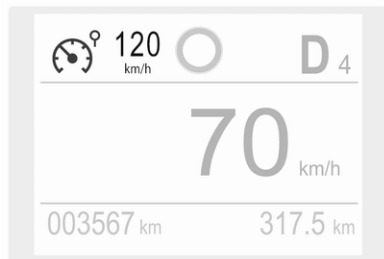

Speed value is indicated in the Driver Information Centre.

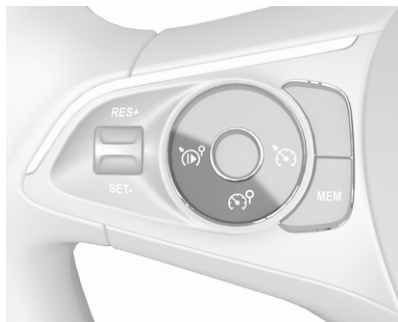

Press  to activate speed limiter.

### Adopting speed by the speed limit recognition

The intelligent speed adaptation informs the driver when a speed limit is detected by the speed limit recognition. The detected speed limit can be used as new value for the speed limiter.

Using the camera at the top of the windscreen, this system detects and reads speed limit and end of speed limit signs.

If the speed limiter is active, the recognised speed limit will be displayed in the Driver Information Centre and **MEM** illuminates if the difference between set speed and speed limit is more than 6 mph.

Press **MEM** on the steering wheel to request saving of the suggested speed limit.

Press **MEM** on the steering wheel once more to confirm and save the new speed setting.

This speed is the new value for the speed limiter.

The function can be activated or deactivated in the vehicle personalisation  80.

### Exceeding the speed limit

In the event of an emergency, it is possible to exceed the speed limit by depressing the accelerator pedal firmly to the final point. In this case, the preset speed value flashes.

Release the accelerator pedal and the speed limiter function is reactivated once a speed lower than the limit speed is obtained.

### Deactivation of the functionality

Press , speed limiter is in pause mode and a message is displayed. The vehicle is driven without speed limiter.

Speed limiter is deactivated, but not switched off. Last stored speed remains in memory for later speed resume.

### Resume limit speed

Press , the stored speed limit will be obtained.

## Switching off the system

Press , the speed limiter mode is deselected and the speed limit indication extinguishes in the Driver Information Centre.

Pressing  to activate cruise control deactivates speed limiter.

The preset speed remains in the memory when the ignition is switched off.

## Fault

In the event of a speed limiter fault, the speed is cleared resulting in flashing of the dashes.

The speed limit recognition may not operate correctly if traffic signs do not comply with the Vienna Convention on Road Signs and Signals.

## Adaptive cruise control

The adaptive cruise control is an enhancement of the cruise control with the additional feature of maintaining a certain following distance to the vehicle ahead.



It uses radar and camera sensors to detect the vehicles ahead. If no vehicle is detected in the driving path, the adaptive cruise control will behave like a conventional cruise control.

The adaptive cruise control automatically decelerates the vehicle when approaching a slower moving vehicle. It then adjusts the vehicle speed to follow the vehicle ahead at the selected following distance. The vehicle speed increases or decreases to follow the vehicle ahead, but will not exceed the set speed. It may apply limited braking with activated brake lights.

If the vehicle ahead accelerates or changes lane, the adaptive cruise control progressively accelerates the vehicle to return to the stored set speed. If the driver operates the turn lights to overtake a slower vehicle, the

adaptive cruise control allows the vehicle to temporarily approach the vehicle ahead to help passing it. However, the set speed will never be exceeded.

If the vehicle ahead is moving too slowly and the selected following distance cannot be maintained anymore, a warning chime is given and a message is displayed in the Driver Information Centre on vehicles with manual transmission. The message prompts the driver to take back control of the vehicle.

On vehicles with automatic transmission, the system can brake the vehicle until a full stop.

### Warning

The complete driver attention is always required while driving with adaptive cruise control. The driver stays fully in control of the vehicle because the brake pedal, the accelerator pedal and the button  have priority over any adaptive cruise control operation.

## Switching on the system

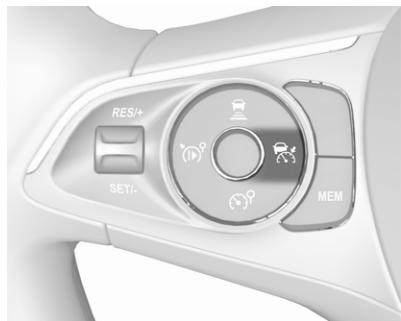

Press .

 is indicated in the Driver Information Centre. The system is still not active.



## Activation of the functionality

## Setting speed by the driver

The adaptive cruise control has to be switched on manually at a speed between 25 mph and 112 mph.

Accelerate to the desired speed and move the thumb wheel to **SET/-**. The current speed is stored and maintained.

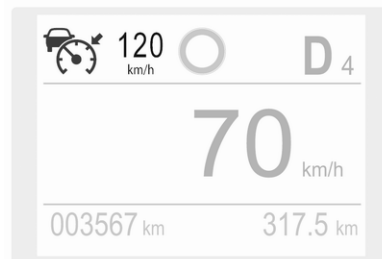

The speed value is indicated in the Driver Information Centre.

The preset speed can then be changed by moving thumb wheel to **RES/+** to increase or **SET/-** to decrease the speed. Move thumb wheel repeatedly to change speed in small steps, move and hold to change speed in large steps.

When the adaptive cruise control is operating, the stop-start system is automatically deactivated.



### Adopting speed by the speed limit recognition

The intelligent speed adaptation informs the driver when a speed limit is detected by the speed limit recognition. The detected speed limit can be taken over as new set speed for the adaptive cruise control.

Using the camera at the top of the windscreen, this system detects and reads speed limit and end of speed limit signs.

If the adaptive cruise control is active, the recognised speed limit will be displayed in the Driver Information Centre and **MEM** illuminates if the difference between set speed and speed limit is more than 6 mph.

Press **MEM** on the steering wheel to request saving of the suggested speed.

Press **MEM** on the steering wheel once more to confirm and save the new speed setting.

This speed limit is now the new set speed of the adaptive cruise control.

The function can be activated or deactivated in the vehicle personalisation ↷ 80.

### Overriding set speed

It is always possible to drive faster than the selected set speed by depressing the accelerator pedal. When the accelerator pedal is released, the vehicle returns to the stored speed. If a slower moving vehicle is ahead, the following distance selected by the driver is restored.

If the set speed is exceeded, the indicated speed setting disappears and a warning message is displayed.

#### Warning

Accelerating by the driver deactivates automatic braking by the system. This is indicated as a pop-up warning in the Driver Information Centre.

### Resuming stored speed

Move the thumb wheel to **RES/+** at a speed above 25 mph. The adaptive cruise control is activated with the stored set speed.

### Adaptive cruise control on vehicles with automatic transmission

For vehicles with automatic transmission, adaptive cruise control allows to maintain the selected distance behind a braking vehicle until a complete stop is reached.

If the system has stopped your vehicle behind another vehicle, then the set speed is replaced by a green control indicator (A). This symbol notifies, that the vehicle is hold automatically in stop position.

When the vehicle ahead drives away within some seconds and the traffic conditions allow a restart of the vehicle, then active cruise control is resumed automatically.

If the stopped vehicle ahead was stopped for a longer time and then begins to move forward, the green

control indicator (A) will flash and a warning chime will sound as a reminder to check traffic before resuming.

When the vehicle ahead drives away, depress the accelerator pedal or press  to resume adaptive cruise control.

If the vehicle stays stopped for more than 5 minutes or if the driver's door is opened and the driver's seat belt is unfastened, then the electric parking brake is applied automatically to hold the vehicle. Control indicator (P) will illuminate. To release electric parking brake, press the accelerator pedal.

Electric parking brake  127.

### Warning

When the system is deactivated or cancelled, the vehicle will no longer be held at a stop and can start moving. Be always prepared to manually apply the brake to hold the vehicle stationary.

Do not leave the vehicle while it is being held at a stop by adaptive cruise control. Always move selector lever to park position **P** and switch off the ignition before leaving the vehicle.

### Setting the following distance

When adaptive cruise control detects a slower moving vehicle in the driving path, it will adjust the vehicle speed to maintain the following distance selected by the driver.

The following distance can be set to close (1 bar), normal (2 bars) or far (3 bars).

If the engine is running and the adaptive cruise control is enabled (grey) or active (green), you can modify the following distance setting:

Press , the current setting is shown in the Driver Information Centre.



Press  again to change the following distance: The new setting is displayed in the Driver Information Centre.

The selected following distance is indicated by full bars in the adaptive cruise control page.

### Warning

The driver accepts full responsibility for the appropriate following distance based on traffic, weather and visibility conditions. Following distance must be adjusted or the system switched off when required by the prevailing conditions.

### Detecting the vehicle ahead

If the system detects a vehicle in the driving path, the adaptive cruise control symbol displayed in the Driver Information Centre changes from  to .

## Deactivation of the functionality

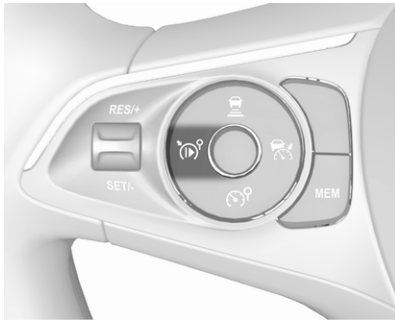

Press , the adaptive cruise control is in pause mode and a message is displayed. The vehicle is driven without adaptive cruise control.

The adaptive cruise control is deactivated, but not disabled. The last stored set speed remains in memory for later usage.

The adaptive cruise control is deactivated automatically in the following cases:

- The brake pedal is depressed.
- The vehicle accelerates above 112 mph.

- The vehicle with manual transmission slows down below 25 mph.
- The electric parking brake is applied.
- The traction control system or electronic stability control is deactivated or operating.
- The selector lever is neither in **D** nor in **M**.
- A fault is detected in the electronic stability control or the radar system.
- Immediately after the clutch pedal has been depressed or a few seconds after the clutch pedal has been depressed (depending on the manual transmission).

## Switching off the system

Press , the adaptive cruise control mode is disabled and the adaptive cruise control indication extinguishes in the Driver Information Centre.

Pressing  to activate the speed limiter deactivates adaptive cruise control.

Switching off the ignition deletes the stored set speed.

## Driver's attention

- Use the adaptive cruise control carefully on bends or mountain roads, as it can lose the vehicle ahead and needs time to detect it again.
- Do not use the system on slippery roads as it can create rapid changes in tyre traction (wheel spinning), so that you could lose control of the vehicle.
- Do not use the adaptive cruise control during rain, snow or heavy dirt, as the radar sensor can be covered by a water film, dust, ice or snow. This reduces or suppresses completely the visibility. In case of sensor blockage, clean the sensor cover.
- Do not use the system when the spare wheel is in use.

## System limits

**⚠ Warning**

The system's automatic brake force does not permit hard braking and the braking level may not be sufficient to avoid a collision.

- After a sudden lane change, the system needs a certain time to detect the next preceding vehicle. So if a new vehicle is detected, the system may accelerate instead of braking.
- The adaptive cruise control does ignore the oncoming traffic.
- The adaptive cruise control does not consider pedestrians and animals for braking and driving off.
- The adaptive cruise control considers stopped vehicles only at low speed.

- Do not use the adaptive cruise control when towing a trailer.
- Do not use the adaptive cruise control on roads with an incline of more than 10%.

As the radar's field of detection is quite narrow, it is possible that the system may not detect:

- vehicles of reduced width, e.g. motorcycles, scooters
- vehicles not running in the middle of the lane
- vehicles entering a corner
- vehicles suddenly pulling out

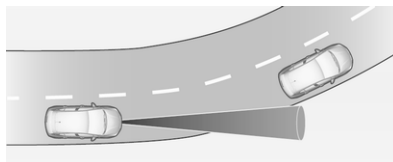
**Bends**

The adaptive cruise control calculates a predicted path based on the centrifugal force. This predicted path considers the current bend characteristic, but cannot consider a

future bend change. The system may lose the current vehicle ahead or consider a vehicle which is not in the actual lane. This can happen when entering or exiting a bend or if the bend gets stronger or weaker. If it no longer detects any vehicle ahead, then  will extinguish.

If the centrifugal force is too high in a bend, the system slows down the vehicle slightly. This braking level is not designed to avoid spinning-off the bend. The driver is responsible for reducing the selected speed before entering a bend and in general to adapt the speed to the road type and to existing speed limits.

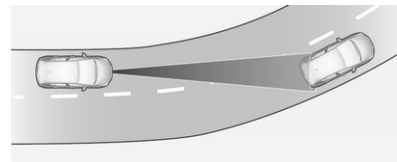
**Motorways**

On motorways, adapt the set speed to the situation and the weather. Always consider that adaptive cruise

control has a limited visibility range, a limited braking level and a certain reaction time to verify if a vehicle is on the driving path or not. Adaptive cruise control may not be able to brake the vehicle in time to avoid a collision with a much slower vehicle or after a lane change. This is particularly true while driving fast or if the visibility is reduced due to weather conditions.

While entering or exiting a motorway, adaptive cruise control may lose the vehicle ahead and accelerate up to the set speed. For this reason, decrease the set speed before the exit or before the entry.

### Vehicle path changes

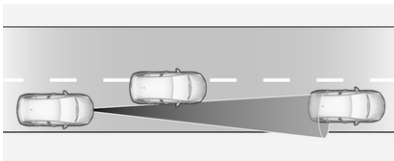

If another vehicle enters your driving path, adaptive cruise control will first consider the vehicle when it is completely in your path. Be ready to

take action and depress the brake pedal if you need to brake more quickly.

### Hill considerations



#### Warning

Do not use the adaptive cruise control on steep hill roads.

System performance on hills depends on vehicle speed, vehicle load, traffic conditions and the road gradient. It may not detect a vehicle in your path while driving on hills. On steep hills, you may have to use the accelerator pedal to maintain your vehicle speed. When going downhill you may have to brake to maintain or reduce your speed.

Note that applying the brake deactivates the system.

### Radar unit



The radar unit is located in the middle of the front bumper.

#### Warning

The radar unit was aligned carefully during manufacture. Therefore, in the event of a front-end impact, do not use the system. The front bumper may appear to be intact, however the sensor behind may be affected and react incorrectly. After an accident, consult a workshop to verify and adjust the radar unit position.

**⚠ Warning**

Do not use a license plate support on the front bumper to ensure proper radar unit functionality.

**Fault**

In the event of an adaptive cruise control fault, a warning light is illuminated in the instrument cluster and a warning message is displayed in the Driver Information Centre accompanied by an audible signal.

The adaptive cruise control may not operate correctly if traffic signs do not comply with the Vienna Convention on Road Signs and Signals.

Have the system checked by a dealer or a qualified workshop.

As a safety measure, do not use the system if the brake lights are faulty. Do not use the system if the front bumper is damaged.

**Forward collision alert**

The forward collision alert may help to avoid or reduce the harm caused by front-end crashes.

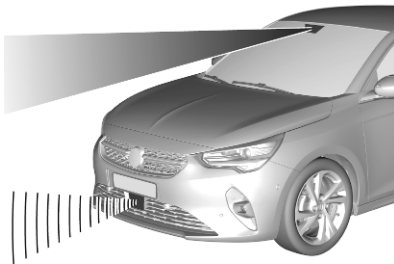

The forward collision alert uses the front camera in the windscreen and depending on the vehicle configuration a radar unit located behind the front bumper to detect a vehicle directly ahead, in the path.

If a vehicle directly ahead is approached too quickly, a warning chime sounds and a message is displayed in the Driver Information Centre.

**⚠ Warning**

Forward collision alert is just a warning system and does not apply the brakes. When approaching a vehicle ahead too rapidly, it may not provide you enough time to avoid a collision.

The driver accepts full responsibility for the appropriate following distance based on traffic, weather and visibility conditions.

The complete attention of the driver is always required while driving. The driver must always be ready to take action and apply the brakes.

**Activation**

The forward collision alert operates from 3 mph to vehicle's maximum speed.

## Alerting the driver

The driver is warned by following alerts:

- A warning message is displayed in the Driver Information Center, when the distance to the vehicle ahead gets too small.
- A warning message is displayed in the Driver Information Center and a warning chime sounds, when a collision is imminent and immediate driver's action is required.
- In some cases, the system performs a short braking, when a collision is imminent and immediate driver's action is required.

## Selecting the alert sensitivity

Three alert sensitivities can be selected in the settings of the active emergency braking within the vehicle personalisation ⇨ 80.

The chosen setting will be memorised when the ignition has been switched off. The alert timing will vary based on selected alert setting.

## Deactivation

The system can only be deactivated by deactivating the active emergency braking in the vehicle personalisation ⇨ 80. When ignition is switched on next time, system is activated.

## System limitations

Forward collision alert is designed to warn on vehicles, pedestrians and cyclists, but may react also to other objects.

In the following cases, forward collision alert may not detect a vehicle ahead or sensor performance is limited:

- driving on winding or hilly roads
- driving during nighttime
- weather limits visibility, such as fog, rain, or snow
- the sensor in the windscreen or the radar unit behind the front bumper is blocked by snow, ice, slush, mud, dirt or by foreign objects, e.g. stickers

- the windscreen is damaged or affected by foreign objects, e.g. stickers
- the bumper is damaged or affected by foreign objects, e.g. license plate support

## Active emergency braking

Active emergency braking can help to reduce the damage and injury from crashes with vehicles and pedestrians directly ahead, when the driver does not actively take action either by manual braking or by steering. Before the active emergency braking applies, the driver is warned by the forward collision alert.

Forward collision alert ⇨ 144.

Front pedestrian protection ⇨ 148.

Active emergency braking can be deactivated in the vehicle personalisation ⇨ 80. If deactivated,  illuminates in the instrument cluster. When ignition is switched on next time, system is activated by default.

The feature uses various inputs (e.g. camera sensor, radar sensor) to calculate the probability of a frontal collision.

### **Warning**

This system is not intended to replace the driver responsibility for driving the vehicle and looking ahead. Its function is limited to supplemental use only to reduce the vehicle speed before a collision.

The system may not react to animals. After a sudden lane change, the system needs a certain time to detect the next preceding vehicle.

The driver must always be ready to take action and apply the brakes and steer to avoid collisions.

### **Functionality**

Depending on the vehicle configuration and the detected objects, there are several operational speed ranges.

On vehicles equipped only with front camera, the active emergency braking operates from 3 mph to 50 mph when a vehicle has been detected.

On vehicles equipped with radar sensor and front camera, the active emergency braking operates from 3 mph to 87 mph when a vehicle has been detected.

Active emergency braking only works when the seat belts of the front passengers are fastened.

The system includes:

- brake preparation system
- emergency automatic braking
- smart brake assist
- forward collision alert
- front pedestrian protection

### **Brake preparation system**

When approaching a vehicle ahead or a pedestrian so quickly that a collision is likely, the brake preparation system slightly pressurises the brakes. This reduces the response time, when braking is requested.

### **Emergency automatic braking**

After activation of brake preparation system and just before the imminent collision, this function automatically applies braking to reduce the impact speed of the collision or prohibit a crash.

If active emergency braking is applied,  flashes in the instrument cluster.

Emergency automatic braking is designed to react on vehicles, pedestrians or cyclist ahead.

Forward collision alert ⇨ 144.

Front pedestrian protection ⇨ 148.

Below a speed of 19 mph, emergency automatic braking may slow down the vehicle to a complete stop. If the



speed exceeds 19 mph, emergency automatic braking reduces the speed. However, the driver must apply the brake to come to a complete stop.

**Automatic transmission:** If the vehicle comes to a complete stop, automatic braking is maintained for a certain time. Keep the brake pedal depressed to prevent the vehicle from starting off again.

**Manual transmission:** If the vehicle comes to a complete stop, the engine may stall.

Cruise control will be deactivated when an emergency automatic braking occurs.

### **Warning**

Do not rely on the system to brake the vehicle. Emergency automatic braking will not brake outside of its operating speed range and only responds to detected vehicles and pedestrians.

### **Smart brake assist**

If the driver brakes, but not sufficiently to avoid a collision, this system will supplement the braking. This assistance will only be provided if the driver presses the brake pedal.

Smart brake assist will automatically disengage when the brake pedal is released.

Forward collision alert ⇨ 144.

Front pedestrian protection ⇨ 148.

### **System limitations**

In some cases, the active emergency braking system may provide an automatic braking in situations that seem to be unnecessary, for instance in parking garages, due to various types of objects, i.e., traffic signs or vehicles in another lane. Firmly apply the accelerator pedal to override the automatic braking if the situation and the surroundings permit.

In the following cases, active emergency braking performance might be limited:

- driving on winding or hilly roads
- detecting vehicles with a trailer, tractors, muddy vehicles, etc.
- detecting a vehicle when weather limits visibility, such as in fog, rain, or snow
- driving during nighttime
- the sensor in the windscreen or the radar unit behind the front bumper is blocked by snow, ice, slush, mud, dirt or by foreign objects, e.g. stickers
- the windscreen is damaged
- the bumper is damaged or affected by foreign objects, e.g. license plate support

Complete attention is always required while driving, and be ready to take action to avoid crashes.

We recommend to deactivate the system in the vehicle personalisation in the following cases:

- when towing a trailer or caravan
- when carrying long objects on roof bars or a roof rack
- when the vehicle is being towed with the engine running
- when the vehicle is fitted with snow chains
- when a spare wheel is fitted that is smaller than the other wheels
- before using an automatic car wash with the engine running
- before placing the vehicle on a rolling road in a workshop
- if the windscreen has been damaged close to the camera
- if the front bumper has been damaged
- if the brake lights are not working

### Fault

In case the system requires a service, a message is displayed in the Driver Information Centre.

If the system does not work properly, vehicle messages are displayed in the Driver Information Centre.

Vehicle messages ⇨ 79.

### Front pedestrian protection

Front pedestrian protection may help to avoid or reduce the harm caused by front-end crashes with pedestrians when driving forward.

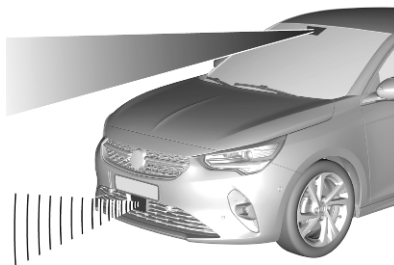

The system uses the front camera in the windscreen and depending on the vehicle configuration a radar unit in the front bumper to detect a pedestrian directly ahead in the path.

### ⚠ Warning

Do not use a license plate support on the front bumper to ensure proper radar unit functionality.

Front pedestrian protection can detect and alert to pedestrians in a forward gear at speeds between 3 mph and 37 mph. Additionally, it can automatically brake the vehicle.

During nighttime driving, system performance is limited.

### ⚠ Danger

Front pedestrian braking does not provide an alert or automatically brake the vehicle, unless it detects a pedestrian.

The system may not detect pedestrians, including children, when the pedestrian is not directly ahead, not fully visible, not standing upright, or when part of a group.

The system can only be deactivated by deactivating the active emergency braking in the vehicle personalisation ↻ 80. When ignition is switched on next time, system is activated.

### Front pedestrian alert

When approaching a detected pedestrian too quickly, a warning message is displayed in the Driver Information Centre. A warning chime is provided.

Cruise control may be disengaged when the front pedestrian alert occurs.

### System limitations

In the following cases, front pedestrian protection may not detect a pedestrian ahead or sensor performance is limited:

- driving on winding or hilly roads
- driving in the dark
- weather limits visibility, such as fog, rain, or snow

- the sensor in the windscreen or the radar unit behind the front bumper is blocked by snow, ice, slush, mud, dirt or by foreign objects, e.g. stickers
- the windscreen is damaged
- the bumper is damaged or affected by foreign objects, e.g. license plate support

## Parking assist

### General information

The system is deactivated when a plug is connected to the power outlet of the trailer hitch.

#### Warning

The driver bears full responsibility for the parking manoeuvre.

Always check the surrounding area when driving backwards or forwards while using parking assist system.

### Notice

It is possible that the sensor detects a non-existing object caused by echo disturbance from external acoustic noise or mechanical misalignments (sporadic false warnings may occur).

### Rear parking assist

The system warns the driver with warning chimes and display indication against potentially hazardous obstacles behind the vehicle while reverse gear is engaged.

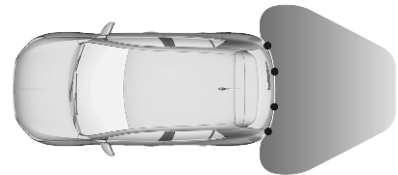

The system operates with ultrasonic parking sensors in the rear bumper.

**Activation**

The system is ready to operate when the LED in the parking assist button  $P_{OFF}$  is not illuminated or when  $P_{OFF}$  extinguishes in the Driver Information Centre. The state of the system is memorised when the ignition is switched off.

Once activated, rear parking assist is ready to operate when reverse gear is engaged.

**Indication**

As soon as an obstacle gets closer to the vehicle, you will hear acoustic warning chimes. The interval between the sounds becomes shorter

as the vehicle gets closer to that obstacle. When the distance is less than approx. 30 cm, the sound is continuous.

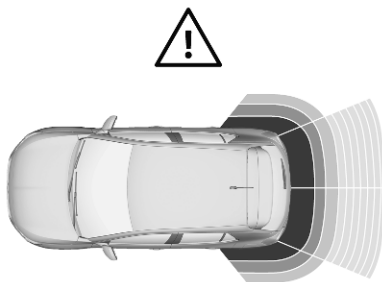

Additionally, the distance to rear obstacles is displayed by changing distance lines in the Info Display ↻ 77. When the obstacle is very close,  $\triangle$  for danger is displayed.

**Deactivation**

The system is switched off when reverse gear is disengaged. Press  $P_{OFF}$  to deactivate the system manually. Depending on version, the LED in the button illuminates or  $P_{OFF}$  illuminates in the Driver Information Centre together with a warning message and accompanied by a warning chime, when the system is deactivated. If the system has been deactivated manually, it is not reactivated automatically the next time the ignition is switched on.

## Front-rear parking assist

Depending on the amount of installed ultrasonic parking sensors, the system operates differently:

### 8 ultrasonic parking sensors

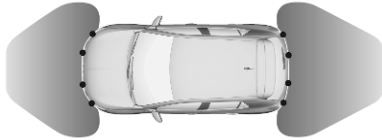

If the vehicle is equipped with four ultrasonic parking sensors each in both the rear and front bumper, the front-rear parking assist measures the distance between the vehicle and obstacles in front and behind the vehicle. It informs and warns the driver by giving warning chimes and display indication.

#### Indication

The system warns the driver with warning chimes against potentially hazardous obstacles in front of the vehicle and behind the vehicle.

The interval between the sounds becomes shorter as the vehicle gets closer to that obstacle. When the distance is less than approx. 30 cm, the sound is continuous.

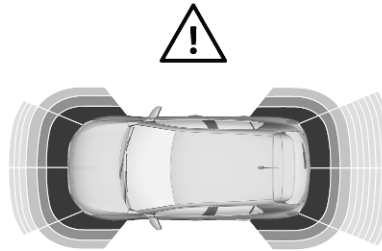

Additionally, the distance to rear and front obstacles is displayed by changing distance lines in the Info Display ↗ 77.

If the vehicle stops for more than 3 seconds in a forward gear, if the automatic transmission is in **P** position or the vehicle speed exceeds 6 mph, no acoustic warning chimes are given and no visual feedback is displayed in the Info Display.

### 12 ultrasonic parking sensors

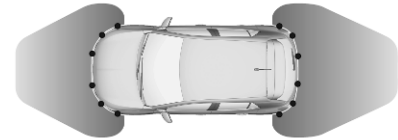

If the vehicle is equipped with six ultrasonic parking sensors each in both the rear and front bumper, the system warns the driver by display indication and warning chimes. However, the display indication can vary depending on version.

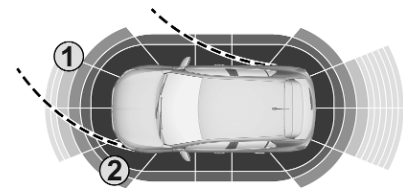

If the obstacle (1) is within the driving path and might lead to a collision, a warning chime is given.

Obstacles (2) that are close to the vehicle, but not within the calculated driving path are indicated in the Info Display, but no warning chime is given.

### Side protection

If the obstacle is alongside the vehicle and within the driving path and might lead to a collision, a warning chime is given. Obstacles alongside the vehicle are only considered if they have been previously recognised by the parking sensors and memorised by the system.

#### **Warning**

Only fixed obstacles are indicated correctly.

Moving obstacles detected at the beginning of a manoeuvre may be indicated mistakenly.

Moving obstacles that appear alongside the vehicle and were not previously recognised by the parking sensors will not be indicated.

Objects memorised during the manoeuvre will only be considered during the current ignition cycle.

### Side protection on vehicles equipped with advanced parking assist

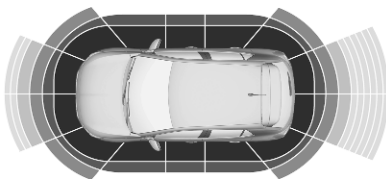

This function warns the driver also by display indication in the case of obstacles alongside the vehicle.

### Activation

When a forward gear has been engaged, the front parking assist is triggered, as soon as an obstacle is detected in the front and the speed of the vehicle is below 6 mph.

When the reverse gear has been engaged, the front parking assist is triggered additionally to the rear parking assist.



The system is ready to operate when the LED in the parking assist button  $P_{\text{OFF}}$  is not illuminated or when  $P_{\text{OFF}}$  extinguishes in the Driver Information

Centre. The state of the system is memorised when the ignition is switched off.

### Deactivation

The system is deactivated by pressing the parking assist button .

When the system is deactivated manually, the LED in the button illuminates or  illuminates in the Driver Information Centre together with a warning message and accompanied by a warning chime.

If the system has been deactivated manually, it is not reactivated automatically the next time the ignition is switched on.

### System limitations

In the event of a fault or if the system does not work temporarily, e.g. due to high external noise level or other interference factors,  illuminates in the instrument cluster. A message is displayed in the Driver Information Centre and a warning chime sounds.

### Notice

Make sure that the front number plate is properly mounted, vertically and horizontally centred and the sensors are firmly in place. The performance of the parking assist will be reduced if the license plate is bent or a license plate support is used.

### Warning

Under certain circumstances, various reflective surfaces on objects or clothing as well as external noise sources may cause the system to fail to detect obstacles.

Special attention must be paid to low obstacles which can damage the lower part of the bumper.

### Caution

Performance of the system can be reduced when sensors are covered, e.g. by ice or snow.

Performance of the parking assist system can be reduced due to heavy loading.

Special conditions apply if there are taller vehicles in the vicinity (e.g. off-road vehicles, mini vans, vans). Object identification and correct distance indication in the upper part of these vehicles cannot be guaranteed.

Objects with a very small reflection cross-section, e.g. objects of narrow size or soft materials, may not be detected by the system.

Parking assist systems do not detect objects outside the detection range.

## Advanced parking assist

### ⚠ Warning

The driver bears full responsibility for accepting the parking slot suggested by the system and the parking manoeuvre.

Always check the surrounding area in all directions when using the advanced parking assist.

The advanced parking assist measures a suitable parking slot while passing, calculates the trajectory and automatically steers the vehicle while parking.

Advanced parking assist provides assistance for the following manoeuvres:

- entry into a parallel parking slot
- entry into a perpendicular parking slot
- exit from a parallel parking slot

The driver must control acceleration, braking and gear shifting, while steering is done automatically. The driver can take control at any time by gripping the steering wheel.

It may be necessary to move forwards and backwards more than once.

Instructions are given in the Info Display ↪ 77.

Advanced parking assist can only be activated when driving forwards.

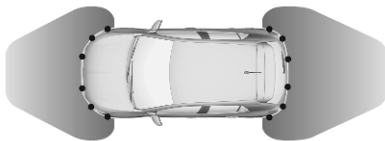

Advanced parking assist is always combined with front-rear parking assist.

The system has six ultrasonic parking sensors each in both the rear and front bumper.

## Entry into a parallel parking slot

### Activation

Slow down the vehicle speed below 19 mph.



Press **P** or activate the system via the Info Display.

Info Display ↪ 77.



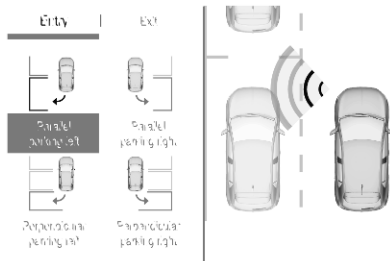

Select the parallel parking slot menu.  $P_{\text{P}}$  is illuminated in the instrument cluster to confirm the activation of the system.

The allowed parallel distance between the vehicle and a row of parked cars is between 0.5 m and 1.5 m.

The system will not identify slots that are clearly smaller or larger than the vehicle.

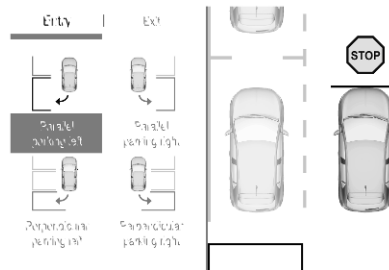

When a free slot is detected, a visual feedback on the Info Display and a first acoustic signal are given.

Drive slowly forwards. When the second acoustic signal is given, stop the vehicle, select reverse gear, release the steering wheel and start moving slowly. A visual feedback is given on the Info Display.

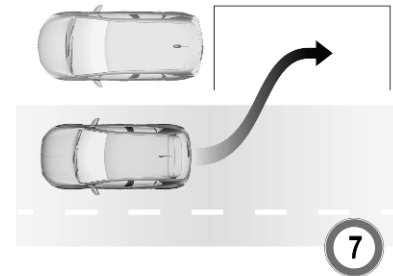

Move forwards and backwards while observing the warnings of the parking assist until the end of manoeuvre is indicated.

### Entry into a perpendicular parking slot

#### Activation

Slow down the vehicle speed below 19 mph.



Press P or activate the system via the Info Display.  
Info Display ⇨ 77.

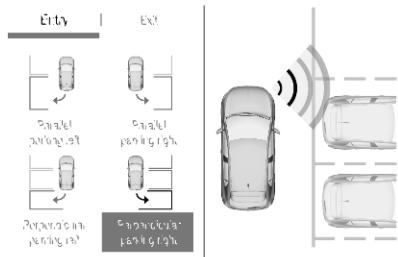

Select the perpendicular parking slot menu. P is illuminated in the instrument cluster to confirm the activation of the system.

The allowed parallel distance between the vehicle and a row of parked cars is between 0.5 m and 1.5 m.

When several successive slots are found, the vehicle will be directed towards the last one.

The system will not identify slots that are clearly smaller or larger than the vehicle.

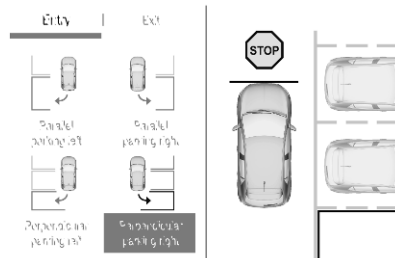

When a free slot is detected, a visual feedback on the Info Display and an acoustic signal are given. Stop the vehicle, select reverse gear, release the steering wheel and start moving without exceeding 4 mph.

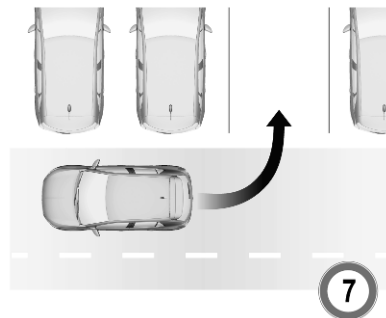

Move forwards and backwards as instructed by observing the warnings of the parking assist and paying attention to the acoustic signals until the end of manoeuvre is indicated.

During the parking manoeuvre, the system is automatically deactivated once the rear of the vehicle is within 50 cm of an obstacle.

## Exiting a parallel parking slot

### Activation



Press **P** or activate the system via the Info Display.  
Info Display  $\rightarrow$  77.

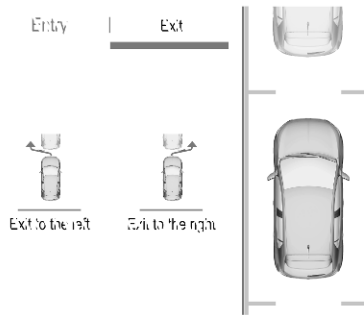

Select the exit side in the menu. **P** is illuminated in the instrument cluster to confirm the activation of the system. Engage reverse or forward gear, release the steering wheel and start moving without exceeding 3 mph.

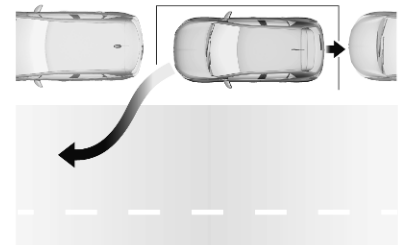

Move forwards and backwards while observing the warnings of the parking assist until the end of manoeuvre is indicated.

The manoeuvre is complete when the vehicle's front wheels are out of the parking slot.

After deactivation check control over the vehicle.

### Display indication

The instructions on the display show:

- general hints and warning messages
- the demand to stop the vehicle, when a parking slot is detected

- the direction of driving during the parking manoeuvre
- the demand to shift into reverse or first gear
- the demand to stop or to drive slowly
- the successful completion of the parking manoeuvre indicated by a pop-up symbol and a chime
- the cancelling of a parking manoeuvre

### Deactivation

The current park assist manoeuvre is cancelled via the button to return to the previous screen in the Info Display. To deactivate the system completely, press  in the centre console.

The system is deactivated automatically:

- if the ignition is switched off
- if stalling the engine
- if no manoeuvre is started within 5 minutes of selection of the type of manoeuvre

- after a prolonged stop of the vehicle during a manoeuvre
- activating the turn light on the opposite side to that of the manoeuvre
- if the electronic stability control is triggered
- if the speed of the vehicle exceeds the stated limit
- when the driver interrupts movement of the steering wheel
- after ten manoeuvres to enter or exit a parallel parking slot or after seven manoeuvres to enter a perpendicular parking slot
- by opening the driver's door
- if one of the front wheels encounters an obstacle
- parking manoeuvre successfully ended

Deactivation by the driver or by the system during manoeuvring will be indicated on the display. Additionally, a chime sounds.

The system is deactivated when a plug is connected to the power outlet of the trailer hitch.

Contact your dealer to switch off the system for a prolonged period.

### Fault

In the event of a fault, a message is displayed in the Colour Info Display, accompanied by an acoustic signal.

In the event of a fault in the power steering,  illuminates and a message is displayed in the Driver Information Centre.

### Warning

Under certain circumstances, various reflective surfaces on objects or clothing as well as external noise sources may cause the system to fail to detect obstacles.

Special attention must be paid to low obstacles which can damage the lower part of the bumper.

### Caution

Performance of the system can be reduced when sensors are covered, e.g. by ice or snow.

Performance of the parking assist system can be reduced due to heavy loading.

Special conditions apply if there are taller vehicles in the vicinity (e.g. off-road vehicles, mini vans, vans). Object identification and correct distance indication in the upper part of these vehicles cannot be guaranteed.

Objects with a very small reflection cross-section, e.g. objects of narrow size or soft materials, may not be detected by the system.

Parking assist systems do not detect objects outside the detection range.

### Notice

It is possible that the sensor detects a non-existing object caused by echo disturbance from external

acoustic noise or mechanical misalignments (sporadic false warnings may occur).

Make sure that the front number plate is properly mounted (not bent and no gaps to the bumper on the left or right side) and the sensors are firmly in place.

Advanced parking assist system may not respond to changes in the available parking space after initiating a parking manoeuvre. The system may recognize an entry, a gateway, a courtyard or even a crossing as a parking slot. After selecting reverse gear the system will start a parking manoeuvre. Take care regarding the availability of the suggested parking slot.

Surface irregularities, e.g. on construction zones, are not detected by the system. The driver accepts responsibility.

### Side blind spot alert

Side blind spot alert assist helps to avoid crashes due to unintentional lane departures when an object is detected within a specified blind spot zone.

The system displays a visual alert in each exterior mirror, when detecting objects that may not be visible in the interior and exterior mirrors.

Side blind spot alert uses some of the advanced parking assist sensors which are located in the front and rear bumper on both sides of the vehicle.

### Warning

Side blind spot alert is only a lane changing aid and does not replace driver vision.

Side blind spot alert does not detect:

- Vehicles outside the side blind zones which may be rapidly approaching.
- Pedestrians or animals.

- Non-moving objects, e.g. stationary vehicles, street lights, road signs, etc.

Failure to use proper care when changing lanes may result in damage to the vehicle, injury, or death. Always check the outside and rearview mirrors, glance over your shoulder, and use the turn signal before changing lanes.

### Activation

The system can be activated via the vehicle settings menu in the Info Display.

Info Display ⇨ 77.

### Functionality

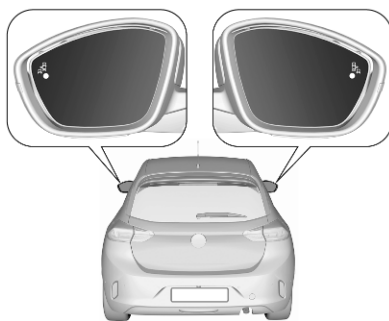

When the system detects a vehicle in the side blind zone while driving forwards, an LED will illuminate in the relevant exterior mirror.

The LED comes on immediately when your vehicle is being passed.

The LED comes on after a delay when your vehicle is passing another vehicle slowly.

### Operation conditions

The following conditions must be fulfilled for proper operation:

- all vehicles are moving in the same direction and in adjacent lanes
- the speed of your vehicle is between 7 or 20 and 87 mph
- passing a vehicle with a speed difference of less than 6 mph
- another vehicle is passing with a speed difference of less than 15 mph
- the traffic flow is normal
- driving on a straight or slightly curved road
- the sensors are not covered by mud, ice or snow
- the warning zones in the door mirrors or the detection zones on front and rear bumper are not covered with adhesive labels or other objects

No alert will be given in the following situations:

- in the presence of non-moving objects, e.g. parked vehicles, barriers, street lamps, road signs
- in very dense traffic, when moving vehicles might be confused with a stationary object
- with vehicles moving in the opposite direction
- driving on a winding road or a sharp corner
- when passing or being passed by a very long vehicle, e.g. lorry, coach, which is at the same time detected at the rear in the blind spot angle and present in the driver's forward field of vision
- when passing too quickly

### Deactivation

The system can be activated via the vehicle settings menu in the Info Display.

Info Display ⇨ 77.

The state of the system is memorised when switching off the ignition.

The system is deactivated when a plug is connected to the power outlet of the trailer hitch.

Due to adverse weather conditions, such as heavy rain, false detections may occur.

### Fault

In the event of a fault,  illuminates in the instrument panel, accompanied a display message. Contact a dealer or a qualified workshop to have the system checked.

### Active side blind spot detection

In addition to the regular side blind spot alert, the active side blind spot detection corrects the vehicle's trajectory by turning the steering wheel gently back into lane when an object is detected within a specified blind spot zone. The system is only active when side blind spot alert and lane keep assist are activated as well.

Lane keep assist ⇨ 166.

Active side blind spot detection operates when the vehicle speed is between 40 and 87 mph.

### Functionality

When steering towards the detected vehicle is attempted, the driver will then notice a turning movement of the steering wheel towards the opposite side. Turn steering wheel in the same direction if the system does not steer sufficiently.

The system also intervenes even if the turn lights have been activated.

### Panoramic view system

This system allows views of the vehicle's surroundings to be displayed as a nearly 180° picture in the Info Display, like a bird's eye view.

The system may use:

- rear camera, installed in the rear bumper
- ultrasonic parking sensors in the rear bumper

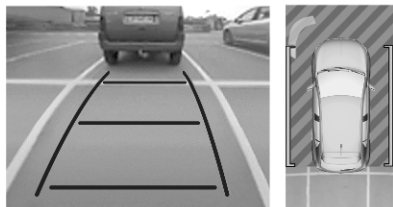

The screen in the Info display is divided into two parts. On the right there is a view from above the vehicle, and on the left there is the view from the rear displayed. If the vehicle is equipped with ultrasonic parking sensors, they complete the information on the view from above the vehicle.

### Activation

The panoramic view system is activated when the reverse gear is engaged.

### Functionality

Different views can be selected in the left part of the display. Change the type of view at any time during a manoeuvre by pressing the touch field in the left lower zone of the display and selecting a view from the view selection menu:

- Standard view
- Auto mode
- Zoom view
- 180° view

The display is immediately updated with the type of view selected.

Auto mode is activated by default. In this mode, the system selects the best view, standard or zoom, to display according to the information from the parking sensors.

The state of the system is not kept in memory when the ignition is switched off.

### Standard view



The area behind the vehicle is displayed in the screen. The vertical lines represent the width of the vehicle with mirrors unfolded. The direction of the lines changes with the position of the steering wheel.

The first horizontal line represents a distance of about 30 cm beyond the edge of vehicle's rear bumper. The upper horizontal lines represent distances of about 1 m and 2 m.

This view is available in auto mode or in the view selection menu.



### Auto mode

This mode is activated by default. If the vehicle is equipped with ultrasonic parking sensors, the automatic view changes from rear view or front view to a view from above, as an obstacle is approached during a manoeuvre.

If the vehicle is not equipped with ultrasonic parking sensors, the view needs to be changed manually in the Info Display.

### Zoom view

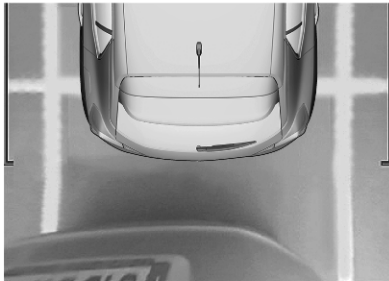

The camera records the vehicle's surroundings during the manoeuvre in order to reconstruct a view from above the rear or the front of the

vehicle in its near surroundings. Thus, the vehicle can be manoeuvred around obstacles nearby. This view is available with auto mode or in the view selection menu.

### 180° view

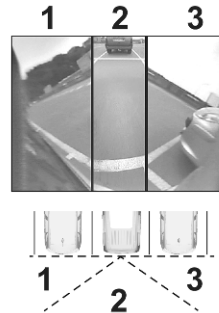

The 180° view facilitates reversing out of a parking bay, making it possible to see the approach of vehicles, pedestrians and cyclists. This view is not recommended for carrying out a complete manoeuvre. It is made up of three areas: left 1, centre 2 and right 3. This view is available from the view selection menu only.

### Deactivation

Panoramic view system is deactivated when:

- a plug is connected to the power outlet of the trailer hitch
- a certain forward speed is exceeded or if reverse gear is not engaged for 7 seconds
- by pressing the icon ⊗ in the left upper corner of the touch screen

### General information

#### ⚠ Warning

The panoramic view system does not replace driver vision. It will not display children, pedestrians, cyclists, crossing traffic, animals, or any other objects outside of the camera view area, e. g. below the bumper, or underneath the vehicle.

Do not drive or park the vehicle using only the panoramic view system.

Always check the surrounding of the vehicle before and during driving.

Displayed images may be further or closer than they appear. The area displayed is limited and objects that are close to either edge of the bumper or under the bumper are not displayed on the screen.

### System limitations

#### Caution

For optimal operation of the system, it is important to keep the lense of the camera in the tailgate between the number plate lights always clean. Rinse the lenses with water and wipe with a soft cloth.

Do not clean the lenses with a steam-jet or high-pressure jet cleaner.

The panoramic view system may not operate properly when:

- surrounding is dark
- sun or beam of headlights is shining directly into camera lenses
- weather limits visibility, such as fog, rain, or snow
- camera lenses blocked by snow, ice, slush, mud, dirt. Clean the lense, rinse with water, and wipe with a soft cloth
- vehicle had a rear end accident
- extreme temperature changes

### Rear view camera

The rear view camera assists the driver when reversing by displaying a view of the area behind the vehicle.

The view of the camera is displayed in the Info Display.

#### Warning

The rear view camera does not replace driver vision. Note that objects that are outside the camera's field of view and the parking assist sensors, e.g. below the bumper or underneath the vehicle, are not displayed.

Do not reverse or park the vehicle using only the rear view camera.

Always check the surrounding of the vehicle before and during driving.

### Activation

Rear view camera is activated when reverse gear is engaged.

## Functionality

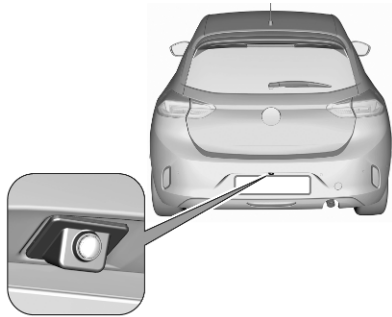

The camera is mounted in the rear bumper above the number plate.

The area displayed by the camera is limited. The distance of the image that appears on the display differs from the actual distance.

### Guidelines

The first horizontal line represents a distance of about 30 cm beyond the edge of vehicle's rear bumper. The upper horizontal lines represent distances of about 1 m and 2 m.

Trajectory lane of the vehicle is shown in accordance with the steering angle.

### Deactivation

The camera is deactivated when:

- a plug is connected to the power outlet of the trailer hitch
- a certain forward speed is exceeded or if reverse gear is not engaged for 7 seconds
- by pressing the icon  in the left upper corner of the touch screen

### System limitations

#### Caution

For optimal operation of the system, it is important to keep the lense of the camera in the tailgate always clean. Rinse the lenses with water and wipe with a soft cloth.

Do not clean the lenses with a steam-jet or high-pressure jet cleaner.

The rear view camera may not operate properly when:

- surrounding is dark
- sun or beam of headlights is shining directly into camera lenses
- weather limits visibility, such as fog, rain, or snow
- camera lenses blocked by snow, ice, slush, mud, dirt. Clean the lense, rinse with water, and wipe with a soft cloth
- vehicle had a rear end accident
- extreme temperature changes

### Traffic sign assistant

The traffic sign assistant is an extension of the speed limit recognition available for speed limiter and cruise control.



The system recognises the traffic signs above and displays them in the Driver Information Centre.

### Warning

The actual traffic sign always takes priority over the traffic sign displayed in the Driver Information Centre.

Speed limiter ⇨ 135.

Cruise control ⇨ 132.

Adaptive cruise control ⇨ 137.

Driver Information Centre ⇨ 74.

## Lane keep assist

Lane keep assist supports the driver to avoid unintended leaving of the lane. The front camera observes road edges, as well as the lane markings between which the vehicle is driving. If the vehicle approaches a road edge or a lane marking, the steering wheel is gently turned to position so that the vehicle turns back into the lane. The driver will then notice a turning movement of the steering wheel. Turn

steering wheel in same direction, if the system does not steer sufficiently. Turn steering wheel gently into opposite direction, if lane change is intended.

When the system steers to correct the trajectory of the vehicle,  flashes yellow in the instrument cluster.

Unintended lane departure is not assumed by the system when the turn lights are operated and during few seconds after turn lights have been switched off.

If the system detects that the steering wheel is not held permanently, it interrupts the correction. A warning message in the Driver Information Centre accompanied by a warning chime alerts when immediate driver's action is required.

If the vehicle is equipped with active side blind spot detection, the interruption of the lane correction might be cancelled.

Side blind spot alert ⇨ 159.

## Notice



The system may be switched off if it detects lanes which are too narrow, too wide or too curved.

Following preconditions have to be fulfilled:

- vehicle speed must be between 40 mph and 112 mph
- the driver must hold the steering wheel
- the turn lights are not activated
- the electronic stability control is activated and not in operation
- no plug is connected to the power outlet of the trailer hitch
- normal driving behaviour (system detects dynamic driving style, i.e. pressure on the brake or accelerator pedal)
- roads with good lane markings
- no spare wheel is used
- the vehicle is not driven in a tight corner

## Activation





If the system is activated, the LED in the button  is not illuminated. To activate the system when the system is deactivated, press .

## Deactivation

To deactivate the system, press . Deactivation of the system is confirmed by the illuminated LED in the button.

## Fault

In the event of a fault,  and  appear in the instrument panel, accompanied by a display message and a warning chime. Seek the assistance of a workshop.

## System limitations

The system performance may be affected by:

- a dirty or foggy windscreen or if the windscreen is affected by foreign objects, e.g. stickers
- close vehicles ahead
- banked roads
- winding or hilly roads
- road edges
- sudden lighting changes
- adverse environmental conditions, e.g. heavy rain or snow
- vehicle modifications, e.g. tyres

Switch off the system if the system is disturbed by tar marks, shadows, road cracks, temporary or construction lane markings, or other road imperfections.

### Warning

Always keep your attention on the road and maintain proper vehicle position within the lane, otherwise vehicle damage, injury or death could occur.

Lane keep assist does not continuously steer the vehicle.

The system may not keep the vehicle in the lane or give an alert, even if a lane marking is detected.

The steering of the lane keep assist may not be sufficient to avoid a lane departure.

The system may not detect hands-off driving due to external influences like road condition and surface and weather. The driver has full responsibility to control the

vehicle and is always required to keep the hands on the steering wheel while driving.

Using the system while towing a trailer or on slippery roads could cause loss of control of the vehicle and a crash. Switch the system off.

## Advanced lane keep assist

### **⚠ Warning**

The system assists the driver in managing the steering, acceleration and braking within the limits of the laws of physics and the capabilities of the vehicle. Some road infrastructure elements or vehicles present on the road may not be properly seen or may be poorly interpreted by the camera and radar, which may lead to an unexpected change in direction, a lack of steering correction and/or inappropriate management of the acceleration or braking.

Advanced lane keep assist is an enhancement of the lane keep assist system.



The activated system observes the lane markings by using the camera located at the top of the windscreen. It steers the vehicle inside the detected lane. The driver will notice a turning movement of the steering wheel.

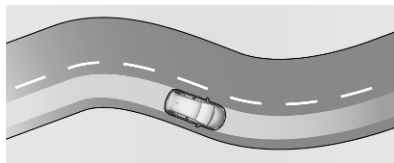

Thus, the current position of the vehicle within the lane is kept. This position is not necessarily the centre of the lane.

In the case that the vehicle is driving at the outer edge of the lane, the system corrects the trajectory smoothly towards the centre of the currently driven lane when a determined speed has been exceeded. Again, the driver will notice a turning movement of the steering wheel.

When the vehicle is steered by the system,  illuminates green in the instrument cluster.

However, the control of the vehicle can be taken over at any time by the driver. Therefore, the driver needs to apply some additional force when turning the steering wheel.

If the system detects that the driver is not holding the wheel firmly enough, it triggers a series of gradual alerts. If the interruption takes too long, the system will be deactivated.  extinguishes in the instrument cluster. The system has to be reactivated again by the driver.

Advanced lane keep assist operates only in combination with adaptive cruise control.



Adaptive cruise control ⇨ 137.

### Required preconditions



- Adaptive cruise control must be activated.
- The driver must hold the steering wheel.
- The turn lights are not activated.
- The Electronic Stability Control is activated and not in operation.
- No plug is connected to the power outlet of the trailer hitch.
- Normal driving behaviour is required (system detects dynamic driving style, i.e. pressure on the brake or accelerator pedal).
- Roads with good lane markings are required.
- No spare wheel is used.
- The vehicle is not driven in a tight corner.

### Activation



Press  to activate the system. The LED in the button is illuminated and  illuminates green in the instrument cluster to confirm the activation of the system.

### Deactivation



To deactivate the system, press . The LED in the button and  in the instrument panel are extinguished to confirm the deactivation of the system.

### Pausing / suspending the system

Advanced lane keep assist may be paused or suspended in the following situations:

- The Electronic Stability Control is in operation or it has been deactivated.
- At least one of the lane markings is not detected by the system for several seconds. The system will be reactivated once the operating conditions are regained.
- The turn lights are activated.
- Driving outside the lane limits.
- The steering wheel is held too tight or moved too dynamically.
- The brake pedal or the accelerator pedal are applied.
- The adaptive cruise control is paused.

### Fault

In the event of a fault,  and  appear in the instrument panel, accompanied by a display message and a warning chime. Seek the assistance of a workshop.

**System limitations**

The system performance may be affected by:

- a dirty or foggy windscreen or if the windscreen is affected by foreign objects, e.g. stickers
- close vehicles ahead
- banked roads
- winding or hilly roads
- road edges
- sudden lighting changes
- adverse environmental conditions, e.g. heavy rain or snow
- vehicle modifications, e.g. tyres

A warning message may appear when the vehicle is travelling in a long straight lane on a smooth road surface even if the driver is holding the steering wheel properly.

Deactivate the system if the system is disturbed by tar marks, shadows, road cracks, temporary or construction lane markings, or other road imperfections.

**⚠ Warning**

Always keep your attention on the road and maintain proper vehicle position within the lane, otherwise vehicle damage, injury or death could occur.

The system may not keep the vehicle in the lane or give an alert, even if a lane marking is detected.

The steering of the advanced lane keep assist may not be sufficient to avoid a lane departure.

The system may not detect hands-off driving due to external influences (road condition and surface, weather etc). The driver has full responsibility to control the vehicle and is always required to keep the hands on the steering wheel while driving.

Using the system while towing a trailer or on slippery roads could cause loss of control of the vehicle and a crash. Switch the system off.

**Driver alert**

The driver alert system monitors the driving time and the vigilance of the driver. Monitoring the vigilance of the driver is based on the trajectory variations of the vehicle compared to the lane markings.

The system cannot replace the need for vigilance on the part of the driver. Taking a break is recommended as soon as feeling tired or at least every 2 hours. Do not drive when feeling tired.

**Activation or Deactivation**

The system can be activated or deactivated in the vehicle personalisation ⇨ 80.

The state of the system stays in memory when the ignition is switched off.

**Driving time alert**

The driver gets notified by a pop-up reminder symbol 🕒 in the Driver Information Centre simultaneously with an acoustic alert if the driver has not taken a break after 2 hours of



driving at a speed above 40 mph. The alert is repeated hourly until the vehicle is stopped, no matter how vehicle speed evolves.

The counting of driving time alert is reset when the ignition has been switched off for a few minutes.

### Driver drowsiness detection

The system monitors the driver's level of vigilance at speeds above 40 mph. A camera at the top of the windscreen detects variations in trajectory compared to the lane markings.

If the trajectory of the vehicle suggests a certain level of drowsiness or inattention by the driver, the system triggers the first level of alert. The driver is notified by a message and an audible signal is given.

After three first level alerts, the system triggers a new alert with a message, accompanied by a more pronounced audible signal.

In certain driving conditions (poor road surface or strong winds), the system may give alerts independent of the driver's level of vigilance.

The driver drowsiness detection is reinitialised when the ignition has been switched off for a few minutes or the speed remains below 40 mph for a few minutes.

### System limitations

In the following situations, the system may not operate properly or even not operate at all:

- poor visibility caused by inadequate lighting of the roadway, falling snow, heavy rain, dense fog etc.
- dazzle caused by headlamps of an oncoming vehicles, low sun, reflections on damp roads, leaving a tunnel, alternating shade and light etc.
- windscreen area in front of the camera covered by dirt, snow, stickers etc.
- no lane markings detected or multiple lane markings due to roadworks
- close vehicles ahead
- winding roads or narrow roads

## Charging

### General information

#### ⚠ Warning

Persons with a pacemaker should consult a doctor for possible precautions.

Charging the vehicle's high voltage battery depends upon several factors:

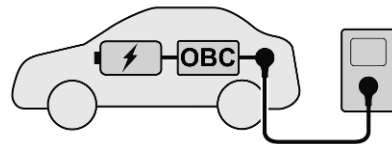

- high voltage battery of the vehicle
- internal onboard charger (OBC)
- external charging device
- charging cable

The charging cable connects the vehicle's high voltage battery with an external charging device providing electric power. This may be a

domestic electrical outlet, a Green'Up socket, a wall box or a public charging station.

The high voltage battery can be charged with direct current (DC) only. When charging from a domestic electrical outlet, a wall box or an alternating current (AC) charging station, AC has to be converted into DC. This is done by the vehicle's onboard charger. The onboard charger is available with 7.4 kW (single-phase) and 11 kW (3-phase).

If the vehicle is charged at a public DC charging station, no DC conversion is required. The high voltage battery can be directly charged with DC provided by the DC charging station.

The speed of charging the vehicle's high voltage battery depends upon the weakest element of the charging chain. To achieve the maximum charging speed, charging cable and charging device have to be attuned to each other.

#### Notice

Make sure that the charging cable used fits to the vehicle's onboard charger.

Charging types ⇨ 172.

Charging cable ⇨ 179.

### Electric power consumption and range

The electric power consumption (combined) is within a range of 17.6 to 15.9 kWh/100 km.

The range is up to 217.5 miles.

For the values specific to your vehicle, refer to the EEC Certificate of Conformity provided with your vehicle or other national registration documents.

The determination of electric power consumption is regulated by directive R (EC) No. 715/2007 and No. 2017/1151 (in the latest applicable version).

### Charging types

There are different types of charging the vehicle's high voltage battery.

### Charging at wallboxes



A wallbox is a charging unit for private households. It provides a charging cable which has to be connected to the vehicle's charging port. Some wallboxes do not provide a charging cable. In this case, a separate charging cable is required which has to be connected to both the wallbox and the charging port of the vehicle.

Charging time may take approx. 5 hours with a charging power of 11 kW or 7.5 hours with a charging power of 7.4 kW.

### Charging at charging stations

Charging stations may provide alternating current (AC) or direct current (DC). Charging time may vary depending on the charging station, DC charging stations provide the fastest charging. To charge the

vehicle's battery, the charging cable of the charging station has to be connected to the charging port of the vehicle.



- AC charging station: Charging time may take approx. 5 hours with a charging power of 11 kW or 7.5 hours with a charging power of 7.4 kW.



- DC charging station: Up to approx. 80% of battery capacity may be charged in approx. 30 minutes at a charging power of 100 kW.

### Charging at domestic electrical outlets



The vehicle's high voltage battery can be charged at a domestic electrical outlet. Connect the charging cable to the vehicle's charging port and to the domestic electrical outlet.

Charging time may take approx. 30 hours with a charging power of 1.8 kW.

### Charging cable

Depending on the charging type, different charging cables are used.

### Warning

Improper use of portable charging cables may cause a fire, electrical shock, or burns, and may result in damage to property, serious injury, or death.

- Do not use extension cables, multi-outlet power strips, splitters, grounding adaptors, surge protectors, or similar devices.
- Do not use an electrical socket that is worn or damaged, or one that will not hold the plug firmly in place.
- Do not immerse the charging cable into any liquid.
- Do not use an electrical socket that is not properly grounded.
- Do not use an electrical socket that is on a circuit with other electrical loads.

**⚠ Warning**

Read all the safety warnings and instructions before using this product. Failure to follow the warnings and the instructions may result in electric shock, fire, and / or serious injury.

Never leave children unattended near the vehicle while the vehicle is charging and never allow children to play with the charging cable.

If the plug provided does not fit the electrical outlet, do not modify the plug. Arrange for a qualified electrician to inspect the electrical outlet.

Do not put fingers into the electric vehicle connector.

**⚠ Danger**

There is a risk of electric shock that may cause personal injury or death.

Do not use the charging cable if any part of the charging cable is damaged.

Do not open or remove the charging cable cover.

Service by qualified personnel only. Connect the charging cable to a properly grounded outlet with cables that are not damaged.

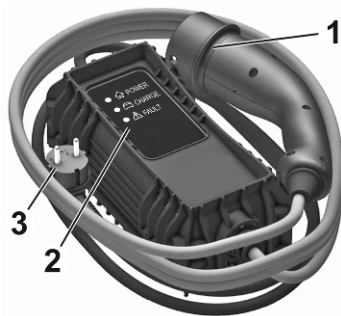
**Basic domestic cable (mode 2) / enhanced domestic cable (mode 2)**

1. Vehicle plug
2. Status indicators
3. Wall plug

Basic domestic cables (mode 2) are used for charging at domestic electrical outlets. A basic domestic cable (mode 2) consists of a vehicle plug, a control box and a plug for the domestic electrical outlet. The control box has an intergrated charge controller and several LEDs indicating the charging status.

Enhanced domestic cables (mode 2) are similar to basic domestic cables (mode 2). However, the charging performance of enhanced domestic cables (mode 2 charging) is better than the charging performance of basic domestic cables (mode 2). Enhanced domestic cables (mode 2) are used at Green'Up sockets which have to be installed by a certified electrician at the customer's site.

**Charging cable status indicators**

After plugging in the charging cable, it will perform a quick self test and all status indicators illuminate for a

moment. For the functions of the status indicators, refer to the manual of the charging cable manufacturer.

### Important information about portable electric vehicle charging

- Charging an electric vehicle can stress a building's electrical system more than a typical household appliance.
- Before you plug in to any electrical outlet, have a qualified electrician inspect and verify the electrical system (electrical outlet, wiring, junctions and protection devices) for heavy-duty service at a 10 A continuous load.
- Electrical outlets may wear out with normal usage or be damaged over time, making them unsuitable for electric vehicle charging.
- Check the electrical outlet / plug while charging and discontinue use if the electrical outlet / plug is hot, then have the electrical outlet serviced by a qualified electrician.

- When outdoors, plug into an electrical outlet that is weather-proof while in use.
- Mount the charging cable to reduce strain on the electrical outlet / plug.

### Mode 3 charging cable



1. Vehicle plug
2. Plug for wall box / AC charging station

Mode 3 charging cables are used for charging at wall boxes and AC charging stations. A mode 3 charging cable provides a vehicle plug and a plug for the wall box / AC charging

station. Wall boxes / AC charging stations may provide an integrated mode 3 charging cable. For more information on the mode 3 charging cable, refer to the manual of the charging cable manufacturer.

### Mode 4 charging cable

#### Notice

Only use DC charging cables shorter than 30 metres.

Mode 4 charging cables are used for DC charging. Since mode 4 charging cables are integrated within DC charging stations, they only provide a vehicle plug.

### Charging

#### **⚠ Warning**

Persons with a pacemaker or similar devices should consult a doctor for possible precautions.

If in doubt, during charging do not remain inside or near the vehicle, near the charging cable or the charging unit.

In order to ensure the compatibility of plug and outlet, different labels are used. The labels are located on the inside of the vehicle's charging port flap. Make sure to connect only a cable of the same type.



Type 2 plug or outlet used for AC charging



FF plug or outlet used for DC charging

**⚠ Warning**

Avoid any entry of fluids into the charging port of the vehicle, the vehicle plug of the charging cable and the domestic electrical outlet.

When charging at a public AC charging station / public DC charging station, follow the instructions for the use of the respective charging station. Public AC charging stations may not provide an integrated charging cable. In this case, a portable mode 3 charging cable is required.

**⚠ Warning**

When charging at a domestic electrical outlet, only use an outlet which is properly grounded and protected by a 30 mA differential switch.

Only use a domestic electrical outlet protected by a circuit breaker adapted to the amperage of the electrical circuit.

Have a qualified electrician check the electrical installation to be used. The installation has to be in compliance with national standards and compatible with the vehicle.

When using a dedicated domestic electrical outlet, have it installed by a qualified electrician.

Make sure that the electrical outlet, the plug and the cable do not support the weight of the control box.

1. Shift into **P** and switch off the vehicle.



2. Push the charging port flap to release it.
3. If necessary, take the charging cable out of the load compartment.
4. If necessary, plug in the plug of the charging cable into the corresponding port of the external power source.

Charging cable ↗ 179.

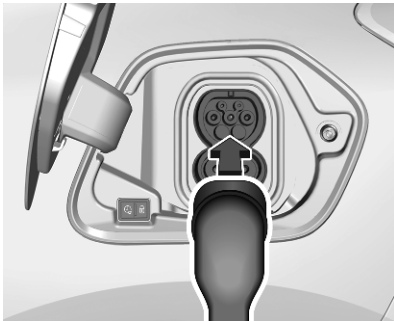

5. Plug in the vehicle plug of the charging cable into the charging port of the vehicle.

Charging status ↗ 179.



The start of charging is indicated by the green flashing of the status indicator at the charging port and at the control box of the charging cable if available.



Once charging, the vehicle plug will be locked to the charging port and cannot be disconnected while charging is active.  indicator illuminates.

Charging types ↗ 172.

### Cancelling the charging process

#### Notice

At public charging stations, the cancelling and subsequent resuming of the charging process may cause additional costs.

Once the charging process has started, only the driver's door can be unlocked without cancelling the charging process. Therefore, activate the driver's door only function in the vehicle personalisation.

Press  on the remote control to cancel the charging process at any time.

Press  twice to cancel the charging process at any time if the function **driver's door only** is activated in the vehicle personalisation.

Central locking system ↗ 10.

Vehicle personalisation ↪ 80.

## Stop charging

The high voltage battery is fully charged if the status indicator on the charging port permanently illuminates green.

1. Unlock the vehicle before removing the vehicle plug from the charging port.

If the vehicle is already unlocked, lock the vehicle and unlock it again.



2. Disconnect the vehicle plug of the charging cable from the charging port within 30 seconds after unlocking.
3. Close the charging port flap by pressing firmly in the centre to latch properly.
4. Disconnect the charging cable from the external power source.
5. If necessary, store the charging cable in the load compartment.

While the charging cable is plugged into the vehicle, the vehicle cannot be driven.

## Programmable charging

By default, charging starts as soon as the charging cable is connected to the charging port of the vehicle.

Programmable charging is only possible when charging at a domestic electrical outlet / Green'Up socket or a wall box.

Programmable charging is also available via the MyVauxhall App.

## Notice

On vehicles without integrated navigation system, programmable charging can only be used via the MyVauxhall App.





1. Press .
2. Select **Charge**.



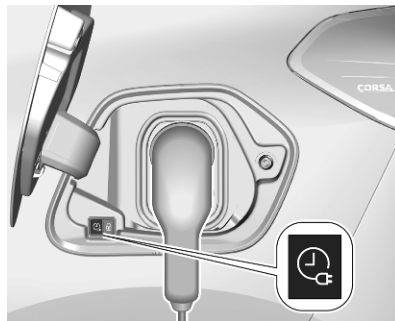

3. Press .
4. Define the number of hours and minutes after which the loading process starts.
5. Press **OK**.
6. Plug in the vehicle.



7. Within 1 minute, press  to activate programmable charging.
8. Depending on version, lock the vehicle.

The status indicator illuminates blue indicating that programmable charging is active.

Charging  175.

Charging status  179.

## Charging status



If the vehicle is plugged in and switched off, the charging status indicator indicates the following:

- Illuminates white: welcome lighting when charging port flap is opened
- Illuminates green: charging complete
- Flashes green: charging in process
- Illuminates red: charging fault
- Illuminates blue: programmable charging active

A charging fault has occurred if the vehicle is plugged in and the charging status indicator is off.

Further charging status indicators are located on the control box of the basic domestic cable (mode 2) / enhanced domestic cable (mode 2).

Charging cable ⇨ 173.

Programmable charging ⇨ 178.

## Fuel

### Fuel for petrol engines

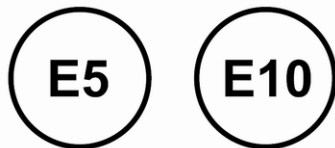

Only use unleaded fuel that complies with European standard EN 228 or E DIN 51626-1 or equivalent.

The engine is capable of running with fuel that contains up to 10% ethanol (e.g. named E10).

Use fuel with the recommended octane rating. A lower octane rating can reduce engine power and torque and slightly increases fuel consumption.

### Caution

Do not use fuel or fuel additives that contain metallic compounds such as manganese-based additives. This may cause engine damage.

### Caution

Use of fuel with a lower octane rating than the lowest possible rating could lead to uncontrolled combustion and engine damage.

The engine specific requirements regarding octane rating are given in the engine data overview ⇨ 236. A country-specific label at the fuel filler flap can supersede the requirement. In certain countries, the use of a particular fuel, e.g. a specific octane rating, may be required to ensure proper engine operation.

## Fuel for diesel engines

The Diesel engines are compatible with bio-fuels that conform to current and future European standards and can be obtained from filling stations:



Diesel fuel that meets standard EN590 mixed with a biofuel that meets standard EN14214 (possibly containing up to 7% Fatty Acid Methyl Ester).



Diesel fuel that meets standard EN16734 mixed with a biofuel that meets standard EN14214 (possibly containing up to 10% Fatty Acid Methyl Ester).



Paraffinic Diesel fuel that meets standard EN15940 mixed with a biofuel that meets standard EN14214 (possibly containing up to 7% Fatty Acid Methyl Ester).

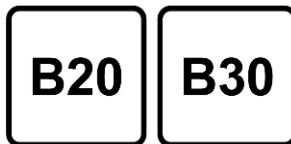

The use of B20 or B30 fuel meeting standard EN16709 is possible in your Diesel engines. However, this use, even occasional, requires strict

application of the special servicing conditions referred to as "Arduous conditions".

For more information, contact a dealer or a qualified workshop.

### Caution

The use of any other type of (bio) fuel (vegetable or animal oils, pure or diluted, domestic fuel etc.) is strictly prohibited (risk of damage to the engine and fuel system).

### Notice

The only Diesel additives authorised for use are those that meet the B715000 standard.

### Low temperature operation

At temperatures below 0 °C, some diesel products with biodiesel blends may clog, freeze or gel, which may affect the fuel supply system. Starting and engine operation may not work properly. Make sure to fill winter grade diesel fuel at ambient temperatures below 0 °C.

Arctic grade diesel fuel can be used at extremely low temperatures below -20 °C. Using this fuel grade in warm or hot climates is not recommended and may cause engine stalling, poor starting or damage on the fuel injection system.

## Refuelling

### **⚠ Danger**

Before refuelling, switch off ignition and any external heaters with combustion chambers.

Follow the operating and safety instructions of the filling station when refuelling.

### **⚠ Danger**

Fuel is flammable and explosive. No smoking. No naked flames or sparks.

If you can smell fuel in your vehicle, have the cause of this remedied immediately by a workshop.

A label with symbols at the fuel filler flap is indicating the allowed fuel types. In Europe the pump nozzles of the filling stations are marked with these symbols. Refuel only the allowed fuel type.

### **Caution**

In case of misfuelling, do not switch on ignition.

Fuel filler flap is located at left rear side of vehicle.



The fuel filler flap can only be opened if the vehicle is unlocked. Release the fuel filler flap by pushing the flap.

## Petrol and diesel refuelling

To open, turn the cap slowly anticlockwise.

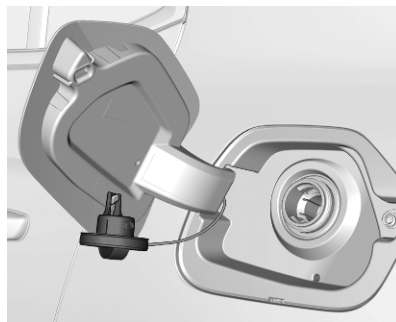

The fuel filler cap can be attached to the hook on the fuel filler flap.

Place the nozzle in straight position to the filler neck and press with slight force to insert.

To refuel, switch on pump nozzle.

After the automatic cut-off, the tank can be topped up by operating the pump nozzle a maximum of two more times.

|                                            |
|--------------------------------------------|
| <b>Caution</b>                             |
| Wipe off any overflowing fuel immediately. |

To close, turn the fuel filler cap clockwise until it clicks.

Close the flap and allow it to engage.

### Fuel filler cap

Only use genuine fuel filler caps.

Diesel-engined vehicles have special fuel filler caps.

### Fuel consumption - CO<sub>2</sub>-Emissions

The fuel consumption (combined) is within a range of 44 to 74 mpg.

The CO<sub>2</sub> emission is within a range of 144 to 101 g/km.

### General information

For the values specific to your vehicle, refer to the EEC Certificate of Conformity provided with your vehicle or other national registration documents.

The determination of fuel consumption is regulated by directive R (EC) No. 715/2007 and No. 2017/1151 (in the latest applicable version).

The specification of CO<sub>2</sub> emission is also a constituent of the directive.

The figures given must not be taken as a guarantee for the actual fuel consumption of a particular vehicle. Furthermore, fuel consumption is dependent on personal driving style as well as road and traffic conditions.

All values are based on the EU base model with standard equipment.

The calculation of fuel consumption takes into account the vehicle's kerb weight, ascertained in accordance with the regulations. Optional equipment may result in slightly

higher fuel consumption and CO<sub>2</sub> emission levels and a lower maximum speed.

## Trailer hitch

### General information

|                                                |
|------------------------------------------------|
| <b>Caution</b>                                 |
| When not in use, remove the coupling ball bar. |

Only use towing equipment that has been approved for your vehicle.

Entrust retrofitting of towing equipment to a workshop. It may be necessary to make changes that affect the cooling system, heat shields or other equipment.

The bulb outage detection function for trailer brake light cannot detect a partial bulb outage. E.g. in case of four bulbs with a power of 5 W each, the function only detects lamp outage when only a single 5 W lamp remains or none remain.

Trailers equipped with LED lights are not suitable for the wiring harness of this trailer hitch.

Fitting of towing equipment could cover the opening of the towing eye. If this is the case, use the coupling ball bar for towing. Always keep the coupling ball bar in the vehicle to have it on hand if needed.

### Driving characteristics and towing tips

Before attaching a trailer, lubricate the coupling ball. However, do not do so if a stabiliser, which acts on the coupling ball, is being used to reduce snaking movements.

During trailer towing do not exceed a speed of 50 mph. A maximum speed of 60 mph is only appropriate if an oscillation damper is used and the permissible gross trailer weight does not exceed the vehicle's curb weight.

For trailers with low driving stability and caravan trailers, the use of an oscillation damper is strongly recommended.

If the trailer starts snaking, drive more slowly, do not attempt to correct the steering and brake sharply if necessary.

When driving downhill, drive in the same gear as if driving uphill and drive at a similar speed.

Adjust tyre pressure to the value specified for full load ⇨ 239.

## Trailer towing

### Trailer loads

The permissible trailer loads are vehicle and engine-dependent maximum values which must not be exceeded. The actual trailer load is the difference between the actual gross weight of the trailer and the actual coupling socket load with the trailer coupled.

The permissible trailer loads are specified in the vehicle documents. In general, they are valid for gradients up to 12%.

The permissible trailer load applies up to the specified incline and at sea level. Since engine power decreases as altitude increases due to the air becoming thinner, therefore reducing climbing ability, the permissible gross train weight also decreases by 10%

for every 1000 m of altitude. The gross train weight does not have to be reduced when driving on roads with slight inclines (less than 8%, e.g. motorways).

The permissible gross train weight must not be exceeded. This weight is specified on the identification plate  
⇨ 233.

### **Vertical coupling load**

The vertical coupling load is the load exerted by the trailer on the coupling ball. It can be varied by changing the weight distribution when loading the trailer.

The maximum permissible vertical coupling load (55 kg) is specified on the towing equipment identification plate and in the vehicle documents.

Always aim for the maximum vertical coupling load, especially in the case of heavy trailers. The vertical coupling load should never fall below 25 kg.

### **Rear axle load**

When the trailer is coupled and the towing vehicle fully loaded, the permissible rear axle load (see identification plate or vehicle documents) may be exceeded by 60 kg, the gross vehicle weight rating must not be exceeded. If the permissible rear axle load is exceeded, a maximum speed of 60 mph applies.

## Vehicle care

|                                             |            |
|---------------------------------------------|------------|
| <b>General Information</b> .....            | <b>186</b> |
| Accessories and vehicle modifications ..... | 186        |
| Vehicle storage .....                       | 188        |
| End-of-life vehicle recovery .....          | 189        |
| <b>Vehicle checks</b> .....                 | <b>190</b> |
| Performing work .....                       | 190        |
| Bonnet .....                                | 191        |
| Engine oil .....                            | 191        |
| Engine coolant .....                        | 193        |
| Washer fluid .....                          | 193        |
| Brakes .....                                | 194        |
| Brake fluid .....                           | 194        |
| Vehicle battery .....                       | 194        |
| High voltage battery .....                  | 196        |
| Diesel fuel system bleeding .....           | 197        |
| Wiper blade replacement .....               | 197        |
| <b>Bulb replacement</b> .....               | <b>198</b> |
| Halogen headlights .....                    | 198        |
| LED headlights .....                        | 199        |
| Front fog lights .....                      | 200        |
| Front turn lights .....                     | 200        |
| Tail lights .....                           | 200        |
| Number plate light .....                    | 202        |
| Interior lights .....                       | 202        |

|                                       |            |
|---------------------------------------|------------|
| <b>Electrical system</b> .....        | <b>203</b> |
| Fuses .....                           | 203        |
| Engine compartment fuse box .....     | 203        |
| Instrument panel fuse box .....       | 205        |
| <b>Vehicle tools</b> .....            | <b>208</b> |
| Tools .....                           | 208        |
| <b>Wheels and tyres</b> .....         | <b>208</b> |
| Winter tyres .....                    | 208        |
| Tyre designations .....               | 209        |
| Tyre pressure .....                   | 209        |
| Tyre deflation detection system ..... | 210        |
| Tread depth .....                     | 211        |
| Changing tyre and wheel size .....    | 211        |
| Wheel covers .....                    | 212        |
| Tyre chains .....                     | 212        |
| Tyre repair kit .....                 | 212        |
| Wheel changing .....                  | 216        |
| Spare wheel .....                     | 217        |
| <b>Jump starting</b> .....            | <b>221</b> |
| <b>Towing</b> .....                   | <b>222</b> |
| Towing the vehicle .....              | 222        |
| Towing another vehicle .....          | 224        |
| <b>Appearance care</b> .....          | <b>224</b> |
| Exterior care .....                   | 224        |
| Interior care .....                   | 226        |
| Floor mats .....                      | 226        |

## General Information

### Accessories and vehicle modifications

We recommend the use of genuine parts and accessories and factory approved parts specific for your vehicle type. We cannot assess or guarantee reliability of other products - even if they have a regulatory or otherwise granted approval.

Any modification, conversion or other changes made to standard vehicle specifications (including, without limitation, software modifications, modifications of the electronic control units) may invalidate the warranty offered by Vauxhall. Furthermore, such changes may affect driver assistance systems, may impact fuel or electric power consumption, CO<sub>2</sub> emissions and other emissions of the vehicle and cause the vehicle to no longer conform to the operating permit, impacting the validity of your vehicle registration.



**Caution**

Access to the diagnostic socket associated with the on-board electronics is reserved for qualified technicians and approved tools.

**Caution**

When transporting the vehicle on a train or on a recovery vehicle, the mud flaps might be damaged.

**Mobile phones and CB radio equipment**

The vehicle specific installation instructions and the operating guidelines of the mobile phone and hands-free manufacturer must be observed when installing and operating a mobile telephone. Failure to do so could invalidate the vehicle type approval (EU directive 95/54/EC).

Recommendations for fault-free operation:

- Professionally installed exterior antenna to obtain the maximum range possible.
- Maximum transmission power 10 W.
- Installation of the phone in a suitable spot, consider the area in which the airbag inflates ⇨ 37.

Seek advice on predetermined installation points for the external antenna or equipment holder and ways of using devices with a transmission power exceeding 10 W.

Use of a hands-free attachment without external antenna with mobile telephone standards GSM 900/1800/1900 and UMTS is only permitted if the maximum transmission power of the mobile telephone is 2 W for GSM 900 or 1 W for the other types.

For reasons of safety, do not use the phone while driving. Even use of a hands-free set can be a distraction while driving.

**⚠ Warning**

Operation of radio equipment and mobile telephones which fail to meet above mentioned mobile telephone standards is only permitted using an antenna located outside of the vehicle.

**Caution**

Mobile telephones and radio equipment may lead to malfunctions in the vehicle electronics when operated inside the vehicle with no exterior antenna, unless the above mentioned regulations are observed.

## Vehicle storage

### Storage for a long period of time

If the vehicle is to be stored for several months:

- Wash the vehicle.
- Have the wax in the engine compartment and underbody checked.
- Clean and preserve the rubber seals.
- Fill up fuel tank completely.
- Change the engine oil.
- Drain the washer fluid reservoir.
- Check the coolant antifreeze and corrosion protection.
- Adjust tyre pressure to the value specified for full load.
- Park the vehicle in a dry, well ventilated place. Engage first or reverse gear or set selector to **P**. Prevent the vehicle from rolling.
- Do not apply the parking brake.

- Open the bonnet, close all doors and lock the vehicle.
- Disconnect the clamp from the negative terminal of the vehicle battery. Note that all systems are not functional, e.g. central locking system.

Anti-theft alarm system ⇨ 18.

### Storage for a long period of time (electric vehicle)

If the vehicle is to be stored for several months:

- Wash and wax the vehicle.
- Have the wax in the engine compartment and underbody checked.
- Clean and preserve the rubber seals.
- Drain the washer fluid reservoir.
- Check the coolant antifreeze and corrosion protection.
- Adjust tyre pressure to the value specified for full load.

- Park the vehicle in a dry, well ventilated place. Engage first or reverse gear or set selector lever to **P**. Prevent the vehicle from rolling.
- Do not apply the parking brake.
- Open the bonnet, close all doors and lock the vehicle.

### Up to four weeks

Plug in the charging cable.

### Four weeks to twelve months

- Discharge the high voltage battery until 30 percent remain on the battery range indicator (battery symbol) on the instrument cluster.
- Do not plug in the charging cable.
- Always store the vehicle in a place with temperatures between  $-10\text{ }^{\circ}\text{C}$  and  $30\text{ }^{\circ}\text{C}$ .
- Vehicle storage at extreme temperatures may cause damage to the high voltage battery.
- Remove the black negative (-) cable from the 12 V vehicle battery and attach a trickle

charger to the vehicle battery terminals or keep the 12 V vehicle battery cables connected and trickle charge from the positive (+) and negative (-) terminals in the engine compartment.

- Every three months, check the battery's state of charge. If the state of charge is below 30 percent, recharge the battery to 30 percent.

### Putting back into operation

When the vehicle is to be put back into operation:

- Connect the clamp to the negative terminal of the vehicle battery. Initialise the power windows ⇨ 23.
- Check tyre pressure.
- Fill up the washer fluid reservoir.
- Check the engine oil level.
- Check the coolant level.
- Fit the number plate if necessary.

### Putting back into operation (electric vehicle)

When the vehicle is to be put back into operation:

- Connect the clamp to the negative terminal of the vehicle battery. Initialise the power windows ⇨ 23.
- Check tyre pressure.
- Fill up the washer fluid reservoir.
- Check the coolant level.
- Fit the number plate if necessary.

### End-of-life vehicle recovery

Information on end-of-life vehicle recovery centres and the recycling of end-of-life vehicles is available on our website, where legally required. Only entrust this work to an authorised recycling centre.

### High voltage battery

The high voltage battery is designed for the life of the vehicle if the recommendations are followed. If it becomes necessary to replace the high voltage battery, contact a

workshop for instructions on its disposal. Improper disposal carries the risk of severe burns, electric shock, and damage to the environment.

Recommendations ⇨ 196.

## Vehicle checks

### Performing work

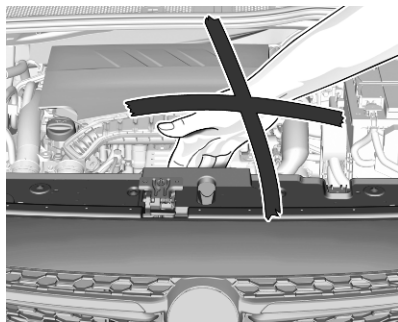

#### **⚠ Warning**

Only perform engine compartment checks when the ignition is off.  
The cooling fan may start operating even if the ignition is off.

#### **⚠ Danger**

The ignition system uses extremely high voltage. Do not touch.



#### **⚠ Danger**

Electric version:  
Never try to perform maintenance work on high voltage components yourself. You may be injured and the vehicle may be damaged. Service and repair of these high voltage components should only be performed by a trained service technician with proper knowledge and tools. Exposure to high voltage may cause shock, burns, and even death. The high voltage

components in the vehicle can only be serviced by technicians with special training.

High voltage components are identified by labels. Do not remove, open, take apart, or modify these components. High voltage cable or wiring has orange covering. Do not probe, tamper with, cut, or modify high voltage cable or wiring.

#### **⚠ Warning**

Electric version:  
Only perform engine compartment checks when the vehicle is off.  
The cooling fan may start operating even if the vehicle is off.

#### **Caution**

Electric version:  
Even small amounts of contamination to the liquids can cause damage to vehicle systems.

Do not allow contaminants to contact the fluids, reservoir caps, or dipsticks.

## Bonnet

### Opening

Open the front left door.



Pull the release lever and return it to its original position.

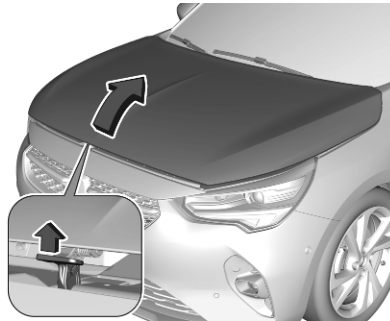

Push the safety catch upwards and open the bonnet.

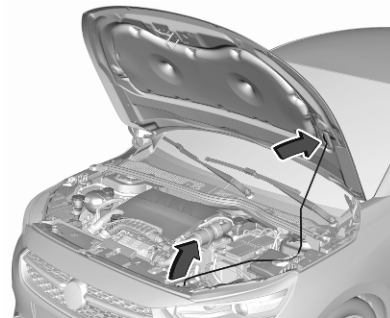

Secure the bonnet support.

### Closing

Before closing the bonnet, press the support into the holder.

Lower the bonnet and let it fall into the latch from a low height (20-25 cm). Check that the bonnet is engaged.

### Caution

Do not press the bonnet into the latch to avoid dents.

### Engine oil

Check the engine oil level manually on a regular basis to prevent damage to the engine. Ensure that the correct specification of engine oil is used.

Recommended fluids and lubricants  
 ⇨ 231.

The maximum engine oil consumption is 0.6 l per 600 miles.

Check with the vehicle on a level surface. The engine must be at operating temperature and switched off for at least 5 min.

**Caution**

It is the owner's responsibility to maintain the proper level of an appropriate quality oil in the engine.

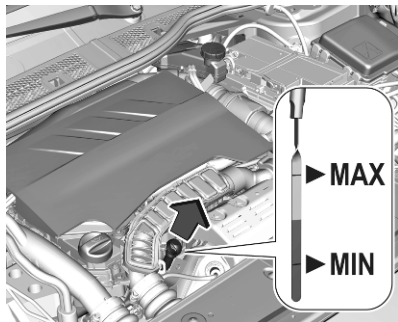

Different dipsticks are used depending on engine variant.

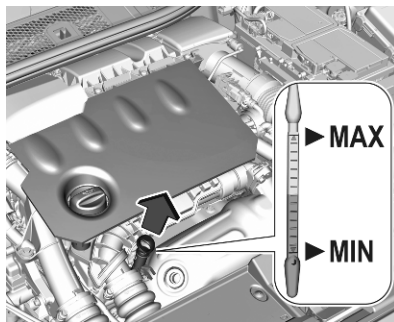

Pull out the dipstick, wipe it clean, reinsert it fully, pull out and read the engine oil level.

When the engine oil level has dropped to the **MIN** mark, top up the engine oil.

We recommend the use of the same grade of engine oil that was used at last change.

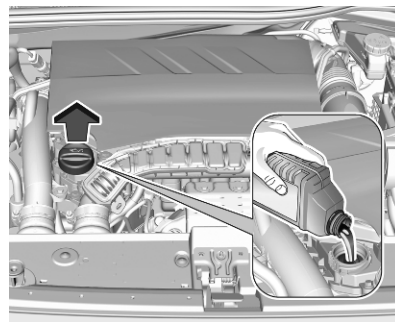

The engine oil level must not exceed the **MAX** mark on the dipstick.

**Caution**

Overfilled engine oil must be drained or suctioned out. If the oil exceeds the maximum level, do not start the vehicle and contact a workshop.

Capacities ⇨ 237.

Fit the cap on straight and tighten it.

## Engine coolant

The factory filled coolant provides freeze protection down to approx. -37 °C.

### Caution

Only use approved antifreeze.

Coolant and antifreeze ⇨ 231.

## Coolant level

### Caution

Too low a coolant level can cause engine damage.

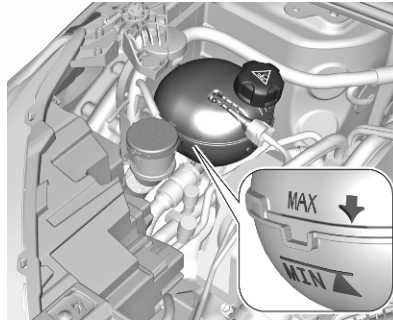

If the cooling system is cold, the coolant level should be above the **MIN** mark. Top up if the level is low.

### ⚠ Warning

Allow the engine to cool before opening the cap. Carefully open the cap, relieving the pressure slowly.

To top up, use a 1:1 mixture of released coolant concentrate mixed with clean tap water. If no coolant concentrate is available, use clean tap water. Install the cap tightly. Have

the coolant concentration checked and have the cause of the coolant loss remedied by a workshop.

## Washer fluid

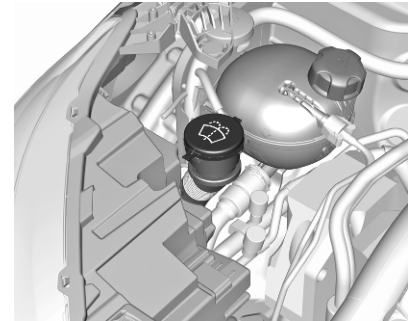

Fill with clean water mixed with a suitable quantity of approved windscreen washer fluid which contains antifreeze.

**Caution**

Only washer fluid with a sufficient antifreeze concentration provides protection at low temperatures or a sudden drop in temperature.

Washer fluid ⇨ 231.

**Brakes**

Depending on the driving style, the brake wear may vary significantly. The brake wear may increase when the vehicle is driven over short distances, e.g. in the city.

It may be necessary to have the condition of the brakes checked, even between vehicle services.

Unless there is a leak in the circuit, a drop in the brake fluid level indicates that the brake pads are worn.

Once new brake linings are installed, do not brake unnecessarily hard for the first few journeys.

**Brake fluid****⚠ Warning**

Brake fluid is poisonous and corrosive. Avoid contact with eyes, skin, fabrics and painted surfaces.

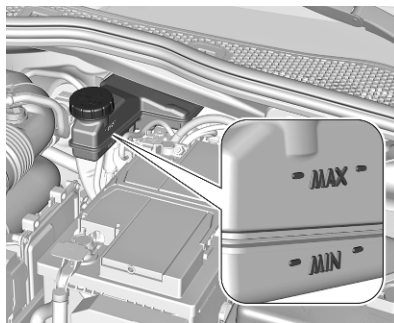

The brake fluid level must be between the **MIN** and **MAX** marks.

If fluid level is below **MIN** seek the assistance of a workshop.

Brake and clutch fluid ⇨ 231.

**Vehicle battery**

The vehicle battery is maintenance-free provided that the driving profile allows sufficient charging of the battery. Short-distance-driving and frequent engine starts can discharge the battery. Avoid the use of unnecessary electrical consumers.



Batteries do not belong in household waste. They must be disposed of at an appropriate recycling collection point.

Laying up the vehicle for more than four weeks can lead to battery discharge. Disconnect the clamp from the negative terminal of the vehicle battery.

Ensure the ignition is switched off before connecting or disconnecting the vehicle battery.

Battery discharge protection ⇨ 91.



## Replacing the vehicle battery

### Notice

Any deviation from the instructions given in this section may lead to temporary deactivation or disturbance of the stop-start system.

When the vehicle battery is being replaced, please ensure that there are no open ventilation holes in the vicinity of the positive terminal. If a ventilation hole is open in this area, it must be closed off with a dummy cap, and the ventilation in the vicinity of the negative terminal must be opened.

Ensure that the battery is always replaced by the same type of battery.

The vehicle battery has to be replaced by a workshop.

Stop-start system ⇨ 107.

## Charging the vehicle battery

### Warning

On vehicles with stop-start system, ensure that the charging potential does not exceed 14.6 V

when using a battery charger. Otherwise the vehicle battery may be damaged.

Jump starting ⇨ 221.

## Discharge protection

### Battery voltage

When the vehicle battery voltage is running low, a warning message will appear in the Driver Information Centre.

When the vehicle is being driven, the load reduction function temporarily deactivates certain functions, such as the air conditioning, the heated rear window, heated steering wheel, etc.

The deactivated functions are reactivated automatically as soon as conditions permit.

### Idle boost

If charging of the vehicle battery is required due to battery condition, the power output of the generator must be increased. This will be achieved by an idle boost which may be audible.

A message appears in the Driver Information Centre.

### Power outlet

The power outlets are deactivated in the event of low vehicle battery voltage.

## Warning label



Meaning of symbols:

- No sparks, naked flames or smoking.
- Always shield eyes. Explosive gases can cause blindness or injury.

- The vehicle battery contains sulphuric acid which could cause blindness or serious burn injuries.
- Keep the vehicle battery out of reach of children.
- See the Owner's Manual for further information.
- Explosive gas may be present in the vicinity of the vehicle battery.

### Power saving mode

This mode deactivates electrical consumers to avoid excessive discharging of the vehicle battery. These consumers, such as the Infotainment system, windscreen wipers, low beam headlights, courtesy light, etc. can be used for a total maximum time of about 40 minutes after ignition is switched off.

### Changing into power saving mode

When power saving mode is activated, a message appears in the Driver Information Centre.

An active telephone call using the hands-free option will be maintained for around 10 minutes longer.

### Deactivating power saving mode

Power saving mode is deactivated automatically when the engine is restarted. Run the engine for a sufficient charge:

- for less than 10 minutes to use the consumers for approx. 5 minutes
- for more than 10 minutes to use the consumers for up to approx. 30 minutes

### Heating functionalities

#### Notice

Individual heating functionalities, such as heated seats or heated steering wheel, may be temporarily unavailable in the event of electrical loading constraints. Functions will be resumed after some minutes.

### High voltage battery

To preserve the range and the durability of the high voltage battery, the following is recommended:

- Whenever possible do not charge the high voltage battery more than 80%.
- Do not completely discharge the high voltage battery.
- Do not store the vehicle for a long period of non-use (more than 12 hours) when the high voltage battery has a low or high charge level. Prefer a charge level between 20 and 40%.
- Limit the use of fast charging.
- Do not expose the vehicle to temperatures below -30 °C and above 60 °C for more than 24 hours.
- Avoid charging the vehicle at low temperatures (except if the vehicle ran more than 20 minutes) or above 30 °C.

- Do not use the high voltage battery as a generator of energy.
- Do not use a generator to recharge the high voltage battery.

Vehicle storage ⇨ 188.

### Leakage

Damage to the high voltage battery could result in the leakage of toxic gases or fluids either immediately or later. The following is recommended:

- Always inform the fire and emergency services in the event of an incident, that the vehicle is equipped with a high voltage battery.
- Never touch the liquids leaking from the high voltage battery.
- Do not inhale the gases emitted by the high voltage battery which are toxic.

- Move away from the vehicle in the event of incident or accident, the gases emitted being flammable and could cause a fire.
- Too low a coolant level must be topped up and the cause of the coolant loss remedied by a workshop.

### Diesel fuel system bleeding

If the tank has been run dry, the diesel fuel system must be bled. Refuel at least five litres diesel. Switch on the ignition for about 60 seconds and switch off again. Then crank the engine. If the engine does not start directly, repeat this process a few times. If the engine then fails to start, seek the assistance of a workshop.

### Wiper blade replacement

#### Windscreen

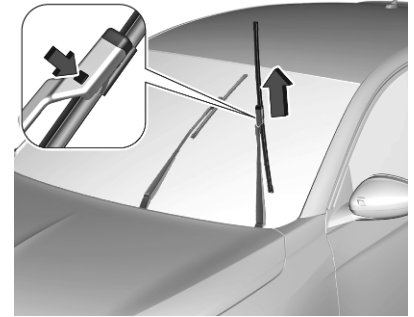

Switch off ignition.

Within one minute after switching off ignition, operate the wiper lever to position the wiper blades vertically on the windscreen.

Lift the wiper arm until it stays in the raised position, press button to disengage the wiper blade and remove.

Attach the new wiper blade to the wiper arm and push until it engages. Lower wiper arm carefully.

To return the wiper arms to their original position, switch on the ignition and operate the wiper lever.

### Rear window

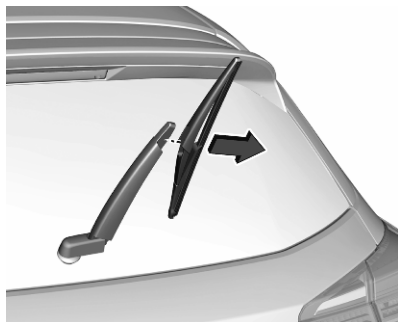

Lift wiper arm. Disengage wiper blade as shown in illustration and remove.

Attach the wiper blade slightly angled to the wiper arm and push until it engages.

Lower wiper arm carefully.

## Bulb replacement

Before replacing a bulb, ensure that all exterior and interior lights and the ignition are switched off.

Only hold a new bulb at the base. Do not touch the bulb glass with bare hands.

Use only the same bulb type for replacement.

Replace headlight bulbs from within the engine compartment.

### Bulb check

After a bulb replacement switch on the ignition, operate and check the lights.

## Halogen headlights

Halogen headlights with separate bulbs for low beam and high beam / daytime running light.

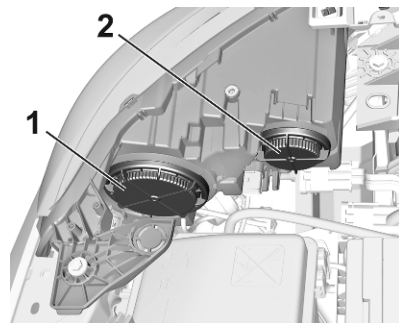

Low beam (1) outer bulb.

High beam / daytime running light (2) inner bulb.

### Low beam (1)

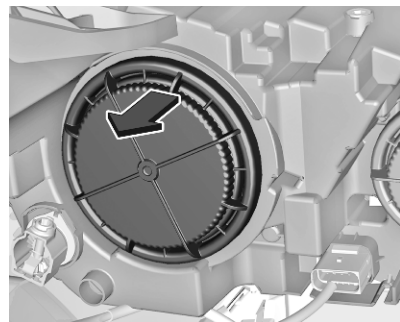

1. Remove the protective cover by pulling.

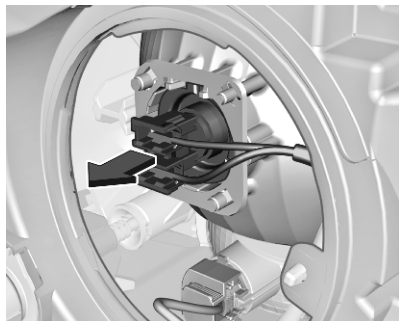

2. Withdraw the bulb socket from the reflector housing.

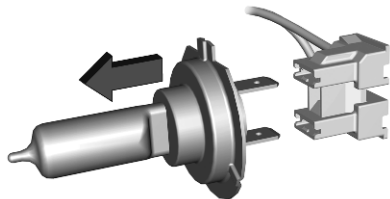

3. Detach the bulb from the bulb socket and replace the bulb.
4. Insert the bulb socket into the reflector housing.
5. Fit the protective cover on.

### High beam / daytime running light (2)

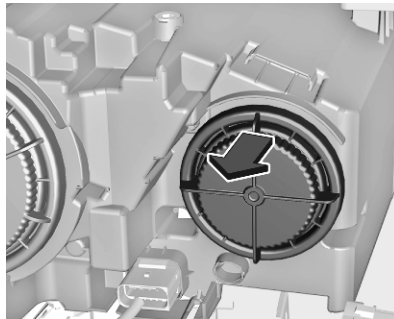

1. Remove the protective cover by pulling.

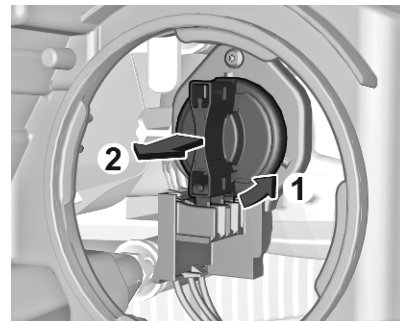

2. Rotate the bulb socket anticlockwise to disengage and withdraw from the reflector.
3. Insert the new bulb socket into the reflector housing.
4. Fit the protective cover on.

### LED headlights

Headlights for low and high beam, daytime running lights and turn lights are designed as LEDs and cannot be changed.

Have lights repaired by a workshop in case of failure.

## Front fog lights

Have lights repaired by a workshop in case of failure.

## Front turn lights

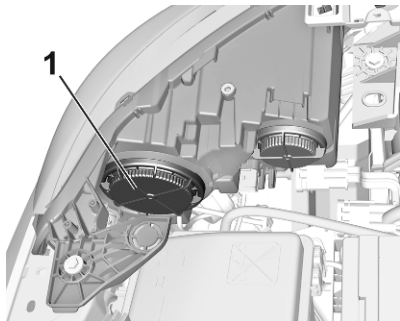

Turn light (1) outer bulb.

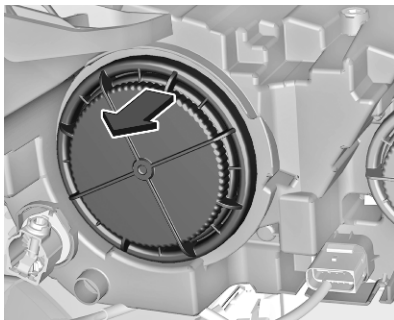

1. Remove the protective cover by pulling.



2. Withdraw the bulb socket from the reflector housing.

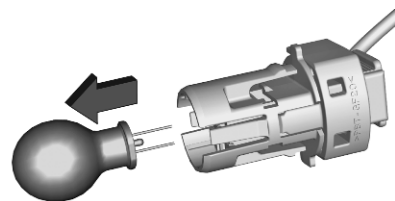

3. Detach the bulb from the bulb socket and replace the bulb.
4. Insert the bulb socket into the reflector housing.
5. Fit the protective cover on.

## Tail lights

### LED tail lights

Have lights repaired by a workshop in case of failure.

## Light assembly in the body



1. Open the tailgate then remove the access cover on the relevant side.

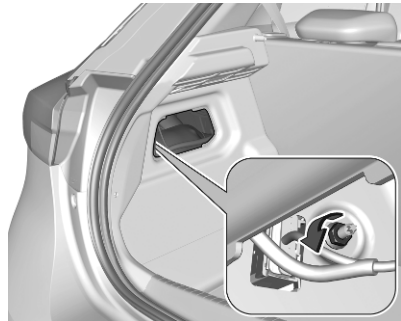

2. Slacken the lamp fixing nut using a box spanner or socket.

To avoid losing the nut if it drops into the wing trim, first place a cloth below it.

3. Manually unscrew and remove the lamp fixing nut.

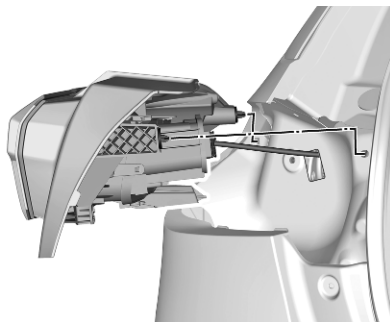

4. Carefully withdraw tail light assembly from the recess and remove.
5. Detach the cable from the retainer.

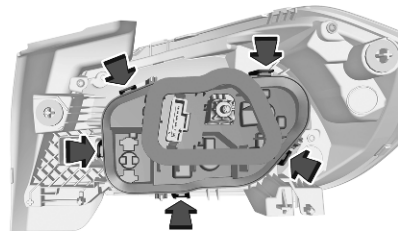

6. Press the five retaining lugs and remove the bulb carrier from the light assembly.

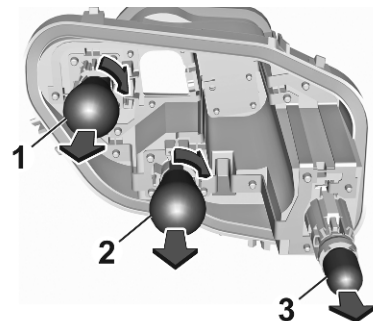

7. Remove and replace the bulbs:

Tail light / brake light (1)

Turn light (2)

Reverse light (3)

8. Insert the bulb carrier into the light assembly. Attach plug to the light assembly. Fit the light assembly in the recess and tighten the lamp fixing nut from the inside. Attach the cover.

### Rear fog light

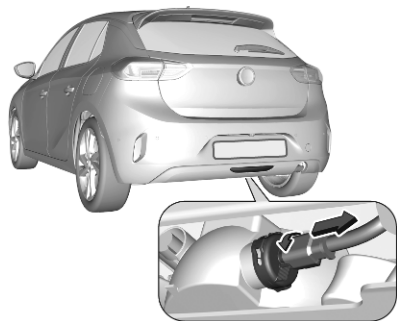

1. Turn the bulb holder anticlockwise and remove it from the reflector housing.

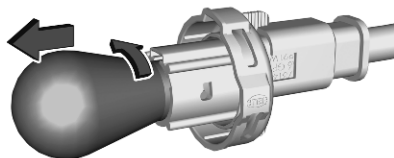

2. Slightly press down the bulb, turn it anticlockwise and remove it from the socket.

3. Replace and insert the new bulb into socket by turning clockwise.

4. Insert the bulb socket into the reflector and turn clockwise.

### Centre high-mounted brake light

Have lights repaired by a workshop in case of failure.

### Number plate light

Have lights repaired by a workshop in case of failure.

### Interior lights

Have the following bulbs replaced by a workshop:

- courtesy light, reading lights
- load compartment light
- instrument panel illumination



## Electrical system

### Fuses

Data on the replacement fuse must match the data on the defective fuse.

The three fuse boxes are located in:

- engine compartment
- instrument panel

Before replacing a fuse, turn off the respective switch and the ignition.

A blown fuse can be recognised by its melted wire.

#### Caution

Do not replace the fuse until the cause of the fault has been remedied.

Some functions are protected by several fuses.

Fuses may also be inserted without existence of a function.

### Fuse extractor

A fuse extractor may be located in the cover of the left side of the instrument panel. The extractor has two sides, each side is designed for a different type of fuses.

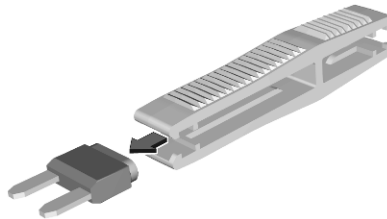

Grab the fuse with the fuse extractor and withdraw the fuse.

### Engine compartment fuse box

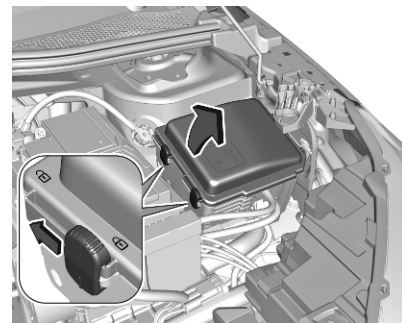

Disengage the cover and remove it.

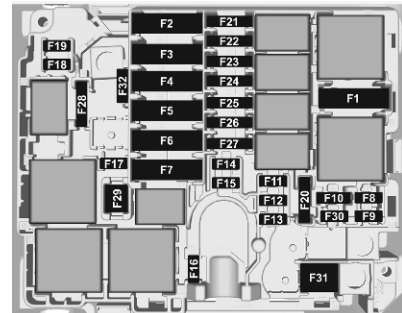

After having changed defective fuses, close the fuse box cover and lock it.

If the fuse box cover is not closed correctly, malfunction may occur.

### **Non-electric vehicle**

#### **No. Circuit**

---

- 1 Climate control system
- 2 Brake system
- 3 Fuse box (right side of the instrument panel)
- 4 Brake system
- 5 Body control module
- 6 Cooling fan
- 7 Body control module
- 8 Engine control module / Fuel pump
- 9 NOX sensor / Diesel water sensor
- 10 Engine control module
- 11 Engine control module

#### **No. Circuit**

---

- 12 Diagnostic link connector
- 13 Body control module
- 14 Battery sensor
- 15 Trailer control module
- 16 Right headlight
- 17 Engine control module / NOX sensor
- 18 Right high beam
- 19 Left high beam
- 20 Engine control module / Fuel pump / Diesel heater
- 21 Starter
- 22 Automatic transmission
- 25 Fuse box (trailer)
- 27 Body control module
- 28 Selective catalytic reduction system
- 29 Windscreen wiper

#### **No. Circuit**

---

- 31 Climate control system
- 32 Steering wheel

### **Electric vehicle**

#### **No. Circuit**

---

- 1 Climate control system
- 2 Brake system
- 3 Fuse box (right side of the instrument panel)
- 4 Brake system
- 6 Cooling fan
- 7 Body control module
- 8 Valve climate control
- 9 Electric vehicle control unit
- 10 Electric vehicle control unit (climate compressor)
- 11 Electric vehicle control unit
- 12 Diagnostic link connector

**No. Circuit**

---

- 13 Body control module / Climate control system
- 15 E-service plug
- 16 Right headlight
- 18 Right high beam
- 19 Left high beam
- 20 Electric vehicle control unit
- 22 Engine compartment relay
- 23 AC/DC converter / DC/DC converter
- 25 High voltage battery interface
- 26 Motor controller (electric motor and inverter)
- 27 Body control module
- 29 Windscreen wiper
- 30 Body control module
- 31 Body control module
- 32 Steering wheel

**Instrument panel fuse box**

**Fuse box on the left side of the instrument panel**

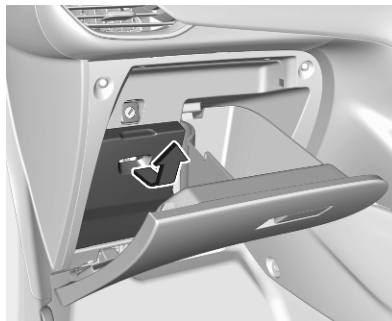

In right-hand drive vehicles, the fuse box is located behind a cover in the glovebox. Open the glovebox and remove the cover.

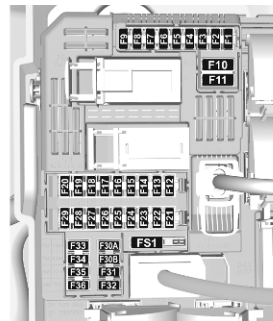
**Non-electric vehicle****No. Circuit**

---

- 1 Radar / Interior mirror
- 3 Inductive charging
- 4 Horn
- 5 Windscreen washer
- 6 Windscreen washer
- 7 USB
- 8 Rear wiper
- 10 Central locking system

**No. Circuit**

---

- 11 Central locking system
- 12 Diagnostic connector module
- 13 Climate control system
- 14 Alarm / Vauxhall Connect
- 17 Instrument cluster
- 21 Power button / Anti-theft locking system
- 22 Rain sensor / Light sensor / Camera
- 23 Seatbelt reminder
- 24 Infotainment / Parking assist / Rear view camera
- 25 Airbag
- 27 Anti-theft alarm system
- 29 Infotainment
- 31 Cigarette lighter / 12 V power outlet
- 32 Heated steering wheel

**No. Circuit**

---

- 33 Climate control system / Automatic transmission
- 34 Parking assist / Exterior mirror adjustment

**Electric vehicle**

**No. Circuit**

---

- 1 Radar / Interior mirror
- 3 Inductive charging
- 4 Horn
- 5 Windscreen washer
- 6 Windscreen washer
- 7 USB
- 8 Rear wiper
- 10 Central locking system
- 11 Central locking system
- 12 Diagnostic connector module
- 13 Climate control module / radio faceplate

**No. Circuit**

---

- 14 Alarm / Vauxhall Connect
- 15 Electronic shifter module / Headlight control unit
- 16 Low voltage network separation device
- 17 Instrument cluster
- 18 Reserved for Aftersales equipment
- 19 Steering column control / Steering wheel controls
- 21 Power button
- 22 Rain sensor / Light sensor / Camera
- 23 Seatbelt reminder
- 24 Infotainment / Parking assist / Rear view camera
- 25 Airbag
- 27 Anti-theft alarm system
- 29 Infotainment

**No. Circuit**

---

- 31 Cigarette lighter / 12 V power outlet
- 32 Heated steering wheel
- 33 Right front headlight
- 34 Parking assist / Exterior mirror adjustment

**Fuse box on the right side of the instrument panel**

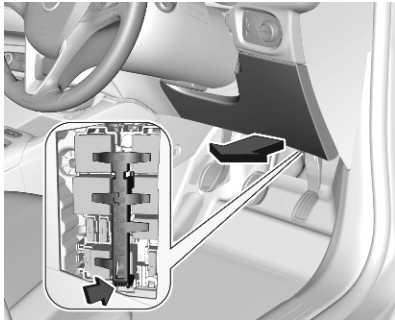

In right-hand drive vehicles, the fuse box is located behind a cover in the instrument panel. Disengage cover at the bottom side and remove. Remove the bracket.

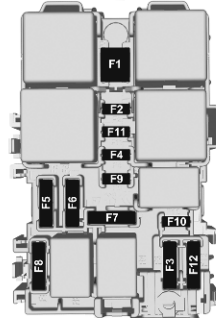

**No. Circuit**

---

- 1 Heated rear window
- 2 Heated exterior mirrors
- 3 Power windows front
- 4 Exterior mirror adjustment / Folding mirrors
- 5 Power windows rear

**No. Circuit**

---

- 8 Fuse box (right side of the instrument panel)
- 10 Heated front seats
- 11 Seat massage function

## Vehicle tools

### Tools

#### Vehicles with spare wheel

Open the load compartment.

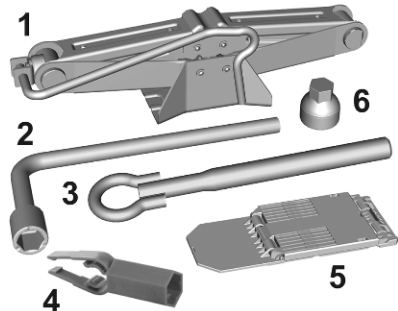

The tools are located in the tool bag:

- Jack (1)
- Wheel wrench (2)
- Towing eye (3)
- Wheel bolt cover remover (4)
- Chock (5)
- Adapter for the locking wheel nuts (6)

#### Vehicles without spare wheel

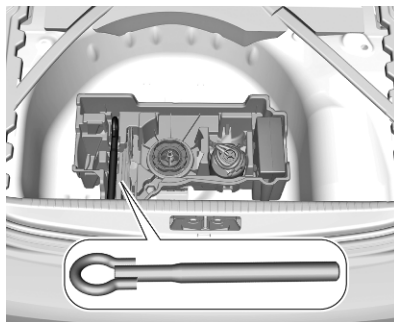

The towing eye is located in a box below the floor cover in the load compartment.

Tyre repair kit ⇨ 212.

## Wheels and tyres

### Tyre condition, wheel condition

Drive over edges slowly and at right angles if possible. Driving over sharp edges can cause tyre and wheel damage. Do not trap tyres on the kerb when parking.

Regularly check the wheels for damage. Seek the assistance of a workshop in the event of damage or unusual wear.

### Winter tyres

Winter tyres improve driving safety at temperatures below 7 °C and should therefore be fitted on all wheels.

In accordance with country-specific regulations, affix the speed sticker in the driver's field of view, if the tyre speed code is below the maximum speed of the vehicle.

All tyre sizes are permitted as winter tyres ⇨ 239.

## Tyre designations

E.g. **225/55 R 18 98 V**

**225** : tyre width, mm

**55** : cross-section ratio (tyre height to tyre width), %

**R** : belt type: Radial

**RF** : type: RunFlat

**18** : wheel diameter, inches

**98** : load index e.g. 98 is equivalent to 750 kg

**V** : speed code letter

Speed code letter:

**Q** : up to 100 mph

**S** : up to 112 mph

**T** : up to 118 mph

**H** : up to 130 mph

**V** : up to 150 mph

**W** : up to 168 mph

Choose a tyre appropriate for the maximum speed of your vehicle.

The maximum speed is achievable at kerb weight with driver (75 kg) plus 125 kg payload. Optional equipment could reduce the maximum speed of the vehicle.

## Directional tyres

Directional tyres should be mounted so that they rotate in the correct direction. The proper rotation direction is indicated by a symbol (e.g. an arrow) on the sidewall.

## Tyre pressure

Check the pressure of cold tyres at least every 14 days and before any long journey. Do not forget the spare wheel. This also applies to vehicles with tyre deflation detection system.



The tyre pressure information label indicates the original equipment tyres and the correspondent tyre pressures.

The tyre pressure data refers to cold tyres. It applies to summer and winter tyres.

Always inflate the full size spare tyre to the pressure specified for full load.

Incorrect tyre pressures will impair safety, vehicle handling, comfort and fuel economy and will increase tyre wear.

The driver is responsible for correct adjustment of tyre pressure.

The tyre pressure tables show all possible tyre combinations ↻ 239.

For the tyres approved for your vehicle, refer to the EEC Certificate of Conformity provided with your vehicle or other national registration documents.

For the correct tyre pressure value, follow the procedure below:

1. Identify the engine identifier code.  
Engine data ↻ 236.
2. Identify the respective tyre.

**⚠ Warning**

If the pressure is too low, this can result in considerable tyre warm-up and internal damage, leading to tread separation and even to tyre blow-out at high speeds.

**⚠ Warning**

For specific tyres the recommended tyre pressure as shown in the tyre pressure table may exceed the maximum tyre pressure as indicated on the tyre. Never exceed the maximum tyre pressure as indicated on the tyre.

**Temperature dependency**

The tyre pressure depends on the temperature of the tyre. During driving, tyre temperature and pressure increase. Tyre pressure values provided on the tyre information label and tyre pressure chart are valid for cold tyres, which means at 20 °C.

The pressure increases by nearly 1.5 psi for a 10 °C temperature increase. This must be considered when warm tyres are checked.

**Tyre deflation detection system**

The tyre deflation detection system continually checks the rotation speed of all four wheels and warns on low tyre pressure condition once vehicle is driving. This is achieved by comparing tyre rolling circumference with reference values and further signals.

If a tyre loses pressure the control indicator (⚠) illuminates and a warning message is displayed in the Driver Information Centre.

Control indicator (⚠) ⇨ 72.

In this case reduce speed, avoid sharp cornering and strong braking. Stop at next safe opportunity and check tyre pressure.

After adjusting tyre pressure initialise system to extinguish the control indicator and restart system.

If the failure continues to be displayed, contact a workshop. The system is inoperable when the ABS or Electronic Stability Control has a malfunction or a temporary spare wheel is used. Once the tyre has been refitted, check the tyre pressure with cold tyres and initialise the system.

**Caution**

Deflation detection system warns just about low tyre pressure condition and does not replace regular tyre maintenance by the driver.

**System initialisation**

After tyre pressure correction or wheel change, the system must be initialised to learn new circumference reference values:

1. Always ensure that all four tyres have correct tyre pressure  
⇨ 239.
2. Apply parking brake.



3. Initialise the system via the Info Display ↗ 77.
4. Reset is confirmed by pop-up indication.

After initialisation system automatically calibrates to new tyre pressures during driving. After longer drive the system will adopt and monitor new pressures.

Always check tyre pressure with cold tyres.

System has to be reinitialised when:

- Tyre pressure has been changed
- Load condition has been changed
- Wheels have been swapped or exchanged

The system will not warn instantaneously on a tyre blow out or a rapid deflation. This is due to required calculation time.

## Tread depth

Check tread depth at regular intervals.

Tyres should be replaced for safety reasons at a tread depth of 2-3 mm (4 mm for winter tyres).

For safety reasons, it is recommended that the tread depth of the tyres on one axle should not vary by more than 2 mm.



The legally permissible minimum tread depth (1.6 mm) has been reached when the tread has worn down as far as one of the tread wear indicators (TWI). Their position is indicated by markings on the sidewall.

If there is more wear at the front than the rear, swap round front wheels and rear wheels periodically. Ensure that the direction of rotation of the wheels remains the same.

Tyres age, even if they are not used. We recommend tyre replacement every 6 years.

## Changing tyre and wheel size

If tyres of a different size than those fitted at the factory are used, it may be necessary to reprogramme the system and make other vehicle modifications.

Have the label with tyre pressures replaced.

### **⚠ Warning**

The use of unsuitable tyres or wheels may lead to accidents and will invalidate the vehicle operating permit.

## Wheel covers

Wheel covers and tyres that are factory approved for the respective vehicle and comply with all of the relevant wheel and tyre combination requirements must be used.

If the wheel covers and tyres used are not factory approved, the tyres must not have a rim protection ridge.

Wheel covers must not impair brake cooling.

### ⚠ Warning

Use of unsuitable tyres or wheel covers could lead to sudden pressure loss and thereby accidents.

Vehicles with steel wheels: When using locking wheel nuts, do not attach wheel covers.

## Tyre chains

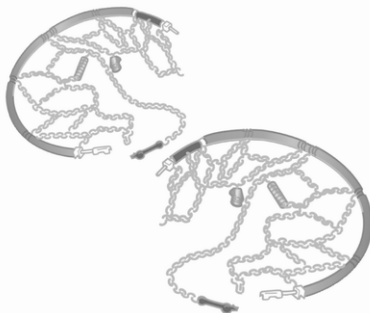

Tyre chains are only permitted on the front wheels.

Always use fine mesh chains that add no more than 9 mm to the tyre tread and the inboard sides (including chain lock).

### ⚠ Warning

Damage may lead to tyre blowout.

Tyre chains are permitted on tyres of size 185/65R15 and 195/55R16.

## Temporary spare wheel

The use of tyre chains is not permitted on the temporary spare wheel.

## Tyre repair kit

Minor damage to the tyre tread can be repaired with the tyre repair kit.

Do not remove foreign bodies from the tyres.

Tyre damage exceeding 4 mm or that is at tyre's sidewall cannot be repaired with the tyre repair kit.

Depending on version, there are two different tyre repair kits (Type A and Type B).

### ⚠ Warning

Do not drive faster than 50 mph.  
Do not use for a lengthy period.  
Steering and handling may be affected.

In the case of a flat tyre:

Apply the parking brake and engage first gear, reverse gear or **P**.

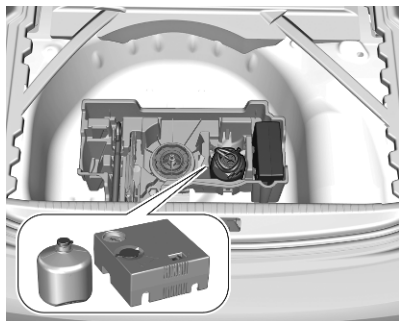

Type A

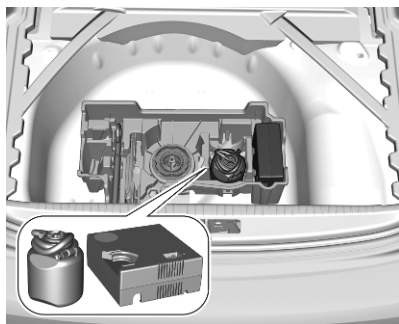

Type B

The tyre repair kit is in the load compartment below the floor cover.

1. Remove the sealant bottle and the compressor.
2. Pull speed limit label from sealant bottle and place it in driver's visible area.

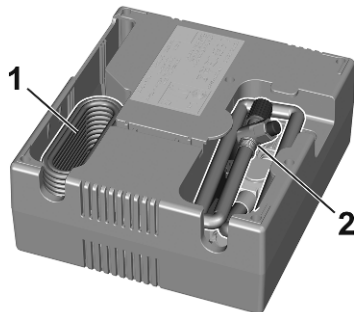

3. Remove the electrical connection cable (1) and air hose (2) from the storage compartments on the underside of the compressor.

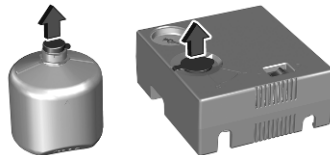

4. Type A: Open sealant bottle and lift the lid.

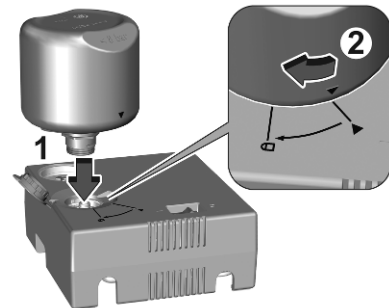

5. Type A: First, insert sealant bottle into the compressor and align the triangle symbols. Then, push down sealant bottle and turn it to the lock position.

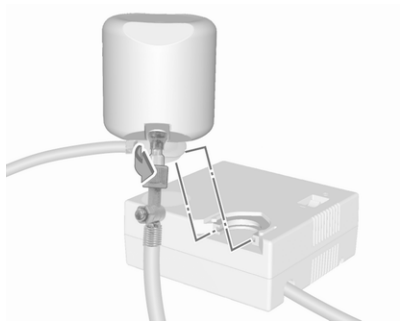

Type B: Screw the compressor air hose to the connection on the sealant bottle.

6. Type B: Fit the sealant bottle into the bracket on the compressor.
7. Set the compressor near the tyre in such a way that the sealant bottle is upright.
8. Unscrew valve cap from defective tyre.

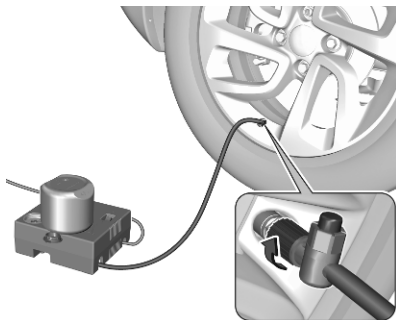

9. Screw the filler hose to the tyre valve.
10. The switch on the compressor must be set to O.
11. Connect the compressor plug to the 12 V power outlet or cigarette lighter socket ↻ 58.  
To avoid discharging the vehicle battery, we recommend running the engine.

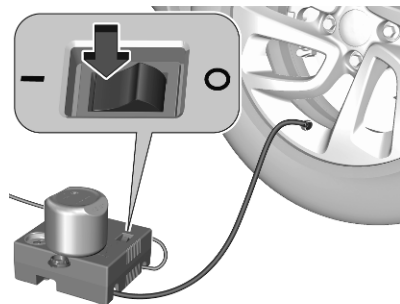

12. Set the rocker switch on the compressor to I. The tyre is filled with sealant.
13. The compressor pressure gauge briefly indicates up to 600 kPa (6 bar) whilst the sealant bottle is emptying (approx. 30 seconds). Then the pressure starts to drop.
14. All of the sealant is pumped into the tyre. Then the tyre is being inflated.
15. The prescribed tyre pressure should be obtained within ten minutes.  
Tyre pressure ↻ 239.

When the correct pressure is obtained, switch off the compressor.

If the prescribed tyre pressure is not obtained within ten minutes, remove the tyre repair kit. Move the vehicle one tyre rotation.

Reattach the tyre repair kit and continue the filling procedure for ten minutes. If the prescribed tyre pressure is still not obtained, the tyre is too badly damaged. Seek the assistance of a workshop.

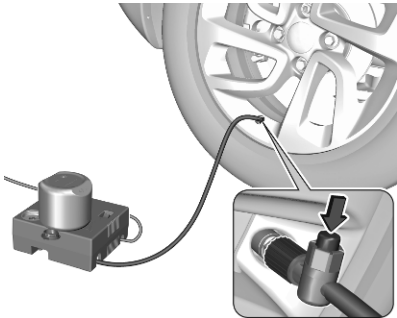

Drain excess tyre pressure with the button on the air hose.

Do not run the compressor longer than ten minutes.

16. Detach the tyre repair kit. Remove sealant bottle from compressor. Screw the filler hose to the free connection of the sealant bottle. This prevents sealant from escaping. Stow tyre repair kit in load compartment.
17. Remove any excess sealant using a cloth.
18. Continue driving immediately so that sealant is evenly distributed in the tyre. Drive between 13 mph and 37 mph. After driving approx. 3 miles but no more than ten minutes, stop and check tyre pressure. Screw compressor air hose directly onto tyre valve when doing this. Fill tyre as described before. Drain excess tyre pressure with the button on the air hose.

If tyre pressure hasn't decreased under 200 kPa (2 bar), set it to the correct value. Otherwise the vehicle must not be used. Seek assistance of a workshop.

Repeat the checking procedure once more after driving further 6 miles but no more than ten

minutes to check that there is no more loss of pressure.

If the tyre pressure has fallen below 200 kPa (2 bar), the vehicle must not be used. Seek the assistance of a workshop.

19. Stow away tyre repair kit in load compartment.

#### Notice

The driving characteristics of the repaired tyre are severely affected, therefore have this tyre replaced.

If unusual noise is heard or the compressor becomes hot, turn compressor off for at least 30 min.

The built-in safety valve opens at a pressure of seven bar (102 psi).

Note the expiry date of the kit. After this date its sealing capability is no longer guaranteed. Pay attention to storage information on sealant bottle.

Replace the used sealant bottle. Dispose of the bottle as prescribed by applicable laws.

The compressor and sealant can be used from approx. -30 °C.

## Wheel changing

Make the following preparations and observe the following information:

- Park the vehicle on a level, firm and non-skid surface. The front wheels must be in the straight-ahead position.
- If necessary, place a chock under the wheel diagonally opposite the wheel to be changed.
- Apply the parking brake and engage first gear, reverse gear or **P**.
- If the ground on which the vehicle is standing is soft, a solid board (max. 1 cm thick) should be placed under the jack.
- Take heavy objects out of the vehicle before jacking up.
- No people or animals may be in the vehicle when it is jacked-up.
- Never crawl under a jacked-up vehicle.
- Do not start the vehicle when it is raised on the jack.
- Before screwing in the wheel bolts, clean them.

### ⚠ Warning

Do not grease wheel bolts.

### Tightening torques

#### Caution

If the vehicle is equipped with alloy wheel rims, tighten the wheel bolts manually at least for the first five turns.

Depending on the wheel rim material, two different bolts with different tightening torques are available.

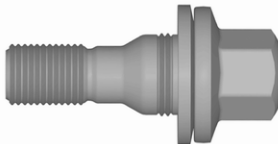

Tightening torque for alloy wheel rims is 115 Nm.

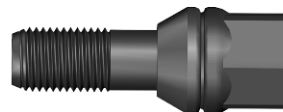

Tightening torque for steel wheel rims is:

- 100 Nm for 15" steel wheels.
- 115 Nm for 16" steel wheels.

### ⚠ Warning

Ensure to use always the correct wheel bolts if changing the wheels. When installing the spare wheel for temporary usage, the bolts for alloy wheel rims can also be used.

### Jacking positions

The jacking positions shown refer to the use of lifting arms and accessory jacks used for changing winter / summer tyres.



The rear arm position of the lifting platform is centrally under the relevant vehicle jacking point.

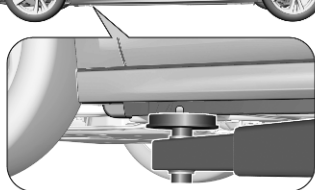

The front arm position of the lifting platform is centrally under the relevant vehicle jacking point.

## Spare wheel

The spare wheel can be classified as a temporary spare wheel depending on the size compared to the other mounted wheels and country regulations. In this case a permissible maximum speed applies, even though no label at the spare wheel indicates this.

Only mount one temporary spare wheel. The permissible maximum speed on the label on the temporary spare wheel is only valid for the factory-fitted tyre size.

Take curves slowly. Do not use for a long period of time.

### Caution

The use of a spare wheel that is smaller than the other wheels or in combination with winter tyres

could affect driveability. Have the defective tyre replaced as soon as possible.



The spare wheel is located in the load compartment beneath the floor covering.

To remove:

1. Open the floor cover ⇨ 48.
2. The temporary spare wheel is secured with a wing nut. Unscrew nut and take out the spare wheel.

3. When, after a wheel change, no wheel is placed in the spare wheel well, tighten the wing nut and close floor cover.
4. After wheel change back to full size wheel, place the temporary spare wheel outside up in the well and secure with the wing nut.

### Fitting the spare wheel

Make the following preparations and observe the following information:

- Park the vehicle on a level, firm and non-skid surface. The front wheels must be in the straight-ahead position.
- If necessary, place a chock under the wheel diagonally opposite the wheel to be changed.
- Apply the parking brake and engage first gear, reverse gear or P.
- Remove the spare wheel.
- Never change more than one wheel at once.

- Use the jack only to change wheels in case of puncture, not for seasonal winter or summer tyre change.
- The jack is maintenance-free.
- If the ground on which the vehicle is standing is soft, a solid board (max. 1 cm thick) should be placed under the jack.
- Take heavy objects out of the vehicle before jacking up.
- No people or animals may be in the vehicle when it is jacked-up.
- Never crawl under a jacked-up vehicle.
- Do not start the vehicle when it is raised on the jack.
- Before screwing in the wheel bolts, clean them.

### ⚠ Warning

Do not grease wheel bolts.

### ⚠ Warning

Ensure to use always the correct wheel bolts if changing the wheels. When installing the spare wheel for temporary usage, the bolts for alloy wheel rims can also be used.

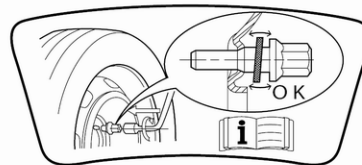

- Note that the spare wheel is secured by the conical contact of each bolt if the wheel bolts for the alloy wheel rims are used. In this case, the washers do not come into contact with the spare wheel.
1. Disengage wheel bolt caps with the wheel bolt cover remover.



Vehicle tools ⇨ 208.

Steel wheels rims with cover: Pull off the wheel cover.



2. Attach the wheel wrench and loosen each wheel bolt by half a turn.

The wheels might be protected by locking wheel nuts. To loosen these specific nuts first attach the adapter onto the head of the nut before installing the wheel wrench. The adapter is located in the tool bag ⇨ 208.



3. Ensure the jack is correctly positioned under the relevant vehicle jacking point.

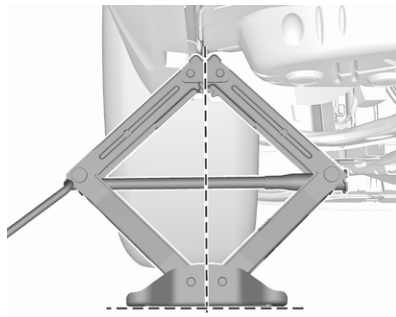

4. Set the jack to the necessary height. Position it directly below

the jacking point in a manner that prevents it from slipping.

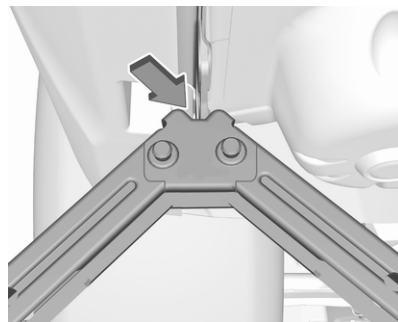

Ensure that the edge of the body fits into the notch of the jack.



With the jack correctly aligned rotate wheel wrench until wheel is clear of the ground.

5. Unscrew the wheel nuts.
6. Change the wheel.
7. Screw on the wheel nuts.
8. Lower the vehicle and remove jack.
9. Install the wheel wrench ensuring that it is located securely and tighten each bolt in a crosswise sequence.

Tightening torque for 15" is 100 Nm and for 16" is 115 Nm.

If the vehicle is equipped with alloy wheel rims, note that the wheel bolts can also be used for the spare wheel with steel rims. In this case, the spare wheel is secured by the conical contact of each bolt.

10. Vehicles with wheel cover: Align the valve hole in the wheel cover with the tyre valve before installing.

Install wheel nut caps.

11. Stow the replaced wheel and the vehicle tools.
12. Check the tyre pressure of the installed tyre and the wheel nut torque as soon as possible.

### Stowing a damaged full size wheel in the load compartment

The damaged full size wheel can be stowed in the spare wheel well. To secure the wheel:



1. Remove centre cap with the brand emblem by pushing from the inside.
2. Position the wheel outside down in the wheel well.

3. Secure the defective wheel with the wing nut.
4. Depending on the tyre size, the floor cover can be placed on the projecting wheel.

## Jump starting

Do not start with quick charger.

A vehicle with a discharged vehicle battery can be started using jump leads and the vehicle battery of another vehicle.

### Caution

Never jump start another vehicle with an electric vehicle.

### ⚠ Warning

Be extremely careful when starting with jump leads. Any deviation from the following instructions can lead to injuries or damage caused by battery explosion or damage to the electrical systems of both vehicles.

### ⚠ Warning

Avoid contact of the battery with eyes, skin, fabrics and painted surfaces. The fluid contains sulphuric acid which can cause injuries and damage in the event of direct contact.

- Never expose the vehicle battery to naked flames or sparks.
- A discharged vehicle battery can already freeze at a temperature of 0 °C. Defrost the frozen battery before connecting jump leads.
- Wear eye protection and protective clothing when handling a battery.
- Use a booster battery with the same voltage (12 V). Its capacity (Ah) must not be much less than that of the discharged vehicle battery.
- Use jump leads with insulated terminals and a cross section of at least 16 mm<sup>2</sup> (25 mm<sup>2</sup> for diesel engines).

- Do not disconnect the discharged vehicle battery from the vehicle.
- Switch off all unnecessary electrical consumers.
- Do not lean over the vehicle battery during jump starting.
- Do not allow the terminals of one lead to touch those of the other lead.
- The vehicles must not come into contact with each other during the jump starting process.
- Apply the parking brake, transmission in neutral, automatic transmission in P.

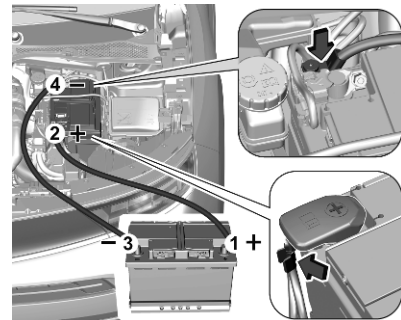

Lead connection order:

1. Connect the red lead to the positive terminal of the booster battery.
2. Connect the other end of the red lead to the positive terminal of the discharged battery.
3. Connect the black lead to the negative terminal of the booster battery.
4. Connect the other end of the black lead to a vehicle grounding point of your vehicle in the engine compartment.

Route the leads so that they cannot catch on rotating parts in the engine compartment.

To start the engine:

1. Start the engine of the vehicle providing the jump.
2. After 5 minutes, start the other engine. Start attempts should be made for no longer than 15 seconds at an interval of 1 minute.

3. Allow both engines to idle for approx. 3 minutes with the leads connected.
4. Switch on electrical consumers e.g. headlights, heated rear window.
5. Reverse above sequence exactly when removing leads.

## Towing

### Towing the vehicle



Remove the cap.

The towing eye is stowed with the vehicle tools ↗ 208.



Screw in the towing eye as far as it will go until it stops in a horizontal position.

Attach the tow rod to the towing eye.

The towing eye must only be used for towing and not for recovering the vehicle.

Switch on ignition to permit operation of brake lights, horn, windscreen wiper and, depending on version, to release the steering wheel lock.

### Caution

Deactivate the driver assistance systems like active emergency braking ⇨ 145, otherwise the vehicle may automatically brake during towing.

Switch the selector lever to neutral.  
Release the parking brake.

### Caution

Drive slowly. Do not drive jerkily. Excessive tractive force can damage the vehicle.

When the engine is not running, considerably more force is needed to brake and steer.

To prevent the entry of exhaust gases from the towing vehicle, switch on the air recirculation and close the windows.

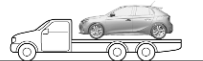

When towing an electric vehicle or a vehicle equipped with an automatic transmission, transport the vehicle on a platform or tow it with the front wheels lifted.

After towing, unscrew the towing eye.

Insert cap with the flange into the recess and fix cap by pushing.

## Towing another vehicle

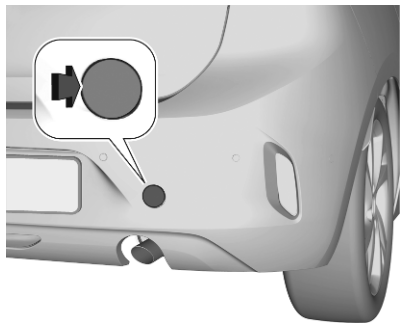

Remove the cap.

The towing eye is stowed with the vehicle tools ↗ 208.

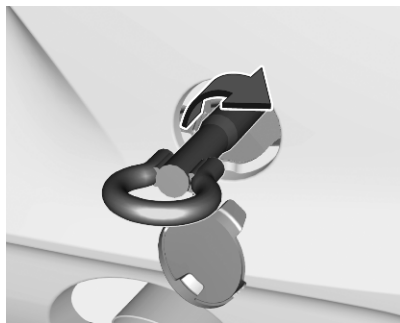

Screw in the towing eye as far as it will go until it stops in a horizontal position.

Attach a tow rope – or better still a tow rod – to the towing eye.

The towing eye must only be used for towing and not for recovering a vehicle.

### Caution

Drive slowly. Do not drive jerkily. Excessive tractive force can damage the vehicle.

After towing, unscrew the towing eye.

Insert cap with the upper flange into the recess and fix cap by pushing.

## Appearance care

### Exterior care

#### Locks

The locks are lubricated at the factory using a high quality lock cylinder grease. Use a de-icing agent only when absolutely necessary, as this has a degreasing effect and impairs lock function. After using a de-icing agent, have the locks regreased by a workshop.

#### Washing

The paintwork of your vehicle is exposed to environmental influences. Bird droppings, dead insects, resin, pollen and the like should be cleaned off immediately, as they contain aggressive constituents which can cause paint damage.

If using a vehicle wash, comply with the vehicle wash manufacturer's instructions. The windscreen wiper and rear window wiper must be

switched off. Remove antenna and external accessories such as roof racks etc.

If you wash your vehicle by hand, make sure that the insides of the wheel housings are also thoroughly rinsed out.

Clean edges and folds on opened doors and the bonnet as well as the areas they cover.

Clean bright metal mouldings with a cleaning solution approved for aluminium to avoid damages.

### Caution

Always use a cleaning agent with a pH value of 4 to 9.

Do not use cleaning agents on hot surfaces.

Do not clean the engine compartment with a steam-jet or high-pressure jet cleaner.

Thoroughly rinse and leather-off the vehicle. Rinse leather frequently. Use separate leathers for painted and glass surfaces: remnants of wax on the windows will impair vision.

Have the door hinges of all doors greased by a workshop.

### Exterior lights

Headlight and other light covers are made of plastic. Do not use any abrasive or caustic agents, do not use an ice scraper, and do not clean them dry.

### Polishing and waxing

Polishing is necessary only if the paint has become dull or if solid deposits have become attached to it.

Plastic body parts must not be treated with wax or polishing agents.

### Windows and wiper blades

Switch off wipers before handling in their areas.

Use a soft lint-free cloth or chamois leather together with window cleaner and insect remover.

When cleaning the rear window from inside, always wipe in parallel to the heating element to prevent damage.

For mechanical removal of ice, use a sharp-edged ice scraper. Press the scraper firmly against the glass so that no dirt can get under it and scratch the glass.

Clean smearing wiper blades with a soft cloth and window cleaner. Also make sure to remove any residues such as wax, insect residues and similar from the window.

Ice residues, pollution and continuous wiping on dry windows will damage or even destroy the wiper blades.

### Wheels and tyres

Do not use high-pressure jet cleaners.

Clean rims with a pH-neutral wheel cleaner.

Rims are painted and can be treated with the same agents as the body.

### Paintwork damage

Rectify minor paintwork damage with a touch-up pen before rust forms. Have more extensive damage or rust areas repaired by a workshop.

## Underbody

Some areas of the vehicle underbody have a PVC undercoating while other critical areas have a durable protective wax coating.

After the underbody is washed, check the underbody and have it waxed if necessary.

Bitumen / rubber materials could damage the PVC coating. Have underbody work carried out by a workshop.

Before and after winter, wash the underbody and have the protective wax coating checked.

## Towing equipment

Do not clean the coupling ball bar with a steam-jet or high-pressure jet cleaner.

## Interior care

### Interior and upholstery

Only clean the vehicle interior, including the instrument panel fascia and panelling, with a dry cloth or interior cleaner.

Clean the leather upholstery with clear water and a soft cloth. In case of heavy soiling, use leather care.

The instrument cluster and the displays should only be cleaned using a soft damp cloth. If necessary use a weak soap solution.

Clean fabric upholstery with a vacuum cleaner and brush. Remove stains with an upholstery cleaner.

Clothing fabrics may not be colourfast. This could cause visible discolourations, especially on light-coloured upholstery. Removable stains and discolourations should be cleaned as soon as possible.

Clean seat belts with lukewarm water or interior cleaner.

### Caution

Close Velcro fasteners as open Velcro fasteners on clothing could damage seat upholstery.

The same applies to clothing with sharp-edged objects, like zips or belts or studded jeans.

### Plastic and rubber parts

Plastic and rubber parts can be cleaned with the same cleaner as used to clean the body. Use interior cleaner if necessary. Do not use any other agent. Avoid solvents and petrol in particular. Do not use high-pressure jet cleaners.

### Floor mats

#### Warning

If a floor mat has the wrong size or is not properly installed, it can interfere with the accelerator pedal and/or brake pedal, what can cause unintended acceleration



and/or increased stopping distance which can cause a crash and injury.

Use the following guidelines for proper floor mat usage.

- The original equipment floor mats were designed for this vehicle. If the floor mats need to be replaced, it is recommended to buy certified floor mats which fit properly and are fixed by the retainers on the driver side. Always check that the floor mats do not interfere with the pedals.
- Use the floor mat with the correct side up. Do not turn it over.
- Do not place anything on top of the driver side floor mat.
- Use only a single floor mat on the driver side.

### Inserting and removing the floor mats

The driver side floor mat is held in place by two retainers.

To install the floor mat:

1. Move the seat backwards as far as possible.

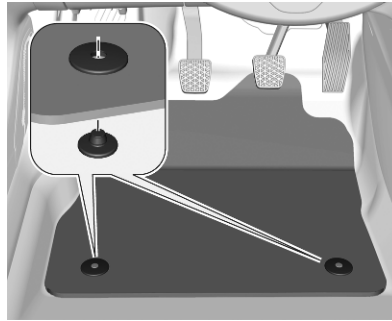

2. Align slots in the mat with the retainers, as shown.
3. Push the mat to the floor.

### Removing

1. Move the seat backwards as far as possible.
2. Remove the mat.

## Service and maintenance

|                                                       |            |
|-------------------------------------------------------|------------|
| <b>General information</b> .....                      | <b>228</b> |
| Service information .....                             | 228        |
| <b>Recommended fluids, lubricants and parts</b> ..... | <b>231</b> |
| Recommended fluids and lubricants .....               | 231        |

## General information

### Service information

In order to ensure economical and safe vehicle operation and to maintain the value of your vehicle, it is of vital importance that all maintenance work is carried out at the proper intervals as specified.

The detailed, up-to-date service schedule for your vehicle is available at the workshop.

Severe operating conditions exist if one or more of the following circumstances occur frequently: Cold starting, stop and go operation, e.g. for taxis and police vehicles, trailer operation, mountain driving, driving on poor and sandy road surfaces, increased air pollution, presence of airborne sand and high dust content, driving at high altitude and large variations of temperature.

Under these severe operating conditions, certain service work may be required more frequently than the regular service interval indicated in

the service display. Contact a workshop for customised service schedules.

Service display ⇨ 64.

## Service intervals

| Engine code     | EB2FAD,<br>EB2FAMD    | EB2ADTD,<br>EB2ADTS,<br>EB2ADTSM,<br>EB2ADTMD | DV5RCf                              | Electric vehicle                     |
|-----------------|-----------------------|-----------------------------------------------|-------------------------------------|--------------------------------------|
| Country group 1 | 12,000 miles / 1 year | 12,000 miles / 1 year                         | 19,000 miles / 1 year <sup>1)</sup> | 16,000 miles / 2 years <sup>2)</sup> |

1) Unless otherwise indicated in the service display.

2) Initial service interval is 8,000 miles / 1 year

### Country Group 1:

Andorra, Austria, Belgium, Cyprus, Denmark, Finland, France, Germany, Greece, Iceland, Italy, Liechtenstein, Luxembourg, Malta, Monaco, Netherlands, Norway, Portugal, Republic of Ireland, San Marino, Spain, Sweden, Switzerland, United Kingdom.

### Country Group 2:

Bosnia-Herzegovina, Bulgaria, Croatia, Czech Republic, Estonia, Hungary, Latvia, Lithuania, North Macedonia, Poland, Romania, Slovakia, Slovenia.

### Country Group 3:

Albania, Kosovo, Montenegro, New Zealand, Serbia.

### Country Group 4:

Israel, Lesotho, South Africa, Swaziland, Turkey.

### Country Group 5:

Russia.

### Country Group 6:

All other countries which are not listed in the previous country groups.

### **Confirmations**

Confirmation of service is recorded in the Service and warranty booklet. The date and mileage is completed with the stamp and signature of the servicing workshop.

Make sure that the Service and warranty booklet is completed correctly as continuous proof of service is essential if any warranty or goodwill claims are to be met, and is also a benefit when selling the vehicle.

## Recommended fluids, lubricants and parts

### Recommended fluids and lubricants

Only use products that meet the recommended specifications.

#### Warning

Operating materials are hazardous and could be poisonous. Handle with care. Pay attention to information given on the containers.

### Engine oil

Engine oil is identified by its quality and its viscosity. Quality is more important than viscosity when selecting which engine oil to use. The oil quality ensures e.g. engine cleanliness, wear protection and oil aging control, whereas viscosity grade gives information on the oil's thickness over a temperature range.

Select the appropriate engine oil based on its quality and on the minimum ambient temperature ⇨ 235.

### Topping up engine oil

#### Caution

In case of any spilled oil, wipe it up and dispose it properly.

Engine oils of different manufacturers and brands can be mixed as long as they comply with the required engine oil quality and viscosity.

Use of engine oils for all petrol engines with only ACEA quality is prohibited, since it can cause engine damage under certain operating conditions.

### Additional engine oil additives

The use of additional engine oil additives could cause damage and invalidate the warranty.

### Engine oil viscosity grades

The SAE viscosity grade gives information of the thickness of the oil.

Multigrade oil is indicated by two figures, e.g. SAE 5W-30. The first figure, followed by a W, indicates the low temperature viscosity and the second figure the high temperature viscosity.

Select the appropriate viscosity grade depending on the minimum ambient temperature ⇨ 235.

All of the recommended viscosity grades are suitable for high ambient temperatures.

### Coolant and antifreeze

Use only antifreeze approved for the vehicle. Consult a workshop.

The system is factory filled with coolant designed for excellent corrosion protection and frost protection down to approx. -28 °C. In cold regions with very low temperatures the factory filled coolant provides frost protection down to approx. -37 °C. This concentration should be maintained all year round. The use of additional coolant additives that intend to give additional corrosion protection or seal against minor leaks can cause function

problems. Liability for consequences resulting from the use of additional coolant additives will be rejected.

### **Washer fluid**

Use only washer fluid approved for the vehicle to prevent damage of wiper blades, paintwork, plastic and rubber parts. Consult a workshop.

### **Brake and clutch fluid**

Over time, brake fluid absorbs moisture which will reduce braking effectiveness. The brake fluid should therefore be replaced at the specified interval.

Use only brake fluid approved for the vehicle. Consult a workshop.

### **AdBlue**

Only use AdBlue to reduce the nitrogen oxides in the exhaust emission ↪ 111.

## Technical data

|                                            |            |
|--------------------------------------------|------------|
| <b>Vehicle identification</b> .....        | <b>233</b> |
| Vehicle identification number ..           | 233        |
| Identification plate .....                 | 233        |
| Engine identification .....                | 234        |
| <b>Vehicle data</b> .....                  | <b>235</b> |
| Recommended fluids and<br>lubricants ..... | 235        |
| Engine data .....                          | 236        |
| Vehicle dimensions .....                   | 237        |
| Capacities .....                           | 238        |
| Tyre pressures .....                       | 239        |

## Vehicle identification

### Vehicle identification number

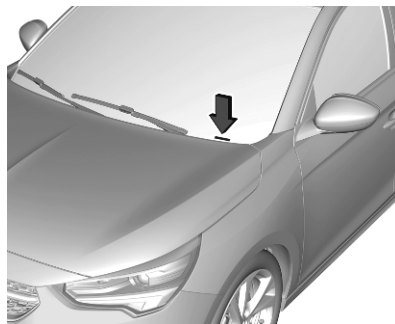

The Vehicle Identification Number may be embossed on the instrument panel, visible through the windscreen, or in the engine compartment on the right body panel.

## Identification plate

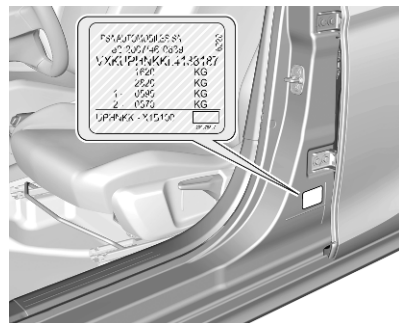

The identification plate is located on the front left or right door frame. The layout and position differ for some export countries.

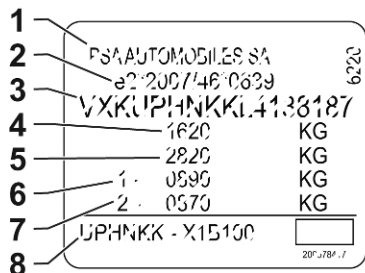

Information on identification label:

- 1 : manufacturer
- 2 : type approval number
- 3 : vehicle identification number
- 4 : permissible gross vehicle weight rating in kg
- 5 : permissible gross train weight in kg
- 6 : maximum permissible front axle load in kg
- 7 : maximum permissible rear axle load in kg
- 8 : manufacturer address, vehicle-specific or country-specific data

The combined total of front and rear axle loads must not exceed the permissible gross vehicle weight.

Vehicle's kerb weight depends on the specification of the vehicle, e.g. optional equipment and accessories. Refer to the EEC Certificate of Conformity provided with your vehicle or other national registration documents.

The technical data is determined in accordance with European Community standards. We reserve the right to make modifications. Specifications in the vehicle documents always have priority over those given in this manual.

## Engine identification

The technical data tables show the engine identifier code.

Engine data ↪ 236.

To identify the respective engine, refer to the engine power in the EEC Certificate of Conformity provided with your vehicle or other national registration documents.



## Vehicle data

### Recommended fluids and lubricants

#### Required engine oil quality

Country groups ⇨ 228

Countries included in country groups 1 to 3 and 5

EB2FAD  
 EB2FAMD  
 EB2ADTD  
 EB2ADTS  
 EB2ADTSM  
 EB2ADTMD  
 DV5RCf

Vauxhall Original engine oil

B71 2010 / B71 2312

#### Engine oil viscosity grades

|                            | B71 2010  | B71 2312  | B71 2302  | B71 2297  |
|----------------------------|-----------|-----------|-----------|-----------|
| Engine oil viscosity grade | SAE 0W-20 | SAE 0W-30 | SAE 0W-30 | SAE 5W-30 |

## Engine data

| Engine identifier code                 | EB2FAD,<br>EB2FAMD | EB2ADTD,<br>EB2ADTMD | EB2ADTS,<br>EB2ADTSM | DV5RCf       | Electric vehicle |
|----------------------------------------|--------------------|----------------------|----------------------|--------------|------------------|
| <b>Sales designation</b>               | <b>1.2</b>         | <b>1.2 T</b>         | <b>1.2 T</b>         | <b>1.5 D</b> | –                |
| Piston displacement [cm <sup>3</sup> ] | 1199               | 1199                 | 1199                 | 1499         | –                |
| Engine power [kW]                      | 55                 | 74                   | 96                   | 74           | 97 / 100         |
| at rpm                                 | 5750               | 5500                 | 5500                 | 3500         | –                |
| Torque [Nm]                            | 110 / 116          | 205                  | 230                  | 240 / 250    | 260              |
| at rpm                                 | 2750               | 1750                 | 1750                 | 1750         | –                |
| Fuel type                              | Petrol             | Petrol               | Petrol               | Diesel       | –                |
| Octane rating RON <sup>1)2)</sup>      |                    |                      |                      |              |                  |
| recommended                            | 95                 | 95                   | 95                   | –            | –                |
| possible                               | 98                 | 98                   | 98                   | –            | –                |
| possible                               | 91                 | 91                   | 91                   | –            | –                |
| Additional fuel type                   | –                  | –                    | –                    | –            | –                |

1) A country specific label at the fuel filler flap can supersede the engine specific requirement.

2) In certain countries, the use of a particular fuel, e.g. a specific octane rating, may be required to ensure proper engine operation.

---

## Vehicle dimensions

|                                                        |       |
|--------------------------------------------------------|-------|
| Length [mm]                                            | 4060  |
| Width without exterior mirrors [mm]                    | 1745  |
| Width with two exterior mirrors folded [mm]            | 1791  |
| Width with two exterior mirrors [mm]                   | 1960  |
| Height (without antenna) [mm]                          | 1432  |
| Length of load compartment floor [mm]                  | 680   |
| Length of load compartment with folded second row [mm] | 1385  |
| Load compartment width between wheel arches [mm]       | 1018  |
| Load compartment width at seat belt height [mm]        | 833   |
| Wheelbase [mm]                                         | 2538  |
| Turning circle diameter [m]                            | 10.32 |

---

## Capacities

### Engine oil

| Engine                  | EB2FAD,<br>EB2FAMD | EB2ADTD,<br>EB2ADTMD | EB2ADTS,<br>EB2ADTSM, | DV5RCf |
|-------------------------|--------------------|----------------------|-----------------------|--------|
| including filter [l]    | 3.25               | 3.5                  | 3.5                   | 4.0    |
| between MIN and MAX [l] | 1.0                | 1.0                  | 1.0                   | 1.5    |

---

### Fuel tank

|                                |    |
|--------------------------------|----|
| Petrol, refilling quantity [l] | 44 |
| Diesel, refilling quantity [l] | 41 |

---

### AdBlue tank

|                                |    |
|--------------------------------|----|
| AdBlue, refilling quantity [l] | 13 |
|--------------------------------|----|

---

### High voltage battery

|                        |    |
|------------------------|----|
| Battery capacity [kWh] | 50 |
|------------------------|----|

---

## Tyre pressures

| Engine                                                | Tyres                      | Vehicle with up to 3 people |                   | With full load    |                   |
|-------------------------------------------------------|----------------------------|-----------------------------|-------------------|-------------------|-------------------|
|                                                       |                            | front                       | rear              | front             | rear              |
|                                                       |                            | [kPa/bar] ([psi])           | [kPa/bar] ([psi]) | [kPa/bar] ([psi]) | [kPa/bar] ([psi]) |
| EB2FAD,<br>EB2FAMD                                    | 185/65 R15,<br>195/55 R16, | 220/2.2 (32)                | 210/2.1 (30)      | 270/2.7 (39)      | 290/2.9 (42)      |
| EB2ADTD,<br>EB2ADTS,<br>EB2ADTSM,<br>DV5RD,<br>DV5RCf | 195/55 R16,<br>205/45 R17  | 220/2.2 (32)                | 210/2.1 (30)      | 270/2.7 (39)      | 290/2.9 (42)      |
| Electric vehicle                                      | 195/55 R16,<br>205/45 R17  | 250/2.5 (36)                | 250/2.5 (36)      | 250/2.5 (36)      | 300/3.0 (45)      |
| All                                                   | Temporary spare wheel      | 420/4.2 (60)                | 420/4.2 (60)      | 420/4.2 (60)      | 420/4.2 (60)      |

## Customer information

|                                                 |            |
|-------------------------------------------------|------------|
| <b>Customer information</b> .....               | <b>240</b> |
| Declaration of conformity .....                 | 240        |
| REACH .....                                     | 242        |
| Software update .....                           | 242        |
| Registered trademarks .....                     | 243        |
| <b>Vehicle data recording and privacy</b> ..... | <b>244</b> |
| Event data recorders .....                      | 244        |
| Radio Frequency Identification (RFID) .....     | 247        |

## Customer information

### Declaration of conformity

#### Radio transmission systems

This vehicle has systems that transmit and / or receive radio waves subject to Directive 2014/53/EU and The Radio Equipment Regulations 2017 by the United Kingdom. The manufacturers of the systems listed below declare conformity with Directive 2014/53/EU and The Radio Equipment Regulations 2017. The full text of the EU declaration of conformity for each system is available at the following internet address: [www.opel.com/conformity](http://www.opel.com/conformity).

Importer is  
Opel / Vauxhall, Bahnhofspatz,  
65423 Ruesselsheim am Main,  
Germany.

Importer is Vauxhall Motors Limited,  
MP UK 1-101-135, Chalton House,  
Luton Road, Chalton, Luton,  
Bedfordshire, LU4 9TT, United  
Kingdom.

#### Infotainment system Multimedia Navi Pro / Multimedia Navi

Continental Automotive Czech Republic s.r.o

Prumyslová 1851, 250 01 Brandys nad Labem, Czech Republic

|      | Operation frequency (MHz) | Maximum output (dBm) |
|------|---------------------------|----------------------|
| BT   | 2402.0 - 2480.0           | 4.1                  |
| Wifi | 2412.0 - 2462.0           | 16.7                 |

#### Infotainment system Radio

Hangsheng France Front Office

Coeur Défense, 110 Espl. du Général de Gaulle, Paris, 9231 la Défense, France

Operation frequency:  
2402.0 - 2480.0 MHz

Maximum output: 4 dBm

#### Infotainment system Multimedia

Robert Bosch Car Multimedia GmbH

Robert-Bosch-Strasse 200, 31139 Hildesheim, Germany

Operation frequency:  
2400.0 - 2483.5 MHz

Maximum output: 4 dBm

#### Wireless charger

Continental Automotive GmbH  
Siemensstrasse 12, 93055  
Regensburg, Germany

Operation frequency:  
90.0 - 119.0 kHz

Maximum output:  
39.24dB $\mu$ A/m at 3m

#### Antenna module

Hirschmann Car Communication  
GmbH  
Stuttgarter Strasse 45-51, 72654  
Neckartenzlingen, Germany  
Operation frequency: N/A

Maximum output: N/A

ASK Industrie SpA

C.P. 110 c/o U.P. RE2, 42121 Reggio  
Emilia, Italy

Operation frequency: N/A

Maximum output: N/A

Fiamm France - RCA Spa

12 rue Augustin Fresnel, 78420  
Aubergenville, France

Operation frequency: N/A

Maximum output: N/A

#### Electronic key transmitter

Valeo Comfort and Driving  
Assistance

76, rue Auguste Perret 94046 Créteil  
- CEDEX France

Operation frequency:  
433.05 - 434.79 MHz

Maximum output: -6,85 dBm

#### Electronic key receiver

Valeo Comfort and Driving  
Assistance

76, rue Auguste Perret 94046 Créteil  
- CEDEX France

|       | Operation<br>frequency | Maximum<br>output (dBm) |
|-------|------------------------|-------------------------|
| BT    | 2402.0 -<br>2480.0     | 5.0                     |
| Radio | 125 kHz                | - 7.3                   |

#### Radio remote control transmitter

Huf Hülsbeck & Fürst GmbH & Co.  
KG

Steeger Str. 17, 42551 Velbert,  
Germany

Operation frequency:  
433.05 - 434.79 MHz

Maximum output: -14 dBm

#### Radio remote control receiver

Aptiv Services France SAS  
22 Avenue des Nations ZAC Paris  
Nord II 93420 Villepinte France

Operation frequency: 125 kHz

Maximum output: 66 dB $\mu$ A/m at 10m

#### Immobiliser

Kostal Bulgaria Automotive  
Pazardzhik

ul. "Sinitevska" 4, 4400 Southern  
Industrial Zone, Bulgaria

Operation frequency: 119 - 134 kHz

Maximum output: 72 dB $\mu$ A/m at 10m

#### Radar unit

ZF TRW Autocruise SAS

Secteur de la Pointe du Diable,  
Avenue du technopôle, 29280  
Plouzane, France

Operation frequency:  
76.0 - 77.0 GHz

Maximum output: 28 dBm

**BTA Module**

Marelli S.p.A.

Viale A. Borletti 61/63, 20011  
Corbetta, Italy

|          | Operation frequency (MHz) | Maximum output (dBm) |
|----------|---------------------------|----------------------|
| GSM 900  | 880 -960                  | 33                   |
| GSM 1800 | 1710 - 1880               | 30                   |
| UMTS     | 880 -960                  | 24                   |
|          | 1920 - 2170               | 24                   |

**ICASA type approval numbers**

List of all Independent Communications Authority of South Africa (ICASA) type approval numbers:

TA-2018/5025, TA-2018/5031,  
TA-2017/2387, TA-2018/1848,  
TA-2018/208, TA-2017/1106,  
TA-2017/3180

**REACH**

Registration, Evaluation, Authorisation and Restriction of Chemicals (REACH) is a European Union regulation adopted to improve the protection of human health and the environment from the risks that can be posed by chemicals. Visit [www.opel.com](http://www.opel.com) for further information and for access to the Article 33 communication.

**Software update**

The Infotainment system can download and install selected software updates over a wireless connection.

**Notice**

The availability of these over-the-air vehicle software updates varies by vehicle and country. Find more information on our website.

**Remote device management and remote software and firmware updates**

As an integral part of the service related to the performance of subscribed connected service contracts, necessary device management and necessary software and firmware updates related to the software and firmware for the named connected service will be performed remotely, in particular by using over-the-air technology.

For this, a secure radio network connection between the vehicle and the device management server will be established when ignition is switched on and a mobile network is available. Depending on the equipment of the vehicle, connection configuration must be set to **Connected vehicle** to allow the establishment of the radio network connection.

Irrespective of a valid connected service subscription, remote product security or product safety related device management and software and firmware updates will be performed when the processing is



necessary for the compliance with a legal obligation to which the manufacturer is subject (e.g. applicable product liability law, emergency call regulation) or when the processing is necessary in order to protect the vital interests of the respective vehicle users and passengers.

The establishment of a secure radio network connection and the related remote updates are not affected by privacy settings and will be performed in principal after an initiation by the vehicle user following a respective notification.

The system is able to notify receipt of an update as soon as it is connected to an exterior Wi-Fi network or a mobile network. Large updates are downloaded only via the Wi-Fi network.

The availability of an update is notified on the Info Display at the end of a trip with an option of immediate installation or postponement of installation.

The installation time is variable and can take several minutes with a maximum of about 30 minutes. A notification will give an estimate of the duration and a description of the update.

Updates can be checked manually via the Info Display. Follow the on-screen prompts in the respective menu.

Info Display ⇨ 77.

#### **Notice**

Steps for downloading and installing updates may vary by vehicle.

For safety reasons and because it requires sustained attention by the driver, the installation must be carried out with the ignition on without starting the engine. The installation cannot be carried out in the following cases:

- engine running
- emergency call in progress
- insufficient vehicle battery charge
- charging the vehicle's high voltage battery

#### **Notice**

During the installation process, the vehicle may not be operational.

If the update has failed, seek the assistance of a workshop.

## **Registered trademarks**

### **Apple Inc.**

Apple CarPlay™ is a trademark of Apple Inc.

App Store® and iTunes Store® are registered trademarks of Apple Inc.

iPhone®, iPod®, iPod touch®, iPod nano®, iPad® and Siri® are registered trademarks of Apple Inc.

### **Bluetooth SIG, Inc.**

Bluetooth® is a registered trademark of Bluetooth SIG, Inc.

### **DivX, LLC**

DivX® and DivX Certified® are registered trademarks of DivX, LLC.

### **Google Inc.**

Android™ and Google Play™ Store are trademarks of Google Inc.

### Velcro Companies

Velcro® is a registered trademark of Velcro Companies.

### Verband der Automobilindustrie e.V.

AdBlue® is a registered trademark of the VDA.

## Vehicle data recording and privacy

### Event data recorders

Electronic control units are installed in your vehicle. Control units process data which is received by vehicle sensors, for example, or which they generate themselves or exchange amongst themselves. Some control units are necessary for the safe functioning of your vehicle, others assist you while you drive (driver assistance systems), while others provide comfort or infotainment functions.

The following contains general information about data processing in the vehicle. You will find additional information as to which specific data is uploaded, stored and passed on to third parties and for what purpose in your vehicle under the key word Data Protection closely linked to the references for the affected functional characteristics in the relevant owner's manual or in the general terms of sale. These are also available online.

### Operating data in the vehicle

Control units process data for operation of the vehicle.

This data includes, for example:

- vehicle status information (e.g. speed, movement delay, lateral acceleration, wheel rotation rate, "seat belts fastened" display)
- ambient conditions (e.g. temperature, rain sensor, distance sensor)

As a rule such data is transient and is not stored for longer than an operational cycle, and only processed on board the vehicle itself. Often control units include data storage (including the vehicle key). This is used to allow information to be documented temporarily or permanently on vehicle condition, component stress, maintenance requirements and technical events and errors.

Depending on technical equipment levels, the data stored is as follows:

- system component operating states (e.g. fill level, tyre pressure, battery status)
- faults and defects in important system components (e.g. lights, brakes)
- system reactions in special driving situations (e.g. triggering of an airbag, actuation of the stability control systems)
- information on events damaging the vehicle
- for electric vehicles the amount of charge in the high-voltage battery, estimated range

In special cases (e.g. if the vehicle has detected a malfunction), it may be necessary to save data that would otherwise just be volatile.

When you use services (e.g. repairs, maintenance), the operating data saved can be read together with the vehicle identification number and used where necessary. Staff working for the service network (e.g. garages, manufacturers) or third parties (e.g.

breakdown services) can read the data from the vehicle. The same applies to warranty work and quality assurance measures.

Data is generally read via the OBD (On-Board Diagnostics) port prescribed by law in the vehicle. The operating data read documents the technical condition of the vehicle or individual components and assists with fault diagnosis, compliance with warranty obligations and quality improvement. This data, in particular information on component stress, technical events, operator errors and other faults, is transmitted to the manufacturer where appropriate, together with the vehicle identification number. The manufacturer is also subject to product liability. The manufacturer potentially also uses operating data from vehicles for product recalls. This data can also be used to check customer warranty and guarantee claims.

Fault memories in the vehicle can be reset by a service company when carrying out servicing or repairs or at your request.

## Comfort and infotainment functions

Comfort settings and custom settings can be stored in the vehicle and changed or reset at any time.

Depending on the equipment level in question, these include

- seat and steering wheel position settings
- chassis and air conditioning settings
- custom settings such as interior lighting

You can input your own data in the infotainment functions for your vehicle as part of the selected features.

Depending on the equipment level in question, these include

- multimedia data such as music, videos or photos for playback in an integrated multimedia system
- address book data for use with an integrated hands-free system or an integrated navigation system

- input destinations
- data on the use of online services

This data for comfort and infotainment functions can be stored locally in the vehicle or be kept on a device that you have connected to the vehicle (e.g. a smartphone, USB stick or MP3 player). Data that you have input yourself can be deleted at any time.

This data can only be transmitted out of the vehicle at your request, particularly when using online services in accordance with the settings selected by you.

### **Smartphone integration, e.g. Android Auto or Apple CarPlay**

If your vehicle is equipped accordingly, you can connect your smartphone or another mobile device to the vehicle so that you can control it via the controls integrated in the vehicle. The smartphone image and sound can be output via the multimedia system in this case. At the same time, specific information is transmitted to your smartphone. Depending on the type of integration,

this includes data such as position data, day / night mode and other general vehicle information. For more information, please see the operating instructions for the vehicle / infotainment system.

Integration allows selected smartphone apps to be used, such as navigation or music playback. No further integration is possible between smartphone and vehicle, in particular active access to vehicle data. The nature of further data processing is determined by the provider of the app used. Whether you can define settings, and if so which ones, is dependent on the app in question and your smartphone's operating system.

### **Online services**

If your vehicle has a radio network connection, this allows data to be exchanged between your vehicle and other systems. The radio network connection is made possible by means of a transmitter device in your vehicle or a mobile device provided by you (e.g. a smartphone). Online functions can be used via this radio network connection. These include online services and applications / apps provided to you by the manufacturer or other providers.

### **Proprietary services**

In the case of the manufacturer's online services, the relevant functions are described by the manufacturer in an appropriate location (e.g. Owner's Manual, the manufacturer's website) and the associated data protection information is provided. Personal data may be used to provide online services. Data exchange for this purpose takes place via a protected connection, e.g. using the manufacturer's IT systems provided for the purpose. Collection,

processing and use of personal data for the purposes of preparation of services take place solely on the basis of legal permission, e.g. in the case of a legally prescribed emergency communication system or a contractual agreement, or by virtue of consent.

You can activate or deactivate the services and functions (which are subject to charges to some extent) and, in some cases, the vehicle's entire radio network connection. This does not include statutory functions and services such as an emergency communication system.

### **Third party services**

If you make use of online services from other providers (third parties), these services are subject to the liability and data protection and usage conditions of the provider in question. The manufacturer frequently has no influence over the content exchanged in this regard.

Therefore, please note the nature, scope and purpose of the collection and use of personal data within the scope of third party services provided by the service provider in question.

### **Radio Frequency Identification (RFID)**

RFID technology is used in some vehicles for functions such as tyre pressure monitoring and immobiliser. It is also used in connection with conveniences such as radio remote controls for door locking / unlocking and starting. RFID technology in Vauxhall vehicles does not use or record personal information or link with any other Vauxhall system containing personal information.

## Index

**A**

|                                                        |         |
|--------------------------------------------------------|---------|
| Accessories and vehicle modifications .....            | 186     |
| Active emergency braking....                           | 74, 145 |
| Adaptive cruise control .....                          | 137     |
| AdBlue.....                                            | 72, 111 |
| Adjustable air vents .....                             | 100     |
| Advanced lane keep assist..                            | 71, 168 |
| Advanced parking assist.....                           | 154     |
| Airbag and belt tensioners .....                       | 68      |
| Airbag deactivation .....                              | 38, 68  |
| Airbag label.....                                      | 33      |
| Airbag system .....                                    | 33      |
| Air conditioning regular operation .....               | 101     |
| Air conditioning system .....                          | 93      |
| Air intake .....                                       | 101     |
| Air vents.....                                         | 100     |
| Antilock brake system .....                            | 126     |
| Antilock brake system (ABS) .....                      | 70      |
| Anti-theft alarm system .....                          | 18      |
| Anti-theft locking system .....                        | 17      |
| Appearance care.....                                   | 224     |
| Armrest.....                                           | 30      |
| Automatic anti-dazzle .....                            | 22      |
| Automatic crash notification.....                      | 81      |
| Automatic light control .....                          | 84      |
| Automatic locking .....                                | 15      |
| Automatic operation of electric parking brake off..... | 70      |

|                              |         |
|------------------------------|---------|
| Automatic transmission ..... | 118     |
| Autostop.....                | 73, 107 |
| Auxiliary heater.....        | 99      |

**B**

|                                    |     |
|------------------------------------|-----|
| Battery discharge protection ..... | 91  |
| BlueInjection.....                 | 111 |
| Bonnet .....                       | 191 |
| Brake and clutch fluid.....        | 231 |
| Brake and clutch system .....      | 69  |
| Brake assist .....                 | 129 |
| Brake fluid .....                  | 194 |
| Brakes.....                        | 194 |
| Breakdown.....                     | 222 |
| Bulb replacement .....             | 198 |

**C**

|                                 |          |
|---------------------------------|----------|
| Capacities .....                | 238      |
| Car wash mode.....              | 114, 127 |
| Catalytic converter .....       | 111      |
| Central locking system .....    | 10       |
| Centre console storage .....    | 46       |
| Changing tyre and wheel size .. | 211      |
| Charging.....                   | 175      |
| Charging cable.....             | 173      |
| Charging cable connected.....   | 73       |
| Charging status.....            | 179      |
| Charging system .....           | 68       |
| Charging types.....             | 172      |
| Child locks .....               | 15       |

|                               |     |
|-------------------------------|-----|
| Child restraint installation  |     |
| locations .....               | 43  |
| Child restraints.....         | 39  |
| Child restraint systems ..... | 39  |
| Climate control systems.....  | 92  |
| Clock.....                    | 58  |
| Control indicators.....       | 65  |
| Control of the vehicle .....  | 103 |
| Controls.....                 | 54  |
| Convex shape .....            | 20  |
| Coolant and antifreeze.....   | 231 |
| Cruise control .....          | 132 |
| Cupholders .....              | 45  |
| Curtain airbag system .....   | 38  |
| Curve lighting.....           | 86  |

## D

|                                   |     |
|-----------------------------------|-----|
| Danger, Warnings and Cautions ... | 4   |
| Daytime running lights .....      | 86  |
| Declaration of conformity.....    | 240 |
| DEF.....                          | 111 |
| Deflation detection system.....   | 72  |
| Diesel exhaust fluid.....         | 111 |
| Diesel fuel system bleeding ..... | 197 |
| Door open .....                   | 74  |
| Door panel storage.....           | 46  |
| Doors.....                        | 16  |
| Drive modes.....                  | 125 |
| Driver alert.....                 | 170 |
| Driver assistance systems.....    | 132 |

|                                                  |     |
|--------------------------------------------------|-----|
| Driver Information Centre.....                   | 74  |
| Driving characteristics and<br>towing tips ..... | 184 |
| Driving hints.....                               | 103 |

## E

|                                                                 |               |
|-----------------------------------------------------------------|---------------|
| Electric adjustment .....                                       | 20            |
| Electrical system.....                                          | 203           |
| Electric drive unit.....                                        | 114           |
| Electric parking brake.....                                     | 127           |
| Electric parking brake fault.....                               | 70            |
| Electric power consumption.....                                 | 171           |
| Electric range.....                                             | 171           |
| Electronic climate control system                               | 95            |
| Electronic driving programmes ..                                | 123           |
| Electronic key system.....                                      | 8             |
| Electronic Stability Control and<br>Traction Control system.... | 71, 130       |
| Emergencies.....                                                | 103           |
| Emergency call.....                                             | 81            |
| End-of-life vehicle recovery .....                              | 189           |
| Engine compartment fuse box ...                                 | 203           |
| Engine coolant .....                                            | 193           |
| Engine coolant temperature .....                                | 71            |
| Engine coolant temperature<br>gauge .....                       | 64            |
| Engine data .....                                               | 236           |
| Engine exhaust .....                                            | 110           |
| Engine identification.....                                      | 234           |
| Engine oil .....                                                | 191, 231, 235 |

|                               |         |
|-------------------------------|---------|
| Engine oil level monitor..... | 64      |
| Engine oil pressure .....     | 72      |
| Entry lighting .....          | 91      |
| Event data recorders.....     | 244     |
| Exhaust filter.....           | 72, 110 |
| Exit lighting .....           | 91      |
| Exterior care .....           | 224     |
| Exterior light .....          | 73      |
| Exterior lighting.....        | 83      |
| Exterior mirrors.....         | 20      |

## F

|                                                         |             |
|---------------------------------------------------------|-------------|
| Fault .....                                             | 124         |
| Fixed air vents .....                                   | 101         |
| Floor mats.....                                         | 226         |
| Folding mirrors .....                                   | 20          |
| Forward collision alert.....                            | 144         |
| Front airbag system .....                               | 37          |
| Front fog lights .....                                  | 74, 88, 200 |
| Front pedestrian protection.....                        | 148         |
| Front seats.....                                        | 27          |
| Front turn lights .....                                 | 200         |
| Fuel.....                                               | 180         |
| Fuel consumption - CO <sub>2</sub> -<br>Emissions ..... | 183         |
| Fuel for diesel engines .....                           | 181         |
| Fuel for petrol engines .....                           | 180         |
| Fuel gauge .....                                        | 63          |
| Fuses .....                                             | 203         |

**G**

|                          |          |
|--------------------------|----------|
| Gauges.....              | 60       |
| Gear selection .....     | 119      |
| Gear shifting.....       | 70       |
| General information..... | 171, 184 |
| Glass panel .....        | 25       |
| Glovebox .....           | 45       |

**H**

|                                    |        |
|------------------------------------|--------|
| Halogen headlights .....           | 198    |
| Hand brake.....                    | 127    |
| Hazard warning flashers .....      | 88     |
| Headlight flash .....              | 85     |
| Headlight range adjustment .....   | 85     |
| Headlights.....                    | 83     |
| Headlights when driving abroad ..  | 86     |
| Head restraints .....              | 26     |
| Heated mirrors .....               | 21     |
| Heated rear window .....           | 24     |
| Heated steering wheel .....        | 54     |
| Heating .....                      | 30     |
| Heating and ventilation system ... | 92     |
| High beam .....                    | 73, 84 |
| High beam assist.....              | 73, 84 |
| High voltage battery.....          | 196    |
| High voltage battery gauge.....    | 63     |
| Hill start assist .....            | 130    |
| Horn .....                         | 55     |

**I**

|                                                |         |
|------------------------------------------------|---------|
| Identification plate .....                     | 233     |
| Ignition switch positions .....                | 104     |
| Immobiliser .....                              | 19      |
| Indicators.....                                | 65      |
| Inductive charging.....                        | 59      |
| Info Display.....                              | 77      |
| Instrument panel fuse box .....                | 205     |
| Instrument panel illumination<br>control ..... | 90      |
| Instrument panel overview .....                | 52      |
| Interior care .....                            | 226     |
| Interior lighting.....                         | 90      |
| Interior lights .....                          | 90, 202 |
| Interior mirrors.....                          | 22      |
| Interruption of power supply .....             | 124     |
| Introduction .....                             | 3       |

**J**

|                     |     |
|---------------------|-----|
| Jump starting ..... | 221 |
|---------------------|-----|

**K**

|                  |   |
|------------------|---|
| Keys .....       | 6 |
| Keys, locks..... | 6 |

**L**

|                        |         |
|------------------------|---------|
| Lane keep assist.....  | 70, 166 |
| Lashing eyes .....     | 49      |
| LED headlights.....    | 199     |
| Light switch .....     | 83      |
| Load compartment ..... | 16, 47  |

|                              |    |
|------------------------------|----|
| Load compartment cover ..... | 48 |
| Loading information .....    | 50 |
| Low beam.....                | 73 |
| Low fuel .....               | 73 |

**M**

|                                   |     |
|-----------------------------------|-----|
| Malfunction indicator light ..... | 68  |
| Manual anti-dazzle .....          | 22  |
| Manual mode .....                 | 122 |
| Manual seat adjustment.....       | 28  |
| Manual transmission .....         | 124 |
| Massage.....                      | 31  |
| Matrix-LED headlights.....        | 86  |
| Misted light covers .....         | 89  |

**N**

|                              |     |
|------------------------------|-----|
| New vehicle running-in ..... | 104 |
| Number plate light .....     | 202 |

**O**

|                               |          |
|-------------------------------|----------|
| Object detection systems..... | 149      |
| Odometer .....                | 61       |
| Oil, engine.....              | 231, 235 |
| Operation.....                | 114      |
| Outside temperature .....     | 57       |
| Overrun cut-off .....         | 107      |

**P**

|                            |     |
|----------------------------|-----|
| Panoramic roof.....        | 25  |
| Panoramic view system..... | 161 |
| Parking .....              | 109 |



|                                    |         |
|------------------------------------|---------|
| Parking assist .....               | 71, 149 |
| Parking brake.....                 | 69, 127 |
| Parking lights .....               | 89      |
| Particulate filter.....            | 110     |
| Pedestrian safety alert.....       | 55      |
| Pedestrian safety alert fault..... | 74      |
| Performing work .....              | 190     |
| Power button.....                  | 104     |
| Power indicator gauge.....         | 63      |
| Power outlets .....                | 58      |
| Power seat adjustment .....        | 29      |
| Power windows .....                | 23      |
| Preheating .....                   | 71      |
| Programmable charging.....         | 178     |
| Puncture.....                      | 217     |

**Q**

|                |    |
|----------------|----|
| Quickheat..... | 99 |
|----------------|----|

**R**

|                                            |             |
|--------------------------------------------|-------------|
| Radio Frequency Identification (RFID)..... | 247         |
| Radio remote control .....                 | 7           |
| Rain sensor.....                           | 74          |
| REACH.....                                 | 242         |
| Reading lights .....                       | 90          |
| Rear floor storage cover .....             | 48          |
| Rear fog light .....                       | 74, 89, 200 |
| Rear view camera .....                     | 164         |
| Rear window wiper and washer ..            | 57          |

|                                         |          |
|-----------------------------------------|----------|
| Recommended fluids and lubricants ..... | 231, 235 |
| Reduced engine power.....               | 73       |
| Refuelling .....                        | 182      |
| Regenerative braking.....               | 130      |
| Registered trademarks.....              | 243      |
| Reversing lights .....                  | 89       |
| Ride control systems.....               | 130      |
| Roadside assistance.....                | 82       |
| Roof.....                               | 25       |
| Roof load.....                          | 50       |
| Roof rack .....                         | 49       |

**S**

|                                    |          |
|------------------------------------|----------|
| Seat belt reminder .....           | 67       |
| Seat belts .....                   | 31       |
| Seat heating.....                  | 30       |
| Seat position .....                | 27       |
| Selective catalytic reduction..... | 111      |
| Selector lever.....                | 119      |
| Service .....                      | 101, 228 |
| Service display .....              | 64       |
| Service information .....          | 228      |
| Service vehicle soon .....         | 69       |
| Side airbag system .....           | 37       |
| Side blind spot alert.....         | 159      |
| Sidelights.....                    | 83       |
| Software update.....               | 242      |
| SOS.....                           | 81       |
| Spare wheel .....                  | 217      |

|                                 |               |
|---------------------------------|---------------|
| Speed limiter.....              | 135           |
| Speed limit recognition .....   | 132, 135, 137 |
| Speedometer .....               | 60            |
| Sport mode .....                | 131           |
| Starting and operating.....     | 104           |
| Starting the engine .....       | 106           |
| Steering.....                   | 103           |
| Steering wheel adjustment ..... | 54            |
| Steering wheel controls .....   | 54            |
| Stop engine.....                | 69            |
| Stop-start system.....          | 107           |
| Storage.....                    | 45            |
| Storage compartments.....       | 45            |
| Sun visors .....                | 25            |
| Symbols .....                   | 4             |
| System check.....               | 69            |

**T**

|                                  |          |
|----------------------------------|----------|
| Tachometer .....                 | 62       |
| Tailgate.....                    | 16       |
| Tail lights .....                | 200      |
| Temperature preconditioning..... | 99       |
| Three-point seat belt .....      | 32       |
| Tools .....                      | 208      |
| Tow bar.....                     | 184      |
| Towing.....                      | 184, 222 |
| Towing another vehicle .....     | 224      |
| Towing the vehicle .....         | 222      |
| Traffic sign assistant.....      | 165      |
| Trailer coupling.....            | 184      |

|                                   |        |
|-----------------------------------|--------|
| Trailer towing .....              | 184    |
| Transmission display .....        | 118    |
| Tread depth .....                 | 211    |
| Trip odometer .....               | 61     |
| Turn lights .....                 | 67, 88 |
| Tyre chains .....                 | 212    |
| Tyre deflation detection system . | 210    |
| Tyre designations .....           | 209    |
| Tyre pressure .....               | 209    |
| Tyre pressures .....              | 239    |
| Tyre repair kit .....             | 212    |

## U

|                                |     |
|--------------------------------|-----|
| Ultrasonic parking assist..... | 149 |
| Upholstery.....                | 226 |
| USB port.....                  | 58  |
| Using this manual .....        | 3   |

## V

|                       |     |
|-----------------------|-----|
| Vauxhall Connect..... | 82  |
| Vehicle battery ..... | 194 |
| Vehicle checks.....   | 190 |
| Vehicle data.....     | 235 |

|                                            |     |
|--------------------------------------------|-----|
| Vehicle data recording and<br>privacy..... | 244 |
| Vehicle dimensions .....                   | 237 |
| Vehicle identification number ...          | 233 |
| Vehicle jack.....                          | 208 |
| Vehicle locator lighting.....              | 91  |
| Vehicle messages .....                     | 79  |
| Vehicle personalisation .....              | 80  |
| Vehicle ready.....                         | 73  |
| Vehicle security.....                      | 17  |
| Vehicle specific data .....                | 3   |
| Vehicle storage.....                       | 188 |
| Vehicle tools.....                         | 208 |
| Ventilation.....                           | 92  |

## W

|                        |     |
|------------------------|-----|
| Warning chimes .....   | 79  |
| Warning lights.....    | 65  |
| Washer fluid .....     | 193 |
| Wheel changing .....   | 216 |
| Wheel covers .....     | 212 |
| Wheels and tyres ..... | 208 |
| Windows.....           | 23  |
| Windscreen.....        | 23  |

|                                  |     |
|----------------------------------|-----|
| Windscreen wiper and washer .... | 55  |
| Winter tyres .....               | 208 |
| Wiper blade replacement .....    | 197 |

Copyright by Vauxhall Motors Ltd.

The information contained in this publication is effective as of the date indicated below. Vauxhall Motors Ltd. reserves the right to make changes to the technical specifications, features and design of the vehicles relative to the information contained in this publication, as well as changes to the publication itself.

Edition: July 2022, Vauxhall Motors Ltd.

Printed on chlorine-free bleached paper.

**ID-VCRFORIE2207-en**

