

Vauxhall Movano / Vivaro

Infotainment System



Contents

| | |
|-------------------------|----|
| Introduction | 4 |
| Radio | 22 |
| CD Player | 30 |
| AUX input | 35 |
| USB port | 37 |
| Bluetooth music | 40 |
| Navigation | 46 |
| Voice recognition | 63 |
| Phone | 65 |
| Index | 86 |

Introduction

| | |
|---------------------------------|----|
| General information | 4 |
| Control elements overview | 6 |
| Theft-deterrent feature | 14 |
| Usage | 14 |
| Tone settings | 18 |
| Volume settings | 21 |

General information

The Infotainment system provides state-of-the-art in-car information and entertainment.

The radio is equipped with assignable channel presets for FM, MW and LW wavebands.

The audio player plays audio CDs, MP3 CDs and also WMA CDs.

External data storage devices, e.g. iPod, MP3 player or USB stick, or a portable player can be connected to the Infotainment system. External audio sources can also be connected via Bluetooth.

The digital sound processor provides several preset equalizer modes for sound optimisation.

The navigation system's dynamic route planning will reliably guide you to your destination and can help avoid traffic jams and other traffic problems.

Optionally, the Infotainment system can be operated using controls on the steering column or via the voice recognition system.

In addition, the Infotainment system can be equipped with a handsfree phone system.

The well-thought-out design of the controls and the clear displays enable you to control the system easily and intuitively.

Notice

This manual describes all options and features available for the various Infotainment systems. Certain descriptions, including those for display and menu functions, may not apply to your vehicle due to model variant, country specifications, special equipment or accessories.

Important information on operation and traffic safety

Warning

Drive safely at all times when using the Infotainment system.

If in doubt, stop the vehicle before operating the Infotainment system.

Radio reception

Radio reception may be disrupted by static, noise, distortion or loss of reception due to

- changes in distance from the transmitter,
- multi-path reception due to reflection,
- shadowing.

In case of poor radio reception the volume will automatically drop as to minimize the disturbance effect.

Using this manual

- This manual describes features that may or may not be on your specific vehicle, either because they are optional or due to changes subsequent to the printing of this manual. Please refer to the purchase documentation to confirm each of the features found on the vehicle.
- Certain controls and descriptions, including symbols, displays and menu functions may not apply to

your vehicle due to model variant, country specifications, special equipment or accessories.

- The table of contents at the beginning of this manual and within each section shows where the information is located.
- The index will enable you to search for specific information.
- The vehicle display screens may not support your specific language.
- Display messages and interior labelling are written in **bold** letters.
- The operations given within this manual refer to Infotainment system controls. For equivalent steering column controls, refer to the control elements overview ⇨ 6.

Warnings and Cautions

Warning

Text marked  **Warning** provides information on risk of accident or injury. Disregarding this information may lead to injury.

Caution

Text marked **Caution** provides information on possible damage to the vehicle. Disregarding this information may lead to vehicle damage.

Symbols

Page references are indicated with ⇨.
⇨ means "see page".

Control elements overview

CD35 BT

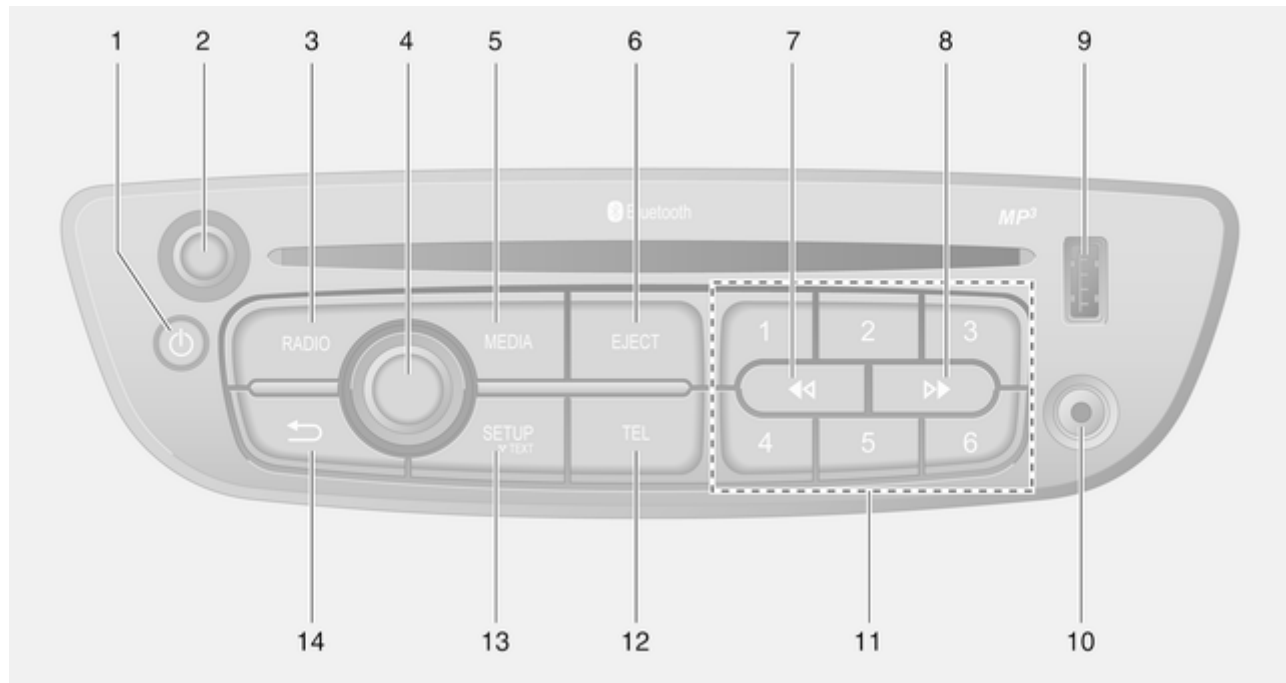

-
- | | | |
|---|--|--|
| <p>1 - Press: Switch on/off 14</p> <p>2 Volume rotary knob - Press: Mute/unmute 14</p> <p>Turn: Adjust volume 14</p> <p>3 RADIO - Change audio source, waveband 22</p> <p>4 Central rotary knob 14</p> <p>Press: Confirm an action 14</p> <p>Turn: Access display menu options 14</p> <p>Turn: Access the stored radio station list 22</p> <p>Turn: Select next/previous station 23</p> <p>Turn: Change CD/MP3 track 31</p> <p>5 MEDIA - Change audio source 31</p> <p>6 EJECT - CD ejection 31</p> | <p>7 - Radio, Short press: Search for previous radio frequency 23</p> <p>Long press: Automatic station search 23</p> <p>Audio/MP3/WMA CD, Short press: Skip track backwards 31</p> <p>Long press: Fast rewind 31</p> <p>8 - Radio, Short press: Search for next radio frequency 23</p> <p>Long press: Automatic station search 23</p> <p>Audio/MP3 CD, Short press: Skip track forwards 31</p> <p>Long press: Fast forward 31</p> <p>9 USB port 37</p> <p>10 AUX input 35</p> <p>11 Station buttons 1..6 23</p> <p>Short press: Select station 23</p> <p>Long press: Save station 23</p> <p>12 TEL - Telephone menu 65</p> | <p>13 SETUP / TEXT - Short press: Settings menu 14</p> <p>Long press: Display radio text information 27</p> <p>Long press: Display CD text information 31</p> <p>14 - Return to previous menu, cancel an action 14</p> |
|---|--|--|

CD30 BT

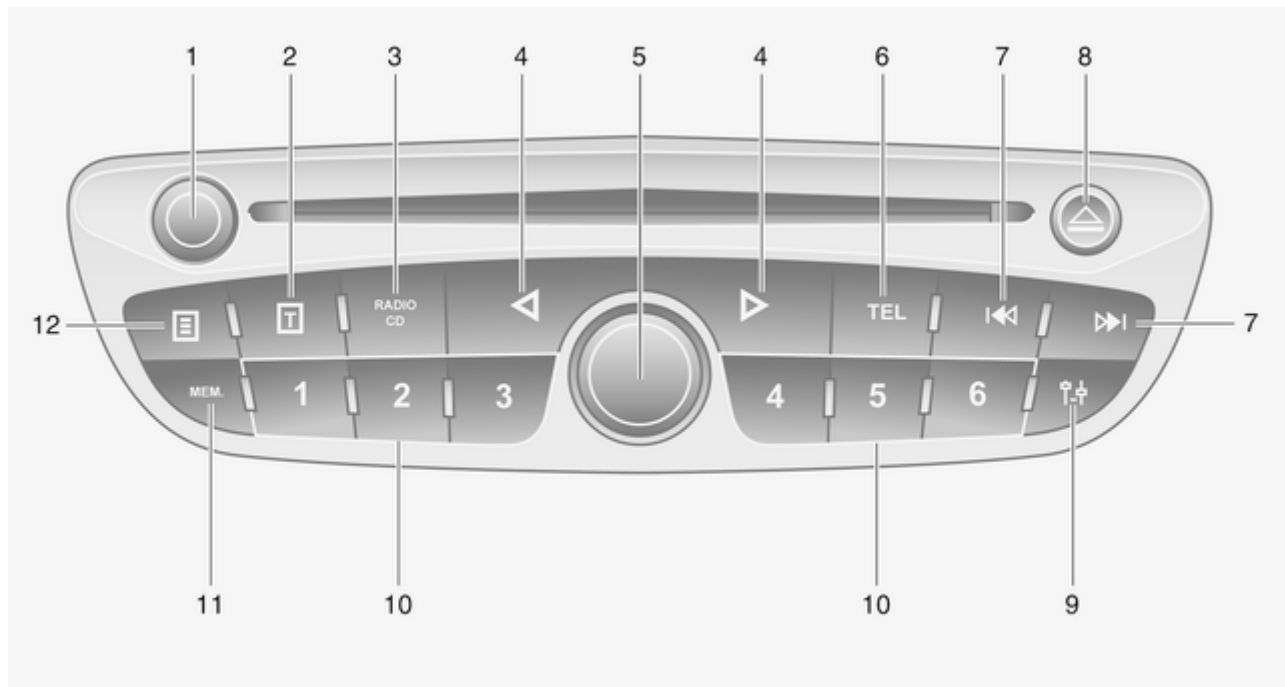

-
- | | | | |
|---|--|----|--|
| 1 | ⊖ - Turn: Adjust volume 14 | 9 | ⚙ - Settings menu 14 |
| | Press: Switch on/off 14 | 10 | Station buttons 1...6 26 |
| 2 | ⓘ - Display radio text information 27 | | Short press: Select station 26 |
| | Display CD text information . . 31 | | Long press: Save station 26 |
| 3 | RADIO/CD - Change audio source 22 | 11 | MEM - Access the stored radio station list 23 |
| 4 | ◀ / ▶ - Move left/right within display text, move around the display screen 23 | 12 | ⓘ - Display CD additional text information 31 |
| 5 | Central rotary knob 14 | | |
| | Press: Confirm an action 14 | | |
| | Turn: Search radio station or waveband 22 | | |
| | Turn: Change CD track 31 | | |
| 6 | TEL - Telephone menu 65 | | |
| 7 | ⏮ / ⏭ - Radio frequency: Search backwards/ forwards 23 | | |
| | Audio/MP3/WMA CD: Skip track backwards/ forwards 31 | | |
| 8 | ⏏ - CD ejection 31 | | |

R15 BT / CD15 BT

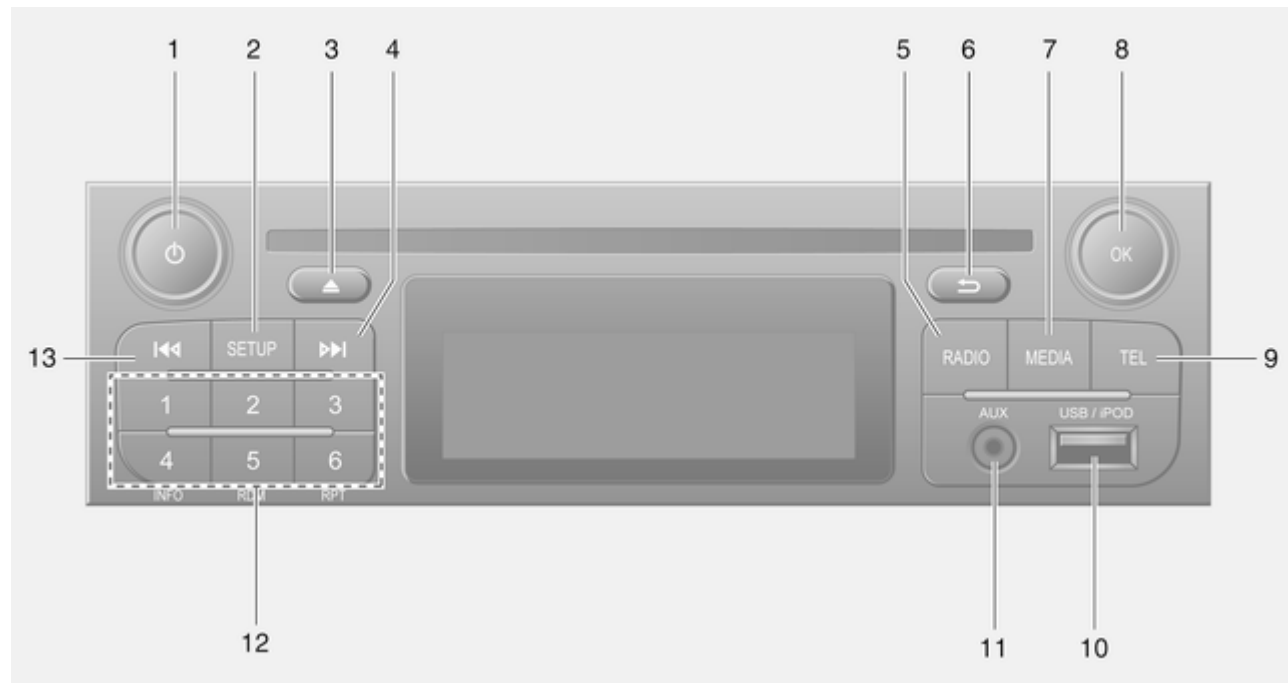

- | | | |
|---|--|--|
| <p>1 - Press: Switch on/off 14</p> <p>Press: Mute/unmute 14</p> <p>Turn: Adjust volume 14</p> <p>2 SETUP - Short press:</p> <p>Settings menu 14</p> <p>Display radio text information 27</p> <p>Long press: Automatic station storing 26</p> <p>3 - CD ejection (CD 15 BT) .. 31</p> <p>Mute/unmute (R15 BT) 14</p> <p>4 - Radio, Short press:</p> <p>Search for next radio frequency 23</p> <p>Long press: Automatic station search 23</p> <p>Audio/MP3/WMA CD, Short press: Skip track forwards (CD 15 BT) 31</p> <p>Long press: Fast forward (CD 15 BT) 31</p> <p>5 RADIO - Change audio source, waveband 22</p> | <p>6 - Return to previous menu, cancel an action 14</p> <p>7 MEDIA - Change audio source 31</p> <p>8 OK rotary knob 14</p> <p>Press: Confirm an action 14</p> <p>Turn: Access display menu options 14</p> <p>Turn: Change radio frequency 23</p> <p>Turn: Change CD/MP3 track (CD 15 BT) 31</p> <p>9 TEL - Telephone menu 65</p> <p>10 USB port 37</p> <p>11 AUX input 35</p> <p>12 Station buttons 1..6 23</p> <p>Short press: Select station 23</p> <p>Long press: Save station 23</p> | <p>Display CD text information (CD 15 BT) 31</p> <p>Audio/MP3/WMA CD tracks: Activate random playback (CD 15 BT) 31</p> <p>13 - Radio, Short press:</p> <p>Search for previous radio frequency 23</p> <p>Long press: Automatic station search 23</p> <p>Audio/MP3/WMA CD, Short press: Skip track backwards (CD 15 BT) 31</p> <p>Long press: Fast rewind (CD 15 BT) 31</p> |
|---|--|--|

Steering column controls - Type A

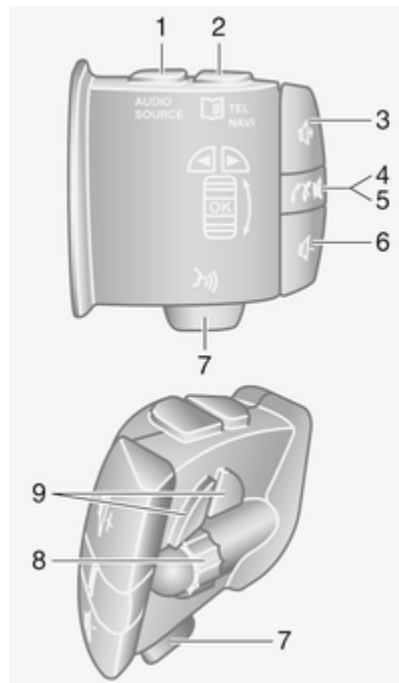

- 1 **AUDIO/SOURCE** - Change audio source 14
 - 2 **TEL** - Telephone menu 65
 - NAVI** - Navigation menu 49
 - 3 **↑** - Increase volume 14
 - 4 **⊘** - Mute/unmute 14
 - 5 **☎** - Take/end phone call 73
 - 6 **↓** - Decrease volume 14
 - 7 **🗣** - Voice recognition 63
 - 8 **OK** - Confirm actions 22
- Turn: Move up/down in display menus, select next/previous radio preset / radio frequency / audio track 23
- 9 **◀ / ▶** - Move left/right within display text, move around display screen 31

Steering column controls - Type B

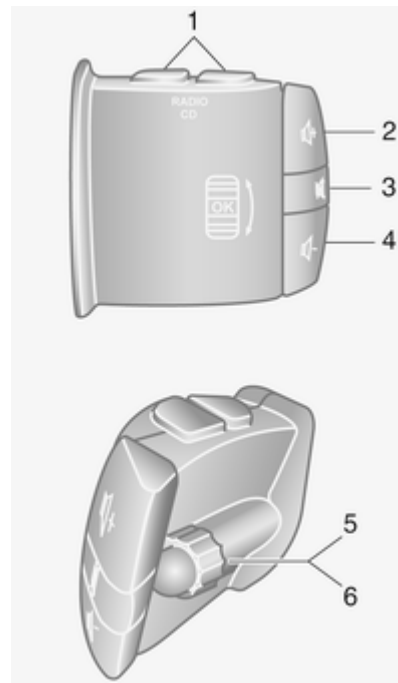

| | | |
|----------|---|----|
| 1 | RADIO/CD - Change audio source | 22 |
| 2 | 🔊 - Increase volume | 14 |
| 3 | 🔇 - Mute/unmute | 14 |
| 4 | 🔊 - Decrease volume | 14 |
| 5 | Short press: Change radio source/waveband | 22 |
| | Long press: Automatic station storing | 26 |
| 6 | Turn: Change radio frequency | 23 |
| | Short press: Select audio track (CD player mode) | 31 |
| | Long press: Fast forward/rewind an audio track (CD player mode) | 31 |

Steering column controls - Type C

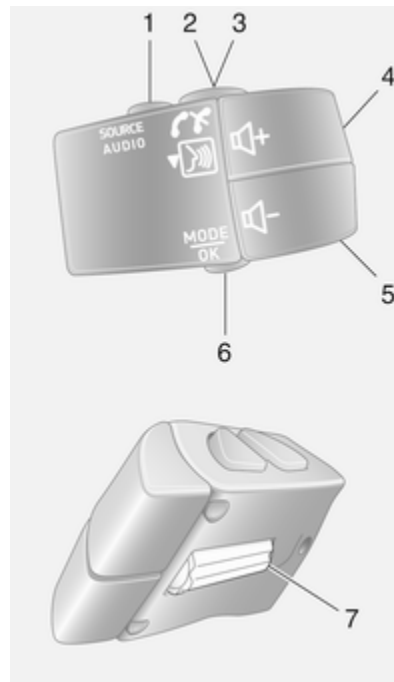

| | | |
|----------|---|----|
| 1 | SOURCE/AUDIO - Change audio source | 14 |
| 2 | 🔇/🔊 | 65 |
| | Take/end phone call | 73 |
| 3 | 🗣️ - Activate voice recognition | 63 |
| 4 | 🔊 - Increase volume, mute/unmute | 14 |
| 5 | 🔊 - Decrease volume, mute/unmute | 14 |
| 6 | MODE/OK - Confirm actions, change audio mode | 22 |
| | Take/end phone call | 73 |
| 7 | Turn: Access display menu options, next/previous radio preset / radio frequency / audio track | 22 |

Theft-deterrent feature

An electronic security system is included for the purpose of theft deterrence. The Infotainment system functions only in your vehicle and is therefore worthless to a thief.

The security code (supplied separately) must be entered upon first use of the system and after prolonged interruptions to the power supply.

Entering the security code

When first switching on the Infotainment system, the message **Radio code** then **0000** appears on the display screen.

To enter first digit of security code, press numbered button **1** on the unit repeatedly until desired number is displayed. Enter second, third and fourth digits using buttons **2**, **3** and **4** in the same way.

When the full code is displayed, press and hold button **6** until an audible signal sounds. The system is unlocked when the correct code has been entered.

Incorrect code entered

When an incorrect code has been entered, **Error code** then **Wait 100** is displayed.

Wait until the countdown has expired, then enter the correct code. Each time the code is entered incorrectly, the countdown time is doubled.

Changing the geographical area

When the security code is entered, you may be prompted to choose a geographical area, e.g.:

- Europe
- Asia
- Arabia
- America

Switch off the Infotainment system, then simultaneously press button **1** and **5** and the \odot rotary knob. Then press button \blacktriangleleft or \blacktriangleright until desired area is highlighted on the display screen and set with button **6**.

Usage

Infotainment controls

The Infotainment system is operated via buttons, rotary knobs and display menus.

Inputs are made via:

- the central control unit in the instrument panel \curvearrowright 6, or
- the controls on the steering column \curvearrowright 6
- the voice recognition system (if available) \curvearrowright 63

Switching the Infotainment system on or off

Press the \odot knob to switch the Infotainment system on.



The previously used audio source is active.

Press the \odot knob (or press and hold) to switch the Infotainment system off.



Automatic switch-off

With the ignition off, if the Infotainment system is switched on with the  knob, it will switch-off automatically a short period after the last user input. Depending on type fitted, this may occur after approx. 5 minutes.

Setting the volume

Turn the  rotary knob, or press button  or .

CD35 BT: Turn volume rotary knob.

Alternatively (with the steering column controls), press button  or .

Stored volume

When the Infotainment system is switched off, the current volume is stored.

CD30 BT: If the volume was greater than 15 when the system was switched off, it will automatically be reduced to 15 when switched on again.

1) Not with CD30.



Speed dependent volume

When speed dependent volume ( 21) is activated, the volume is adapted automatically to compensate for road and wind noise.

Mute

To mute the current audio source, press  knob briefly¹⁾.



CD35 BT: Press volume rotary knob briefly.

Alternatively (with the steering column controls), press the  button or press  and  simultaneously.

Unmute

To unmute, briefly press (or turn) the  knob again.

CD35 BT: Press volume rotary knob again.



Alternatively (with the steering column controls): Press  again or press  and  simultaneously again.

Display screen operation

R15 BT / CD15 BT

- To move up/down in the display: Turn the **OK** rotary knob.
- To confirm actions: Press the **OK** rotary knob.
- To cancel actions (and return to previous menu): Press the  button.

CD30 BT

- To move up/down in the display: Turn the rotary knob.
- To move left/right in the display: Press button  or .
- To confirm actions (and to move right only in the display): Press the rotary knob.

CD35 BT

- To move up/down in the display: Turn the central rotary knob.
- To confirm actions: Press the central rotary knob.
- To cancel actions (and return to previous menu): Press the \rightarrow button.

System settings

R15 BT / CD15 BT - System settings

Press the **SETUP** button and access the settings menu by turning and pressing the **OK** rotary knob.

When system setting adjustments have been made, press **SETUP** to exit the menu and save changes. The system also saves and exits automatically after a delay.

Change system language

Change the display language by accessing the **Language** menu. Select a language from the list by turning and pressing the **OK** knob.

Restore default system settings

To restore system settings to their default values, select **Default settings** by turning and pressing the **OK** knob. Confirm modification when prompted by pressing the **OK** knob again.

CD30 BT - System settings

Press the \updownarrow button and select the **System settings** menu.

When system setting adjustments have been made, press \updownarrow to exit the menu and save changes. The system also saves and exits automatically after a delay.

Set the clock

To set the time, access the **Clock** menu. Press button \leftarrow or \rightarrow to select the time menu items, then turn the rotary knob to adjust the time. Press button \leftarrow or \rightarrow to select the minutes, then turn rotary knob to adjust the time.

Change system language

Change the text and voice recognition language by accessing the **Language** menu. Select a language from the list. The voice recognition and phone functions are not available when the language is being changed.

Restore default system settings

To restore system settings to their default values, select **Default settings** by turning and pressing the rotary knob. Confirm modification with the display option when prompted.

CD35 BT - System settings

Press the **SETUP / TEXT** button to access the settings menu.

When system setting adjustments have been made, press **SETUP / TEXT** to exit the menu and save changes. The system also saves and exits automatically after a delay.

Set the clock

To set the time, access the **Clock** menu. Turn the central rotary knob to adjust the **Hours** setting, then press

the knob to confirm. Turn the knob to adjust the **Minutes** setting and press to confirm.

Change system language

Change the display language by accessing the **Language** menu. Turn the central rotary knob to select one of the 9 languages from the list, then press the knob to confirm.

Restore default system settings

To restore system settings to their default values, select **Default settings** by turning and pressing the central rotary knob. Confirm modification when prompted by pressing the knob again.

Modes of operation

Radio

To change the audio source to radio: Press the **RADIO**, **RADIO/CD** or **AUDIO/SOURCE** button.

Detailed description of the radio functions ⇨ 22.

Audio players

To change the audio source to **CD**, **USB**, **AUX**, Bluetooth or iPod (where applicable): Press the **MEDIA**, **RADIO/CD** or **AUDIO/SOURCE** button.

R15 BT

Detailed descriptions of:

- AUX input functions ⇨ 35
- USB port functions ⇨ 37
- Bluetooth music operation ⇨ 40

CD15 BT

Detailed descriptions of:

- CD player functions ⇨ 31
- AUX input functions ⇨ 35
- USB port functions ⇨ 37
- Bluetooth music operation ⇨ 40

CD30 BT

Detailed descriptions of:

- CD player functions ⇨ 31
- AUX input functions ⇨ 35
- USB port functions ⇨ 37
- Bluetooth music operation ⇨ 40

CD35 BT

Detailed descriptions of:

- CD player functions ⇨ 31
- AUX input functions ⇨ 35
- USB port functions ⇨ 37
- Bluetooth music operation ⇨ 40

Navigation system

CD30 BT, CD35 BT

Detailed description of the Navigation system ⇨ 46.

Phone

R15 BT / CD15 BT - Phone

To access the **Phone** menu: Press the  or **TEL** button.

To access the phone settings menu: Press the **TEL** button and select **Phone settings**.

CD30 BT - Phone

To access the **Phone** menu: Press the  or **TEL** button.

To access the phone settings menu: Press the  button and select **Phone settings**.

CD35 BT - Phone

To access the **Phone** menu: Press the  or TEL button.

To access the phone settings menu: Press the **SETUP / TEXT** button and select **Phone settings**.

Use the display options in these menus to connect mobile phones, make telephone calls, create contacts lists and adjust various settings.

Detailed description of the handsfree phone system functions ⇨ 65.

Tone settings

R15 BT / CD15 BT - Tone settings

In the audio settings menu, the tone characteristics can be set.

Press the **SETUP** button to access the settings menu.

Select **Audio settings** and turn the **OK** rotary knob until the desired setting is selected from:

- BASS (bass)
- TREBLE (treble)

- FADER (front/rear balance)
- BALANCE (left/right balance)

The display indicates the type of setting followed by the adjustment value.

Set the desired value by turning the **OK** rotary knob and press the knob to confirm selections.

To exit the audio settings menu, press the → button.

Notice

If there is no activity, the system will exit the audio settings menu automatically.

Setting bass and treble

Select **Bass** or **Treble**.

Set the desired value by turning the **OK** rotary knob and press the knob to confirm setting.

Setting the volume distribution between right - left

Select **Balance**.

Set the desired value by turning the **OK** rotary knob and press the knob to confirm setting.

Setting the volume distribution between front - rear

Select **Fader**.

Set the desired value by turning the **OK** rotary knob and press the knob to confirm setting.

CD30 BT - Tone settings

In the audio settings menu, the tone characteristics can be set.

To move around the menu and select the various headings, turn the rotary knob to move up/down and press button < or > to move left/right. Alternatively, press the rotary knob to move right only.

Press the  button to access the settings menu.

Select **Audio settings** and use < or > and/or the rotary knob until the desired setting is selected.

The display indicates the type of setting followed by the adjustment value.

A value of **0** means the function is deactivated.

To exit the settings menu, press .

Notice

If there is no activity, the system will exit the audio settings menu automatically.

Optimising the tone for the style of music

Select the **Musical atmosphere** menu.

Turn the rotary knob to select from:

- **Voice**
- **Classical**
- **Jazz**
- **Neutral**
- **Pop**
- **Rock**

The displayed options offer optimised bass, middle and treble settings for the relevant style of music.

Set the style of music by pressing the rotary knob.

Setting bass and treble

Select the **Musical atmosphere** menu.

Turn the rotary knob to select **Bass/treble**.

Press < or > to access **Bass** or **Treble**.

Set the desired value for the selected option by turning the rotary knob.

Optimising the sound distribution

Select the **Sound optimisation** menu.

To optimise the sound distribution for the entire vehicle or just the driver, turn the rotary knob to select from:

Vehicle or **Driver**.

Set by pressing the rotary knob.

Setting the volume distribution between right - left

Select the **Sound optimisation** or **Balance/fader** menu.

Turn the rotary knob to select **Balance**.

Press rotary knob or button < or > to display current setting and turn rotary knob to adjust.

Press rotary knob to set the desired value and display the **Fader** setting.

Setting the volume distribution between front - rear

The **Fader** setting is displayed after **Balance** has been set.

Turn the rotary knob to adjust the fader between front/rear.

Moderate volume in the front

To suppress the volume in the rear and moderate only the volume in the front of the vehicle:

Select the **Sound optimisation** menu.

Turn the rotary knob to select **Rear OFF** and press rotary knob to set.

Setting Loudness

Select the **Other audio settings** menu.

Select **Loudness** by pressing the rotary knob.

CD35 BT - Tone settings

In the audio settings menu, the tone characteristics can be set.

Press the **SETUP / TEXT** button to access the settings menu.

Select **Audio settings** and turn the central rotary knob until the desired setting is selected.

The display indicates the type of setting followed by the adjustment value.

A value of **0** means the function is deactivated.

To exit the settings menu, press **SETUP / TEXT** (or \rightarrow).

Notice

If there is no activity, the system will exit the audio settings menu automatically.

Optimising the tone for the style of music

Select the **Musical atmosphere** menu.

Turn the rotary knob to select from:

- **Pop/ Rock**
- **Classical**
- **Jazz**
- **Neutral**

The displayed options offer optimised bass, middle and treble settings for the relevant style of music.

Set the style of music by pressing the central rotary knob.

Setting bass and treble

Select the **Musical atmosphere** menu.

Turn the central rotary knob to select **Bass/treble** and press knob to confirm.

Turn the central rotary knob to access **Bass** or **Treble** and press knob to confirm.

Set the desired value for the selected option by turning the central rotary knob and press knob to confirm.

Optimising the sound distribution

Select the **Sound optimisation** menu.

To optimise the sound distribution for the entire vehicle or just the driver, turn the central rotary knob to select from: **Vehicle** or **Driver**.

Set by pressing the knob.

Setting the volume distribution between right - left

Select the **Sound optimisation** menu.

Turn the central rotary knob to select **Balance/fader**. Press knob to display current setting for **Balance** and turn knob to adjust.

Press knob to set the desired value and display the **Fader** setting.

Setting the volume distribution between front - rear

The **Fader** setting is displayed after **Balance** has been set.

Turn the central rotary knob to adjust the fader between front/rear.

Moderate volume in the front

To suppress the volume in the rear and moderate only the volume in the front of the vehicle:

Select the **Sound optimisation** menu.

Turn the central rotary knob to select **Rear OFF** and press knob to set.

Automatic Gain Control (AGC)

To switch on low volume sound enhancement:

Select the **AGC Activated** menu and press the central rotary knob to activate.

Restore default audio settings

Select **Default settings** and press the central rotary knob to confirm.

All the audio settings return to their default values.

Display software version

To display the software version, access the **Software version** menu and press the central rotary knob.

Volume settings

Speed dependent volume

When this feature is activated, the volume is adapted automatically to compensate for road and wind noise during driving.

CD30 BT - Volume settings

When this feature is activated, the volume is adapted automatically to compensate for road and wind noise during driving.

Press the **≡** button to access the **Audio settings** menu.

Select **Other audio settings** then **Adaptation volume km/h**.

Turn the rotary knob to set the degree of volume adaptation.

A value of **0** means the function is deactivated.

CD35 BT - Volume settings

When this feature is activated, the volume is adapted automatically to compensate for road and wind noise during driving.

Press the **SETUP / TEXT** button to access the settings menu. Select **Audio settings** followed by **Adaptation volume km/h** by turning the central rotary knob and pressing to confirm the selection.

Turn the knob to set the degree of volume adaptation.

A value of **0** means the function is deactivated.

Radio

| | |
|-------------------------------|----|
| Usage | 22 |
| Station search | 23 |
| Autostore lists | 26 |
| Radio data system (RDS) | 27 |

Usage

Radio reception

Radio reception may be disrupted by static, noise, distortion or loss of reception due to:

- changes in distance from the transmitter,
- multi-path reception due to reflection,
- shadowing.

Control buttons - R15 BT / CD15 BT

The most important buttons for control of the radio are:

- **RADIO**: Activate radio, change waveband
- **◀▶**: Station search
- **OK** rotary knob: Change frequency
- Station buttons 1...6: Preset station buttons
- **SETUP**: System settings, automatic station storing

Activating the radio

Press the **RADIO** button to switch the audio source to radio.

The station previously selected will be received.

Selecting the waveband

Press the **RADIO** button repeatedly to switch between the available wavebands (e.g. FM1, FM2, AM).

The station previously selected in that waveband will be received.

Control buttons - CD30 BT

The most important buttons for control of the radio are:

- **RADIO/CD**: Activate radio
- Central rotary knob: Change waveband and frequency
- **◀▶**: Change search mode (frequency, station name, stored station number)
- **◀▶**: Station search
- **MEM**: Access stored radio station list

- Station buttons 1...6: Preset station buttons
- **f#**: System settings

Activating the radio

Press the **RADIO/CD** button to switch the audio source to radio.

The station previously selected will be received.

Selecting the waveband

Press button **<** or **>** to highlight the waveband in the display menu then turn the rotary knob to select the desired waveband.

The station previously selected in that waveband will be received.

Control buttons - CD35 BT

The most important buttons for control of the radio are:

- **RADIO**: Activate radio, change waveband
- **◀ ▶**: Change frequency, station search
- Central rotary knob: Access stored radio station list

- Station buttons 1...6: Preset station buttons
- **SETUP / TEXT**: System settings

Activating the radio

Press the **RADIO** button to switch the audio source to radio.

The station previously selected will be received.

Selecting the waveband

Press the **RADIO** button repeatedly to switch between the available wavebands (e.g. FM1, FM2, MW, LW).

The station previously selected in that waveband will be received.

Station search

Automatic station search

R15 BT / CD15 BT - Automatic station search

Briefly press button **◀** or **▶** to search for the next receivable station in the current waveband.

If no station is found, automatic searching continues until **◀◀** or **▶▶** is pressed again.

CD30 BT - Automatic station search

Highlight the frequency in the display using button **<** or **>**.

Press button **◀◀** or **▶▶** to search for the next receivable station in the current waveband.

CD35 BT - Automatic station search

Press button **◀◀** or **▶▶** for approx. 2 seconds to search for the next receivable station in the current waveband.

If no station is found, automatic searching continues until **◀◀** or **▶▶** is pressed again.

Manual station search

Stored station search

This allows you to recall radio stations that you have previously stored.

To store a station, select the desired waveband and station then press station button 1...6 until an audible signal sounds, confirming that the

station has been stored to the appropriate station button. 6 stations per waveband can be stored.

Recalling a stored station

To recall a station, select the desired waveband then briefly press station button 1...6.

R15 BT / CD15 BT - Manual station search

Select the desired waveband then press and hold button ◀◀ or ▶▶ to scan the selected waveband.

Release the button when close to the required frequency. An automatic search is then made for the next receivable station and it is played automatically.

Turn the **OK** rotary knob to change the frequency in increments.

Stored station search

This allows you to recall radio stations that you have previously stored.

To store a station, select the desired waveband and station then press station button 1...6 until an audible signal sounds, confirming that the

station has been stored to the appropriate station button. 6 stations per waveband can be stored.

Recalling a stored station

To recall a station, select the desired waveband then briefly press station button 1...6.

Stored station search

This allows you to recall radio stations that you have previously stored.

To store a station, select the desired waveband and station then press the **MEM** button (to access the stored radio station list) and select a digit by pressing button 1 or 2. Confirm the selection by pressing the [OK]/OK button.

You can store up to 12 FM, 6 LW or 6 MW stations in this way.

Alternatively, press and hold station button 1...6 until an audible signal sounds, confirming that the station has been stored to the appropriate station button. 6 stations per waveband can be stored in this way.

Recalling a stored station

To recall a station, select the desired waveband then briefly press station button 1...6.

Alternatively, select the desired waveband then highlight the stored station number field in the display, using button ◀ or ▶. Press button 1 or 2 repeatedly to manually search the stored station list.

Search radio station name (FM only)

Select the FM waveband then highlight the station name in the display using button ◀ or ▶.

Press button 1 or 2 repeatedly to manually search for the required station name. The frequency may be displayed instead if the station name is unavailable.

The alphabetical list contains up to 60 FM radio stations with the best reception. This list can be updated at any time ⇨ 26.

CD30 BT - Manual station search

Select the desired waveband then highlight the frequency in the display using button ◀ or ▶.

Turn rotary knob or press and hold button ◀◀ or ▶▶ to scan the frequencies in the current waveband.

Release the button when the desired frequency has been reached. The station is played automatically.

Stored station search

This allows you to recall radio stations that you have previously stored.

To store a station, select the desired waveband and station then press the **MEM** button (to access the stored radio station list) and select a digit by turning and pressing the rotary knob.

You can store 12 stations in this way.

Alternatively, press and hold station button 1...6 until an audible signal sounds, confirming that the station has been stored to the appropriate station button. 6 stations per waveband can be stored in this way.

Recalling a stored station

To recall a station, select the desired waveband then briefly press station button 1...6.

Alternatively, select the desired waveband then highlight the stored station number field in the display, using button ◀ or ▶. Turn the rotary knob to manually search the stored station list.

Search radio station name (FM only)

Select the FM waveband then highlight the station name in the display using button ◀ or ▶.

Turn rotary knob to manually search for the required station name.

The alphabetical list contains up to 50 FM radio stations with the best reception. This list can be updated at any time ↻ 26.

CD35 BT - Manual station search

Select the desired waveband then press and hold button ◀◀ or ▶▶ to scan the selected waveband.

Release the button when close to the required frequency. An automatic search is then made for the next receivable station and it is played automatically.

Press button ◀◀ or ▶▶ briefly to change the frequency in increments.

Stored station search

This allows you to recall radio stations that you have previously stored.

To store a station, select the desired waveband and station then press station button 1...6 until an audible signal sounds, confirming that the station has been stored to the appropriate station button. 6 stations per waveband can be stored.

Recalling a stored station

To recall a station, select the desired waveband then briefly press station button 1...6.

Search radio station name (FM only)

Select the FM waveband and open the FM radio station list by turning the central rotary knob.

Turn the knob to manually search for the required station name and press the knob to select.

The alphabetical list contains up to 50 FM radio stations with the best reception. This list can be updated at any time ↷ 26.

Autostore lists

The stations with the best reception in a waveband can be searched for and stored automatically via the autostore function.

Automatic station storing

R15 BT / CD15 BT - Automatic station storing

The FM waveband has an autostore list (AST), on which 6 stations can be stored.

While listening to the radio, press and hold the **SETUP** button: The 6 stations with the strongest reception will be automatically stored on AST.

Notice

Due to signal strength, it is possible that less than 6 stations will be stored.

CD30 BT - Automatic station storing

Depending on vehicle, up to 50 radio stations are continually updated and stored automatically by the system.

CD35 BT - Automatic station storing

Depending on vehicle, up to 50 radio stations are continually updated and stored automatically by the system.

Recalling a station

R15 BT / CD15 BT - Recalling a station

Select the desired waveband, then briefly press station button 1...6 to recall a stored station.

To recall a station on the autostore list (AST), while listening to the radio briefly press the **SETUP** button to activate AST mode. The station previously selected will be received.

Briefly press station button 1...6 to recall another stored station on the autostore list.

CD30 BT - Recalling a station

Select the desired waveband, then briefly press station button 1...6 to recall a stored station.

Alternatively, select the desired waveband then highlight the stored station number field in the display, using button < or >. Turn the rotary knob to manually search the stored station list.

CD35 BT - Recalling a station

Select the desired waveband, then briefly press station button 1...6 to recall a stored station.

Alternatively, select the FM waveband and open the FM radio station list by turning the central rotary knob. Turn the knob to manually search for the required station name and press the knob to select.

Updating stations manually

Stations can also be stored manually in the autostore list¹⁾.

To update the list of stations and obtain the most recent ones, activate the system update manually. The sound will be muted during a manual update.

CD30 BT - Updating stations manually

Press the  button to access the **Radio functions** menu.

Turn the rotary knob to select **Update FM list** and press to confirm update.

CD35 BT - Updating stations manually

Press the **SETUP / TEXT** button and turn the central rotary knob to access **Radio functions**.

Turn the rotary knob to select **Update FM list** and press to confirm update.

Radio data system (RDS)

RDS is an FM station service that helps you find the desired station and ensures its fault-free reception.

Advantages of RDS

- The programme name of the chosen station appears on the display screen instead of its frequency.
- During an automatic station search, the Infotainment system tunes into RDS stations only.
- The Infotainment system always tunes into the best receivable broadcasting frequency of the chosen station, by means of AF (Alternative Frequency).

R15 BT / CD15 BT - RDS functions

Configuring RDS

Press the **SETUP** button and turn the **OK** rotary knob to access the **RDS** menu. Press knob to select.

Turn the rotary knob to select **RDS SETUP**.

Switching RDS on and off

Switch on/off **RDS-AF** by pressing the **OK** rotary knob. **AF** is shown on the display screen when RDS is active.

Text information (Radio text)

Certain FM radio stations issue text information relating to the broadcast program (e.g. song name).

Press the **SETUP** button and turn the **OK** rotary knob to access the **Radio texts** menu.

Turn the rotary knob to select **Radio** and press the knob to see this information.

CD30 BT - RDS functions

Configuring RDS

With the radio on, press the **RADIO/CD** button to access the **Radio functions** menu.

Switching RDS on and off

1) Not with R15 BT / CD15 BT

Switch on/off **RDS-AF** and press the rotary knob to confirm. **RDS-AF** will appear on the display screen when switched on.

I Traffic service (Traffic information)

Radio traffic service stations are FM RDS stations that broadcast traffic news.

Switching the I Traffic service on and off

To switch the traffic announcement on and off:

With the radio on, press the **RADIO/CD** button to access the **Radio functions** menu.

Switch on/off **i Traffic** and press the rotary knob to confirm.

- If the radio traffic service is switched on, **i Traffic** is displayed in the radio main menu.
- Only radio traffic service stations are received.

- If the radio traffic service is switched on, CD/MP3 playback is interrupted for the duration of the traffic announcement.
- Traffic announcements will not be broadcast automatically when the LW or MW waveband is selected. Change the audio source or waveband to FM to ensure traffic announcements are broadcast automatically.

Blocking out traffic announcements

To block out a traffic announcement e.g. during CD/MP3 playback: Press the rotary knob.

The traffic announcement is interrupted, but the radio traffic service remains switched on.

Program type search (PTY)

Press the **RADIO/CD** button to access the **Radio functions** menu.

Press < or > to access the waveband.

Turn the rotary knob to select PTY.

Press rotary knob or button < or > to display the list of program types.

Select a program from the following options:

- **News**
- **Pop music**
- **Sport**
- **Serious classics**
- **Varied speech**

Select a station from the list.

The system automatically suggests a program that corresponds to the initial selection.

Text information (Radio text)

Certain FM radio stations issue text information relating to the broadcast program (e.g. song name).

Briefly press the  button to see this information.

Press  again or change the source to return to the original display screen.

CD35 BT - RDS functions

Configuring RDS

Press the **SETUP / TEXT** button and turn the central rotary knob to access the **Radio functions** menu. Press knob to select.

Turn the rotary knob to select **RDS-AF**.

Switching RDS on and off

Switch on/off **RDS-AF** by pressing the central rotary knob.

I Traffic service (Traffic information)

Radio traffic service stations are FM RDS stations that broadcast traffic news.

Switching the I Traffic service on and off

To switch the traffic announcement on and off:

Press the **SETUP / TEXT** button and turn the central rotary knob to access the **Radio functions** menu. Press knob to select.

Turn the rotary knob to select **i Traffic** and switch on/off by pressing the knob.

- If the radio traffic service is switched on, CD/MP3 playback is interrupted for the duration of the traffic announcement.
- Traffic announcements will not be broadcast automatically when the LW or MW waveband is selected. Change the audio source or waveband to FM to ensure traffic announcements are broadcast automatically.

Blocking out traffic announcements

To block out a traffic announcement e.g. during CD/MP3 playback: Press the central rotary knob (or the **→** button).

The traffic announcement is interrupted, but the radio traffic service remains switched on.

Text information (Radio text)

Certain FM radio stations issue text information relating to the broadcast program (e.g. song name).

Press and hold the **SETUP / TEXT** button to see this information.

Press the **→** button or wait for 30 seconds to return to the original display screen.

CD Player

| | |
|---------------------------|----|
| General information | 30 |
| Usage | 31 |

General information

The Infotainment system's CD player can playback audio CDs, MP3 CDs and also WMA CDs.

CD15 BT, CD 30 BT only: AAC and WAV formats can also be played.

Important information about audio CDs and MP3/WMA CDs

Caution

Under no circumstances place DVDs, single-CDs with a diameter of 8 cm or shaped CDs in the audio player.

You must not put any stickers on CDs. These discs can get jammed in the CD drive and ruin the drive. An expensive replacement of the device will then be necessary.

- Audio CDs with copy protection, which are not in compliance with the audio CD standard, may not play correctly or not at all.

- Self-recorded CD-Rs and CD-RWs and WMA files with Digital Rights Management (DRM) from online music shops may not play correctly or not at all.
- On mixed mode CDs (combinations of audio and data, e.g. MP3), only the audio tracks will be detected and played.
- Self-recorded CD-Rs and CD-RWs are more vulnerable to mishandling than prerecorded CDs. Correct handling, especially in the case of self-recorded CD-Rs and CD-RWs, must be ensured; see below.
- Avoid leaving fingerprints when you change CDs.
- Put CDs back in their sleeves immediately after removing them from the CD player, in order to protect them from dirt and damage.
- Dirt and liquids on CDs can smear the lens of the audio player inside the device and cause faults.
- Protect CDs from heat and direct sunlight.

- The following restrictions apply for MP3/WMA CDs:
 - Only MP3 files and WMA files can be read.
 - Maximum folder structure depth: 11 levels
 - Maximum number of MP3 and/or WMA files that can be saved: 1000 files
 - Applicable playlist extensions: .m3u, .pls
 - Playlist entries must be in the form of relative paths.
- The operation of MP3 and WMA files is identical. When a CD with WMA files is loaded, MP3-related menus are displayed.

Usage

CD15 BT - CD player usage

Starting CD playback

Switch on the Infotainment system (by pressing the \odot knob) and push the CD with the printed side up into the CD slot until it is pulled in: CD playback starts automatically.

If there is already a CD in the unit, press the **MEDIA** button repeatedly to select the desired audio source: CD playback is started.

Notice

Depending on the data stored on the audio CD or MP3 CD, differing information about the CD and the current music track will be shown on the display.

Selecting an album or track

Turn the **OK** rotary knob to select an album or track from the list.

Skipping to the next track or previous track

Briefly press button \lll or \ggg once or several times.

Fast forward or rewind

Press and hold button \lll or \ggg to fast forward or rewind the current track.

Random playback

During CD playback, press and hold the numbered button 4 (from the Station buttons 1...6) to activate random playback.

MIX appears on the display when random playback is active.

Notice

On an MP3 CD, the random playback function applies only to the current album.

Press and hold the numbered button 4 again to deactivate.

MIX disappears from the display.

Random playback can also be deactivated by ejecting the CD.

Notice

Random playback is not deactivated when the audio system is switched off or the source changed.

Pause

Briefly press the \odot rotary knob, \times or both \blacktriangleleft and \blacktriangleright buttons simultaneously to interrupt CD/MP3 CD playback. Press again to resume playback.

The pause function is deactivated automatically when the volume is adjusted, the audio source is changed or automatic information messages are issued.

Displaying additional text information (CD-Text or ID3 tag)

After selecting a track or album, briefly press numbered button **5** (from the Station buttons 1...6) to access the text information available on the CD (e.g. artist name, album name or song name).

To display all text information at once, press and hold numbered button **5**.

To exit the display, press the \rightarrow button.

Removing a CD

Press the \triangle button: The CD is pushed out of the CD slot.

If the CD is not removed after ejection, it will be drawn back in again automatically after a few seconds.

CD30 BT - CD player usage**Starting CD playback**

Switch on the Infotainment system (by pressing the \odot knob) and push the CD with the printed side up into the CD slot until it is pulled in: CD playback starts automatically.

If there is already a CD in the unit, press the **RADIO/CD** button: CD playback is started.

Notice

Depending on the data stored on the audio CD or MP3 CD, differing information about the CD and the current music track will be shown on the display.

Selecting an album or track

Turn the rotary knob to select an album or track from the list.

Skipping to the next track or previous track

Briefly press button $\blacktriangleleft\blacktriangleleft$ or $\blacktriangleright\blacktriangleright$ once or several times.

Fast forward or rewind

Press and hold button $\blacktriangleleft\blacktriangleleft$ or $\blacktriangleright\blacktriangleright$ to fast forward or rewind the current track.

Random playback

Access the **Other audio settings** menu.

Select **Random** and press the rotary knob to activate.

Notice

On a CD MP3/WMA, the random playback function applies to the current album, then moves on to the next album.

Pause

Press the \times button or both \blacktriangleleft and \blacktriangleright buttons simultaneously to interrupt CD/MP3 CD playback.

This function is deactivated automatically when the volume is adjusted, the source is changed or automatic information messages are issued.

Selecting tracks using the audio CD or MP3 menu

During audio CD playback

To select a track on the audio CD: Turn the rotary knob to select the desired track.

During MP3 playback

Press the ▷ button to access the subfolder or track.

Press the ◀ button to return to the parent folder.

Press and hold the ◀ button to return to the root folder.

Press and hold the ▷ button to display the name of the track being played.

Once an album is selected:

- Press rotary knob to display the track list.
- Turn rotary knob to select the desired track.

Displaying additional text information (CD-Text or ID3 tag)

After selecting a track or album, press the [] button to access the text information available on the CD (e.g. artist name, album name or song name). To exit the corresponding display, press [] again.

Press the [] button to display the full name of the album or track playing. To exit the display, press [] again.

Removing a CD

Press the △ button: The CD is pushed out of the CD slot.

If the CD is not removed after ejection, it will be drawn back in again automatically after a few seconds.

CD35 BT - CD player usage

Starting CD playback

Switch on the Infotainment system (by pressing the Ⓞ knob) and push the CD with the printed side up into the CD slot until it is pulled in: CD playback starts automatically.

If there is already a CD in the unit, press the **MEDIA** button repeatedly to select the desired audio source: CD playback is started.

Notice

Depending on the data stored on the audio CD or MP3 CD, differing information about the CD and the current music track will be shown on the display.

Selecting an album or track

Turn the central rotary knob to select an album or track from the list.

Skipping to the next track or previous track

Briefly press button ◀◀ or ▶▶ once or several times.

Fast forward or rewind

Press and hold button ◀◀ or ▶▶ to fast forward or rewind the current track.

Random playback

Press the **SETUP / TEXT** button to access the settings menu.

Turn the central rotary knob to select **Audio settings** and press knob to confirm.

Select **Random** and press the knob to activate.

Notice

On a CD MP3/WMA, the random playback function applies to the current album, then moves on to the next album.

Pause

Briefly press the volume rotary knob, \otimes or both \leftarrow and \rightarrow buttons simultaneously to interrupt CD/MP3 CD playback. Press again to resume playback.

The pause function is deactivated automatically when the volume is adjusted, the audio source is changed or automatic information messages are issued.

Displaying additional text information (CD-Text or ID3 tag)

After selecting a track or album, press and hold the central rotary knob to access the text information available on the CD (e.g. artist name, album name or song name).

To exit the display, press the \rightarrow button.

Removing a CD

Press the \triangle button: The CD is pushed out of the CD slot.

If the CD is not removed after ejection, it will be drawn back in again automatically after a few seconds.

AUX input

| | |
|---------------------------|----|
| General information | 35 |
| Usage | 35 |

General information

CD30 BT

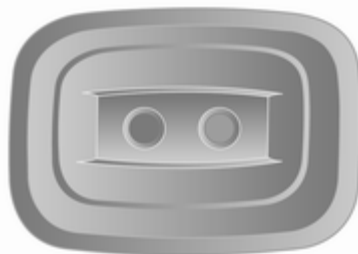

An AUX socket is available for the connection of external audio sources.

Notice

The socket must always be kept clean and dry.

It is possible, for example, to connect a portable CD player with RCA connectors or a 3.5 mm jack plug to the AUX input.

R15 BT / CD15 BT, CD35 BT

In the Infotainment unit, there is an AUX socket for the connection of external audio sources.

Notice

The socket must always be kept clean and dry.

It is possible, for example, to connect a portable CD player with a 3.5 mm jack plug to the AUX input.

Usage

An audio source that is connected to the AUX input can only be operated via the controls on the audio source, i.e. not via the Infotainment system. Only select a track directly on the audio source when the vehicle is stationary.

Caution

Before connecting or disconnecting an auxiliary device, e.g. a portable CD player, switch off the player and the Infotainment

system, to avoid sound quality issues and possible damage to the equipment.

Upon connection via the jack plug, the system detects the audio source automatically. Depending on the recording volume, there may be a delay before the audio source is heard.

The artist or track name are not shown on the display screen.

R15 BT / CD15 BT - AUX input usage

Press the **MEDIA** button to change the audio source to AUX mode, then switch on the auxiliary device. AUX appears on the display screen.

AUX settings

Press the **SETUP** button to access the settings menu.

Select AUX IN and turn the **OK** rotary knob until the desired setting is selected from:

- HI (300 mV)
- MID (600 mV)
- LO (1200 mV)

CD30 BT - AUX input usage

Press the **RADIO/CD** button to activate the AUX mode, then switch on the auxiliary device.

CD35 BT - AUX input usage

Press the **MEDIA** button to activate the AUX mode, then switch on the auxiliary device. Jack appears on the display screen.

USB port

| | |
|---------------------------------|----|
| General information | 37 |
| Playing saved audio files | 38 |

General information

R15 BT / CD15 BT, CD35 BT

In the Infotainment unit, there is a USB socket for the connection of external audio sources.

CD30 BT



A USB socket is available for the connection of external audio sources.

Notice

The socket must always be kept clean and dry.

An MP3 player, USB drive or an iPod can be connected to the USB port.

These devices are operated via the controls and menus of the Infotainment system.

Important information

MP3 player and USB drives

- The MP3 players and USB drives connected must comply with the USB Mass Storage Class specification (USB MSC).
- Only MP3 players and USB drives with a sector size of 512 Bytes and a cluster size smaller or equal to 32 kBytes in the FAT32 file system are supported.
- Hard disk drives (HDD) are not supported.
- The following restrictions apply for the data stored on an MP3 Player or USB device:

Only MP3 files, WMA, ACC¹⁾ and OGG²⁾ files can be read. WAV files

1) Not with CD30 BT.

2) CD30 BT only.

and all other compressed files cannot be played

Maximum folder structure depth: 11 levels

Maximum number of files that can be saved: 1000 files

WMA files with Digital Rights Management (DRM) from online music shops may not play correctly or not at all

Applicable playlist extensions: .m3u, .pls

Playlist entries must be in the form of relative paths

Playing saved audio files

Depending on the auxiliary device connected, select a folder (MP3 player, USB drive) or a playlist (portable digital music player).

Once connected, it is only possible to use the controls and menus of the Infotainment system to operate the auxiliary device.

The operation of data sources connected via USB is generally the same as for an audio/MP3/WMA CD ↷ 31.

R15 BT / CD15 BT - Playing music via USB

MP3 player / iPod / USB drives

The system detects the auxiliary device when a USB device is connected and the current track is displayed automatically.

When a new auxiliary device is connected, the first track in the first folder is played automatically. When reconnecting the device, the previously played track is resumed.

Selecting a track

To select tracks directly (and change folders), first access the auxiliary device menu structure by pressing the OK rotary knob during playback. Select tracks and change folders by turning and pressing the knob.

CD30 BT - Playing music via USB

MP3 player / iPod / USB drives

The system detects the auxiliary device when a USB device is connected and the **AUX-USB** menu is displayed automatically.

Selecting a track

Select tracks directly by turning and pressing the central rotary knob.

By default, albums are listed in alphabetical order.

If a USB drive is connected, all the folders will be at the same level on the tree structure.

Depending on the auxiliary device connected, you may refine your selection by folders and files, or by a criteria search from the following:

- Artists
- Albums
- Genres
- Playlists
- Songs

CD35 BT - Playing music via USB

MP3 player / iPod / USB drives

The system detects the auxiliary device when a USB device is connected and the first track in the first folder is played automatically. When reconnecting the device, the previously played track is resumed.

Selecting a track

To select tracks directly (and change folders), first access the auxiliary device menu structure by pressing the central rotary knob during playback (with iPod, turn the knob to access menu). Select tracks and change folders by turning and pressing the knob.

Disconnecting from USB socket

Playback is stopped immediately when the auxiliary device is withdrawn from the USB socket.

Bluetooth music

| | |
|---------------------------|----|
| General information | 40 |
| Operation | 40 |

General information

Bluetooth-enabled auxiliary audio sources (e.g. music mobile phones, MP3 players etc.), which support Bluetooth music protocol A2DP, can be connected wirelessly to the Infotainment system.

Important information

- The Infotainment system only connects to Bluetooth devices that support A2DP (Advanced Audio Distribution Profile). Connection issues may arise with early versions.
- The Bluetooth device must support AVRCP (Audio Video Remote Control Profile) version 1.0 or higher. If the device does not support AVRCP, only the volume can be controlled via the Infotainment system.
- Before connecting the Bluetooth device to the Infotainment system, become acquainted with its operating instructions for Bluetooth functions.

Operation

Prerequisites

The following prerequisites must be met, in order to control a Bluetooth-enabled audio device via the Infotainment system:

- The Bluetooth function of the Infotainment system must be activated ⇨ 70.
- The Bluetooth function of the Bluetooth-enabled auxiliary audio source must be activated (see audio device operating instructions).
- Dependent upon the audio source, it may be required to set that device to "visible" (see audio device operating instructions).
- The audio source must be paired and connected to the Infotainment system.

R15 BT / CD15 BT - Playing music via Bluetooth

Bluetooth connection

A connection must be set up between the audio device and the Infotainment system via Bluetooth, i.e. the device must be paired to the vehicle before using it.

- A maximum of 5 audio devices can be paired and saved in the device list, but only one can be connected at a time.
- If the device has both audio player and telephone functions, both functions will be paired. Pairing a mobile phone ⇨ 70.
- Phone functions will remain active while the audio player is in use, and audio playback will be suspended during phone use.

Pairing an auxiliary audio device to the Infotainment system

To pair the audio device, press the **TEL** button and select **Pair device** by turning and pressing the **OK** rotary knob. The **Ready to Pair** screen is displayed.

Then, on the audio device, search for Bluetooth equipment in the vicinity of the device.

Select **My Radio** (i.e. the name of the system) from the list on the audio device, then, if applicable, on the audio device keypad enter the pairing code shown on the Infotainment system display screen.

Notice

If the audio device does not have a screen, enter the default pairing code on the device, then on the Infotainment system. Refer to the operating instructions for this default audio device pairing code, usually **0000**. Depending on the device, the pairing code may need to be entered in reverse order, i.e. on the Infotainment system first.

If pairing fails, the system returns to the previous menu and a corresponding message is displayed. Repeat procedure if necessary.

When pairing is completed, a confirmation message followed by the name of the paired audio device is shown on the Infotainment system display screen.

Notice

When a Bluetooth connection is active, controlling the audio device via the Infotainment system will discharge the audio device battery more rapidly.

Connecting an audio device

Audio devices are automatically connected to the Infotainment system after the pairing procedure is completed.

To connect any audio device that has been paired, or to connect to a different paired audio device than the current one, press the **TEL** button and select the **Select Device** menu. The device list shows the audio devices already paired.

Select the desired device from the list and confirm by pressing the **OK** rotary knob. A display message confirms connection.

Disconnecting an audio device

To disconnect an audio device from the Infotainment system, press the **TEL** button (or the **SETUP** button) and select **Bluetooth connection**. Select the desired device from the device list then select **Disconnect the device** by turning and pressing the **OK** rotary knob. A display message confirms disconnection.

Switching off the audio device or deactivating the Bluetooth function on the audio device also disconnects the device from the Infotainment system.

Unpairing an auxiliary audio device from the Infotainment system

If the list of paired audio devices is full, a new device can only be paired if an existing device is unpaired.

To unpair, i.e. to delete an audio device from the system memory, press the **TEL** button and select **Delete device**. Select the desired

audio device from the list and press the **OK** rotary knob to confirm deletion when prompted.

Operation via Infotainment system

When paired and connected wirelessly, audio playback begins automatically.

The audio device can then be operated via the Infotainment system function buttons, rotary knobs and display menus.

The range of accessible functions that can be operated via the Infotainment system depends on the type of audio player.

The operation of the audio device when connected wirelessly is similar to the operations for the CD player ⇨ 31.

CD30 BT - Playing music via Bluetooth

Bluetooth connection

A connection must be set up between the audio device and the Infotainment system via Bluetooth, i.e. the device must be paired to the vehicle before using it.

- A maximum of 5 audio devices can be paired and saved in the device list, but only one can be connected at a time.
- If the device has both audio player and telephone functions, both functions will be paired. Pairing a mobile phone ⇨ 70.
- Phone functions will remain active while the audio player is in use, and audio playback will be suspended during phone use.

Pairing an auxiliary audio device to the Infotainment system

To pair the audio device, press the **TEL** button and select **Bluetooth connection**. Select an empty slot by

turning the rotary knob and press rotary knob or button < or > to display the next menu.

Select **Pair audio device** by turning and pressing the rotary knob, then, on the audio device, search for Bluetooth equipment in the vicinity of the device.

Select **My Radiosat** (i.e. the name of the system) from the list on the audio device, then, if applicable, on the audio device keypad enter the pairing code shown on the Infotainment system display screen.

Notice

If the audio device does not have a screen, enter the default pairing code on the device, then on the Infotainment system. Refer to the operating instructions for this default audio device pairing code, usually **0000**. Depending on the device, the pairing code may need to be entered in reverse order, i.e. on the Infotainment system first.

If pairing fails, the message **Connection has failed.** is displayed and a tone sounds. Repeat procedure if necessary.

When pairing is completed, a confirmation message followed by the name of the paired audio device is shown on the Infotainment system display screen.

Notice

When a Bluetooth connection is active, controlling the audio device via the Infotainment system will discharge the audio device battery more rapidly.

Connecting an audio device

To connect an audio device after it has been paired, or to connect to a different paired audio device than the current one, press the \mathbb{F} button and select **Bluetooth connection**.

The device list shows the audio devices already paired. Select the desired device from the list. Select **Connect the device** and confirm by pressing the rotary knob. A display message confirms connection.

Disconnecting an audio device

To disconnect an audio device from the Infotainment system, select the desired device from the **Bluetooth**

connection menu then select **Disconnect the device** by turning and pressing the rotary knob. A display message confirms disconnection.

Switching off the audio device or deactivating the Bluetooth function on the audio device also disconnects the device from the Infotainment system.

Unpairing an auxiliary audio device from the Infotainment system

If the list of paired audio devices is full, a new device can only be paired if an existing device is unpaired.

To unpair, i.e. to delete an audio device from the system memory, press the \mathbb{F} button and select **Bluetooth connection**. Select the desired audio device from the list, press the rotary knob or button < or > and select **Delete this device**.

Operation via Infotainment system

When paired and connected wirelessly, audio playback begins automatically.

The audio device can then be operated via the Infotainment system function buttons, rotary knobs and display menus.

The range of accessible functions that can be operated via the Infotainment system depends on the type of audio player.

The operation of the audio device when connected wirelessly is similar to the operations for the CD player ↷ 31.

CD35 BT - Playing music via Bluetooth

Bluetooth connection

A connection must be set up between the audio device and the Infotainment system via Bluetooth, i.e. the device must be paired to the vehicle before using it.

- A maximum of 5 audio devices can be paired and saved in the device list, but only one can be connected at a time.

- If the device has both audio player and telephone functions, one or both functions can be paired. Pairing a mobile phone ↷ 70.
- Phone functions will remain active while the audio player is in use, and audio playback will be suspended during phone use.

Pairing an auxiliary audio device to the Infotainment system

To pair the audio device, press the **SETUP / TEXT** button and select **Bluetooth connection**. Select an empty slot by turning the central rotary knob and press the knob to display the next menu.

Select **Pair device** by turning and pressing the rotary knob, then, on the audio device, search for Bluetooth equipment in the vicinity of the device.

Select **My_Radio** (i.e. the name of the system) from the list on the audio device, then, if applicable, on the audio device keypad enter the pairing code shown on the Infotainment system display screen.

Notice

If the audio device does not have a screen, enter the default pairing code on the device, then on the Infotainment system. Refer to the operating instructions for this default audio device pairing code, usually **0000**. Depending on the device, the pairing code may need to be entered in reverse order, i.e. on the Infotainment system first.

If pairing fails, the message **Pairing failed** is displayed. Repeat procedure if necessary.

When pairing is completed, a confirmation message followed by the name of the paired audio device is shown on the Infotainment system display screen.

Notice

When a Bluetooth connection is active, controlling the audio device via the Infotainment system will discharge the audio device battery more rapidly.

Connecting an audio device

Audio devices are automatically connected to the Infotainment system after the pairing procedure is completed.

To connect any audio device that has been paired, or to connect to a different paired audio device than the current one, press the **SETUP / TEXT** button and select **Bluetooth connection** (or press the **TEL** button when no device is connected). The device list shows the audio devices already paired.

Select the desired device from the list and confirm by pressing the central rotary knob. A display message confirms connection.

Disconnecting an audio device

To disconnect an audio device from the Infotainment system, select the desired device from the **Bluetooth connection** menu then select **Disconnect the device** by turning and pressing the central rotary knob. A display message confirms disconnection.

Switching off the audio device or deactivating the Bluetooth function on the audio device also disconnects the device from the Infotainment system.

Unpairing an auxiliary audio device from the Infotainment system

If the list of paired audio devices is full, a new device can only be paired if an existing device is unpaired.

To unpair, i.e. to delete an audio device from the system memory, press the **SETUP / TEXT** button and select **Bluetooth connection**. Select the desired audio device from the list, press the central rotary knob and select **Delete**.

Operation via Infotainment system

When paired and connected wirelessly, audio playback begins automatically.

The audio device can then be operated via the Infotainment system function buttons, rotary knobs and display menus.

The range of accessible functions that can be operated via the Infotainment system depends on the type of audio player.

The operation of the audio device when connected wirelessly is similar to the operations for the CD player
⇨ 31.

Navigation

| | |
|---------------------------|----|
| General information | 46 |
| Usage | 49 |
| Destination input | 55 |
| Guidance | 58 |
| Symbols overview | 62 |

General information

Warning

The navigation system is an aid to your navigational abilities and does not replace them. Drive with due care and attention and adopt a safe, vigilant attitude.

If a navigation system instruction contradicts traffic regulations, the traffic regulations always apply.

The Navigation system will reliably guide you to your chosen destination without the need for physical road maps.

If the **Traffic info** service is available in your country or region, the current traffic situation is also considered in route calculations. The system receives traffic messages in the current reception area.

To receive the most up-to-date, real-time traffic information possible, subscribe to the Live services facility via the **TomTom™** website.

Functioning of the Navigation system

The position and movement of the vehicle are detected by the Navigation system using sensors.

The distance travelled is determined by the vehicle's speedometer signal, and turning movements on bends are determined by a gyro sensor. The position is determined by GPS (Global Positioning System) satellites.

By comparing these sensor signals with the digital maps on the Navigation system SD card, it is possible to accurately determine the position of the vehicle.

When using the vehicle for the first time, or after a ferry trip, etc., the system will self-calibrate. It is, therefore, normal if it does not provide an exact location until the vehicle has travelled for some distance.

After the entry of the destination address or point of interest (nearest petrol station, hotel, etc.) the route is calculated from the current location to the selected destination.

Route guidance is provided by voice output and the display screen.

Warning

Areas such as one-way streets and pedestrian zones are not marked on the navigation system map. In such areas, the system may issue a warning that must be accepted. Therefore, pay particular attention to one-way streets and other roads and entrances that must not be driven into.

SD card

An SD card is supplied with the Navigation system and contains, among other things, a digital map of the towns and roads in your country. After delivery of a new vehicle, there is a maximum of 60 days in which to update the digital map for free. After this time has elapsed, a fee is charged for map updates.

TomTom HOME™ software installation

To update the digital maps and to benefit from exclusive downloadable services, including real-time safety and traffic alerts, an account must be created on the TomTom™ website and the free **TomTom HOME™** software must be installed.

Creating an account

Create your TomTom™ internet account via the TomTom™ website. Select e.g., the **Create account** option on the web page and enter the appropriate details.

Installing the software



Insert the SD card in your computer's card reader (or an external card reader) while connected to the Internet. The software installation is launched automatically.

Follow the on-screen instructions to install the free TomTom HOME™ software.

Your SD card is automatically recognised by the system after the initial set-up.

Updating the SD card and Navigation system

Updates are issued regularly, e.g. for map and safety camera revisions.

These updates are only available via the **TomTom HOME** software, which is accessed via the SD card.

Using the **TomTom HOME** software, it is possible to:

- Update the Navigation system (maps, safety cameras etc.),
- Subscribe to LIVE services,
- Save the system data onto your computer,
- Add or delete data,
- Customise the system,
- Share map corrections with the community (**Map Share™**),
- Download the full TomTom™ Navigation system user manual.

The **TomTom HOME** software menus guide you through these operations.

System update

To get the best from the Navigation system, update it as often as possible. **Map Share™** map updates, for example, can be shared with the entire community of system users.

Main functions of TomTom HOME application

Download new and extra maps

Select the **Add Maps** icon to access the menu where maps can be downloaded.

Downloading voices, points of interest, etc.

Select the Add Traffic, Voices, Safety Cameras, etc. icon to:

- download voices to customise the system,
- download points of interest, etc.

Notice

In certain countries it is illegal to download and activate the camera warning option and this could lead to prosecution.

Save the SD card and system data

System data can be saved on your computer and also restored, if necessary.

It is recommended that the system data is saved on a regular basis. Saving the data allows it to be recovered if, for example, the SD card is lost or damaged.

Download instructions

It is possible to access to the full TomTom™ Navigation system user manual for the system.

Customise the system

It is also possible to customise the system by installing new points of interest and synthesised voices and by changing the colour scheme.

Usage

Remote control

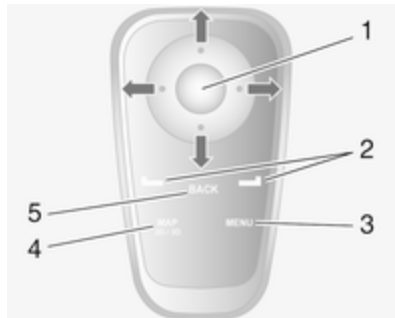

1. Central button: Confirm, access the quick menu

Press up, down, right, left: Move around menu or map

Press up/down: Adjust the map scale (zoom in/out)

Press right: Access traffic information

2. Soft buttons (↵ and ↩)

From menu: Select and confirm actions

From map: Left button (↵) - repeats a voice instruction; Right button (↩) - displays route summary

3. **MENU**: Access the main menu

4. **MAP 2D/3D**

From menu: Displays map

From map: Switches map to 2D/3D mode

5. **BACK**: Back to previous screen



The soft buttons (↵ and ↩) select or confirm actions which appear at the bottom of the screen.

The LED on the remote control flashes once when the remote control is connected to the Navigation system. To connect it more quickly, press one of the remote control buttons when the system starts, before the legal notices appear.

If the LED flashes and a message appears on the screen, the batteries require replacing.

Battery replacement

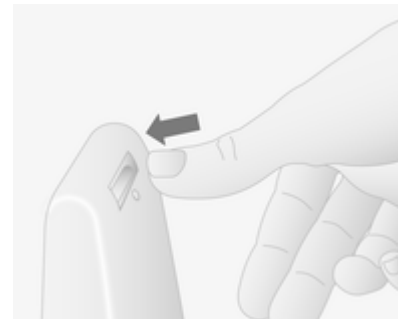



Press down latch on the back of the unit and lift out the keypad.

Insert new batteries (Type: AAA / LR03 / UM4 1.5V) ensuring they are installed correctly, then replace the battery cover.

Activating the Navigation system

Switching on

The Navigation system switches on automatically when the ignition is switched on. In other cases, press the  knob.

With the ignition off, the Navigation system can be used for approx. 20 minutes. Press the  knob to switch on the Navigation system. The system will automatically switch off approx. 20 minutes after the last user input.

Switching off

With the ignition off, the Navigation system switches off automatically when the driver's door is opened.

With the ignition on, press the  knob to switch off the Navigation system.

Switching between Navigation system and Infotainment system menus

With the Infotainment and Navigation systems on, press the **NAVI** button (on the steering column controls) to switch between the Navigation system and Infotainment system screens.

When the Infotainment controls are used to change, for example, the audio source, the Infotainment system screen pops-up temporarily over the Navigation system screen. The display switches back after a delay.

Clock

The clock is displayed when switched to the Infotainment system screen.

Inserting the SD card

Switch off the Navigation system and insert the SD card in its slot. The SD card is fragile; do not bend it.

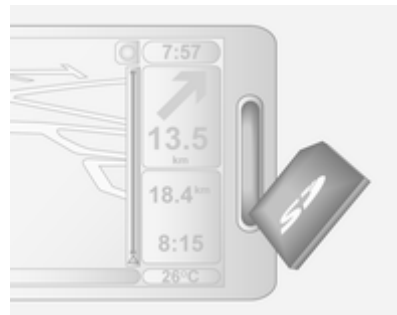

Insert it the right way round, as shown in the illustration.

Removing the SD card

Select **Remove SD card** in the main menu, then confirm using the right soft button . A message is displayed when it is safe to remove the SD card.

To remove the SD card from its slot, press on the card then release it. The card is released slightly to enable it to be withdrawn.

Only use an SD card which is compatible with the system.

Information on the display

Menu screen

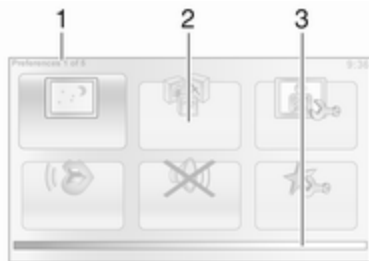

The menu screen contains the following:

1. Menu name
2. Sub-menu selection
3. Menu page scroll bar

To access the main menu, press the **MENU** button.

Menus may contain multiple screen pages. The scroll bar indicates the current position.

Quick menu

The **Quick menu** contains a preset selection of some commonly used menu items (e.g. hide map, cancel route, report safety cameras, etc.).

To access the Quick menu, press the central button on the remote control.

Map screen



The map screen contains the following:

1. Warning of the next risk area within distance (fixed or mobile speed camera, school, etc.)
2. Speed limit. Illuminates red and flashes if speed limit is exceeded
3. Name of the next major road or road sign information, if applicable
4. Traffic sidebar: Display of incidents on the route, traffic info reception indicator
5. Current time
6. Direction and distance to next change of direction
7. Exterior temperature (depending on vehicle)
8. Journey information, e.g. estimated arrival time, total remaining distance
9. Current location
10. Audio system information
11. Compass

To access the map screen at any time, press the **MAP 2D/3D** button.

Ensure any changes made are confirmed with the soft buttons (⏪ and ⏩) before switching to the map screen, otherwise the changes will be lost.

In the map screen, press the **MAP 2D/3D** button again to switch between 2D/3D map modes.

Guided tours

The system offers tutorials to enable quick familiarisation with the different functions.

Select **Guided tours** in the main menu, then the required tour:

- **Remote control operation**
- **Driving view**
- **Menu options**
- **Browse map**
- **Route planning**
- **Itinerary planning**
- **Traffic information**
- **Warnings and notifications**

- **Quick menu**
- **TomTom HOME**

LIVE services

Live services includes road safety alerts, up-to-date traffic information with HD Traffic™, local search with Google™ and a weather forecast.

These features are available for a free 3 month trial period, after which a subscription is required. Visit the TomTom website and refer to the **Services** section to subscribe to **LIVE services**.

Live services are not available in some countries or regions.

To check the status of your subscription at any time, select **My Services** in the **LIVE services** menu. Some features will not be available for selection in the main menu until a subscription to live services has been set up. To access these features, select **LIVE services** from the Navigation system main menu.

Safety alerts

This service includes the location of mobile speed cameras in real-time, accident blackspots and fixed speed cameras.

The latest fixed camera updates can be downloaded via TomTom HOME™.

This service can be activated or deactivated at any time via **Safety Alerts** in the **LIVE services** menu.

HD Traffic™

To only receive up-to-date, real-time traffic information and to plan the best route to your destination, select **HD Traffic**¹⁾ in the **LIVE services** menu.

Google™ local search

This service allows you to use a keyword to quickly find any point of interest and set it as a destination.

Weather

The weather forecast service provides up to 5 days of weather reports for your current location and your chosen destination.

1) The **HD Traffic** service is named **Traffic** if a subscription has not been activated.

Image viewer

The system can be used to view images. Select **Image viewer** in the main menu; the image gallery opens and an image can be selected.

To scroll through the images in slideshow mode, select **Slideshow** using the right soft button \rightarrow and set the seconds-per-slide when prompted, using the directional buttons.

To set the slideshow to manual mode, select **Manual** by moving to the far right of the seconds-per-slide display, then use the directional buttons to scroll through the images manually. Start the slideshow by pressing the right soft button \rightarrow .

Images can be added or deleted when updating the Navigation system.

Compatible image formats are:

- JPG: Greyscale and RGB
- BMP: 1-bit, 2 colours; 4-bit, 16 colours; 8-bit, 256 colours and 24-bit, 16.7 million colours

Setting up the Navigation system

Navigation volume

To change the volume during a voice instruction, turn the \odot knob or press $+$ or $-$.

Alternatively, press button \leftarrow or \rightarrow on the steering column controls to change the volume.

To repeat a voice instruction, press the left soft button \leftarrow .

System preferences

The system can be adjusted to suit personal requirements. Select **Change preferences** in the main menu to view the adjustable preferences.

Certain menu items can also be found more quickly in the Quick menu. Press the central button on the remote control to open the **Quick menu**.

Change Home location

To change the location of your designated home.

Manage favourites

To delete stored favourite destinations. Select the desired entry followed by **Done** using the soft button to delete the entry.

Switch map

Used if installing several maps on the SD card. To change map, select **Switch map**, then select the map required.

Voice preferences

To select a voice used to give voice instructions and to select either human or synthesised voices.

The human voice instructions provide simplified guidance only, while the synthesised voice instructions provide road directions plus additional information (e.g. traffic signs and traffic information etc.).

Disable voice

To deactivate the voice instructions and use only the map screen for guidance.

Turn off sound

To deactivate all sound, including voice instructions and alerts etc.. To turn the sound back on, select **Turn on sound**.

Safety preferences

To activate sound warnings during driving (e.g. when exceeding a set speed or when approaching schools etc.). This option can also be used to simplify the menus.

Planning preferences

Five types of planning preferences are selectable. The recommended preference is **Fastest route**.

After having selected the planning criteria, the system permits the activation of the IQ Routes™ function. If activated, this function plans the best route taking the actual road speeds into account.

Toll road preferences: After having entered a destination, the system asks if you wish to change this request. Select one of the 3 types of planning preferences, then finish using the right soft button ↵.

Road types: Select preferences in terms of particular sections of the journey, such as unmade roads and ferry transfers.

Show lane images

When approaching a major road change, the system may switch to a close-up view of the junction with a turn arrow and road signs. This feature can be deactivated, if preferred.

Automatic zooming

During guidance, the display gradually zooms in before each change of direction. If preferred, this mode can be deactivated.

Show POI on map

To select the points of interest (POIs) which appear on the map.

Manage POIs

To add, modify or delete points of interest (POIs) or POI categories.

Set units

Units of distance: Select **Miles** or **Kilometres**, then select **Done** using the soft button.

Clock display: Select from the 3 clock display mode options, then select **Done** using the soft button to move to the next step.

Coordinates: Select from the 3 latitude and longitude display options, then select **Done** using the soft button to move to the next step.

Show/hide tips

When using the Navigation system, the system will display tips to help get the best use of the functions. These can be deactivated by selecting **Hide tips**. To reactivate, select **Show tips**.

Change car symbol

Changes the style of the car symbol.

2D map settings

To change the default map settings between 2D and 3D.

Compass preferences

Changes the compass display on the map screen.

Status bar preferences

Add to the list of options that appear on the navigation map status bar.

Name preferences

To display street and house numbers on the map.

Use day/night colours

In the default automatic mode, the system will automatically switch between day and night modes.

If manual mode is preferred, automatic mode can be deactivated by selecting **Use day colours** or **Use night colours**.

Automatic switching can be reactivated using the **Brightness preferences** menu.

Change map colours

New colours can also be downloaded. To select a downloaded colour, select an additional colour scheme, then the colour required.

Brightness preferences

Adjust the screen brightness to suit the external lighting conditions.

Set clock

When the clocks change in summer or winter, or when travelling abroad, the time on the system will need adjusting. Select **Set clock**; the

system offers three display modes. Select the desired mode, then **Done** using the soft button. Set the clock, then select **Done**.

Clock synchronisation: The synchronisation option allows the time to be set directly using GPS information. Select the **Sync** option with the left soft button \leftarrow .

Start-up preferences

Used to change the system start-up settings and also the start-up page by customising it with a chosen photo.

Show fewer menu options

Allows simplification of the menu to facilitate better use. To reactivate all options, select this icon again.

Change language

To change language, select **Language:**, the required language can then be selected from the list.

Reset factory settings

To reset all system parameters and delete all personal data.

Select **Reset factory settings** in the main menu, then follow the on-screen instructions using the soft buttons.

Partial reset: allows the deletion of all personal data (favourites, recent destinations, etc.).

After resetting, the system will restart in English.

Destination input

Select a destination

From the main menu, select **Navigate to...**, then choose from the following options:

Home

Guides you to your home.

To store the address of your home location, see **Add and save a favourite**.

Favourite

A stored list of frequently visited destinations.

- Select **Favourite** and confirm.
- Select the required destination from the list and confirm.

To store a destination in the favourites list, see **Add and save a favourite**.

Notice

The **Favourite** icon will be greyed out if no destinations have been saved as a Favourite.

Address

Enter either all or part of the address (i.e. city and street or city centre, area code etc.).

Notice

Only addresses known to the system through the digital map are accepted.

- When using for the first time, set the destination country.
- Enter the name of the desired city. The system may suggest several cities (the first line is always highlighted in yellow).
- Select the desired city from the list of suggestions and select **Done** using the soft button.
- Proceed in the same way for **Street:** and **House number:**.



If the desired city does not appear in the brief list of suggestions, a complete list can also be accessed via the drop down arrow (in the top right corner of the screen).

The system stores previously entered cities in its memory. They can then be directly selected from the full list via the drop down arrow.

Recent destination

Select a destination from the list of addresses last used, which are automatically stored.

Point of Interest(POI)

A point of interest (POI) is a service, establishment or tourist area close to a location. POIs are classed in different categories (e.g. restaurants, museums, car parks, etc.).

Select **Point of Interest** and confirm, then search for a POI from the following options:

Search by POI name

Enter the name of the POI and the system will automatically search for the point of interest.

Search by POI category

Select the desired category type (e.g. museum), then choose the area required from the following options:

- **POI near you,**
- **POI in city**
- **POI near Home**

Select **Done** to start the search.

Point on map

A destination from the map can be defined. Position the cursor on this destination and confirm. The system will calculate the route.

Latitude Longitude

Defines a destination using its latitude and longitude values.

Confirm the destination

Once the destination information has been entered, the system calculates the route. At the end of the calculation, the system displays the navigation summary and suggests two options:

- **Details:** Displays details of the journey in various forms. Refer to **Route information** in the **Guidance** section.
- **Done:** Guidance starts.

If not confirmed, this page will close after a few seconds and guidance starts automatically.

The IQ routes™ function can optimise the journey time using statistical data. To activate or deactivate this function, see **Route planning** in the **Usage** section.

Add and save a favourite

Select **Add Favourite** from the main menu.

The location for your Favourite can be selected from the following options:

Home

Save your home address as a favourite.

Favourite

Not used.

Address

When entering an address, choose from the following options:

- City centre,
- Street and house number,
- Area code,
- Crossing or junction.

Recent destination

Select a favourite location from the list of those recently entered as a destination.

Point of Interest

When adding a point of interest (POI) to your Favourites, choose from the following options:

- **POI near you:** Search from a list of POIs near your current position.
- **POI in city:** Choose a POI in a particular town or city. The town/city must be specified.
- **POI near Home:** Search from a list of POIs near your home location.

When navigating to a destination, a selection can also be made from a list of POIs:

- **POI along route,**
- **POI near destination.**

My location

When stopped somewhere interesting, it can be saved as a Favourite. The system will always suggest a name, usually the address, but a name can be chosen. To enter the name, just start typing.

Point on map

Select the location of the Favourite using the cursor, then select **Done** using the soft button.

Latitude Longitude

Creates a Favourite by entering latitude and longitude values.

Delete or rename a favourite

Select **Change preferences**, then select **Manage favourites**: select the Favourite then **Delete item** or **Rename item** using the soft button.

Prepare route in advance

Journeys can be planned in advance, e.g. to find out how long a journey is expected to take, or to check the route.

Select **Prepare route** from the main menu. Choose a starting point in the same way as selecting the destination, then select a destination. Choose the type of route and confirm. The system plans the route and allows details to be viewed.

Guidance

Route information

To view the route before guidance begins, select **View route** after a destination has been entered.

Select the details of the route from the following options:

Browse as text

Shows the route plan. Several details of the route will appear:

- direction change arrows,
- road types,
- road names,
- distance before a junction.

Browse as images

Shows changes in direction as images.

Browse map of route

Shows the map of the route.

Show route demo

Shows a demonstration of the route. The speed of the demonstration can be selected.

Show route summary

Shows details of the journey time, the distance and the type of route. To access this page directly from the navigation map, press the right soft button.

Show traffic on route

Shows an overview of traffic incidents affecting the journey.

Edit Itinerary

To modify the route, select **Find alternative** from the main menu. The following options are available:

Calculate alternative

Calculates an alternative to the route already planned. The system will look for another route from your current location to the destination.

Avoid roadblock

Select this if there is a roadblock or a line of traffic ahead which was not indicated by the Traffic info service. How much of the route to be avoided can be chosen: Avoid 100m, 500m, 2000m or 5000m.

The system will recalculate the route avoiding the section of the route for the selected distance.

Recalculate original

Returns to the original route.

Avoid part of route

Avoids a specific part of the route, such as a road or a junction. Choose the road to be avoided from the list of roads on the route.

Minimise traffic delays

Select this menu to plan the route based on the latest traffic information.

Travel via...

Select this to change the route so that it passes a particular location, e.g. to pick someone up. The location is chosen in the same way the destination is chosen, so all the same options can be selected: **Address**, **Favourite**, **Point of Interest** and **Point on map**.

The system will calculate a new route to the destination that passes the chosen location.

Deactivating guidance

To stop guidance when in progress, select **Clear route** (or **Cancel route**) in the main menu and confirm. To resume guidance, select **Navigate to...**, then **Recent destination**.

Browse map

Select **Browse map** from the main menu or use one of the direction buttons on the control. The right soft button zooms using the up and down keys. To access the options, press the OK button, then the right soft button.

Options

Access the option from the map browser. This menu allows the selection of information that will be shown on the browser. To change the display preferences for points of interest (POI), press the left soft button. To confirm the selection, press the right soft button.

Find

The map can be centred on a specific location; press the left soft button and this menu can centre:

- your home,
- a favourite,
- an address,
- a recent destination,
- a point of interest,
- your current location.

Cursor position:

To access the **Cursor position:** from the map browser, press the OK button. Use this menu to:

- centre the map on the vehicle location,
- navigate to a point on the map,
- search for a point on the map,
- add a point on the map to the favourites,
- add a point on the map to the POI,
- correct the location of the vehicle.

Help me!

Use **Help me!** to find and contact assistance. The following options can be selected:

Emergency phone numbers

The **Emergency phone numbers** menu gives different service centres:

- Nearest police station,
- Nearest doctor,
- Nearest hospital,
- Nearest public transport,
- Nearest car repair services,
- Nearest dentist,
- Nearest pharmacy,
- Nearest vet.

When a service centre is selected, the location and phone number are displayed. Select the service centre as a destination by pressing the soft button.

Drive to help

Use the system to navigate by road to:

- Nearest car repair services,
- Nearest hospital,

- Nearest doctor,
- Nearest police station,
- Nearest pharmacy,
- Nearest dentist.

Where am I?

The system shows your current location (address) and gives the GPS coordinates (latitude/longitude).

TomTom Safety Cameras

The system can provide alerts of safety or speed cameras on route. For options select **TomTom Safety Cameras** in the main menu:

Report safety camera

If the system does not indicate a camera that is on the journey, its details can be entered manually by selecting **Report safety camera**.

The type of camera has to be entered (fixed or mobile). The system opens a map page and using the directional controls, place the red marker on the location of the camera and confirm using the soft buttons.

Confirm the type of camera, and if **Speed camera** is chosen, the speed limit must also be entered and confirmed.

For the system to integrate cameras entered manually by other users, you must be subscribed to the camera updates in **TomTom HOME**. The camera alert will only become active after the location is confirmed by the TomTom technical department.

The quick menu can also be used to report a camera. Select **Report safety camera**. The system requires the type of camera to be entered, then which side of the road it is on. Confirm with the right soft button.

Change warning preferences

Use to delete or modify the warning time before the camera and the sound of the warning.

To add camera alerts (mobile camera, toll road camera etc.), check the types of camera required. Select the type of camera to modify, then to delete the warning, use the soft buttons to confirm yes or no. If No is

chosen, enter the warning time before the camera and **Done** using the soft button.

Select the desired sound to warn of an upcoming camera. Test the sound using the left soft button and confirm with the right soft button.

Disable alerts

The camera warnings can be enabled/disabled. Select **Disable alerts** in the main menu if the warnings are enabled or **Enable alerts** if the warnings are disabled.

Notice

In certain countries it is illegal to download and activate the camera warning option and this could lead to prosecution.

Traffic info

Allows up-to-date traffic information from local sources to be received. Traffic information can include:

- accidents and incidents,
- traffic volumes,
- roadworks,

- weather conditions,
- lane closures.

The **Traffic info** service is not available in all countries and regions.

Traffic incidents are notified by verbal messages and by symbols on the map - refer to the **Symbols overview** section.

To show the status of the **Traffic info** service, the following icons are displayed on the traffic sidebar:

- A = The device is searching for an FM station broadcasting traffic information.
- = Traffic information is up-to-date or being updated.
- ◐ = Information not updated for at least 9 minutes.
- ◑ = Information not updated for at least 14 minutes.
- ◒ = Information not updated for at least 19 minutes.
- ◓ = Information not updated for at least 24 minutes.

To manage the **Traffic info** service, select **Traffic info** (or **HD Traffic**) from the main menu and select from the following options:

Minimise traffic delays

Select this menu to plan the route based on the latest traffic information.

Show traffic on route

Select this menu to see an overview of all traffic incidents on the route. Use the soft buttons on the resulting screen to see more detailed information about each incident.

Browse map

This menu enables the map to be explored and to keep up-to-date with the traffic situation in the area. The map displays the last location shown. For information relating to the incidents shown on the map, select the incident using the right and left buttons, then confirm.

To access an area you are searching for more quickly, add it to your favourites.

Change Traffic info preferences

The following can be changed:

- Automatically minimise delays after every traffic update.
- Beep to notify when traffic situation on route changes.

Read aloud traffic info

Select this menu for traffic incidents to be read aloud on the route.

Symbols overview

 = Accident

 = Traffic jam

 = One or more lanes closed

 = Road closed

 = Traffic incident

 = Road works

 = Heavy rain

 = Snow

 = Strong wind, storm

 = Fog

 = Ice

Voice recognition

| | |
|---------------------------|----|
| General information | 63 |
| Phone control | 63 |

General information

The voice recognition function of the handsfree phone system allows you to operate certain functions of the mobile phone via voice input.

Voice tags can be created for the contacts in the vehicle phonebook enabling you to call a contact without manually selecting the caller name or number.

To ensure that conversations held inside the vehicle do not start unintentional calls to a saved contact, the voice recognition function must first be activated via the steering column controls.

In the event of incorrect operation, the voice recognition function requests you to repeat the desired command, or plays back the available options.

Phone control

Creating voice tags

In addition to names and numbers, voice tags can be created when new contacts are added to the vehicle phonebook. Refer to **Operation** in the **Phone** section ⇨ 73.

Voice tags can also be added or modified afterwards by selecting the following menus and options:

- **Directory Management,**
- **Vehicle phonebook,**
- **Modify this contact.**

Select the contact to be modified from the list of contacts, then select the following menu options by turning and pressing the rotary knob:

- **(voice tag),**
- **Launch voice tag recording,**



When prompted to record a voice tag, speak after the tone. A message asks for the voice tag to be repeated. If the system does not recognise the repeated voice tag, it will request it to

be repeated again. A message confirms that the voice tag has been recorded successfully.

Upon completion, ensure the voice tag is stored along with other contact details by selecting **Memorise**.

Activating voice recognition

To activate the voice recognition function:

- Press button  or
- Press button  (on the steering column controls)

After the tone, repeat the voice tag previously recorded for the desired contact to start the dialling process.

Say the voice tag directly, i.e. do not say 'Call' before the voice tag.

If the system does not recognise the voice tag, a message asks you to repeat it. If the voice tag is still not recognised, the list of recorded voice tags is played back. Repeat the desired voice tag when it is played back, to start the dialling process.

In the event the system still does not recognise the voice tag, the voice recognition function is automatically deactivated.

Phone

| | |
|--|----|
| General information | 65 |
| Connection | 67 |
| Bluetooth connection | 70 |
| Emergency call | 72 |
| Operation | 73 |
| Mobile phones and CB radio equipment | 83 |

General information

The handsfree phone system provides you with the possibility of having mobile phone conversations via the vehicle's microphone and loudspeakers, as well as operating the most important mobile phone functions via the Infotainment system.

To be able to use the handsfree phone system, the mobile phone has to be connected with it via **Bluetooth**.

Not all handsfree phone system functions are supported by every mobile phone. The possible phone functions depend on the relevant mobile phone and network provider. Refer to the operating instructions for your mobile phone or consult your network provider.

Important information for operation and traffic safety

Warning

Use of the handsfree phone system while driving can be dangerous as your concentration is reduced when telephoning. Park the vehicle before using the handsfree phone system.

Follow the regulations of the country in which you are driving.

Also follow the special regulations that apply in specific areas and always switch off the mobile phone if the use of mobile phones is prohibited, if interference is caused by the mobile phone or if dangerous situations can occur.

Warning

Mobile phones have effects on your environment. For this reason, safety regulations have been

prepared which you should make yourself familiar with before you use the telephone.

Bluetooth

The handsfree phone system supports Bluetooth Handsfree Profile V. 1.5 and is specified in accordance with the Bluetooth Special Interest Group (SIG).

Further information about the specification is available at www.bluetooth.org/qualweb

EU R & TTE Compliance

CE 0700

Hereby, we declare that the **Bluetooth System Transceiver** is in compliance with the essential requirements and other relevant provisions of Directive 1999/5/EC.





Phone controls

The most important phone controls are as follows:

Controls on Infotainment system or steering column:

- Button , or
- Button **TEL**: Opens the **Phone** menu.

Controls on steering column only:

- , : Take call, end/reject call.
- **MODE/OK**: Take call, end/reject call, confirm an action.
-  or : Activate/deactivate speech recognition.



Some features of the handsfree phone system can also be operated via voice recognition  63.

Display screen operation

R15 BT / CD15 BT - Display screen operation

- To move up/down in the display: Turn the **OK** rotary knob.
- To confirm actions: Press the **OK** rotary knob.
- To cancel actions (and return to previous menu): Press the  button.

CD30 BT - Display screen operation

- To move up/down in the display: Turn the rotary knob.
- To move left/right in the display: Press button  or .
- To confirm actions (and to move right only in the display): Press the rotary knob.

CD35 BT - Display screen operation

- To move up/down in the display: Turn the central rotary knob.
- To confirm actions: Press the central rotary knob.
- To cancel actions (and return to previous menu): Press the → button.

Operating keyboards in the display

R15 BT / CD15 BT - Operating keyboards in the display

To move within and to enter characters in the numerical keyboard shown on the display screen: Turn and press the **OK** rotary knob.

Entries can be corrected during input with the ← keyboard character.

Press the → button to stop using the keyboard and return to the previous screen.

CD30 BT - Operating keyboards in the display

To move within and to enter characters in both the alphabetical and numerical keyboards shown on the display screen: Turn and press the rotary knob.

Press button < or > to move between the keyboard area and the edit/confirm area (i.e. **Memorise**, **Cancel** and the keyboard type selector).

The keyboard selector switches between keyboard types, e.g. lower case/upper case alphabets with/without accented vowels.

Entries can be corrected during input via a display option or with the ← keyboard character.

Upon completion, store entries by selecting **Memorise**, or select **Cancel** to stop using the keyboard and return to the previous screen.

CD35 BT - Operating keyboards in the display

To move within and to enter characters in both the alphabetical and numerical keyboards shown on the display screen: Turn and press the central rotary knob.

Entries can be corrected during input with the ← keyboard character.

Press the → button to stop using the keyboard and return to the previous screen.

Connection

A mobile phone must be connected to the handsfree phone system in order to control its functions via the Infotainment system.

No phone can be connected to the system unless it has first been paired. Refer to the **Bluetooth connection** section (⇨ 70) for pairing a mobile phone to the handsfree phone system via Bluetooth.

When the ignition is switched on, the handsfree phone system searches for paired phones in the vicinity.

Bluetooth must be activated on the mobile phone for the phone to be recognised by the handsfree phone system. Searching continues until a paired phone is found. A display message indicates that the phone is connected.

Notice

When a Bluetooth connection is active, using the handsfree phone system will discharge the mobile phone battery more rapidly.

Automatic connection

For your phone to connect automatically when the system is switched on, it may be necessary to activate the automatic **Bluetooth** connection function on your mobile phone; refer to the mobile phone operating instructions.

Notice

When reconnecting to a paired phone, or when 2 paired phones are within range of the handsfree phone system, either the priority phone (if defined) or the last connected phone is connected automatically, even if

this phone is outside the vehicle but still within range of the handsfree phone system.

During automatic connection, if a call is already in progress, the conversation will automatically switch to the vehicle's microphone and loudspeakers.

If connection fails:

- Check the phone is switched on,
- Check the phone battery is not flat,
- Check if the phone has already been paired.

The Bluetooth function on the mobile phone and on the handsfree phone system must be active and the mobile phone must be configured to accept the system connection request.

Manual connection

R15 BT / CD15 BT - Manual connection

To change the phone connected to the handsfree phone system, press the **TEL** button and select the **Select Device** menu. The device list shows the phones already paired.

Select the desired phone from the list and confirm by pressing the **OK** rotary knob. A display message confirms phone connection.

CD30 BT - Manual connection

To change the phone connected to the handsfree phone system, press the **☰** button and select **Bluetooth connection** from the settings menu. The device list shows the phones already paired.

Select the desired phone from the device list, then select **Connect the device** and confirm by pressing the rotary knob. A display message confirms phone connection.

CD35 BT - Manual connection

To change the phone connected to the handsfree phone system, press the **SETUP / TEXT** button and select **Bluetooth connection** (or press the **TEL** button when no device is connected). The device list shows the phones already paired.

Select the desired phone from the list and confirm by turning and pressing the central rotary knob. A display message confirms phone connection.

Disconnecting a phone

If the mobile phone is switched off, the phone is automatically disconnected from the handsfree phone system.

During disconnection, if a call is already in progress, the conversation will automatically switch to the mobile phone.

R15 BT / CD15 BT - Disconnecting a phone

To disconnect a phone from the Infotainment system, press the **TEL** button (or the **SETUP** button) and select **Bluetooth connection**. Select the desired device from the device list

then select **Disconnect the device** by turning and pressing the **OK** rotary knob. A display message confirms phone disconnection.

CD30 BT - Disconnecting a phone

To disconnect a phone from the handsfree phone system, press the **☎** button and select **Bluetooth connection** from the settings menu. Select **Disconnect the device** and confirm by pressing the rotary knob. A display message confirms phone disconnection.

CD35 BT - Disconnecting a phone

To disconnect a phone from the Infotainment system, press the **SETUP / TEXT** button and select **Bluetooth connection**. Select the desired device from the device list then select **Disconnect the device** by turning and pressing the central rotary knob. A display message confirms phone disconnection.

Defining the priority phone

R15 BT / CD15 BT - Defining the priority phone

The priority phone is the last connected phone.

When the ignition is switched on, the handsfree phone system searches first for the priority paired phone. Searching continues until a paired phone is found.

CD30 BT - Defining the priority phone

If defined, when the ignition is switched on, the handsfree phone system searches first for the priority paired phone.

To define the priority phone, press the **☎** button and select **Bluetooth connection** from the settings menu. The device list shows the phones already paired.

Select the desired phone from the device list, then select **Define priority (number)** and confirm by pressing the rotary knob.

CD35 BT - Defining the priority phone

The priority phone is the last connected phone.

When the ignition is switched on, the handsfree phone system searches first for the priority paired phone. Searching continues until a paired phone is found.

Bluetooth connection

Bluetooth is a radio standard for the wireless connection of, e.g., a telephone with other devices.

Information such as a mobile phone contact list and call lists can be transferred. The functionality can be restricted depending on the phone model.

Prerequisites

The following prerequisites must be met, in order to control a Bluetooth-enabled mobile phone via the Infotainment system:

- The Bluetooth function of the Infotainment system must be activated.

- The Bluetooth function of the Bluetooth-enabled mobile phone must be activated (see mobile phone operating instructions).
- Dependent upon the mobile phone, it may be required to set the device to "visible" (see mobile phone operating instructions).
- The mobile phone must be paired and connected to the Infotainment system.

Activating Bluetooth function of the Infotainment system

To enable the Infotainment system to recognise and operate a Bluetooth-enabled mobile phone, the Bluetooth function must first be activated. Deactivate the function if not required.

R15 BT / CD15 BT - Activating Bluetooth

Press the **TEL** button and select **Bluetooth** by turning and pressing the **OK** rotary knob.

Select **ON** or **OFF** and confirm by pressing the knob.

CD35 BT - Activating Bluetooth

Press the **SETUP / TEXT** button and select **Phone settings** by turning and pressing the central rotary knob.

Select **Bluetooth activated** or **Bluetooth deactivated** and confirm by pressing the knob.

Pairing a mobile phone to the handsfree phone system

In order to use your handsfree phone system, a connection must be set up between the mobile phone and the system via **Bluetooth**, i.e. the mobile phone must be paired to the vehicle before using it. For this purpose, the mobile phone must support Bluetooth. Refer to the operating instructions for your mobile phone.

To set up a Bluetooth connection, the handsfree phone system must be switched on and Bluetooth must be activated on the mobile phone.

Notice

If another phone is automatically connected during a new pairing procedure, it will automatically be disconnected, to allow the new pairing procedure to continue.

Pairing enables the handsfree phone system to recognise and store a mobile phone in the device list. A maximum of 5 mobile phones can be paired and stored in the device list, but only one can be connected at a time.

When pairing is completed, a message with the name of the paired phone is shown on the Infotainment system display screen and the phone is automatically connected to the handsfree phone system. The mobile phone can then be operated via the Infotainment system controls.

Notice

When a Bluetooth connection is active, using the handsfree phone system will discharge the mobile phone battery more rapidly.

R15 BT / CD15 BT - Pairing a mobile phone

To pair a phone to the handsfree phone system, press the **TEL** button and select **Pair device** by turning and pressing the **OK** rotary knob. The **Ready to Pair** screen is displayed.

On the mobile phone, search for Bluetooth equipment in the vicinity of the device.

Select **My Radio** (i.e. the name of the handsfree phone system) from the list on the mobile phone, then, on the mobile phone keypad, enter the pairing code shown on the Infotainment system display screen.

If pairing fails, the system returns to the previous menu and a corresponding message is displayed. Repeat procedure if necessary.

CD30 BT - Pairing a mobile phone

To pair a phone to the handsfree phone system, press the **f+** button and select **Bluetooth connection** from the settings menu. Select an empty

slot by turning the rotary knob and press rotary knob (or button **<** or **>**) to display the next menu.

Select **Pair phone** by turning and pressing the rotary knob, then, on the mobile phone, search for Bluetooth equipment in the vicinity of the phone.

Select **My Radiosat** (i.e. the name of handsfree phone system) from the list on the mobile phone, and on the mobile phone keypad enter the pairing code shown on the Infotainment system display screen.

If pairing fails, a tone sounds and the message **Connection has failed.** is shown on the display. Repeat procedure if necessary.

CD35 BT - Pairing a mobile phone

To pair a phone to the handsfree phone system, press the **SETUP / TEXT** button and select **Bluetooth connection** from the settings menu. Select an empty slot by turning the central rotary knob and press the knob to display the next menu.

Select **Pair phone** by turning and pressing the central rotary knob, then, on the mobile phone, search for Bluetooth equipment in the vicinity of the phone.

Select **My_Radio** (i.e. the name of handsfree phone system) from the list on the mobile phone, then on the mobile phone keypad enter the pairing code shown on the Infotainment system display screen.

If pairing fails, the message **Pairing failed** is displayed. Repeat procedure if necessary.

Unpairing a mobile phone from the handsfree phone system

If the list of paired phones is full, a new phone can only be paired if an existing phone is unpaired.

Notice

Unpairing a phone erases all of its downloaded contacts and its call history from the handsfree phone system mobile phonebook.

R15 BT / CD15 BT - Unpairing a mobile phone

To unpair, i.e. to delete a phone from the handsfree phone system memory, press the **TEL** button and select **Delete device**.

Select the desired phone from the device list and press the **OK** rotary knob to confirm deletion when prompted.

CD30 BT - Unpairing a mobile phone

To unpair, i.e. to delete a phone from the handsfree phone system memory, press the **†‡** button and select **Bluetooth connection** from the settings menu.

Select the desired phone from the device list, press the rotary knob (or button **<** or **>**) and select **Delete this device**.

CD35 BT - Unpairing a mobile phone

To unpair, i.e. to delete a phone from the handsfree phone system memory, press the **SETUP / TEXT** button and select **Bluetooth connection** from the settings menu.

Select the desired phone from the device list, press the central rotary knob and select **Delete**.

Emergency call

Warning

Connection setup cannot be guaranteed in all situations. For this reason, do not rely exclusively on a mobile phone when a vitally important communication (e.g. a medical emergency) is concerned.

On some networks, it may be necessary for a valid SIM card to be properly inserted in the mobile phone.

Warning

Bear in mind that you can only make and receive calls with the mobile phone if it is in a service area with a sufficiently strong signal.

Under certain circumstances, emergency calls cannot be made on all mobile phone networks; it is also possible that emergency calls cannot be made when certain network services and/or telephone functions are active. Consult your network provider for more information.

The emergency call number differs depending on country or region. Please enquire beforehand about the correct emergency call number for the relevant country or region.

Setting the emergency call number (CD30 BT)

CD30 BT

To make an emergency call via the handsfree phone system, the correct emergency call number must first be set.

Determine the correct emergency call number then open the **Phone** menu by pressing button  or **TEL**.

Select **Emergency** followed by **Enter/change number**. Enter the emergency call number (e.g. **112**) using the numerical keyboard  65.

Emergency call numbers vary depending on the country or region.

Dialling the emergency call number

CD30 BT

Open the **Phone** menu by pressing button  or **TEL**.

Select **Emergency** followed by **Call** to start dialling the emergency call number (e.g. **112**).

A telephone connection to the emergency call centre is set up.

Answer when the service personnel questions you about the emergency.

Warning

Do not end the call until you are requested to do so by the emergency call centre.

Operation

Introduction

When a Bluetooth connection has been set up between your mobile phone and the handsfree phone system, certain functions of your mobile phone can be operated via the Infotainment system controls.

It is then possible, e.g., to import the contacts and telephone numbers stored in your mobile phone into the handsfree phone system.

After connection, the mobile phone data is transmitted to the handsfree phone system. This can take some

time, depending on phone model. During this period, operation of the mobile phone is possible via the Infotainment system only to a limited extent.

Notice

Not every mobile phone supports the functions of the handsfree phone system. Therefore, deviations from the range of functions described are possible.



Phone menu

To display the **Phone** menu:

- Press button , or
- Press button **TEL**.





Volume control



R15 BT / CD15 BT - Volume control

During a call, turn  rotary knob or press  or  (on the steering column controls) to change the call volume.

CD30 BT - Volume control

To preset the volume for calls, voice recognition or the ringtone, press the  button and select **Phone settings** from the settings menu, followed by **Volume**.



Select the desired option (e.g. **Ringing volume**) and adjust the volume with the  rotary knob (or button  or ). Press  again to save changes and exit the menu.

During a call, turn  or press  or  to change the call volume.

CD35 BT - Volume control

To preset the volume for calls, voice recognition or the ringtone, press the **SETUP / TEXT** button and select **Phone settings** from the settings menu, followed by **Volume**.

Select the desired option (e.g. **Ringing volume**) and adjust the volume with the central rotary knob.

During a call, turn volume rotary knob or press  or  (on the steering column controls) to change the call volume.

Dialling a telephone number



Several options are available for dialling telephone numbers, including calling a contact from the mobile phonebook, from the vehicle phonebook or from a call log. Numbers can also be dialled manually.

Display the **Phone** menu by pressing the  or **TEL** button and select the relevant option from the list.

Entering a number manually

R15 BT / CD15 BT - Entering a number manually

With the **Phone** menu displayed, select **Dial** from the list.

Enter the desired number using the numerical keyboard ( 65) and select  to start dialling.

To redial the last number, press and hold the **TEL** button.

CD30 BT - Entering a number manually

With the **Phone** menu displayed, select **Dial a number** from the list.

Enter the desired number using the numerical keyboard (↵ 65) and select **Call** to start dialling.

CD35 BT - Entering a number manually

With the **Phone** menu displayed, select **Dial a number** from the list.

Enter the desired number using the numerical keyboard (↵ 65) then select the  icon in the display. Press the central rotary knob to start dialling.

Mobile phonebook

The mobile phonebook contains contact lists available only to the current vehicle user. For reasons of confidentiality, each downloaded contacts list can only be viewed when the corresponding phone is connected.

R15 BT / CD15 BT - Mobile phonebook

After pairing the mobile phone to the Infotainment system, the contact list in the mobile telephone is downloaded to the handsfree phone system.

To dial a number from the mobile phonebook, with the **Phone** menu displayed, select **Phonebook** and select the desired contact from the alphabetical list. Press the **OK** rotary knob to start the dialling process.

CD30 BT - Mobile phonebook

After setting up the connection, the contact list in the mobile telephone is downloaded to the handsfree phone system. Each time the phone is connected, the system's mobile phonebook is updated automatically.

The mobile telephone book can also be updated manually while the phone is connected by selecting the **Directory Management** menu followed by **Update**.

A maximum of 500 contacts and 4 numbers per contact can be downloaded. If the memory capacity is exceeded, a prompt to delete excess contacts will appear. Deleted contacts will remain on the mobile phone, but are deleted from the system memory.

Dialling a number from the mobile phonebook

To dial a number from the mobile phonebook, with the **Phone** menu displayed, select **Mobile phonebook** and select the first letter of the desired name by turning the rotary knob. Press the rotary knob to display the contacts listed for that letter, if applicable.

Turn rotary knob to select desired contact and press to display the corresponding details. Select **Call** to start the dialling process.

Adding contacts to the mobile phonebook

Contacts can be added to the mobile phonebook by selecting the following menu options:

- **Directory Management**
- **Mobile phonebook**
- **Add contact**

Use the alphabetical and numerical keyboards (↵ 65) to enter a name and up to 4 numbers for the new contact.

Upon completion, the following menu options are available:

- **Memorise:** to save the new contact details,
- **Cancel:** to cancel the entry,
- **Delete:** to delete the entry.

Incorrect names and numbers entered via the keyboards can also be deleted during contact creation.

Deleting mobile phonebook contacts

Individual contacts or the entire list can be deleted from the list of contacts in the mobile phonebook by selecting the following menu options:

- **Directory Management**
- **Mobile phonebook**
- **Delete contacts** or **Delete phonebook**

Turn and press the rotary knob to select and delete. Confirm deletion when prompted.

CD35 BT - Mobile phonebook

After setting up the connection, the contact list in the mobile telephone is downloaded to the handsfree phone system. Each time the phone is connected, the system's mobile phonebook is updated automatically.

The mobile telephone book can also be updated manually while the phone is connected by selecting the **Phone settings** menu followed by **Update**. Select the **Update** option and confirm by turning and pressing the central rotary knob.

A maximum of 500 contacts and 4 numbers per contact can be downloaded. If the memory capacity is exceeded, a prompt to delete excess contacts will appear. Deleted

contacts will remain on the mobile phone, but are deleted from the system memory.

Dialling a number from the mobile phonebook

To dial a number from the mobile phonebook, with the **Phone** menu displayed, select **Phone settings** to display the contacts list.

Select the first letter of the desired name by turning the central rotary knob. Press the knob to display the contacts listed for that letter, if applicable.

Turn rotary knob to select desired contact and press knob to display the corresponding details. Select the relevant number for the contact and press knob to start the dialling process.

Adding contacts to the mobile phonebook

Contacts can be added to the mobile phonebook by selecting the following menu options:

- **Phone settings**
- **Add contact**

Use the alphabetical and numerical keyboards (↵ 65) to enter a name and up to 4 numbers for the new contact.

Incorrect names and numbers entered via the keyboards can also be deleted during contact creation.

Vehicle phonebook

CD30 BT - Vehicle phonebook

The vehicle phonebook is a contact list shared by all users of the vehicle. A maximum of 40 contacts can be added to the list. In addition to names and numbers, voice tags can be assigned to each contact in the vehicle phonebook.

Dialling a number from the vehicle phonebook

To dial a number from the vehicle phonebook, with the **Phone** menu displayed, select **Vehicle phonebook** and select the desired contact from the alphabetical list by turning the rotary knob. Press the rotary knob to display the corresponding details and select **Call** to start the dialling process.

Adding contacts to the vehicle phonebook

Contacts can be added to the vehicle phonebook by selecting the following menu options:

- **Directory Management**
- **Vehicle phonebook**
- **Create a new contact**

Select **(name)** followed by **Enter/change the name** to create or modify the contact name. Select **(number)** followed by **Enter/change number** to create or modify the contact number. Use the alphabetical and numerical keyboards (↵ 65) to enter names and numbers for the new contact.

Depending on the vehicle, a voice tag can also be entered for each contact added to the vehicle phonebook. Select **(voice tag)**, followed by **Launch voice tag recording** by turning and pressing the rotary knob.

When prompted to record a voice tag, speak after the tone. A message asks for the voice tag to be repeated. If the system does not recognise the repeated voice tag, it will request it to be repeated again. A message confirms that the voice tag has been recorded successfully.

Upon completion, the following menu options are available:

- **Memorise**: to save the new contact details,
- **Cancel**: to cancel the entry,
- **Delete**: to delete the entry.

Incorrect names and numbers entered via the keyboards can also be deleted during contact creation.

Modifying contacts in the vehicle phonebook

Contact details, including the voice tag, can be modified afterwards in the same way by selecting the following menu options:

- **Directory Management**
- **Vehicle phonebook**
- **Modify this contact**

Select the contact to be modified from the list of contacts in the vehicle phonebook. It is possible to modify, delete or play back the existing voice tag from this menu.

Importing contacts in to the vehicle phonebook

Contacts can also be imported into the vehicle phonebook from the mobile phonebook or the call history lists (e.g. dialled numbers, received calls, missed calls) by selecting the following menu options:

- **Directory Management**
- **Vehicle phonebook**

- **Import contact**
- **Mobile phonebook** or **Dialled numbers** etc.

Select the number to be imported from the chosen list and select **Memorise** to store the contact in the vehicle phonebook. Confirm modification when prompted.

Alternatively, contacts can be stored in the vehicle phonebook from the mobile phonebook or the call history lists while those menus are active.

Deleting vehicle phonebook contacts

Individual contacts or the entire list can be deleted from the list of contacts in the vehicle phonebook by selecting the following menu options:

- **Directory Management**
- **Vehicle phonebook**
- **Delete this contact** or **Delete phonebook**

Turn and press the rotary knob to select and delete. Confirm deletion when prompted.

Call lists

R15 BT / CD15 BT - Call lists

To dial a number from the call history lists (e.g. dialled numbers, received calls, missed calls), select the relevant option, e.g. **Recent calls** from the **Call list** menu. Select the desired contact and press the **OK** rotary knob to start the dialling process.

CD30 BT - Call lists

To dial a number from the call history lists (e.g. dialled numbers, received calls, missed calls), select the relevant option, e.g. **Dialled numbers** from the **Call history list** menu. Select the desired contact followed by **Call this contact**, to start the dialling process.

The call history lists are updated automatically. They can also be updated manually by selecting **Call history list** then selecting **Update** from the menu.

CD35 BT - Call lists

To dial a number from the call history lists (e.g. dialled numbers, received calls, missed calls), select the relevant option, e.g. **Dialled calls** from the **History** menu. Select the desired contact and press the central rotary knob to start the dialling process.

Voice mail box

R15 BT / CD15 BT - Voice mail box

To listen to mobile phone voice mail messages via the Infotainment system, select the **Voice mail box** menu.

CD30 BT - Voice mail box

To listen to mobile phone voice mail messages via the Infotainment system, your phone's voice mail box number must first be entered into the handsfree phone system.

To enter the number, with the **Phone** menu displayed, select **Voice mail box** from the list, followed by **Enter/change number**. Enter your phone's voice mail box number using the numerical keyboard (↔ 65).

To listen to voice mail, with the **Phone** menu displayed, select **Voice mail box** from the list, followed by **Call**, to start the dialling process.

The voice mail box number varies depending on the service provider.



CD35 BT - Voice mail box

To listen to mobile phone voice mail messages via the Infotainment system, select the **Voice mail box** menu.



Receiving calls

R15 BT / CD15 BT - Receiving calls

To accept the call, depending on vehicle configuration:

- Briefly press the  button (on the steering column controls)
- Select the  icon in the display (by turning and pressing the **OK** rotary knob)

To reject the call, depending on vehicle configuration:

- Press and hold the  button (on the steering column controls)
- Select the  icon in the display (by turning and pressing the **OK** rotary knob)

When receiving a call, the caller number may be shown on the Infotainment system display screen. If the number is stored in the system memory, the name is displayed instead. If the number cannot be displayed, the message **Private number** is shown.

CD30 BT - Receiving calls

When receiving a call, various functions are available, including:

- **Pick up**
- **Hold**
- **Refuse**

When receiving a call, the caller number may be shown on the Infotainment system display screen. If the number is stored in the system memory, the name is displayed

instead. If the number cannot be displayed, the message **Private number** is shown.

The handsfree phone system ringtone is dependent upon the phone model and mode (silent, vibrate, etc.).

Automatic call waiting

For safety reasons, the automatic call waiting function is set by default. It is recommended that this feature remains activated.

When an incoming call arrives, a message alerts the caller to the fact that you are driving. The call starts automatically and the length of the call is shown on the Infotainment system display screen. Pick up the call only when it is safe to do so.

To deactivate automatic call waiting, refer to **Activate/deactivate automatic call waiting** in the **Phone settings** section.

With automatic call waiting deactivated, it is possible to reject the call by selecting **Refuse** or by pressing and holding the **✕** or **MODE/**

OK button. To place the caller on hold, select **Hold**; the caller is informed they are on hold via an automatic message.

Temporarily override the automatic call waiting feature by selecting **Pick up** or press the **↶** or **MODE/OK** button to receive the call.

CD35 BT - Receiving calls

To accept the call, briefly press the **↶** button (on the steering column controls).

To reject the call:

- Press and hold the **✕** button (on the steering column controls), or
- Select **Refuse** in the display (by turning and pressing the central rotary knob)

When receiving a call, the caller number may be shown on the Infotainment system display screen. If the number is stored in the system memory, the name is displayed instead. If the number cannot be displayed, the message **Unknown** is shown.

The handsfree phone system ringtone is dependent upon the phone model and mode (silent, vibrate, etc.).

Automatic call waiting

For safety reasons, the automatic call waiting function is set by default. It is recommended that this feature remains activated.

When an incoming call arrives, a message alerts the caller to the fact that you are driving. The call starts automatically and the length of the call is shown on the Infotainment system display screen. Pick up the call only when it is safe to do so.

To deactivate automatic call waiting, refer to **Activate/deactivate automatic call waiting** in the **Phone settings** section.

With automatic call waiting deactivated, it is possible to reject the call by selecting **Refuse** or by pressing and holding the **✕** button. To place the caller on hold, select **Pause**; the caller is informed they are on hold via an automatic message.

Temporarily override the automatic call waiting feature by selecting **Resume** or press the  button to receive the call.

Functions during a telephone call

R15 BT / CD15 BT - Functions during a telephone call

In addition to volume control, various functions are available during a call, including:

- Switch the call to the mobile phone
- Access the keyboard
- End call

Turn and press the **OK** rotary knob to select and confirm.

Switch the call from the handsfree phone system to the mobile phone by selecting the mobile phone display item. Some mobile phones may become disconnected from the handsfree phone system during the switch to this mode.

A number can also be entered on the numerical keyboard (⇨ 65) e.g. to control a voice server such as the voicemail box. Select the **#123** display item to access the numerical keyboard. Refer to **Voicemail box** for further information.

To end the call, depending on vehicle configuration:

- Briefly press the  button
- Press the **TEL** button
- Select the  icon in the display

CD30 BT - Functions during a telephone call

In addition to volume control, various functions are available during a call, including:

- **Pause / Pick up**
- **Handset**
- **Keyboard**
- **Hang up**

To put the caller on hold, select **Pause**; the caller is informed they are on hold via an automatic message. Select **Pick up** to resume the call.

Switch the call from the handsfree phone system to the mobile phone by selecting **Handset**. Some mobile phones may become disconnected from the handsfree phone system during the switch to this mode.

A number can also be entered on the numerical keyboard (⇨ 65) e.g. to control a voice server such as the voicemail box. Select the **Keyboard** menu item to access the numerical keyboard. Refer to **Voicemail box** for further information.

To end the call, depending on vehicle configuration:

- Press the  button
- Select **Hang up** then press the **MODE/OK** button

CD35 BT - Functions during a telephone call

In addition to volume control, various functions are available during a call, including:

- **Pause / Resume**
- **Handset**

■ Keyboard

■ Hang up

To put the caller on hold, select **Pause**; the caller is informed they are on hold via an automatic message. Select **Resume** to resume the call.

Switch the call from the handsfree phone system to the mobile phone by selecting **Handset**. Some mobile phones may become disconnected from the handsfree phone system during the switch to this mode.

A number can also be entered on the numerical keyboard (⇨ 65) e.g. to control a voice server such as the voicemail box. Select the **Keyboard** menu item to access the numerical keyboard. Refer to **Voicemail box** for further information.

To end the call:

- Press the ✕ button, or
- Select **Hang up**, then press the central rotary knob

Phone settings

CD30 BT - Phone settings

Press the **☎** button and select the **Phone settings** menu.

When phone setting adjustments have been made, press **☎** to exit the menu and save changes. The system also saves and exits automatically after a delay.

Activate/deactivate automatic call waiting

To activate or deactivate automatic call waiting, access the **Put on hold** menu, then select either **Automatic** (the default setting) or **Manual**.

Change ringtones

The vehicle ringtone or phone ringtone can be changed for incoming calls. Access the **Ring tone** menu, then select **Vehicle** or **Phone**.

Notice

Depending on phone model, the ringtone transfer function may not be available.

Restore default phone settings

To restore phone settings to their default values, select **Default settings** by turning and pressing the rotary knob. Confirm modification with the display option when prompted.

Display software version

To display the software version, select **Display software version** by turning and pressing the rotary knob.

CD35 BT - Phone settings

Press the **SETUP / TEXT** button and select the **Phone settings** menu.

Activate/deactivate automatic call waiting

To activate or deactivate automatic call waiting, access the **Put on hold** menu, then select either **Automatic** (the default setting) or **Manual**.

During automatic mode, a tone will sound to indicate that a call is on hold.

Change ringtones

The vehicle ringtone or phone ringtone can be changed for incoming calls. Access the **Ring tone** menu, then select **Vehicle** or **Phone**.

Notice

Depending on phone model, the ringtone transfer function may not be available.

Restore default phone settings

To restore phone settings to their default values, select **Default settings** by turning and pressing the rotary knob. Confirm modification with the display option when prompted.

Display software version

To display the software version, select **Display software version** by turning and pressing the rotary knob.

Mobile phones and CB radio equipment

Installation instructions and operating guidelines

The vehicle specific installation instructions and the operating guidelines of the mobile phone and handsfree manufacturer must be observed when installing and operating a mobile telephone. Failure to do so could invalidate the vehicle type approval (EU directive 95/54/EC).

Recommendations for fault-free operation:

- Professionally installed exterior antenna to obtain the maximum range possible,
- Maximum transmission power 10 watts,
- Installation of the phone in a suitable spot, consider relevant Note in the Owner's Manual section **Airbag system**.

Seek advice on predetermined installation points for the external antenna or equipment holder and ways of using devices with a transmission power exceeding 10 watts.

Use of a handsfree attachment without external antenna with mobile telephone standards GSM 900/1800/1900 and UMTS is only permitted if the maximum transmission power of the mobile telephone is 2 watts for GSM 900 or 1 watt for the other types.

For reasons of safety, do not use the phone while driving. Even use of a handsfree set can be a distraction while driving.

Warning

Operation of radio equipment and mobile telephones which fail to meet above mentioned mobile telephone standards is only permitted using an antenna located outside of the vehicle.

Caution

Mobile telephones and radio equipment may lead to malfunctions in the vehicle electronics when operated inside the vehicle with no exterior antenna, unless the above mentioned regulations are observed.

Index

- | | | |
|-----------------------------------|----|--|
| A | | Change system language..... 14 |
| AAC files..... | 30 | Clock..... 14, 49 |
| ACC files..... | 37 | Connecting an audio device..... 40 |
| Adaptation volume km/h..... | 21 | Connection..... 67 |
| AF (Alternative Frequency)..... | 27 | Control elements overview..... 6 |
| AGC Activated..... | 18 | Creating a TOMTOM HOME™ account..... 46 |
| AST..... | 26 | |
| Audio CDs..... | 30 | D |
| Audio settings..... 18, 31 | | Defining the priority phone..... 67 |
| Automatic call waiting..... | 73 | Destination input 55 |
| Automatic Gain Control (AGC)..... | 18 | Dialling a telephone number..... 73 |
| Automatic station search..... | 23 | Display..... 14 |
| Automatic station storing..... | 26 | Display information..... 31 |
| Automatic switch-off..... | 14 | Display screen operation..... 14, 65 |
| Autostore lists..... | 26 | |
| AUX input..... | 35 | E |
| | | Emergency call..... 72 |
| B | | |
| Balance..... 18 | | F |
| Bass..... 18 | | Fader..... 18 |
| Battery replacement..... | 49 | FM station list..... 26 |
| Bluetooth..... | 65 | FMT..... 26 |
| Bluetooth connection..... 40, 70 | | |
| Bluetooth music..... | 40 | G |
| | | General information..... |
| C | | 4, 30, 35, 37, 40, 46, 63, 65 |
| Call lists..... | 73 | GPS (Global Positioning System). 46 |
| CD display..... | 31 | Guidance 58 |
| CD player..... 30, 31 | | Guided tours..... 49 |
| CD-Text..... | 31 | |

| | |
|------------------------|----|
| Switching on/off..... | 14 |
| Symbols overview | 62 |
| System settings..... | 14 |

T

| | |
|--|-------|
| Text information (CD-Text or ID3 tag)..... | 31 |
| Text information (Radio text)..... | 27 |
| Theft-deterrent feature | 14 |
| Time..... | 14 |
| TomTom HOME™ | 46 |
| Tone settings..... | 18 |
| Traffic announcements..... | 27 |
| Traffic announcement volume..... | 21 |
| Traffic info service..... | 46 |
| Traffic safety..... | 4, 65 |
| Treble..... | 18 |

U

| | |
|------------------------------------|--------------------|
| Update FM list..... | 26 |
| Usage..... | 14, 22, 31, 35, 49 |
| USB port..... | 37 |
| Using the CD player..... | 31 |
| Using the display screen..... | 14 |
| Using the Infotainment system..... | 14 |
| Using this manual..... | 4 |

V

| | |
|------------------------|----|
| Vehicle phonebook..... | 73 |
| Voicemail box..... | 73 |

| | |
|-----------------------------------|--------|
| Voice recognition..... | 63 |
| Voice tags..... | 63 |
| Volume..... | 63 |
| Adaptation volume km/h..... | 21 |
| Automatic Gain Control (AGC).. | 18 |
| Low volume sound enhancement..... | 18 |
| Rear OFF..... | 18 |
| Speed dependent volume... .. | 14, 21 |
| Traffic announcement volume... .. | 21 |
| Volume distribution..... | 18 |
| Volume settings..... | 21 |

W

| | |
|-------------------------|----|
| Waveband selection..... | 22 |
| WAV files..... | 30 |
| WMA CDs..... | 30 |
| WMA files..... | 37 |

Copyright by General Motors UK Ltd.

The information contained in this publication is effective as of the date indicated below. General Motors UK Ltd. reserves the right to make changes to the technical specifications, features and design of the vehicles relative to the information contained in this publication, as well as changes to the publication itself.

Edition: January 2013, General Motors UK Ltd.

Printed on chlorine-free bleached paper.

KTA-2701/4-VX-en TS 1686-A-13

01/2013

