



Owner's Manual

ASTRA

Operation, Safety and Maintenance



ASTRA

VAUXHALL Astra

Operation, Safety, Maintenance

Data specific to your vehicle

Please enter your vehicle's data here to keep it easily accessible.

This information is available under the section "Technical data" as well as on the identification plate.

Fuel

Designation

Engine oil

Grade

Viscosity

Tyre inflation pressure

Tyre size
Summer tyres

Winter tyres

with full load

Front Rear

Front Rear

Weights

Permissible gross vehicle weight

- EC kerb weight

= Loading

Your Astra

Developed to the latest findings of automobile research, it offers technical sophistication and exceptional comfort.

Your vehicle represents an intelligent synthesis of advanced technology, outstanding safety, environmental compatibility and economy.

It now lies with you to drive your vehicle safely and to see it performs perfectly. This Owner's Manual provides you with all the necessary information to that end.

Make sure your passengers are aware of the possible risk of accident and injury which may result from improper use of the vehicle.

You must always comply with the laws of the country in which you are travelling. These could differ from the information in this Owner's Manual.

The Owner's Manual should always be kept in the vehicle: ready to hand in the glove compartment.

Make use of the Owner's Manual:

- Its "In Brief" section will give you an initial overview.
- The table of contents at the start of the Owner's Manual and in each individual chapter will help you find your way.
- Its index will help you find what you want.
- It will familiarise you with the sophisticated technology.
- It will increase your pleasure in your vehicle.
- It will help you to handle your vehicle expertly.

The Owner's Manual is designed to be clearly laid-out and easily understood.

This symbol signifies:

▶ Continue reading on next page.

* The asterisk signifies equipment not fitted to all vehicles (model variants, engine options, models specific to one country, optional equipment, Genuine Vauxhall Parts and Accessories).

Warning

 **Warning** is used to mark text regarding possible risks of accident or injury. Failure to follow the instructions could lead to injury or loss of life. Inform vehicle passengers accordingly.

Yellow arrows in the illustrations serve as points of reference or indicate some action to be performed.

Black arrows in the illustrations indicate a reaction or a second action to be performed.

Thank you for choosing a Vauxhall. We wish you many hours of pleasurable driving.

Your Vauxhall Team

Contents

Commitment to customer satisfaction:

Our aim: to keep you happy with your vehicle. All Vauxhall Authorised Repairers offer first class service at competitive prices. Experienced, factory-trained technicians work according to factory instructions. Your Authorised Repairer can supply you with GENUINE VAUXHALL-APPROVED PARTS, which have undergone stringent quality and precision checks, and of course useful and attractive VAUXHALL-APPROVED ACCESSORIES. **Our name is your guarantee!**

For details of the Vauxhall Authorised Repairer Network please ring this number; 01582 - 427200

| | |
|---|-----|
| In Brief | 2 |
| Instruments | 36 |
| Keys, doors, bonnet | 66 |
| Seats, Interior | 87 |
| Safety systems | 111 |
| Lighting | 136 |
| Windows, Sun Roof | 143 |
| TwinTop | 148 |
| Climate control | 157 |
| Easytronic | 178 |
| Automatic transmission | 186 |
| Automatic transmission with ActiveSelect | 192 |
| Driving hints | 200 |
| Saving fuel, Protecting the environment | 202 |
| Fuel consumption, fuel, refuelling | 204 |
| Catalytic converter, exhaust gases | 207 |
| Drive Control Systems | 212 |
| Brakes | 226 |
| Wheels, tyres | 230 |
| Roof racks, Caravan and trailer towing | 238 |
| Self-help | 247 |
| If you have a problem | 294 |
| Maintenance, Inspection System | 296 |
| Vehicle care | 308 |
| Technical Data | 312 |
| Index..... | 349 |

In Brief



17027 9

Key numbers, Code numbers

Remove key number from keys.

The key number is specified in the vehicle documents and in the Car Pass *.

Alloy wheels *, towing equipment *: make a note of the key identifier codes.

Electronic immobiliser, infotainment system *: The code numbers are specified in the Car Pass.

Do not keep the Car Pass in the vehicle.

For key with retractable key blade *, press button to extend.

► Further information – pages 66, 67, vehicle recommissioning – page 307.



16968 7

To unlock and open the vehicle: Press button , pull door handle

In vehicles with an Open&Start system *, the vehicle is unlocked automatically by pulling a door handle or by pulling the button beneath the rear door handle if the electronic key is in the external reception range of the vehicle.

► Child safety locks – page 86, electronic immobiliser – page 67, keys – page 66, Open&Start system * – page 70, radio remote control – page 68, central locking system – page 76, anti-theft locking system * – page 77, Vauxhall alarm system * – page 83, TwinTop roof operation * – page 148.



**To unlock and open the luggage compartment:
Press button \geq on remote control and pull button beneath handle**

In vehicles with Open&Start system * the tailgate is unlocked automatically by pulling the button beneath the handle if the electronic key is within the external reception range of the vehicle. The doors are also unlocked.

► Open&Start-System * – Page 70,
Radio remote control – Page 68,
Central locking system – Page 76,
Vauxhall alarm system * – Page 83.

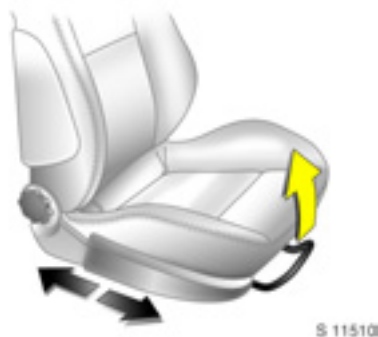

**To adjust front seat:
Pull handle, slide seat, release handle**

Never adjust the seat while driving. It could move in an uncontrolled manner when the handle is pulled.

► Seat position – page 87.

⚠ Warning

Do not sit nearer than 10 inches (25cm) from the steering wheel, to permit safe airbag deployment.



**Adjust front seat backrest:
Turn handwheel**

Move backrest to suit seating position.

Do not lean on seat backrest whilst adjusting it.

► Seat position – page 87.

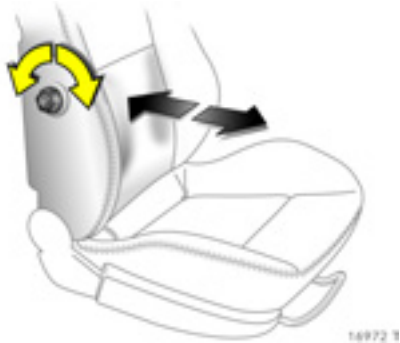

**To adjust front seat lumbar support *:
Turn handwheel**

Adjust lumbar support to suit personal requirements.

Do not lean on seat backrest whilst adjusting it.

► Seat position – page 87.

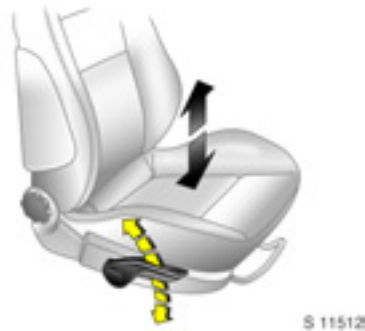

**To adjust front seat height *:
Operate lever on outboard side of seat**

Lever pumping action
upward: seat higher
downward: seat lower

► Seat position – page 87.

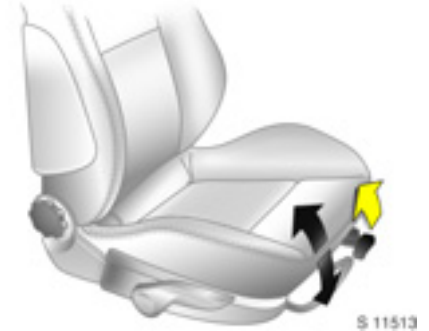

**To adjust front seat inclination *:
Pull inner lever on front of seat,
adjust inclination,
release lever,
engage seat in position**

Adjust the inclination by distributing body weight.

► Seat position – page 87.

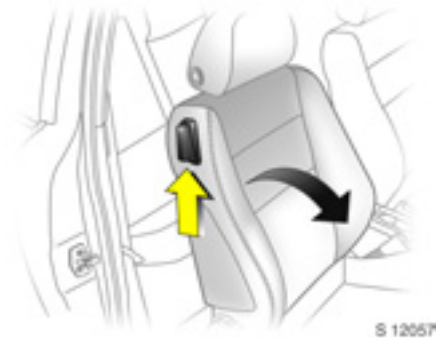

Tip the front seat backs forward *:
Lift release lever, tilt seat back forward, lower release lever, seat back is engaged in tilted position, slide seat forwards

To straighten the seat, slide back and it engages in its original position. Raise release lever, straighten seat back, lower release lever, seat back engages.

For seats without memory function *:
 engage seat in desired position.

The seat back can only be tipped forwards from an upright position.

Panoramic windscreen *:
 before folding the seat, push the head restraints down and close the sun visors.

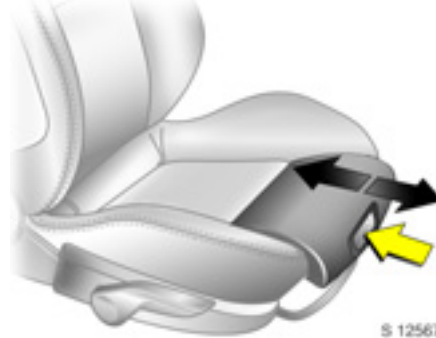

To adjust thigh support * of the front sport seat *:
Press button in recessed handle at the front of the adjustment cushion and adjust the thigh support

Adjust thigh support to suit personal requirements.

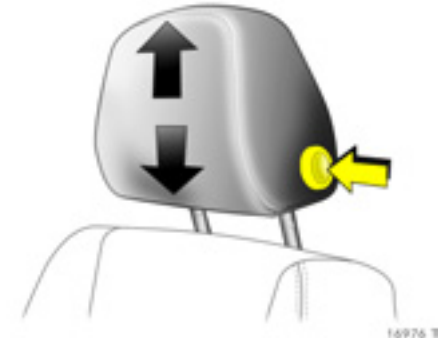

To adjust head restraint height of front and rear outboard seats:
Press button to release, adjust height, engage in position

► Head restraint position – Page 88,
 Adjusting rear centre head restraint – Page 89,
 Removing the head restraint – Page 88.

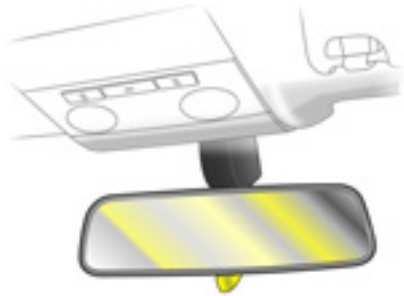

S 11514

**Adjusting interior mirror:
Swivel mirror housing**

Swivel lever on underside of mirror housing to reduce dazzle at night.

- ▶ Automatic anti-dazzle interior mirror – page 134.



S 12058

**To adjust exterior mirrors:
From inside, swivel lever
in required direction**

- ▶ Further information, aspherical exterior mirror * – page 134.

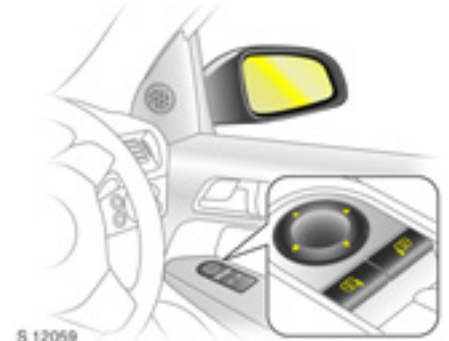

S 12059

**Electrical exterior mirrors *,
adjust:
Four-way switch in driver's door**

Press mirror switch right or left: Four-way switch adjusts corresponding mirror.

- ▶ Further information, aspherical exterior mirror – page 134, heated exterior mirrors – page 18.

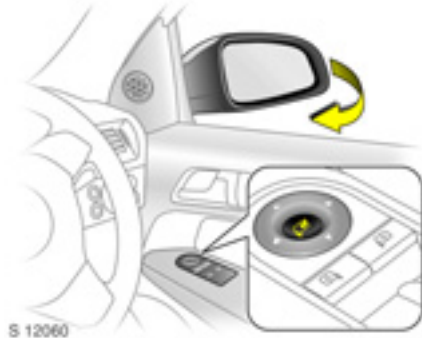



Swing in exterior mirror:

Manual: Mirrors can be folded in under light pressure.

Electrically ✳: Press  and both mirrors will swing in.

Press button  again - both exterior mirrors swivel to the driving position.

If an electrical retracted mirror is extended manually, pressing button  will cause the mirror to move all the way forward. The other mirror will be electrically swiveled to the driving position. If button  is pressed again, both mirrors will be electrically retracted. Press again: both mirrors swivel to the driving position.



Fitting seat belt: Draw seat belt smoothly from inertia reel, guide over shoulder and engage in buckle

The seat belt must not be twisted at any point. The lap belt must lie snugly against the body. The front seat backrests must not be tilted back too far (recommended tilting angle approx. 25°).

To release belt, press red button on belt buckle.

► Three-point seat belts – Page 112,
Vauxhall Full Size Airbag System
– Page 117,
Seat position – Page 87.

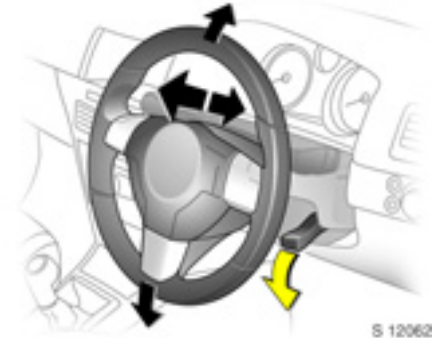

Steering wheel adjustment: Move lever down, adjust height and distance, move lever up, engage

Adjust steering wheel only when vehicle is stationary and steering column lock is released.

► Vauxhall Full Size Airbag System
– Page 117.

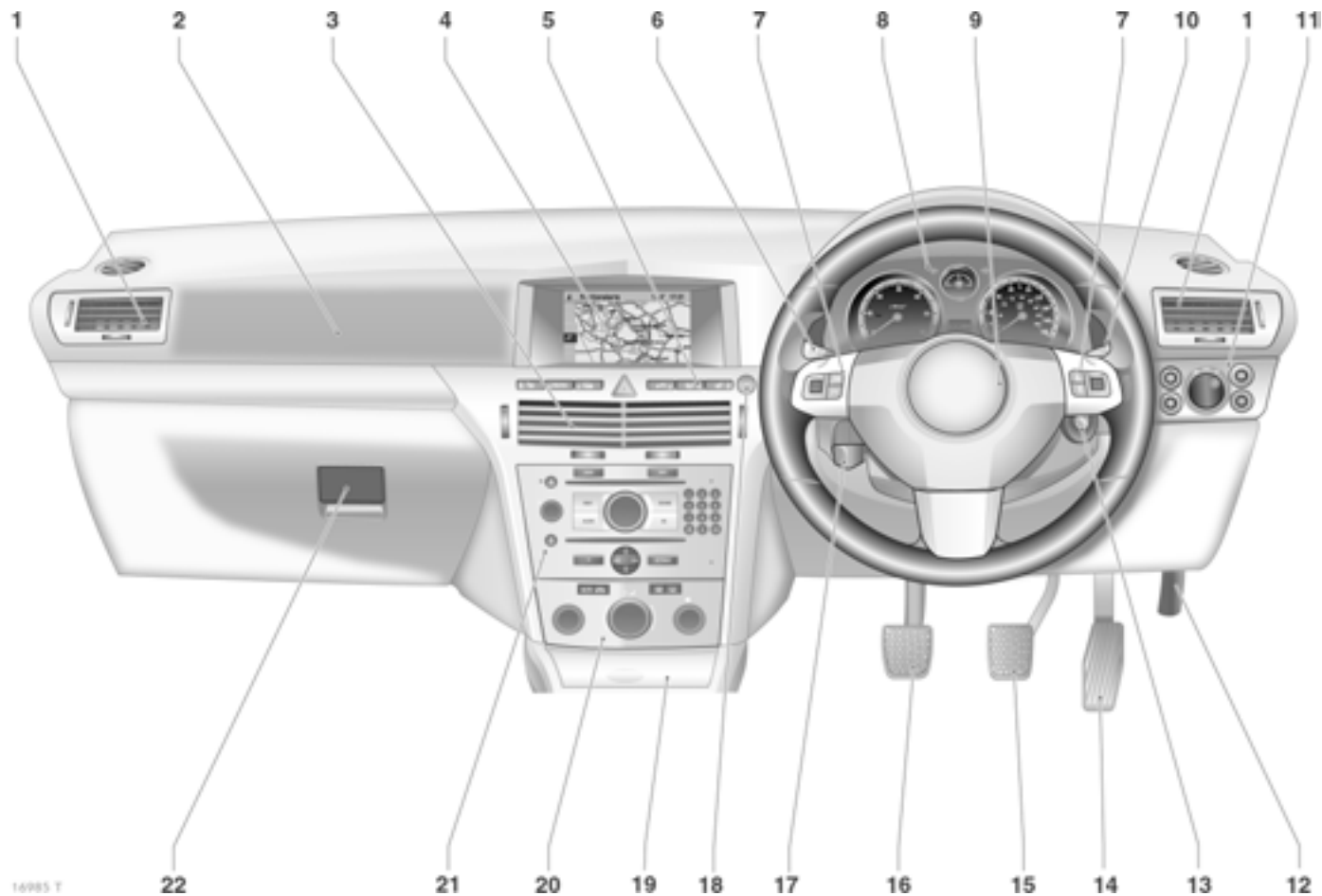







| | Page |
|--|--------|
| 1 Side air vents | 159 |
| 2 Front passenger airbag | 117 |
| 3 Centre air vents | 159 |
| 4 Central information display for time, date, outside temperature, infotainment system *, check control * | 62 |
| Trip computer * | 52, 58 |
| Climate control system * | 171 |
| 5 Heated seat (left) * | 160 |
| Deflation detection system * | 221 |
| Tyre pressure monitoring system * | 222 |
| Parking distance sensor * | 218 |
| Hazard warning lights | 16 |
| Central locking system | 76 |
| SPORT mode * | 214 |
| Heated seat (right) * | 160 |

| | Page |
|---|---------|
| 6 Turn signal lights, headlight flash Dipped beam, main beam | 15 |
| Door-to-door light function * | 140 |
| Parking lights * | 140 |
| Cruise control * | 13, 216 |
| 7 Remote control on steering wheel * | 64 |
| 8 Instruments | 36 |
| 9 Horn | 16 |
| Driver's Airbag | 117 |
| 10 Windscreen wiper, windscreen wash system, headlight wash system * and rear window wash system | 17, 18 |
| 11 Parking lights, dipped beam | 140 |
| Instrument illumination | 140 |
| Fog tail light | 137 |
| Fog lights * | 137 |
| Headlight range adjustment * | 138 |
| 12 Bonnet release lever | 86 |

| | Page |
|--|---------------|
| 13 Starter switch with immobiliser | 14 |
| and sensor panel for emergency operation Open&Start system * | 73 |
| 14 Accelerator pedal | 200, 201 |
| 15 Brake pedal | 201, 226, 227 |
| 16 Clutch pedal * | 201 |
| 17 Steering wheel adjustment | 7 |
| 18 Start/stop button * | 22, 70 |
| 19 Ashtray * | 108 |
| Cigarette lighter * | 107 |
| 20 Climate control | 157 |
| 21 Infotainment system * | 65 |
| 22 Glove compartment | 72, 110, 159 |

Control indicators

-  **Open&Start system**
see pages 36, 70.
-  **Engine oil pressure**
see page 37.
-  **Brake system, clutch system**
see pages 38, 226, 302.
-  **Airbag systems, belt tensioners, deployable anti-roll bar ***
see pages 113, 123, 132.
-  **Electronic Stability Programme (ESP^{Plus}) ***
see page 212.
-  **Seat belt ***
see pages 38, 115.



Door open
see page 39.



Alternator
see page 39.



Coolant temperature
see pages 39, 300.



Engine electronics, Gear electronics *, Immobiliser Diesel fuel filter *, fault
see pages 39, 67, 184, 190, 198, 210.



Easytronic *, start engine *
see pages 39, 179.



IDS+ Continuous Damping Control *, SPORT mode *
see pages 214, 215.



Engine oil level *
see pages 40, 298.



Exterior lights
see pages 40, 136.



Parking distance sensor *
see page 218.



Turn signal lights
see pages 15, 40.



Fuel level
see pages 40, 43, 205.



Fog lights *
see pages 41, 137.



Main beam
see pages 15, 41.



Fog tail light
see pages 41, 137.



Winter programme of automatic transmission * or Easytronic *
see pages 182, 189, 196.



SPORT mode of automatic transmission * or Easytronic *
see pages 181, 188, 195.



Seat occupancy recognition *
see page 124.



Exhaust emission *
see pages 41, 209.



Anti-lock brake system
see page 229.



Preheating system *, Diesel particle filter *
see page 42.



Deflation detection system *, Tyre pressure monitoring system *
see pages 42, 221, 224.



Adaptive headlights *, Fault
see pages 139, 142.



Cruise control *
see pages 13, 216.

Lighting

Light switch, stalk positions
see pages 14, 136,



Lights off,



Parking lights,



Dipped beam, main beam



Fog lights *
see page 137.



Fog tail light
see page 137.



Main beam
see page 15.



Turn signal lights
see page 15.



Instrument illumination
see page 140.



Courtesy lights
see page 141.











Reading lights *
see page 141.



Hazard warning lights
see page 16.

Climate control

-  **Air distribution**
see pages 161, 175,
-  to head area via adjustable air vents and to foot well,
-  to head area via adjustable air vents,
-  to windscreen,
-  to windscreen and to foot well,
-  to foot well.
-  **Air flow**
see pages 161, 175.
- A** **Automatic control of fan speed ***
see page 168.
-  **Heated rear window**
see pages 18, 160.



Air conditioning system *
see pages 19, 164, 168.



Air recirculation system *
see pages 164, 168, 176.

AUTO

Automatic mode *
see pages 19, 172.



Demisting and defrosting *
see pages 19, 163, 166, 174.



Heated seats *
see page 160.

Astra TwinTop *



Open roof
see page 149.



Close roof
see page 149.



Central switch window operation, opening
see page 144.



Central switch window operation, closing
see page 144.

Sun roof *



Sun roof:
opening or tilting – see page 147.



Sun roof:
closing – see page 147.



Sunblind:
opening – see page 147.



Sunblind:
closing – see page 147.

Windscreen wiper

Stalk positions–
see pages 17, 18



Off,



Timed interval wipe, or automatic wipe with rain sensor *,





Slow



Fast



Cruise control *

Buttons on turn signal stalk
see pages 16, 216.

-  Activate, store, accelerate,
-  Resume stored speed, decelerate,
-  Deactivate.







Information display, infotainment system

Information display
see page 46.

-  On button for date and time, see page 48,
-  Date and time setting button, See page 48.

Remote control on steering wheel *,
see pages 49, 64.

Miscellaneous

-  **Central locking system:**
locking – see page 76.
-  **Central locking system:**
unlocking – see page 76.
-  **Central locking button,**
see page 78.
-  **Vauxhall alarm system ***
see page 83.
-  **Emergency operation
Open&Start system**
see page 73.
-  **Child safety system
for rear windows ***
see page 144.



**Deflation detection system *,
Tyre pressure monitoring system ***
see pages 221, 222.



Parking distance sensor *
see page 218.



SPORT mode *
see page 214.



**Winter programme,
Easytronic *,
Automatic transmission ***
see pages 182, 189, 196.



Horn
see page 16.



First-aid kit (cushion) *
see page 252.



Warning triangle *
see page 252.

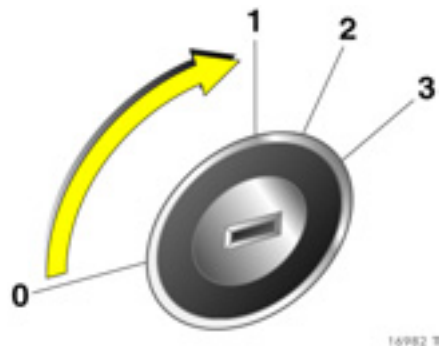

Steering wheel lock and ignition:
 Turn key to position 1.
 Move steering wheel slightly
 to release lock

Positions:

- 0 = Ignition off
- 1 = Steering released, ignition off
- 2 = Ignition on,
with diesel engine: preheating
- 3 = Start

To lock the steering wheel, switch ignition off, remove key and engage steering wheel.

► Starting – page 22,
 electronic immobiliser – page 67,
 parking the vehicle – page 24.



**Steering wheel lock and ignition
 on vehicles with Open&Start
 system *:**
 Make sure electronic key
 is in the interior reception
 range and press the Start/Stop
 button.
 Release steering column lock by
 moving the steering wheel
 slightly.

To start the vehicle, also operate brake or clutch pedal.

To lock the steering wheel, switch ignition off by pressing the Start/Stop button, open driver's door and engage steering wheel. Do not allow vehicle to move whilst doing this.

► Starting – page 22,
 electronic immobiliser – page 67,
 parking the vehicle – page 24.



Light switch:

- 0 = Off
- ☞ = Parking lights
- ☞☞ = Dipped or main beam
- AUTO = Automatic dipped beam activation *

Press button:

- ☞☞☞ = Fog lights*
- ☞☞☞ = Rear fog lights

► Lighting - Page 136,
 Headlight control indicator – Page 23.

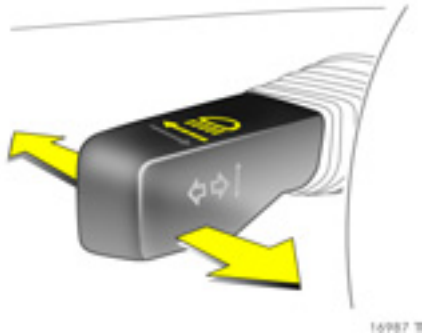

16987 T

Dipped and main beam switch:

Main beam = Push stalk forward

Dipped beam = Push stalk forward again or pull toward steering wheel

The blue control indicator  is illuminated when main beam is on.

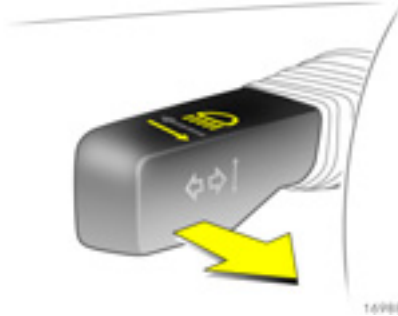

16988 T

Headlight flash:

Pull stalk towards steering wheel

The main beam is switched on while activated.

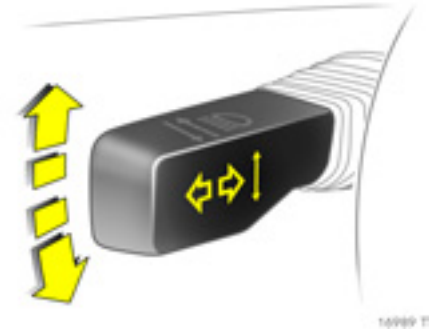

16989 T

To operate turn signal lights:

Right = Move stalk up

Left = Move stalk down

After operation, the turn signal stalk returns to its starting position.

If the stalk is moved past the resistance point, the turn signal light remains on. When the steering wheel moves back toward the straight-ahead position, the turn signal light is automatically deactivated.

Tap signal: Move stalk to resistance point and release to activate three flashes from the turn signals when changing lanes or the like.

Move the stalk to the resistance point and hold for the turn signals to flash longer.

Switch the turn signal off manually by moving the stalk slightly.

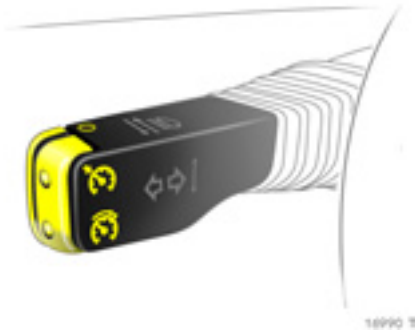

Cruise control operation *:
Press button on stalk

Switch on: briefly press button .

Switch off: briefly press button .

Resume at stored speed:
briefly press button .

► Cruise control * – page 216.



Hazard warning lights:

On = Press 

Off = Press  again

To aid location of the pushbutton, the red surface is illuminated when the ignition switched on. When the button is pressed, its control indicator flashes in time with the hazard warning lights.



Activate horn:

Press  in centre of steering wheel

► Vauxhall Full Size Airbag System
– Page 117,
Remote control on steering wheel *
– Page 64.

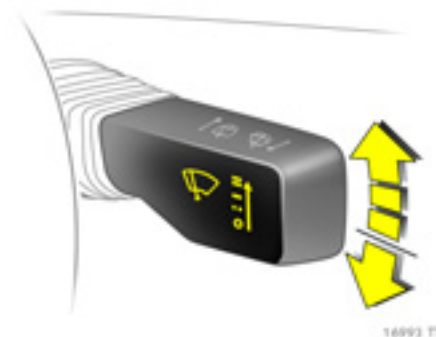

Windscreen wiper:

Move lever upward

○ = Off

-- = Timed interval wipe

— = Slow

≡ = Fast

Lever always moves back to starting position. Shift to next higher or lower level: move lever slightly.

Push lever past resistance point and hold: the windscreen wiper stages are run through; an acoustic signal sounds at position ○.

Press lever down from position ○: Single swipe.

► Further information – pages 303, 310.

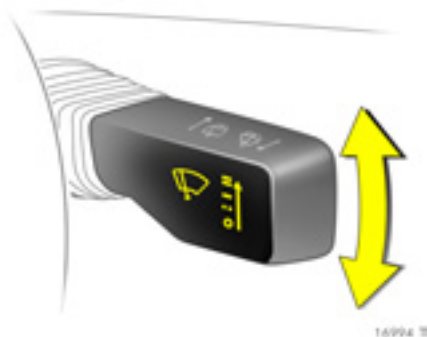

Windscreen wiper: adjustable wiper interval *

To set the wiper interval to a value between 2 and 15 seconds:

Switch on ignition.

Press lever down from position ○.

Wait the desired interval.

Set the lever to timed interval wipe --.

The interval time selected remains stored until it is next changed or the ignition is turned off.

After turning on the ignition and setting the lever to --, the interval is set to 6 seconds.

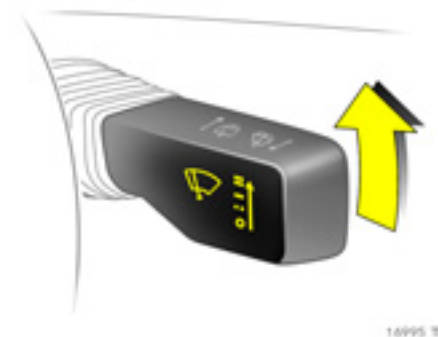

Automatic wiping with

rain sensor *:

Move stalk upward

-- = Automatic wiping
with rain sensor

Automatic wiping --: The rain sensor detects the amount of water on the windscreen and automatically regulates the windscreen wiper.

To switch off, move stalk downwards

► Further information – pages 303, 310.

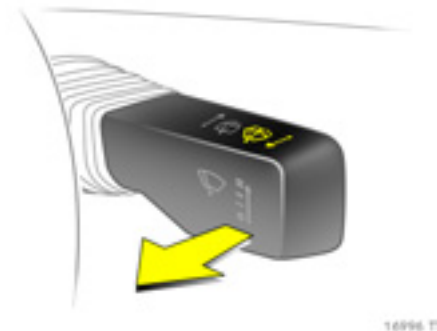

Operating windscreen and headlight wash systems *:
Pull stalk towards steering wheel

The wiper swipes for a few strokes. At low speeds, there is a single post-wash swipe.

The headlight wash system * can be operated when the lights are on. Wash fluid is sprayed on the headlights. The headlight wash system cannot be operated for 2 minutes thereafter.

On vehicles fitted with rain sensor *, keep the sensor area clean.

► Further information – pages 303, 310.

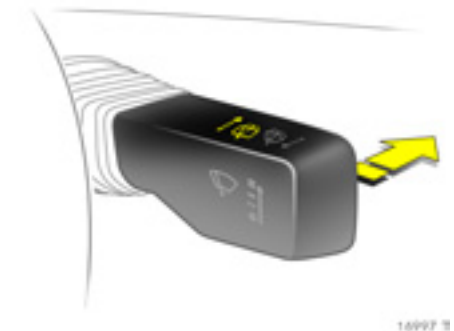

Activate rear wiper * and wash *:

- Wiper on** = **Stalk forwards**
- Wiper off** = **Stalk forwards again**
- Wash** = **Hold stalk fully forwards**

The rear window wiper swipes in timed interval mode.

The rear window wiper engages automatically when the windscreen wiper is switched on and reverse gear is engaged.

► Further information – pages 303, 310.



Heated rear window, heated exterior mirrors:





- On** = **Press**
- Off** = **Press again**

Heating operational only with engine running.

The rear window and exterior mirror heating is switched off automatically after approx. 15 minutes.

► Air conditioning– Page157,
 Heated rear window– Page160.



To demist or defrost windows:
 Set air distribution to , rotary switch for temperature and air flow clockwise;
 Air conditioning system *:
 also press button ;
 Automatic air conditioning system *:
 press button  and , turn rotary switch for temperature clockwise, air flow to A;
 Climate control system *:
 press button 

Open air vents and direct the side air vents toward the door windows.

► Climate control system * – page 157.



Set automatic mode on climate control system *:
 Press AUTO,
 preselect temperature with rotary knob,
 open air vents

► Climate control system * – page 171.

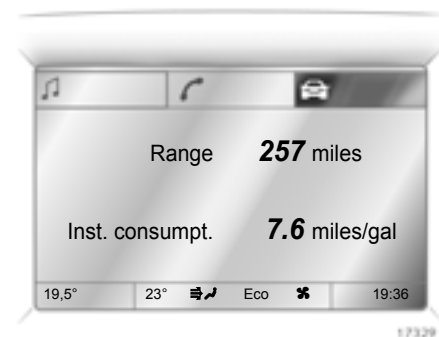

Information display *:
 provides information:

- Time,
- outside temperature,
- radio * and date,
- navigation *,
- telephone *,
- check control *,
- trip computer *,
- climate control system *.

► Information Display * – page 46.



S 11521

Manual transmission:

Reverse: with the vehicle stationary, wait 3 seconds after declutching and then pull up the button on the selector lever and engage the gear.

If the gear does not engage, set the lever in neutral, release the clutch pedal and depress again; then repeat gear selection.



S 12064

Easytronic * :

- N** = Idle
- = Drive position
- +** = higher gear
- = lower gear
- A** = Change between Automatic and Manual mode
- R** = Reverse (with selector lever lock)

The selector lever must always be moved in the appropriate direction as far as it will go. Upon release, it automatically returns to the centre position. Pay heed to the gear/mode indicator in the transmission display.

The foot brake must be depressed when starting.

► Easytronic * – Page 178.



S 12065

Automatic transmission * :

- P** = Park
- R** = Reverse
- N** = Neutral (idle)
- D** = Automatic gear selection
- 3** = 1st to 3rd gear
- 2** = 1st and 2nd gear
- 1** = 1st gear

Starting only possible in **P** or **N**. To move from **P**, switch on ignition, depress foot brake and press button on selector lever.

Press button on selector lever to engage **P** or **R**.

P: Only with vehicle stationary, first apply hand brake

R: Only with vehicle stationary

► Automatic transmission * – page 186.



S 12066

Automatic transmission with ActiveSelect*:

P = Park

R = Reverse gear

N = Neutral (idle)

D = Automatic gear selection

Selector lever in D to left:

Manual mode

+ = Higher gear or stage

- = Lower gear or stage

P or **N** must be engaged when starting.

To move from **P** or **N**, switch on ignition, depress foot brake and press button on selector lever.

To select **P** or **R**, press button on selector lever.

P: Only with vehicle stationary, first apply hand brake

R: Only with vehicle stationary

► Automatic transmission with *
– page 192.



17004 II

Exhaust gases are poisonous

Exhaust gases contain carbon monoxide, which is extremely poisonous but is odourless and colourless.

Therefore never inhale exhaust gases, and never run the engine in an enclosed space.

Avoid driving with an open luggage compartment. Otherwise, exhaust gases could penetrate the interior.

► Catalytic converter, exhaust – Page 207

Before starting off, check:

- Tyre pressure and tyre condition – pages 232, 333.
- Engine oil level and fluid levels in engine compartment – see pages 297 to 305.
- All windows, mirrors, exterior lighting and number plates are free from dirt, snow and ice and operational.
- Do not place any objects in front of the rear window, on the instrument panel or in the area in which the airbags inflate.
- Seats, seat belts and mirrors are correctly adjusted.
- Check brakes.

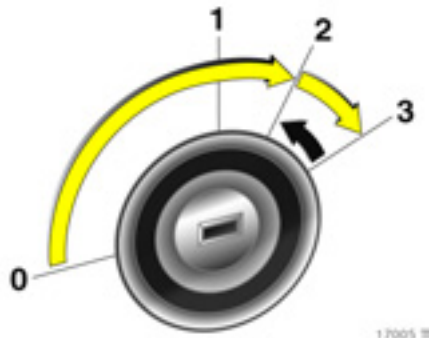
**To start engine:**

Operate clutch and brake, automatic transmission * in P or N,

Easytronic * : Depress brake, do not accelerate,

Petrol engine: Turn key to 3;

Diesel engine: Turn key to 2, when control indicator ∞ goes out¹⁾

turn key to 3;

release key

once engine is running

Before restarting or switching off the engine, turn key back to 0.

To switch on the ignition, only turn key to 2.

- Electronic immobiliser – Page 67,
- Diesel fuel system – Page 247.

**To start engine**

with Open&Start system *:
The electronic key must be inside the car,

operate clutch or brake, Automatic transmission * in P or N,

Easytronic * : Depress brake, do not accelerate,

Petrol engine: Press button;

Diesel engine: Briefly press button; when control indicator ∞ goes out¹⁾ press button again for 1 second;

release button once engine is running

Press button again to repeat the starting procedure or switch off the engine.

¹⁾ Preheating system switches on only if outside temperature is low.

To turn on the ignition, do not press the brake or clutch pedal; just press the button briefly.

Do not start unless vehicle is stationary.

► Open&Start-System * – Page 70,
Electronic immobilizer – Page 67,
Diesel fuel system – Page 247.

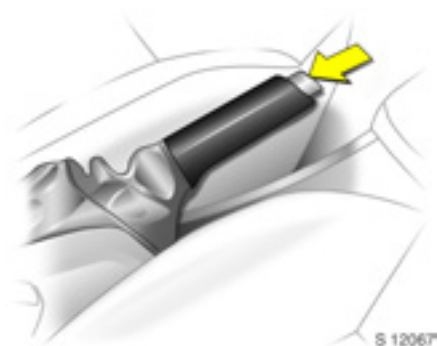

Releasing the hand brake: Raise lever slightly, Press lock button, Lower lever fully

To reduce operating forces, depress foot brake at the same time.

And now "Have a good journey!"

Drive carefully, economically and with the environment in mind. While driving, do not do anything that could distract you.

Warning buzzers

When starting the engine or whilst driving:

- if the electronic key of the Open&Start system* is not present or is not recognised,
- if seat belt is not fastened *,
- if a door or the tailgate is ajar,
- once you have reached a certain speed if the hand brake is applied *,
- if a specified maximum speed is exceeded *.
- for Easytronic * - if **A**, **M** or **R** is selected while the engine is running and the driver's door is opened but the foot brake is not depressed.

When the vehicle is parked and the driver's door is opened:

- when the key is in the starter switch *,
- with parking lights or dipped beam on,
- with Open&Start system * and automatic transmission if the selector lever is not in **P**
- with Easytronic * – if the hand brake is not applied and no gear is engaged when the engine is off.

Indicator and warning buzzers for Astra TwinTop ✱:

- Indicator buzzer upon completed opening or closing of the convertible hardtop.
- Indicator buzzer upon completed raising or lowering of the electric luggage compartment loading aid.
- Gong tone if the boot lid is not closed during roof operation.
- Gong tone if the boot lid is not fully opening during operation of the luggage compartment loading aid.
- Gong tone during roof operation if vehicle speed exceeds 20 mph (30 km/h).
- Gong tone when vehicle speed exceeds 20 mph (30 km/h) if the roof is not fully open or closed.
- Three gong tones during roof or loading aid operation if the luggage compartment blind is not attached.
- Three gong tones during roof operation if outside temperature is below -20°C , vehicle battery voltage is too low or the system is overloaded.

- Continuous warning buzzer during roof operation if the anti-roll bars ✱ have been triggered.
- Continuous warning buzzer starting one minute before the end of the 9-minute standby time with the roof in an intermediate position.
- Continuous warning buzzer starting one minute before the end of the 9-minute standby time with the loading aid in a raised position.
- Persistent warning buzzer when closing the luggage compartment lid, if the lowering process of the electric load aid is not complete or has been interrupted.

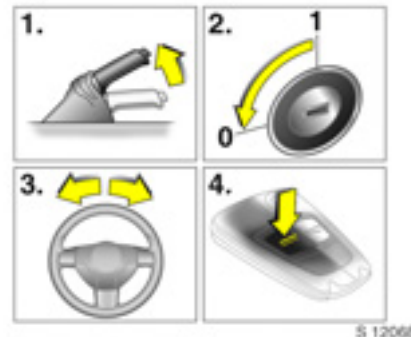

**Parking the vehicle:
apply hand brake firmly,
engine off,
lock steering wheel,
lock vehicle**

To lock, press  button or with Open&Start system ✱ touch sensor in one of the front door handles.

With Open&Start system ✱, the driver's door must be opened to lock the steering wheel.

To activate the anti-theft locking system * and the Vauxhall alarm system * press button  twice or with Open&Start system * touch sensor in one of the front door handles twice.

► Further information – pages 67, 200, Open&Start system – page 70, radio remote control – page 68, central locking system – page 76, Vauxhall alarm system * – page 83, vehicle decommissioning – page 307, TwinTop roof operation * – page 148.

Advice when parking:

- Do not park the vehicle on an easy flammable surface. The high temperature of the exhaust system could ignite the surface.
- Always apply the hand brake firmly. Apply the hand brake as firmly as possible on uphill or downhill slopes. To reduce operating forces, depress foot brake at the same time.
- Close the windows and sun roof * or TwinTop.
- For manual transmission, select first or reverse; for automatic transmission * move selector lever to **P**, for Easytronic * select first or reverse before switching off the ignition (note gear display, see pages 178, 186, 193).
- On vehicles with automatic transmission * the key can only be withdrawn when the selector lever is in position **P**. On the Open&Start system *, "P" flashes in the gear display for a few seconds if **P** is not engaged or the handbrake is not applied.

- On vehicles with Easytronic * control indicator  flashes for a few seconds after the ignition is switched off if the hand brake has not been applied – page 184.
- With the Open&Start system * the engine can only be switched off when the car is stationary.
- Turn steering wheel until the steering lock perceptibly engages (theft protection) after first withdrawing the ignition key; for Open&Start-System * switch off ignition and open driver's door.
- The engine cooling fans may run after the engine has been switched off see page 297.
- Further information – pages 306, 307.



Service work, Maintenance

We recommend that you entrust all work to your Vauxhall Authorised Repairer, who can provide you with reliable service and correctly perform all work according to factory instructions.

► Vauxhall Service – page 294,
service interval display – pages 44, 296.

Genuine Vauxhall Parts and Accessories

We recommend that you use "Genuine Vauxhall Parts and Accessories" and conversion parts expressly approved for your vehicle type. These parts have undergone special tests to establish their reliability, safety and specific suitability for Vauxhall vehicles. Despite continuous market monitoring, we cannot assess or guarantee these attributes for other products, even if they have been granted approval by the relevant authorities or in some other form.

"Genuine Vauxhall Parts and Accessories" and conversion parts approved by Vauxhall can be obtained from your Vauxhall Authorised Repairer, who can provide comprehensive advice about permissible technical changes and ensure that the part is installed correctly.

Warning

Carry out regularly the checks recommended in the individual sections of this Owner's Manual.

Ensure that your vehicle is serviced at the service intervals specified in the Service Booklet. We recommend that you entrust this work to your Vauxhall Authorised Repairer.

Have faults remedied without delay! Consult a workshop. We recommend your Vauxhall Authorised Repairer. If necessary, interrupt your journey.

► Maintenance – page 296.

That was the most important information for your first drive in your Astra in brief.

The other pages of this chapter contain a summary of the interesting functions in your vehicle.

The remaining chapters of the Owner's Manual contain important information on operation, safety and maintenance as well as a complete index.

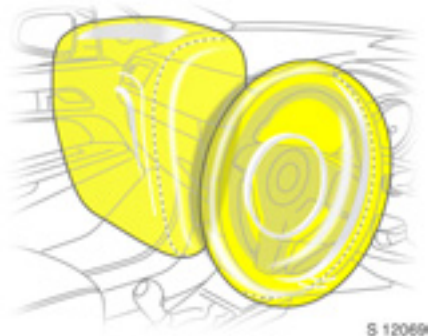

Vauxhall Full Size airbag system

The Vauxhall Full Size airbag system comprises several individual systems.

Front airbag system

The front airbag system will be triggered in the event of a serious accident involving a frontal impact and forms safety cushions for the driver and front passenger. The forward movement of the driver and front passenger is checked and the risk of injuries to the upper body and head thereby substantially reduced.

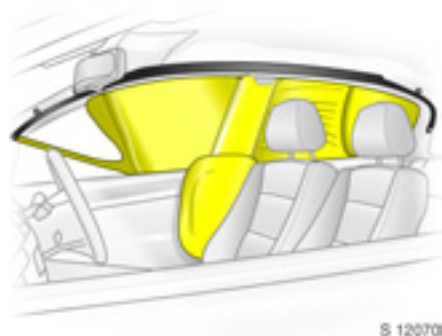

Side airbag system *

The side airbag is triggered in the event of a side-on collision to form a safety cushion for the driver or front passenger in the respective door area. This substantially reduces the risk of injury to the upper body and pelvis.

Curtain airbag system *

The curtain airbag system triggers in case of a side-on collision and provides a safety barrier in the head area on the respective side of the vehicle. This reduces the risk of injury to the head considerably in case of a side-on collision.

► Vauxhall Full Size Airbag System – Page 117.



Active head restraints * on front seats

In the event of a rear-end impact, the active head restraints tilt forward a little. The head is more effectively supported by the head restraint and the danger of injuries caused by hyperextension in the area of the cervical vertebrae is reduced.

Active head restraints are identified by the lettering **ACTIVE** on the head restraint guide sleeves.

► Headrests – page 88.



17012 T

Operating menus in the information display *

Menu options are selected via menu using the buttons/four-way button or the multifunction button of the Infotainment system * or the left adjustment wheel/buttons * on the steering wheel. The respective menu options are shown on the display.

Selection using four-way button * press four-way button at top, bottom, left or right.



17013 T

Selection using multifunction button * rotate and press multifunction button.

To exit a menu, turn the multifunction button left or right to **Return** or **Main** and select.



17014 T

Selection with left adjuster wheel on steering wheel * turn adjuster wheel and press.

► Information Display – page 46.

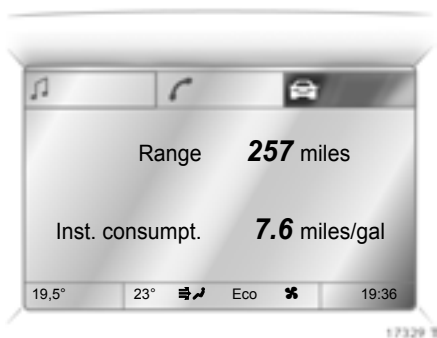

Trip computer *

The trip computers provide information on driving data, which is continually recorded and evaluated electronically.

Functions:

- Range
- Instantaneous consumption
- Distance travelled
- Average speed
- Effective consumption
- Average consumption
- Stop watch
- Tyre pressure *

► Trip computer * – Pages 52, 58.

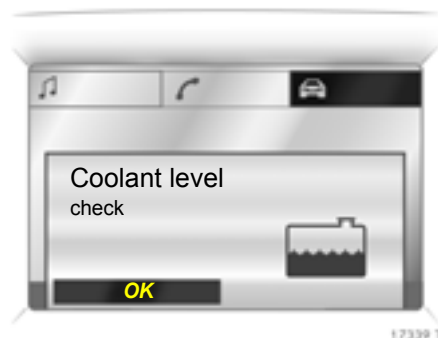

Check control *

The check control software monitors

- Fluid levels
 - Tyre pressure *
 - Radio remote control battery
 - Vauxhall alarm system *
 - Important exterior lighting lights, including cables and fuses.
- Check Control * – Page 62.

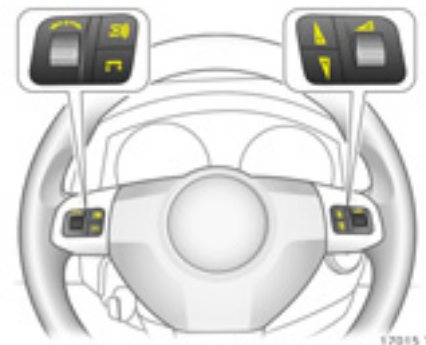

Remote control on steering wheel *

The functions of the infotainment system * and the information display can be operated with the remote control on the steering wheel.

Further information is available in the infotainment system operating instructions.

► Remote control on steering wheel * – Page 64, Infotainment System – Page 65.



17026 1

Twin Audio *

Twin Audio allows rear seat occupants the choice between the audio source played on the infotainment system or a separate audio source.

Only an audio source that is not currently active on the infotainment system can be controlled using Twin Audio.

Two headphone connections are available, with separate volume controls.

Further information is available in the infotainment system operating instructions.

► Twin Audio * – Page 64.



S 12071

Open&Start system with electronic key and radio remove control *

The Open&Start system allows the vehicle to be locked and unlocked, including anti-theft locking system * and the Vauxhall alarm system * without a mechanical key and the engine to be started and stopped using a start/stop button. All the driver has to do is carry the electronic key around with him.

► Open&Start System * – Page 70.



17203 1

Parking distance sensor *

When reverse gear is selected, the parking distance sensor switches itself on automatically.

The parking distance sensor can also be activated at speeds of less than 15 mph (25 km/h) by pressing the P button on the instrument panel.

If the vehicle approaches an obstacle when reversing, a series of signals can be heard in the vehicle interior. The interval between the signals becomes shorter as the distance is reduced. If the distance is less than 30 cm, the signal will be continuous.

► Parking distance sensor * – Page 218.



Sport mode *

To activate

Press button **SPORT**.

SPORT mode is used to change damping *,steering *, throttle application and the shift point for Easytronic * and automatic transmission * while driving.

Damping and steering become more direct and provide better contact with the road surface. The engine reacts more quickly to accelerator movements.

With Easytronic * and automatic transmission *, the shift times are shortened and shifting takes place at higher revs (not with cruise control enabled *).

► Sport mode * – Page 214.



Tyre pressure loss monitoring system (DDS = Deflation Detection System) *

The deflation detection system continuously monitors the speed of all wheels while driving. If a tyre loses pressure, it grows smaller and therefore rotates more quickly than the other wheels. If the system detects a difference in speed, the control indicator (⚠) illuminates in red.



After tyre pressure is corrected or a tyre or wheel is changed, the system must be initialised by pressing the DDS button.

► Tyre deflation detection system *
– Page 221.

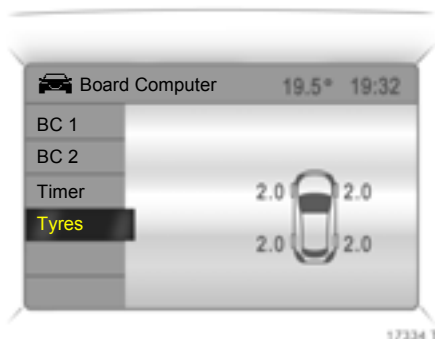

Tyre pressure monitoring system *

The tyre pressure monitoring system continually checks the pressure and speed of all four wheels while driving.

A pressure sensor is installed in each wheel. The inflation pressures of the individual wheels are transmitted to a controller, where they are compared.

The current tyre pressures can be displayed on the graphical information display or the colour information display *.

Deviating tyre pressures are displayed in the form of messages on the information display whilst driving.

► Tyre pressure monitoring system *
– Page 221.

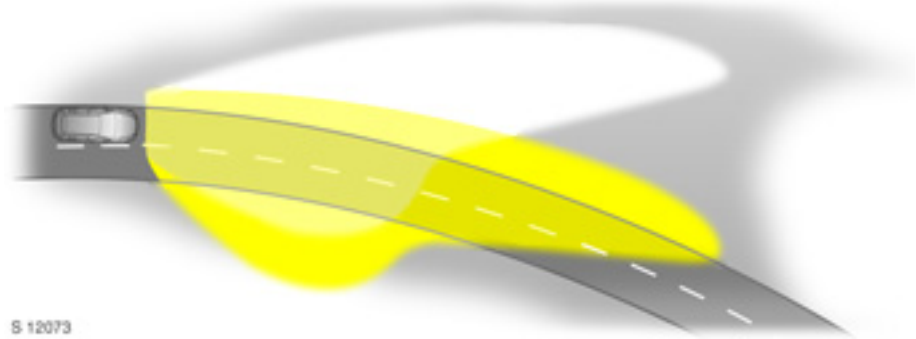

S 12073

Adaptive Forward Lighting (AFL) *

improves lighting in curves (curve lighting) on vehicles with Bi-Xenon headlight system.

Curve lighting

The Xenon light beam pivots based on steering wheel position and speed (from approx. 6 mph /10 km/h).

Motorway lighting

At higher speeds and continuous straight ahead travel, the dipped beam automatically raises slightly, thereby increasing headlight range.

► Adaptive driving lights * – Page 139.

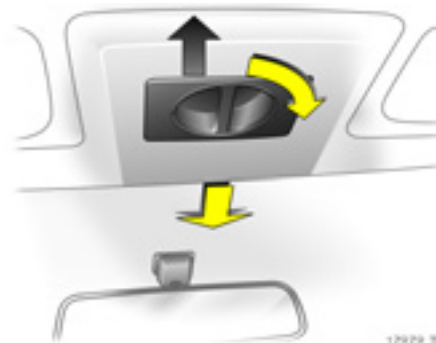

Panoramic windscreen *

To open:

Turn the handle to the right and move the roof lining rearward to a suitable position.

To close:

Move the roof lining forward to a suitable position. When moved all the way forward, the roof lining engages in position.

▶ Panoramic roof * – Page 146.

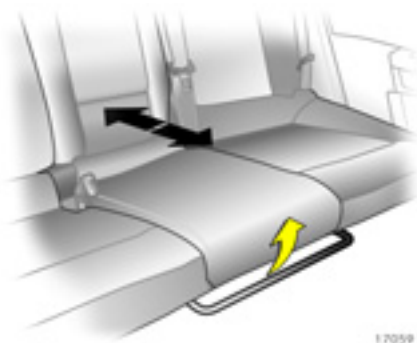

Adjusting the rear row of seats *

- Pull the handle below the seat
 - Slide the seat bench to the desired position
 - Release the handle and engage the seat bench
- ▶ Adjusting the rear row of seats * –Page 90.

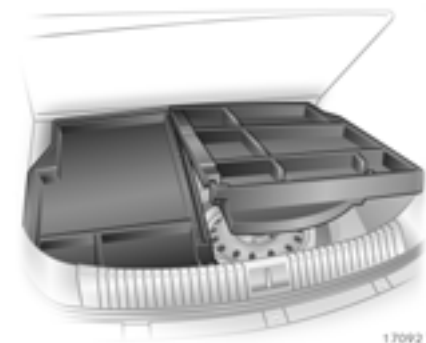

Cargo box *

Collapsible box to divide the luggage compartment.

The cargo box may only be loaded when the backrests are engaged in an upright position.

When removing, start with the right half.

▶ Cargo Box * – Page 103.

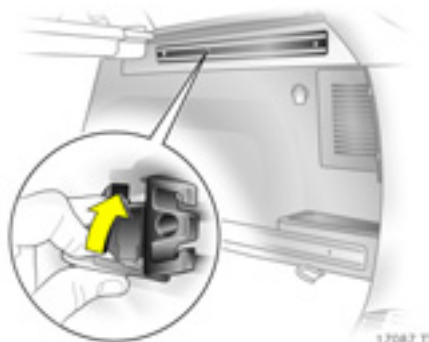

FlexOrganizer *

The side walls contain retaining strips, where various components can be attached to divide the luggage compartment or fasten loads.

The system consists of

- adapters
- variable partition net
- mesh pockets for the side walls
- hooks in the luggage compartment

► FlexOrganizer * – Page 102.

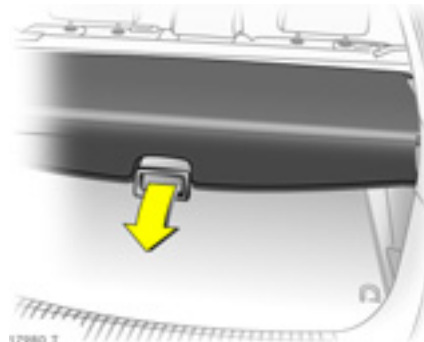

Luggage compartment cover, Estate

To open:

Press handle on luggage compartment cover down. The cover automatically unrolls.

► Luggage compartment cover *
– Page 98.



Astra TwinTop

With TwinTop, a convertible hardtop, Astra unites the benefits of a coupe with those of a convertible.

To optimise safety, the Astra TwinTop is equipped with a rollover protection system with reinforced windscreen frame and the choice of fixed or deployable anti-roll bars in addition to the front and side airbag systems.

The roof is operated with the buttons on the roof console above the mirror or with the remote control.

To improve luggage compartment accessibility, the electric loading aid makes it possible to raise the open roof when it is stowed in the luggage compartment.

► TwinTop – see page 148.

Instruments

Control indicators 36
 Instrument display 43
 Information display 46
 Radio reception *..... 64
 Remote control on steering wheel *.. 64
 Twin Audio * 64
 Mobile telephones and radio
 equipment *..... 65
 Infotainment system *..... 65



18444 7

Control indicators

The control indicators described here are not present in all vehicles. The description applies to all instrument versions.

The control indicator colours mean:

- Red Danger, important reminder,
- Yellow Warning, note, fault,
- Green Engagement confirmation,
- Blue Engagement confirmation.



Open&Start system *

Control indicator lights or flashes yellow.

If it flashes

System has not detected electronic key in vehicle interior. The reasons for this may be:

- The electronic key is in the wrong location in the vehicle interior (do not put key in luggage compartment or in front of information display), or the electronic key is not in the vehicle interior, or influence from an external interference source (radio masts, interfering transmitters in the vicinity).
or -
- Electronic key failure, for emergency operation – page 73.

If the battery in the electronic key needs changing, **InSP3** appears in the service display or, in vehicles with check control *, by an appropriate message in the information display – pages 44, 74.

lights

Fault in Open&Start system.

Lock or unlock vehicle using remote control or emergency key if necessary – page 80, or attempt to use the spare key.

Emergency operation – page 81.

If  illuminates, this can also mean that the steering wheel lock is still locked: move steering wheel to and fro a little and press Start/Stop button again.

If  illuminates whilst driving a system error has occurred that may eventually lead to a complete failure.

If  illuminates or flashes: The Start/Stop button must be held depressed somewhat longer to switch off the ignition. It is possible that the vehicle will not start during the next start attempt.

If  continues to flash or remains illuminated, consult a workshop immediately. We recommend your Vauxhall Authorised Repairer.

**Engine oil pressure**

Control indicator lights red.

It illuminates when the ignition is switched on and goes out shortly after the engine starts.

Illuminates when the engine is running
Engine lubrication may be interrupted. This may result in damage to the engine and/or locking of the drive wheels:

1. Depress clutch.
2. Shift manual transmission or Easytronic * into neutral; for automatic transmission *, set selector lever to **N**.
3. Move out of the flow of traffic as quickly as possible without impeding other vehicles.
4. Switch off ignition.

 **Warning**

When the engine is off, considerably more force is needed to brake and steer.

Do not remove key until vehicle has come to a standstill, otherwise the steering column lock could engage unexpectedly.

Consult a workshop. We recommend your Vauxhall Authorised Repairer.



(i)
**Brake system,
 clutch system**

Control indicator lights or flashes red.

It illuminates after the ignition is turned on, when the hand brake is applied or if the brake or clutch fluid level is too low. For further information – pages 226, 302.

For vehicles with Easytronic *****, the control indicator flashes for a few seconds when the ignition is turned off if the hand brake is not applied.

⚠ Warning

If it illuminates when the hand brake is not applied: Stop the vehicle; interrupt your journey immediately. Consult a workshop. We recommend your Vauxhall Authorised Repairer.



Airbag systems ***,
 belt tensioners *****,
 deployable anti-roll bars *******
 Control indicator lights red.

Illuminates when the engine is running
 Fault in airbag system, belt tensioners or roll-over protection, – pages 113, 123, 132.



**Electronic
 Stability Programme (ESP [®]Plus) *******
 Control indicator flashes or lights yellow.

Flashing during driving
 System actively engaged,
 – page 212, 213.

Illuminates while driving
 System switched off or fault in system for Electronic Stability Program, – page 213.



Seat belt *****
 Control indicator lights or flashes red.

It lights after the ignition is turned on until the seat belt is fastened. When driving begins, the control indicator flashes. Apply seat belt – page 115.

**Door open**

Control indicator lights red.

It is illuminated when a door or the luggage compartment is open.

**Alternator**

Control indicator lights red.

It illuminates when the ignition is switched on and goes out shortly after the engine starts.

Illuminates when the engine is running

Stop, switch engine off. Battery is not charged. Engine cooling may not be operating. With a diesel engine the brake servo unit may stop operating. Consult a workshop. We recommend your Vauxhall Authorised Repairer.

**Coolant temperature**

Control indicator lights red.

Illuminates when the engine is running

Stop and switch off engine. Coolant temperature too high: Danger of engine damage. Check coolant level immediately – page 300.

**Engine electronics, transmission electronics *, immobiliser, diesel fuel filter ***

Control indicator lights or flashes yellow.

It illuminates for a few seconds when the ignition is switched on.

Illuminates when the engine is running

Fault in engine electronics or transmission electronics. Electronics switch to emergency running programme, fuel consumption may increase and driveability of the vehicle may be impaired – page 210. Consult a workshop immediately. We recommend your Vauxhall Authorised Repairer.

Illuminated together with InSP4 in the service display: Have the diesel fuel filter drained of water – page 300.

Flashes when the ignition is on

Fault in the electronic immobiliser system; the engine cannot be started – page 67.

**Easytronic *, start engine**

Control indicator lights yellow.

It illuminates if the foot brake is not operated. The indicator goes off as soon as the foot brake is operated. The engine can only be started with the foot brake operated, page 179.

IDS+**Interactive Driving System *, Continuous Damping Control (CDC) *, SPORT mode ***

Control indicator lights yellow.

It illuminates for a few seconds when the ignition is switched on.

Illuminates while driving

System fault. Consult a workshop. We recommend your Vauxhall Authorised Repairer.

IDS+ – page 212, CDC – page 214, SPORT mode – page 214.



18444 7



Engine oil level *

Control indicator lights yellow.

The engine oil level is checked ¹⁾ automatically.

Illuminates when the engine is running

Engine oil level too low. Check engine oil level and top up engine oil if necessary, – page 298.

¹⁾ Not on Z 14 XEP or Z 20 LEH engine. Sales designation – see page 314.



Exterior lights

Control indicator lights green.

It is illuminated when the exterior lights are on – see page 136.



Parking distance sensor * □

Control indicator lights yellow.

System fault. Consult a workshop. We recommend your Vauxhall Authorised Repairer.

Parking distance sensor – page 218.



Turn signal lights

Control indicator flashes green.

The corresponding control indicator flashes on the side of the direction indicators selected.

Both control indicators flash with the hazard warning lights on.

Fast flashing: failure of a direction indicator light or associated fuse, failure of direction indicator light on trailer *.

Change bulbs – page 274.

Fuses – page 266.



Fuel level

Control indicator lights or flashes yellow.

lights

Low fuel level, fuel gauge in reserve area.

Flashing

Fuel supply exhausted, refuel immediately.

Never let the tank run dry!

Erratic fuel supply can cause catalytic converter to overheat, – page 207.

Diesel engines: If the tank is run dry, bleed the fuel system as described on page 247.

**Fog lights ***

Control indicator lights green.

It is illuminated when the fog lights are on – page 137.

**Main beam**

Control indicator lights blue.

It is illuminated when main beam is on and during headlight flash – page 15.

**Fog tail light**

Control indicator lights yellow.

It is illuminated when the rear fog lights are on – page 137.

**Winter programme of automatic transmission * or Easytronic ***

Symbol lights in gear display with Winter programme engaged.

Further information – pages 182, 189, 196.

**SPORT mode of automatic transmission * or Easytronic ***

Symbol lights in gear display with Sport programme engaged.

Further information – pages 181, 188, 195.

**Seat occupancy recognition * –**

Symbol lights or flashes in kilometre display.

lights

Seat occupancy recognition has detected a child restraint system with transponders. Airbag systems for the passenger are deactivated – page 124.

Flashing : Fault in system or child seat with transponder not correctly fitted – page 124.

**Exhaust emission ***

Control indicator lights or flashes yellow.

It illuminates when the ignition is switched on and goes out shortly after the engine starts.

Illuminates when the engine is running

Fault in emission control system. The permitted emission limits may be exceeded. Consult a workshop. We recommend your Vauxhall Authorised Repairer.

If it flashes when the engine is running:

Fault that can lead to destruction of the catalytic converter is indicated – page 209. Consult a workshop immediately. We recommend your Vauxhall Authorised Repairer.

**Anti-lock brake system (ABS) ***

Control indicator lights red.

Illuminates while driving

Fault in antilock braking system – page 228.



 **Preheating system ***,
Diesel particle filter *
Control indicator lights or flashes yellow.

lights
Preheating system active, switches on only if outside temperature is low.

Flashing (in vehicles with diesel particle filter)
Diesel particle filters require cleaning. As soon as the road and traffic situation permits, briefly increase speed to greater than 25 mph (40 km/h). The control indicator goes off as soon as cleaning is complete.

 **Deflation detection system ***, **tyre pressure monitoring system ***
Control indicator lights red
Tyre pressure loss – page 221.
Control indicator lights yellow
Fault in system – pages 221, 222. Consult a workshop. We recommend your Vauxhall Authorised Repairer.

 **Adaptive Forward Lighting ***
(AFL)
Control indicator lights or flashes yellow.

lights
System fault. Consult a workshop. We recommend your Vauxhall Authorised Repairer.
Flashing
System converted to symmetrical dipped beam.

AFL – page 139.

 **Cruise control ***
Control indicator lights green.
It is illuminated when the system is on – page 216.



17021 F

Instrument display

On some versions, the pointer of the tachometer, speedometer and fuel gauge briefly moves to its end position when the ignition is switched on.

Tachometer

Indicates engine speed.

Warning zone: Maximum permissible engine speed exceeded; danger to engine.

Speedometer
Speed display.



17023 F

Fuel gauge

Pointer in left zone or  illuminated

= Reserve area

Pointer in left zone or  flashing

= Fill up – page 205

Never run the tank dry!

Diesel engines: If the tank is run dry, bleed the fuel system as described on page 247.

Because of the fuel remaining in the tank, the amount of fuel required to fill the tank may be less than the specified tank capacity.



Odometer display

Top line:

Trip odometer or clock display *

To switch between the trip odometer and the clock display *, press reset knob briefly, see previous page.

Trip odometer

Display of miles covered since reset.

To reset, hold reset button down for around one second with the ignition turned on, see previous page.

If the clock display is activated, first switch to trip odometer.

Time display *

To adjust the time, setting knob in instrument:

Press for approx. 2 seconds:

Hours flash

Press briefly

Set hours

Press for approx. 2 seconds

Minutes flash

Press briefly

Set minutes

Press for approx. 2 seconds

Clock is started.

Bottom line:

Odometer

Records the miles counted.



Service Display

InSP Service interval display.
Shows remaining distance until next service.
Further information – page 296.

InSP2 Bulb failure * – page 274.

InSP3 Low battery voltage for remote control or electronic key for Open&Start System
*, - pages 69, 74.

InSP4 Water in diesel fuel filter *.
Contact your workshop.
We recommend your Vauxhall Authorised Repairer.

On vehicles with check control *, a message is shown on the display instead of **InSP2** and **InSP3**.

ESPoff Electronic Stability Program * deactivated – see page 212.

ESP on Electronic Stability Program * activated – see page 212.



Transmission display *

Display of gear selected on automatic transmissions * or current gear or mode for Easytronic *:

P Park position of automatic transmission.

R Reverse gear.

N Neutral or idling position.

A Automatic mode, Easytronic.

M Manual mode, Easytronic.

D Automatic mode, automatic transmission.

1-4 Current gear, automatic transmission.

1-5 or
1-6 * current gear, Easytronic, manual mode.

For Easytronic *, the display flashes for a few seconds if **A**, **M** or **R** is selected when the engine is running but the foot brake is not depressed.



Information display

Triple information display

Display of time, outside temperature and date/infotainment system (when it is on).

When the ignition is off, the time, date and outside temperature can be presented for 15 seconds by briefly pressing one of the two buttons below the display.

An **F** in the display indicates a fault. Have the cause of the fault remedied. We recommend that you consult your Vauxhall Authorised Repairer.



Board information display *

Display of time, outside temperature and date/infotainment system (when it is on).

An **F** in the display indicates a fault. Have the cause of the fault remedied. We recommend that you consult your Vauxhall Authorised Repairer.

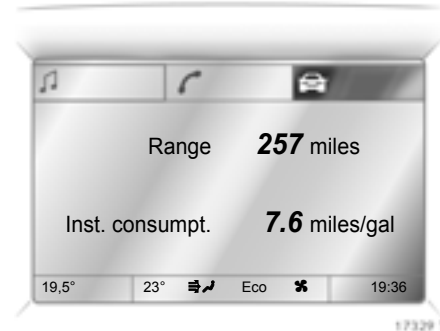

Graphical information display *, Colour information display *

Display of time, outside temperature, date/infotainment system (when it is on) and climate control system *.

The graphical information display presents the information in monochrome. The colour information display presents the information in colour.

The type of information and how it is displayed depends on the equipment of the vehicle and the settings of the trip computer *, climate control system * and infotainment system *.

Some information appears in the display in an abbreviated form.

Climate control system – page 171.

Infotainment system – see infotainment system instructions.

An **F** in the display indicates a fault. Have the cause of the fault remedied. We recommend that you consult your Vauxhall Authorised Repairer.



Outside temperature

A fall in temperature is indicated immediately and a rise in temperature after a time delay.

If outside temperature drops to 3 °C, the symbol * illuminates in the triple information display or the board information display * as a warning for icy road surfaces. * remains illuminated until temperatures reach at least 5 °C.



In vehicles with graphical information display * or colour information display *, a warning message appears the display as a warning for icy road surfaces. There is no message below -5 °C.

Warning

Caution: The road surface may already be icy even though the display indicates a few degrees above 0 °C.

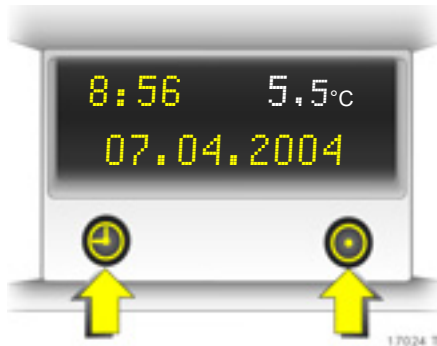

Triple information display

Set date and time

Infotainment system off: press and below the display as follows:

Press for approx. 2 seconds:

Day flashes

: Set day

: Month flashes

: Set month

: Year flashes

: Set year

: Hours flash

: Set hours

: Minutes flash

: Set minutes

: Clock is started.

Correcting time *

Some RDS transmitters do not send a correct time signal. If the incorrect time is continually displayed, switch off automatic time synchronisation * and set the time manually - see next column.

The automatic setting is indicated by in the display.

Deactivating/activating automatic time synchronisation: infotainment system off, press and below the display:

Hold down for approx. 2 sec., clock display is now in setting mode.

Press twice (until year flashes).

Press and hold down for approx. 3 seconds until flashes in display * and "RDS TIME" appears (years flash during this time).

Press , display indicates:

RDS TIME 0 = Off.

Press , display indicates:

RDS TIME 1 = On.

Press three times.

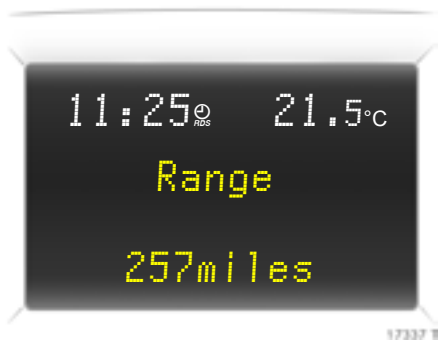

Board information display *, Selecting functions

Functions and settings of some equipment * can be accessed via the board information display.

This is done via the menus and the buttons/four-way button on the infotainment system * or with the left adjuster wheel * on the steering wheel. The relevant menu options are then shown in order on the display.



Select options via the menus and with the buttons/four-way button on the infotainment system *.



Depending on the equipment level of the vehicle, menu options can be selected with the left adjuster wheel * on the steering wheel. The relevant menu options are then shown in order on the display.

If check control * issues a warning message, the display is blocked from other functions. Acknowledge the message by pressing the four-way button to the right or left or by pressing the left adjuster wheel * on the steering wheel. If there are several warning messages, acknowledge them one at a time.

System settings – page 50.

Trip computer – page 52.



Board information display *, System settings

Press the **Settings** button of the infotainment system. Menu item **Audio** or **System** will appear.

Press the lower button of the four-way button to reach menu item **System**. After pressing the right-hand part of the four-way button, the first function of the **System** menu is shown.

Some information appears in the display in an abbreviated form.

The functions are displayed in the following order:

- Time synchronisation
- Time, setting hours
- Time, setting minutes
- Date, setting day
- Date, setting month
- Date, setting year
- Ignition logic
- Language selection
- Setting units of measure

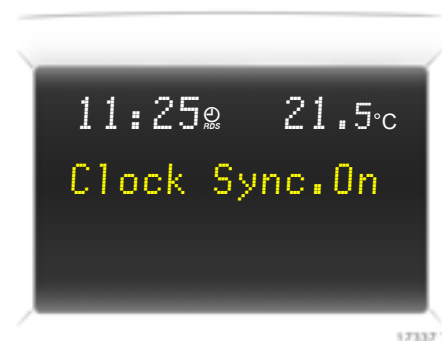

Correcting time *

Some RDS transmitters do not send a correct time signal. If the incorrect time is continually displayed, deactivate automatic time synchronisation * and set the time manually - see next page.

The automatic setting is indicated by  in the display.

To correct time with the help of RDS, select the menu item for time synchronisation from the **Settings** menu.

Make the desired setting.

Setting date and time

Select the menu item for time and date setting from the **Settings** menu.

Make the desired setting.

The setting is saved when the menu item is exited.

Ignition logic *

See infotainment system instructions.



Language selection

You can select the display language for some functions.

Select the menu item for language from the **Settings** menu and make the desired setting.

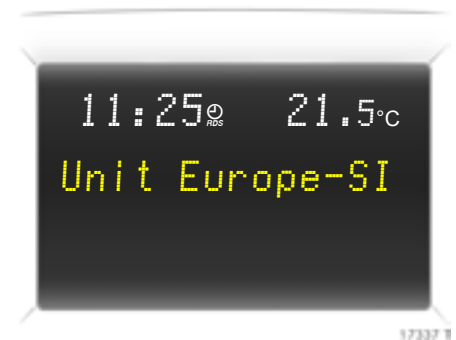

Setting units of measure

You can select which units of measure are to be used.

Select the menu item for units of measure from the **Settings** menu and confirm the desired setting.

Board information display *, trip computer *

The trip computer provides information on driving data, which is continually recorded and evaluated electronically.

Access trip computer vehicle data by pressing the **BC** button on the infotainment system or the left adjuster wheel * on the steering wheel.

Some information appears in the display in an abbreviated form.

Once an audio function has been selected, the subsequent rows of the trip computer function are displayed.

The functions are displayed in the following order:

- Instantaneous consumption
- Average consumption
- Effective consumption
- Average speed
- Distance travelled
- Range
- Stop watch



Instantaneous consumption

Display changes depending on speed:

Display in gal/h below 8 mph (13 km/h).

Display in mpg above 8 mph (13 km/h).

Average consumption

Display of average consumption. The measurement can be reset at any time and restarted, see "Reset".

Effective consumption

Display of fuel used. The measurement can be reset at any time and restarted, see "Reset".

Average speed

Display of average speed. The measurement can be reset at any time and restarted, see "Reset".

Stoppages in the journey with the ignition off are not included in the calculations.

Distance travelled

Display of miles travelled. The measurement can be reset at any time and restarted, see "Reset".

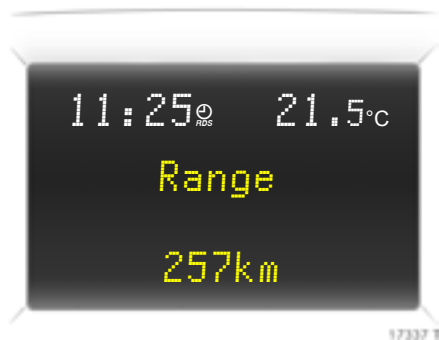

Range

Range is calculated from current fuel tank content and instantaneous consumption. The display shows average values.

After refuelling, the vehicle updates the range automatically after a brief delay.

If less than 30 miles (50 km) can be driven with the fuel remaining in the tank, the warning "Range" appears on the display.

If less than 20 miles (30 km) can be driven with the fuel remaining in the tank, the warning "Refuel!" * appears on the display.

Acknowledge the menu item as described on page 54.

Reset: Reset trip computer information

The following trip computer information can be reset (reset and restart measurements or calculations):

- Average consumption
- Effective consumption
- Average speed
- Distance travelled.

Select the desired trip computer information.

Reset by pressing left adjuster wheel * on steering wheel or by pressing the four-way switch to the left or right:

| | |
|----------------------------|---------------|
| <u>Press for more than</u> | |
| <u>2 seconds</u> | current value |
| <u>Press for more than</u> | |
| <u>4 seconds</u> | All values. |



Stop watch

Select function, operate with four-way switch:

Press right button Start/Stop

Press left button
at least 2 seconds Reset

Operating using the left adjuster wheel * on the steering wheel:

Press Start/Stop.

Interruption of power supply

If the power supply has been interrupted or if the battery voltage has dropped too low, the values stored in the trip computer will be lost.



**Graphical information display *
or
colour information display *
Selecting functions**

The functions and settings of some equipment * can be accessed via the graphical information display or the colour information display.

These functions are marked or executed in the menu display via the four-way switch, the multifunction knob * on the Infotainment System or the left adjuster wheel * on the steering wheel.



To select with four-way button:
Select menu items via menus and with the buttons/four-way button of the infotainment system.

If check control * issues a warning message, the display is blocked from other functions. Acknowledge the message by pressing the right or left portion of the four-way button. If there are several warning messages, acknowledge them one at a time.



To select using the multifunction button:
Turn Mark menu items or commands, select functions

Press Select marked item, confirm command.

To exit a menu, turn the multifunction button left or right to **Return** or **Main** and select.

If check control * issues a warning message, the display is blocked from other functions. Acknowledge the message by pressing the multifunction button. If there are several warning messages, acknowledge them one at a time.



17014 1

Select using the left adjuster wheel * on the steering wheel:

| | |
|------------------|--------------------|
| <u>Turn up</u> | Previous menu item |
| <u>Turn down</u> | Next menu item |

Press Select marked item, confirm command.

If check control * issues a warning message, the display is blocked from other functions. Acknowledge the message by pressing the left adjuster wheel. If there are several warning messages, acknowledge them one at a time.

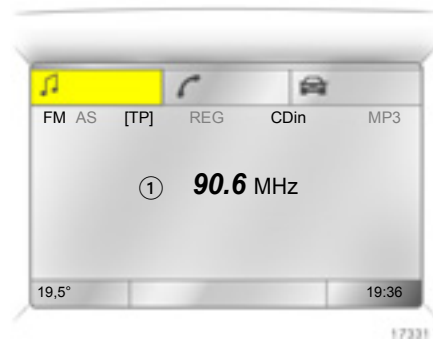

17331 1

For each functional area there is a main page (Main), which is selected at the top edge of the display (not with the Infotainment system CD 30 or the Mobile Phone Portal):

- Audio
- Navigation *
- Telephone *
- Trip computer *

For Audio, Navigation * and Telephone * functions – see infotainment system instructions.

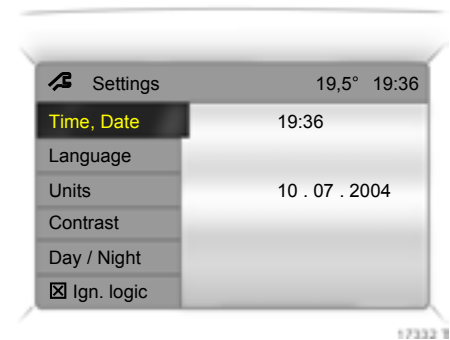

17332 1

System settings

The settings are accessed via the **Settings** menu.

Press the **Main** button * (not found on all infotainment systems) on the infotainment system (call up main display).

Press the **Settings** button of the infotainment system. On Infotainment System CD 30, make sure no menu has been selected.

The **Settings** menu is displayed.

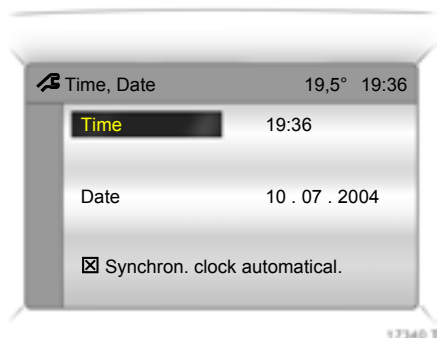

Setting the date and time ✱

Select menu item **Time, Date**, from the **Settings** menu.

The menu for **Time, Date** is displayed.

Select the menu items required:

Make the desired setting.

Correcting time ✱

In systems with GPS receiver¹⁾, date and time are set automatically upon receipt of a GPS satellite signal. If the displayed time does not match local time, it can be corrected manually or automatically by receiving an RDS time signal²⁾ ✱.

Some RDS transmitters do not send correct time signals. If the incorrect time is displayed often, deactivate automatic time synchronisation ✱ and set the time manually.

To correct time with the help of RDS, select menu item **Synchron. clock automatical.** from the **Time, Date** menu.

The box in front of **Synchron. clock automatical.** will be ticked; see Fig. 17340 T.

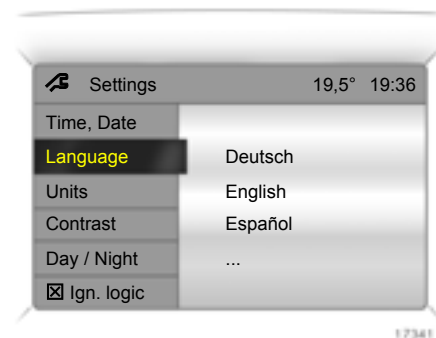

Language selection

You can select the display language for some functions.

Select menu item **Language** from the **Settings** menu.

The available languages are displayed.

1) **GPS** = **G**lobal **P**ositioning **S**ystem,
Satellite system for world-wide positioning.

2) **RDS** = **R**adio **D**ata **S**ystem.

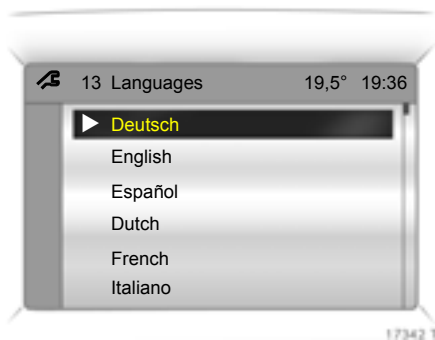

Select the desired language.

Selections are indicated by a ► in front of the menu item.

In systems with voice output ✱, when the language setting of the display is changed the system will ask whether the announcement language should also be changed – see Infotainment system instructions.

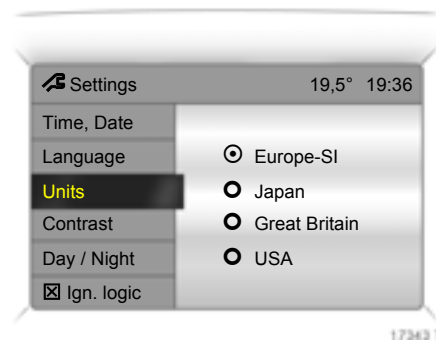

Setting units of measure

You can select which units of measure are to be used.

Select menu item **Units** from the **Settings** menu.

The available units are displayed.

Select the desired unit.

Selections are indicated by a ● in front of the menu item.

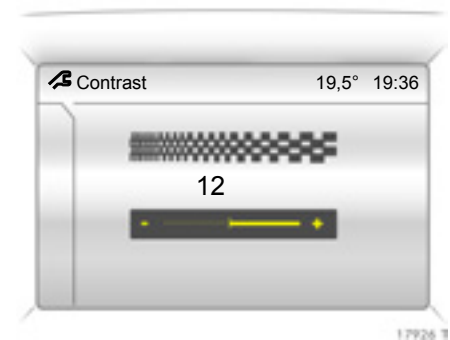

Adjusting contrast ✱

(graphical information display)

Select menu item **Contrast** from the **Settings** menu.

The menu for **Contrast** is displayed.

Confirm the required setting.

Setting display mode *

The display can be adjusted to suit the light conditions, black or white or coloured text on a light background or white or coloured text on a dark background.

Select menu item **Day / Night** from the **Settings** menu.

The options are displayed.

Automatic: adapted based on vehicle lighting.

Always day design: black or coloured text on light background.

Always night design: white or coloured text on dark background.

Selections are indicated by a ● in front of the menu item.

Ignition logic *

See infotainment system instructions.

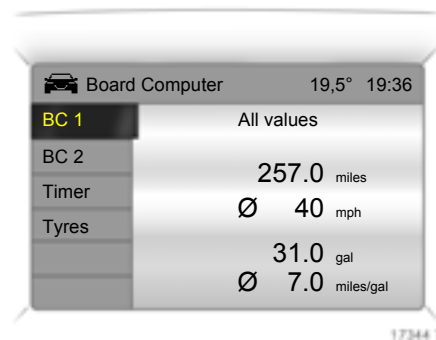

**Graphical information display *
or
Colour information display *, Trip
computer ***

The trip computers provide information on driving data, which is continually recorded and evaluated electronically.

The trip computer main page provides information on range and instantaneous consumption.

To display other trip computer data, press the **BC** button on the infotainment system *, select the trip computer menu front the display or press the left adjuster wheel * on the steering wheel.

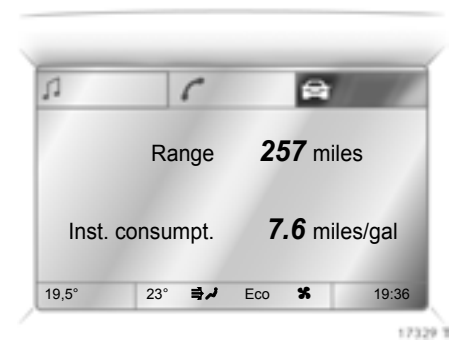
**Range**

Range is calculated from current fuel tank content and instantaneous consumption. The display shows average values.

After refuelling, the vehicle updates the range automatically after a brief delay.



If the fuel in the tank will allow less than 30 miles (50 km) of travel, the warning "Range" appears on the display.

If less than 20 miles (30 km) can be driven with the fuel remaining in the tank, the warning "Please refuel!" * appears on the display.

Acknowledge the menu item as described on page 54.

Instantaneous consumption

Display changes depending on speed:

Display in gal/h below 8 mph (13 km/h).

Display in mpg above 8 mph (13 km/h).

Distance travelled

Display of miles travelled. The measurement can be reset at any time and restarted, see "Reset".

Average speed

Calculation of average speed. The measurement can be reset at any time and restarted, see "Reset".

Stoppages in the journey with the ignition off are not included in the calculations.

Effective consumption

Display of fuel used. The measurement can be reset at any time and restarted, see "Reset".

Average consumption

Calculation of average consumption. The measurement can be reset at any time and restarted, see "Reset".

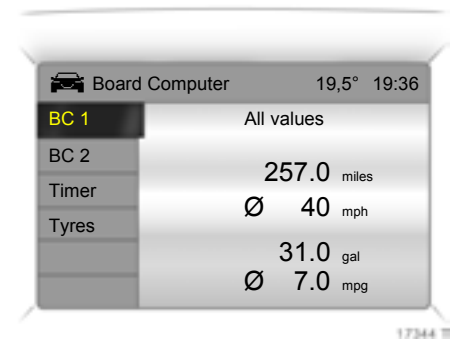

Reset:

Reset trip computer information

The following trip computer information can be reset (restart measurements):

- Distance
- Average speed
- Effective consumption
- Average consumption.

Select **BC 1** or **BC 2** from the trip computer menu.

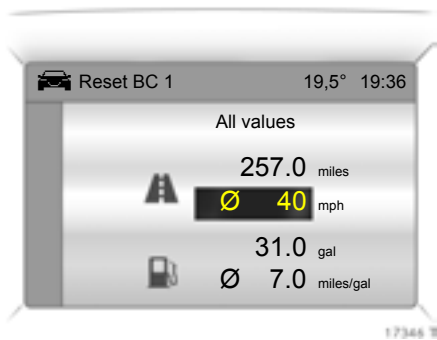

The information of the two trip computers can be reset separately, making it possible to evaluate data from different time periods.

Select the desired trip computer information.

The value for the selected function will be reset and recalculated.

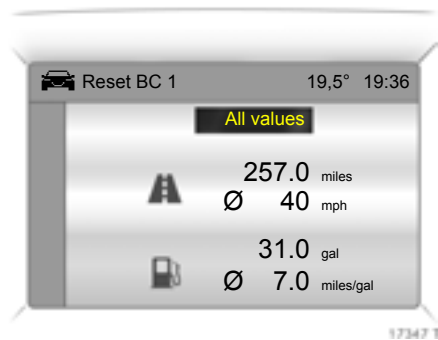

To reset all information of a trip computer, select menu item **All values**.

After resetting, "- -" is displayed for the trip computer information selected. The recalculated values are displayed after a brief delay.

Interruption of power supply

If the power supply has been interrupted or if the battery voltage has dropped too low, the values stored in the trip computer will be lost.

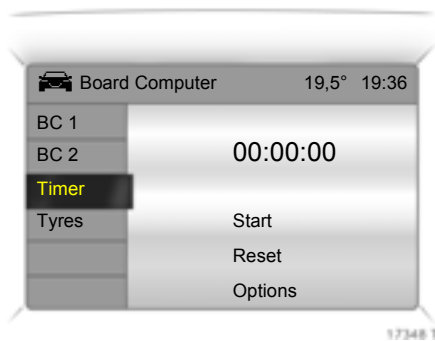

Stop watch

Select menu item **Timer** from the **Board Computer** menu.

The **Timer** menu is displayed.

To start, select menu item **Start**.

To reset, select menu item **Reset**.

The desired stop watch display can be selected from the **Options** menu ✱:

Driving Time excl. Stops

The time the vehicle is in motion is recorded. Stationary time is not included.

Driving Time incl. Stops

The time the vehicle is in motion is recorded. The time the vehicle is stationary with the key in the starter switch is included.

Travel Time

Measurement of the time from manual activation via **Start** to manual deactivation via **Reset**.

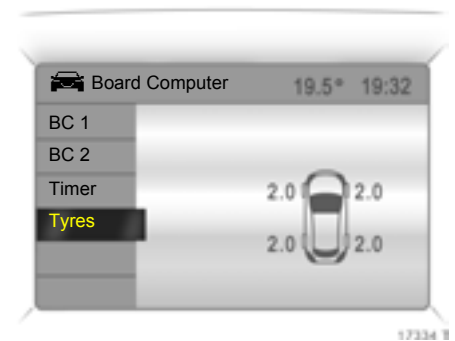

Display of current tyre pressure ✱

Select menu item **Tyres** from the **Board Computer** menu.

The current pressure of each tyre is displayed.

Further information – page 222.

Check control *

Check control monitors some fluid levels, the tyre pressure *, battery of the remote control, the antitheft warning system *, the brake light switch and important exterior lights, including cable and fuses. In trailer mode, the trailer lighting is monitored.

Warning messages appear on the display. If there are several warning messages, they are displayed one after the other.

Some of the warning messages appear on the display in an abbreviated form.

Examples of warning messages for the graphical information display * and colour information display * are depicted. On the board information display, messages appear in an abbreviated form.

Acknowledge warning messages as described on pages 49, 54. Unacknowledged warning messages can be re-displayed later.

Warning messages:

Remote Control Battery check

Battery voltage of remote control or electronic key of Open&Start system too low – page 69.

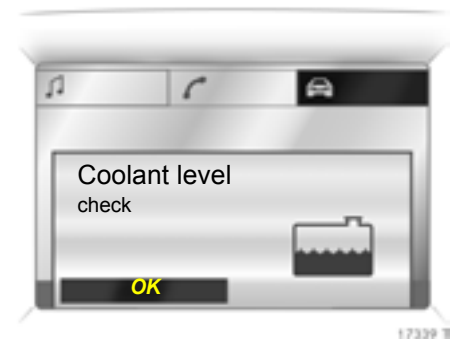

Brakelight switch check

Fault. Brake light does not come on when brake applied. Have cause of fault remedied immediately. We recommend that you consult your Vauxhall Authorised Repairer.

Safeguard check

Fault. System error in Vauxhall alarm system. Have cause of fault remedied immediately. We recommend that you consult your Vauxhall Authorised Repairer.

If there is a fault in the vehicle lighting, the respective fault source is displayed as text, e.g.:

**Brakelight
check right**

In vehicles with tyre pressure monitoring system ✱, if tyre pressure is too low, the display indicates which tyre to check, e.g.:

**Tyre pressure
check rear
right tyre
(value in bar)**

Check tyre pressure at next opportunity using suitable gauge. Tyre pressure monitoring system ✱ – page 222. Checking tyre pressure – page 333.

In vehicles with tyre pressure control system ✱, if there is major loss of pressure in a tyre, the display indicates the tyre at fault, e.g.:

**Attention!
Rear left tyre
pressure loss
(value in bar)**

Stop immediately and check tyre and tyre pressure. Tyre pressure monitoring system ✱ – page 222.

**Wash
Fluid Level
check**

Fluid level in windscreen wash system too low. Topping up wash fluid – page 305.

Rear window wash system and headlight wash system ✱ are deactivated if wash fluid level is low.

**Coolant level
check**

Fluid level in engine cooling system is low. Check coolant level immediately – page 300.

Interruption of power supply

Stored warning messages appear on the display one after the other.

Radio reception *

Car radio reception differs from domestic radio reception:

As the vehicle antenna is relatively near the ground, the broadcasting companies cannot guarantee the same quality of reception as obtained with a domestic radio using an overhead antenna.

- Changes in distance from the transmitter,
 - multi-path reception due to reflection and
 - shadowing
- may cause hissing, noise, distortion or loss of reception altogether.

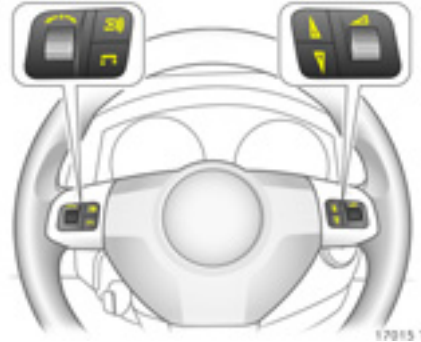

Remote control on steering wheel *

The functions of the infotainment system * and the information display can be operated on the steering wheel.

Further information – page 49 and the relevant operating instructions.



Twin Audio *

Twin Audio allows rear seat occupants the choice between the audio source played on the infotainment system or a separate audio source.

Only an audio source that is not currently active on the infotainment system can be controlled using Twin Audio.

Two headphone connections are available, with separate volume controls.

Further information is available in the infotainment system operating instructions.

Mobile telephones and radio equipment *

The Vauxhall installation instructions and the operating guidelines provided by the telephone manufacturer must be observed when fitting and operating a mobile telephone. Failure to do so could invalidate the vehicle's operating permit (EU Directive 95/54/EG).

Prerequisites for fault-free operation:

- Professionally installed exterior antenna to obtain the maximum range possible
- Maximum transmission power 10 Watt,
- Installation of the telephone in a suitable spot (see information on page 126).

Obtain advice on predetermined installation locations for the external antenna and equipment holder and ways of using devices with transmission power of more than 10 Watts. We recommend that you consult your Vauxhall Authorised Repairer, who will have brackets and various installation kits available as accessories and will install them in accordance with regulations.

For reasons of safety, we recommend that you do not use the phone while driving. Even use of a handsfree set can be a distraction while driving. Be sure to observe any country-specific regulations.

Warning

When used in the vehicle interior, mobile telephones and radio equipment (CB) with integrated antenna may cause malfunctions in the vehicle electronics.

Mobile telephones and radio equipment (CB) should only be used with an antenna fitted on the vehicle exterior.

Infotainment system *

The infotainment system is operated as described in the operating instructions.

Keys, doors, bonnet

| | |
|---|----|
| Electronic immobiliser..... | 67 |
| Radio remote control * with mechanical key | 68 |
| Open&Start system *..... | 70 |
| Central locking system | 76 |
| Fault when locking or unlocking..... | 80 |
| Luggage compartment..... | 81 |
| Vauxhall alarm system *..... | 83 |
| Child safety locks *..... | 86 |
| Bonnet | 86 |

Replacement keys

The key number is specified in the vehicle documents and in the Car Pass *.

The key is a constituent of the electronic immobiliser. Ordering keys from a Vauxhall Authorised Repairer guarantees problem-free operation of the electronic immobiliser.

When electronic keys of the Open&Start system are being replaced, all keys must be handed to the dealer for programming.

Keep the spare key in a safe spot.

Locks – page 311,
Open&Start system, electronic keys
– page 70.

Car Pass

The Car Pass contains all of the vehicle's data and should therefore not be kept in the vehicle.

Have your Car Pass on hand when consulting a Vauxhall Authorised Repairer.



17027 1

Key with foldaway key section *

Press button to extend. Press button to retract; key section engages audibly.

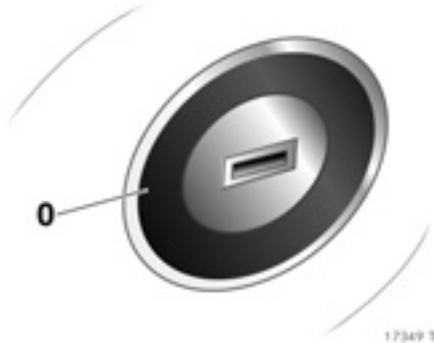

Electronic immobiliser

The system checks whether the vehicle may be started with the mechanical key or electronic key of the Open&Start system * that is being used. If the key is recognised as "authorised" the vehicle can be started. The check takes place via a transponder in the key.

The electronic immobiliser activates itself automatically after the key has been removed from the ignition or, with the Open&Start system *, when the engine is switched off by pressing the Start/Stop button.

The code number of the electronic immobiliser is given in the Car Pass.



Control indicator for immobiliser

Control indicator  illuminates briefly when the ignition is switched on.

If the control indicator flashes when the ignition is on, there is a fault in the system; the engine cannot be started. Switch off the ignition and then repeat the start attempt.

If control indicator  continues to flash, try to start the engine using the spare key and consult a workshop. We recommend your Vauxhall Authorised Repairer.



If control indicator  illuminates after the engine is started, there is a fault in the engine electronics or transmission electronics * - pages 184, 190, 198, 210 or there is water in the diesel fuel filter * - page 300.

Note

The immobiliser does not lock the doors. Therefore, after leaving the vehicle always lock it and switch on the Vauxhall alarm system * - pages 76, 83.

Store personal vehicle settings in the vehicle key *

The last settings selected

- for the climate control system *
- information display *
- Infotainment system *
- instrument illumination

are stored automatically depending on the vehicle key used.

Different settings stored for each vehicle key are retrieved automatically on use the vehicle key concerned.

Each time the vehicle is locked, the settings are saved again.



17029 1

Radio remote control * with mechanical key

Radio remote control in version with Open&Start system – page 70.

The radio remote control is integrated in the key.

Used to operate:

- central locking system,
- mechanical anti-theft locking system *
- Vauxhall alarm system *

Depending on the equipment level of the vehicle *, the windows of vehicles with electric windows in all doors * can be opened or closed from outside using the radio remote control - page 79.

On the Astra TwinTop, the roof can also be opened or closed with the remote control *.



17030 1

The radio remote control has a range of approx. 5 metres. This range can be affected by outside influences. Aim the remote control at the vehicle to operate.

Handle the radio remote control with care, protect it from moisture and high temperatures and avoid unnecessary operation.

The hazard warning lights come on to indicate that the remote control is operational.

Central locking system, mechanical anti-theft locking system *

– page 76.

Vauxhall alarm system *

– page 83.

Electric windows *

– page 143.

Astra TwinTop

– page 148.

Fault

If the central locking system cannot be operated with the radio remote control, it may be due to the following:

- The range of the radio remote control has been exceeded.
- Radio remote control battery voltage is too low. Battery replacement - see next page.
- Frequent, repeated operation of the radio remote control outside the reception range of the vehicle (e.g. too far from vehicle, remote control is then no longer recognised). Remote control synchronisation - see next page.
- If the central locking system is overloaded as a result of repeated operation at short intervals. The power supply is cut off for a brief period.
- Interference from higher-power radio waves from other sources.

To eliminate the cause of the fault, contact your Vauxhall Authorised Repairer.

Open driver's door with key, – page 80.

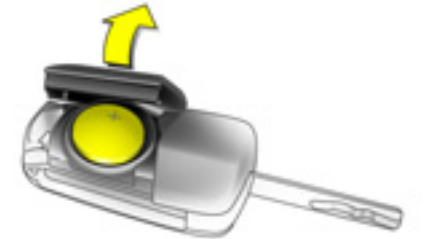

17031 8

Remote control battery replacement

Replace the battery as soon as the range of the radio remote control begins to shrink.

Key with foldaway key section

Extend key, – page 66. Open radio remote control. Replace battery - battery type, – page 342 - noting installation position. Close radio remote control.

Make sure that you dispose of old batteries in accordance with environmental protection regulations.

Key with fixed key section

Entrust battery replacement to a workshop. We recommend your Vauxhall Authorised Repairer.

Radio remote control synchronisation

After a battery change, unlock the door with the key in the lock. Synchronise by turning on the ignition.



Open&Start system *

The Open&Start system allows the vehicle to be locked and unlocked, including the anti-theft locking system * and the Vauxhall alarm system *, and the engine to be started and stopped without a mechanical key. All the driver has to do is keep the key on his person.

Depending on the equipment level of the vehicle *, the windows of vehicles with electric windows in all doors * can be opened or closed from outside using the remote control of the electronic key - page 79.

On the Astra TwinTop, the roof can also be opened or closed with the remote control * of the electronic key.



The electronic key must be within the external reception range about 1 metre from the vehicle in order to lock and unlock the vehicle.

If the electronic key is recognized as "authorised," the vehicle can be unlocked by pulling a door handle or the knob beneath the tailgate handle and the doors and the tailgate can be opened.



When the Start/Stop button is pressed, the system re-checks the authorisation. The electronic key has to be recognised in the interior in order to do this. After the key has been authorised the ignition switches on. At the same time, the electronic immobiliser is switched off and the electro-mechanical steering column lock is deactivated. Pressing the Start/Stop button again with the brake or clutch pedal depressed or in **P** or **N** with automatic transmission * starts the engine. Press the button for at least one second with the vehicle stationary or hold until the engine starts.

If the brake or clutch pedal is depressed, the engine can be started right away with a single press on the Start/Stop button.

Releasing the Start/Stop button interrupts the starting procedure.

The engine and the ignition are switched off by pressing the Start/Stop button again. The vehicle must be stationary. The immobiliser is activated at the same time.

If the ignition has been switched off and the vehicle is stationary, the steering wheel lock activates automatically when the driver's door is opened or closed.

The electronic key must be within the interior reception in order to switch the ignition on or off. We recommend that the driver carries the electronic key on his or her person. If the electronic key is not recognised, try a different position for the key.

Do not put the electronic key in the luggage compartment or in front of the information display.

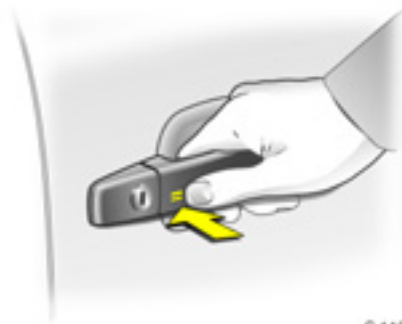

S 11527

The vehicle is locked from the outside with the doors closed by touching the sensor panel in the door handle of one of the front doors. The electronic key must be within the external reception range of approximately one metre from the vehicle.

The Open&Start system * does not lock the vehicle automatically if the electronic key is outside the external reception range of approximately one metre from the vehicle.

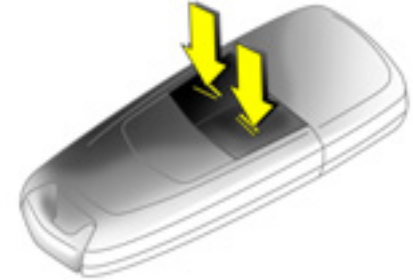

17035 F

Radio remote control

The vehicle can be locked and unlocked by conventional means using the radio remote control with the buttons on the electronic key.

In addition, the anti-theft locking system and anti-theft alarm system can be armed and disabled using the radio remote control. Depending on the equipment level of the vehicle *, the windows of vehicles with electric windows in all doors * can be opened or closed from outside using the radio remote control.



The radio remote control has a range of approx. 5 metres. This range can be affected by outside influences. Aim the remote control at the vehicle to operate.

Handle the radio remote control with care, protect it from moisture and high temperatures and avoid unnecessary operation.

The hazard warning lights come on to indicate that the remote control is operational.

**Central locking system,
mechanical anti-theft locking system ***

– page 76.

Anti-theft alarm system *

– page 83.

Electric windows *

– page 143.

Astra TwinTop

– page 148.



Control indicator for Open&Start system





If the control indicator flashes  with the ignition switched on or with the engine running an operating error has occurred, e.g. the electronic key is no longer within the reception range of the vehicle interior. During the next starting procedure the engine may not be able to be started. Press Start/Stop key somewhat longer to switch the ignition off.

Flashing of the  can also be an indication of complete failure of the electronic key. In this case operation is only possible using the emergency facility – page 73.

InSP3 in the service display or an appropriate message in the information * display indicates that the battery of the electronic key needs replacing – page 74.

If the control indicator  is permanently on, an error has occurred in the system. Lock or unlock vehicle using the radio remote control or the emergency key if necessary – page 80, or try using the spare key.

If  illuminates, this can also mean that the steering wheel lock is still locked: move steering wheel to and fro a little and press Start/Stop button again.

Illumination of  whilst driving indicates a system fault. Consult a workshop immediately. We recommend your Vauxhall Authorised Repairer.

Emergency operation – page 73.

**Lockable glove compartment,
Astra TwinTop with Open&Start system ***

In addition to the electronic key of the Open&Start system, there is a standard key without remote control for the glove compartment lock.

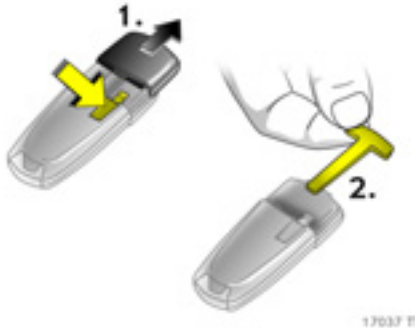

17037 F

Emergency operation

If the Open&Start system fails or the electronic key (control indicator ) flashes or permanently on) the driver's door can be locked or unlocked with the emergency key in the electronic key: press locking mechanism on underside and remove cap toward the front by applying gentle pressure to the cap. Push emergency key towards the outside over the detent and remove.



S 11528

Only the driver's door can be locked and unlocked using the emergency key. Unlock the entire vehicle as described on page 80. In the version with Vauxhall alarm system * the alarm may be triggered when the vehicle is unlocked. Switch ignition on to deactivate alarm and release the steering column lock: hold electronic key at marked position on the steering column panelling and press the Start/Stop button. Repeat procedure if necessary.

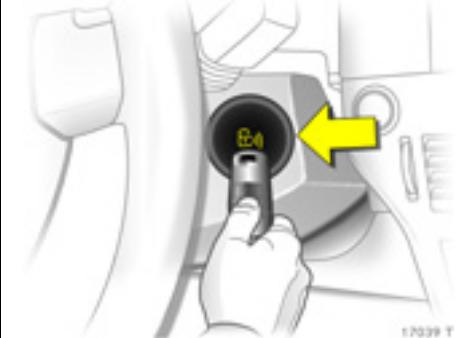

17039 F

To start the engine, hold the electronic key at the marked position, depress brake pedal or clutch pedal or in vehicles with automatic transmission * depress brake pedal and engage **P** or **N**, Then press the Start/Stop button.

Press start/stop button for at least 1 second to switch the engine off. Lock all doors except driver's door as described on page 80. Unlock driver's door with emergency key.

This facility is only intended for emergencies. Replace battery in electronic key at the earliest opportunity or have the system repaired. Consult a workshop. We recommend your Vauxhall Authorised Repairer.



Replacing battery in electronic key

Replace the battery immediately if the system is no longer working properly or the range of the radio remote control is reducing. The need for a battery change is indicated via **InSP3** in the service display or, in vehicles with check control *****, by an appropriate message in the display – page 44.



To replace the battery, press the locking mechanism on the underside of the electronic key and remove the cover towards the front by applying gentle pressure – page 73, figure 17037 T. Push off cover with emblem on the button side towards the outside.

Replace battery, for battery type – page 342, pay attention to installation position. Engage caps.

Radio remote control synchronisation

The radio remote control synchronises itself automatically during every starting procedure.

Fault in Open&Start system or radio remote control.

If the central locking cannot be operated or the engine cannot be started, the cause may be one of the following:

- Electronic key out of reception range, or out of range of radio remote control,
- Radio remote control battery voltage too low – see previous page for instructions on how to change battery,
- Frequent, repeated operation of the radio remote control outside the reception range (e.g. too far from vehicle, remote control is then no longer recognised).

- If the central locking system is overloaded as a result of repeated operation at short intervals. The power supply is cut off for a brief period.
- Interference from higher-power radio waves from other sources.

To remedy the cause of the problem, move electronic key or radio remote control to another location or change the remote control battery. If the problem persists we recommend that you consult your Vauxhall Authorised Repairer.

Emergency operation, – page 73.



16968 T

Central locking system

For doors, boot lid/tailgate and tank flap.

To unlock

Remote control with mechanical key

Press button  on radio remote control.

To open the door, pull the handle. Open the luggage compartment by pulling the knob under the tailgate handle.

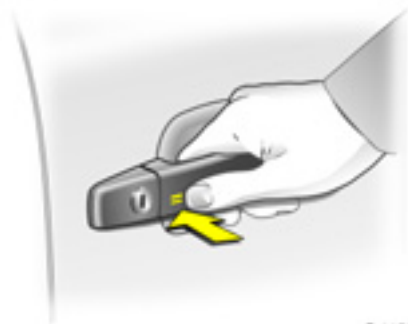

S 11527

Open&Start system with electronic key *

The electronic key must be in the outer reception range of the vehicle. The vehicle is unlocked by pulling a door handle or operating the button beneath the tailgate handle

– or –
by pressing button  of the electronic key's remote control.



17042 T

To lock

Close doors, luggage compartment and tank flap.

Radio remote control with mechanical key

Press button  on radio remote control.

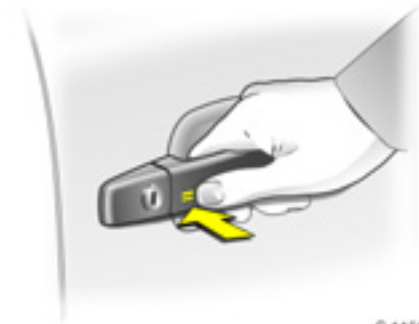

S 11527

Open&Start system with electronic key ❄

The electronic key must be outside of the vehicle. There must not be any electronic key in the vehicle interior. All of the doors and the luggage compartment are locked by touching the sensor in the handle of the driver's or front passenger door

– or –

by pressing button  of the electronic key's remote control.

Mechanical anti-theft locking system ❄,

Warning

Do not use the system if there are people in the vehicle! The doors cannot be unlocked from inside.



17043 1

Radio remote control with mechanical key

All doors must be closed. At the latest 15 seconds after locking, press button  of the radio remote control again.

Lock buttons on all doors are positioned such that doors cannot be opened.

If the ignition was on, the driver's door must be opened and closed once so that the vehicle can be secured.

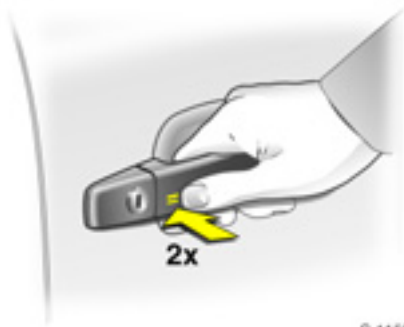

S 11530

Open&Start system with electronic key *

All doors must be closed. The electronic key must be outside of the vehicle. No more than 15 seconds after locking, touch the sensor in the handle of the driver's or front passenger door again

– or –

press button  of the electronic key's remote control again.

If the ignition was on, the driver's door must be opened and closed once so that the vehicle can be secured.

All doors are secured against opening.

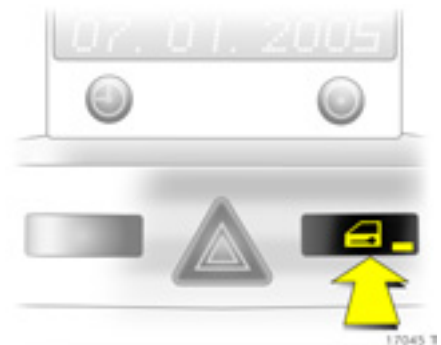

Central locking button for locking and unlocking the doors from inside the vehicle

Press button  in the centre console: doors are locked or unlocked.

The LED in the central locking button  illuminates for around 2 minutes after locking with the remote control.

If the doors are locked from the inside during driving using the central locking button, the ELD  lights permanently.

If the key is in the ignition, locking is only possible if all doors are closed.

When the mechanical anti-theft locking system * is active – see previous page – the doors cannot be unlocked with this button.

Note

- If the driver's door is not closed properly, the central locking system will not lock.
- To lock the doors from within (e.g. to prevent unwanted entry from outside), press central locking switch  in the centre console.
- After unlocking with the key in the lock and opening the driver's door, the entire vehicle is unlocked.
- If locked via the central locking system, the doors can also be opened by pulling the inside door handles. The central locking system is also unlocked at this time (not possible on Astra TwinTop when the roof is open).
- Locked doors unlock automatically in the event of an accident of a certain severity (to allow external help to gain access). The hazard warning lights and courtesy light also come on. For this to occur, the key must be in the starter switch.

- With the Open&Start system * the vehicle cannot be unlocked until 2 seconds after locking. Within this time, a door handle can be pulled or the button beneath the tailgate handle operated to check whether the vehicle is locked.
- The Open&Start system * does not lock the vehicle automatically if the electronic key is outside the reception range of the vehicle (more than 1 metre away from the vehicle).
- When using the Open&Start system *, there must not be an electronic key inside the vehicle when locking.
- The locking sensors in the door handles must be kept clean to ensure unrestricted functionality of the Open&Start system *.

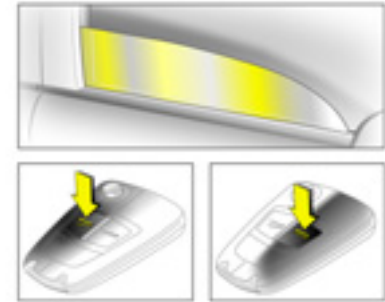

S 11531

Operating the windows * from the outside

 Warning

Take care when operating the electric windows. Risk of injury, particularly to children.

Vehicle passengers should be informed accordingly.

Keep a close watch on the windows when closing them. Ensure that nothing becomes trapped in them as they move.



Depending on the equipment level of the vehicle *, the windows of vehicles with electric windows in all doors * can be opened or closed from outside:

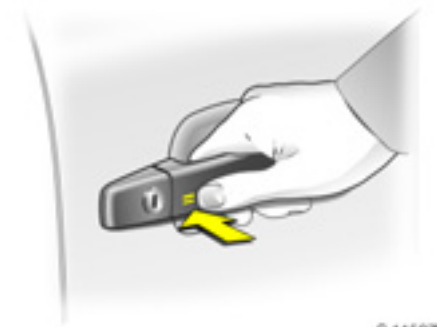





S 11527

Radio remote control with mechanical key

Hold button  or  on the radio remote control depressed until all windows have opened or completely closed.

Open&Start system with electronic key *

Hold down button  of radio remote control to open. To close, hold down button  or touch sensor in door handle for longer. The electronic key must be recognised within the external reception range. It is advisable for the driver to keep the electronic key on his person.

Further information on windows – page 143.

Overload

The power supply is cut off for a brief period if the central locking system is repeatedly operated at short intervals.

The system is protected by a fuse in the fuse box – page 266.

Further information on windows with electric drive – page 145.



S 11532

Fault when locking or unlocking

Fault in radio remote control or Open&Start system.

To unlock

Turn key or emergency key for Open&Start system – page 73 anticlockwise in the driver's door lock as far as it will go. Return key to a vertical position and remove. The entire vehicle is unlocked when the driver's door is opened.

For Astra TwinTop with open roof - after opening the driver's door, press the central locking button  in the centre console. The vehicle will then be unlocked, provided the anti-theft locking system * is not engaged. Switch on the ignition to deactivate the Vauxhall alarm system *. Emergency operation of the Open&Start system – page 73.

To lock

Open passenger door, close driver's door, press central locking button  in centre console. Central locking system locks all doors. Close passenger door.

Malfunction in central locking system

To unlock

Turn key or emergency key with Open&Start system – page 73, forwards in driver's door lock as far as it will go. Turn key back to a vertical position and remove. The other doors can be opened by pulling the handle on the inside of the doors (not possible if anti-theft locking system * enabled beforehand). The luggage compartment and the fuel filler cap remain locked. To deactivate the anti-theft locking system * switch ignition on – page 14.



To lock

Insert the key or emergency key for Open&Start system – page 73 into the opening above the lock on the inside of the door and press until the lock audibly engages. Then close the door. The procedure must be repeated for each door. The driver's door can also be locked from outside using the lock. The unlocked fuel filler flap and tailgate/boot lid cannot be locked.

Emergency operation of Open&Start system *

– page 73.

Luggage compartment

To unlock

Radio remote control with mechanical key

Press button  on the remote control. The luggage compartment is unlocked together with the doors.

Open&Start system with electronic key *

By pulling the knob under the tailgate handle, the luggage compartment together with the doors is unlocked and opened if the electronic key is detected in the outer reception range,

– or –

press button  on the radio remote control of the electronic key and the luggage compartment is unlocked together with the doors.

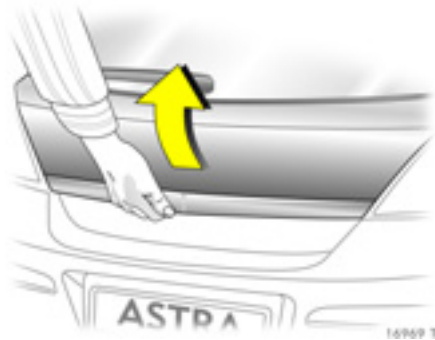

To open:

The luggage compartment is opened by operating the button beneath the handle.

⚠ Warning

Do not drive with the tailgate open or ajar, e.g. when transporting bulky objects, since toxic exhaust gas could penetrate the interior.

Fitting of accessories on the tailgate will increase its weight. If it becomes too heavy, the tailgate will then not stay open.



To close:

Close luggage compartment using the handle on the inside of the tailgate.

Do not operate the button beneath the handle when closing. Otherwise the luggage compartment will once again be unlocked.



To lock

Close doors, luggage compartment and tank flap.

Radio remote control with mechanical key

Press button  on radio remote control.

Open&Start system with electronic key *

Press button  of the electronic key radio remote control or touch sensor in handle of one of the front doors. The electronic key must be recognised in the external reception area. It is advisable for the driver to keep the electronic key on his person.

Vauxhall alarm system *

monitors

- the doors, luggage compartment, bonnet
- the passenger compartment
- vehicle tilt, e.g. if it is raised,
- the ignition.

| |
|------------------|
| ⚠ Warning |
|------------------|

| |
|---|
| Do not use the system if there are people in the vehicle! The doors cannot be unlocked from the inside. |
|---|



17043 0

To activateRadio remote control with mechanical key

All doors, windows, the sun roof * and the bonnet must be closed. Within 15 seconds of locking, press button = on the radio remote control again.

If the ignition was switched on, the driver's door must be opened and closed once so that the Vauxhall alarm system can be switched on.

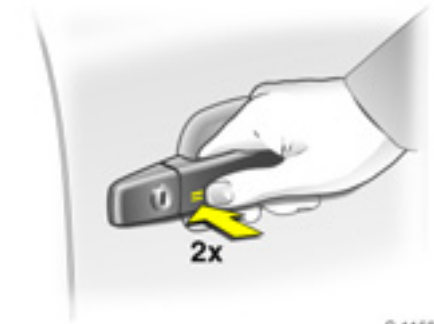

S 11530

Open&Start system with electronic key *

The doors, the windows and the bonnet must be closed. The electronic key must be in the outside reception range of the vehicle. Touch the sensor in the door handle of the driver's or front passenger door again no more than 15 seconds after locking

– or –
press button = of the electronic key's remote control again.

If the ignition was switched on, the driver's door must be opened and closed once so that the Vauxhall alarm system can be switched on.



Activation without monitoring of passenger compartment and vehicle tilt
e.g. if animals are to be left in the vehicle.

1. Close tailgate and bonnet.
2. Press button ① in the roof console. The LED in button ② flashes (max. 10 seconds) – see next column
3. Close doors.

4. Switch on Vauxhall alarm system. LED illuminates. After approx. 10 seconds the system is activated, without monitoring of the passenger compartment or vehicle tilt. LED flashes until system is switched off.

For Astra TwinTop, passenger compartment monitoring is deactivated if the roof is open to prevent false alarms.

Light emitting diode (LED)

During the first 10 seconds of anti-theft alarm system activation:

- LED illuminated = Test, switch-on delay
- LED flashes rapidly = Door, luggage compartment, bonnet open, system fault.



After the first 10 seconds of anti-theft alarm system activation:

- LED flashes slow = System switched on,
- LED illuminates for approx. 1 second = Switch-off

If a system fault occurs, consult a workshop. We recommend your Vauxhall Authorised Repairer.



16968 T

To deactivate

Radio remote control with mechanical key

Press button  of the radio remote control –or– turn on ignition.

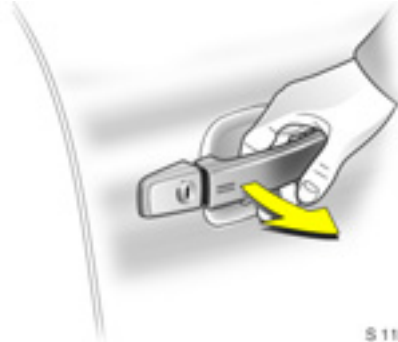

S 11526

Open&Start system with electronic key *

Pulling a handle or operating the button beneath the tailgate handle unlocks the vehicle and disarms the Vauxhall alarm system if the electronic key has been recognised in the outer reception range of the vehicle
 – or –
 if button  on the electronic key's remote control has been pressed.

In the event of a fault in the radio remote control or the Open&Start system, open the vehicle as described on page 80.

If the alarm is triggered when the driver's door is opened, deactivate the Vauxhall alarm system by switching on the ignition.

Note

Changes to the vehicle interior, such as the use of seat covers, could impair the function of passenger compartment monitoring.

Alarm

While the Vauxhall alarm system is switched on the alarm can be triggered:

- an acoustic signal (horn) and
- a visual signal (hazard warning lights).

The number and duration of the alarms are legally established.

The alarm is silenced by pressing a button of the radio remote control or by switching on the ignition. The Vauxhall alarm system is deactivated at the same time.

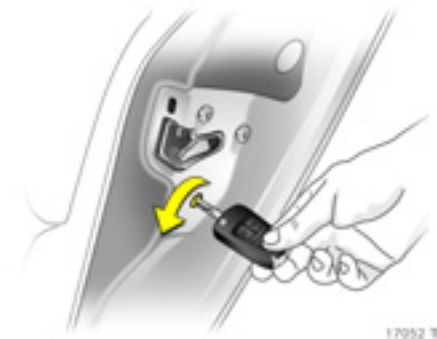

Child safety locks ✳

Warning

Use the child safety lock whenever children are occupying the rear seats. Disregard may lead to injuries or endanger life. Vehicle passengers should be informed accordingly.

Using key or screwdriver, turn knob on rear door lock from the vertical position: door cannot be opened from inside.

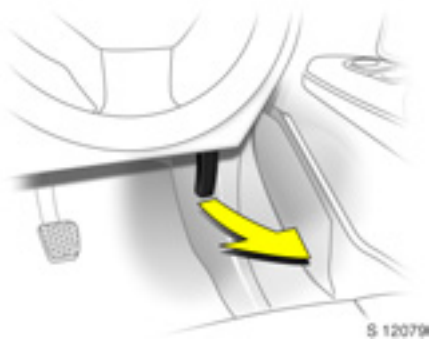

Bonnet

To open the bonnet, pull the release lever located on the driver's side below the instrument panel. The bonnet will then be unlocked and will partially open. Return release lever to its original position.

There is a safety catch on the underside of the bonnet: lift this upwards and open the bonnet.

Dirt or snow on the bonnet can slide onto the windscreen when opened and block the air intake.

Air intake – page 177.



The bonnet is held open automatically ✳.

In another design, to lock the bonnet in the open position, insert the rod lying across the radiator into the small slot on the bonnet underside. Press rod firmly into its holder before closing.

Lower the bonnet and allow it to drop into its catch.

Check that the bonnet is locked in position by pulling at its front edge. If it is not engaged, repeat the procedure.

Seats, Interior

| | |
|--|-----|
| Head restraints | 88 |
| Armrest * at driver's seat | 90 |
| Adjusting the rear row of seats * | 90 |
| Armrest * in the rear backrest | 90 |
| Luggage compartment enlargement, Hatch | 91 |
| Luggage compartment enlargement, Estate without adjustable rear row of seats | 92 |
| Luggage compartment enlargement, Estate with adjustable rear row of seats | 94 |
| Extending the luggage compartment, Astra TwinTop | 97 |
| Folding down the front passenger seat * | 97 |
| Luggage compartment cover | 98 |
| Safety net *, Estate | 99 |
| Luggage compartment grille *, Van. | 101 |
| Rails and hooks in the luggage compartment *, Estate | 102 |
| FlexOrganizer *, Estate | 102 |
| Lashing eyes * | 103 |
| Cargo box * | 103 |
| Luggage compartment blind, Astra TwinTop | 104 |
| Easy Load | 104 |
| Notes on loading the vehicle | 106 |
| Cigarette lighter * | 107 |
| Accessory socket * | 107 |
| Ashtray * | 108 |
| Foldaway tables * | 109 |

| | |
|----------------------------|-----|
| Head restraints | 88 |
| Stowage compartments | 110 |
| Sun visors | 110 |



Front seat adjustment

see pages 3, 4.

Seat position

Adjust driver's seat such that with the driver sitting upright the steering wheel is held in the area of its upper spokes with the driver's arms slightly bent.

Push passenger seat as far back as possible.

The seat backrests must not be tilted too far back (recommended tilting angle approx. 25 °).

⚠ Warning

Failure to observe the descriptions could lead to injuries which could be fatal. Vehicle passengers should be informed accordingly before starting off.

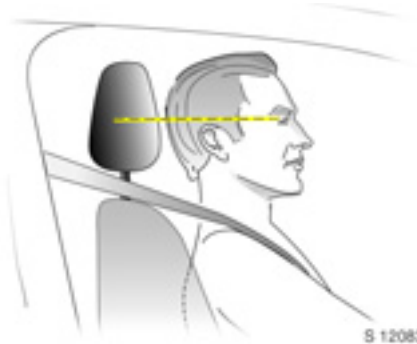

Head restraints

The middle of the head restraint should be at eye level. If this is not possible for extremely tall persons, set to highest position, and set to lowest position for small persons.

⚠ Warning

Failure to observe the descriptions can lead to injuries which could be fatal. Vehicle passengers should be informed accordingly before moving away.

Removal, see page 89.

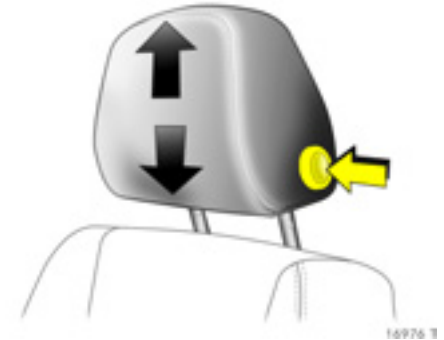

To adjust front head restraints (all variants) and outboard rear head restraints Hatch and Estate

To adjust, press button on side and adjust height.

To fold down the backrests – page 91 or improve visibility when the rear seats are not occupied, remove the head restraints or push them all the way down.

If the seats are occupied, set height according to body size.

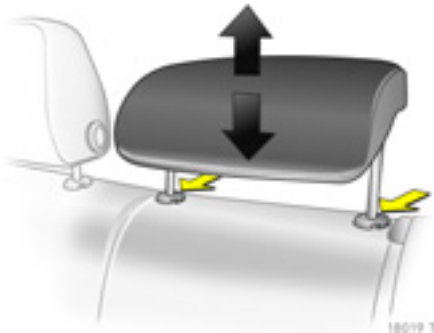

To adjust the centre rear head restraint ✱, Hatch and Estate

To adjust, pull the head restraint up or press the catch to release. Then push the head restraint down.

To fold down the backrest – page 91 or improve visibility when the centre rear seat is not occupied, remove the head restraint or push it all the way down.

If the seat is occupied, set height according to body size.



To adjust the rear head restraints ✱, Astra TwinTop

To adjust, pull the head restraint up or press the two catches to release. Then push the head restraint down.

To improve visibility when the rear seats are not occupied, push the head restraints all the way down.

If the seats are occupied, set height according to body size.

Do not place any objects on the cover behind the head restraints or between the head restraints and the anti-roll bars ✱.

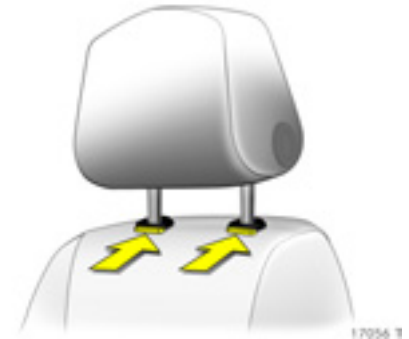

Removing the head restraints

Press and release the two catches. Pull and remove the head restraint.

To fold down the backrests ✱ – page 91, push the rear head restraints all the way down or remove.

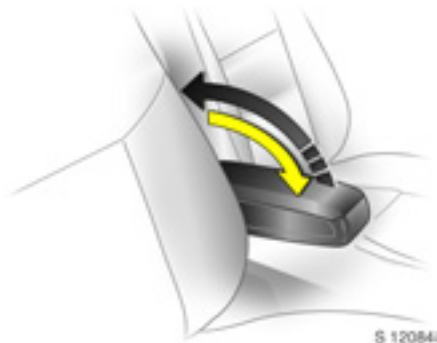

Armrest * at driver's seat

Push raised armrest backward against resistance and fold down.

The armrest can be moved to different positions in stages by lifting it.

Stowage compartment in armrest,
– page 110.

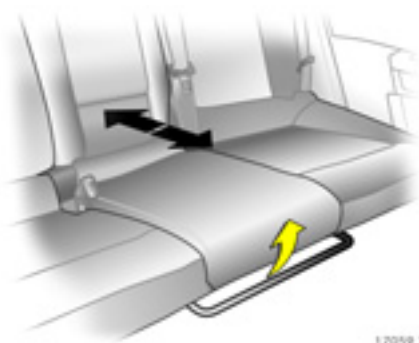

Adjusting the rear row of seats *

Pull the handle below the seat to slide the seat bench to the desired position.

Release the handle and engage the seat bench.



Armrest * in the rear backrest

Fold down the armrest, pulling the strap obliquely down (45°).

When the centre rear seat is in use or the rear backrests are folded, fold the armrest up.

A flap located behind the armrest facilitates transport of long, narrow objects
– see page 96.



Astra TwinTop

Pull the armrest by the strap, pivot it down and position on the sit with the flat side up.

The armrest is held in place on the backrest with a retaining strap. To fully remove the armrest, disengage the bracket at the retaining strap.

A flap located behind the armrest facilitates transport of long, narrow objects – page 97.



Luggage compartment enlargement, Hatch

Folding the backrest

Pushing rear head restraints all the way down or remove – page 88.

Slide front seat forward slightly.

Disengage the backrest (single or split *) using the pushbutton and fold it down onto the seat cushion.

Return front seat to desired position.

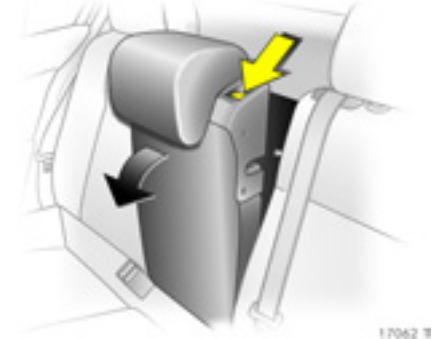

Fold down centre backrest *

Push head restraint all the way down – page 89.

Disengage backrest using handle and fold onto seat cushion.

Folding down the centre seat backrest makes it possible to load longer objects. The outer seats can still be used for occupants.

Warning

The load must not obstruct the operation of the pedals, the handbrake or the gears or restrict the driver's freedom of movement. Do not place loose objects in the interior.

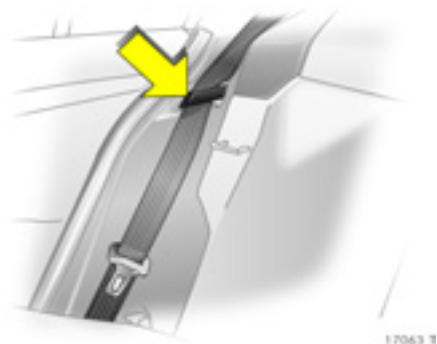

Restoring backrest to an upright position
Guide the seat belt through the side bracket to protect against damage.

Restore the backrest to an upright position and audibly engage.

The three-point seat belt for the centre rear seat can only be pulled from its inertia reel if the backrest is properly engaged.

Notes on loading
– page 106.

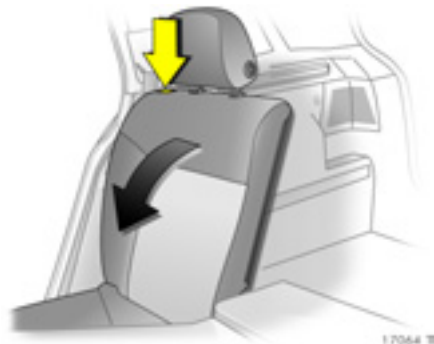

Luggage compartment enlargement, Estate without adjustable rear row of seats

Fold the backrest onto the seat cushion

Push the rear head restraints all the way down or remove – page 88. Detach the hooks of the luggage compartment cover from the head restraints – page 99.

Slide front seat forward slightly.

Disengage the backrest (single or split) using the pushbutton and fold it down onto the seat cushion.

Return front seat to desired position.

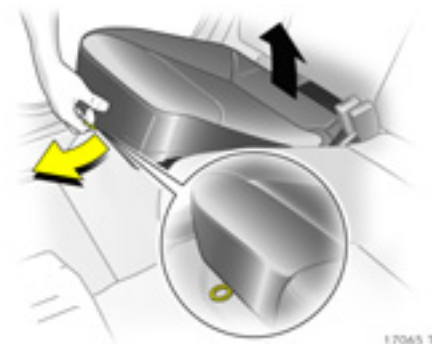

Raise the seat cushion and fold the backrest

Pull the strap on the seat cushion and lift the backrest forwards (single or split).

Detach the hooks of the luggage compartment cover from the head restraints – page 99.

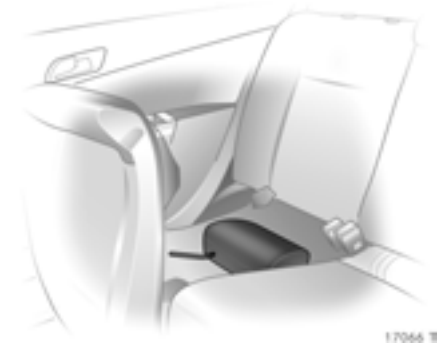

Remove the outer rear head restraints. Push the centre head restraint all the way down – page 88.

Stow the removed head restraints in the cavity below the raised seat cushions.



Disengage the backrest (single or split) using the pushbutton, fold it forward and engage.



Fold down centre backrest *

Push head restraint all the way down – page 89.

Disengage backrest using handle and fold onto seat cushion. If the seat cushion is raised, fold it forward until it engages.

Folding the centre seat backrest makes it possible to load longer objects. The outer seats can still be used for occupants.

⚠ Warning

The load must not obstruct the operation of the pedals, the handbrake or the gears or restrict the driver's freedom of movement. Do not place loose objects in the interior.



Restoring the backrests or seat cushions ✱ to their original position

Guide the seat belt through the side bracket to protect against damage.

To restore the backrest to an upright position, fold up, pressing the button on the backrest. Audibly engage the backrest in an upright position.

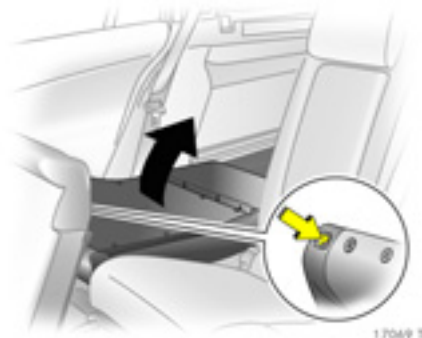

Raised seat cushions : Insert and adjust head restraints in backrests – pages 5, 88. Fold back seat cushions, making sure the belt buckles are properly positioned.

Attach the hooks of the luggage compartment cover to the head restraints – page 99.

The three-point seat belt for the centre rear seat can only be pulled from its inertia reel if the backrest is properly engaged.

Safety net ✱
– page 99.

Notes on loading
– page 106.

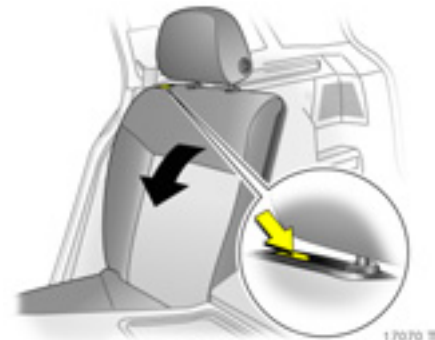

Luggage compartment enlargement, Estate with adjustable rear row of seats

Fold backrests onto seat cushions

Push the rear head restraints all the way down or remove – page 88. Detach the hooks of the luggage compartment cover from the head restraints – page 99.

Slide front seat forward slightly.

Disengage the backrest (single or split) using the sliders and fold it down onto the seat cushion.

Return front seat to desired position.

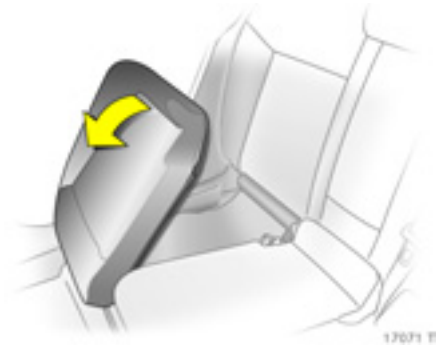

Raise the seat cushion and fold the backrest

Lift rear seat cushions forward, single or split.

Detach the hooks of the luggage compartment cover from the head restraints – page 99.

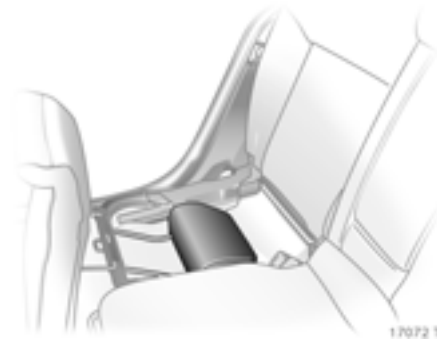

Remove the outer rear head restraints. Push the centre head restraint all the way down – page 88.

Stow the removed head restraints in the cavity below the raised seat cushions.

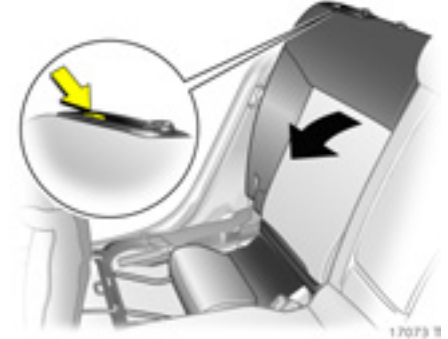

Disengage the backrest (single or split) using the sliders, fold it forward and engage.



Loading option behind the armrest in the rear seat backrest *

Fold down the armrest, pulling the strap obliquely down (45°).

Pull the handle and fold down the cover.

Folding down the cover makes it possible to load long, narrow objects. The outer seats can still be used for occupants.

⚠ Warning

The load must not obstruct the operation of the pedals, the handbrake or the gears or restrict the driver's freedom of movement. Do not place loose objects in the interior.

To restore, fold the armrest back in position.



Restoring the backrests or seat cushions * to their original position

Guide the seat belts through the side brackets to protect against damage.

To restore the backrest to an upright position, fold up, disengaging the backrest at the sliders. Audibly engage the backrest in an upright position.



Raised seat cushions : Insert and adjust head restraints in backrests – pages 5, 88. Fold back seat cushions, making sure the belt buckles are properly positioned.

Attach the hooks of the luggage compartment cover to the head restraints – page 99.

The three-point seat belt for the centre rear seat can only be pulled from its inertia reel if the backrest is properly engaged.

Safety net *
– page 99.

Notes on loading
– page 106.



18020 T

Extending the luggage compartment, Astra TwinTop

Loading area between rear seats
 Pull out the armrest by the strap.

The armrest is held in place on the backrest with a retaining strap. To fully remove the armrest, disengage the bracket at the retaining strap.

Pull the handle and fold down the cover.

⚠ Warning

The load must not obstruct the operation of the pedals, the handbrake or the gears or restrict the driver's freedom of movement. Do not place loose objects in the interior.

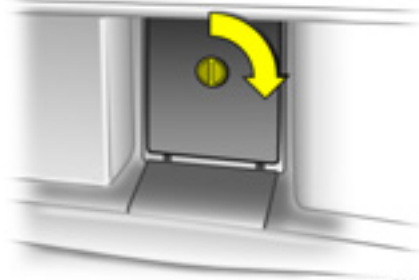

17954 T

Cover behind armrest can be locked from luggage compartment * : turn handle 90°:

- Locked = Handle horizontal
- Unlocked = Handle vertical

Notes on loading
 – page 106.



S 11569

Folding down the front passenger seat *

Push front passenger seat head restraint all the way down or remove – pages 5, 88.

Push front passenger seat back.

Fold front passenger seat forward by raising release lever.

Raise front passenger seat backrest
 Raise release lever and engage passenger seat back audibly.



Luggage compartment cover

Hatch

To remove, unhook the retaining straps from the tailgate.

Pull cover from the side guides.

Fit in reverse order.

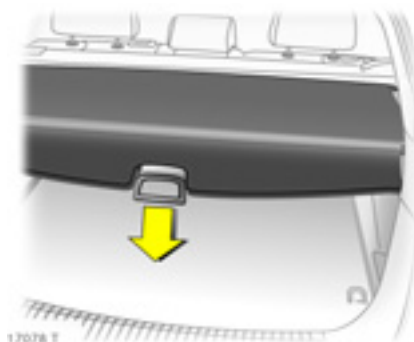

Estate

To open:

Press handle on luggage compartment cover down. The cover automatically unrolls.

To close:

Press handle on luggage compartment cover rearwards; the cover automatically engages in its end position.

Do not place any heavy or sharp-edged objects on the cover.



To cover the gap between the luggage compartment cover and the rear backrests, there is a cover on the cartridge. Attach the two hooks of the cover to the head restraint guide rods. If the safety net is mounted, run the hooks through the net mesh.

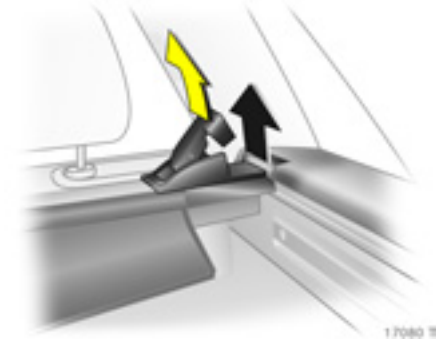

Removing

Open the luggage compartment cover and detach the hooks from the head restraints.

Move release lever on right side of luggage compartment cover upward. Lift right cover and remove from brackets.

Fitting

Insert the luggage compartment cover in the recess on the left, press the release lever on the right side upward, insert the cover in the recess on the right, engage and press the lever down.

Attach the hooks on the head restraints (see Fig. 17079 T).

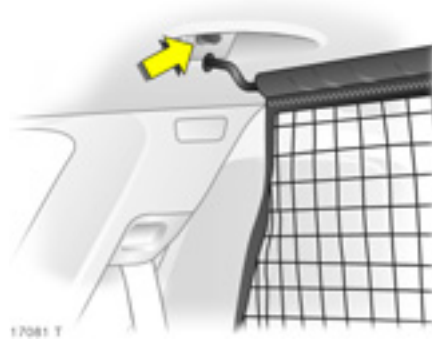

Safety net *, Estate

The safety net can be mounted behind the rear seats or, if the rear seat backrests are folded and the seat cushions raised, behind the front seats.

Passengers must not be carried behind the safety net.

Fitting behind the rear seats

Remove the luggage compartment cover - see left column.

Unroll the safety net.

There are two brackets in the roof frame. Hook the net rods into the brackets on one side and then the other. Slide forward to engage.



Fixed rear row of seats: Extend the safety net straps by adjusting the strap at the upper fastener in the loop of the strap (see Fig. 17085 T). Attach the straps in the eyelets in the floor on the right and left.

Adjustable rear row of seats ✱: Extend the safety net straps by adjusting the strap at the upper fastener in the loop of the strap (see Fig. 17085 T). Attach the straps in the eyelets on the back of the right and left rear seat backrest.

Install the luggage compartment cover - see left column.

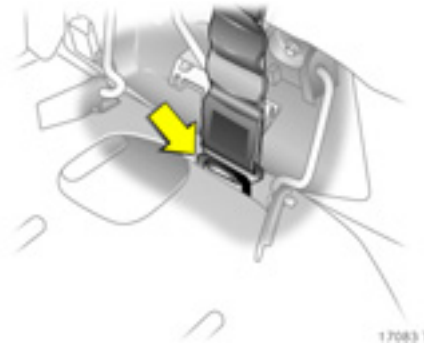

Fitting behind front seats

Raise the rear seat cushions – pages 92 and 95.

Unroll the safety net.

There are two brackets in the roof frame above the front seats. Hook the net rods into the brackets on one side and then the other. Slide forward to engage.

Fixed rear row of seats: Extend the safety net straps by adjusting the strap at the upper fastener in the loop of the strap (see Fig. 17085 T). Attach the straps in the eyelets in the floor on the right and left.

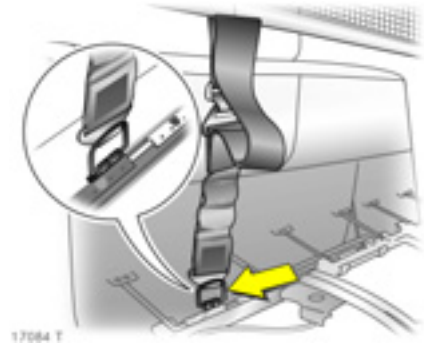

Adjustable rear row of seats ✱: Extend the safety net straps by adjusting the strap at the upper fastener in the loop of the strap (see Fig. 17085 T). Attach the straps in the brackets on the right and left raised seat cushions.

Remove the outer rear head restraints and fold the backrests forward – pages 92 and 94.

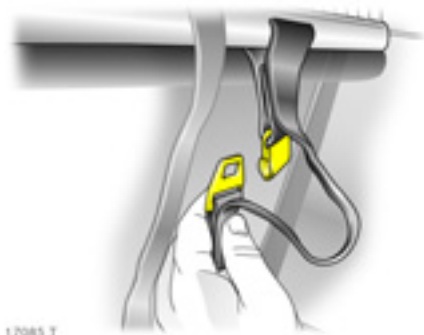

Removing

Detach the safety net belt straps by tipping up the length adjuster.

Unhook the safety net rods from the brackets in the roof frame. Roll up the net and secure with a strap.

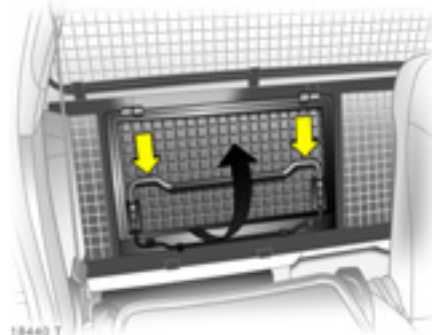

Luggage compartment grille ✳, Van

To transport long objects, part of the luggage compartment grille behind the passenger seat can be opened:

Release passenger seat back and fold forward.

Press bracket down and fold grille section up.

Lock grille in open position.

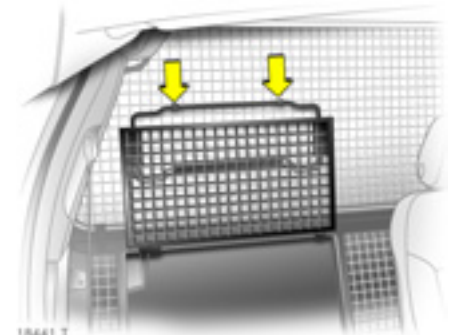

To close the grille section from the open position, press bracket down, fold down grille and lock.

Check that the closed grille is properly locked.

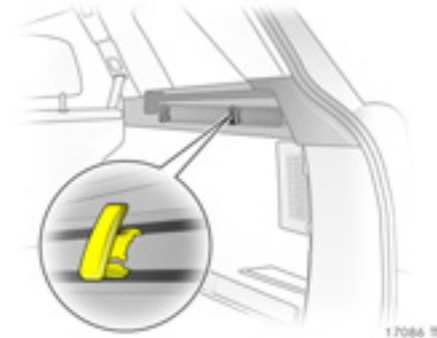

Rails and hooks in the luggage compartment *, Estate

The side walls of the luggage compartment house two rails. Insert the hooks in the desired position in the rails: insert the hook in the upper groove on the rail and press in the lower groove.

Pull off the hook to remove.

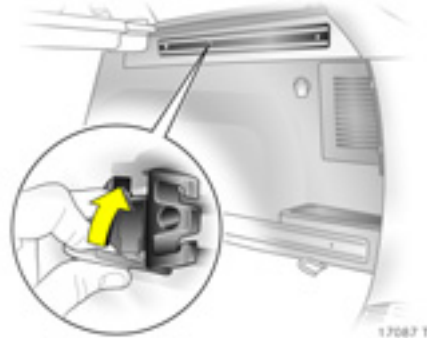

FlexOrganizer *, Estate

Flexible system for dividing the luggage compartment or securing loads in an Estate.

The system consists of

- Adapters
- variable partition net
- mesh pockets for the side walls
- Hooks in the luggage compartment

Components are mounted in the two guide rails in the side walls of the luggage compartment by means of adapters or hooks.

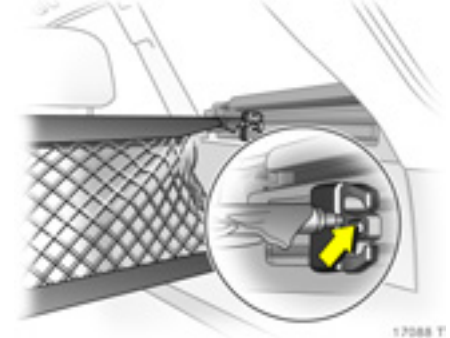

Variable partition net

Insert an adapter in each rail: Fold up handle plate, insert adapter in upper and lower groove of rails, move to desired position. To lock the adapter, swivel the handle plate up. Compress the rods of the partition net slightly and insert in corresponding openings of the adapter. The longer rod must be inserted in the upper adapter.

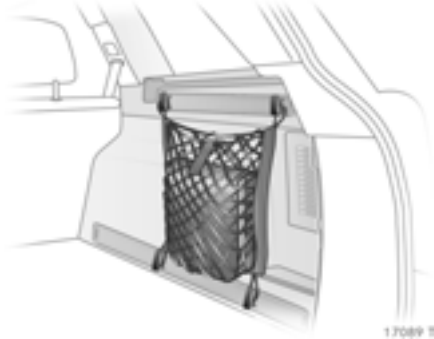

Hooks and mesh pocket

Insert the hooks in the desired position in the rails: insert the hook in the upper groove on the rail and press in the lower groove. The mesh pocket can be hung from the hooks.

Removing

Press the partition net rods together and remove from the adapters.

Adapter: fold open the retainer, release the adapter from the lower groove and remove from the upper groove.

Release the hooks from the rails.

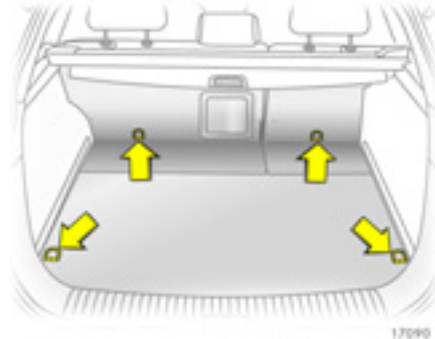

Lashing eyes *

in the luggage compartment are intended for fixing lashing straps * or a luggage net *. They secure transport items from slipping.

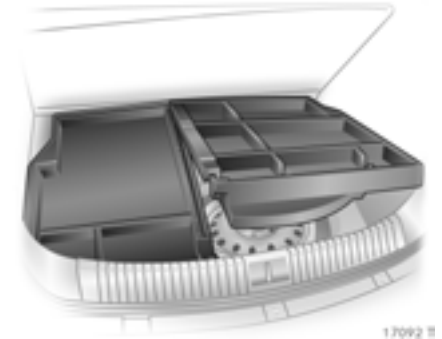

Cargo box *

Foldable box under the floor cover used to divide the luggage compartment.

The cargo box may only be loaded when the backrests are engaged in an upright position.

To remove the cargo box floor cover, remove first the right half then the left half. For models with towing equipment, first release the coupling ball bar fixing strap and thread this through the eye – page 242. Installation in the reverse order.



18024 T

Luggage compartment blind, Astra TwinTop

To open:

Disengage the luggage compartment blind from the recess on the right and left. Rolls up automatically.

To close:

Grasp the handle, pull the blind towards the rear of the vehicle and engage in the recess on the right and left.

Do not place any objects on the blind.

There must be no objects outside of or on top of the luggage compartment blind when the roof is open or in the process of opening.

The roof can only be operated with the luggage compartment blind engaged in the recess.



17978 T

Easy Load (Electrically operated loading aid for the luggage compartment of the Astra TwinTop)

The loading aid makes it possible to comfortably load the luggage compartment when the roof is open. The press of a button will raise the roof folded up in the luggage compartment 25 cm. This enlarges the load opening of the luggage compartment.

- Open the boot lid.
- Unhook the luggage compartment blind and attach it to the rear window frame.



17977 T

- Briefly press button : The folded roof is raised. The roof remains in this end position for approx. 9 minutes.

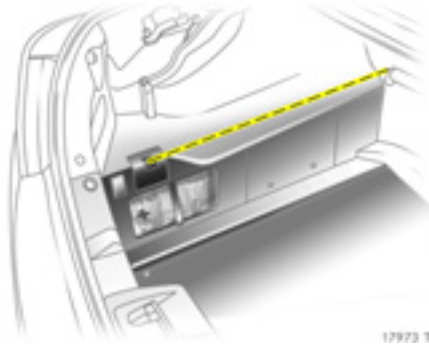

- Load luggage compartment at most to marked load height, otherwise the roof and load could be damaged.
- Suspend the luggage compartment blind from the rear window frame, and engage in recesses on right and left. The luggage compartment blind must be flat; objects underneath it must not push it upwards.
- Briefly press button : The folded roof is lowered.
- Close the boot lid only after the confirmation signal has sounded. Otherwise the roof could be damaged.

Warning



Take care when operating the loading aid. Risk of injury.

Make sure that nothing could be pinched.

Make sure no one is in the action zone during operation. Risk of injury.

This is especially important for children. Inform passengers accordingly.

Note

- Do not place objects on or near the luggage compartment blind.
- The folded roof can only be lowered when the blind is closed. Otherwise, a warning buzzer will sound three times.
- Movement can only be stopped by pressing button . Holding the button depressed will change the direction of movement.
- A confirmation signal sounds in the upper and lower end positions.
- Only close the boot lid once the confirmation signal has sounded to indicate that the loading aid is in its lower end position.
- If the loading aid is not in its lower end position when the boot lid is closed, a warning tone sounds or the boot lid is blocked mechanically  – page 153.
- Do not touch moving parts.
- One minute before the end of the hold time for the raised loading aid, a warning buzzer will sound to remind you to lower the roof.
- The loading aid is only operable when the vehicle is unlocked.

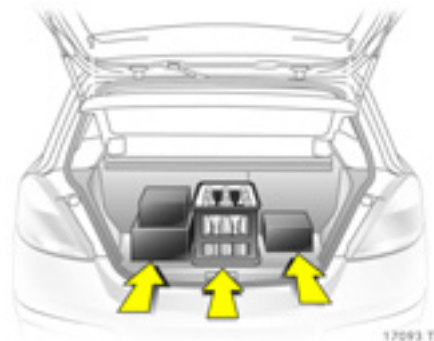

Notes on loading the vehicle

- Heavy objects in the luggage compartment should be placed against the engaged rear seat backrests * or, if the rear seat backrests are folded down, against the front seat backrests. If objects are to be stacked, the heavier objects should be placed at the bottom. Unsecured objects in the luggage compartment would be thrown forward with great force in the event of heavy braking, for example.
- Secure objects with lashing straps * attached to lashing eyes – see page 103. If heavy loads slip when the vehicle is braked heavily or driven around a bend, the handling of the vehicle may change.
- Estate: mount the safety net * when transporting objects in the luggage compartment – page 99.
- Estate: close the luggage compartment cover so the rear window does not reflect the objects.
- If the backrests are not folded down when transporting objects in the luggage compartment, they must be engaged in their upright position * – pages 92, 94, 96.
- Do not allow the load to protrude above the upper edge of the rear seat backrests, or above the upper edge of the front seat backrests if the rear seat backrests * are folded down.
- Astra TwinTop: Note the maximum loading height when the roof is open (See page 104, Fig. 17973 T).
- The warning triangle * and first-aid kit (cushion) * must always be freely accessible.
- Do not place any objects in front of the rear window or on the instrument panel. They are reflected in the glass, obstruct the driver's view and will be thrown through the vehicle, for instance in the event of heavy braking.
- The load must not obstruct the operation of the pedals, the handbrake or the gears or restrict the driver's freedom of movement. Do not place loose objects in the interior.
- Astra TwinTop: Do not place any objects on the cover of the deployable anti-roll bars *, behind the rear head restraints or in the luggage compartment outside of, on or next to the luggage compartment cover.
- Do not place any objects in the deployment area of the airbags and deployable anti-roll bars * as this poses a risk of injury should the systems be triggered.
- Do not drive with luggage compartment open when transporting bulky objects, for example, since toxic exhaust fumes could penetrate the interior.
- Weights, payload and roof load – page 324.
- Driving with a roof load – pages 200, 203, 238, increases the sensitivity of the vehicle to cross-winds and has a detrimental effect on vehicle handling owing to the vehicle's higher centre of gravity.

Warning

Failure to observe these descriptions can lead to injuries which may be fatal. Vehicle passengers should be informed accordingly.

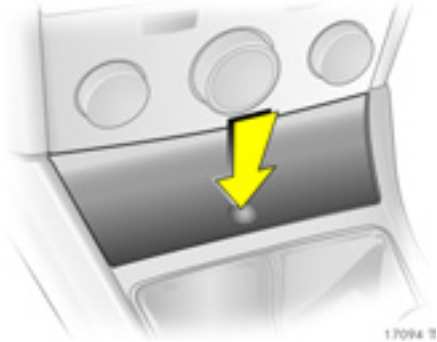

Cigarette lighter *

The cigarette lighter is located under the ashtray cover.

The cover opens when pressed at the point indicated.

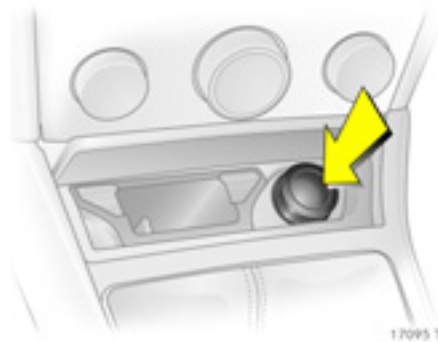

Press in cigarette lighter. Switches off automatically once the element is glowing. Pull out lighter.



Accessory socket *

Some vehicles have an accessory socket for the connection of electrical accessories instead of a cigarette lighter. Use of the accessory socket while the engine is not running will discharge the battery.

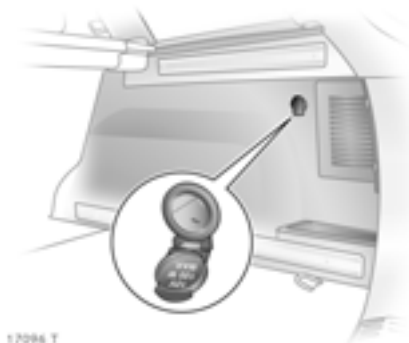

Estates have an additional accessory socket * in the luggage compartment.

Do not damage the sockets by using unsuitable plugs.

The maximum power consumption of electrical accessories must not exceed 120 watts.

Do not connect any current-delivering accessories, e.g. electrical charging devices or batteries.

Electrical accessories connected to the socket must comply with the electromagnetic compatibility requirements laid down in DIN VDE 40 839, otherwise vehicle malfunctions may occur.

If the tyre repair kit * is in operation, no consumers may be connected to the auxiliary socket.

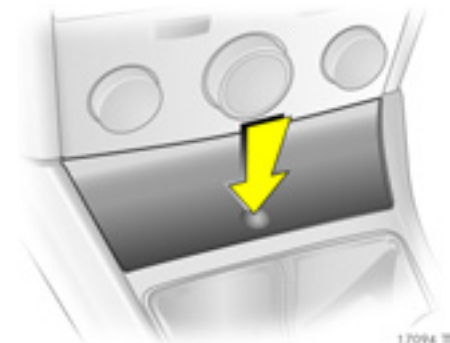

Ashtray *

To be used only for ash and not for combustible rubbish.

Warning

Failure to observe these descriptions can lead to injuries which may be fatal. Vehicle passengers should be informed accordingly.

Ashtray, front

The cover opens when pressed at the point indicated.

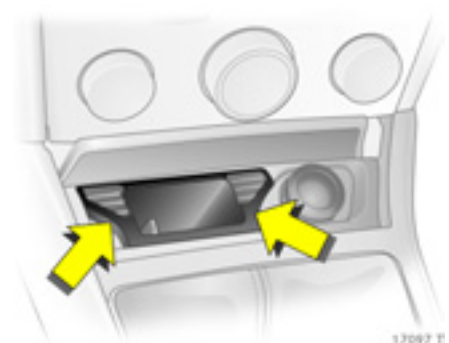

To empty, grip both sides of the ashtray insert at the spots illustrated and pull upwards.



Rear ashtray *

In the rear centre console.

Pull out the ashtray by pushing on one of the sides.



Foldaway tables *

on the front seat backrests.

Open by pulling upward until it engages.

Fold away by pressing down past the resistance point.

Do not place any heavy objects on the table.

To empty, open the ashtray, press the spring (arrow) and pull the ashtray straight out rearwards.

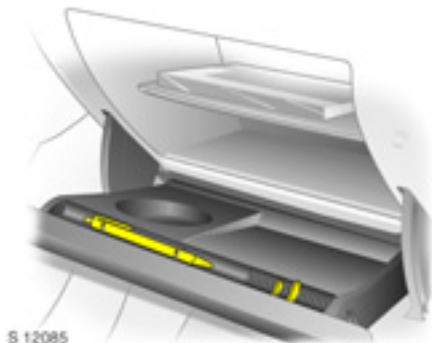

Stowage compartments

Glove compartment

To open, pull handle upwards.

The glove compartment shelf * can be removed: Disengage the shelf by pulling on the front edge.

Refit the shelf by sliding it into the side guide strips and engage it in the rear panel by pushing.

The front of the open cover houses a pen holder and a coin compartment.

Cooled glove compartment * – page 159.

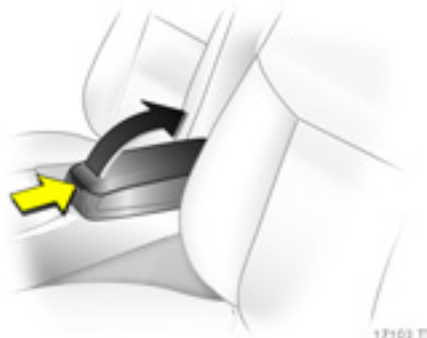

Stowage compartment in front armrest *

To open, press button and open upper part of armrest.

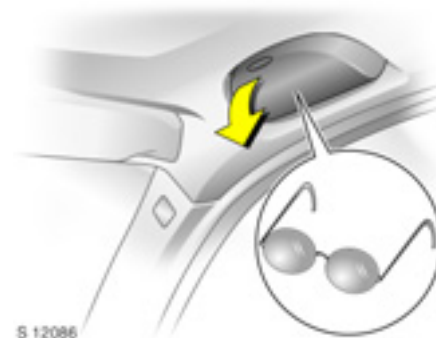

Stowage compartment for glasses *

On driver's side: fold down to open.

Do not store heavy objects in the stowage compartment.

Sun visors

Use the sun visor to protect from glare by pulling it down and swivelling it to the side *.

On vehicles with panoramic windscreen *, close the sun visors before moving the roof lining.

Safety systems

| | |
|--|-----|
| Three-point seat belts | 112 |
| Testing the belts | 112 |
| Belt tensioners..... | 113 |
| Using the belts | 115 |
| Vauxhall Full Size airbag system | 117 |
| Mounting brackets * for ISOFIX child restraint systems | 129 |
| Child restraint system *..... | 130 |
| Rollover protection system *..... | 132 |
| Exterior mirrors..... | 134 |
| Aspherical exterior mirror * | 134 |
| Automatic anti-dazzle interior mirror *..... | 134 |
| Sun visors, glove compartment | 134 |
| Hazard warning flashers | 134 |
| Head restraints | 135 |
| Safety accessories * | 135 |

Three-stage safety system

Comprising:

- three-point seat belts
- belt tensioners at the front seats
- airbag systems for the driver, front passenger and outboard rear seats *; for TwinTop *, anti-roll bars behind the backrests.

The three stages are activated in sequence depending on the severity of the accident:

- The automatic seat belt locking devices prevent the belt strap from being pulled out and thus ensure that the vehicle occupants are retained in their seats.
- The front seat belts are pulled down at the belt buckles. This means the belts fit snugly, the occupants are decelerated early with the vehicle and the body loading is reduced.
- In the event of a severe accident, the airbag systems and deployable anti-roll bars * also deploy, forming safety cushions for the occupants. The front airbags are inflated in two stages based on the severity of the collision.

Warning

The airbag systems and anti-roll bars * serve to supplement the three-point seat belts and belt tensioners. The seat belts must therefore always be worn. Disregard of these instructions could lead to injuries or endanger life. Vehicle passengers should be informed accordingly.

Read the instructions supplied with the child restraint system!



Three-point seat belts

The vehicle is equipped with three-point seat belts with automatic retractors and locking devices, allowing freedom of body movement although the spring tensioned belts always ensure a snug fit.

For information on correct seating position – pages 87, 115, 119.

The belts are locked during heavy acceleration or deceleration of the vehicle.

Warning

Always wear your seat belt, and that means also in urban traffic and when you are a rear seat passenger. It can save your life!

Pregnant women must always wear a seat belt – page 115.

In the event of an accident, persons not wearing seat belts endanger their fellow occupants and themselves.

Control indicator  for the seat belt – page 38.

Seat belts are only intended for one person. They are not suitable for anyone under 12 years of age or under 150 cm tall.

For children up to 12 years of age, we recommend the Vauxhall child restraint system – page 130.

Belt force limiters

on the front seats reduce the body load due to damped release of the belt on a collision. This means that the occupants move forward under control.

Testing the belts

Please check all parts of the belt system occasionally for damage and correct operation. Have damaged parts replaced. In case of an accident, please replace overstretched belts and triggered belt tensioners. We recommend that you consult your Vauxhall Authorised Repairer.

Do not perform any alterations on the belts, their anchorages, the automatic retractors or the belt buckles.

Make sure that belts are not damaged or trapped by sharp-edged objects.

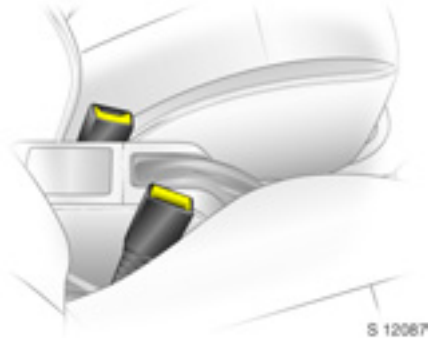

Belt tensioners

The front seat belts are fitted with belt tensioners. The seat belts are pulled down at the buckles on a front or rear impact above a certain severity. This tightens the belts.

Actuation of belt tensioners



is indicated by illumination of control indicator , see next column.

The belt tensioners must be replaced after activation. We recommend that you consult your Vauxhall Authorised Repairer.

Important information – page 114.



Control indicator for belt tensioners

The function of the belt tensioners is monitored electronically together with the airbag systems and the deployable anti-roll bars . Their operational readiness is indicated by control indicator  in the instrument panel. When the ignition is switched on, the control indicator illuminates for approx. 4 seconds. If it does not illuminate, does not go out after 4 seconds or illuminates whilst driving, there is a fault in the belt tensioner or and airbag systems or in the deployable anti-roll bars  – page 123. The systems may fail to trigger in the event of an accident.

Deployment of the belt tensioners is indicated by continuous illumination of .

Warning

Have the cause of the fault remedied. We recommend that you consult your Vauxhall Authorised Repairer.

The system's integrated self-diagnostics allows faults to be quickly remedied. Have your Car Pass on hand when consulting a Vauxhall Authorised Repairer.

Note

- Accessories and other objects not specifically approved for your vehicle type must not be affixed or placed within the action zone of the belt tensioners (near the belt buckles) as this could result in injury if the belt tensioners are triggered.
- Do not make any modifications to the components of the belt tensioners, as this will render the vehicle unroadworthy.

| |
|--|
|  Warning |
| Incorrect handling (e.g. removal or fitting of belts or belt buckles) can trigger the belt tensioners with risk of injury. |

- The belt tensioner and airbag system control electronics can be found in the centre console area. In order to avoid malfunctions, do not store magnetic objects in this area.
- When using the rear seats, ensure that the front belt components are not damaged by shoes or other objects. Avoid dirt getting into the belt winders.
- We recommend that you have the front seats removed by a Vauxhall Authorised Repairer.
- The belt tensioners are for single use only, indicated by the lighting of the control indicators . Replace triggered belt tensioners. We recommend your Vauxhall Authorised Repairer.
- Applicable safety directives must always be observed when disposing of the vehicle. For this reason, disposal should be performed by an authorised recycling company. We recommend that you consult your Vauxhall Authorised Repairer.



Using the belts

Fitting seat belts

Pull the belt out of the retractor and guide it across the body, making certain that it is not twisted.

Insert the latch plate into the buckle. The front seat backrest must not be tilted back too far or the seat belt will not operate properly. The recommended angle of inclination is 25°. Make sure that the lap belt is not twisted and that it fits snugly across the body. Tension the belt frequently while driving by tugging the diagonal part of the belt.



Warning

On pregnant women in particular, the lap belt must be positioned as low as possible across the pelvis so as not to put too much pressure on the abdomen.

Bulky clothing prevents the belt from fitting properly. The belt must not rest against hard or fragile objects in the pockets of your clothing (e.g. ballpoint pens, keys, spectacles) because these could cause injury. Do not place any objects (e.g. handbags, mobile phones) between the belt and your body.



Height adjustment*

of front seat belt upper anchorage point:

1. Pull belt out slightly.
2. Press down button on adjuster slide.
3. Move adjuster slide up or down.
4. Allow sliding adjuster to audibly latch.

Do not adjust height while driving.





Adjust height such that the belt passes over the wearer's shoulder and rests against the shoulder. It must not pass over the neck or upper arm.



Removing the belt

To remove the belt, depress the red pushbutton on the buckle; the belt will retract automatically.

Three-point seat belts on rear outer seats

When not in use, pass seat belts through side holders * as shown in Fig. 17063 T on page 92.

Three-point seat belt of centre rear seat *

The belt can only be pulled from the inertia reel when the backrests are upright and properly engaged – page 91.

Three-point seat belts of rear seats in Astra TwinTop

In order to prevent the flutter noise caused by the belts when the roof and windows are open, the seat belts can be secured behind the armrest when the rear seats are not occupied.

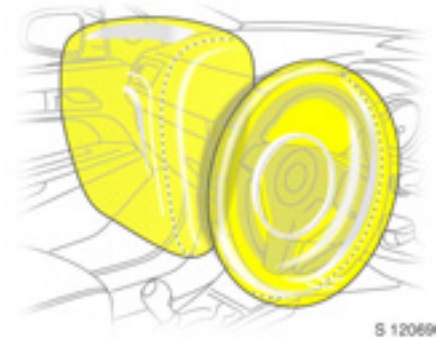

Vauxhall Full Size airbag system

The Vauxhall Full Size airbag system comprises several individual systems.

Front airbag system

The front airbag system will be triggered in the event of a serious accident involving a frontal impact and forms safety cushions for the driver and front passenger. The forward movement of the driver and front passenger is checked and the risk of injuries to the upper body and head thereby substantially reduced.

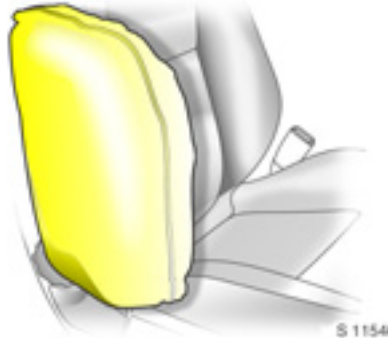

Side airbag system *

The side airbag is triggered in the event of a side-on collision to form a safety cushion for the driver or front passenger in the respective door area. This substantially reduces the risk of injury to the upper body and pelvis.

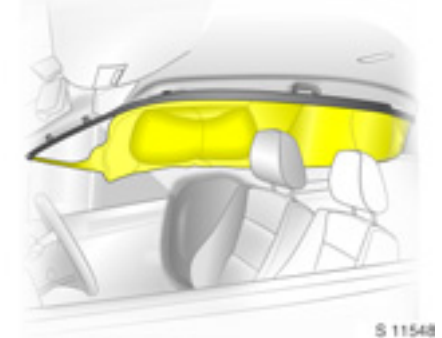

Curtain airbag system *

The curtain airbag system triggers in case of a side-on collision and provides a safety barrier in the head area on the respective side of the vehicle. This reduces the risk of injury to the head considerably in case of a side-on collision.



Vauxhall Full Size airbag system





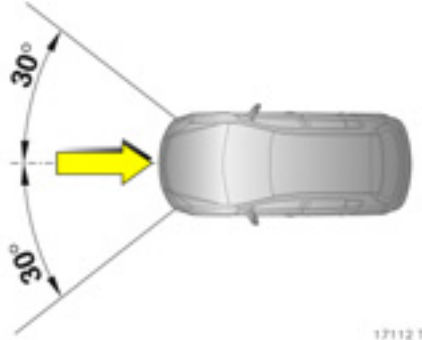

Front airbag

The front airbag system is identified by the word **AIRBAG** on the steering wheel and above the glove compartment.





The front airbag system comprises:

- an airbag with inflator in the steering wheel and a second one in the instrument panel
- control electronics with impact sensors
- control light for airbag systems  in instrument panel,



- seat occupancy recognition ,
 - the control indicator for Vauxhall child restraint systems   with transponders  in the instrument panel.
- The front airbag system will be triggered:
- depending on the severity of the accident
 - depending on the type of impact
 - within the range shown in the illustration
 - independent of side airbag  and curtain airbag system .

Exception:

Passenger seat with seat occupancy recognition system . The seat occupancy recognition system deactivates the front and side airbags on the passenger side  if the front passenger seat is unoccupied or a Vauxhall child restraint system with transponders  has been fitted to the front passenger seat. Seat occupancy recognition, see page 124. Vauxhall child restraint system with transponders  – page 130.

Examples of events triggering the front airbag system:

- Impact against a non-yielding obstacle: the front airbags are triggered at low vehicle speed.
- Impact against a yielding obstacle (such as another vehicle): the front airbags are only triggered at a higher vehicle speed.

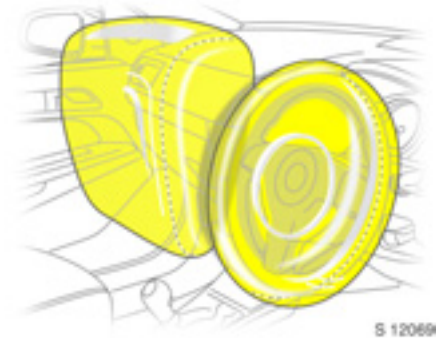

S 12069

When triggered, the front airbags inflate in milliseconds to form a safety cushion for the driver and front passenger. The forward movement of the front seat occupants is checked, thereby substantially reducing the risk of injury to the upper body and head.

No impairment of view will occur, because the airbags inflate and deflate so quickly that it is often not even noticed in an accident.



S 11538

Warning

The front airbag system provides optimum protection when the seat, backrest and head restraint are correctly adjusted: Adjust the driver's seat according to the occupant's height such that with the driver sitting upright the steering wheel is held in the area of its upper spokes with the driver's arms slightly bent. The passenger seat should be as far back as possible, with the backrest upright – pages 3, 87. Do not place the head, body, hands or feet on the covers of the airbags systems.

Do not place any objects in the area in which the airbags inflate. Important information – page 126.

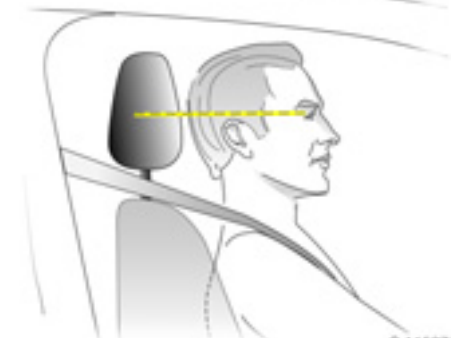

Warning

The three-point seat belt must be correctly fitted – page 115.

The front airbag system will not be triggered in the event of

- the ignition is switched off
- minor frontal collisions
- accidents in which the vehicle overturns
- collisions involving a side or rear impact that is to say, if it would not be of benefit to the occupants.

⚠ Warning

Seat belts must therefore always be worn. The front airbag system serves to supplement the three-point seat belts. If you do not wear your seat belt you risk being seriously injured, or even thrown from the vehicle, in the event of an accident.

In the event of an accident the belt helps to keep you in the correct seating position, so that the front airbag system can provide you with effective protection.

In addition, the front airbag system will not be triggered for the front passenger in versions with seat occupancy recognition * if

- the front passenger seat is unoccupied
 - there is a properly fitted Vauxhall child restraint system with transponders *.
- Seat occupancy recognition – page 124.
Vauxhall child restraint system with transponders * – page 130.

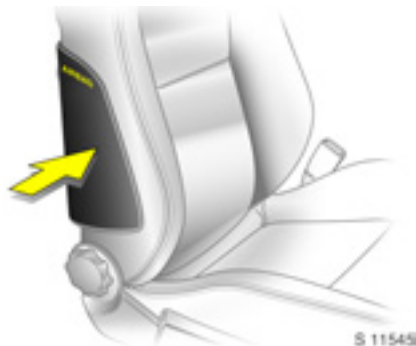

Side airbag *

The side airbag system is identified by the word **AIRBAG** on the outboard sides of the front seat backrests.

The side airbag system comprises:

- an airbag with inflator in the back of the driver's and front passenger seat respectively
- the control electronics
- the side impact sensors
- control light for airbag systems ⚡ in instrument panel,
- seat occupancy recognition *,
- the control indicator for Vauxhall child restraint systems ⚡ with transponders * in the instrument panel.

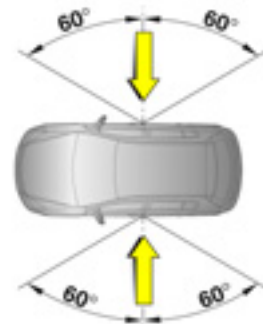

The side airbag system will be triggered:

- depending on the severity of the accident
- depending on the type of impact
- within the range shown in the illustration on the centre door pillar of the driver's or front passenger side,
- independently of the front airbag system.

Exception: Passenger seat with seat occupancy recognition system *. The seat occupancy recognition system deactivates the front and side airbags on the passenger side * if the front passenger seat is unoccupied or a Vauxhall child restraint system with transponders * has been fitted to the front passenger seat. Seat occupancy recognition, – page 124. Vauxhall child restraint system with transponders * – page 130.

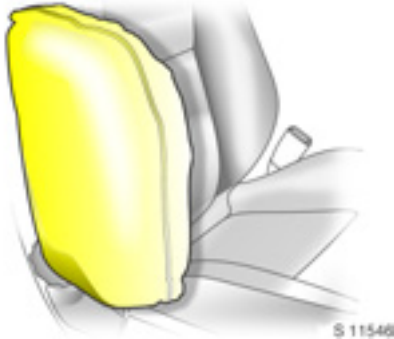

When triggered, the side airbag inflates within milliseconds to form a safety cushion for the driver or front passenger in the respective door area. This substantially reduces the risk of injury to the upper body and pelvis in the event of a side-on collision.

Warning

There must be no objects in the area in which the airbag inflates or in the area between the seat backs and the vehicle body. Do not place the hands or arms on the covers of the airbag systems.

Important information – page 126.

The three-point seat belt must always be correctly fitted – page 115.

The side airbags will not be triggered in the event of

- the ignition is switched off
- frontal collisions
- accidents in which the vehicle overturns
- collisions involving a rear impact
- Side-on collisions outside the passenger cell.

In addition, the side airbag system * will not be triggered for the front passenger in versions with seat occupancy recognition * if

- the front passenger seat is unoccupied
- there is a properly fitted Vauxhall child restraint system with transponders * .
Seat occupancy recognition – page 124.
Vauxhall child restraint system with transponders * – page 130.



S 11547

Curtain airbag ✳

The curtain airbag system is identified by the word **AIRBAG** on the roof pillar trim.

The curtain airbag system comprises:

- an airbag with inflator in the roof frame on the driver's and front passenger side respectively
- the control electronics
- the side impact sensors
- control light for airbag systems ✳ in instrument panel.

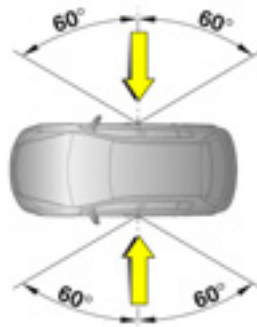

17114 B

The curtain airbag system will be triggered:

- depending on the severity of the accident
- depending on the type of impact
- within the range shown in the illustration on the centre door pillar of the driver's or front passenger side,
- together with the side airbag system ✳,
- irrespective of seat occupancy recognition ✳,
- independently of the front airbag system.

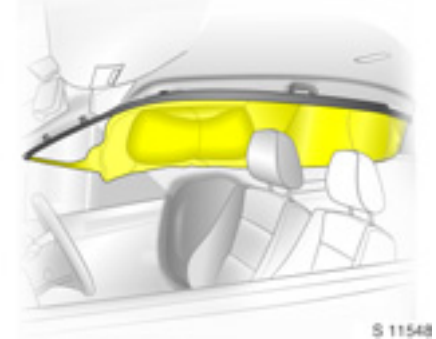

S 11548

When the curtain airbag is triggered it inflates within milliseconds and provides a safety barrier in the head area on the respective side of the vehicle. This reduces the risk of injury to the head considerably in case of a side impact.

Warning

There must be no objects in the area in which the airbag inflates. Do not place the hands or arms on the covers of the airbag systems. Important information – page 126.





The three-point seat belt must always be correctly fitted – page 115.

The curtain airbags will not be triggered in the event of

- the ignition is switched off
- frontal collisions
- accidents in which the vehicle overturns
- collisions involving a rear impact
- Side-on collisions outside the passenger cell.



Control indicator for airbag systems

The function of the airbag systems is monitored electronically together with the seat occupancy recognition  and belt tensioner systems  and the deployable anti-roll bars. Their operational readiness is indicated by control indicator . When the ignition is switched on, the control indicator illuminates for approx. 4 seconds. If it does not illuminate, does not go out after 4 seconds or illuminates whilst driving, there is a fault in the airbag systems, seat occupancy recognition  or belt tensioner systems, or in the deployable anti-roll bars , – page 113. The systems may fail to trigger in the event of an accident.

Deployment of the airbags is indicated by continuous illumination of .



Warning

Have the cause of the fault remedied. We recommend that you consult your Vauxhall Authorised Repairer.

The system's integrated self-diagnostics allows faults to be quickly remedied. Have your Car Pass on hand when consulting a Vauxhall Authorised Repairer.

Seat occupancy recognition *

The seat occupancy recognition system deactivates the front and side airbags * for the front passenger if the front passenger seat is not occupied or a Vauxhall child restraint system with transponders * is fitted on the front passenger seat. The curtain airbag system * remains activated.

The control indicator  for seat occupancy recognition is located in the instrument panel. If the control indicator  illuminates for approx. 4 seconds when the ignition is switched on, the vehicle is equipped with seat occupancy recognition, see next page, Fig. 17117 T.

If a Vauxhall child restraint system with transponders * is fitted, the control indicator  lights permanently after the ignition is switched on as soon as the system has detected the child restraint system. Only then may the child restraint system with transponders * be used on the passenger seat.



17116 T

Vehicles with seat occupancy recognition are also identified by a sticker on the lower panel of the front passenger seats – see figure above.

Vauxhall child restraint systems with transponders * are automatically detected if correctly fitted to the front passenger seat. When this type of child restraint system is in use on the front passenger seat, the front and side airbag systems for the front passenger seat are deactivated. The curtain airbag system remains activated. Pay attention to control indicator  for seat occupancy recognition * see Fig. 17117 T.

Warning

Only Vauxhall child restraint systems with transponders * can be fitted on the front passenger seats. Use of systems without transponders poses a risk of fatal injury.

Vauxhall child restraint systems with transponders * can be identified by a sticker.

Note

On the Astra TwinTop, there may be interference in radio reception of certain frequencies in the medium waveband when the roof is open and the front passenger seat is unoccupied.

Control indicator for Vauxhall child restraint systems with transponders *

The presence of a Vauxhall child restraint system with transponders * is indicated after the ignition has been switched on by permanent illumination of the control indicator  in the instrument panel, as soon as the seat occupancy recognition system has detected the child restraint system.

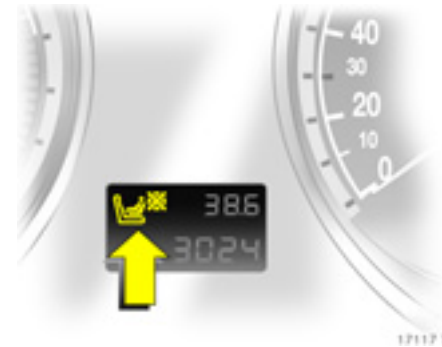

If the control indicator does not illuminate whilst driving, the front and side airbag * have not been deactivated on the passenger side. Risk of fatal injury to the child - fit child restraint system to rear seat. Have cause of fault remedied. We recommend that you consult your Vauxhall Authorised Repairer.

If the child restraint system is not correctly installed or the transponder is faulty, the control indicator flashes. Check for correct installation of child restraint system. To install the child restraint system with transponders *, see the instructions enclosed with the system.

If the control indicator flashes even though there is correctly installed child restraint system with transponders *, there is a fault - risk of fatal injury to the child. Fit child restraint system to rear seat. Have the cause of the fault remedied. We recommend that you consult your Vauxhall Authorised Repairer.

If no Vauxhall child restraint system with transponders * is installed, the control indicator must neither illuminate nor flash, since this indicates that the front passenger airbag systems would not be triggered. Have the cause of fault remedied. We recommend that you consult your Vauxhall Authorised Repairer.

Warning

If the Vauxhall child restraint system with transponders * has been fitted according to the instructions, the control indicator for Vauxhall restraint systems with transponders must illuminate in the instrument panel when the ignition is switched on.

If the control indicator does not illuminate whilst driving, the airbag systems have not been deactivated on the passenger side. Risk of fatal injury. In this case, fit child restraint system to rear seat. Have cause of fault remedied. We recommend that you consult your Vauxhall Authorised Repairer.

Important

- Do not affix or place accessories or other objects in the deployment area or the airbag systems or deployable anti-roll bars * as this could result in injuries if the components are triggered.
- Do not place any objects between the airbag systems/anti-roll bar covers * and the occupants. Risk of injury.

| |
|--|
|  Warning |
| Never carry child restraint systems or other objects on your lap - risk of fatal injury. |

- Use the hooks in the roof frame only to hang up light articles of clothing or coat hangers. Do not place any objects in the pockets of the hanging items – risk of injury.
- The control electronics of the airbag systems, belt tensioners and deployable anti-roll bars * are located in the centre console area. Do not store any magnetic objects in the area as they could cause malfunction.

- Do not bond or use other material to cover the steering wheel, dashboard, front seat backrests and roof frame in the area of the airbags and the seat cushion of the passenger seat or the covers of the deployable anti-roll bars *.
- Use only a dry cloth or interior cleaner to clean the steering wheel, instrument panel, front seat backrests, roof frame and seat cushion of the front passenger seat. Do not use any aggressive cleaning agents.
- Only protective covers which are approved for your vehicle with side airbag * may be fitted on the front seats. When fitting the protective covers, make sure that the airbag units on the outboard sides of the front seat backrests are not covered.
- The airbag systems are triggered independently of each other based on the severity of the accident and the type of impact. The side airbag system * and the curtain airbag system * are triggered together.
- Astra TwinTop: The deployable anti-roll bars * are deployed together with the front and side airbag systems * depending on the severity of the impact.

- Each airbag or deployable anti-roll bar * can only be deployed once. Have deployed components replaced immediately. We recommend that you consult your Vauxhall Authorised Repairer.
- The speeds, directions of movement and deformation properties of the vehicles, and the properties of the obstacle concerned, determine the severity of the accident and triggering of the airbags. The degree of damage to your vehicle and the resulting repair costs alone are not indicative that the criteria for triggering of the airbags were met.
- Do not make any modifications to components of the airbag systems or the anti-roll bars * as this would render the vehicle unroadworthy.

| |
|--|
|  Warning |
| The systems can be triggered abruptly and cause injury if they are handled improperly. |

- We recommend having the steering wheel, the instrument panel, all panelling parts, the door seals, the handles and the seats removed by your Vauxhall Authorised Repairer.

- Applicable safety directives must always be observed when disposing of the vehicle. For this reason, disposal should be performed by an authorised recycling company. We recommend that you consult your Vauxhall Authorised Repairer.
- Persons weighing less than 35 kg should only travel on the rear seats. This does not apply to children who are travelling in child restraint systems with transponders ✱.
- In vehicles with seat occupancy recognition ✱, do not place any heavy objects on the front passenger seat otherwise the airbag systems for the front passenger seat may be triggered in the event of an accident.
- In vehicles with seat occupancy recognition ✱, to prevent malfunctions do not use protective covers or seat cushions on the front passenger seat.

- In order to prevent malfunctions when using a Vauxhall child restraint system with transponders ✱ on the front passenger seat, no objects (e.g. plastic sheet, stickers or heated mats) may be placed under the child restraint system.

⚠ Warning

Child restraint systems as well as other objects must never be carried on the lap of passengers; risk of fatal injury. If carried in this way, child restraint systems with transponders ✱ in vehicles with seat occupancy recognition ✱ could lead to front passenger airbag systems not being triggered in the event of an accident.



17118 B

Use of child restraint systems ✱ on the front passenger seat in vehicles with airbag systems, but without seat occupancy recognition ✱

⚠ Warning

No child restraint system ✱ may be installed on front passenger seat. Danger to life.

Versions with front passenger airbag can be identified by the word **AIRBAG** over the glove compartment and the warning sticker on the side of the instrument panel, visible when the passenger door is open - see Fig. 17118 A.



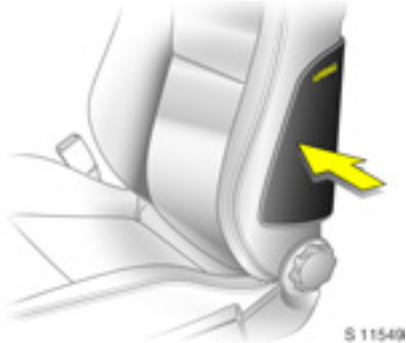

The side airbag system* is identified by the word **AIRBAG** on the outboard sides of the front seat backrests.

Seat occupancy recognition * – page 124.





Use of child restraint systems * on front passenger seat in vehicles with airbag systems and seat occupancy recognition *

⚠ Warning

Only Vauxhall child restraint systems with transponders * can be fitted on the front passenger seats. Use of systems without transponders poses a risk of fatal injury.

Vehicles with seat occupancy recognition are identified by a sticker on the lower panel of the front passenger seat – see Fig. 17116 T.



Vehicles with seat occupancy recognition can also be identified by control indicator  in the instrument panel. If control indicator  illuminates for approx. 4 seconds when the ignition is switched on, the vehicle is equipped with seat occupancy recognition – page 124.

The seat occupancy recognition system detects Vauxhall child restraint systems with transponders * and deactivates the front and side airbag systems * for the front passenger seat. The curtain airbag system * remains activated. For seat occupancy recognition see page 124.



Vauxhall child restraint systems with transponders * can be identified by a sticker on the child restraint system – see figure.

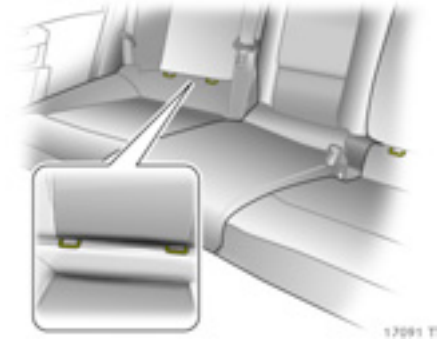

Mounting brackets * for ISOFIX child restraint systems

The brackets located between the backrest and seat cushion are used for mounting ISOFIX child restraint systems.

Please follow the instructions accompanying the ISOFIX child restraint system.

Only ISOFIX child restraint systems approved for the vehicle may be used. We recommend that you consult your Vauxhall Authorised Repairer.

Child restraint system *

The Vauxhall child restraint system is designed specifically for your Vauxhall and thus provides optimum safety for your child in the event of impact. If a different child safety seat is used, follow the manufacturers' instructions for fitting and use.

The country in which you are travelling may not permit the use of child restraint systems on certain seats. Always comply with the local or national regulations.

Selecting the right system

Your child should travel facing backwards in the car for as long as possible. A child has a very weak cervical spinal column and in the event of an accident is less likely to suffer injury in a rearward-facing, semi-lying position than if seated upright.

⚠ Warning

Never carry child restraint systems on your lap, risk of fatal injury.

Permissible options for fitting a child safety seat¹⁾

| Weight and age class ²⁾ | On front passenger seat | On outer rear seats | On centre rear seat ³⁾ |
|--|-------------------------|---------------------|-----------------------------------|
| Group 0: up to 10 kg or approx. 10 months | B ¹ , + | U, + | U |
| Group 0+: up to 13 kg or approx. 2 years | | | |
| Group I: 9 to 18 kg or approx. 8 months to 4 years | B ² , + | U, + | U |
| Group II: 15 to 25 kg or approx. 3 to 7 years | | | |
| Group III: 22 to 36 kg or approx. 6 to 12 years | X | U | U |

¹⁾ For reasons of safety, we recommend that the child safety seat be installed on one of the outer rear seats.

²⁾ We recommend the use of each system until the child reaches the upper weight limit.

³⁾ Not on Astra TwinTop.

B¹ = Limited, only with seat occupancy recognition and Vauxhall child restraint system with transponders.

If the child restraint system is being secured using a three-point seat belt, move seat height adjustment ✿ to uppermost position. Move front passenger seat as far back as possible and move front passenger seat belt anchorage point to lowest position.

B² = Limited, only with seat occupancy recognition and Vauxhall child restraint system with transponders.

If the child restraint system is being secured using a three-point seat belt, move seat height adjustment ✿ to uppermost position. Move front passenger seat as far back as possible so that vehicle safety belt runs from anchorage point towards the front.

U = Universal suitability in conjunction with three-point seat belt.

+ = Vehicle seat with ISOFIX mounting available. When mounting with ISOFIX, only ISOFIX child restraint systems that have been approved for the vehicle may be used. We recommend your Vauxhall Authorised Repairer.

X = No child restraint system permitted in this weight class.

Note

- Children under 12 years or under 150 cm tall should only travel in an appropriate child safety seat.
- When transporting children, use the child restraint systems suitable for the child's weight.
- Ensure correct installation of child restraint system, see the instructions enclosed with the system.
- The covers of the Vauxhall child restraint system can be wiped clean.
- Do not stick anything on the child restraint systems and do not cover them with any other materials.
- Only allow the child to enter and exit on the side of the vehicle facing away from the road.
- A child restraint system which has been subjected to stress in an accident must be replaced.
- Secure or remove child restraint systems carried in the vehicle when not in use.

Rollover protection system *

The Astra TwinTop is equipped with rollover protection with reinforced windscreen frame and anti-roll bars behind the rear seat head restraints. Depending on the variant, the anti-roll bars are either fixed or deploy automatically in the event of an impact of a certain severity. The subsequent description only regards the variant with automatically deployed anti-roll bars *.

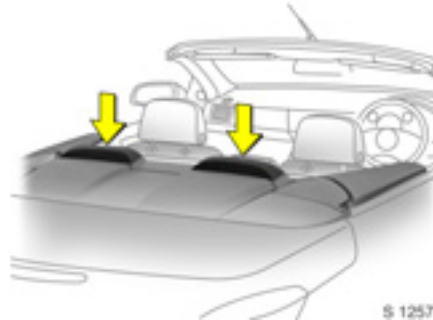

S 12574

In the event of a rollover, the anti-roll bars deploy upwards in a matter of milliseconds. They also deploy together with the front and side airbag systems *, helping to optimise occupant protection.

The system deploys whether the roof is open or closed. Roof operation is not possible if the anti-roll bars are extended.



17105 1

Control indicator * for anti-roll bars

The deployable anti-roll bars are monitored electronically together with the belt tensioners and the airbag systems. Their operational readiness is indicated by control indicator * in the instrument panel. When the ignition is switched on, the control indicator illuminates for approx. 4 seconds. If it does not illuminate, does not go out after 4 seconds or illuminates whilst driving, there is a fault in or deployment of the anti-roll bars, belt tensioners and airbag systems – page 113. The systems may fail to trigger in the event of an accident.

Deployment of the anti-roll bars is indicated by continuous illumination of *.

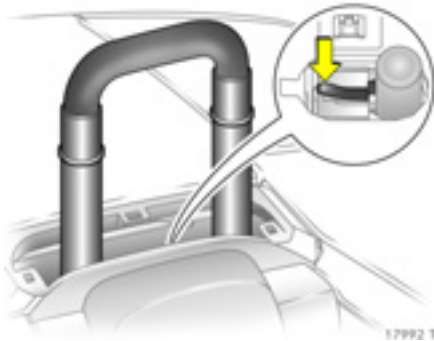

Extended anti-roll bars

can be retracted (e.g. in order to close the roof after a collision).

Press the lever between the rods of an anti-roll bar to unlock the system. Push the anti-roll bar all the way down until it engaged. Fit the cover.

Repeat the procedure on the other anti-roll bar.

Control indicator , however, will remain illuminated and the anti-roll bars will not deploy in the event of another collision.

Have the cause of the fault remedied. We recommend that you consult your Vauxhall Authorised Repairer.

Warning

The roof cannot be closed or opened if the anti-roll bars are extended. The anti-roll bars must first be retracted.

If an attempt is made to operate the roof while the anti-roll bars are extended, a continuous signal will sound as a warning.

Note

- Do not place any objects on the covers of the anti-roll bars behind the head restraints. They would be propelled through the vehicle in an uncontrolled fashion should the anti-roll bars deploy. Such objects could also prevent the anti-roll bars from extending.
- Do not operate the roof while the anti-roll bars are extended. Parts of the roof could be damaged during such operation.
- Deployment of the anti-roll bars is indicated by illumination of control indicator .
- Manually retracted anti-roll bars will not deploy in the event of a collision.
- After deployment, the anti-roll bar system must be serviced immediately. We recommend that you consult your Vauxhall Authorised Repairer.



Exterior mirrors

For the safety of pedestrians, the exterior mirrors will swing out of their normal mounting position if they are bumped with sufficient force. Reposition the mirror by applying slight pressure to the mirror housing.

Aspherical exterior mirror *

increases the field of view. Estimating the distance away of vehicles following you is only possible to a limited extent because of slight distortion.



Automatic anti-dazzle interior mirror *

Dazzle at night is automatically reduced.

With the ignition off, the mirror does not dim.

Setting – page 6.

Sun visors, glove compartment

The mirror covers in the sun visors and the glove compartment should be closed whilst driving.



Hazard warning flashers

The hazard warning lights switch on automatically when the airbags are triggered, and the central locking unlocks all doors. Switch off hazard warning lights with button .

Head restraints

Do not attach objects or components that are not approved for your vehicle to the head restraints, since they can reduce the protection provided by the head restraints and could be catapulted uncontrollably through the vehicle in the event of hard braking or an accident.

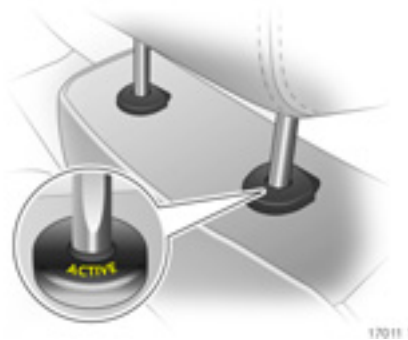

Active head restraints ✳

In the event of a rear-end impact, the active head restraints tilt forwards slightly. The head is more effectively supported by the head restraint and the danger of hyperextension in the area of the cervical vertebra is reduced.

Active head restraints are identified by the lettering **ACTIVE** on the head restraint guide sleeves.

Safety accessories ✳

The wide range of Vauxhall accessories allows you to equip your vehicle as you desire. In addition to safety accessories, items for improving comfort and a complete range of vehicle care products, there are many articles which will be of great value to you when needed.

"Genuine Vauxhall Parts and Accessories" guarantee high quality and accurate fit.

Your Vauxhall Authorised Repairer will be happy to advise you, for example with regard to:

- Vauxhall child restraint systems,
- Tow ropes,
- Tow rods,
- Jump leads,
- Spare bulb kit,
- Spare fuse kit
- Halogen fog lights
- Mud flaps
- Warning triangle
- First-aid kit (cushion)

Lighting

| | |
|--|-----|
| Automatic dipped beam activation * | 137 |
| Fog lights \mathcal{D} * | 137 |
| Fog tail light \mathcal{D} * | 137 |
| Turn signals, hazard warning flashers | 137 |
| Reversing lights | 137 |
| Headlight range adjustment \mathcal{D} | 138 |
| Adaptive Forward Lighting * (AFL) .. | 139 |
| Door-to-door light function | 140 |
| Parking lights * | 140 |
| Instrument illumination , Information display illumination | 140 |
| Courtesy light | 141 |
| Puddle light * | 142 |
| Battery discharge protection | 142 |
| Light covers | 142 |
| Headlights when driving abroad | 142 |



Exterior lights

Turn light switch:

- 0** = Off
- \mathcal{D} = Parking lights
- \mathcal{D} = Dipped beam, main beam

Dipped beam, main beam and headlight flash – see page 15.

In positions \mathcal{D} and \mathcal{D} , the tail lights and number plate lights are also on.

Control indicator \mathcal{D} – page 40.

If the ignition is switched off with the dipped beam or main beam on, the parking lights illuminate.

Versions with daytime running lights * :
Parking lights are on when the ignition is switched on and the light switch is set to **0** or **AUTO**. Dipped beam is on when the engine is running.

The daytime running lights switch off when the ignition is switched off.

Follow the regulations of the country in which you are driving when using daytime running lights and fog lights *.

Driving abroad – page 142.



17123 B

Automatic dipped beam activation *

Light switch to **AUTO** : Dipped beam comes on automatically when the engine is running if outside light conditions warrant such.

The exterior lights switch off when the ignition is switched off.

For reasons of safety, the light switch should always remain in the **AUTO** position.



17124 B

Fog lights #D *

On = Press #D #D illuminates in instrument panel

Off = Press #D again or switch ignition or light off

The fog lights can only be switched on when both the ignition and lights are on.

Fog tail light Q#

On = Press Q# Q# illuminates in instrument panel

Off = Press Q# again or switch ignition or light off

The fog tail light can only be switched on both the ignition and dipped beam/parking lights are on.

The vehicle fog tail light are deactivated when towing.

Turn signals, hazard warning flashers

– page 15.

Reversing lights

Come on when reverse gear is engaged and ignition is switched on.



17125 1

Headlight range adjustment

Manual headlight range adjustment

With dipped beam switched on, adjust headlight range in four steps to suit vehicle load. Turn wheel against resistance and click it to the required position.

Correct adjustment of the headlight range reduces dazzle for other road users.

Automatic level control system 

– page 220.

Vehicles without level control system

- Front seats occupied = 0
- All seats occupied = 1
- All seats occupied and luggage compartment load =2
- Driver's seat occupied and luggage compartment load =3

Vehicles with level control system

- Front seats occupied = 0
- All seats occupied = 1
- All seats occupied and luggage compartment load =1
- Driver's seat occupied and luggage compartment load =2

Automatic headlight range adjustment

On vehicles with Xenon headlights, the range of the headlights is adjusted automatically based on vehicle load.

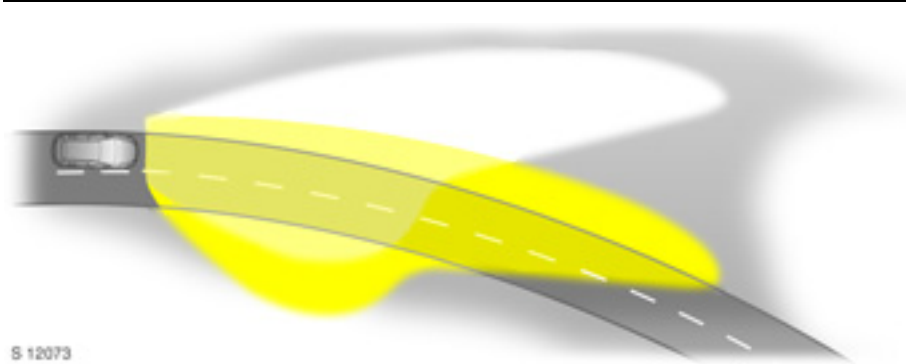

S 12073

Adaptive Forward Lighting * (AFL)

improves lighting in curves (curve lighting) on vehicles with Bi-Xenon headlight system.

Curve lighting

The Xenon light beam pivots based on steering wheel position and speed (from approx. 6 mph /10 km/h).

The headlights shine at an angle of up to 15 ° to the right or left of the direction of travel.

Motorway lighting

At higher speeds and continuous straight ahead travel, the dipped beam automatically raises slightly, thereby increasing headlight range.



17127 1

Control indicator for adaptive driving lights

Illuminated: Fault in system. The system is not ready for operation.

If the cornering light swivelling device fails, the relevant dipped beam is switched off. The corresponding fog light is automatically switched on for reasons of safety.

Consult a workshop. We recommend your Vauxhall Authorised Repairer.

If control indicator  flashes for approx. 4 seconds after the ignition is switched on, the headlights have been set to symmetrical dipped beam; see "Headlights when driving abroad" on page 142.

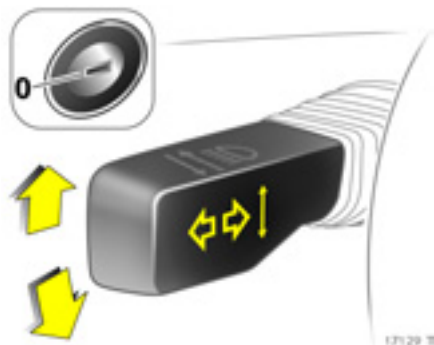
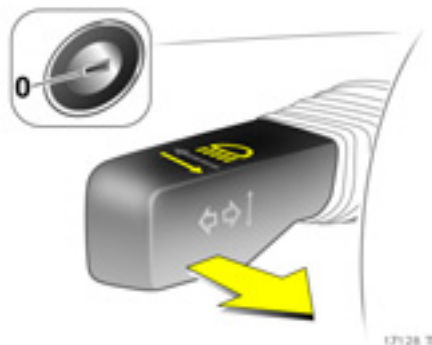

Door-to-door light function

Dipped beam and reversing lights * light for around 30 seconds after the driver exits the vehicle and closes his door.

To activate

1. Switch off ignition.
2. Remove ignition key. *
3. Open driver's door.
4. Pull turn signal stalk toward steering wheel.
5. Close driver's door.

If the driver's door is left open, the lights will go out after two minutes.

Door-to-door lighting can be deactivated by inserting the key in the starter switch or by pulling the turn signal stalk toward the steering wheel again while the driver's door is open.

Parking lights *

The front parking light and tail light of one side of the vehicle can be activated when parking:

1. Set light switch to **0** or **AUTO** *,
2. Ignition off
3. Move turn signal stalk all the way up (right parking light) or down (left parking light).

An acoustic signal sounds and control indicator  illuminates briefly in the instrument panel to indicate activation.

To switch it off, switch on the ignition or move the turn signal stalk in the opposite direction.

Instrument illumination , Information display illumination

Comes on when ignition is switched on.

Brightness can be adjusted when the exterior lights are on: Push to release knob  and then turn it clockwise or anticlockwise and hold until the desired brightness is obtained.

Display mode * – page 58.

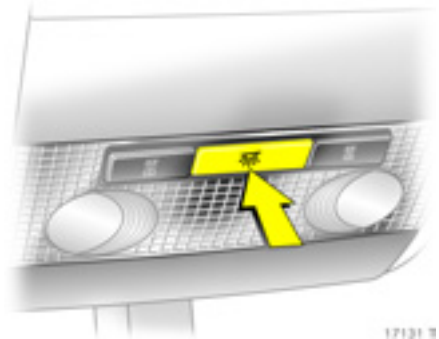

17131 1

Courtesy light

Automatic interior light

Comes on automatically when the vehicle is unlocked with the radio remote control, when a door is opened or when the key is removed from the starter switch after the ignition is switched off.

Goes off automatically after a delay when the doors are closed or immediately when the ignition is switched on or the doors are locked.

Front courtesy light

To operate manually from inside when the doors are closed:

- On = Press button ☀
- Off = Press button ☀ again

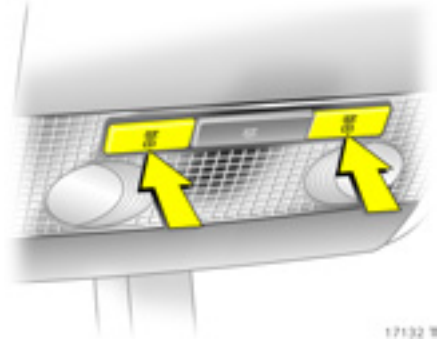

17132 1

Front reading lights ✳

Left and right reading lights are individually operable. With ignition on:

- on: press = button ☀
- off: press=button ☀ again

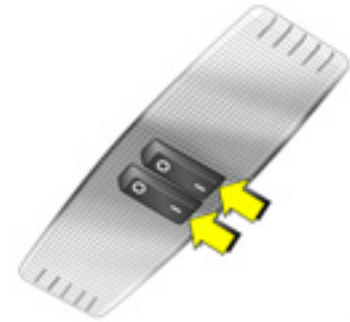

17133 1

Courtesy lights and rear reading lights ✳

Centre switch position: The rear courtesy light comes on together with the front one when a door is open.

The rear reading lights on the left and right can be switched on separately. With ignition on:

- On = Switch position I
- Off = Switch position 0

Entry lighting ✱

After unlocking the vehicle, the instrument and switch lighting come on for a few seconds.

Door handle lighting ✱

When the exterior lights are on, the interior front door handles are illuminated.

Illuminated mirror in the sun visors ✱

The lighting switches on when the cover is opened.

Glove compartment lighting

on when lid is open.

Cigarette lighter and ashtray illumination ✱

Comes on when ignition is switched on.

Luggage compartment lighting

Comes on when the boot lid/tailgate is opened.

Automatically regulated centre console lighting ✱

Spotlight in housing of interior mirror.

Daylight-dependent, automatically regulated centre console lighting with ignition switched on.

Puddle light ✱

After unlocking the vehicle, the number plate lights come on for a few seconds.

Battery discharge protection

To prevent the battery from becoming discharged, the courtesy light, reading lights, luggage compartment lighting and glove compartment lighting switch off automatically 10 minutes after the ignition is switched off.

Light covers

The inside of the light covers may mist up briefly in poor, wet and cold weather conditions, in heavy rain or after washing. The mist disappears quickly by itself; to help, switch on the lights.

Headlights when driving abroad

The asymmetrical dipped beam increases the field of vision on the passenger side of the lane.

This causes glare for oncoming traffic if the vehicle is driven in countries where traffic drives on the opposite side of the road.

Do as follows to prevent glare:

Vehicles with halogen headlight system or Xenon headlight system ✱

Have the headlights adjusted by a workshop. We recommend your Vauxhall Authorised Repairer.

Vehicles with adaptive forward lighting ✱ (AFL)

1. Pull and hold stalk for main beam on steering wheel (headlight flash)
2. Switch on ignition.
3. After approx. 3 seconds, an acoustic signal sounds and then AFL control indicator  flashes approx. 4 seconds.

After the switch, AFL control indicator  flashes for 4 seconds each time the ignition is switched on.

To return to asymmetrical dipped beam, pull and hold the main beam stalk again, switch on the ignition and wait for the acoustic signal. AFL control indicator  will then discontinue flashing.

Control indicator  – page 42.

Windows, Sun Roof

Electric windows *..... 143
 Panoramic windscreen *..... 146
 Sun roof * 146

⚠ Warning

Take care when operating the electric windows * and the sun roof *. Risk of injury, particularly to children. Vehicle passengers should be informed accordingly.

If there are children on the rear seat, switch on the child safety system * for the electric windows.

Keep a close watch on the windows and sun roof when closing them. Ensure that nothing becomes trapped in them as they move.

Electric windows *

The electric windows can be used

- with ignition on,
- within 5 minutes of switching ignition off *,
- within 5 minutes of switching ignition key to position 1.

Stand-by after switching on the ignition ends when the driver's door is opened.



Operated via two or four * switches in the driver's door handle. The front switches are for the driver and front passenger doors. The rear switches * are for the rear doors. Additional switches are located in the front passenger door and rear doors *.

For incremental operation, briefly pull or press the switch. For automatic opening or closing, pull or press the switch longer. Pull or press the switch again to stop the movement.



Safety function

If the window glass encounters resistance above the middle of the window during automatic closing, it is immediately stopped and the window opened again.

In the event of difficulty due to frost or the like, press the relevant window switch several times until the window is closed.





Child safety system for rear windows ✖

Switch ✖ between the rear switches in the driver's door handle

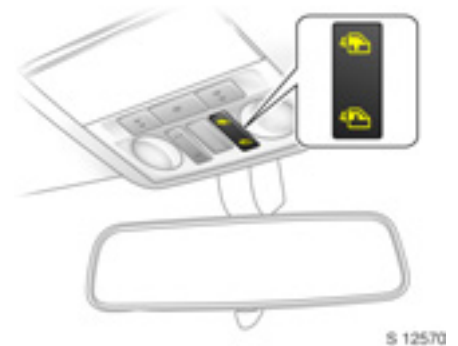
- Forward (red field visible): Rear door switches non-operational
- Rearward (green field visible): Rear door switches operational



Central switch for electric windows, Astra TwinTop

Button  or  in the roof console

Press button  : all windows are closed

Press button  : all windows are opened

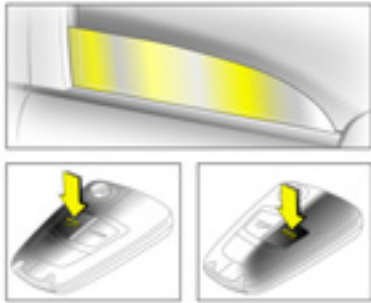



S 11531

Operating windows from outside *

Depending on the equipment level of the vehicle *, the windows of vehicles with electric windows in all doors * can be opened or closed from outside using the radio remote control.

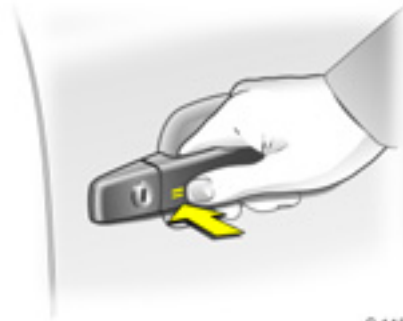

Radio remote control with mechanical key

Hold button  or  on the radio remote control depressed until all windows have opened or completely closed.



S 11527

Open&Start system with electronic key *

Hold down button  of radio remote control to open. To close, hold down button  or touch sensor in door handle for longer. The electronic key must be recognised within the external reception range. It is advisable for the driver to keep the electronic key on his person.

Stand-by after switching on the ignition ends when the driver's door is opened.

Overload

If the windows are repeatedly operated at short intervals, the power supply is briefly cut off.

The system is protected by fuses in the fuse box – page 266.

Fault

The windows cannot be automatically opened or closed.

Activate electronic windows as follows:

1. Close doors.
2. Switch on ignition.
3. Window completely open.
4. Close the window and hold the button depressed at least 5 seconds.
5. Repeat for each window.



Panoramic windscreen *

Open the roof lining

Turn the handle to the right and move the roof lining rearward to a suitable position.

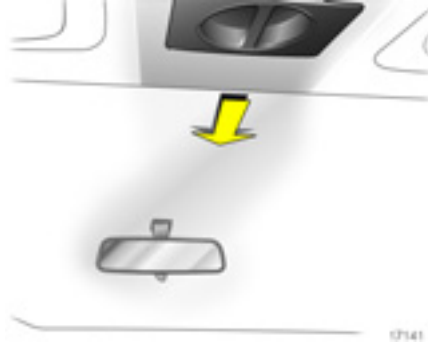

Close the roof lining

Move the roof lining forward to a suitable position. When moved all the way forward, the roof lining engages in position.

Note

Close the sun visors before sliding the roof lining.



Sun roof *

Operated via rocker switches in the roof console when the ignition is switched on.

For incremental operation, briefly press the button. For automatic opening or closing, press the button longer.

To raise:

When the roof is closed, press button . The roof is tilted in the rear.

To open:

Press button  again from the tilted position. The roof opens to its stop.

To close:

Press button .

For reasons of safety, the roof closes from its open position to approx. 20 cm. Hold button  depressed to close the roof completely.

**Sunblind**

Used to reduce sun penetration into the interior when the sun roof is closed.

The sunblind opens when the sun roof opens.

To open:

Press button . The sunblind opens to its stop.

To close:

Press button  .

For reasons of safety, the blind closes from its open position to approx. 20 cm. Hold button  depressed to close completely.

Note

- If the top of the roof is wet, raise roof, allow water to run off and then open roof.
- When using a roof rack, check the clearance of the sun roof to avoid damage.



Overload

If the system is overloaded, the power supply is automatically cut off for a short time.

The system is protected by fuses in the fuse box – page 266.

Fault

If the sun roof and sunblind do not operate properly, activate electronics as follows:

1. Switch on ignition.
2. Close the sun roof and hold button  depressed at least 10 seconds.
3. Close sunblind and hold button  depressed at least 10 seconds.

TwinTop

| | |
|----------------------------------|-----|
| TwinTop..... | 148 |
| Rollover protection system | 152 |
| Luggage compartment..... | 153 |
| Wind deflector *..... | 154 |

With TwinTop, a convertible hardtop, Astra unites the benefits of a coupe with those of a convertible.

Warning

Take care when operating the convertible hardtop. Risk of injury.

Monitor the action zone above, to the side and to the rear of the vehicle during roof operation. Make sure that nothing could become pinched.

Make sure no one is in the action zone of the roof or boot lid during roof operation. Risk of injury.

Check the amount height, length and width of available space before operating the roof, e. g. in a garage, parking garage or when a bicycle rack is fitted.

Vehicle passengers should be informed accordingly.

Before leaving the vehicle, remove the ignition key in order to prevent unauthorised operation of the windows and sun roof.

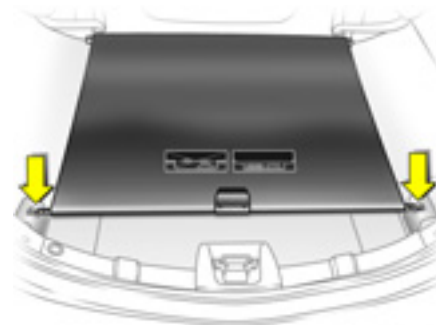

18024 1

TwinTop

Operating the convertible hardtop

Stand-by with ignition key in lock from position 1, or for Open&Start-System * switch on ignition.

Requirements:

- Vehicle is stationary or driving no more than 20 mph (30 km/h).
- Luggage compartment blind is closed and engaged - see above and page 104.
- Boot lid is closed.

If any of the requirements are not fulfilled, a warning buzzer sounds when the switch is actuated and the roof does not open or close.



S 12571

To open the roof

There must be no objects in front of the rear window or in the pivot area of the roof and boot lid.



Hold button  in the roof console depressed until the roof is completely open and the boot lid is closed.

An acoustic signal sounds at the end of the opening procedure.

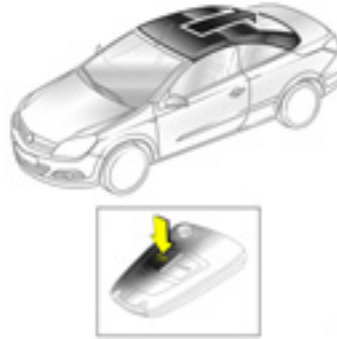
Open the door windows slightly before opening the roof. If button  is pressed again after the acoustic signal sounds, the door windows will close.



17970 1

With the vehicle stopped, the roof can be opened using the radio remote control . Unlock the vehicle. Press button  again and keep pressed until the roof has opened fully and the boot lid has closed.

During operation with the remote control, the door windows are opened completely.



S 12572

To close the roof

There must be no objects in the pivot area of the roof and boot lid.

Hold button  in the roof console depressed until the roof and boot lid are completely closed.



An acoustic signal sounds at the end of the closing procedure.

Open the door windows slightly before closing the roof. If button  is pressed again after the acoustic signal sounds, the door windows will close.





17971 1

With the vehicle stopped, the roof can be closed using the radio remote control . Lock the vehicle. Press button  again and keep pressed until the roof and boot lid have closed completely.

Indicator and warning buzzers

- Indicator buzzer upon completed opening or closing of the convertible hardtop.
- Indicator buzzer upon completed raising or lowering of the electric luggage compartment loading aid.
- Gong tone if the boot lid is not closed during roof operation.
- Gong tone if the boot lid is not fully opening during operation of the luggage compartment loading aid.
- Gong tone during roof operation if vehicle speed exceeds 20 mph (30 km/h).
- Gong tone when vehicle speed exceeds 20 mph (30 km/h) if the roof is not fully open or closed.
- Three gong tones during roof or loading aid operation if the luggage compartment blind is not attached.
- Three gong tones during roof operation if outside temperature is below -20°C , vehicle battery voltage is too low or the system is overloaded.
- Continuous warning buzzer during roof operation if the anti-roll bars  have been triggered.
- Continuous warning buzzer starting one minute before the end of the 9-minute standby time with the roof in an intermediate position.
- Continuous warning buzzer starting one minute before the end of the 9-minute standby time with the loading aid in a raised position.
- Continuous warning buzzer when closing the boot lid if the lowering process of the electric load aid is not complete or was interrupted.

Note

- Do not open the luggage compartment until the acoustic signal indicating the end of the roof opening or closing procedure has sounded.
- The luggage compartment blind must always be closed during roof operation.
- There must be no one at the covers behind the rear head restraints.
- There must be no objects in the pivot area or the roof or on the covers behind the rear head restraints.
- The roof can only be operated at temperatures above -20°C . If the temperature is below this limit, a gong will sound three times when roof operation is requested.

- The roof can be held in an intermediate position for 9 minutes to facilitate cleaning of roof spaces. This is done by disengaging the actuation switch. One minute before the end of this period, a continuous buzzer sounds as a warning that the hold period is almost over and the roof could start to move.
- Activating the roof on uneven ground can lead to malfunctions and damage.

Fault

The automatic drive of the roof is only operational if the roof is in the proper open or closed position.

Check if:

- The luggage compartment blind is engaged in the closed position
- The boot lid is completely closed
- Outside temperature is above -20°C
- There is sufficient battery voltage
- There is a system overload

If the automatic drive is not operational, two persons are required to manually close the roof. See the accompanying instructions for Astra TwinTop. We recommend that you seek professional assistance.

Rollover protection system

To optimise safety in the event of a rollover, the Astra TwinTop is equipped with reinforced windscreen frame and anti-roll bars behind the rear seat head restraints. The anti-roll bars are fixed or deployable depending on vehicle variant.

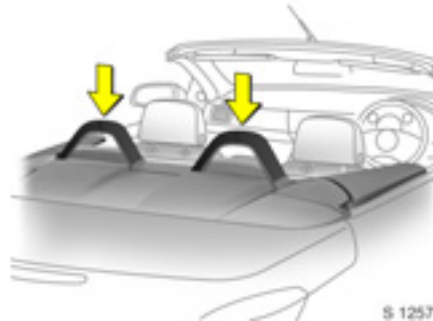

Fixed anti-roll bars
are secured to the vehicle bodywork.

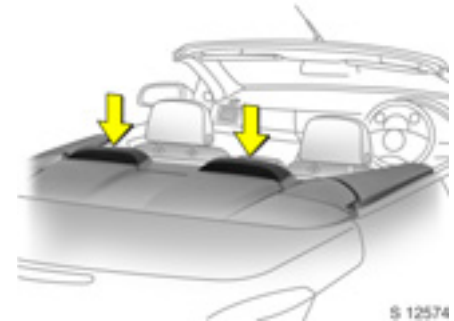

Deployable anti-roll bars *
are located between the rear head restraints and the boot lid in such a way that they are out of sight. In the event of a rollover, head-on collision or side impact, the anti-roll bars deploy upwards within milliseconds. The convertible roof must not be operated if the anti-roll bars have been deployed. A continuous warning will sound if the switch is actuated. The airbag control indicator  illuminates if the anti-roll bars have been deployed.

Manual retraction of the anti-roll bars
– page 132.

Further information, – page 133.

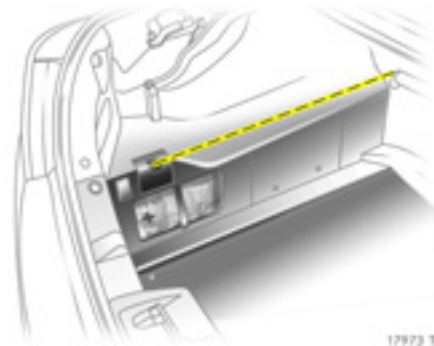

Luggage compartment

The roof can only be opened if the load in the luggage compartment does not exceed the height of the luggage compartment blind or protrude sideways. The load height marked in the figure must not be exceeded. The luggage compartment blind must be flat; objects below it must not press it upwards. Otherwise the roof and load may be damaged.

Electrically operated loading aid for the luggage compartment – page 104.

Luggage compartment blind – page 104.

Blockage of boot lid on closure *

To avoid damage to the open roof, boot lid or load, the boot lid can only be closed if the electric load aid is in the lower end position – page 104.

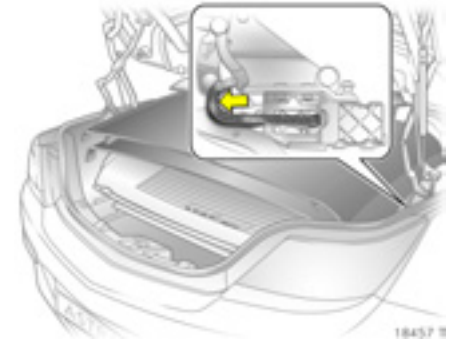

Unblocking on failure of electric drive

Push locking lever forward as shown in the figure.

Wind deflector ✱

With the wind deflector installed turbulence, draughts and noise in the passenger compartment are reduced when the roof is open.

The rear seats cannot be occupied when the wind deflector is in place.

Do not place any objects on the wind deflector.

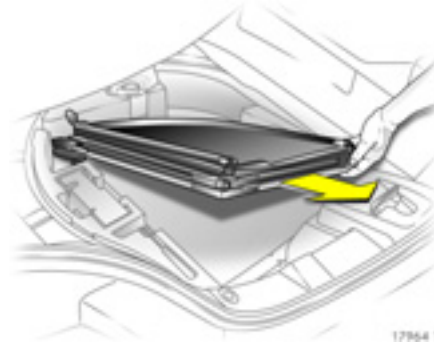

With tyre repair set ✱, the wind deflector is folded down into a storage compartment ✱ in the luggage compartment below the loading floor cover.

For the version with spare wheel ✱, the wind deflector is folded away in the luggage compartment.

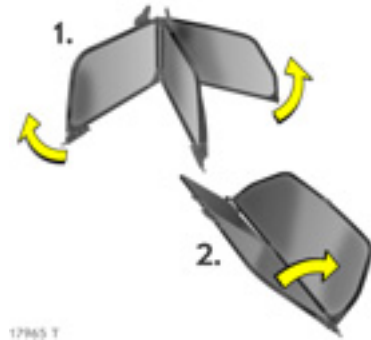

Fitting

Take the wind deflector from the luggage compartment.

Expand the collapsed wind deflector as illustrated.

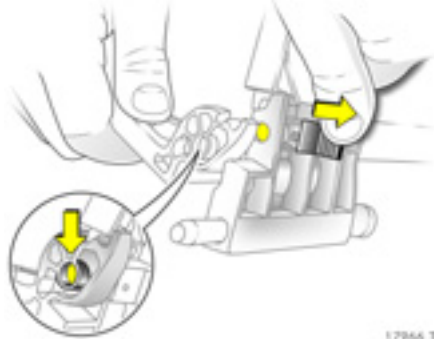

17966 I

Join together the unfolded ends of the wind deflector: press in the pin at the slider, guide the hinge over the pin and release the slider so that the pin engages in the hinge.

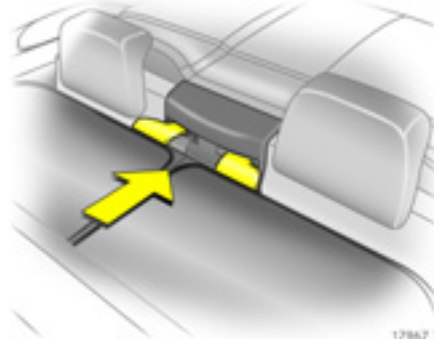

17967 II

Insert the guide clips of the wind deflector in the seat belt recesses between the rear head restraints.

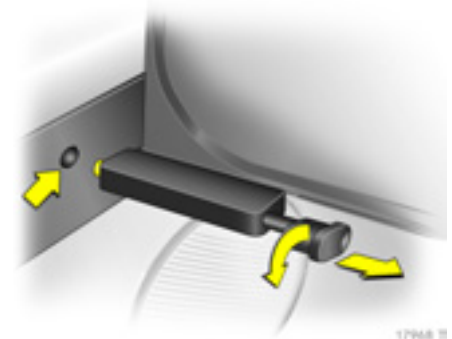

17968 III

Pull the toggle of the right and left locking pin and turn to lock. Straighten out the wind deflector, turn the toggle back and engage the locking pin in the recess in the side trim.

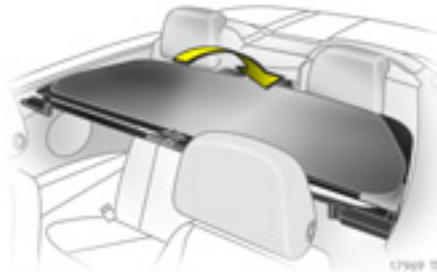

The wind deflector can be folded back when not in use.

If the wind deflector is folded and the rear seats are unoccupied, the wind deflector can remain mounted in the vehicle when the roof is closed.

Removing

Removal in reverse order, store wind deflector fully folded in the luggage compartment:
for tyre repair set ✱, in the compartment below the loading floor cover.

- for version with spare wheel ✱, place in the luggage compartment.

The wind deflector may never protrude upwards or sideways from the luggage compartment, see marked loading height, see page 153, Figure 17973 T.

Climate control

| | |
|---|-----|
| Air vents | 159 |
| Cooled glove compartment * | 159 |
| Heated rear window, heated exterior mirrors * | 160 |
| Heated seats * | 160 |
| Heating and ventilation system | 161 |
| Air conditioning system * | 164 |
| Automatic air conditioning system * | 166 |
| Electronic climate control system * | 171 |
| Air intake | 177 |
| Pollen filter | 177 |
| Note | 177 |
| Maintenance | 177 |

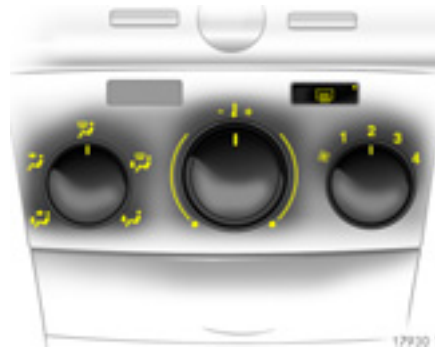

Heating and ventilation system, air conditioning system *

Ventilation, heating and cooling * are combined into one unit that is designed to provide comfort regardless of the season, weather or outside temperature.

When cooling * is activated, the air is cooled and dried.

The heating unit heats the air as required in all operating modes depending on the position of the temperature switch. The air supply can be adjusted to suit requirements by means of the fan.

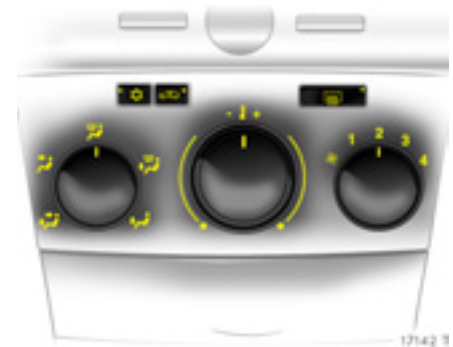

The buttons for cooling ☀❄ and air recirculation ↻ are only found on versions with optional air conditioning system *.

Air conditioning system *
– pages 164, 166.



Automatic air conditioning system *

Provides a comfortable interior regardless of the weather, outside temperature or season.

When an interior temperature is set with the temperature control, the temperature and amount of inflowing air are automatically regulated. A uniform, comfortable climate in the vehicle is thereby automatically obtained based on outside climate conditions.

Automatic air conditioning system
– page 166.



Electronic climate control system *

Offers the greatest comfort in the vehicle interior regardless of the conditions outside.

To ensure a uniform and comfortable climate in the vehicle, the temperature of inflowing air, air-flow rate and air distribution are automatically adapted based on the climate conditions outside the vehicle and the current temperature of the vehicle interior.

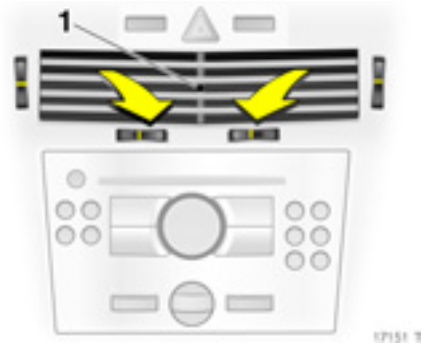

The set values appear on the information display.

Electronic climate control system
– page 171.



Air vents

Pleasant ventilation to the interior controlled by the position of the temperature switch.

To increase the air supply, turn the fan all the way up and set the air distribution switch to  or .

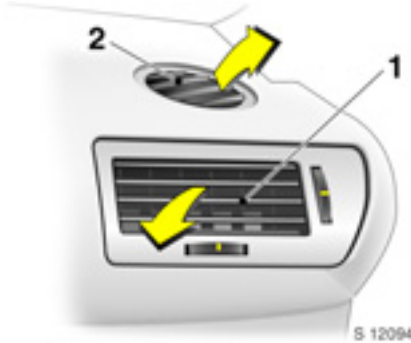

Centre and side air vents (1)

Vents open: Vertical knurled wheel down. Adjust the flow of air by turning the horizontal knurled wheel.



To close the vent, turn the vertical adjuster wheel fully up. The symbol **0** appears. The slats of the vent remain open although the air supply is closed.

Windscreen defroster nozzles (2)

Air distribution switch to  or  :
Air flows onto windscreen and side windows.

Additional vents

below the windscreen and door windows and in the front footwell.

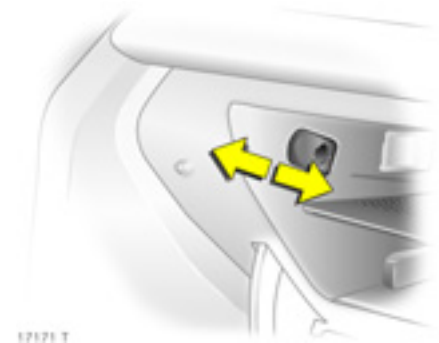

Cooled glove compartment *

Cooled air is fed into the glove compartment through a nozzle.

If glove compartment cooling is not required, slide the slider forward.



Heated rear window, heated exterior mirrors *

With the ignition on, the rear screen and exterior mirror heating is switched on by pressing button :

LED  lights: rear screen and exterior mirror heating.

LED  does not light: rear screen and exterior mirror heating is switched off.

Heating works with the engine running and is switched off automatically after around 15 minutes.

Astra TwinTop: The heated rear window and heated exterior mirrors * are deactivated when the roof is open.

Vehicles with diesel particle filter * : the heated rear window is automatically switched on during particle filter cleaning.



Heated seats *

Operation with ignition switched on:

Press button  one or more times to set the desired heat output. The control indicator in the button indicates which of the three heating levels is active.

We do not recommend prolonged use of the highest level for people with sensitive skin.

Deactivation: Press button  repeatedly until the control indicator goes out.

Seat heating is operational when the engine is running.

**General information,
as well as information on air
intake, air outlet, pollen filter and
maintenance,**

– page 177.

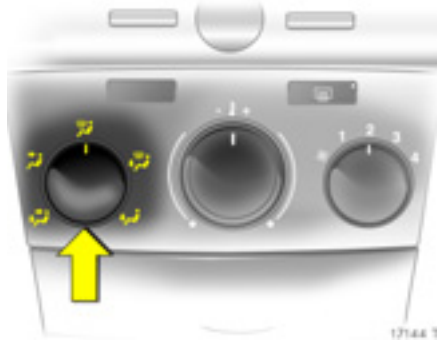

Heating and ventilation system

Left-hand rotary switch: Air distribution

- ☞ to head area via adjustable air vents and to foot well
- ☞ to headroom via adjustable air vents
- ☞ To the windscreen and front door windows
- ☞ to the windscreen, front door windows, to foot well
- ☞ to foot well

Intermediate settings are possible.

Open the air vents when the switch is set to ☞ or ☞.



Centre rotary switch: Temperature

- Turn right = warm
- Turn left = cold



Right-hand rotary switch: air flow



Four fan speeds:

- ☞ = Off
- 4 = Maximum air flow

The rate of air flow is determined by the fan. The fan should therefore also be switched on during a journey.



Ventilation

- For maximum ventilation in head area: set air distribution switch to  and open all vents
- Set the temperature to the desired setting.
- Set the fan to the desired setting.
- For ventilation to foot well: Set air distribution switch to ,
- For simultaneous ventilation to the head area and the foot well: Set air distribution switch to .

Heating

The amount of heat is dependent on the coolant temperature and is thus not fully attained until the engine is warm.



For rapid warming of the passenger compartment:

- Set air distribution switch to desired position, preferably position  – page 161.
- Turn the temperature switch clockwise as far as it will go.
- Set the fan to speed 3.
- Open air vents

Vehicles with Quickheat *: depending on the outside temperature and the engine temperature the passenger compartment is heated up more quickly using an auxiliary electric heater.

The auxiliary electric heater switches itself on automatically.

The comfort and general well-being of the vehicle occupants are to a large extent dependent on a suitable ventilation and heating setting.

To achieve a stratification of temperature with the pleasant effect of "cool head and warm feet", turn the rotary switch for air distribution to  or , set temperature rotary switch to any position (in the mid-range with stratification of temperature).



Heating the foot well

- Set air distribution switch to ,
- Set the temperature switch in the right-hand zone.
- Switch on fan.





Demisting and defrosting windows

Warning

Failure to follow the instructions could lead to misted or icy windows and accidents stemming from impaired visibility.

Misted or icy windows, e. g. due to damp weather, damp clothing or low outside temperatures:

- Move air distribution switch to ALIM UCH. .
- Turn the temperature switch clockwise as far as it will go (warm).

- Set fan to **3** or **4**,
- Activate heated rear window ,
- Open side air vents as required and direct them towards door windows.
- For simultaneous footwell heating, set air distribution switch to .

Air conditioning system *

As a supplement to the heating and ventilation system, the air conditioning system cools and dehumidifies (dries) inflowing air.

If cooling or dehumidification is not desired, switch off cooling in order to save fuel.

Cooling switches off automatically at low outside temperatures.



Cooling ☀❄

Operate only with the engine on and the fan running:

Press On= ☀❄

Press off= ☀❄ again

Control indicator in button.



Air recirculation system 🔄

The recirculation switch 🔄 is used to set the ventilation system to recirculation mode (control indicator in switch).

If fumes or unpleasant odours penetrate from outside: temporarily switch on air recirculation system 🔄.





To increase the cooling power at high outside temperatures, temporarily switch on the air recirculation system.

The air recirculation system minimises the entry of outside air. The humidity increases, and the windows can mist up. The quality of the passenger compartment air deteriorates which may cause the vehicle occupants to feel drowsy.

Air distribution to : the air recirculation system is automatically switched off to speed up window demisting and prevent fogging.



Comfort setting



- Set cooling  as desired.
- Air recirculation system  off.
- Set air distribution switch to  or .
- Set temperature switch as desired.
- Switch on fan at desired speed
- Open or adjust vents as required.

Temperature switch in centre of adjustment range: warmer air will flow into the foot well and cooler air into the upper zone, with warmer air coming from the side air vents and cooler air from the centre vents.



Maximum cooling

Open windows and sun roof  briefly so that warm air can escape rapidly.

- Cooling  on.
- Activate recirculation system .
- Set air distribution switch to .
- Turn the temperature switch anticlockwise as far as it will go (cold)
- Set fan to 4,
- Open all vents.





Window demisting and de-icing

Warning

Failure to follow the instructions could lead to misted or icy windows and accidents stemming from impaired visibility.

Misted or icy windows, e. g. due to damp weather, damp clothing or low outside temperatures:

- Cooling  on.
- Move air distribution switch to ALIM UCH.
- Turn the temperature switch clockwise.
- Set fan to 4,
- Open side air vents as required and direct them towards door windows.
- Activate heated rear window ,
- Open side air vents as required and direct them towards the side windows.

Automatic air conditioning system

Provides a uniformly comfortable interior regardless of the weather, outside temperature or season.

To ensure a constant and comfortable climate in the vehicle, the temperature of the inflowing air and the air-flow rate are changed automatically based on climate conditions outside the vehicle.

Temperature changes due to external influences, such as direct sunlight, are automatically compensated.



Automatic mode





Basic setting for maximum comfort:

- Set fan switch to **A**
- Set air distribution switch to desired position - see next column
- Use rotary switch to set temperature to 22 °C (a higher or lower temperature can be set as desired)
- Air conditioning compressor activation – page 168,
- All front air vents open. If desired, the rear vents also .



Deactivation of the air conditioning compressor can reduce the level of comfort and safety – page 168.



Air distribution setting

-  to head area via adjustable air vents and to foot well
-  to headroom via adjustable air vents
-  To the windscreen and front door windows
-  to the windscreen, front door windows, to foot well
-  to foot well

Intermediate settings are possible.

Open the air vents when the switch is set to  or .



Temperature preset

Set the rotary switch to a value between 17 °C and 27 °C. Intermediate settings are possible.

The selected temperature is maintained.

For reasons of comfort, temperature can only be changed in small increments.

There is no temperature control for settings below 17 °C (all the way left) or above 27 °C (all the way right). The air conditioning system works at maximum cooling or heating.



Air flow setting

1 - 4 Manual fan speed setting. Intermediate settings are possible.

A Automatic control of fan speed

❌ Fan off

Fan speed is regulated to provide the rate of air flow necessary to maintain the pre-selected temperature.

Select automatic mode for the highest level of comfort.

When the fan is off, the air conditioning compressor is also off.



To activate/deactivate air conditioning compressor (cooling) ☼

Operate only with the engine on and the fan running:

Press On= ☼

Press off= ☼ again

Control indicator in the button.

When cooling (AC compressor) is active, air is cooled and dehumidified. If cooling or dehumidification is not desired, switch off cooling in order to save fuel.

Cooling switches off automatically at low outside temperatures.



Manual air recirculation mode

The air recirculation system prevents the entry of outside air and the air in the passenger compartment is circulated.

Press button , control indicator in button.

The exchange of fresh air is reduced in air recirculation mode. The quality of the passenger compartment air deteriorates which may cause the vehicle occupants to feel drowsy. In operation without cooling the air humidity increases, so the windows may mist up. Consequently, manual air recirculation should only be run for short periods of time.

To deactivate manual air recirculation:

Press button  again. The control indicator in the button will go out.



Ventilation

- For maximum ventilation in head area: set air distribution switch to and open all vents.
- For ventilation to foot well: Set air distribution switch to ,
- For simultaneous ventilation to the head area and the foot well: set air distribution switch to .
- Set desired temperature
- Set fan switch to **A**. The fan can also be manually set: Set the rotary switch to position **1 - 4**. Intermediate settings are also possible.

Heating

The amount of heat is dependent on the coolant temperature and is thus not fully attained until the engine is warm.

For rapid warming of the passenger compartment:

- Set the air distribution switch to the desired position – page 161.
- Set the centre rotary switch to the desired temperature. We recommend a value of about 22 °C.
- Set fan switch to **A**. The fan can also be manually set: Set the rotary switch to position **1 - 4**. Intermediate settings are also possible.

Vehicles with Quickheat : depending on the outside temperature and the engine temperature the passenger compartment is heated up more quickly using an auxiliary electric heater.

The auxiliary electric heater switches itself on automatically.

The comfort and general well-being of the vehicle occupants are to a large extent dependent on a suitable ventilation and heating setting.

To obtain a stratification of temperature in the vehicle with the pleasant effect "cool head and warm feet", set the air distribution switch to or , set the temperature switch to about 22 °C and open the centre air vents.



Maximum cooling for very hot interior

Open windows and sun roof briefly so that warm air can escape rapidly.

- Cooling on.
- Set air distribution switch to **2**.
- Set the temperature switch to the desired temperature.
- Set fan switch to **A**.
- Open all vents.

The automatic climate control system provides maximum cooling down to the set value.

At settings below 17 °C (rotary switch all the way to the left), the system continually runs with maximum cooling. When the air conditioning compressor is running, air recirculation is switched on automatically.



Window demisting and de-icing

Warning

Failure to follow the instructions could lead to misted or icy windows and accidents stemming from impaired visibility.

Misted or icy windows, e. g. due to damp weather, damp clothing or low outside temperatures:

- Cooling on.
- Press button : In switch position **A** , the fan automatically switches to the highest speed and air is directed to the windscreen.

- Set temperature to maximum heating, i.e. turn the centre rotary switch all the way to the right (28 °C).

- Switch on heated rear window **N**.

Operation with cooling (air conditioning compressor) is not possible when outside temperatures are low.

To switch off, press button again; the automatic air conditioning system will operate at the settings selected previously.

Electronic climate control system *

Provides a the greatest amount of comfort in the interior regardless of the weather, outside temperature or season.

To ensure a constant and comfortable climate in the vehicle, the temperature of the inflowing air, the air-flow rate and the air distribution are changed automatically according to climatic conditions outside the vehicle.

Temperature changes due to external influences, such as direct sunlight, are automatically compensated.

Data is shown on the information display. Setting modifications are briefly shown in the information display, superimposing over the currently displayed menu.

The display can vary according to the type of presentation – page 46.

The settings in the climate control system are stored in the vehicle key when the vehicle is locked, see " Store personal settings in vehicle key " – page 68.



Different settings are stored for each remote control. Use of a remote control will activate the settings associated with it.

Manual settings e.g. operating without cooling and air distribution can be selected using the menu – page 173.

When cooling (air conditioning compressor) is active, air is cooled and dehumidified.

The pollen filter removes dust, soot, pollen and spores from the inflowing outside air.



The automatic air recirculation system * has an air quality sensor to detect harmful ambient gases, in which case it will switch automatically to recirculation.

When set to automatic mode, the climate control system provides the optimal settings for almost all conditions. If necessary, climate control system settings can be modified manually.

The climate control system is only operational when the engine is running.

Cooling (air conditioning compressor) switches off automatically at low outside temperatures.



Automatic mode

Basic setting for maximum comfort:

- Press **AUTO** button.
- Open all air vents.
- Air conditioning compressor activation – page 174,
- Set pre-selected temperature to 22 °C using left rotary knob.

The temperature can be set higher or lower as desired.

Switching off the AC compressor (**Eco** appears in display) can reduce comfort and affect safety – page 174.

All air vents are actuated automatically in automatic mode. The air vents should therefore always be open – page 159.

Automatic air recirculation mode *

The ventilation system is set to recirculation mode and interior air is recirculated.

The automatic air recirculation system has an air quality sensor to detect harmful gases in the outside air, in which case it will switch automatically to recirculation.

If outside temperatures are low and cooling (air conditioning compressor) is switched off, automatic air recirculation is only available in a limited capacity so as to prevent the windows from misting. Activate recirculation manually if so desired.

Switching automatic recirculation on or off – page 176.

Manual recirculation mode – page 176.

Temperature preset

The left rotary knob can be used to set temperatures between 16 °C and 28 °C.

For reasons of comfort, temperature can only be changed in small increments.

Vehicles with Quickheat *: depending on the outside temperature and the engine temperature the passenger compartment is heated up more quickly using an auxiliary electric heater.

The auxiliary electric heater switches itself on automatically.

If a temperature below 16 °C is set, **Lo** appears in the display: the climate control system runs constantly at maximum cooling power. The temperature is not regulated.

If a temperature above 28 °C is set, **Hi** appears in the display: the climate control system runs constantly at maximum heating power. The temperature is not regulated.

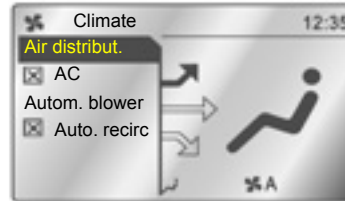

17162 P

Manual settings

Under certain circumstances (e.g. iced or misted windows), the functions of the climate control system can be modified manually.

Climate control system settings can be changed via the centre knob, the buttons and the menu depicted on the display.

Press the centre knob to call up the menu. The menu for manual climate control system settings appears in the display.

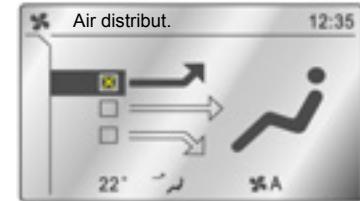

17162 P

Individual menu items are marked by turning the centre knob and selected by pressing it. Selecting certain menus by pressing the knob will open a submenu *.

To exit a menu, turn the centre knob left or right to **Return** or **Main** and select.



Window demisting and de-icing

Warning

Failure to follow the instructions could lead to misted or icy windows and accidents stemming from impaired visibility.

Misted or icy windows, e. g. due to damp weather, damp clothing or low outside temperatures:

Press  button.  appears in display: control indicator in button illuminates.

The temperature and the air distribution are adjusted automatically, the fan runs at a faster speed and the windows are rapidly cleared of ice and moisture.

The air flow can be increased or decreased by turning the right knob.

To return to automatic mode: press button  or **AUTO**.

Heated rear window – page 160.

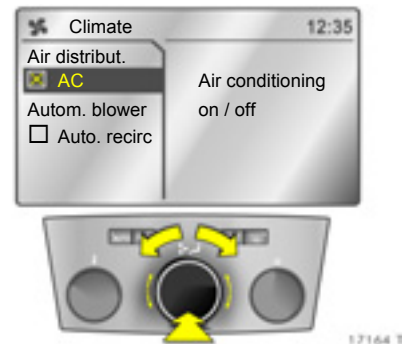

Activating and deactivating air conditioning compressor

If no cooling or dehumidification is required, switch the air conditioning compressor off (maximum energy savings): Mark menu item **AC** from the manual settings menu and select by pressing. **Eco** appears on the display.

Inflowing air is neither cooled nor dehumidified. This restricts the level of comfort provided by the electronic climate control system. This may cause the windows to mist up, for example.

To activate cooling: Select menu item **AC** from the manual settings menu and press to activate cooling.



Air distribution

Press the centre knob. The possible air distribution settings appear one after another in the display.

Air distribution can also be set in the **Air distribut.** menu:

- Up Air distribution to windscreen and front door windows
- Centre Air to vehicle occupants via front adjustable air vents
- Down Air distribution to foot well

Return to automatic air distribution:

Deactivate corresponding setting or press button **AUTO**.



Air flow

Turn right knob right or left. The selected fan speed is indicated with **3** and the number in the display.

At speed **0** both the fan and cooling (air conditioning compressor) are switched off.

To return to automatic mode: Press **AUTO** button.



Fan control in automatic mode*

Fan regulation in automatic mode can be modified.

Select menu item **Automatic blower** from the manual settings menu and select the desired fan control.

Depending on the setting, the maximum air flow, and thereby the noise level, will increase.

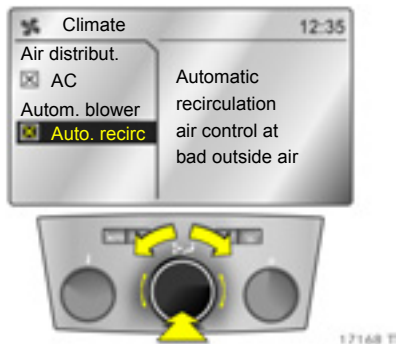

Switching automatic recirculation on or off

The automatic air recirculation system has an air quality sensor to detect harmful gases in the outside air, in which case it will switch automatically to recirculation.

Select menu item **Auto. recirc** from the manual settings menu and switch it on or off by pressing.

Switch to manual air recirculation as necessary.



Manual air recirculation mode

The air recirculation system prevents the entry of outside air and the air in the passenger compartment is circulated.

Press button , the control indicator in the button will illuminate.

The exchange of fresh air is reduced in air recirculation mode. The quality of the passenger compartment air deteriorates which may cause the vehicle occupants to feel drowsy. In operation without cooling the air humidity increases, so the windows may mist up. Consequently, manual air recirculation should only be run for short periods of time.

To deactivate manual air recirculation: Press button  again. The control indicator in the button will go out.



Air conditioning with the engine not running

When the vehicle is stopped and the ignition off, the heat or cooling power still in the system can be used to condition the passenger compartment, for example when stopped at a level crossing.

Press button **AUTO** with the ignition off. **Residual air conditioning on** will appear briefly in the display.

The air conditioning will operate for a limited period of time.

To cancel air conditioning, press the **AUTO** button.

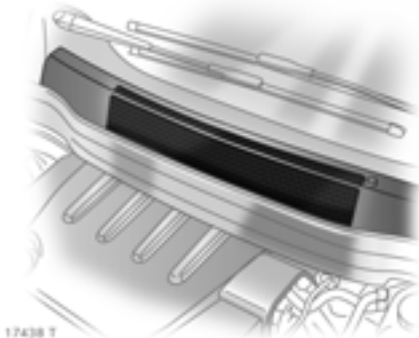

Air intake

The air intakes in front of the windscreen in the engine compartment must be kept clear to allow air intake. Remove any leaves, dirt or snow.

Pollen filter

The pollen filter cleans dust, soot, pollen and spores from the air entering from outside. The active carbon layer ✱ eliminates most odours and harmful ambient gases from the air.

Replace the pollen filter at the intervals given in the Service Booklet.

Note

If the windscreen mists up during damp weather, temporarily set the system as described under "Demisting and defrosting the windows" – pages 163, 166 or 174.

Cooling ✱ is most efficient when the windows are closed. If the interior is extremely hot due to a long period in strong sunlight, briefly open the windows and sun roof ✱ to allow the hot air to escape quickly.

When cooling ✱ (air conditioning compressor) is switched on condensation forms, which is expelled from the underside of the vehicle.

At least one air vent must be open while cooling ✱ (air conditioning compressor) is on in order to prevent the evaporator from icing up due to lack of air movement.

Cooling switches off automatically at low outside temperatures.

Do not cover the sensor on the instrument panel as this could cause the climate control ✱ system to malfunction.

Maintenance

In order to ensure continuously efficient performance, the air conditioning compressor ✱ must be operated for a few minutes once a month, irrespective of the weather and time of year. The climate control system, if present, handles this automatically while driving. Air conditioning compressor operation is not possible when outside temperatures are low.

If a fault occurs, consult a workshop. We recommend your Vauxhall Authorised Repairer.

Easytronic

| | |
|---|-----|
| Transmission display | 178 |
| Starting the engine | 179 |
| Easytronic operation via the selector lever..... | 179 |
| Move selector lever toward N..... | 179 |
| Starting off | 180 |
| Electronically controlled driving programmes..... | 181 |
| Winter programme ❄️ | 182 |
| Kickdown..... | 182 |
| Braking assistance from engine | 183 |
| "Rocking the car"..... | 183 |
| Manoeuvring the vehicle..... | 183 |
| Stopping the vehicle..... | 184 |
| Vehicle storage | 184 |
| Fault..... | 184 |
| Interruption of power supply | 185 |

Easytronic ❄️

The semi-automatic Easytronic transmission permits manual (manual mode) or automatic gear shifting (automatic mode), both with automatic clutch control.

⚠️ Warning

Disregard of these instructions may lead to injuries or endanger life.

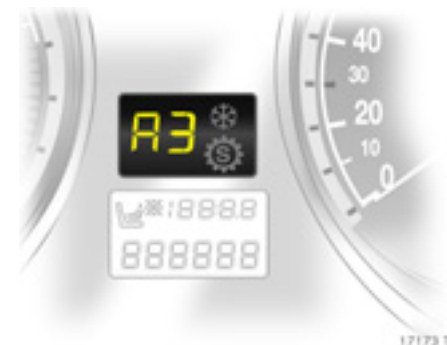

Transmission display

Shows the mode and current gear.

The display flashes for a few seconds when **A**, **M** or **R** is selected with the engine running and the foot brake not activated.



18442 T

Starting the engine

When starting the engine, press the foot brake at the same time. The engine can only be started with the foot brake pressed. The gear display shows "N". If the foot brake is not operated, the control indicator  lights and "N" flashes in the gear display, and the engine cannot be started.

Also the vehicle cannot be started if all brake lights have failed.

There is no need to select neutral before starting the engine. If a gear is engaged, the transmission automatically switches to neutral (N) before the engine starts when the foot brake is operated. This can lead to a slight delay in the starting process.



S 12064

Easytronic operation via the selector lever

Always move the selector lever in the appropriate direction as far as it will go. Upon release, it automatically returns to the centre position. Pay heed to the gear/mode indicator in the transmission display.

Move selector lever toward N
Neutral.



S 12096

Starting off

Depress the foot brake, release the hand brake and move the selector lever to **A**, **+** or **-**. Easytronic is in automatic mode and first gear is engaged (second gear if the Winter programme is active). "A1" appears in the transmission display ("A2" if the Winter programme is active).

The vehicle begins to "creep" when the foot brake is released.

It is also possible to start off without depressing the foot brake if the accelerator pedal is operated directly after movement of the selector lever. If there is no immediate acceleration or the foot brake is not depressed, no gear is engaged and "A" flashes. After a few seconds, the display resumes showing "N". Start off by repeating the previously described procedure.

In Automatic mode, selection of other gears is automatic irrespective of driving conditions.

Move selector lever toward A

Switch between Automatic and Manual mode.

Manual gear shifting is possible in manual mode. "M" and the currently engaged gear appear in the transmission display.

If the engine speed is too low the Easytronic will automatically shift to a lower gear even in Manual mode. This prevents the engine from stalling.



S 12064

Move selector lever toward + or -

+ Shift to a higher gear.

- Shift to a lower gear.

If a higher gear is selected when the running speed is too low, or a lower gear when the speed is too high, no shift is effected. This prevents the engine from running at too low or too high revs.

Gears can be skipped by moving the selector lever repeatedly at short intervals.

If the vehicle is in automatic mode, on movement of the selector lever to + or - Easytronic shifts to manual mode and changes up or down. "M" and the currently engaged gear appear in the transmission display.

Move selector lever toward R

Reverse gear. Engage only when vehicle is stationary.

Depress the foot brake, release the hand brake and move the selector lever to R. Reverse gear is engaged. "R" appears in the transmission display.

The vehicle begins to "creep" when the foot brake is released.

It is also possible to start off in reverse without depressing the foot brake if the accelerator pedal is operated directly after movement of the selector lever. If there is no immediate acceleration or the foot brake is not depressed, no gear is engaged and "R" flashes. After a few seconds, the display resumes showing "N". Start off by repeating the previously described procedure.

Electronically controlled driving programmes

- By means of delayed gear changing (higher engine speeds) following a cold start, the operating temperature programme in automatic mode quickly and automatically brings the catalytic converter to the temperature required for optimum pollutant reduction.
- Adaptive programmes automatically adapt gear shifting in automatic mode to suit the driving conditions, such as if the vehicle is towing a caravan/trailer, has a high payload, or is being driven on inclines.



- When SPORT mode is engaged, shift times are reduced and the transmission shifts at higher engine speeds (unless cruise control is on). SPORT mode – page 214.
- Winter programme: Press button ❄ – see next page.



S 12097

Winter programme ❄️

In the event of difficulties starting off on slippery roads, press button ❄️ ("A", currently engaged gear and ❄️ appear in the transmission display). Easytronic switches to automatic mode and the vehicle sets off in second gear.

The winter program is switched off by:

- pressing button ❄️ again,
- turning off the ignition.

In order to protect the Easytronic the winter programme automatically switches itself off at extremely high clutch temperatures.

If the Winter programme is activated, SPORT mode is deactivated.

If the vehicle is switched to manual mode while the winter programme is active, the winter programme is interrupted. The winter programme resumes upon return to automatic mode.

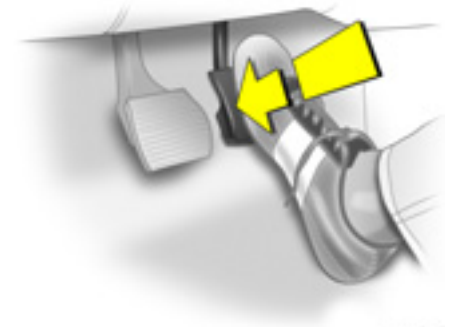

18451 1

Kickdown

Accelerator pedal pressed past the pressure point: below certain speeds, the transmission shifts down into a lower gear. Full engine power is available for acceleration.

During kickdown no manual gear shifting is possible.

When the engine speed approaches its upper limit, the transmission shifts to a higher gear during kickdown even in Manual mode.

Without kickdown this automatic shift is not effected in Manual mode.

If SPORT mode is engaged, the drive wheels may spin slightly when starting off with kickdown. This allows for maximum acceleration of the vehicle.

Braking assistance from engine

Automatic mode:

When driving downhill, Easytronic does not shift into higher gears until a fairly high engine speed has been reached. When braking, Easytronic shifts down in good time.

Manual mode:

To utilise the engine braking effect, select a lower gear in good time when driving downhill.

"Rocking the car"

If it becomes necessary to rock the vehicle to free it from sand, mud, snow or a hole, move the selector lever between **R** and **A** (or + or -) in a repeat pattern while applying light pressure to the accelerator pedal. Do not race the engine and avoid sudden acceleration.

This applies only to the exceptional circumstances mentioned above.

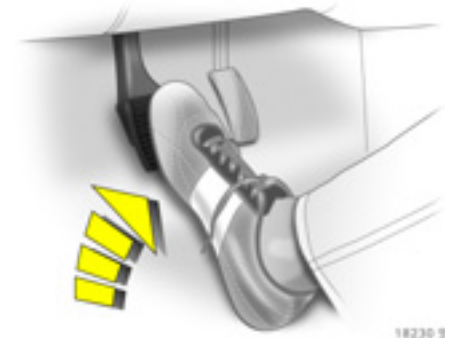

Manoeuvring the vehicle

To manoeuvre the vehicle back and forth during attempts to park or in garage entrances the creeping movement can be utilised by releasing the foot brake.

Never actuate accelerator and brake pedals simultaneously.

To prevent damage, Easytronic disengages the "creep function" when the temperature of the automatic clutch is high.

Stopping the vehicle

In Automatic or Manual mode, when the vehicle has stopped first gear (with Winter mode engaged, second gear) is engaged automatically and the clutch released. In **R** reverse remains engaged.

A warning buzzer sounds when the driver's door is opened if the engine is running, a gear is engaged and the foot brake is not depressed. The vehicle creeps if the hand brake is not engaged. Move the selector lever to **N** and apply the hand brake.

When stopping on gradients, engage the hand brake or depress the brake pedal. To prevent overheating of the clutch, do not increase engine speed to ensure smooth idling when in gear.

To prevent damage to the Easytronic, the clutch is closed automatically at high clutch temperatures.

Switch off engine if stopping for a lengthy period, e.g. in traffic jams or at level crossings.

Vehicle storage

Before leaving the vehicle:

- engage hand brake
- Remove the ignition key or, with the Open&Start system , remove the electronic key from the vehicle.

The most recently engaged gear (indicator in transmission display) remains engaged. With **N**, no gear is engaged.

When the ignition is switched off the Easytronic no longer responds to movement of the selector lever.

Lock the vehicle. Otherwise the battery may become discharged if the vehicle is parked for long periods.

If the hand brake has not been applied, the control indicator  flashes for a few seconds after the ignition is switched off.

With the engine off and the hand brake not applied, when the driver's door is opened a warning buzzer sounds and the control indicator  flashes; switch on ignition, engage gear, switch off ignition and apply hand brake.



17028 1

Fault

Control indicator  illuminates in the event of a fault in the Easytronic system. In the event of serious faults, **F** also appears in the transmission display.

It is possible to continue driving if only control indicator  illuminates. Manual mode can then no longer be selected.

If **F** appears in the transmission display, continued driving is not possible.

Have the cause of the fault remedied. We recommend that you consult your Vauxhall Authorised Repairer. The system's integrated self-diagnostics allows faults to be quickly remedied.

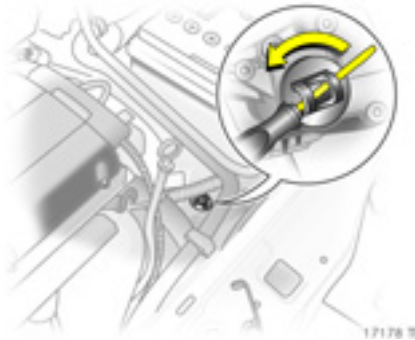

Interruption of power supply

The clutch is not disengaged if the vehicle battery is discharged and a gear has been selected. The vehicle cannot move.

If the battery is flat, start the vehicle using jump leads – page 248.

If the interruption of power supply was not caused by a discharged battery, consult a workshop. We recommend your Vauxhall Authorised Repairer. If the vehicle must be moved out of the flow of traffic, disengage the clutch on vehicles with 5-speed Easytronic. Disengaging the clutch is not possible on vehicles with 6-speed Easytronic ✱. The vehicle must be moved. Raise the vehicle by the front axle when towing.

To disengage the clutch (only on vehicles with 5-speed Easytronic):

1. Apply hand brake and switch off ignition.
2. Open bonnet and engage support.

3. Clean Easytronic around the cap (see figure) so that no dirt can get into the opening when the cap is removed.
4. Rotate cap to slacken and remove by lifting upwards – see figure.
5. Turn the adjusting screw clockwise using a flat-head screwdriver (vehicle tools ✱ – page 256) until clear resistance can be felt. The clutch has now been disengaged.

Do not turn beyond the resistance, since this can damage the Easytronic.

6. Fit cleaned cap again. The cap must be in full contact with the housing.

Towing the vehicle and starting the engine is not permitted when the clutch has been released in this way, although the vehicle can be moved a short distance.

Consult a workshop immediately. We recommend your Vauxhall Authorised Repairer.

Automatic transmission

| | |
|--|-----|
| Selector lever positions P, R, N and D | 187 |
| Gears 3, 2, 1 | 187 |
| Electronically controlled driving programmes | 188 |
| Winter programme  | 189 |
| Kickdown | 189 |
| Engine braking | 189 |
| "Rocking the car" | 189 |
| Manoeuvring the vehicle | 190 |
| Stopping the vehicle | 190 |
| Fault | 190 |
| Interruption of power supply | 191 |

The automatic transmission  allows automatic selection.

The engine can only be started when the gear selector is in position **P** or **N**. When starting in position **N**, depress the foot brake or apply the hand brake. After starting the engine, depress the brake before selecting a gear. Do not accelerate whilst selecting a gear. If a gear has been selected and the brake is released, the vehicle will "creep". Never operate the accelerator and the brake pedal simultaneously. The selected gear is displayed in the transmission display.

Warning

Disregard of these instructions may lead to injuries or endanger life.

Only select **3**, **2** or **1** to prevent automatic upshifting or as an aid in engine braking.



Transmission display

Display of mode or selected gear in left position of transmission display. The gear that has been selected by the transmission appears in the right position of the transmission display.

| | |
|----------------|---|
| P | Park position. |
| R | Reverse gear. |
| N | Neutral. |
| D | Drive position. |
| 3, 2, 1 | Selected gear  . |



Selector lever positions P, R, N and D

- P** Park position. Front wheels locked. Only engage when the vehicle is stationary and the hand brake is applied. "P" appears on the transmission display.
- R** Reverse gear. Only engage when the vehicle is stationary. "R" appears on the transmission display.
- N** Neutral or idle. "N" appears on the transmission display.
- D** Drive position for normal driving in 1st gear to highest gear. "D" and the current gear appear in the transmission display.

The selector lever can only be moved from **P** when the ignition is switched on and the foot brake depressed (selector lever lock).

To engage **P** or **R**, push button on selector lever.

The engine can only be started with lever in position **P** or **N**. When position **N** is selected, press foot brake or engage hand brake before starting.

Do not accelerate during the selection procedure.

Gears 3, 2, 1



3, 2, 1 Transmission does not shift above the selected gear.

Press button on selector lever to engage **3** or **1**.

The current gear is displayed in the transmission display.



Electronically controlled driving programmes

- When SPORT mode is engaged, the transmission shifts at higher engine speeds (unless cruise control is on). Control indicator  illuminates in the transmission display. SPORT mode – page 214.
- Winter programme: Press button  – page 189.

- Automatic neutral shift function automatically sets the transmission to **N** to reduce fuel consumption, e.g. at traffic lights.

The automatic neutral is activated when:

- the selector lever is in automatic mode ,
- the selector lever is in position **3, 2** or **1**,
- the foot brake is depressed,
- the vehicle is stationary,
- the accelerator pedal is not actuated,
- the transmission fluid temperature is greater than 0 °C.

As soon as the brake is released and the accelerator pedal is depressed, the vehicle starts off in the usual manner.

- By means of delayed gear changing (higher engine speeds) following a cold start, the operating temperature programme quickly and automatically brings the catalytic converter to the temperature required for optimum pollutant reduction.
- The adaptive programme automatically tailors gearshifting to the driving conditions, e.g. greater load or gradients.



S 12098

Winter programme ❄️

Press button ❄️ if you are having problems starting off on a slippery road surface.

To activate

The winter programme can be activated in **P**, **R**, **N**, **D** and **3** (❄️ illuminates in the transmission display). The vehicle starts off in 3rd gear.

To deactivate

The winter program is switched off by:

- pressing button ❄️ again,
- shifting to **2** or **1** manually,
- turning off the ignition.

In order to prevent damage, the winter program switches off automatically at high transmission oil temperatures.

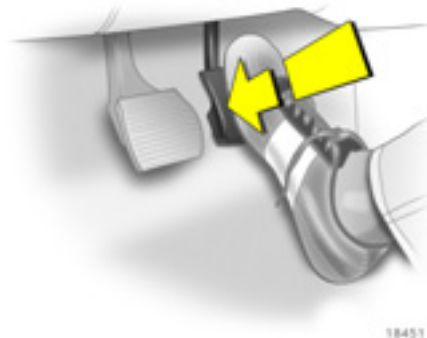

18451 E

Kickdown

Depressing the accelerator pedal past the pressure point: depending on the engine speed the transmission shifts to a lower gear. Full engine power is available for accelerating.

Engine braking

In order to utilise the engine braking effect when driving downhill, select drive range **3**, **2** or, if necessary, **1** in good time.

The braking action is most effective in drive range **1**. If drive range **1** is selected at too high a speed, the transmission remains in second gear until the shift point for first gear is reached, e.g. as a result of deceleration.

"Rocking the car"

If it becomes necessary to rock the vehicle to free it from sand, mud, snow or a hole, move the selector lever from **D** to **R** in a repeat pattern while simultaneously applying light pressure to the accelerator pedal. Do not race the engine and avoid sudden acceleration.

This applies only to the exceptional circumstances mentioned above.

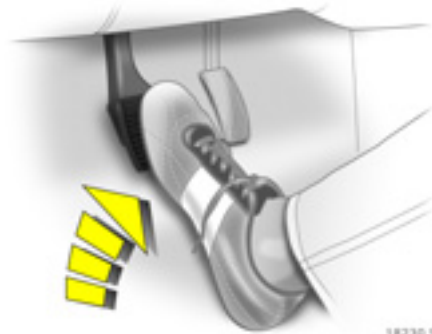

18230 1

Manoeuvring the vehicle

To manoeuvre the vehicle back and forth during attempts to park or in garage entrances, the vehicle's creeping movement can be utilised by releasing the brake pedal.

Never actuate accelerator and brake pedals simultaneously.

Stopping the vehicle

The selector lever can be left in the chosen gear with the engine running.

When stopping on gradients engage hand brake or depress brake pedal. To prevent overheating of the transmission, do not increase engine revolutions to ensure smooth idling while standing if a gear has been selected.

Switch off engine if stopping for a lengthy period, e.g. in traffic jams or at level crossings.

Before leaving the vehicle, first apply the hand brake. Then select **P**. Remove the ignition key or, with Open&Start system, remove the electronic key  from the vehicle. Lock the vehicle. Otherwise the battery may become discharged if the vehicle is parked up for long periods.

The ignition key can only be removed when the selector lever is in position **P**.

With the Open&Start system , "P" flashes in the transmission display for 10 seconds when the ignition is switched off if **P** has not been engaged or the hand brake has not been applied.



17028 1

Fault

If there is a problem with the automatic transmission, control indicator  illuminates. The transmission no longer shifts automatically. The vehicle can continue to be driven.

Illumination of control indicator  may also indicate a problem with the engine electronics – page 210.

For diesel engines ¹⁾ Z 19 DTL, Z 19 DT and Z 19 DTH, illumination of control indicator  could also indicate that the diesel fuel filter must be drained of water - page 300.

Have the cause of the fault remedied. We recommend that you consult your Vauxhall Authorised Repairer.

¹⁾ Sales designation – see page 315.

The transmission no longer shifts automatically. Vehicle can continue to be driven. Second gear is not available. Forward gears 1, 3 and 4 must be shifted manually using selector lever:

- 1 = 1st gear
- 2 = 3rd gear
- 3, D = 4th gear

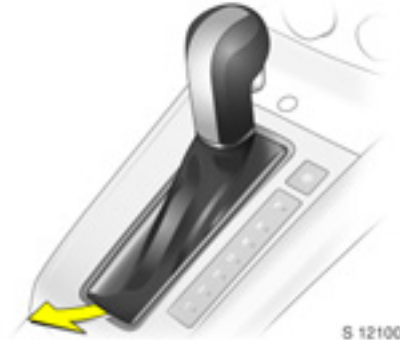

Interruption of power supply

If the vehicle battery is flat, the selector lever cannot be moved out of position **P**.

If the battery is flat, start the vehicle using jump leads – see page 248.

If the battery is not the cause of the fault, release selector lever:

1. Apply hand brake.
2. Disengage selector lever trim rearward from centre console and fold upwards.



3. Push the yellow catch forward with a screwdriver and move the selector lever out of **P**.
4. Mount selector lever trim on centre console and refit.

Re-selecting **P** locks the selector lever again. Have cause of power supply interruption remedied. We recommend that you consult your Vauxhall Authorised Repairer.

Automatic transmission with ActiveSelect

| | |
|--|-----|
| Transmission display | 193 |
| Selector lever settings P, R, N and D (automatic mode) | 193 |
| ActiveSelect (manual mode) | 194 |
| Electronically controlled driving programmes | 195 |
| Winter programme ❄ | 196 |
| Kickdown | 196 |
| Engine braking | 197 |
| "Rocking the car" | 197 |
| Manoeuvring the vehicle | 197 |
| Stopping the vehicle | 198 |
| Fault | 198 |
| Interruption of power supply | 199 |

This automatic transmission ❄ allows both automatic gearchanges (**automatic mode**) and manual gearchanges (**manual mode**) ❄.

The engine can only be started when the selector lever is in position **P** or **N**. When starting in position **N**, depress the foot brake or apply the hand brake. After the engine has started, depress the brake before selecting a gear. Do not accelerate whilst selecting a gear. If a gear has been selected and the brake is released, the vehicle will "creep". Never operate the accelerator and the brake pedal simultaneously. The selected gear is displayed in the transmission display – page 193.

Warning

Disregard of these instructions may lead to injuries or endanger life.

Selecting **D** puts the transmission in automatic mode.

If the selector lever is moved to the left from the **D** position, manual mode is activated. Gearchanges can then be made manually by tipping the selector lever toward + or -.



Transmission display

Display of mode or selected gear in left position of transmission display. The gear that has been selected by the transmission appears in the right position of the transmission display.

- P** Park position.
- R** Reverse gear.
- N** Neutral.
- D** Automatic mode.
- M** Manual mode with display of selected gear.



Selector lever settings P, R, N and D (automatic mode)

- P** Park position. Front wheels locked. Only engage when the vehicle is stationary and the hand brake is applied. "P" appears on the transmission display.
- R** Reverse gear. Only engage when the vehicle is stationary. "R" appears on the transmission display.
- N** Neutral or idle. "N" appears on the transmission display.
- D** Drive position for normal driving in 1st gear to highest gear. "D" and the current gear appear in the transmission display.

The selector lever can only be moved out of position **P** or **N** with the ignition switched on and the foot brake applied (selector lever lock). In selector lever position **N** the selector lever lock is activated after a delay and only if the vehicle is stationary.



In position **P** or **N**, control indicator  illuminates red in the selector lever indicator strip if the selector lever is blocked.

To engage **P** or **R**, push button on selector lever.

The engine can only be started with lever in position **P** or **N**. When position **N** is selected, press foot brake or engage hand brake before starting.

Do not accelerate during the selection procedure.



ActiveSelect (manual mode)

Move selector lever out of position **D** and then forwards or backwards.

- + Shift to a higher gear
- Shift to a lower gear

If a higher gear is selected at a speed that is too slow or a lower gear is selected at a speed that is too high, the gear will not be changed. This prevents the revs from being too low or too high.

If the engine revs are too low the transmission automatically shifts to a lower gear, but not unless a certain speed has been reached.



No automatic shifting to a higher gear takes place at high engine revs.

For safety reasons, kickdown is also available in manual mode – page 196.

The selected gear is displayed in the transmission display – page 193.



Electronically controlled driving programmes

- When SPORT mode is engaged, the transmission shifts at higher engine speeds (unless cruise control is on). Control indicator  illuminates in the transmission display. SPORT mode – page 214.
- Winter programme: Press button  – page 196.

- Automatic neutral shift function automatically sets the transmission to N to reduce fuel consumption, e.g. at traffic lights.

The automatic neutral is activated when:

- the selector lever is in automatic or manual mode,
- the foot brake is depressed,
- the vehicle is stationary,
- the accelerator pedal is not actuated,
- the transmission fluid temperature is greater than 0 °C.

As soon as the brake is released and the accelerator pedal is depressed, the vehicle starts off in the usual manner.

- The operating temperature programme automatically brings the catalytic converter to the temperature that is required for optimum emission reduction after a cold start by selecting an appropriate gear (increased engine revs).
- The adaptive programme automatically tailors gearshifting to the driving conditions, e.g. greater load or gradients.



Winter programme ❄️

Press button ❄️ if you are having problems starting off on a slippery road surface.

To activate

The winter programme can be activated in automatic mode (❄️ illuminates in transmission display). The vehicle starts off in 4th gear.

To deactivate

The winter program is switched off by:

- pressing button ❄️ again,
- changing to manual mode,
- turning off the ignition.

In order to prevent damage, the winter program switches off automatically at high transmission oil temperatures.

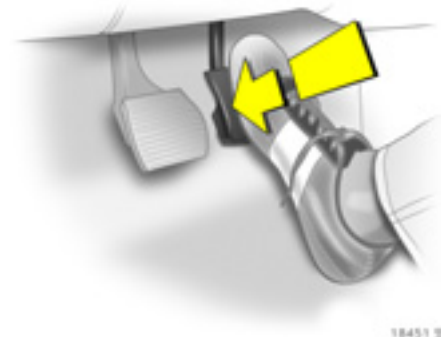

Kickdown

Depressing the accelerator pedal past the pressure point: depending on the engine speed the transmission shifts to a lower gear. Full engine power is available for accelerating.

For safety reasons kickdown is available in both automatic and manual mode.

Engine braking

The automatic transmission automatically selects the driving programs with the best possible braking effect.

If necessary, lower gears can also be selected in manual mode to increase the braking effect. 1st gear has the greatest braking effect.

"Rocking the car"

If it becomes necessary to rock the vehicle to free it from sand, mud, snow or a hole, move the selector lever from **D** to **R** in a repeat pattern while simultaneously applying light pressure to the accelerator pedal. Do not race the engine and avoid sudden acceleration.

This applies only to the exceptional circumstances mentioned above.

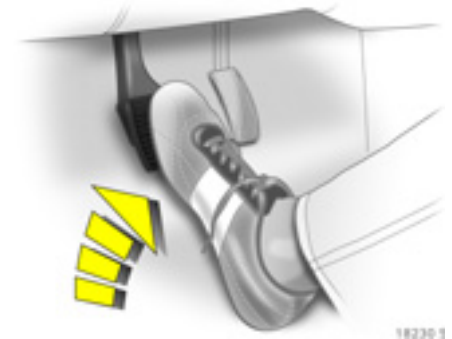

Manoeuvring the vehicle

To manoeuvre the vehicle back and forth during attempts to park or in garage entrances, the vehicle's creeping movement can be utilised by releasing the brake pedal.

Never actuate accelerator and brake pedals simultaneously.

Stopping the vehicle

The selector lever can be left in the chosen gear with the engine running.

When stopping on gradients engage hand brake or depress brake pedal. To prevent overheating of the transmission, do not increase engine revolutions to ensure smooth idling while standing if a gear has been selected.

Switch off engine if stopping for a lengthy period, e.g. in traffic jams or at level crossings.

Before leaving the vehicle, first apply the hand brake. Then select **P**. Remove the ignition key or, with Open&Start system, remove the electronic key \ast from the vehicle. Lock the vehicle. Otherwise the battery may become discharged if the vehicle is parked up for long periods.

The ignition key can only be removed when the selector lever is in position **P**.

If the selector lever is not in position **P** when the ignition is switched off, control indicator \odot and **P** flash in the selector lever indicator strip – page 194, Fig. 17194 T. Move the selector lever to position **P**.

With the Open&Start system \ast , "P" flashes in the transmission display for 10 seconds when the ignition is switched off if **P** has not been engaged or the hand brake has not been applied.



17028 1

Fault

If there is a problem with the automatic transmission, control indicator \odot illuminates. The transmission no longer shifts automatically. The vehicle can continue to be driven.

Illumination of control indicator \odot may also indicate a problem with the engine electronics – page 210.

For diesel engines ¹⁾ Z 19 DTL, Z 19 DT and Z 19 DTH, illumination of control indicator \odot could also indicate that the diesel fuel filter must be drained of water - page 300.

Have the cause of the fault remedied. We recommend that you consult your Vauxhall Authorised Repairer.

¹⁾ Sales designation – see page 315.

2nd gear and the highest gear can be selected in manual mode. Depending on the nature of the problem, only the highest gear may be available.

Only the highest gear is available in **D** in automatic mode.

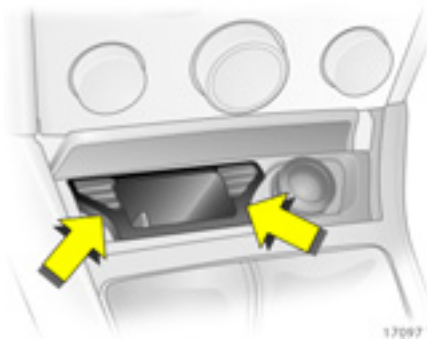

Interruption of power supply

If the vehicle battery is flat, the selector lever cannot be moved out of position **P** or **N**.

If the battery is flat, start the vehicle using jump leads – page 248.

If the battery is not the cause of the fault, release selector lever:

1. Apply hand brake.
2. Remove the ashtray insert * or the rubber covering on the bottom of the stowage compartment * - page 108.

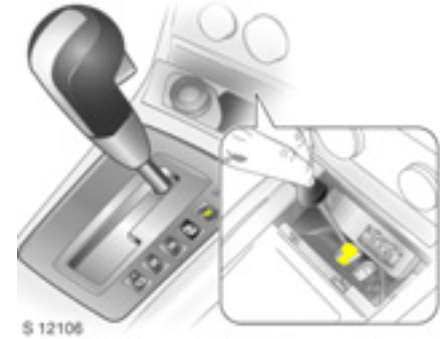

3. To open, push the yellow catch down with a screwdriver and move the selector lever out of **P** or **N**.
4. Refit the ashtray insert * or rubber covering on the bottom of the stowage compartment * - page 108.

Re-selecting **P** or **N** locks the selector lever again. Have cause of power supply interruption remedied. We recommend your Vauxhall Authorised Repairer.

Driving hints

The first 600 miles / 1000 km

Drive your vehicle at various speeds. Do not use full throttle. Never allow the engine to labour at low revs.

Make good use of all gears. Depress the accelerator pedal a maximum of around three quarters of the available pedal travel in all gears.

Do not drive faster than three quarters of maximum speed.

Do not brake unnecessarily hard for the first 120 miles (200 km).

Never coast with engine not running

Many units will not function in this situation (e.g. brake servo unit, electro-hydraulic power steering). Driving in this manner is a danger to yourself and others.

Brake servo unit

When the engine is not running, the brake servo unit is no longer effective once the brake pedal has been depressed once or twice. Braking effect is not reduced, but significantly greater force is required for braking.

Electro-hydraulic power assisted steering

If the power-assisted steering fails when being towed with the engine switched off, the vehicle can still be steered, but considerably more force is required.

Driving in mountainous terrain or with a trailer/caravan

The cooling fan is electrically operated. Its cooling power is therefore independent of the engine speed.

Since a considerable amount of heat is generated at high engine speeds and less at slower speeds, do not shift down when climbing hills whilst the vehicle is still coping with the gradient in the higher gear.

Driving with a roof load

Do not exceed the permissible roof load - pages 238, 324. For reasons of safety, distribute the load evenly and secure it properly with retaining straps. Adjust the tyre pressure to the load conditions. Do not drive faster than 75 mph (120 km/h). Check and retighten the straps frequently. Observe country-specific regulations. Roof loads are not permitted on the Astra TwinTop.

Switching off the engine

When you switch off, fans in the engine compartment may continue running for a time to cool the engine.

If the engine temperature is very high, e.g. after driving in mountainous terrain: allow the engine to idle for approximately two minutes in order to prevent heat accumulation.

Vehicles with turbocharged engine

After running at high engine speeds or high engine loads, operate the engine briefly at a low load or run in neutral for approx. 30 seconds before switching off in order to protect the turbocharger.

Save energy – more miles

Please observe the running-in hints on the previous page and the tips for saving energy on the following pages.

Good, technically correct and economical driving ensures maximum durability and performance for your vehicle.

Overrun

The fuel supply is automatically shut off during overrun, e.g. when the vehicle is being driven down long gradients or when braking. To enable the overrun cut-off to take effect, do not accelerate during overrun and, if in manual transmission mode, do not de-clutch. To prevent damage to the catalytic converter, overrun cut-off is temporarily deactivated when the catalytic converter temperature is high.

Vehicles with turbocharged engine

Flow-generated noises may be audible if the accelerator is released quickly on account of air flow in the turbocharger.

Engine speed

Drive in a low engine speed range for each gear as much as possible.

Warming up

Allow the engine to warm up while driving. Do not warm it up by letting it run at idling speed. Do not apply full throttle until the engine has reached operating temperature.

After a cold start, the automatic transmission * or Easytronic * in automatic mode shifts into higher gears at higher rpm. This allows the catalytic converter to quickly reach the temperature required for optimum pollutant reduction.

Correct gear selection

Engine in neutral and without revving in the lower gears. Stop-and-go traffic and driving at a speed too high for the selected gear or transmission ratio increases wear and fuel consumption.

Change down

When decreasing speed, shift down into the next lowest gear. Do not slip the clutch with a high-revving engine. This is especially important when hill climbing.

Clutch operation

Always depress the clutch pedal hard to the floor to prevent shifting difficulties and transmission damage.

When driving do not use the pedal as a foot rest; this will cause substantial clutch wear.

Cooling fan

The cooling fan is controlled via a thermostic switch and therefore only runs if necessary.

Vehicles with diesel particle filter *: the cooling fan comes on automatically during particle filter cleaning.

Pedals

Do not place any objects in the foot well which could slip under the pedals and inhibit the pedal travel.

To ensure the pedal travel is uninhibited, there must be no mats in the area of the pedals.

Battery care

When driving slowly or when the vehicle is stationary, e.g. in slow urban traffic, stop-and-go traffic or traffic jams, turn off all unnecessary electrical loads where possible (e.g. heated rear window, heated seats).

Declutch when starting in order to relieve the strain on the starter and the battery.

Saving fuel, Protecting the environment

Trend-setting technology

When developing and manufacturing your vehicle, Vauxhall used environment-friendly and in the main recyclable materials. The production methods used to make your vehicle are likewise environmentally-compatible.

Recycling of production wastes keeps the circulation of material closed. Reduction of energy and water requirements also helps to conserve natural resources.

A highly advanced design means that your vehicle can be easily disassembled at the end of its working life, and the individual materials separated for subsequent re-use.

Materials such as asbestos and cadmium are not used. The refrigerant in the air conditioning system * is CFC-free.

New painting techniques employ water as a solvent.

End-of-life vehicle recovery

For detailed information on Vauxhall's on-going commitment to achieving an environmentally sustainable future, including; design for recycling, take back of End-of-Life Vehicle (ELVs) and the recycling of ELVs, view www.vauxhall.co.uk/recycling for details.

Energy and environment-conscious driving

- High noise levels and exhaust emissions are often a result of driving without due attention to saving energy and protecting the environment.
- You should therefore drive with energy in mind – "more miles with less fuel".

Reduce the noise level and exhaust emissions by adopting an environment-conscious driving style. This is extremely worthwhile and improves the quality of life.

Fuel consumption depends to a great extent on your own personal driving style. The following hints are intended to help you consume fuel at a rate that is as close as possible to the specified levels – page 319.

Check your vehicle's fuel consumption every time you refuel. This facilitates early detection of any irregularities causing increased fuel consumption.

Warming up

- Full throttle and warming up at idle speed increase wear, fuel consumption, exhaust emission, the amount of pollutant in the exhaust and the amount of noise.
- Drive off as soon as possible after starting.

Uniform speed

- Hectic driving significantly increases fuel consumption, the exhaust emissions, the proportion of pollutant in the exhaust gas and the noise level.
- Do not accelerate and brake unnecessarily. Drive at uniform speed, watching the road.

Avoid frequent starting off and stopping e.g. at traffic lights, in short distance traffic and in queues of traffic by means of clever planning. Select roads with good traffic flow.

Idling

- The engine also consumes fuel when idling.
- If you have to wait for more than one minute, it is worthwhile switching off the engine. Five minutes of idling corresponds to approximately 0.6 miles (1 km) of driving.

Overrun

- The fuel supply is automatically shut off during overrun, e.g. when the vehicle is being driven down long gradients or when braking – page 201.
- To enable the overrun cut-off to come into action and save fuel, do not accelerate or declutch during overrun.

Correct gear selection

- High revs increase engine wear and fuel consumption.
- Do not race your engine. Avoid driving at high engine speeds.

Making use of the tachometer helps to save fuel. Drive in a low engine speed range for each gear as much as possible with uniform engine speeds. Drive as often as possible in top gear, select the next higher gear as soon as possible, and only change down when the engine is no longer running perfectly smoothly.

High speed

- The higher the speed, the higher the consumption and the noise level. At top speed, you consume a great deal of fuel and produce excessive noise and exhaust emissions.

- Slightly releasing the accelerator pedal results in distinct fuel savings with no major loss of speed.

Drive at no more than around three quarters of maximum speed and you will use up to 50 % less fuel, without losing a great deal of time.

Tyre pressure

- Inadequate tyre pressure, leading to higher road resistance, costs money in two ways: for more fuel and increased tyre wear.
- Regular checks (every 14 days) pay off.

Electrical loads

- The power consumption of electrical equipment increases fuel consumption.
- Switch off all auxiliary electrical loads (e.g. air conditioning ✱, heated rear window) when not needed.

Roof racks, ski-holders

- Due to air resistance, a roof load can increase fuel consumption by approx. 3.5 gal. /1000 miles (1 l/100 km).
- Remove them if they are not being used.

Repair and maintenance

- Improper repairs or adjustment and maintenance work can increase fuel consumption. Do not carry out work on the engine yourself.

You may out of ignorance infringe environmental laws by not disposing of materials properly.

Appropriate parts might not be recycled.

Contact with some of the materials involved may pose a health hazard.

- We recommend that repair and maintenance be entrusted to your Vauxhall Authorised Repairer.

Extreme driving conditions

- Going up steep slopes, cornering, driving on poor roads and winter driving all increase fuel consumption.

Fuel consumption increases dramatically in urban traffic and at winter temperatures, especially on short trips when the engine operating temperature is not reached.

- Follow the hints given above to keep consumption to a minimum under such conditions.

Fuel consumption, fuel, refuelling

| | |
|------------------------------|-----|
| Fuel for diesel engines..... | 205 |
| Fuel filler cap..... | 205 |
| Refuelling..... | 205 |

Fuel consumption

Fuel consumption is determined under specific driving conditions – page 319.

Special equipment increases the weight of the vehicle. As a result, they can increase fuel consumption and reduce the specified maximum speed.

For the first few thousand miles, friction between the engine and transmission components is higher. This increases fuel consumption.

Fuel for petrol engines

Normal commercial high-quality fuels with a maximum ethanol content of 5% in accordance with DIN EN 228 are suitable (for catalytic converter – page 207, for octane numbers – pages 314, 315). The quality thereof has considerable effect on the performance, running and service life of the engine. The additives mixed with the fuel are extremely important. For this reason you must only refuel with high quality fuels containing additives.

Fuels with ethanol content greater than 5% do not comply with DIN EN 228 and must not be used unless the vehicle has been specifically developed and approved for these fuels.

Fuel with too low an octane number can cause pinking. Vauxhall cannot be held liable for resulting damage.

Petrol with a higher octane number can always be used.

The ignition timing adjusts automatically to the grade of fuel used (octane number) – pages 314, 315.

Use of petrol with an octane rating of 95 will ensure economical driving.

For vehicles with Z20 LEH¹⁾ engine, use of 95 RON fuel reduces performance and torque.

¹⁾ Sales designation – see page 314.

Fuel for diesel engines

Diesel engines must be operated only on commercially available diesel fuel meeting the specifications of DIN EN 590.

Since January 2004, some oil companies have mixed their diesel fuel with upto 5% Bio fuel (FAME = Fatty Acid Methyl Esters) like RME (Rape-Oil Methyl Ester). This is in accordance with the current DIN EN 590 and does not harm the fuel/injection system. The characteristics of a diesel fuel mixed up with 5% Bio fuel (FAME) do not differ from conventional diesel fuel and do not influence the vehicle's driveability.

Important: Diesel fuel mixed with 5% FAME according to DIN EN 590 must not be confused with 100% Bio Diesel, which is not to be used in Vauxhall engines.

The flow and filterability of diesel fuel are temperature-dependent.

Diesel fuels with improved low temperature properties are therefore available on the market during the winter months. Make sure that you fill the tank with winter fuel before the start of the cold weather season.

Additives can be used with diesel fuels with winter properties that are guaranteed by the manufacturer and when using diesel fuel filters that are heated depending on the outside temperature.

Fuel filler cap

If replacing the fuel filler cap, be sure to use a genuine Vauxhall fuel filler cap for your model to ensure full functionality. Diesel-engined vehicles have special fuel filler caps.

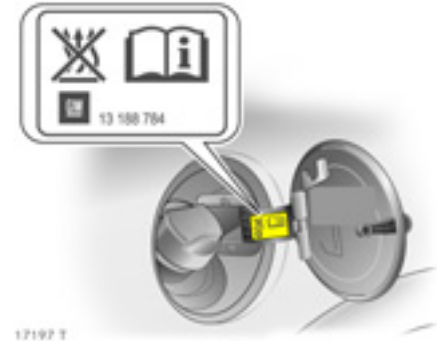

Refuelling

Warning

Care must be taken when handling fuel.

Before refuelling, switch off the engine and where applicable any auxiliary heating with combustion chambers (see sticker on fuel filler cap). Switch off mobile phones.



Warning

Fuel is flammable and explosive. avoid naked flames or sparks when handling fuel or just in its vicinity. Do not smoke. This also applies where fuel is perceptible only from its characteristic odour. If fuel odours occur in the vehicle itself, eliminate the cause immediately. We recommend your Vauxhall Authorised Repairer.

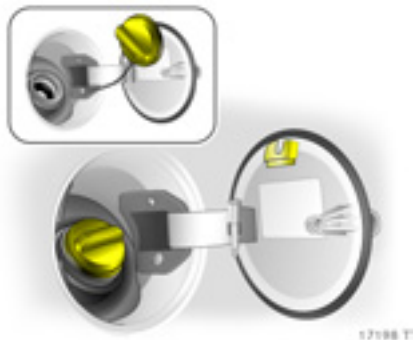

Fuel filler neck at right rear side of vehicle.

The tank flap is locked together with the doors – page 76.

Open the tank flap.

Unscrew the fuel filler cap, remove and suspend from the tank flap.

The fuel tank has a limiting system which prevents overfilling of the tank.

Correct filling depends to a large extent on proper operation of the fuel dispensing pump:

1. Fully insert the pump nozzle and switch it on.
2. After automatic switch off, the specified tank capacity is reached after continued, measured filling. Leave the filler nozzle in place until the stop.

To close, position the fuel filler cap and rotate past the resistance until the cap audibly clicks over the retainer.

Close fuel tank cover.

Wipe off any overflowing fuel immediately.

Catalytic converter, exhaust gases

| | |
|--|-----|
| Catalytic converter for petrol engines | 207 |
| Catalytic converter for diesel engines | 208 |
| Controlling exhaust emission..... | 209 |
| Exhaust gases | 210 |
| Maintenance | 211 |

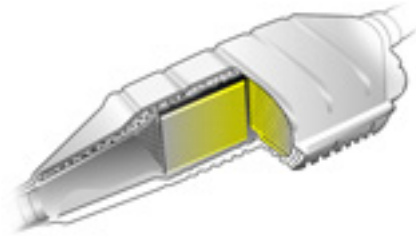

17199 01

Catalytic converter for petrol engines

Leaded fuel will damage the catalytic converter and parts of the electronic system, rendering them inoperative.

High quality fuels other than those listed on pages 204, 314 (e. g. LRP¹⁾) could damage the catalytic converter.

Damage to the catalytic converter or the vehicle may result if the following points are not observed:

- Consult a workshop, such as your Vauxhall Authorised Repairer, as quickly as possible in the event of misfiring, irregular engine running following a cold start, a significant loss of engine power or other unusual malfunctions which may indicate a fault in the ignition system. If necessary, driving may be continued for a short time at a low speed and with a low engine speed.



Irregular engine running and a loss of engine power when the Electronic Stability Program (ESP @^{Plus}*) comes into action are the result of operating conditions and are therefore of no significance - page 212.



¹⁾ LRP = L ead R eplacement P etrol.

- If unburned fuel enters the catalytic converter, this may result in overheating and irreparable damage to the catalytic converter.

You should therefore avoid unnecessarily long use of the starter when starting off, running the tank dry (an irregular fuel supply will lead to overheating) and starting the engine by pushing or towing.

- If the emission control indicator  flashes, slow down until the flashing stops and the control indicator is steady. Consult a workshop immediately. We recommend your Vauxhall Authorised Repairer. For emission control indicator  – page 209.

Catalytic converter for diesel engines

Damage to the catalytic converter or the vehicle may result if the following points are not observed:

- Consult a workshop, such as your Vauxhall Authorised Repairer, as quickly as possible in the event of irregular engine running, a significant loss of engine power or other unusual malfunctions. If necessary, driving may be continued for a short time at a low speed and with a low engine speed.

Irregular engine running and a loss of engine power when the Electronic Stability Program (ESP @^{Plus} ) comes into action are the result of operating conditions and are therefore of no significance - page 212.



Controlling exhaust emission

Some of the damaging substances in the exhaust such as carbon monoxide (CO), hydrocarbons (HC) and nitrous oxides (NO_x) are reduced to a minimum by making structural changes – mainly in the injection system and the ignition system in conjunction with the catalytic converter.



Control indicator for exhaust

Illuminates when the ignition is switched on and during the start attempt. Goes off shortly after the engine starts running.

If it illuminates while the engine running there is a fault in the emission control system. The permitted emission values may be exceeded. Consult a workshop immediately. We recommend your Vauxhall Authorised Repairer.

Flashing with the engine running indicates a fault that may damage the catalytic converter. You can continue to drive without causing damage by slowing down until the flashing stops and the control indicator is steady. Consult a workshop immediately. We recommend your Vauxhall Authorised Repairer.



17028 1



Control indicator for engine electronics

Illuminates for a few seconds after the ignition is switched on.

If it illuminates when the engine is running, there is a fault in engine or transmission electronics. The electronic system switches to an emergency running programme. Fuel consumption may be increased and the driveability of the vehicle may be impaired.

In some cases, the fault can be remedied by switching the engine off and on again. If the control indicator illuminates again when the engine is running, consult a workshop to have the cause of the fault remedied. We recommend your Vauxhall Authorised Repairer.

If it illuminates briefly, but does not recur, it is of no significance.

Illumination of  could indicate the presence of water in the diesel fuel filter . A text message will appear in the service display at the same time, – page 44. Have the fuel filter checked for moisture. We recommend that you consult your Vauxhall Authorised Repairer.

If it flashes after the ignition is switched on, there is a fault in the immobiliser system. The engine cannot be started – page 67.

Exhaust gases

Warning

Engine exhaust gases contain poisonous carbon monoxide, which is colourless and odourless and could be fatal if inhaled.

If exhaust fumes penetrate the vehicle interior, open the windows and consult a workshop immediately. We recommend your Vauxhall Authorised Repairer.

Avoid driving with an open luggage compartment. Otherwise, exhaust gases could penetrate the interior.

During the first drive smoke may develop because of wax and oil evaporating on the exhaust system. Park the vehicle in the open for a while after the first drive and avoid inhaling the fumes.

Diesel particle filter *

The diesel particle filter system contains a self-cleaning function at certain intervals. The filter is cleaned by burning soot particles. The amount of noise and fumes that is generated is normal.

The heated rear window is automatically switched on for the duration of the self-cleaning *.

Maintenance

Have all maintenance work carried out at the intervals specified by Vauxhall. We recommend that you entrust this work to your Vauxhall Authorised Repairer, who has proper equipment and trained personnel available. Electronic testing systems permit rapid diagnosis and remedy of faults. This way you can be certain that all components of the vehicle's electrical, injection and ignition systems operate correctly, that your vehicle has a low level of pollutant emission and that the catalytic converter system will have a long service life.

You are thereby making an important contribution towards keeping the air clean and compliance with emissions legislation.

Checking and adjustment of the fuel-injection and ignition systems is part of the scope of inspection. For this reason you should have all maintenance work carried out at the intervals specified in your Service Booklet.

Drive Control Systems

Interactive Driving System 212
 Electronic Stability Program 212
 Continuous Damping Control * 214
 SPORT mode * 214
 Cruise control * 216
 Parking distance sensor * 218
 Automatic level control * 220
 Deflation Detection System 221
 Tyre pressure monitoring system * ... 222

Interactive Driving System (IDS+) *

IDS+ unites the sensors and control units of the Electronic Stability Program (ESP®^{Plus}), Anti-lock Brake System (ABS) and Continuous Damping Control (CDC). This provides both excellent driving dynamics and greater safety.

Electronic Stability Program (ESP®^{Plus}) *

ESP®^{Plus} improves driving stability as necessary in any driving situation regardless of the type of road surface or tyre grip. It also prevents the drive wheels from spinning irrespective of road surface and tyre grip.

The system monitors vehicle movements. As soon as the vehicle starts to swerve (understeers/oversteers) engine output is reduced (the sound of the engine changes) and individual wheels are specifically braked. This considerably improves the driving stability of the vehicle on snow and ice and on wet or slippery road surfaces.

ESP®^{Plus} is ready for operation as soon as the ignition is switched on and control indicator  goes out.

When ESP®^{Plus} comes into action,  flashes.

The vehicle is now in a critical situation; ESP®^{Plus} allows you to keep control of the vehicle and reminds you to match your speed to the road conditions.

| |
|--|
|  Warning |
| Do not let this special safety feature tempt you into taking risks when driving. |
| Traffic safety can only be achieved by adopting a responsible driving style. |



17200 1

Control indicator ⚡

Illuminates for a few seconds when the ignition is switched on. The system is now ready for operation.

Flashing during driving

This shows the system has come into action. The engine output may be reduced (the sound of the engine changes) and the vehicle may be braked automatically to a small degree.

Illuminates while driving

The system is switched off or a fault is present. Continued driving is possible. The driving stability can however deteriorate depending on road surface conditions.

Reactivate ESP^{Plus} or have the cause of the fault remedied. We recommend that you consult your Vauxhall Authorised Repairer. The system's integrated self-diagnostics allow faults to be quickly remedied.

Switching off ⚡

With SPORT mode ⚡ engaged (LED in **SPORT** button illuminated), the ESP^{Plus} can be disengaged for sports performance.

Hold the **SPORT** button depressed for around 4 seconds. Control indicator ⚡ will illuminate. **ESPoff** will also appear in the service display – see page 44.

⚠ Warning

ESP^{Plus} should not be deactivated if one of the run-flat tyres ⚡ has no pressure.



17961 1

ESP^{Plus} is reactivated by pressing the **SPORT** button again or switching on the ignition.

SPORT mode – page 214.

Continuous Damping Control * (CDC)

CDC adapts vehicle damping to the current driving situation and road conditions.

The system continually monitors wheel and vehicle movements and immediately modifies the damping of each shock absorber. Chassis calibration is optimally adapted to the driving situation and road conditions.

When SPORT mode is engaged, the damping control is adapted to a sportier driving style ("harder" chassis setting).

SPORT mode - see right column.



Control indicator IDS+ for Continuous Damping Control

Illuminates for approx. 10 seconds after the driver's door is opened. If it illuminates while driving, there is a fault in the system. The system is not operational. For reasons of safety "harder" chassis calibration will be activated. Have the cause of the fault remedied. We recommend that you consult your Vauxhall Authorised Repairer. The system's integrated self-diagnostics allows faults to be quickly remedied.

SPORT mode *

SPORT mode is used to change damping *, steering *, throttle application * and the shift point for automatic transmission * and Easytronic * while driving.

Damping and steering become more direct and provide better contact with the road surface. The engine reacts more quickly to accelerator movements.

For automatic transmission * and Easytronic *, the shift times are reduced and gearchanges occur at a higher engine speed (except when cruise control is on).



To activate

Press the **SPORT** button. The LED in the button illuminates.

In vehicles with automatic transmission * or Easytronic *, control indicator  also illuminates.

SPORT mode cannot be activated if the Winter programme * is running (vehicles with automatic transmission * or Easytronic *). Winter programme – pages 182, 189, 196.

To deactivate

Briefly press the **SPORT** button again or switch off the ignition. The LED in the button goes out.

Holding it pressed switches off ESP @^{Plus} – page 213. SPORT mode remains engaged.

SPORT mode is deactivated if the Winter programme * is switched on (vehicles with automatic transmission * or Easytronic *). Winter programme – pages 182, 189, 196.





Control indicator IDS+ for SPORT mode

Illuminates for approx. 10 seconds when the driver's door is opened. If it illuminates while driving, there is a fault in the system. The system is not operational. Have the cause of the fault remedied. We recommend that you consult your Vauxhall Authorised Repairer. The system's integrated self-diagnostics allows faults to be quickly remedied.

Cruise control *

Cruise control can store and maintain speeds between 20 mph (30 km/h) and 125 mph (200 km/h). Deviation from the stored speed may occur when driving up or downhill.

For safety reasons the cruise control cannot be activated until the foot brake has been operated once.

Cruise control is operated with buttons , , and  on the turn signal stalk.

Do not use the cruise control if it is not advisable to maintain a constant speed (e.g. in situations presenting a danger to yourself and other road users, in heavy traffic or on winding, slippery or greasy roads).

With automatic transmission *, only use cruise control in **D** or in automatic mode with Easytronic *.

When the cruise control is active, reaction times may be increased due to the different position of the feet.

Warning

The driver is always responsible for ensuring that vehicle speed is appropriate for the speed limit and driving conditions - even if cruise control is engaged. Failure to follow the instructions could lead to injuries or endanger life.



17202 1

Control indicator

When driving, control indicator  will illuminate as soon as the system is switched on.

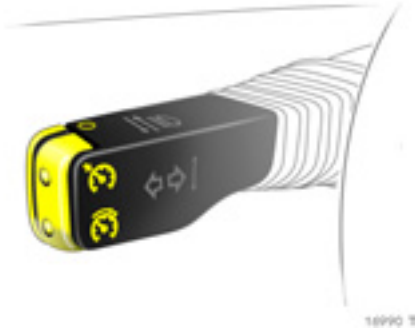



To activate

Briefly press button : the current speed is stored and maintained. The accelerator pedal can be released.

Vehicle speed can be increased by depressing the accelerator pedal. When the accelerator pedal is released, the previously stored speed is resumed.

Increase

With cruise control active, hold down button  or briefly press it repeatedly: speed is increased continuously or in steps of 1.2 mph (2 km/h) without using the accelerator pedal.



When button  is released the current speed is stored and maintained.

Decelerate

With cruise control active, hold down button  or briefly press it repeatedly: speed is reduced continuously or in steps of 1.2 mph (2 km/h).



When button  is released the current speed is stored and maintained.

To deactivate

Briefly press button : Cruise control is switched off, control indicator  goes out and the vehicle slowly decelerates. To continue driving, depress the accelerator pedal in the usual manner.

For reasons of safety, cruise control deactivates under certain driving conditions.

For example:

- the vehicle's speed drops below approx. 1.2 mph (2 km/h) or
- the brake pedal is depressed or
- the clutch pedal is depressed or
- Selector lever of automatic transmission  or Easytronic  in N.

Resuming the stored speed

Briefly press button  at a speed above 20 mph (30 km/h): the speed selected before the cruise control was switched off is resumed.

The value of the stored speed is deleted when the ignition is turned off.



17203 1

Parking distance sensor *

Parking distance sensor makes reverse parking easier by measuring the distance between the vehicle and an obstacle in the rear, and giving an acoustic signal in the passenger compartment.

The system records the distance using four sensors in the rear bumper.



17016 1

To activate

The parking distance sensor system activates automatically when the ignition is switched on and reverse gear is engaged.

Its operational readiness is indicated by illumination of the LED in button **P**▲.

If the vehicle approaches an obstacle when reversing, a series of signals can be heard in the vehicle interior. The interval between the signals becomes shorter as the distance is reduced. If the distance is less than 30 cm, the signal will be continuous.

▲Warning

Under certain circumstances, various reflective surfaces on objects or clothing as well as external noise sources may cause the system to fail to detect obstacles. For this reason, care must be taken when reversing even if the parking distance sensor is operational. This is of particular importance when in the vicinity of pedestrians.

To deactivate

The system deactivates automatically when reverse gear is disengaged.

To deactivate the system when reverse gear is engaged, press button **P**▲. The LED in the button goes out.

To reactivate, press button **P**▲ again.



17204 1

Control indicator P▲

Illuminated

Fault in the system. The system is not ready for operation. Have the fault remedied. We recommend that you consult your Vauxhall Authorised Repairer. The system's integrated self-diagnostics allows faults to be quickly remedied.

If it flashes

The fault is due to sensors obstructed with snow or ice. The sensors must be undamaged and free of dirt, snow and ice.

Interference due to external sources of ultra sound (e.g. pneumatic drills, rotary machines). Once the source of interference is removed, the system will operate normally.

Caravan/trailer towing equipment ✳, caravan/trailer towing

The system automatically detects if a towbar is properly fitted to the vehicle.

When towing, the parking distance sensor is automatically deactivated when the trailer cable is plugged into the socket.

Fitting rear load racks ✳

Rear load racks, e.g. bicycle racks, fitted near the sensors could disrupt the system.

Observe the note on the Astra TwinTop on page 151.



17205 1

Automatic level control ✳

Automatic level control makes it possible to keep the height of the vehicle constant when subjected to different loads in the rear (e.g. when towing a caravan or trailer). This significantly improves driving conditions.

The vehicle is automatically raised at the rear, increasing the spring travel and ground clearance.

The automatic level control system is activated after approx. 2 miles (3 km), depending on the vehicle loading and the nature of the road surface.

Headlight range adjustment – page 138.

In the event of malfunctions, do not utilise the vehicle's full load capacity. Have the cause remedied without delay. We recommend that you consult your Vauxhall Authorised Repairer.



17018 1

Deflation Detection System (DDS = Deflation Detection System) *

The deflation detection system continuously monitors the speed of all wheels while driving. If a tyre loses pressure, it grows smaller and rotates more quickly than the other wheels. If the system detects a difference in speed, control indicator (U) illuminates red.

Stop immediately and check tyre pressure. Mount the spare wheel if necessary – pages 254, 257.

The system is operational when the ignition is switched on and can detect pressure loss from a speed of 20 mph (30 km/h).

Control indicator (U)

If control indicator (U) illuminates red while driving, there is a loss of pressure. Stop immediately and check tyre pressures. A maximum speed of 50 mph (80 km/h) is permitted for run-flat tyres *. Observe the information on page 235.

If control indicator (U) illuminates yellow, there is a fault in the system. Have the cause of the fault remedied. We recommend that you consult your Vauxhall Authorised Repairer. The system's integrated self-diagnostics allows faults to be quickly remedied.

The control indicator flashes three times when the system is initialising.

Warning

The deflation detection system does not replace manual checks with a suitable gauge.

Check tyre pressures at least every 14 days and prior to any long journey; the tyres should be checked when cold. Don't forget to check the spare *.

Tyre pressure – pages 232, 333.



17019 1

System initialisation

After correcting tyre pressure or changing a tyre/wheel, the system must be initialised: With the ignition switched on, press the DDS button for approx. 4 seconds. Control indicator (U) flashes 3 times. The system is operational after driving a certain distance.

Only initialise the system if all tyres have the prescribed pressure.

Tyre pressure monitoring system *

The tyre pressure monitoring system continually checks the pressure and speed of all four wheels while driving.

A pressure sensor is integrated in each wheel. Once a minute, the pressure of each tyre is sent to a control unit, where it is compared. If the system detects one or more pressure differences, a message appears on the information display.

In vehicles with graphical information display * or colour information display * and trip computer *, current tyre pressures can be shown in the information display.

For the system to be operational, all wheels must be equipped with pressure sensors and all tyres must be filled to the prescribed pressure. The tyre pressure monitoring system automatically detects if the vehicle is being driven with a load of up to 3 persons or a full load.

Once the ignition is switched on, the system is operational and will continuously monitor the tyre pressures at speeds of approx. 20 mph (30 km/h) and above.

Warning

The tyre pressure monitoring system does not replace manual checks with a suitable gauge.

Check tyre pressures at least every 14 days and prior to any long journey; the tyres should be checked when cold. Don't forget to check the spare *.

Tyre pressure – see pages 232, 333.

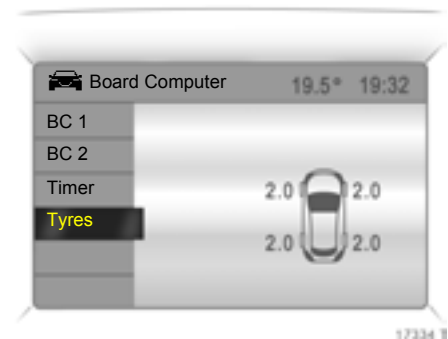

Display of current tyre pressure *

Select menu item **Tyres** from the **Board Computer** menu.

The current pressure of each tyre is displayed.

Warning messages

A message is given on the information display to warn of inconsistent tyre pressures. In some versions, the message is displayed in abbreviated form.

For example, the following messages can be displayed:

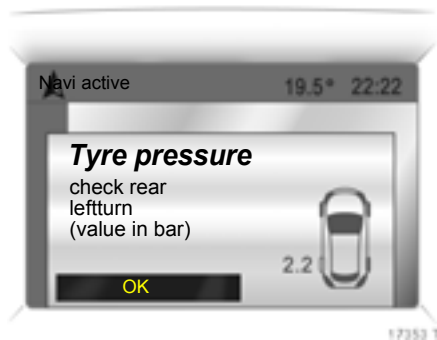

A graphic * indicating the left rear tyre is shown together with the current tyre pressure: Slight pressure deviation. Reduce speed. Check pressure at next opportunity with appropriate gauge and correct if necessary.

On the colour information display this report will appear in yellow.

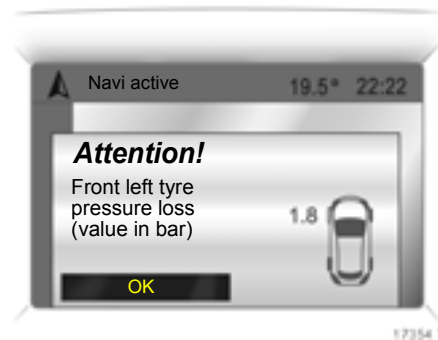

A graphic * indicating the front left tyre is shown together with the current tyre pressure: Significant pressure deviation or direct pressure loss! Steer out of flow of traffic as quickly as possible without endangering other drivers. Stop and check the tyres.

Mount the spare wheel if necessary - pages 254, 257. A maximum speed of 50 mph (80 km/h) is permitted for run-flat tyres *. Observe the information on page 235.

On the colour information display this report will appear in red.

Acknowledgement of warnings – page 54.



17018 T

Control indicator (⚠)

If control indicator (⚠) illuminates yellow while driving, there is a fault in the tyre pressure monitoring system. Fitting a wheel without pressure sensor (e.g. spare wheel) will also generate a fault in the system. Have the cause of the fault remedied. We recommend that you consult your Vauxhall Authorised Repairer. The system's integrated self-diagnostics allows faults to be quickly remedied.



17019 T

System initialisation

The system must be initialised after a wheel/tyre change:

With the ignition switched on, press button **DDS** approx. 4 seconds. Control indicator (⚠) flashes 3 times. The system is operational after driving a certain distance.

Only initialise the system if all tyres have the prescribed pressure (check when tyres are cold).

General information

The spare wheel/temporary spare is not equipped with a pressure sensor. The tyre pressure monitoring system is not operational if the spare wheel/temporary spare is in use. Control indicator (⚠) illuminates yellow –.– appears in the display of tyre pressures. Tyre pressure is monitored by the deflation detection system – page 221.

If a complete set of wheels without tyre pressure control system sensors is mounted (e.g. four winter tyres), no error message will be displayed. The tyre pressure monitoring system is not operational. The tyre pressure of a set of wheels without sensors is monitored by the deflation detection system – page 221.

Sensors for the tyre pressure monitoring system can be retrofitted. We recommend that you consult your Vauxhall Authorised Repairer.

When manually checking tyre pressure with a pressure gauge, screw the adapter onto the valve. Tyre pressure – page 333.

The tyre pressure monitoring system valve cores and sealing rings must be replaced each time the tyres are changed. We recommend that you consult your Vauxhall Authorised Repairer.

The use of commercially available liquid filled run-flat systems or repair kits can impair the function of the system. Vauxhall-approved systems can be used.

Radio transmitters (e.g. radio headphones, walkie-talkies) operated in the area could cause interference in the tyre pressure monitoring system.

Brakes

| | |
|-----------------------------------|-----|
| Brake system..... | 226 |
| Anti-lock brake system (ABS)..... | 228 |

Brake system

The brakes are an important factor for traffic safety.

To improve effectiveness, do not brake unnecessarily hard for the first 125 miles (200 km) after new brake pads have been fitted.

Brake pad wear must not exceed a specified limit. Regular maintenance as detailed in the Service Booklet is therefore of the utmost importance for traffic safety.

Have worn brake pads replaced. We recommend that you consult your Vauxhall Authorised Repairer, who will fit pads that have been tested and approved by Vauxhall and guarantee optimum braking power.

Brake pads worn to their minimum thickness generate a grinding noise. Continued driving is possible. Have the brake pads replaced as soon as possible by a workshop. We recommend your Vauxhall Authorised Repairer.



Brake assist

If the brake pedal is operated with a powerful push, the vehicle is automatically braked at full braking power in order to achieve the shortest possible braking distance when full-on braking occurs (braking assistant).

Maintain steady pressure on the brake pedal for as long as full-on braking is to continue. When the brake pedal is released, the maximum brake force amplification is taken away.

Adaptive brake light ✱

During full-on braking, all three brake lights flash for the duration of ABS control.

Foot brake

The foot brake comprises two independent brake circuits.

If a brake circuit fails, the vehicle can still be braked using the other brake circuit. If this occurs, however, the brake pedal must be depressed quite far using considerable force before braking effect occurs. The distance required for braking will be greater. Consult a workshop before continuing your journey. We recommend your Vauxhall Authorised Repairer.

To ensure the full pedal travel can be utilized, especially in case of a fault in one of the brake circuits, there must be no mats in the vicinity of the pedals – page 201.

When the engine is not running, the support of the brake servo unit disappears once the brake pedal has been depressed once or twice. Braking effect is not reduced, but braking requires significantly greater force. This is especially important to bear in mind when towing.

Check the brake lights before starting out on a journey. On vehicles with check control ✱ the brake lights are checked automatically – page 62.

Shortly after starting each journey the effectiveness of the brake system should be tested at low speed and without inconveniencing other traffic, especially if the brakes are wet, e.g. after the vehicle has been washed.

The brake fluid level should be checked regularly. If the brake fluid level is too low and the hand brake is not applied, control indicator (D) on the instrument panel illuminates – page 38.

Hill Start Assist ✱ (HSA)

The system helps pull away on inclines. After releasing the footbrake, if the hand brake is not applied the brakes are only released after 2 seconds. As soon as the acceleration is sufficient to prevent rolling back, the brake is released.

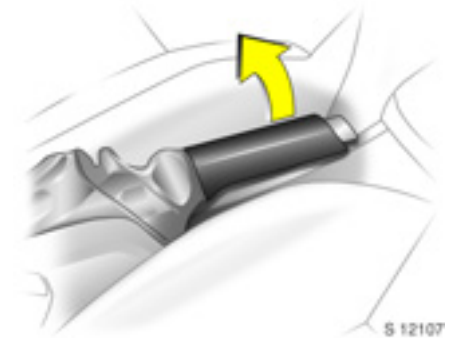
**Hand brake**

Always apply hand brake firmly. On slopes apply the hand brake as firmly as possible.

The mechanical hand brake acts on the brakes on the rear wheels. It engages automatically when applied.

To release the hand brake pull the lever up slightly, press the ratchet knob, and fully lower the lever.

To reduce the operating forces of the hand brake, depress the foot brake at the same time.



Brake system control indicator (ⓘ)

The control indicator illuminates when the ignition is switched on if the hand brake is applied or if the brake or clutch fluid level is too low. Brake fluid - page 302.

For vehicles with Easytronic ✱, the control indicator flashes for a few seconds when the ignition is turned off if the hand brake is not applied.

⚠ Warning

If the control indicator illuminates when the hand brake is not applied: Stop. Interrupt your journey immediately. Consult a workshop. We recommend your Vauxhall Authorised Repairer.

Anti-lock brake system (ABS (ABS))

ABS continually monitors the brake system and prevents the wheels from locking regardless of the type of road surface or tyre grip.

It starts to regulate the braking pressure as soon as a wheel shows a tendency to lock. The vehicle remains steerable, even in the event of very heavy braking, for instance on bends or when swerving to avoid an obstacle. Even in the case of full-on braking, the ABS makes it possible to drive round an obstacle without releasing the brakes.

ABS control is made apparent though a pulse in the brake pedal and the noise of the regulation process.

⚠ Warning

For optimum braking, keep the brake pedal fully depressed throughout the braking process, despite the fact that the pedal is pulsating. Do not reduce the pressure on the pedal.

Do not let this special safety feature tempt you into taking risks when driving.

Traffic safety can only be achieved by adopting a responsible driving style.



17209 II

Control indicator for ABS

It comes on for a few seconds after the ignition is turned on. The system is ready for operation when the control indicator goes out.

If the control indicator does not go out after a few seconds, or if it illuminates while driving, there is a fault in the ABS. The brake system remains operational without ABS regulation.

Self-check

Each time the ignition is turned on and the engine started, after moving away from a speed of around (2 mph) 3 km/h the system performs a self-check which may be audible.

Fault

Warning

If there is a fault in ABS, the wheels may be subject to locking due to braking that is heavier than normal. The advantages of ABS are no longer operational. The vehicle can no longer be steered and may swerve.

You can continue driving, provided you drive with care and anticipation.

Have the cause of the fault remedied. We recommend that you consult your Vauxhall Authorised Repairer. The system's integrated self-diagnostics allows faults to be quickly remedied.

Wheels, tyres

| | |
|---------------------------------------|-----|
| Tyres | 230 |
| Changing tyre/wheel type..... | 230 |
| Tyre pressure..... | 232 |
| Tyre condition, wheel condition | 233 |
| Run-flat tyres (RFT) *..... | 235 |
| Winter tyres *..... | 236 |
| Wheel covers *..... | 236 |
| Tyre chains..... | 236 |

Tyres

See page 333 for suitable tyres and restrictions.

Tyres fitted in the factory are adapted to the chassis and provide optimum driving comfort and safety.

Changing tyre/wheel type

Before switching to different tyres or wheels, seek advice on the technical possibilities. We recommend that you consult your Vauxhall Authorised Repairer, who will be able to advise you of any necessary modifications.

If tyres of a different size than those fitted at the factory are used, the electronic speedometer may require reprogramming to ensure that the correct speed is displayed.

Warning

Use of unsuitable tyres or wheels may lead to accidents and render the vehicle unroadworthy.

Vehicles with tyre pressure monitoring system *

If winter tyres or tyres of a different size are fitted, tyre pressure monitoring system sensors can be retrofitted if so desired. Otherwise, the system will not indicate tyre pressure deviations. We recommend that you consult your Vauxhall Authorised Repairer.

Deflation detection system * – page 221,
tyre pressure monitoring system *
– page 222.

Vehicles with run-flat tyres *

When switching wheels, e.g. when switching to winter tyres, use run-flat tyres as there is no spare wheel or tyre repair kit in the vehicle.

Run-flat tyres * - page 235.

Fitting new tyres

Fit tyres in pairs or in sets, which is even better. Ensure that tyres on one axle are

- the same size
- the same design
- the same make
- and have the same tread pattern.

Fit directional tyres such that they roll in the direction of travel. The rolling direction is indicated by a symbol (e.g. an arrow) on the sidewall.

Tyres fitted opposing the rolling direction (e.g. when a tyre is changed) should be refitted as soon as possible. This is the only way to obtain full benefit from the design properties of the tyre.

Run-flat tyres * must not be combined with conventional tyres.

 **Warning**

We recommend that you have your tyres changed by your Vauxhall Authorised Repairer, who will be familiar with the requirements of the law as regards disposal of tyres and can thus help to protect the environment and your health.

Some brands of tyres have a beaded edge for alloy wheels to protect against damage. If wheel trim is used on steel wheels with beaded-edge tyres, the following specification must be followed:

- Use of wheel trims and tyres that approved by Vauxhall for the vehicle in question and thereby fulfil all requirements for the wheel and tyre combination.
- If the wheel trims and tyres used are not Vauxhall-approved, the tyres must not have a beaded edge.

 **Warning**

Use of unsuitable tyres or wheel trims could lead to sudden loss of air and thereby accidents.

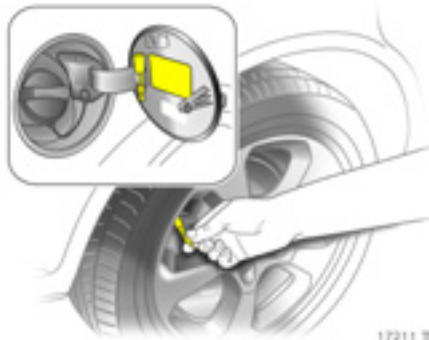

Tyre pressure

Check tyre pressure, including the spare wheel, at least every 14 days and prior to any long journey; the tyres should be checked when cold. Don't forget to check the spare ✱.

Use the valve cap key to make unscrewing the valve caps easier. The key is located on the inside of the tank flap.

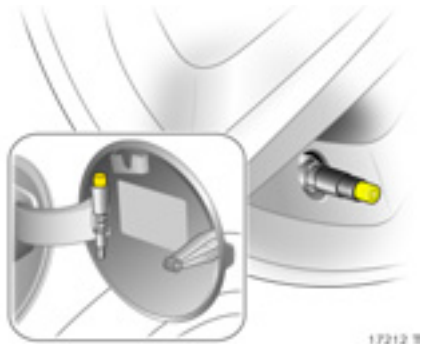

In vehicles with tyre pressure monitoring system ✱ there is an adapter in the valve cap key. Screw adapter to valve before attaching tyre pressure gauge – page 222.

Tyre pressure – page 333 and the adhesive foil ✱ on the inside of the tank flap. Have adhesive foil replaced after changing to different tyre size.

Do not reduce tyre pressure when the tyres are warm. Otherwise the pressure may drop below the permissible minimum when the tyres cool down.

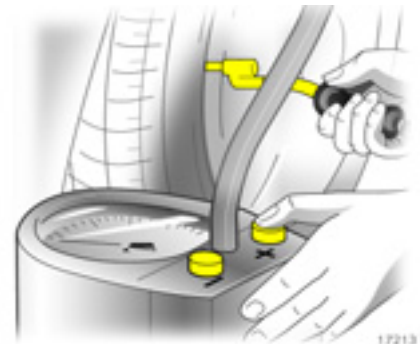

After having checked the tyre pressure, tighten the valve caps using the valve cap key.

Incorrect inflation pressures will impair safety, vehicle handling, comfort and fuel economy and will increase tyre wear.

If the pressure is too low, this can result in considerable tyre warm-up and internal damage, leading to tread separation and even to tyre blow-out at high speeds.

Hidden tyre damage is not eliminated by adjusting the inflation pressure.

⚠ Warning

Incorrect tyre pressure could lead to a flat tyre.

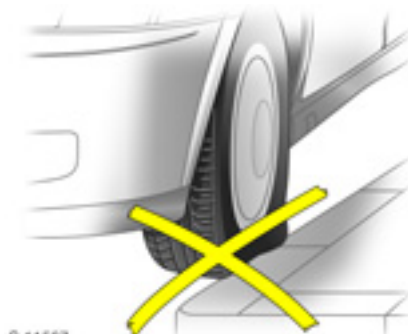

S 11567

Tyre condition, wheel condition

Drive over edges slowly and at a right angle if possible. Driving over sharp edges can lead to hidden tyre damage and wheel damage which is only noticed later on.

When parking, ensure that the tyres are not pressed against the edge of the kerb.

Check tyres regularly for damage (foreign bodies, punctures, cuts, cracks, bulges in sidewalls). Check wheels for damage. In the event of damage or abnormal wear, consult a workshop. We recommend your Vauxhall Authorised Repairer.

⚠ Warning

Damage may lead to tyre blow-out.

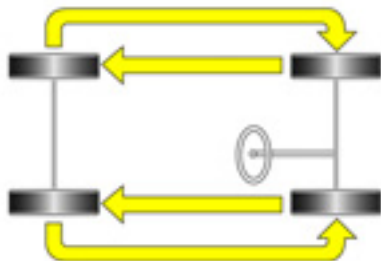

S 11568

Tread depth

Check tread depth regularly.

If wear in the front is greater than that in the rear, move the rear wheels to the front axle and vice versa.

Correct tyre pressure. For vehicles with deflation detection system * or tyre pressure control system *, initialise the system – pages 221, 224.

For reasons of safety, tyres should be replaced when their tread depth has worn down to 2 to 3 mm (winter tyres: 4 mm).



The legally permissible minimum tread depth (1.6 mm) has been reached when the tread has worn down as far as one of the wear indicators (TWI¹⁾). A number of wear indicators are spaced at equal intervals around the tyre within the tread. Their position is indicated by markings on the tyre sidewall.

General information

- The danger of aquaplaning is greater if the tyres are worn.
- Tyres age, even if they are used only very little or not at all. A spare wheel which has not been used for six years should be used only in emergencies; drive slowly when using such tyres.
- Never fit used tyres the previous history and use of which you do not know.
- So as not to impair brake cooling, use only wheel trims approved for use on your vehicle.

1) **TWI** = **T**read **W**ear **I**ndicator.

Tyre designations

Meanings:

e.g. **195/65 R 15 91 H****195** = Tyre width in mm**65** = cross-section ratio
(tyre height to tyre width) in %**R** = belt type: **R** radial**RF** = type: RunFlat**15** = rim diameter in inch**91** = load index

z. B.: 91 corresponds to 618 kg

H = speed code

Speed code letters:

Q Up to 100 mph (160 km/h)**S** Up to 112 mph (180 km/h)**T** Up to 118 mph (190 km/h)**H** Up to 130 mph (210 km/h)**V** Up to 150 mph (240 km/h)**W** Up to 168 mph (270 km/h)**Run-flat tyres
(RFT) ***

Run-flat tyres have reinforced, self-supporting sidewalls, which ensure that the tyres always have a certain amount of driveability, even when there is no pressure.

Run-flat tyres are only permitted on vehicles with ESP ^{Plus} and tyre pressure monitoring system or deflation detection system.**Warning**

Even the tyre pressure of run-flat tyres must be checked regularly.

Check tyre pressures at least every 14 days and prior to any long journey; the tyres should be checked when cold.

Depending on tyre manufacturer, run-flat tyres can be identified from a marking on the tyre wall. E.g. **ROF** = RunonFlat for Goodyear or **SSR** = Self Supporting Runflat Tyre for Continental.

Run-flat tyres may only be used in combination with Vauxhall-approved alloy wheels; this also applies to winter tyres.

Driving with a damaged tyre

A loss in tyre pressure is indicated by the tyre pressure monitoring system * or the deflation detection system *.

If a tyre has no pressure, continued driving is possible

- at a speed of max. 50 mph (80 km/h),
- up to a distance of 50 miles (80 km).

Warning

When driving with a flat tyre, do not exceed a speed of 50 mph (80 km/h) or a distance of 50 miles (80 km).

The vehicle will be more difficult to steer and handle and the braking distance will be longer.

Adapt driving style and speed to the conditions at hand.

Do not use a tyre repair kit.

Deflation detection system * – page 221,
tyre pressure monitoring system *
– page 222.

Winter tyres *

For notes on fitting new tyres – page 230.

Limitations - pages 235, 333.

Winter tyres improve safety at temperatures below 7 °C and should therefore be fitted on all the wheels.

The design of summer tyres means they have limited qualities for winter driving.

If the maximum permissible speed for the winter tyres is less than that of the vehicle, a notice indicating the maximum permissible speed for the tyres must be affixed within the driver's field of vision¹⁾.

If you use the spare wheel when it is fitted with a summer tyre, the vehicle's driveability may be affected, especially on slippery road surfaces. Obtain a replacement for the faulty tyre as soon as possible, and have the wheel balanced and fitted to the vehicle.

Wheel covers *

If the wheel trims and tyres used are not Vauxhall-approved, make sure that the tyres do not have a beaded edge – see page 231.



17217 E

Tyre chains

Limitations and further information – page 333.

Tyre chains are only permitted on the drive wheels (front axle). They must be fitted to the tyres symmetrically in order to achieve a concentric fit.

Always use fine mesh chains that add no more than 10 mm to the tyre tread and the inboard sides (including chain lock).

We recommend that you consult your Vauxhall Authorised Repairer.

¹⁾ Varies from country to country on account of national regulations.

Wheel trim on steel wheels could come into contact with parts of the chain and be damaged. Remove the wheel trim – see page 257.

Tyre chains may only be used at speeds up to 50 km/h and, when travelling on roads that are free of snow, they may be used for brief periods only since they are subject to rapid wear on a hard road and may snap.

Temporary spare wheel

Tyre chains must not be used on the temporary spare wheel. If you need to use tyre chains after suffering a flat front tyre, fit the temporary spare on the rear axle and transfer one of the rear wheels to the front axle.

For notes on the temporary spare wheel – see page 255.

Wheel changing – see page 257.

Correct tyre pressure. Deflation detection system * – see page 221, tyre pressure control system * – see page 222.

Roof racks, Caravan and trailer towing

| | |
|--|-----|
| Roof racks *..... | 238 |
| Towing equipment *..... | 239 |
| Towing equipment with detachable coupling ball bar *..... | 239 |
| Stowage of coupling ball bar | 242 |
| Caravan and trailer loads..... | 243 |
| Coupling socket load..... | 244 |
| Rear axle load during towing | 244 |
| Tyre pressure..... | 244 |
| Trailer Stability Assist * (TSA) | 244 |
| Driving characteristics, towing tips | 245 |
| Starting on inclines | 246 |

Warning

Disregard of these notes can lead to injuries which may be fatal. Vehicle passengers should be informed accordingly.

Roof racks *

For reasons of safety and to avoid damaging the roof, we recommend that you use the Vauxhall roof rack system approved for your vehicle. Consult your Vauxhall Authorised Repairer.

Roof loads are not permitted on the Astra TwinTop.

Fasten the roof rack following the instructions that accompany the system.

Driving hints – see page 200.

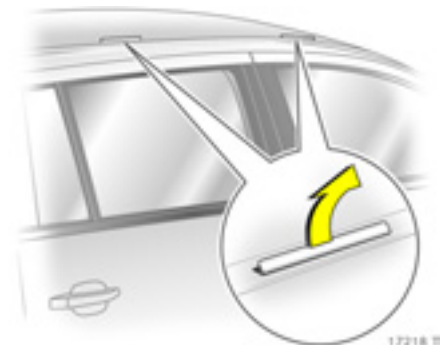

Version without roof railing

Lift the covers from the fitting openings.

Attach roof rack at appropriate points, see enclosed roof luggage rack system instructions.

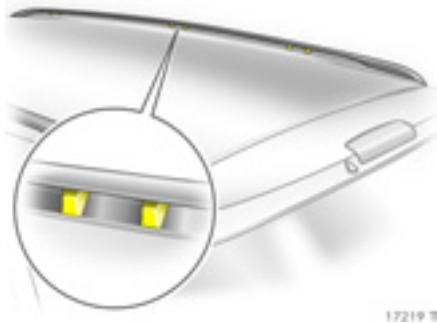

Version with roof railing ❄

Attach roof rack to roof railing at points shown in figure, see enclosed roof luggage rack system instructions.

Towing equipment ❄

Use only towing equipment that has been approved for your vehicle. We recommend entrusting the retrofitting of towing equipment to your Vauxhall Authorised Repairer, who will advise you on any possible towed load increases. Your Vauxhall Authorised Repairer has instructions on how to install the towing equipment and make any necessary changes to the vehicle that affect the cooling system, heat shields or other equipment.

Observe the note on the Astra TwinTop on page 151.

Do not mount towing equipment to vehicles with Z 20 LEH¹⁾ engine.

⚠ Warning

The coupling ball bar is to be removed when not towing.

For installation dimensions of the trailer towing equipment – pages 345, 346.

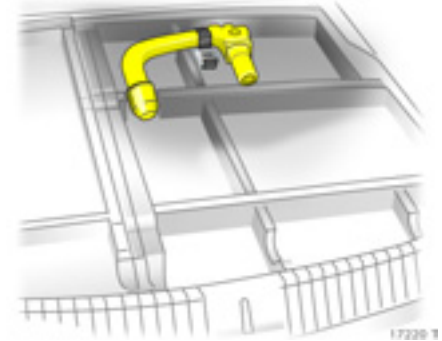

Towing equipment with detachable coupling ball bar ❄

Stowage of coupling ball bar

In Saloons, the coupling ball bar is in a pouch, fastened in the luggage compartment cargo box with a strap - page 242.

In Estates, the coupling ball bar is fastened with a strap in a compartment in the spare wheel well of the luggage compartment.



¹⁾ Sales designation – see page 314.

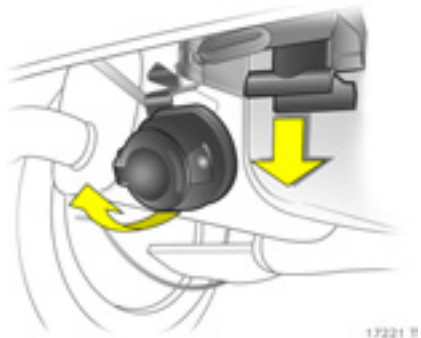

Fitting the coupling ball bar

Disengage and fold down the socket. Remove the sealing plug from the hole for the coupling ball bar and stow it in the luggage compartment.

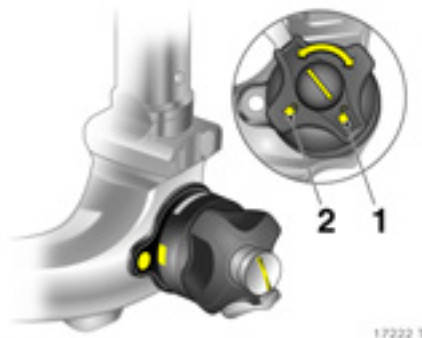

Checking the tensioning of the coupling ball bar

- Red marking on turn knob points towards white marking on coupling ball bar.
- Gap of approx. 6 millimetres between rotary knob and coupling ball bar.
- Key is in lock at position 1.

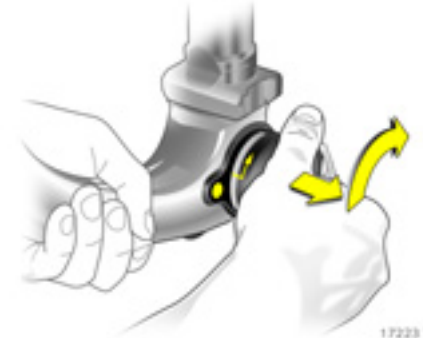

Otherwise, the coupling ball bar must be tensioned before it is inserted into the coupling housing:

- Unlock coupling ball bar (key to position 1) – see Fig. 17222 T.
- Pull turn knob out and then turn it clockwise as far as it will go – see Fig. 17223 T.

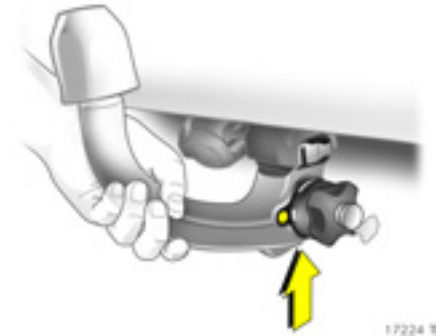

Inserting the coupling ball bar

Insert the tensioned coupling ball bar into the coupling housing and push firmly upwards until the coupling ball bar audibly engages in position.

The turn knob snaps back into its home position resting against the coupling ball bar.

⚠ Warning

Do not touch the turn knob when inserting the coupling ball bar - risk of injury.

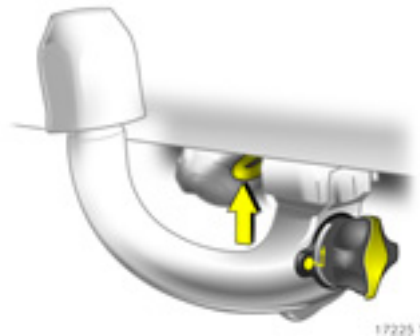

Lock coupling ball bar (key to position 2 – page 240, Fig. 17222 T). Remove key and press protective flap into position.

When the coupling ball bar is locked the turn knob can no longer be pulled out.

Important

Check that the coupling ball bar is correctly installed:

- Green marking on turn knob points towards white marking on coupling ball bar.
- No gap between turn knob and coupling ball bar.
- Coupling ball bar must be seated firmly in coupling housing.
- Coupling ball bar must be locked and key must be removed.

⚠ Warning

Towing a caravan/trailer is only permitted with a properly attached coupling ball bar. If the coupling ball bar cannot be properly attached, consult a workshop. We recommend your Vauxhall Authorised Repairer.

Eye for break-away stopping cable

In the case of caravans/trailers with brake, attach the break-away stopping cable to the eye (arrow in Fig. 17225 T).

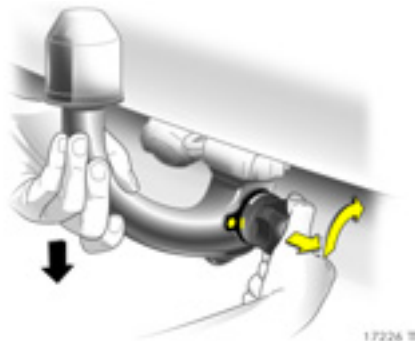

Dismounting the coupling ball bar

Unlock coupling ball bar (key to position 1 – page 240, Fig. 17222 T).

Pull out turn knob and then turn it clockwise as far as it will go. Pull coupling ball bar down out of the coupling housing and stow in compartment in the luggage compartment – page 239.

Insert the sealing plug in the hole for the coupling ball bar. Fold away the socket – page 240, Fig. 17221 T.

Do not use steam-jet cleaners or other high-pressure cleaners to clean the coupling ball bar.

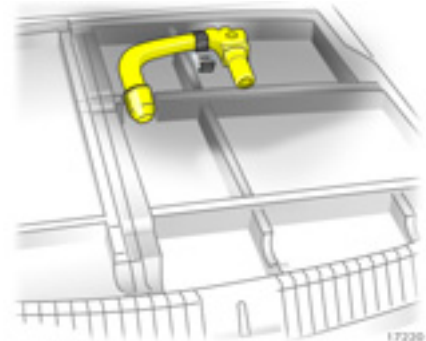

Stowage of coupling ball bar

Hatch

Stow the coupling ball bar in the pouch and fasten it in the luggage compartment cargo box with the strap.

Estate

Stow the coupling ball bar in the compartment in the spare wheel well of the luggage compartment, fastening it with the strap.

Caravan and trailer loads¹⁾

The permissible caravan/trailer loads are vehicle- and engine-dependent maximum values which must not be exceeded. The actual caravan/trailer load is the difference between the actual gross weight of the caravan/trailer and the actual coupling socket load with the caravan/trailer coupled. When the caravan/trailer load is being checked, therefore, only the caravan/trailer wheels – and not the jockey wheel – must be standing on the weighing apparatus.

The permissible caravan/trailer loads for your vehicle are given in the vehicle documents. Unless otherwise stated, they are valid for gradients up to max. 12 %.

The permissible caravan/trailer load should be fully utilised only by drivers who are adequately experienced in towing large or heavy caravans/trailers.

The permitted caravan/trailer load applies up to the specified incline and up to an altitude of 1000 metres above sea level. Since engine power decreases as altitude increases because of the air becoming thinner, therefore reducing climbing ability, the permitted towing weight also decreases by 10 % for every 1000 metres of additional altitude. The towing weight does not have to be reduced when driving on roads with slight inclines (less than 8 %, e. g. motorways).

The actual caravan/trailer load plus the actual gross weight of the towing vehicle must not exceed the maximum permitted towing weight. For example, if the permitted gross vehicle weight is utilised, the trailer/caravan load must only be used until the maximum permitted towing weight is reached. The maximum permitted towing weight is shown on the identification plate – page 312.

¹⁾ Observe national regulations.

Coupling socket load

The coupling socket load is the load exerted by the caravan/trailer on the coupling ball. It can be varied by changing the weight distribution when loading the caravan/trailer.

The maximum permissible coupling socket load (75 kg) is specified on the towing equipment identification plate and in the vehicle documents. Always aim for the maximum load, especially in the case of heavy caravans/trailers. The coupling socket load should never fall below 25 kg.

When measuring the coupling socket load, make sure that the drawbar of the loaded caravan/trailer is at the same height as it will be when the caravan/trailer is coupled with the towing vehicle loaded. Particularly important for caravans/trailers with tandem axle.

Rear axle load during towing

With a trailer coupled and the towing vehicle fully loaded (including all occupants), the permissible rear axle load (see identification plate or vehicle documents) may be exceeded by 65 kg and the permissible gross vehicle weight by 45 kg for the Hatch. For the Estate, the permissible rear axle load may be exceeded by 60 kg and the permissible gross vehicle weight by 30 kg. If the permissible rear axle load is exceeded a maximum speed of 60 mph (100 km/h) applies 50 mph (80 km/h) if approved for use as a commercial vehicle). If national regulations specify a lower maximum speed for vehicles towing a trailer, this must be observed.

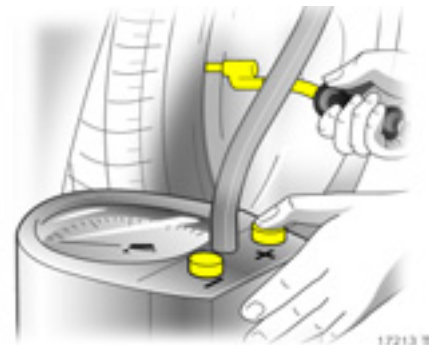

Tyre pressure

Increase the tyre pressure on the towing vehicle to the value specified for a full load – page 333. Check the pressure of the spare wheel and caravan/trailer wheels.

Trailer Stability Assist * (TSA)

TSA monitors vehicle movements when towing a caravan or trailer. If the system detects lurching movements, engine power is reduced and the vehicle/trailer combination is selectively braked until the lurching ceases.

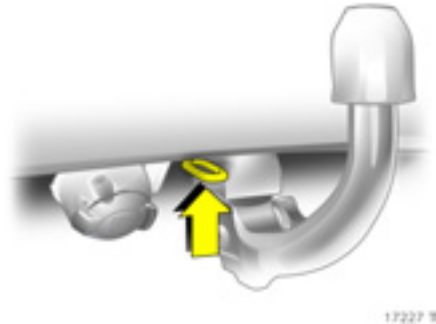

Driving characteristics, towing tips

In the case of caravans/trailers with brakes, attach breakaway stopping cable to eye.

Before attaching the trailer/caravan, lubricate the ball of the trailer/caravan towing device. However, do not lubricate the ball if a stabiliser, which acts on the coupling ball, is being used to damp hunting.

Check caravan/trailer lighting before starting to drive. The fog tail lights on the vehicle are deactivated when towing a caravan or trailer.

Trailers with LED turn signals must have a provision enables light monitoring for commercial bulbs.

Turn signal control indicator - page 40.

Parking distance sensor * is deactivated when towing.

Handling is greatly influenced by the loading of the trailer/caravan. Loads should therefore be secured so that they cannot slip and be placed in the centre of the trailer/caravan if possible, i.e. above the axle.

In the case of trailers with low driving stability or caravans with a permitted gross vehicle weight of over 1300 kg (Hatch) / 1200 kg (Estate), do not exceed a speed of 50 mph (80 km/h); the use of a friction-type stabiliser is highly recommended.

Do not drive faster than 50 mph (80 km/h) if possible, even in countries where higher speeds are permitted.

Make sure that you have enough room when cornering and avoid sudden manoeuvres.

If the trailer/caravan starts to sway, drive more slowly, do not attempt to correct the steering and brake sharply if necessary.

If it is necessary to apply the brakes fully, depress the brake pedal as hard as possible.

Remember that the braking distance for vehicles towing caravans/trailers with and without brake is always greater than that for vehicles not towing a caravan/trailer.



When driving downhill, the brakes are under considerably more load when towing a caravan/trailer. For this reason, drive in the same gear as if driving uphill and drive at a similar speed.

Automatic transmission * or Easytronic * in automatic mode will automatically select the driving programme with the optimum engine braking effect.

Gear position **3**, **2** or **1** can also be manually selected if required.

The cooling fan is electrically operated. Its cooling power is therefore independent of the engine speed.

Since a considerable amount of heat is generated at high engine speeds and less at slower speeds, do not shift down when climbing hills whilst the vehicle is still coping with the gradient in the higher gear.



17228 8

Starting on inclines

For vehicles with manual transmission, the most favourable engine speed when starting off on an incline is between 2500 and 3000 rpm for petrol engines and between 2000 and 2200 rpm for diesel engines. Hold engine speed constant, engage clutch gradually (let slip), release hand brake and open throttle. If possible, the engine speed should not drop during this procedure.

For vehicles with automatic transmission * or Easytronic * in automatic mode, apply full throttle.

Before starting off under extreme conditions (high combination weight, mountainous terrain with steep inclines), switch off all unnecessary electrical loads (e.g. heated rear window, air conditioning system *, heated front seats *).

Self-help

| | |
|---|-----|
| Starting the engine with jump leads * | 248 |
| Towing the vehicle..... | 249 |
| Towing service | 250 |
| Towing another vehicle..... | 251 |
| Warning triangle ▲* | 252 |
| First-aid kit (cushion) ⊕* | 252 |
| Spare wheel placed in luggage compartment..... | 254 |
| Jack 🛠️* and vehicle tools*..... | 256 |
| Changing wheels | 257 |
| Tyre repair kit*..... | 261 |
| Electrical system | 264 |
| Fuses and the most important circuits they protect | 266 |
| Bulb replacement | 274 |
| Halogen headlight system..... | 274 |
| Xenon headlight system*, Adaptive Forward Lighting system*..... | 278 |
| Front indicator lights..... | 281 |
| Fog lights*..... | 281 |
| Tail lights..... | 282 |
| Number plate light | 291 |
| Courtesy lights | 292 |

⚠️ Warning

Disregard of these notes can lead to injuries which may be fatal. Vehicle passengers should be informed accordingly.

Diesel fuel system, bleeding

Never let the tank run dry! If control indicator 🛢️ illuminates, refuel as soon as possible. Refuel immediately if it flashes.

It is possible to restart the engine if the tank has been run dry. A delayed start is to be expected. Switch on the ignition three times for approx. 15 seconds. Then attempt to start the engine for approx. 40 seconds¹⁾. If the engine does not start, wait at least 5 minutes and try again. If the engine does not start, consult a workshop. We recommend your Vauxhall Authorised Repairer.

¹⁾ For engine Z 17 DTH: For technical reasons, only possible for 30 seconds. Sales designation - see page 315.

Starting

Do not start with quick charger

This prevents damage to electronic components.

Do not start by pushing or towing

Because your vehicle is fitted with a catalytic converter, it must not be started by pushing or towing – page 207.

Vehicle with the Open&Start system * must not be started by pushing or towing if the battery is discharged, since the steering column lock cannot be released.

The vehicle can only be started using jump leads – see following page.

Starting the engine with jump leads *

A vehicle with a discharged battery can be started using jump leads and the battery of another vehicle.

Warning

Be extremely careful when starting with jump leads. Any deviation from the following instructions can lead to injuries or damage caused by battery explosion or damage to the electrical systems of both vehicles.

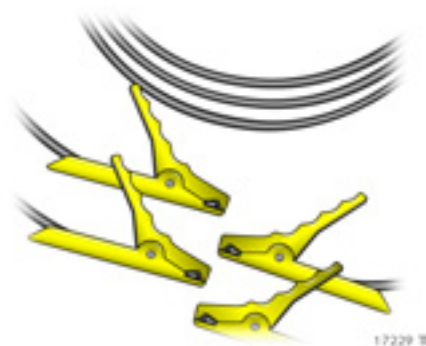

- Never expose the battery to naked flames or sparks.
- A discharged battery can freeze at temperatures of 0 °C. Defrost the frozen battery in a warm room before connecting jump leads.
- Do not allow battery fluid to come into contact with eyes, skin, fabrics or painted surfaces. The fluid contains sulphuric acid which can cause injuries and damage in the event of direct contact.
- Wear eye protection and protective clothing when handling a battery.
- Use auxiliary battery with same voltage (12 volts). Its capacity (Ah) must not be considerably less than that of the discharged battery. Voltage and capacity information can be found on the batteries.
- Use jump leads with insulated terminals and a cross section of at least 16 mm² (25 mm² for diesel engines).
- Do not disconnect the discharged battery from the vehicle.
- Switch off all unnecessary electrical consumers.
- Do not lean over the battery during jump starting.
- Do not allow the terminals of one lead to touch those of the other lead.
- Do not touch the vehicles while jump starting.
- Apply hand brake. Manual transmission or Easytronic * in neutral, automatic transmission * in P.

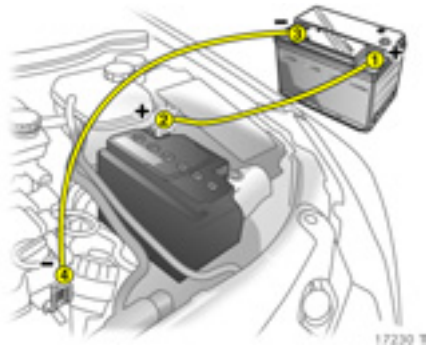

Connect the leads in the order shown in the illustration:

1. Connect one end of the first jump lead to the positive terminal **1** of the battery providing the jump start (identified by "+" sign on battery case or terminal).
2. Connect the other end of this lead to the positive terminal **2** of the discharged battery ("+" sign).
3. Connect the first end of the other jump lead to the negative terminal **3** of the battery providing the start ("-" sign).
4. Connect the other end of the second jump lead **4** to ground on the other vehicle, e.g. engine block or screw connection in the engine suspension.

- Do not connect leads to negative terminal of discharged battery!
- The connection point should be as far away from the discharged battery as possible.
- Route the leads so that they cannot catch on rotating parts in the engine compartment.
- Start the engine of the vehicle providing the jump start.
- After 5 minutes, start the other engine. Start attempts should be made at intervals of 1 minute not last longer than 15 seconds.
- After starting, allow both engines to idle for approx. 3 minutes with the leads connected.
- In order to avoid excess voltage in the electrical system, before removing a lead, switch on an electrical consumer (e.g. light, heated rear window) in the vehicle receiving the jump start.
- Reverse above sequence exactly when removing leads.

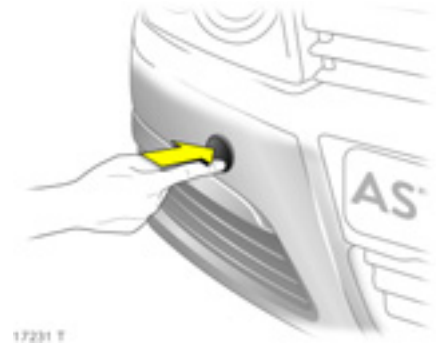

Towing the vehicle

To open the cover concealing the towing eye socket at the front right of the vehicle: disengage the cover at the bottom and pull it off downwards.

For versions with tyre repair set ✱, the towing eye is in the stowage compartment in the boot below the loading floor cover – page 261.

For versions with spare wheel ✱, the towing eye is in the stowage compartment for the jack ✱ and tool kit ✱ below the spare wheel – page 256.





17232 F

Screw in the towing eye anticlockwise as far as it will go until it stops in a horizontal position.

Attach a tow rope * – or better still a tow rod * – to the eye.

The towing eye must only be used for towing and not recovering a vehicle.

Switch on ignition to release steering column lock and to permit operation of brake lights, horn and windscreen wiper.

Vehicles with the Open&Start system * must not be towed when the battery is discharged because the steering column lock cannot be released. Towing is only possible with the ignition switched on. Use jump leads to start the engine if necessary.

Manual transmission or Easytronic * in neutral, automatic transmission * in **N**.

Drive slowly. Do not drive jerkily. Excessive tractive force can damage the vehicle.

Warning

For braking and steering, significantly higher forces are required: brake assistance and steering assistance are effective only with the engine running.

To prevent the entry of exhaust fumes from the towing vehicle, switch on the air recirculation * and close the windows.

Vehicles with automatic transmission * should be towed facing forward only and must not be towed faster than 50 mph (80 km/h) or further than 60 miles (100 km). If the transmission is defective, or if the above speed or distance is to be exceeded, the front axle must be raised off the ground.

Consult a workshop. We recommend your Vauxhall Authorised Repairer, who will serve you best to get your vehicle back on the road.

If the automatic clutch has been manually released in vehicles with Easytronic * because of an interruption to the power supply, towing is not permitted – see page 185. In this case, consult a workshop as soon as possible. We recommend your Vauxhall Authorised Repairer.

After towing, unscrew the towing eye clockwise and refit the cover.

Towing service

Entrust your vehicle only to the towing service of your choice and obtain an estimate on towing costs before employing any towing service. In this way you avoid unnecessary costs and possible insurance problems during claim processing.

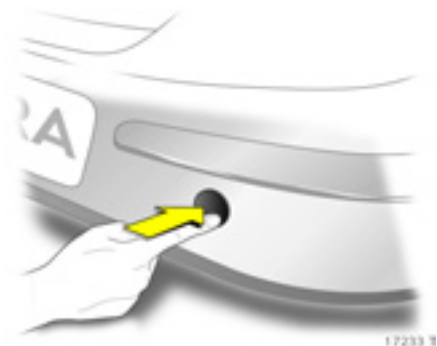

Towing another vehicle

To open the cover concealing the towing eye socket at the rear right of the vehicle: disengage the cover at the bottom and pull it off downwards.

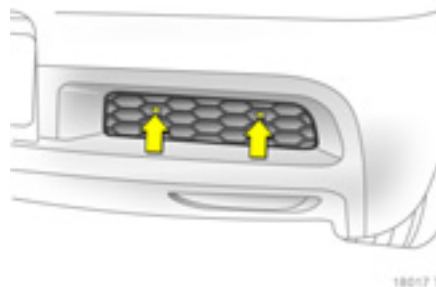

On some versions ✱: remove the cover concealing the towing eye at the rear right of the vehicle by disengaging the tabs at the bottom and pulling off the cover from the top.

For versions with tyre repair set ✱, the towing eye is in the stowage compartment in the boot below the loading floor cover – page 261.

For versions with spare wheel ✱, the towing eye is in the stowage compartment for the jack ✱ and tool kit ✱ below the spare wheel – page 256.



Screw in the towing eye anticlockwise as far as it will go until it stops in a horizontal position.

Attach a tow rope ✱ – or better still a tow rod ✱ – to the eye.

The towing eye must only be used for towing and not recovering a vehicle.

Drive slowly. Do not drive jerkily. Excessive tractive force can damage the vehicle.

After towing, unscrew the towing eye clockwise and refit the cover.

Version with cover ✱: install by inserting the bottom lugs of the cover ✱ in the bumper, folding and then press the lugs at the top into place.

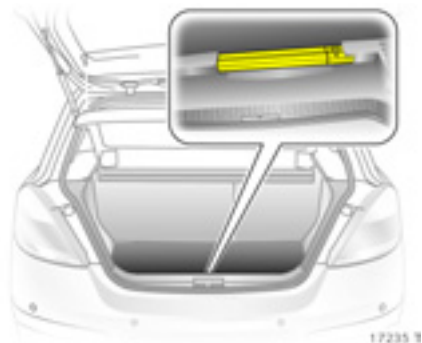

Warning triangle ▲*

Hatch, Astra TwinTop

Store warning triangle in rear luggage compartment wall: first fit warning triangle into recess on left and the insert in guide on right.

To remove the warning triangle, lift to the right and pull out to the right.

For vehicles with cargo box * : Lift the warning triangle with the right half of the cargo box. Pull out the warning triangle to the right.



Estate, Van

Insert the warning triangle in the retaining straps of the tailgate inner panelling.

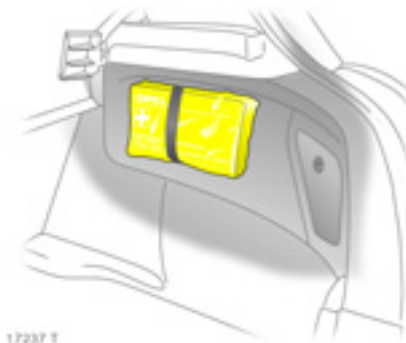

First-aid kit (cushion) ⊕*

Hatch

Secure the first-aid kit to the right luggage compartment wall using the retaining strap.

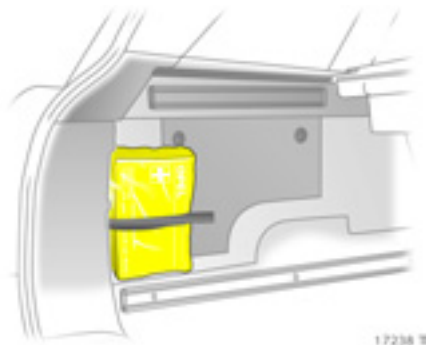
**Estate**

Fasten the first-aid kit (cushion) to the left luggage compartment wall with a retaining strap.

**Van**

Place first aid kit in stowage compartment behind driver's seat. To open the cover, press the locking tab.

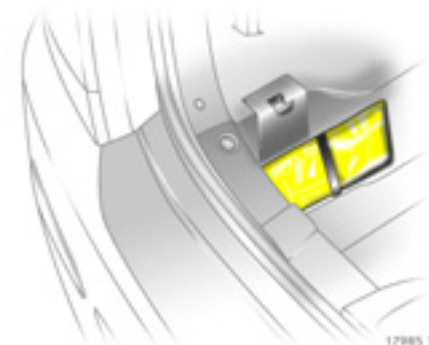
**Astra TwinTop**

Store the first-aid kit (cushion) in the recess behind the strap in the left luggage compartment wall.

Spare wheel ✳

Some vehicles are equipped with a tyre repair kit instead of a spare wheel

– page 261.

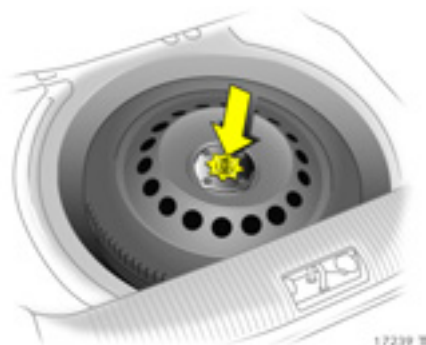

Spare wheel placed in luggage compartment

The spare wheel is located in the luggage compartment below the floor cover and is fastened with a nut. On Estates, there is also a spacer over the retaining nut.

Stowing wheels with wide tyres in the spare wheel well

The spare wheel well is not designed for all permitted tyre sizes. If a wheel wider than the spare must be stowed in the spare wheel well after changing wheels, the floor cover can be placed on the projecting wheel.

This must be observed when loading the luggage compartment, especially for the Astra TwinTop.



Estate

Take adapter * and hooks * from the rails * in the luggage compartment walls. Raise the rear lashing eyes and lift the floor cover to the vertical position so that it rests on the roof lining.

When closing, guide the lashing eyes through the slots in the floor cover.

Vehicles with cargo box *: Removal – page 103.

Astra TwinTop

Accessing the spare wheel when the roof is open: Engage luggage compartment cover on the rear window frame and activate the loading aid (see page 104). Raise the floor cover in the luggage compartment.

General information

Depending on version, the spare wheel may be in the form of a temporary spare wheel *. Refer to the notes on this page and pages 237, 260, 333.

On vehicles with alloy wheels * the spare wheel may have a steel rim.

If you use winter tyres *, the spare wheel may still be fitted with a summer tyre. If you use the spare wheel the vehicle's handling may be altered. Obtain a replacement for the faulty tyre as soon as possible, and have the wheel balanced and fitted to the vehicle.

The spare wheel may have a smaller tyre and a smaller rim than the wheels mounted on the vehicle ¹⁾: Using the spare wheel may alter vehicle handling. Have the defective tyre replaced as soon as possible, balance the wheel and have it mounted on the vehicle.

¹⁾ Country-specific version: The spare wheel is only to be used as a temporary spare wheel.

Notes on temporary spare wheel *

- Using a temporary spare wheel may change the driving behaviour of the vehicle, particularly if using winter tyres *. Replace defective tyre as quickly as possible, balance wheel and fit to vehicle.
- Fit only one temporary spare wheel.
- Do not drive faster than 50 mph (80 km/h).
- Take curves slowly.
- Do not use the temporary spare wheel for a lengthy period.
- Replace temporary spare wheel with full specification wheel without delay.
- Tyre chains are not permitted on the temporary spare wheel. If tyre chains are necessary after a front wheel puncture, fit the temporary spare wheel to the rear and a rear wheel to the front. Check tyre pressure and adjust if necessary – page 334.
- Follow temporary spare wheel instructions on pages 237, 260, 333.

Notes on directional tyres *

Directional tyres only provide maximum performance when they are mounted in the correct direction of rotation. If the tyres or spare wheel must be mounted opposing the specified direction of rotation (e.g. after changing a flat tyre), observe the following:

- Vehicle handling may change. Have the defective tyre replaced as soon as possible, and have the wheel balanced and mounted on the vehicle.
- Do not drive faster than 50 mph (80 km/h).
- Be especially careful when driving in rain and snow.

Further information on directional tyres – page 230.

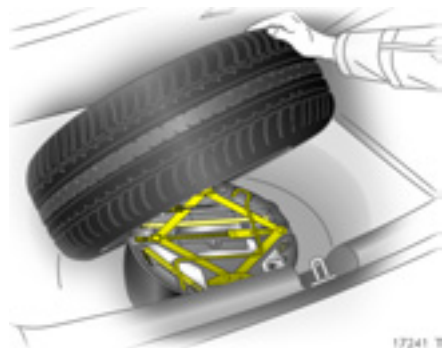
**Jack  and vehicle tools ***

The jack and the vehicle tools have been specially developed for your vehicle and must only be used on that vehicle. Only use jack for changing wheels.

Vehicles with spare wheel *

The jack and tool kit are in a stowage compartment in the boot below the spare wheel. Remove spare wheel, – page 254.

Vehicles with tyre repair set *

The tool kit and tyre repair set are in a storage compartment below the floor cover in the luggage compartment.

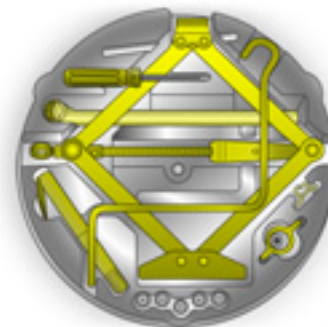

After use, stow away the jack and tools in the compartment as shown in illustration.

Astra TwinTop: The tools for emergency operation of the convertible hardtop are stowed in the glove compartment.

Changing wheels

There may be a tyre repair kit instead of a spare wheel – page 261.

To ensure your safety, make the following preparations and observe the following information when changing wheels:

- Park the vehicle on a level, firm and non-skid surface.
- Switch on hazard warning lights, apply hand brake, automatic transmission * - selector lever in P, manual transmission or Easytronic *
- engage 1st or reverse gear.
- Correctly set up the warning triangle *.
Warning triangle – page 252.
- Remove spare wheel from luggage compartment, see previous page 254.
- Before raising the vehicle, set the front wheels to the straight-ahead position.
- On the Astra TwinTop, the roof must be closed before the vehicle is raised.
- Never change more than one wheel at once.
- Block the wheel diagonally opposite the wheel to be changed by placing wedge blocks or equivalent in front and behind the wheel.
- Use the jack * only to change wheels.
- If the ground on which the vehicle is standing is soft, a solid board (max. 1 cm thick) should be placed under the jack *. Using a thicker board could damage the jack * and the vehicle.
- No people or animals may be in the vehicle when it is jacked up.
- Never crawl under a jacked-up vehicle.
- Do not start or run the engine while the vehicle is on the jack.
- Apply a light coating of grease to the cone of each wheel bolt before screwing in the wheel bolts after a wheel change. Some normal commercial grease will be required for this purpose. We recommend your Vauxhall Authorised Repairer.



1. Prise off the wheel trim using the hook included with the vehicle tools *. For vehicle tools, – page 256.

On wheel trims with visible wheel bolts *: The trim can remain on the wheel. Do not remove the retaining washers * on the wheel bolts.



Alloy wheels *: Disengage the wheel bolt caps with a screwdriver and remove. Protect the wheel by inserting a soft cloth between the screwdriver and ally wheel.

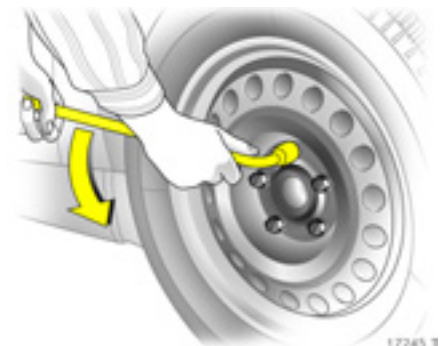

2. Turn wheel bolts half a turn using the wheel bolt wrench *, pushing the wrench * on as far as possible.



17246 T

3. The location of each jacking point * is indicated by a mark on the bottom edge of the vehicle.

For vehicles with side skirt trims *, the jack * may not be used as it may damage the vehicle.

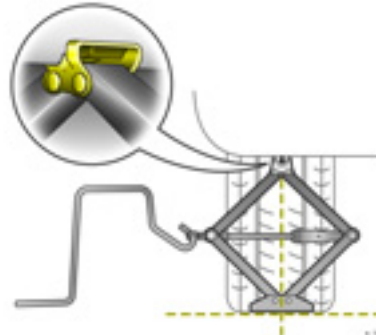

17247 T

4. Before positioning the jack *, set it to the necessary height by rotating the eye by hand. Position the jack * at the front or rear so that the jack claw spans the vertical base and grips in the recess in the vertical base. Make sure it is properly positioned.

The jack base must be on the ground directly below the jacking point in a manner that prevents it from slipping.

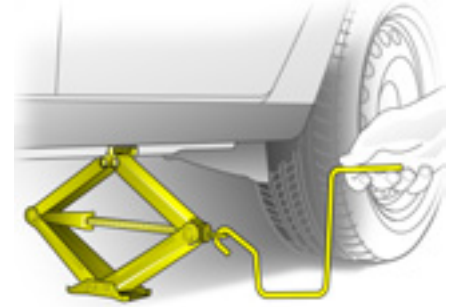

17248 T

Attach crank to eye of threaded rod and turn crank to raise vehicle.

If this is not the case, carefully lower the vehicle immediately and reposition the jack.

5. Unscrew wheel bolts and wipe clean with a cloth. Then apply a light coating of grease to the wheel bolts. Do not grease the thread of the bolts. Do not put the wheel bolts down in a location where they may become soiled.

If the wheel bolts have retaining washers *, they must not be removed.

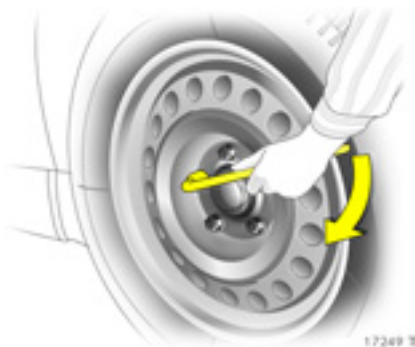

6. Change the wheel. Notes on spare wheel – page 254, notes on temporary spare wheel – page 255.
7. Screw in wheel bolts and tighten slightly, inserting the wheel bolt wrench * as far as possible.
8. Lower vehicle.
9. Tighten wheel bolts crosswise, putting on wheel bolt wrench * as far as possible.

10. Before refitting the wheel trim, clean the wheel around the retaining clips. Valve symbol * on back of wheel trim must point towards valve on wheel.

Align and refit wheel trim or wheel bolt caps *.

Alloy wheels *: Align and refit wheel bolt caps *.

11. Stow replaced wheel, tools and warning triangle * in luggage compartment, see pages 252 to 256.

12. Check the tyre pressure of the newly fitted wheel. Adjust as necessary.

13. Have the tightening torque of the wheel bolts on the new wheel checked on the vehicle using a torque wrench as soon as possible and, if necessary, corrected. Tightening torque – page 333.

14. Replace the faulty tyre on the wheel that was removed.

15. Replace temporary spare wheel * with a full specification wheel without delay.

16. Initialise the deflation detection system * or tyre pressure monitoring system * – pages 221, 224.

Tyre repair kit *

Minor damage to the tyre tread or side wall, e.g. from foreign bodies, can be repaired using the tyre repair kit (does not apply to run-flat tyres).

Do not remove the foreign body from the tyre.

Tyre damage exceeding 4 mm or that is on the rim cannot be repaired with the tyre repair kit.

Warning

Driving with inadequate tyre pressure or a flat tyre can lead to hidden tyre damage, which cannot be eliminated by using the tyre repair kit. Park the vehicle and consult a workshop. We recommend your Vauxhall Authorised Repairer.

Important information – page 264.

In the event of a flat tyre:

- Switch on hazard warning lights, apply hand brake, automatic transmission * - selector lever in **P**, manual transmission or Easytronic * - engage 1st or reverse gear.
- Correctly set up the warning triangle *, warning triangle – page 252.



The tyre repair kit is in a compartment under the floor cover luggage compartment.

1. Take the pouch with the tyre repair kit from the compartment. Carefully remove the components from the pouch.
2. Remove the compressor.

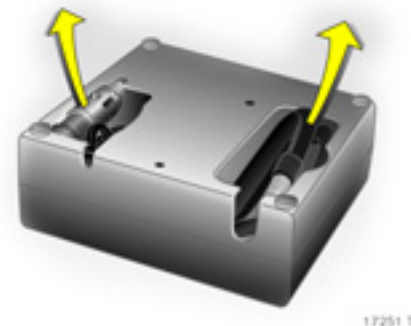

3. Remove the electrical connection cable and air hose from the stowage compartments on the underside of the compressor.



17252 8

4. Screw the compressor air hose to the connection on the sealant bottle.
5. Fit the sealant bottle in the retainer on the compressor.

Set the compressor near the tyre in such a way that the sealant bottle is upright.

6. Remove the valve cap from the defective tyre.

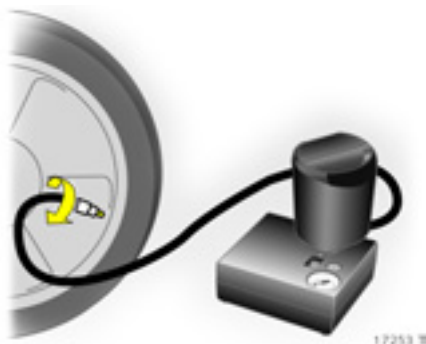

17253 8

7. Screw the filler hose to the tyre valve.
8. The switch on the compressor must be set to **O**.
9. Connect the compressor plug to the accessory socket or cigarette lighter socket. Accessory socket – page 107.
To avoid discharging the battery, we recommend running the engine.



17254 8

10. Set the rocker switch on the compressor to **I**. The tyre is filled with sealant.
11. While the sealant bottle drains (approx. 30 seconds) the pressure indicator on the compressor briefly points to 6 bar. Pressure then sinks again.
12. All of the sealant is pumped into the tyre. Afterwards, the tyre is filled with air.
13. The prescribed tyre pressure – page 333 should be reached within 10 minutes. Switch off the compressor when the correct pressure is obtained.

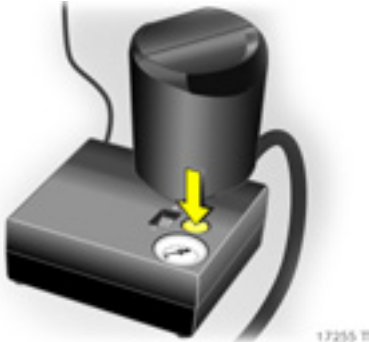

If the prescribed tyre pressure is not reached within 10 minutes, detach the tyre repair kit. Move the vehicle one tyre revolution (approx. 2 metres) in or against the flow of traffic. Reconnect the tyre repair kit and continue the filling procedure for 10 minutes. If the prescribed tyre pressure is still not reached, the tyre is too badly damaged. Park the vehicle and consult a workshop. We recommend your Vauxhall Authorised Repairer.

- Drain excess tyre pressure with the button over the pressure indicator.
- Do not run the compressor for more than 10 minutes - see "Important information" on page 264.
14. Detach the tyre repair kit. Screw the filler hose to the free connection on the sealant bottle. This prevents sealant leakage. Stow the tyre repair kit in the luggage compartment.
 15. Wipe away any sealant spill with a cloth.
 16. Disassemble the warning triangle * and store in luggage compartment – page 252.
 17. The enclosed sticker shows the maximum permitted speed at which the tyre repair may be used. Apply sticker in the driver's field of vision.
 18. Continue driving immediately to allow the sealant to distribute evenly throughout the tyre. Stop after approx. 6 miles / 10 km (no more than 10 minutes) and check tyre pressure. Screw the compressor air hose directly onto the tyre valve (see Fig. 17256 T).

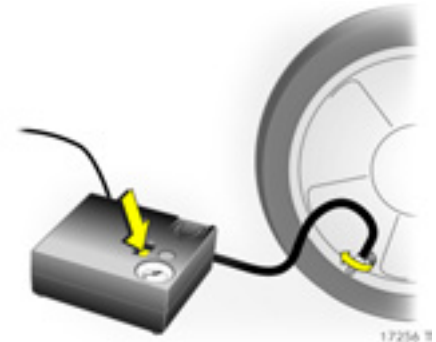

If tyre pressure is more than 1.3 bar, adjust to the prescribed value. Repeat the procedure until there is no more pressure loss.

If tyre pressure is below 1.3, the vehicle must not be driven. Consult a workshop. We recommend your Vauxhall Authorised Repairer.

19. Stow the tyre repair kit in the luggage compartment – page 261.

Important

⚠ Warning

Do not drive faster than 50 mph (80 km/h).

Do not use the temporary spare wheel for a lengthy period.

Steerability and driving behaviour may be impaired.

The driving comfort of the repaired tyre is severely affected, therefore have this tyre replaced.

If the compressor makes abnormal noises or heats up greatly, switch it off for at least 30 minutes.

The integrated safety valve opens at a pressure of 7 bar.

Protect the compressor from moisture and rain.

The sealant can only be stored for approx. 4 years. After this time, the sealing properties can no longer be guaranteed. Heed the expiration date on the sealant bottle.

The sealant bottle can only be used once. Replace a used sealant bottle.

The compressor and sealant can be used from approx. -30 °C.

Dispose of a used tyre repair kit in accordance with applicable legislation.

The adapters supplied * can be used to inflate other items e.g. footballs, air mattresses, inflatable dinghies etc.

They are located on the underside of the compressor. To remove, screw on compressor air hose and withdraw adapter.

When using the tyre repair set, no consumers may be connected to the front accessory socket.

Electrical system

⚠ Warning

Electronic ignition systems generate very high voltages. Do not touch the ignition system; high voltage can be fatal.

Fuses

The vehicle has two fuse boxes: one behind a cover on the left side of the luggage compartment and one in the front left of the engine compartment.

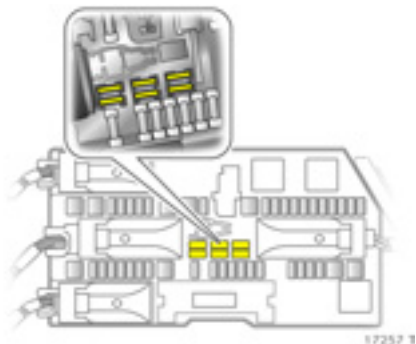

We recommend carrying a complete set of spare fuses –available from your Vauxhall Authorised Repairer. Store spare fuses in the fuse box in the luggage compartment. Open cover, see page 266.

Before replacing a fuse, turn off the respective switch and the ignition.

A blown fuse (see figures to the right) can be recognised by its melted wire. Do not install a new fuse until the cause of the fault has been remedied.

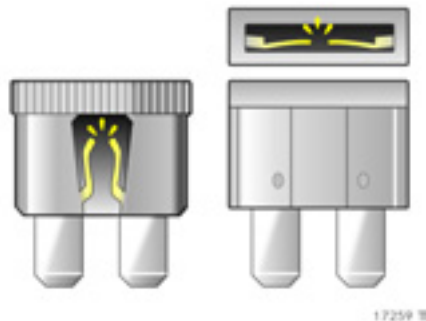

Different versions of fuses are used.

| Fuse colour | Fuse rating |
|-----------------|-------------|
| Brownish yellow | 5 A |
| Brown | 7.5 A |
| Red | 10 A |
| Blue | 15 A |
| Yellow | 20 A |
| Transparent | 25 A |
| Green | 30 A |



| Fuse colour | Fuse rating |
|-------------|-------------|
| Blue | 20 A |
| Transparent | 25 A |
| Pink | 30 A |
| Green | 40 A |

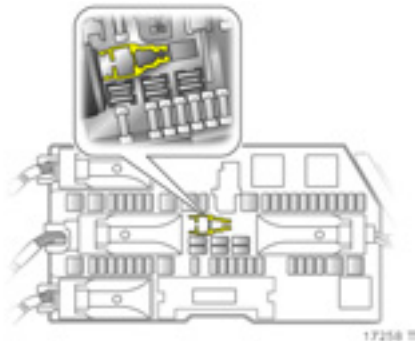

There is a fuse extractor in the luggage compartment fuse box to facilitate replacement of fuses - see figure above for an example.

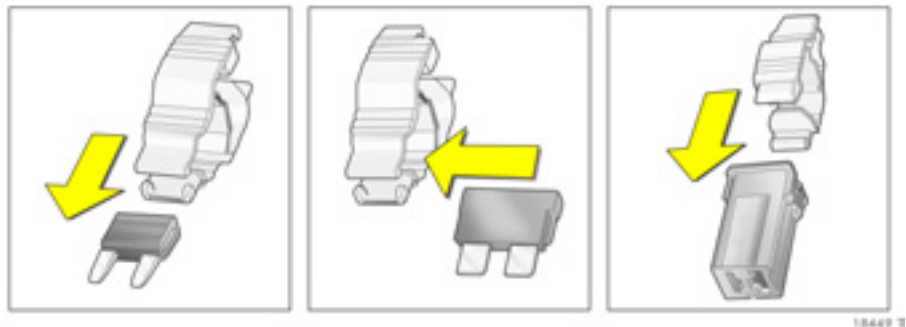

Place the fuse extractor on the various types of fuse from the top or side, and withdraw fuse.

Only fit fuses of the specified current rating. Each fuse has its current ratings written on it, in addition the ratings are colour coded.

Fuses and the most important circuits they protect

Fuse box in luggage compartment

Depending on the equipment version, there are two different fuse boxes for differing electrical circuits.

- Version A – see figure 18453 T,
- Version B – see figure 17958 T

Astra TwinTop always has version B.

Spare fuses, fuse extractor – page 264.

The fuse box is located on the left side of the luggage compartment behind a cover.

Do not store any objects behind the cover.

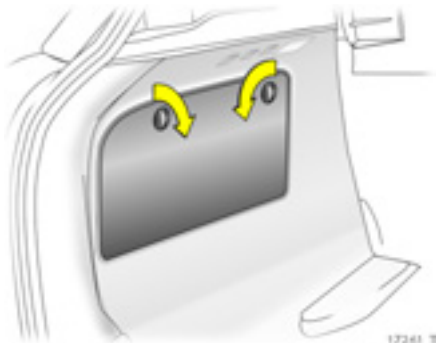

5-door saloon,
Estate, van

To open, turn both catches with a coin and fold cover down.

3-door hatch

To open, fold the cover upwards.

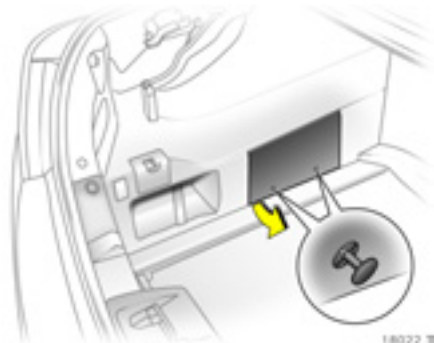

Astra TwinTop

To open, pull the two knobs, remove the clips and fold the cover upwards.

Fuse box, version A

Some functions are protected by several fuses. To replace a fuse, pull off its protective cap.

| No | Circuit | Rating |
|----|----------------------------|--------|
| 1 | Luggage compartment socket | 15 A |
| 2 | Rear socket | 15 A |
| 3 | Electric windows, front | 30 A |
| 4 | Electric windows, rear | 30 A |
| 5 | Reversing lights | 7.5 A |
| 6 | Air conditioning system | 10 A |
| 7 | Heated exterior mirrors | 7.5 A |

Fuse box, version B

Some functions are protected by several fuses.

| No | Circuit | Rating |
|----|--|--------|
| 1 | Electric windows, front | 25 A |
| 2 | – | – |
| 3 | Instruments | 7.5 A |
| 4 | Heating, air conditioning system, climate control system | 5 A |
| 5 | Airbags | 7.5 A |
| 6 | – | – |
| 7 | – | – |
| 8 | – | – |
| 9 | – | – |
| 10 | – | – |
| 11 | Heated rear window | 25 A |
| 12 | Tailgate wiper | 15 A |

| No | Circuit | Rating |
|----|---|--------|
| 13 | Parking distance sensor | 5 A |
| 14 | Heating, air conditioning system | 7.5 |
| 15 | – | – |
| 16 | Seat occupancy recognition, Open&Start system | 5 A |
| 17 | Rain sensor, air quality sensor, tyre pressure monitoring system, interior mirror | 5 A |
| 18 | Instruments, switches | 5 A |
| 19 | – | – |
| 20 | CDC | 10 A |
| 21 | heated exterior mirrors | 7.5 A |
| 22 | Sun roof | 20 A |
| 23 | Electric windows, rear | 25 A |

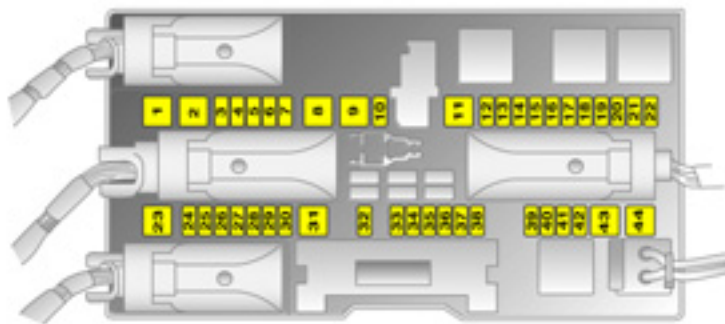

17958 1

| No | Circuit | Rating |
|----|---|--------|
| 24 | Diagnostics plug | 7.5 A |
| 25 | – | – |
| 26 | Electrically retractable exterior mirrors | 7.5 A |
| 27 | Ultrasonic sensor, Vauxhall alarm system | 5 A |
| 28 | – | – |
| 29 | Cigarette lighter, front socket | 15 A |
| 30 | Rear socket | 15 A |
| 31 | – | – |

| No | Circuit | Rating |
|----|-------------------|--------|
| 32 | – | – |
| 33 | Open&Start system | 15 A |
| 34 | Sun roof, TwinTop | 25 A |
| 35 | Rear socket | 15 A |
| 36 | Towing equipment | 20 A |
| 37 | – | – |

| No | Circuit | Rating |
|----|----------------------------------|--------|
| 38 | Central locking system, clamp 30 | 25 A |
| 39 | Seat heater (left) | 15 A |
| 40 | Seat heater (right) | 15 A |
| 41 | – | – |
| 42 | – | – |
| 43 | – | – |
| 44 | – | – |



Fuse box in engine compartment

The fuse box is at the front left side of the engine compartment.

Warning

Turn off engine before opening engine compartment fuse box; risk of injury – page 297.

To open the cover, release the catch by inserting a screwdriver into the opening as far as it will go and swivelling it to the side. Open the cover upwards and remove.

Depending on the equipment version, there are two different fuse layouts for the engine compartment fuse box, handling different electrical circuits:

- If the luggage compartment fuse box is version **A** - see Fig. 18453 T on page 267 - the fuse layout in the engine compartment is version **A** – see next column.
- If the luggage compartment fuse box is version **B** – see Fig. 17958 T on page 269 - the fuse layout in the engine compartment is version **B** – see next page.

Astra TwinTop always has version B.

Spare fuses, fuse extractor – page 264.

Fuse layout, version A

Some functions are protected by several fuses.

| No | Circuit | Rating |
|----|--|--------------|
| 1 | ABS | 20 A |
| 2 | ABS | 30 A |
| 3 | Interior fan climate control system | 30 A |
| 4 | Interior fan, heating, air conditioning system | 30 A |
| 5 | Radiator fan 1 ¹⁾ | 30 A 40 A |

¹⁾ Different ratings depending on engine and equipment level.

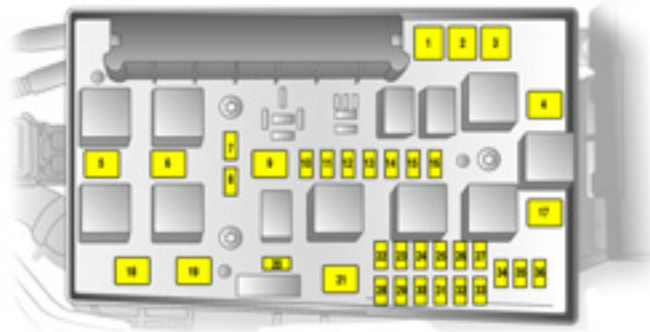

17264 T

| No | Circuit | Rating |
|----|--|----------------------|
| 6 | Radiator fan 2 ¹⁾ | 20 A 30 A 40 A |
| 7 | Central locking system | 20 A |
| 8 | Windscreen wash system, tailgate | 10 A |
| 9 | Heated rear window, heated exterior mirrors | 30 A |
| 10 | Diagnostics plug | 7.5 A |
| 11 | Instruments | 7.5 A |
| 12 | Mobile telephone, digital radio, Twin Audio, display | 7.5 A |
| 13 | Courtesy light | 5 A |

| No | Circuit | Rating |
|----|--|--------------|
| 14 | Windscreen wiper | 30 A |
| 15 | Windscreen wiper | 30 A |
| 16 | Horn, ABS, brake light switch, air conditioning system | 5 A |
| 17 | Diesel filter or air conditioning system | 25 A 20 A |
| 18 | Starter | 25 A |
| 19 | – | – |
| 20 | Horn | 15 A |

| No | Circuit | Rating |
|----|--|--------|
| 21 | Engine electronics | 20 A |
| 22 | Engine electronics | 7.5 A |
| 23 | Headlight range adjustment | 5 A |
| 24 | Fuel pump | 15 A |
| 25 | – | – |
| 26 | Engine electronics | 10 A |
| 27 | Heating, air conditioning system, air quality sensor | 7.5 A |
| 28 | – | – |
| 29 | Power steering | 5 A |
| 30 | Engine electronics | 10 A |
| 31 | Tailgate wiper | 15 A |
| 32 | Brake light switch | 5 A |
| 33 | Headlight range adjustment, light switch, clutch switch, instrument assembly, driver's door module | 5 A |
| 34 | Control unit Steering column module | 7.5 A |
| 35 | Infotainment system | 20 A |
| 36 | Cigarette lighter, front socket | 15 A |

¹⁾ Different ratings depending on engine and equipment level.

Fuse layout, version B

Some functions are protected by several fuses.

| No | Circuit | Rating |
|----|--|----------------------|
| 1 | ABS | 20 A |
| 2 | ABS | 30 A |
| 3 | Interior fan climate control system | 30 A |
| 4 | Interior fan, heating, air conditioning system | 30 A |
| 5 | Radiator fan 1 ¹⁾ | 30 A 40 A |
| 6 | Radiator fan 2 ¹⁾ | 20 A 30 A 40 A |

| No | Circuit | Rating |
|----|------------------------|--------|
| 7 | Windscreen wash system | 10 A |
| 8 | Horn | 15 A |
| 9 | Headlight wash system | 25 A |
| 10 | – | – |
| 11 | – | – |
| 12 | – | – |
| 13 | Fog lights | 15 A |
| 14 | Windscreen wiper | 30 A |
| 15 | Windscreen wiper | 30 A |

| No | Circuit | Rating |
|----|--|--------|
| 16 | Electronics control units, Open&Start system, ABS, brake light switch, TwinTop | 5 A |
| 17 | Diesel filter heating | 25 A |
| 18 | Starter | 25 A |
| 19 | Transmission electronics | 30 A |
| 20 | Air conditioning system | 10 A |
| 21 | Engine electronics | 20 A |
| 22 | Engine electronics | 7.5 A |
| 23 | Adaptive Forward Lighting, headlight range adjustment | 10 A |

¹⁾ Different ratings depending on engine and equipment level.

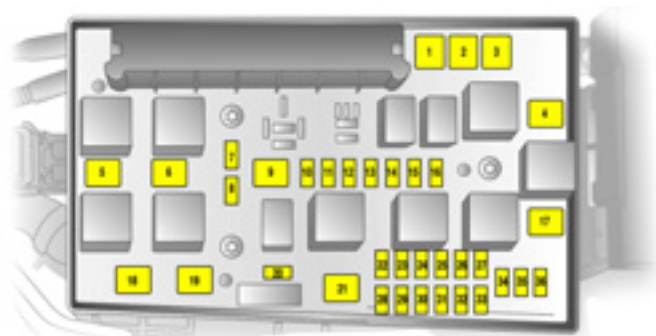

17264 T

| No | Circuit | Rating |
|----|--------------------------|--------|
| 24 | Fuel pump | 15 A |
| 25 | Transmission electronics | 15 A |
| 26 | Engine electronics | 10 A |
| 27 | Power steering | 5 A |
| 28 | Transmission electronics | 5 A |
| 29 | Transmission electronics | 7.5 A |
| 30 | Engine electronics | 10 A |

| No | Circuit | Rating |
|----|---|--------|
| 31 | Adaptive Forward Lighting, headlight range adjustment | 10 A |
| 32 | Brake system, air conditioning system, clutch switch | 5 A |
| 33 | Adaptive Forward Lighting, headlight range adjustment, light switch | 5 A |
| 34 | Control unit, steering column module | 7.5 A |
| 35 | Infotainment system | 20 A |
| 36 | Mobile telephone, digital radio, Twin Audio, display | 7.5 A |

Bulb replacement

Before replacing a bulb, switch ignition off and switch relevant switch off.

Only hold new bulb at base! Do not touch the bulb glass with bare hands, otherwise fingerprints on the glass evaporate. Residue builds up on the reflector eventually resulting in a dull reflector. Inadvertently stained bulbs may be cleaned with a clean non-fluffy cloth, using alcohol or white spirits.

The replacement bulb must be in accordance with the data on the base of the defective bulb. Do not exceed wattage given on bulb base.

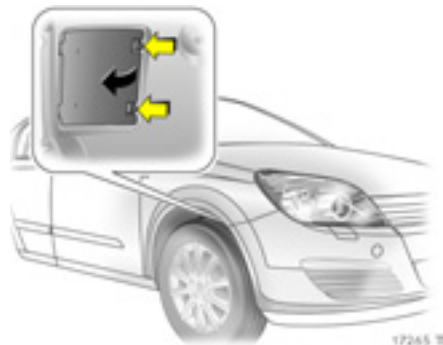

The bulbs of the front outer lights are replaced through openings in the front wheel arch: turn relevant wheels to gain access, release catch and remove cover.

Headlight aiming

We recommend that headlight aiming be carried out by your Vauxhall Authorised Repairer, who will have special equipment.

When adjusting headlights, headlight range adjustment must be set to 0.

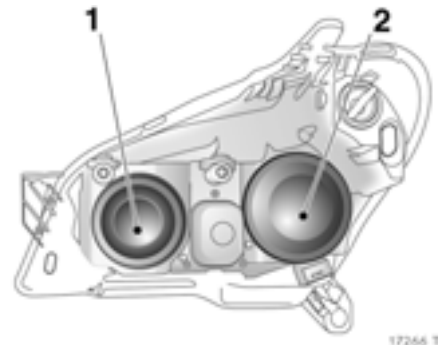

Halogen headlight system

Headlights with separate systems for main beam **1** (inner bulbs) and dipped beam **2** (outer bulbs).

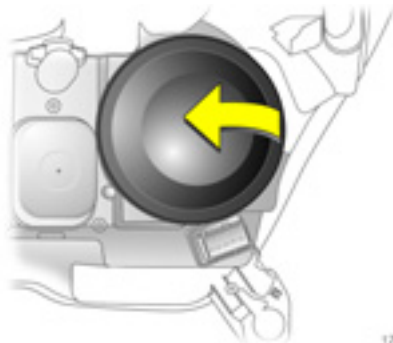

Dipped beam

1. Replace bulb through opening the front wheel arch: turn relevant wheel to gain access, release catch and remove cover – page 274.
2. Remove headlight protective cover.

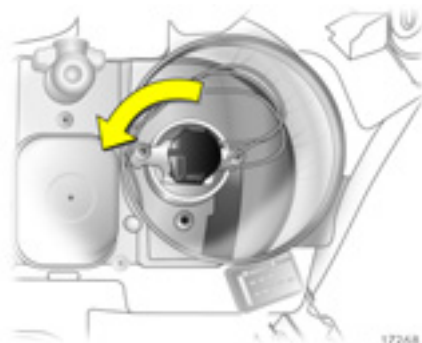

3. Rotate left bulb holder and disengage.

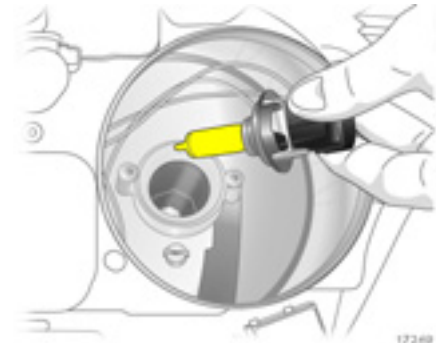

4. Remove the bulb holder with bulb from the reflector.

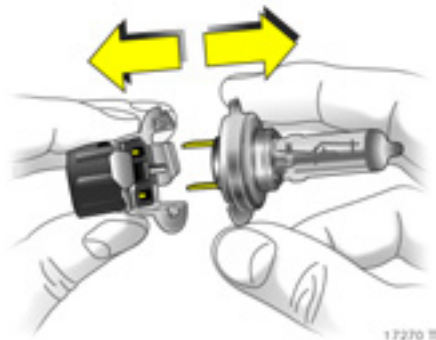

5. Detach bulb from bulb holder.
6. Insert new bulb into bulb holder, without touching the glass.
7. Insert new bulb so that the two lugs on the bulb holder engage in the recesses in the reflector.
8. Rotate bulb holder to right as far as it will go.
9. Place headlight protective cover in position and close.
10. Position cover on opening in wheel arch and engage.

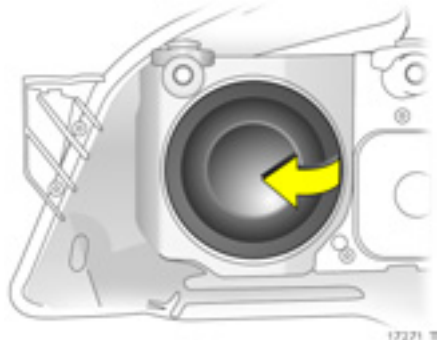

Main beam

1. Open bonnet and engage support.
2. Replace bulbs from engine compartment out.

To replace the bulb on the right-hand side, remove the air hose from the air filter.

To replace the bulb on the left-hand side, remove the plug from the fuse box.

3. Remove headlight protective cover.
4. Detach plug connector from bulb.

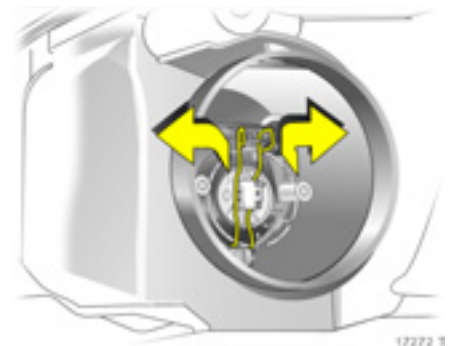

5. Disengage spring clip from retainer by pressing forward and then swing downward.
6. Remove bulb from reflector housing.
7. When fitting a new bulb, engage the lugs in the recesses on the reflector without touching the glass.

8. Engage spring wire clip, plug connector onto bulb.
9. Place headlight protective cover in position and close.

After bulb replacement on the right-hand side, reattach air hose to air filter and engage.

After bulb replacement on the left-hand side, reconnect the fuse box plug and engage.

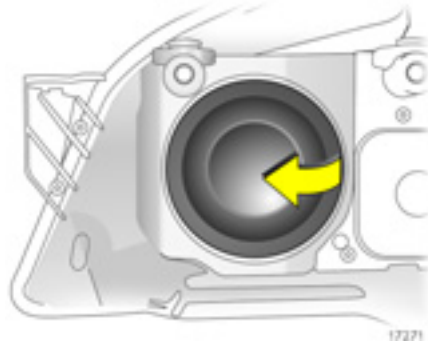

Parking lights

1. Open bonnet and engage support.
2. Replace bulbs from engine compartment out.

To replace the bulb on the right-hand side, remove the air hose from the air filter.

To replace the bulb on the left-hand side, remove the plug from the fuse box.
3. Remove main beam headlight protective cover.

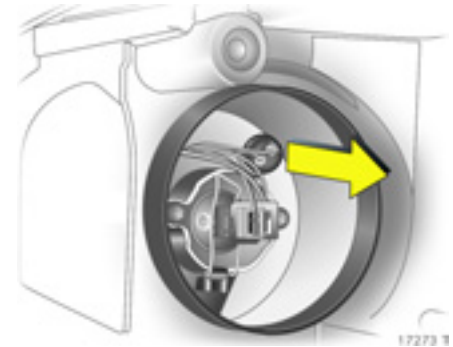

4. Remove parking light socket from reflector.



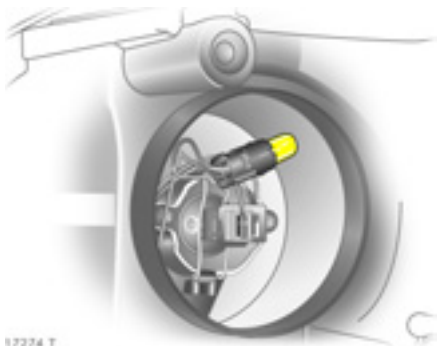

17274 T

5. Remove bulb from socket.
6. Insert new bulb, without touching the glass.
7. Insert holder in reflector. Place headlight protective cap in position and close.

After bulb replacement on the right-hand side, reattach air hose to air filter and engage.

After bulb replacement on the left-hand side, reconnect the fuse box plug and engage.

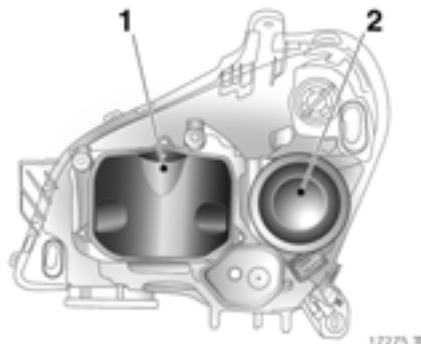

17275 T

Xenon headlight system *, Adaptive Forward Lighting system *

Headlights with separate systems for dipped beam 1 (inner bulbs) and main beam 2 (outer bulbs).

Dipped beam

Warning

The dipped beam operates at very high voltage. Do not touch; high voltage can be fatal. Have bulbs changed by a workshop. We recommend your Vauxhall Authorised Repairer.

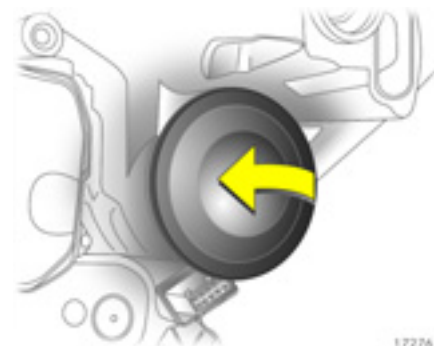

17276 T

Main beam

1. Replace bulb through opening the front wheel arch: turn relevant wheel to gain access, release catch and remove cover – page 274.
2. Remove headlight protective cover.



3. Rotate left bulb holder and disengage.

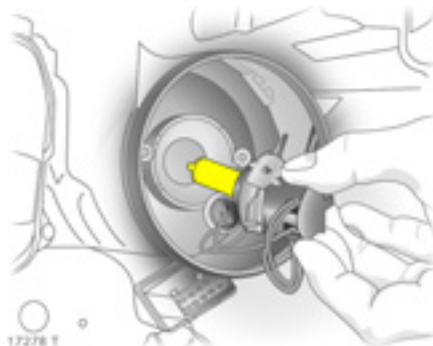

4. Remove the bulb holder with bulb from the reflector.

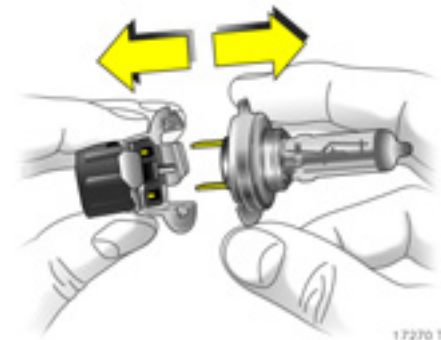

5. Detach bulb from bulb holder.
6. Insert new bulb into bulb holder, without touching the glass.
7. Insert new bulb so that the two lugs on the bulb holder engage in the recesses in the reflector.
8. Rotate bulb holder to right as far as it will go.
9. Place headlight protective cover in position and close.
10. Position cover on opening in wheel arch and engage.

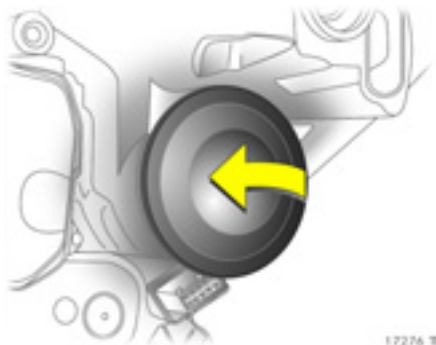

Parking lights

1. Open bonnet and engage support.
2. Replace bulb through opening the front wheel arch: turn relevant wheel to gain access, release catch and remove cover – page 274.
3. Remove main beam headlight protective cover.

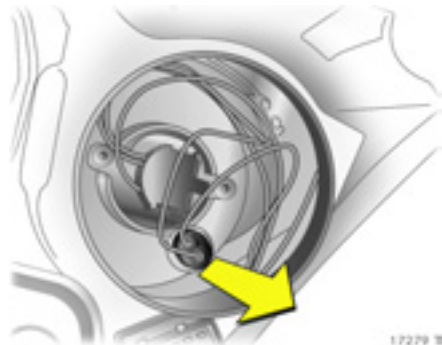

4. Remove parking light socket from reflector.

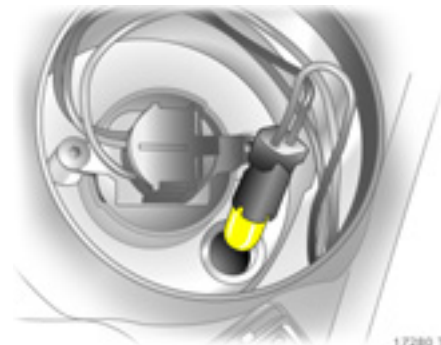

5. Remove bulb from socket.
6. Insert new bulb, without touching the glass.
7. Insert holder in reflector. Place headlight protective cap in position and close.
8. Position cover on opening in wheel arch and engage.



Front indicator lights

1. Open bonnet and engage support.
2. Replace bulb through opening the front wheel arch: turn relevant wheel to gain access, release catch and remove cover – page 274.
3. Rotate bulb holder to left and disengage.

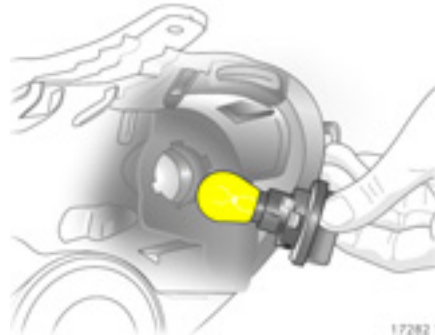

4. Push bulb into socket slightly, rotate left and remove.
5. Insert new bulb, without touching the glass.

6. Insert light holder in reflector, rotate clockwise and engage in position.
7. Position cover on opening in wheel arch and engage.

Fog lights *

Have the bulbs replaced by a workshop. We recommend your Vauxhall Authorised Repairer.



Tail lights

Hatch 5-door

1. To replace bulbs on the right side, use a coin to open the lock as indicated in the Fig. and fold the cover down.

To replace bulbs on the left side, use a coin to turn both locks as illustrated on page 266 in Fig. 17261 T and fold the cover down.

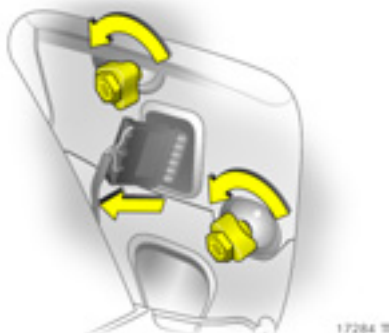

2. Detach plug connector from bulb holder.
3. Hold outside of bulb housing, loosen fastening nuts with wheel bolt wrench * and unscrew by hand. Wheel bolt wrench * – see vehicle tools on page 256.

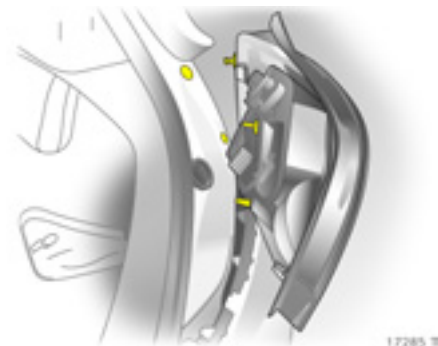

4. Detach bulb housing towards the rear.

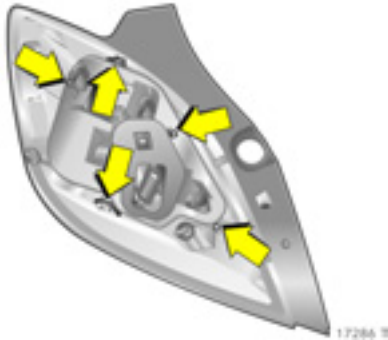

5. Unscrew three screws using a screwdriver (vehicle tools – page 256). Press locking tabs on outside of bulb holder inward and remove the bulb holder.

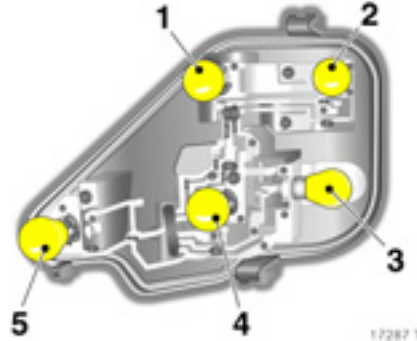

- Bulbs in bulb holder:
 1 = Reversing light
 2 = Turn signal
 3 = Tail light/brake light
 4 = Tail light
 5 = Fog tail light

6. Remove bulb from socket.
 7. Insert new bulb, without touching the glass.
 8. Engage bulb holder in bulb housing, ensuring that it properly engages. Insert three screws with washers and tighten as far as possible.

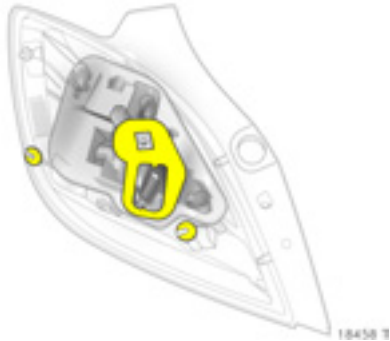

9. Ensure that the seals are applied to the bulb holder and fixing screws.



10. Insert the bulb housing in the body, engaging the lug and the ball pin in the recesses. Tighten the fastening nuts using a wheel bolt wrench . Attach the plug connector. Close and engage the flap.

11. Carry out the following steps to ensure proper function of the tail lights:

- Switch on ignition
- Operate brake
- Switch on parking lights

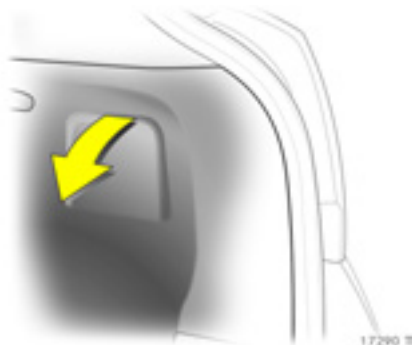

Hatch 3-door

1. To replace bulbs, fold the cover down.

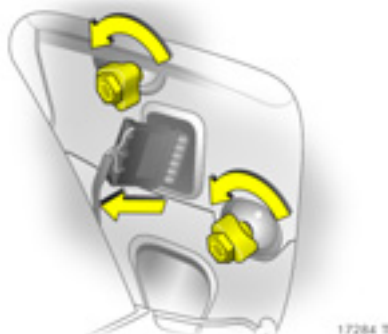

2. Detach plug connector from bulb holder.

3. Hold outside of bulb housing, loosen fastening nuts with wheel bolt wrench * and unscrew by hand. Wheel bolt wrench * – see vehicle tools on page 256.

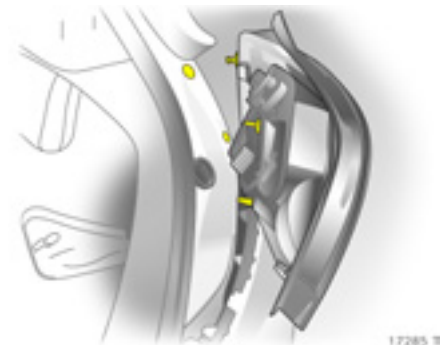

4. Detach bulb housing towards the rear.

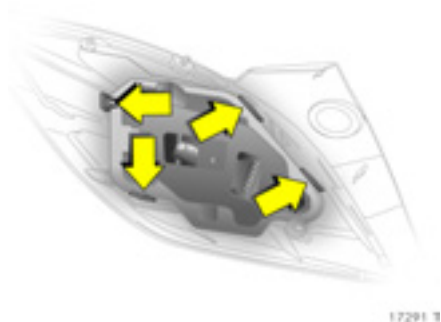

5. Remove the round seal from the fastening bolt. Press the locking tabs on the outside of the bulb holder outward and remove the bulb holder.

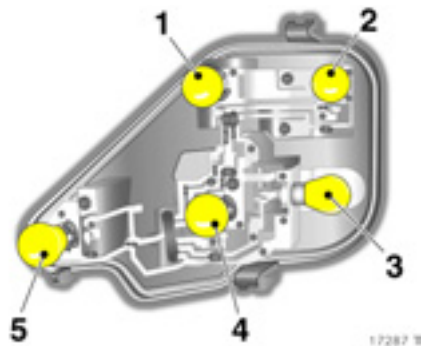

Bulbs in bulb holder:
1 = Reversing light
2 = Turn signal
3 = Tail light/brake light
4 = Tail light
5 = Fog tail light

6. Remove bulb from socket.
7. Insert new bulb, without touching the glass.
8. Engage bulb holder in bulb housing, ensuring that it properly engages.



18439 T

9. Ensure that the seals are applied to the bulb holder and fixing screws.



17289 T

10. Insert the bulb housing in the body, engaging the lug and the ball pin in the recesses. Tighten the fastening nuts using a wheel bolt wrench *. Attach the plug connector. Close and engage the flap.

11. Carry out the following steps to ensure proper function of the tail lights:

- Switch on ignition
- Operate brake
- Switch on parking lights

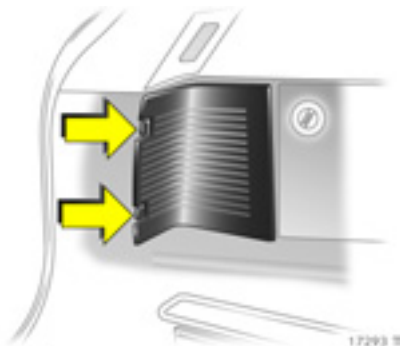

Estate, van

1. Disengage cover by pressing retaining lugs and remove.

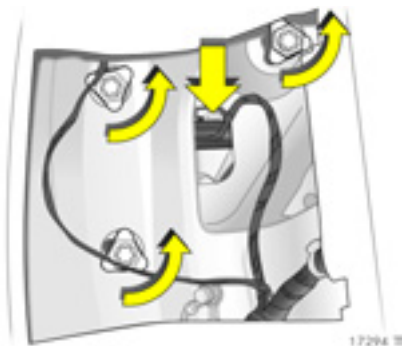

2. Detach plug connector from bulb holder.
3. Hold the outside of the bulb housing, unscrew the three fastening nuts and remove the bulb housing rearwards.

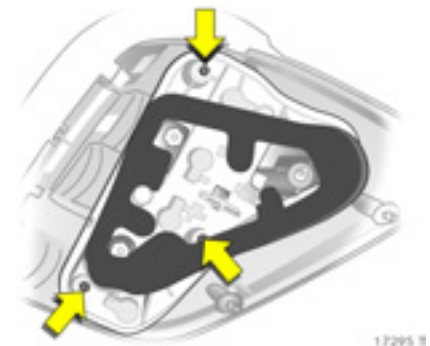

4. Unscrew the three screws with a screwdriver (vehicle tools – page 256) and remove the bulb holder.

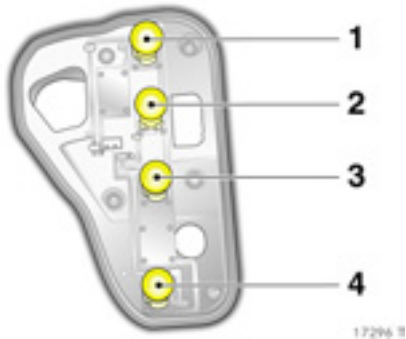

Bulbs in bulb holder:
 1 = Tail light/brake light
 2 = Turn signal
 3 = Reversing light
 4 = Fog tail light

5. Remove bulb from socket.

6. Insert new bulb without touching the glass. Insert bulb holder in bulb housing and screw in place. Insert bulb housing into body and tighten fastening nuts by hand. Attach plug connector. Close and lock cover.

7. Carry out the following steps to ensure proper function of the tail lights:

- Switch on ignition
- Operate brake
- Switch on parking lights



Astra TwinTop

1. Unscrew retaining nuts.



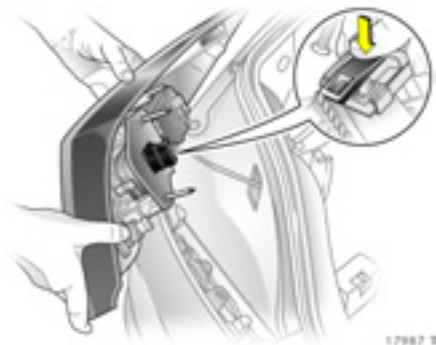

2. Remove bulb housing from outside.
Disengage plug by pressing on flap and remove from bulb holder.
3. Detach seal from bulb holder.

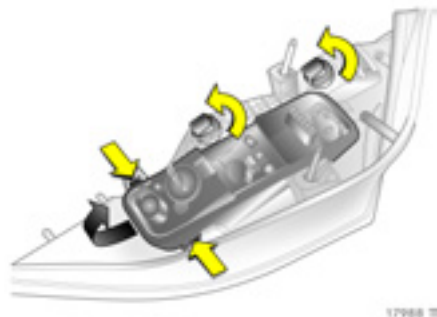

4. Disengage sockets by turning and remove.
Press locking tabs on the long sides of the bulb holder outwards; lift bulb holder at front end (arrow) and remove.

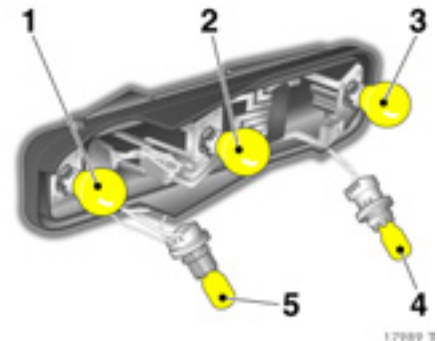

- Bulbs in bulb holder:
- 1 = Tail light/brake light
 - 2 = Tail light
 - 3 = Fog tail light
 - 4 = Reversing light
 - 5 = Turn signal

5. Remove bulb from socket.
6. Insert new bulb, without touching the glass.
7. Insert bulb holder in bulb housing by first inserting the lug in the front of the plug. Fold together bulb holder, ensuring that it engages properly. Insert sockets and engage by turning.

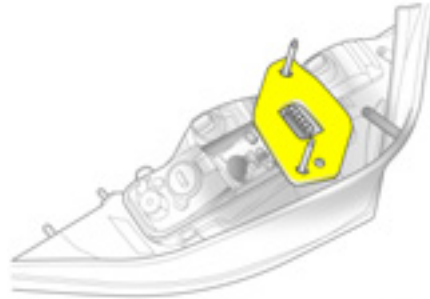

8. Fit seal on bulb holder as illustrated. Ensure that the seal is flat in the area of the screws.
9. Engage plug. Insert light housing in body, ensuring proper positioning of the ball pins in the recesses. Tighten the retaining nuts.
10. Carry out the following steps to ensure proper function of the tail lights:
 - Switch on ignition
 - Operate brake
 - Switch on parking lights

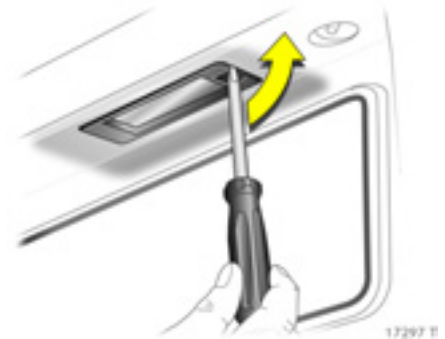

Number plate light

1. Insert screwdriver vertically in bulb insert as illustrated in figure. Press to the side and release spring.

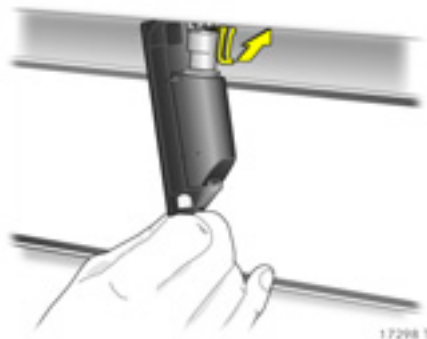

2. Remove bulb housing downward, taking care not to pull on the cable.
3. Lift flap and disconnect plug from bulb socket.



4. Rotate bulb socket anticlockwise and disengage.
5. Remove bulb from socket.
6. Insert new bulb, without touching the glass.
7. Insert bulb holder in bulb housing and twist to right.
8. Connect plug to bulb socket.
9. Insert and engage bulb housing.

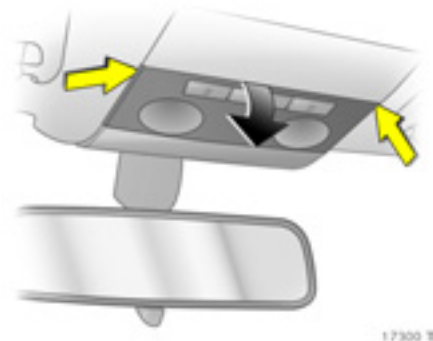

Courtesy lights

Front courtesy light, reading lights ✽

To ensure that no power is supplied to the lights, close the doors before removing.

1. Disengage lens by hand at location illustrated in figure, press it downward slightly and remove at a downward angle.
2. Remove bulb from socket.
3. Insert new bulb, without touching the glass.
4. Mount lens and engage in position.

**Rear courtesy lights ✳,
rear reading lights ✳**

Have the bulbs replaced by a workshop.
We recommend your Vauxhall Authorised
Repairer.



17301 1

**Glove compartment lighting,
luggage compartment lighting,
foot well lighting ✳**

To ensure that no power is supplied to the
lights, close the doors or hold the contact
switch depressed before removing.

1. Prise the light out with a screwdriver.



17302 1

2. Press bulb slightly towards spring clip and remove.
3. Insert new bulb, without touching the glass.
4. Insert light in opening and engage in position.

**Instrument illumination,
Information display illumination ✳**

Have the bulbs replaced by a workshop.
We recommend your Vauxhall Authorised
Repairer.

If you have a problem

In our experience the most common cause of all complaints is the result of misunderstanding or lack of communication between the customer and the Vauxhall Authorised Repairer.

We sincerely hope you will never have cause to complain about your vehicle. However, if things do go wrong, the best course of action for you to take is to contact your Vauxhall Authorised Repairer's Service Reception Staff and explain the difficulty you are having. We are confident they will do their utmost to resolve the problem to your complete satisfaction.

Sometimes, however, despite the best of intentions of all concerned, misunderstandings can occur. If your problem has not been resolved to your satisfaction, please make an appointment to discuss the matter with the Manager of the department concerned.

The majority of areas of concern can be quickly resolved in this way.

Should you wish to pursue the matter further, the Principal of the Vauxhall Authorised Repairer should be made aware of your concern. It is advisable in cases such as this to write to him to confirm your problem and the solutions that have been offered.

You can be assured the Authorised Repairer's Principal will only be too anxious to fully investigate your problems and correct any errors made. After all, he has a large investment in his business and is proud of his reputation and professionalism and fully realises that satisfied customers are his key to success.

In the unlikely event that you are still not happy with the answer your Vauxhall Authorised Repairer has given, or the action he proposes to correct the problem, you may contact the Customer Care Department¹⁾ where a team of Customer Care Consultants will spare no effort to ensure your complete satisfaction.

Vauxhall Motors Ltd.

Customer Care,
Griffin House,
Osborne Road,
LUTON,
Beds., LU1 3YT
Telephone: 01582 427200

They will review all the facts involved. Then if it is felt some further action can be taken,

¹⁾ Calls may be monitored and recorded for training purposes.

the Vauxhall Authorised Repairer will be advised accordingly. In any case, your contact will be acknowledged confirming Vauxhall Motors' position in the matter.

If you are not satisfied with the outcome, you can if you wish, seek advice from an independent third party such as:

Automobile Association (A.A.)

Fanum House,
BASINGSTOKE,
Hants., RG21 2EA

Royal Automobile Club (R.A.C.),

R.A.C. Motoring Services Ltd.,
89-91 Pall Mall,
LONDON, SW1Y 54S

The Customer Relations Department,
Society of Motor Manufacturers and Traders Ltd. (S.M.M.T.),
Forbes House, Halkin Street,
LONDON, SW1X 7DS

Customer Complaints Service,
Scottish Motor Trade Association,
(S.M.T.A.),
3 Palmerston Place,
EDINBURGH, EH12 5AQ

The National Conciliation Service,
Retail Motor Industry Federation,
9 North Street,
RUGBY, CV21 2AB

If you have a problem whilst abroad:The Service Departments of ADAM OPEL GmbH and General Motors branches everywhere will provide information and assistance:

In **Luxembourg**, please contact the General Motors Service Department in Antwerp – Belgium
Tel. 00 32-34 50 63 29

General Motors Austria GmbH
Groß-Enzersdorfer Str. 59
1220 Vienna – Austria
Tel. 00 43 1-2 88 77 444 or
00 43-1-2 88 77 0

General Motors Belgium N.V.
Noorderlaan 401 – Haven 500
2030 Antwerp – Belgium
Tel. 00 32-34 50 63 29

General Motors Southeast Europe,
org. složka
Olbrachtova 9
140 00 Prague – Czech Republic
Tel. 00 420-2 39 004 321

General Motors Denmark
Jaegersborg Alle 4
2920 Charlottenlund – Denmark
Tel. 00 45-39 97 85 00

Vauxhall Motors Ltd.
Customer Care
Griffin House, Osborne Road
Luton, Bedfordshire, LU1 3YT – England
Tel. 00 44-15 82-42 72 00

General Motors Finland Oy
Pajuniityntie 5
00320 Helsinki – Finland
Tel. 00 358-9 817 101 47

General Motors France
1 – 9, avenue du Marais
Angle Quai de Bezons
95101 Argenteuil Cedex – France
Tel. 00 33-1-34 26 30 51

ADAM OPEL GmbH
Bahnhofsplatz 1
65423 Rüsselsheim – Germany
Tel. 00 49-61 42-77 50 00 or
00 49-61 42-7 70

General Motors Hellas S.A.
56 Kifisias Avenue & Delfon str.
Amarousion
151 25 Athens – Greece
Tel. 00 30-1-6 80 65 01

General Motors Southeast Europe Ltd.
Szabadsag utca 117
2040 Budaörs – Hungary
Tel. 00 36-23 446 100

General Motors India
Sixth Floor, Tower A
Global Business Park
Mehrauli – Gurgaon Road
Gurgaon – 122 022, Haryana – India
Tel. 00 91-124 280 3333

General Motors Ireland Ltd.
Opel House, Unit 60, Heather Road
Sandyford, Dublin 18 – Ireland
Tel. 00 353-1-216 10 00

General Motors Italia Srl
Piazzale dell'Industria 40
00144 Rome – Italy
Tel. 00 39-06-5 46 51

General Motors Nederland B.V.
Lage Mosten 49 – 63
4822 NK Breda – Netherlands
Tel. 00 31-76-5 44 83 00

General Motors Norge AS
Kjeller-Vest 6
2027 Kjeller – Norway
Tel. 00 47-23 50 01 04

General Motors Poland Sp. z o. o.
Domaniewska 41
06-672 Warsaw – Poland
Tel. 00 48-22-606 17 00

General Motors Portugal
Quinta da Fonte
Edifício Fernão Magalhães, Piso 2
2780-190 Paço d'Arcos – Portugal
Tel. 00 351-21 440 75 00

General Motors Southeast Europe,
org. zložka
Apollo Business Centre
Mlynské Nivy 45
821 09 Bratislava – Slovakia
Tel. 00 421-2 58 275 543

General Motors España S.L.
Paseo de la Castellana, 91
28046 Madrid – Spain
Tel. 00 34-902 25 00 25

General Motors Norden AB
Årstaängvägen 17
100 73 Stockholm – Sweden
Tel. 00 46-20 333 000

General Motors Suisse S.A.
Stelzenstraße 4
8152 Glattbrugg – Switzerland
Tel. 00 41-44 828 28 80

General Motors Türkiye Ltd. Sti.
Kemalpaşa yolu üzeri
35861 Torbalı/Izmir – Turkey
Tel. 00 90-2 32-8 53-14 53

In **Albania, Bosnia-Herzegovina, Bulgaria, Croatia, Estonia, Latvia, Lithuania, Macedonia, Romania, Serbia-Montenegro and Slovenia**

please contact the Opel Service Department in Budaörs – Hungary
Telephone 00 36-23 446 100

Maintenance, Inspection System

| | |
|---|-----|
| A note on safety | 297 |
| Checking and topping up fluids | 297 |
| Engine oil | 298 |
| Diesel fuel filter | 300 |
| Coolant | 300 |
| Brake fluid | 302 |
| Windscreen wiper | 303 |
| Windscreen and headlight wash systems ✱ | 305 |
| Battery | 306 |
| Protecting electronic components | 306 |
| Vehicle decommissioning | 307 |
| Vehicle recommissioning | 307 |



In order to guarantee economical and safe vehicle operation and to maintain the value of your vehicle, it is of vital importance that all maintenance work is carried out at the proper intervals as specified by Vauxhall.

In vehicles with a fixed engine oil change and service interval, **InSP** appears in the odometer display when the ignition is switched on if the vehicle is due for service. Have service work performed within a week or 300 miles (500 km). We recommend your Vauxhall Authorised Repairer.

The service interval display takes account of off-the-road periods during which the battery is disconnected.

For vehicles with flexible engine oil change and service intervals, the length of these intervals is based on several parameters stemming from usage. For this reason, various engine-specific data is continually gathered and is used to calculate the remaining distance until the next service.

This remaining distance can be displayed with the ignition off: briefly press the trip odometer reset button, the mileage reading shows. Press the button again for around 2 seconds, **InSP** and the remaining distance is shown.

If the remaining distance is less than 1000 miles (1500 km), **InSP** is displayed with a remaining distance of 600 miles (1000 km) when the ignition is switched on and off. **InSP** is displayed for several seconds if the remaining distance is less than 600 miles (1000 km). Have the service work that is due carried out within one week or 300 miles (500 km). Have this work carried out by a Vauxhall Authorised Repairer in order to avoid invalidation of warranty claims.

Further information on maintenance and the inspection system can be found in the service booklet, which is in the glove compartment.

Have maintenance work, as well as repairs to the bodywork and equipment, carried out by a professional. We recommend your Vauxhall Authorised Repairer, who is familiar with Vauxhall vehicles and in possession of the necessary special tools and the latest service instructions from Vauxhall. It is particularly advisable to use a Vauxhall Authorised Repairer during the warranty period to avoid invalidation of warranty claims. See the Service Booklet for further information.

Separate anti-corrosion service

Have the work carried out at the intervals specified in the Service Booklet. We recommend your Vauxhall Authorised Repairer.

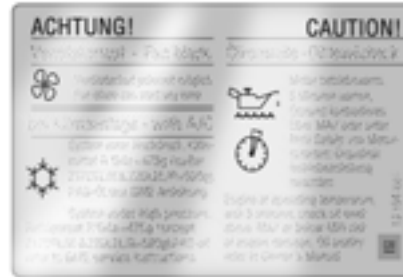

17304 II

A note on safety

To avoid injury from moving parts and cables conducting ignition voltage, only carry out engine compartment checks (e.g. checking brake fluid or engine oil level) when the ignition is switched off.

Warning

The cooling fan is controlled by a thermostatic switch and can therefore start unexpectedly even if the ignition is switched off. Risk of injury.

Electronic ignition systems generate very high voltages. Do not touch the ignition system; high voltage can be fatal.

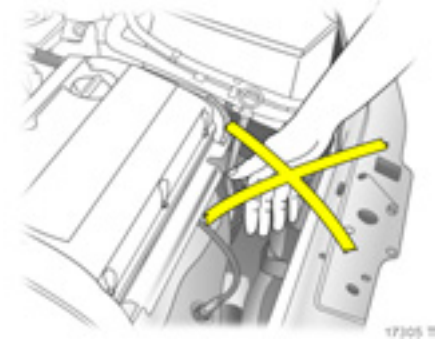

17305 II

Never carry out any repairs or adjustment and maintenance work on the vehicle yourself. This especially applies to the engine, chassis and safety parts. You may unwittingly infringe the provisions of the law and, by not performing the work properly, endanger yourself and other road users.

Checking and topping up fluids

To aid identification, the caps used when topping up engine oil, coolant and wash fluid as well as the oil dipstick are coloured yellow.

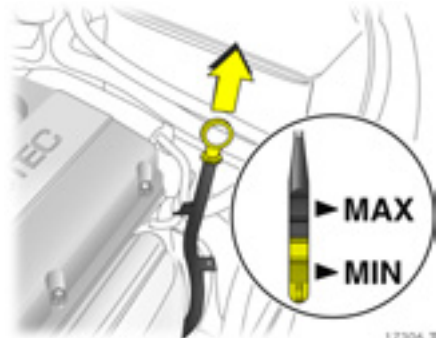

Engine oil

Information on engine oils is found in the Service Booklet.

Engine oil level and consumption

Every engine consumes engine oil for technical reasons. The engine oil consumption cannot be assessed until a fairly long distance has been driven, and may be above the specified value when the vehicle is first being driven (run-in period). Frequent driving at high revs increases engine oil consumption.

Warning

It is the Owner's Responsibility to maintain the proper level of an appropriate quality oil in the engine.

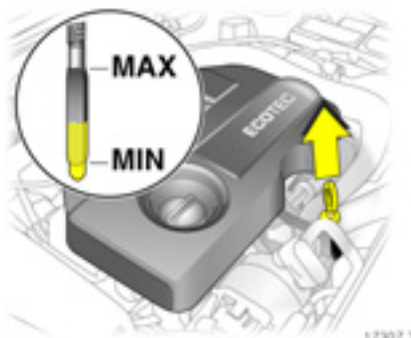

The engine oil level * is checked automatically ¹⁾, see page 40. Before embarking on a long journey it is advisable to check the engine oil level.

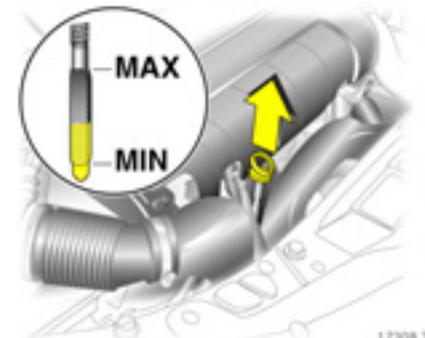

Checking the engine oil level, topping up engine oil

The figures on this page indicate checks on one petrol and two diesel engines.

The oil level must be checked with the vehicle on a level surface and with the engine (which must be at operating temperature) switched off. Wait at least 5 minutes before checking the level to allow the normal engine oil accumulation in the engine to drain into the oil pan.

¹⁾ Not on Z 14 XEP or Z 20 LEH engine. Sales designation – see page 314.

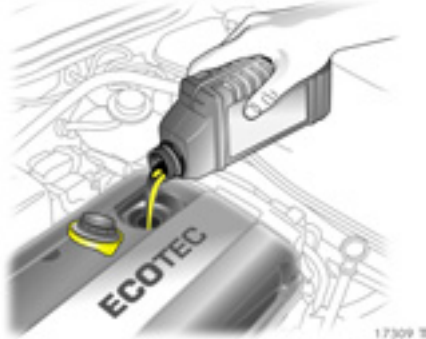

To check the engine oil level, insert wiped oil dipstick into handle as far as it will go. Top engine oil up if the level has dropped into the range of the top-up mark **MIN**.

The engine oil level must not exceed the upper mark **MAX** on the dipstick. Excess engine oil must be drained off or extracted. If the engine oil level is above the **MAX** mark there is a risk of damage to the engine or the catalytic converter.

Capacity between **MIN** and **MAX** marks – pages 343, 343.

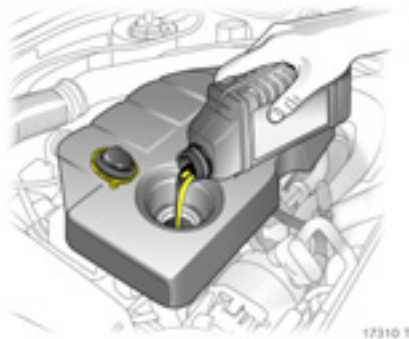

Top up with the same brand of engine oil that was used during the previous oil change, following the instructions in the service booklet.

To close, position the cap and screw it into place.

Capacities – pages 343, 343.

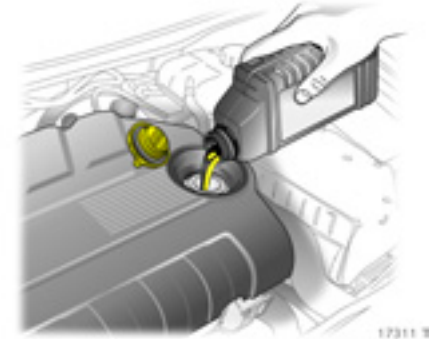

Engine oil change, oil filter change

Change the oil at the displayed service intervals.

We recommend that you use genuine Vauxhall engine oil filters.

Warning

Drained engine oil filters cannot be placed with domestic refuse. We recommend your Vauxhall Authorised Repairer for engine oil and filter change. He is familiar with the legal requirements on the disposal of old oil and filters. This ensures protection for the environment and your health.

Diesel fuel filter

Check fuel filter for any water residue when each engine oil change takes place. We recommend that you consult your Vauxhall Authorised Repairer.

Illumination of  indicates water in the fuel filter .

Have fuel filter checked at shorter intervals if the vehicle is subjected to extreme operating conditions such as high humidity (primarily in coastal areas), extremely high or low outside temperatures and substantially varying daytime and night-time temperatures.

Coolant

The glycol-based coolant provides excellent corrosion protection for the heating and cooling systems as well as antifreeze protection down to -28°C . It remains in the cooling system throughout the year and need not be changed.

Use of certain antifreezes can lead to engine damage. We therefore recommend that you use antifreezes that have been approved by Vauxhall.

Warning

Antifreeze is a danger to health; it must therefore be kept in the original container and out of the reach of children.

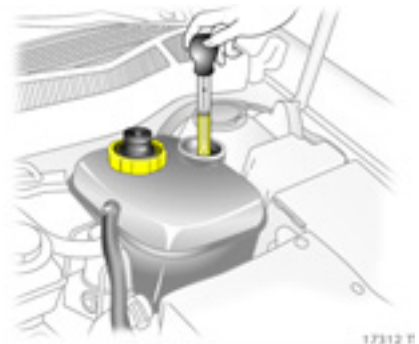

Antifreeze and corrosion protection

Before the start of the cold weather season, have the coolant checked for correct concentration. We recommend that you consult your Vauxhall Authorised Repairer. The amount of antifreeze must provide protection down to approx. -28°C . If the antifreeze concentration is too low, this reduces protection from freezing and corrosion. Top up antifreeze if necessary.

If coolant loss is topped up with water, have concentration checked and add antifreeze if necessary.



Coolant level

Hardly any losses occur since the cooling system is sealed and it is thus rarely necessary to top up the coolant.

The coolant should be a little above the **KALT/COLD** mark in the expansion tank with a cold cooling system. The coolant level can also be read off from the outside of the expansion tank.

Warning

Allow engine to cool down before removing coolant filler cap. Remove filler cap carefully so that pressure can escape slowly, otherwise there is a risk of scalding.

When the engine is at operating temperature, coolant level rises. It falls again when the system cools. If it falls below the **KALT/COLD** mark when the system is cold, top up to the mark.

Top up antifreeze. If no antifreeze is available, top up with clean tap water. If tap water is unavailable, distilled water can be used.

After topping up with drinking water or distilled water, check the anti-freeze level and add anti-freeze if required. Eliminate the cause of the coolant loss. We recommend your Vauxhall Authorised Repairer.

Too low a coolant level can cause engine damage.

To close, position the cap and screw it into place.

Coolant temperature

Control indicator  illuminates when coolant temperature is too high. Check coolant level immediately:

- Coolant level low:
Top up coolant. Pay attention to the instructions given under "Antifreeze and corrosion protection" and "Coolant level". Have the cause of coolant loss remedied. We recommend that you consult your Vauxhall Authorised Repairer.
- Coolant level OK:
Have the cause of increased coolant temperature remedied. Consult a workshop. We recommend your Vauxhall Authorised Repairer.

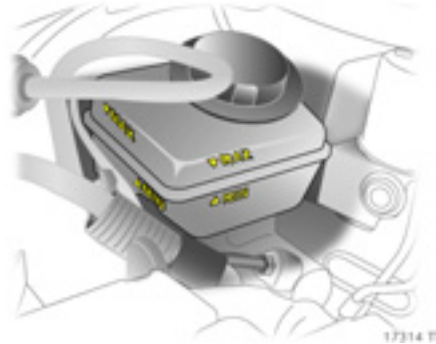

Brake fluid

Brake fluid level

Warning

Caution – brake fluid is poisonous and corrosive. Do not allow it to come into contact with eyes, skin, fabric or painted surfaces. Direct contact could cause injury and damage.

The fluid level in the reservoir must be neither higher than the **MAX** mark nor lower than the **MIN** mark.

Use of certain brake fluids can lead to damage or reduced braking effect. We therefore recommend that you use only high performance brake fluid approved by Vauxhall.

When topping up, ensure maximum cleanliness as contamination of the brake fluid can lead to function problems in the braking system.

After correcting the brake fluid level, have the cause of brake fluid loss remedied. We recommend that you consult your Vauxhall Authorised Repairer.

Brake fluid change

Brake fluid is hygroscopic, i.e. it absorbs water. If the brakes become hot, such as when driving on long downhill stretches, vapour bubbles can occur in the water, which can have an extremely adverse effect on braking power (depending on the proportion of water).

The fluid change intervals specified in the Service Booklet must therefore be observed.

Warning

We recommend that you have brake fluid changed by a Vauxhall Authorised Repairer, who will be familiar with the requirements of the law as regards disposal of brake fluid and can thus help to protect the environment and your health.

Windscreen wiper

Clear vision is essential for safe driving.

Perform regular checks on the windscreen wiper and headlight wash system * to ensure they are operating correctly. We recommend wiper blade replacement at least once a year.

If the windscreen is dirty, operate the windscreen wash system before switching on the windscreen wiper or setting the wiper to automatic operation with the rain sensor *. This will avoid wiper blade wear.

Do not switch on the windscreen wiper or set them to automatic operation with the rain sensor * if the windscreen is iced up as this could damage the wiper blades or the wiper system.

If the wiper becomes frozen on to the glass, we recommend that they be released with the aid of Vauxhall De-icer Spray.

Smearing wiper blades can be cleaned with a soft cloth and Vauxhall Windscreen Wash Solvent.

Wiper blades whose lips have become hardened, cracked or covered with silicone must be replaced. This may be necessary as a result of the effects of ice, thawing salt or heat, or the incorrect use of cleaning agents.

Switch off the windscreen wiper or automatic wiper with rain sensor * in car washes – pages 17, 18, 309.

Windscreen wiper care – page 310.

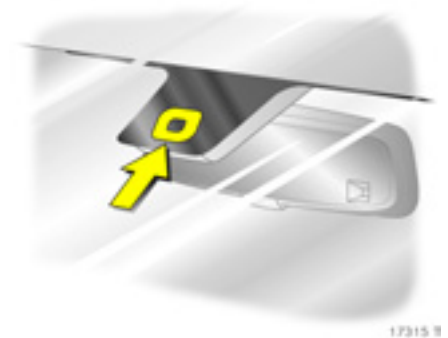

To ensure proper operation of the rain sensor * the sensor area must be free from dust, dirt and ice, which is why the windscreen wash system must be operated at regular intervals and the sensor area de-iced. Vehicles with rain sensor * can be identified by the sensor area near the top of the windscreen.



Service setting for front windscreen wiper (e.g. for changing or cleaning the front wiper blades).

Within 4 seconds from turning off the ignition, with the key still in the lock ✳ or for the Open&Start System after switching off the ignition and before opening the driver's door, press the wiper stalk down. Release wiper stalk as soon as the wiper is vertical.

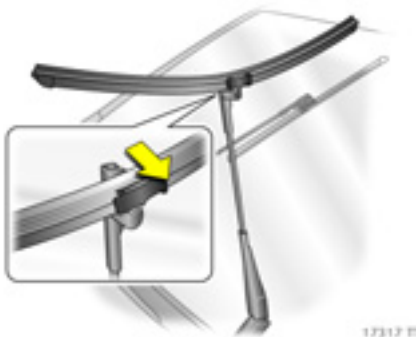

Wiper blades on the windscreen

Activate service setting - see previous column. Raise wiper arm, tilt wiper blade at a 90° to the wiper arm and remove to the side.

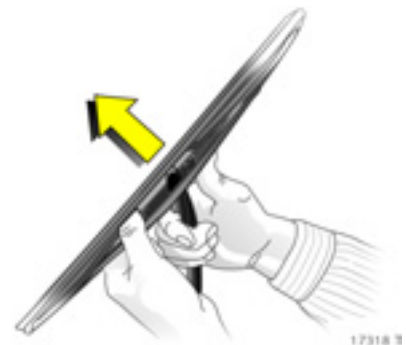

Wiper blade on the rear window ✳

Lift wiper arm. Disengage wiper blade as shown in illustration and remove.

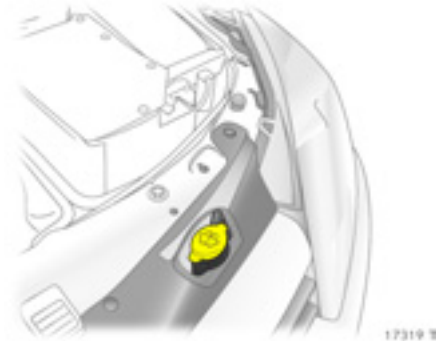

Windscreen and headlight wash systems *

The fluid reservoir filler neck for the windscreen wash system and headlight wash system * is located at the front next to the left headlight.

Capacities – pages 343, 343.

Fill only with clean water to prevent the nozzles from clogging. To improve cleaning efficiency, we recommend that you add a little Vauxhall Windscreen Wash Solvent.

The windscreen wash system and headlight wash system will not freeze in winter:

| Frost protection down to | Mixture Vauxhall Windscreen Wash Solvent: Water |
|--------------------------|---|
| - 5 °C | 1 : 3 |
| - 10 °C | 1 : 2 |
| - 20 °C | 1 : 1 |
| - 30 °C | 2 : 1 |

When closing the reservoir, press the lid firmly over the beaded edge all the way round.



17320 1

Battery

The battery is maintenance-free.

Warning

We recommend that you have battery changes carried out by a Vauxhall Authorised Repairer. They know the laws concerning the disposal of used batteries and therefore protect the environment and your health.

Retrofitted electrical or electronic accessories can place an additional load on the battery or even discharge the battery. We recommend that you consult a Vauxhall Authorised Repairer regarding technical possibilities, such as fitting a more powerful battery.

Laying up the vehicle for more than 4 weeks can lead to battery discharge, which may reduce the service life of the battery. Disconnect battery from on-board power supply by detaching negative terminal (anti-theft alarm system * is then disabled).

Ensure that ignition is switched off before connecting battery. Then perform the following actions:

- Setting date and time in the information display – pages 48, 51, 56.
- If necessary activate the windows * and sun roof * – pages 145, 146.

In order to prevent the battery from discharging, some consumers such as the courtesy light automatically switch off after approx. 20 minutes.

Protecting electronic components

In order to prevent faults in electronic components in the electrical system, never connect or disconnect battery with engine running or ignition switched on. Never start engine with battery disconnected, e.g. when starting using jump leads.

To avoid damaging the vehicle, do not make any modifications to the electrical system, e.g. connecting additional consumers or tampering with electronic control units (chip tuning).

Warning

Electronic ignition systems generate very high voltages. Do not touch the ignition system; high voltage can be fatal.

Disconnecting/connecting the battery from/to the electrical system

Disconnect the battery from the vehicle electrical system before charging: First detach the negative and then the positive lead. Do not reverse the polarity of the battery, i.e. do not confuse the terminals for the positive and negative leads. When connecting, start with the positive lead and then connect the negative lead.

Vehicle decommissioning

Observe national regulations.

If the vehicle is decommissioned for several months, the following work must be carried out in order to prevent damage. We recommend that you consult your Vauxhall Authorised Repairer.

- Wash and preserve the vehicle – page 309.
- Check corrosion protection in engine compartment and on underbody and repair if necessary.
- Clean and wax the rubber seals of the bonnet, doors and roof. Intermediate position of the Astra TwinTop roof for cleaning – page 151.
- Change engine oil – page 299.
- Check antifreeze and corrosion protection – page 300.
- Check the coolant level, top up with antifreeze if necessary – page 301.
- Empty windscreen wash system and headlight wash system.
- Increase tyre pressure to value specified for full load – page 334.

Vehicle storage

- Park vehicle in dry, well ventilated place.
With manual transmission or Easytronic ✱, engage 1st or reverse gear. With automatic transmission ✱, selector lever in P. Use chocks or the like to prevent the vehicle from rolling.
- Do not apply hand brake.
- Disconnect battery by disengaging negative terminal from vehicle electrical system – page 306.

Vehicle recommissioning

Observe national regulations.

Perform the following work before recommissioning the vehicle:

- Connect battery – see page 306.
- Check tyre pressure and correct if necessary – page 334.
- Fill up windscreen wash system – page 305.
- Check engine oil level – page 298.
- Check the coolant level; top up with antifreeze if necessary – page 301.
- Fit the number plate if necessary.

Vehicle care

| | |
|--------------------------------|-----|
| Vehicle care aids *..... | 308 |
| Washing | 309 |
| Waxing | 309 |
| Polishing | 309 |
| Wheels | 309 |
| Paintwork damage..... | 310 |
| Exterior lights | 310 |
| Plastic and rubber parts | 310 |
| Wheels and tyres | 310 |
| Interior and upholstery..... | 310 |
| Seat belts..... | 310 |
| Windows | 310 |
| Windscreen wiper blades..... | 310 |
| Locks..... | 311 |
| Engine compartment..... | 311 |
| Underbody | 311 |
| Astra TwinTop | 311 |

Obtain advice from a Vauxhall Authorised Repairer regarding cleaning materials that have been tested and recommended by Vauxhall.

When caring for your vehicle, observe all national environmental regulations, particularly when washing it.

Regular, thorough care helps to improve the appearance of your vehicle and maintain its value over the years. It is also prerequisite for warranty claims for any paint or corrosion damage. The following pages contain tips for vehicle care which, if used properly, will help combat the unavoidable, damaging effects of the environment.

Vehicle care aids *

Vehicle wash:

- Wash brush
- Shampoo
- Sponge
- Insect Removal Sponge
- Chamois

Vehicle care:

- Paintwork Cleaner
- Paintwork Polish
- Cream Polish
- Metallic Paintwork Wax
- Hard wax
- Vauxhall Touch-Up Paint
- Vauxhall Touch-Up/Aerosol Paint
- Wheel Preserver
- Insect Remover
- Window Cleaner,
- Vauxhall Windscreen Wash Solvent
- Silicone Oil for Rubber Seals,
- Cleaner

Washing

The paintwork of your vehicle is exposed to environmental influences, e.g. continuous changes in weather conditions, industrial waste gases and dust or thawing salts, so wash and wax your vehicle regularly. When using automatic car washes, select a programme which includes waxing.

Bird droppings, dead insects, resin, pollen and the like should be cleaned off immediately, as they contain aggressive constituents which can cause paint damage.

If using a car wash, comply with the pertinent instructions of the car wash manufacturer. The windscreen wiper and rear window wiper must be switched off – pages 17, 18. Remove antenna ✱ and roof rack ✱. Stand on the door sill to reach them more easily.

If you wash your vehicle by hand, make sure that the insides of the wings are also thoroughly rinsed out.

Clean edges and folds on opened doors and flaps as well as the areas they cover.

Thoroughly rinse off and leather-off the vehicle. Rinse leather frequently. Use separate leathers for paint and window surfaces: remnants of wax on the windows will impair vision.

Observe national regulations.

Waxing

Wax your vehicle regularly, in particular after it has been washed using shampoo and at the latest when water no longer forms beads on the paintwork, otherwise the paintwork will dry out.

Also wax edges and folds on opened doors and flaps as well as the areas they cover.

Sun roof ✱

Never clean with solvents or abrasive agents, fuels, aggressive media (e.g. paint cleaner, acetone-containing solutions etc.), acidic or highly alkaline media or abrasive pads.

No stickers may be applied to the sun roof.

Polishing

Polishing is necessary only if the paint has become dull or if solid deposits have become attached to it.

Paintwork polish with silicone forms a protective film, making waxing unnecessary.

Plastic body parts should not be treated with wax and polish.

Use Metallic Paintwork Wax on vehicles with a metallic-effect paint finish.

Wheels

Use a pH-neutral wheel cleaning agent to clean the wheels.

Wheels are painted and can be treated with the same agents as the body. For alloy wheels we recommend use of Alloy Wheel Preserver.

Paintwork damage

Repair small areas of paint damage such as stone impacts, scratches etc. immediately using a Vauxhall touch-up applicator or Vauxhall spray and touch-up paint before rust can form. If rust has already formed, have the cause remedied. We recommend that you consult your Vauxhall Authorised Repairer. Please also pay attention to surfaces and edges beneath the vehicle where which rust may have formed unnoticed for some time.

Exterior lights

Headlight and other protective light bezels are made of plastic. If they require additional cleaning after the vehicle has been washed, clean them with Car Shampoo. Do not use any abrasive or caustic agents, do not use an ice scraper, and do not clean them dry.

Plastic and rubber parts

For additional cleaning of plastic and rubber parts use Cleaner. Do not use any other agent, and in particular do not use solvents or petrol.

Do not use high-pressure jet cleaners.

Wheels and tyres

Do not use high-pressure jet cleaners.

Interior and upholstery

Clean the vehicle interior, including the instrument panel fascia, using interior cleaner.

The instrument panel should only be cleaned using a soft damp cloth.

Clean fabric upholstery with a vacuum cleaner and brush. To remove stains, use cleaner that is suitable for both fabrics and vinyl.

Do not use cleaning agents such as acetone, tetrachloride, paint thinner, pint remover, nail varnish remover, washing powder or bleach. petrol is also unsuitable.

Open Velcro fasteners on clothing could damage seat upholstery. Make sure Velcro fasteners are closed.

Seat belts

Always keep seat belts clean and dry.

Clean only with lukewarm water or Cleaner.

Windows

When cleaning the heated rear window, make sure that the heating element on the inside of the window is not damaged.

Use a soft lint-free cloth or chamois leather in conjunction with Window Cleaner and Insect Remover.

Vauxhall Windscreen Wash Solvent is suitable for de-icing windows.

For mechanical removal of ice, use a commercially available sharp-edged ice scraper. Press the scraper firmly against the glass so that no dirt can get under it and scratch the glass.

Windscreen wiper blades

Wax, such as that used in car washes, can cause streaks to form on the windscreen when the wiper is used.

Smearing wiper blades can be cleaned with a soft cloth and Vauxhall Windscreen Wash Solvent, and replaced if necessary – page 303.

Locks

The locks are lubricated with a high-grade lock cylinder grease at the factory. Vauxhall lock cylinder grease prevents the locks from freezing up. Only use de-icing agent in emergencies, as they have a degreasing effect and will impair the function of the locks. After using a de-icing agent, have the locks re-greased. We recommend that you entrust this to your Vauxhall Authorised Repairer.

Engine compartment

Areas of the engine compartment that are painted in the same colour as the vehicle must be looked after like any other painted surface.

It is advisable to wash the engine compartment before and after winter and preserve it with wax. Cover alternator and brake fluid reservoir with plastic sheets before washing the engine.

When washing the engine with a steam-jet cleaner, do not direct the steam jet at components of the anti-lock brake system, the air conditioning system, the climate control system or the belt drive and its components.

Protective wax that has been applied is also removed during the engine wash. For this reason, have the engine, brake system components in the engine compartment, axle components with steering, body parts and cavities thoroughly preserved with protective wax after the wash. We recommend that you consult your Vauxhall Authorised Repairer.

An engine wash can be performed in the spring in order to remove dirt that has adhered to the engine compartment, which may also have a high salt content. Check protective wax layer and make good if necessary.

Do not use high-pressure jet cleaners.

Underbody

Your vehicle has a factory-applied PVC undercoating in the wheel arches (including the longitudinal members) which provides permanent protection and needs no special maintenance. The surfaces of the vehicle underbody not covered by PVC are provided with a durable protective wax coating in critical areas.

On vehicles which are washed frequently in automatic car washes with underbody washing facility, the protective wax coating may be impaired by dirt-dissolving additives.

Check the underbody after washing and have it waxed if necessary. Before the start of the cold weather season, check the PVC coating and protective wax coating. Have them restored to perfect condition if necessary.

Caution - commercially available bitumen/rubber materials can damage the PVC coating. We recommend that you have underbody work carried out by a Vauxhall Authorised Repairer, who knows the prescribed materials and has experience in the use thereof.

The underbody should be washed following the end of the cold weather season to remove any dirt adhering to the underbody since this may also contain salt. Check protective wax coating and, if necessary, have it restored to perfect condition.

Astra TwinTop

Treat all seals, e. g. on the roof and windscreen frame, with silicone oil from time to time. Good contact between the fine rubber lips and the sealing surfaces prevents leaks and reduces clamping forces.

Intermediate roof position for cleaning - see page 151.

Do not use high-pressure jet cleaners.

Technical Data

| | |
|--|-----|
| Vehicle documents, identification plate..... | 312 |
| Vehicle identification data..... | 313 |
| Coolant, brake fluid, oils..... | 313 |
| Engine data..... | 314 |
| Performance..... | 316 |
| Fuel consumption, CO ₂ emissions | 319 |
| Weights, payload and roof load..... | 324 |
| Tyres | 333 |
| Electrical system | 342 |
| Capacities | 343 |
| Dimensions..... | 344 |
| Installation dimensions of trailer towing equipment..... | 345 |

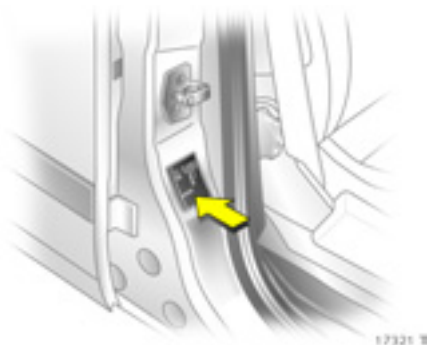

Vehicle documents, identification plate

The technical data is determined in accordance with European Community standards. We reserve the right to make modifications. Specifications in the vehicle documents always have priority over those given in this manual.

The identification plate is affixed to the front right door frame.



Information on identification plate:

- 1 Manufacturer
- 2 Type approval number
- 3 Vehicle identification number
- 4 Permissible gross vehicle weight
- 5 Permissible gross train weight
- 6 Maximum permissible front axle load
- 7 Maximum permissible rear axle load
- 8 Vehicle-specific or country-specific data



Vehicle identification data

The vehicle identification number is stamped on the identification plate (see previous page) and in the vehicle floor on the right-hand side under a cover between the driver's door and seat.

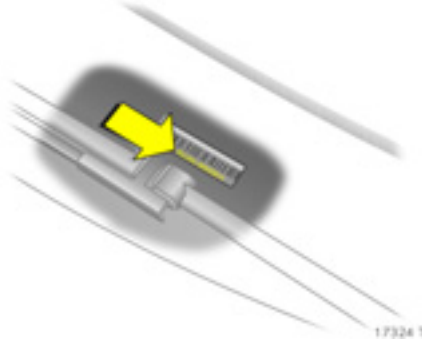

The vehicle identification number may be embossed on the instrument panel.

Engine code and engine number: stamped on left-hand side of engine on crankcase.

Coolant, brake fluid, oils

When topping up

- coolant,
- brake fluid,
- manual transmission oil,
- automatic transmission oil,
- power steering oil

we recommend that you consult your Vauxhall Authorised Repairer, who can advise you on the correct products to use.

Use of unsuitable fluids can cause serious damage to the vehicle.

Engine oils

Information on engine oils is found in the Service Booklet.

Engine data

| Sales designation Engine identifier code | 1.4 Z 14 XEP | 1.6 Z 16 XEP | 1.8 Z 18 XE | 1.8 Z 18 XER | 2.0 Turbo Z 20 LEL |
|--|--|--|--|--|--|
| Number of cylinders | 4 | 4 | 4 | 4 | 4 |
| Piston displacement (cm ³) | 1364 | 1598 | 1796 | 1796 | 1998 |
| Brake horse power (kW/bhp) at rpm | 66 5600 | 77 6000 | 92 5600 | 103 6300 | 125 5200 |
| Torque (Nm) at rpm | 125 4000 | 150 3900 | 170 3800 | 175 ¹⁾ 3800 | 250 1950 |
| Type of fuel | Petrol | Petrol | Petrol | Petrol | Petrol |
| Octane requirement (RON) ²⁾ unleaded or unleaded or unleaded | 95³⁾ 98 ³⁾ 91 ³⁾⁴⁾ | 95³⁾ 98 ³⁾ 91 ³⁾⁴⁾ | 95³⁾ 98 ³⁾ 91 ³⁾ | 95³⁾ 98 ³⁾ 91 ³⁾ | 95³⁾ 98 ³⁾ 91 ³⁾⁵⁾ |
| Max. permissible engine speed, continuous operation (rpm) approx. | 6200 | 6400 | 6800 | 6800 | 6400 |
| Oil consumption (l/1000 km) | 0.6 | 0.6 | 0.6 | 0.6 | 0.6 |

¹⁾ For versions with automatic transmission 170 Nm.

²⁾ Standard high-quality fuels, e.g. unleaded DIN EN 228; value printed in bold: recommended fuel.

³⁾ Knock control system automatically adjusts ignition timing according to type of fuel used (octane number).

⁴⁾ Use of 91 RON fuel reduces power and torque.

⁵⁾ If no unleaded Premium fuel is available, 91 RON can be used to avoid high engine load or full load as well as for driving in mountainous terrain with a caravan/trailer load or high payload.

Engine data

| Sales designation Engine identifier code | 2.0 Turbo Z 20 LER | VXR Z 20 LEH | 1.3 CDTI Z 13 DTH | 1.7 CDTI Z 17 DTH | 1.9 CDTI Z 19 DTL | 1.9 CDTI Z 19 DT | 1.9 CDTI Z 19 DTH |
|--|---|---|-----------------------------|-----------------------------|-----------------------------|-----------------------------|-----------------------------|
| Number of cylinders | 4 | 4 | 4 | 4 | 4 | 4 | 4 |
| Piston displacement (cm ³) | 1998 | 1998 | 1248 | 1686 | 1910 | 1910 | 1910 |
| Brake horse power (kW/bhp) at rpm | 147 5400 | 177 5600 | 66 4000 | 74 4400 | 74 3500 | 88 3500 | 110 4000 |
| Torque (Nm) at rpm | 262 4200 | 320 2400 to 5000 | 200 1750 to 2500 | 240 2300 | 260 1700 to 2500 | 280 2000 to 2750 | 320 2000 to 2750 |
| Type of fuel | Petrol | Petrol | Diesel | Diesel | Diesel | Diesel | Diesel |
| Octane requirement (RON) ¹⁾ unleaded or unleaded or unleaded | 95 ²⁾ 98 ²⁾ 91 ²⁾³⁾ | 95 ²⁾³⁾ 98 ²⁾ 91 ²⁾⁴⁾ | – – – | – – – | – – – | – – – | – – – |
| Cetane requirement (CN) ¹⁾ | | – | 49 (D) ⁵⁾ | 49 (D) ⁵⁾ | 49 (D) ⁵⁾ | 49 (D) ⁵⁾ | 49 (D) ⁵⁾ |
| Max. permissible engine speed, continuous operation (rpm) approx. | 6400 | 6400 | 5100 to 5300 | 5200 | 5200 | 5200 | 5200 |
| Oil consumption (l/1000 km) | 0.6 | 0.6 | 0.6 | 0.6 | 0.6 | 0.6 | 0.6 |

¹⁾ Standard high-quality fuels, e.g. unleaded DIN EN 228, Diesel DIN EN 590; D = Diesel; value printed in bold: recommended fuel.

²⁾ Knock control system automatically adjusts ignition timing according to type of fuel used (octane number).

³⁾ Use of 95 RON fuel reduces power and torque. Slight increase in fuel consumption.

⁴⁾ If no unleaded Premium fuel is available, 91 RON can be used to avoid high engine load or full load as well as for driving in mountainous terrain with a caravan/trailer load or high payload.

⁵⁾ A lower value is possible with winter diesel fuels.

Performance

(approx. mph / km/h), **5-door Hatchback**

| Engine¹⁾ | Z 14 XEP | Z 16 XEP | Z 18 XE | Z 18 XER | Z 20 LEL | Z 20 LER |
|-----------------------------|-----------------|-----------------|-----------------|-----------------|-----------------|-----------------|
| Maximum speed ²⁾ | | | | | | |
| Manual transmission | 111/178 | 115/185 | 123/198 | 129/208 | 135/217 | 143/230 |
| Easytronic | 110/176 | 115/185 | – | – | – | – |
| Automatic transmission | – | – | 117/188 | 117/188 | – | – |
| Engine¹⁾ | Z 13 DTH | Z 17 DTH | Z 19 DTL | Z 19 DT | Z 19 DTH | |
| Maximum speed ²⁾ | | | | | | |
| Manual transmission | 107/172 | 112/180 | 112/180 | 121/194 | 129/208 | |
| Easytronic | 107/172 | – | – | – | – | |
| Automatic transmission | – | – | – | 117/188 | – | |

¹⁾ Sales designation – see pages 314, 315.

²⁾ The maximum speed indicated is achievable at kerb weight (without driver) plus 200 kg payload. Optional equipment could reduce the specified maximum speed of the vehicle.

Performance

(approx. mph / km/h), **3-door Hatchback**

| Engine ¹⁾ | Z 14 XEP | Z 16 XEP | Z 18 XE | Z 18 XER | Z 20 LEL |
|-----------------------------|----------|----------|---------|----------|----------|
| Maximum speed ²⁾ | | | | | |
| Manual transmission | 112/180 | 116/187 | 124/200 | 130/210 | 137/220 |
| Easytronic | 111/178 | 187 | – | – | – |
| Automatic transmission | – | – | 118/190 | 118/190 | – |

| Engine ¹⁾ | Z 20 LER | Z 20 LEH | Z 13 DTH | Z 17 DTH | Z 19 DTL | Z 19 DT | Z 19 DTH |
|-----------------------------|----------|----------|----------|----------|----------|---------|----------|
| Maximum speed ²⁾ | | | | | | | |
| Manual transmission | 145/234 | 152/244 | 108/174 | 113/182 | 113/182 | 122/196 | 130/210 |
| Easytronic | – | – | 108/174 | – | – | – | – |
| Automatic transmission | – | – | – | – | – | 118/190 | – |

Performance

(approx. mph / km/h), **Van**

| Engine ¹⁾ | Z 14 XEP | Z 13 DTH | Z 17 DTH | Z 19 DTL | Z 19 DT | Z 19 DTH |
|-----------------------------|----------|----------|----------|----------|---------|----------|
| Maximum speed ²⁾ | | | | | | |
| Manual transmission | 111/178 | 107/172 | 112/180 | 112/180 | 120/193 | 129/207 |
| Easytronic | – | – | – | – | – | – |
| Automatic transmission | – | – | – | – | 116/187 | – |

¹⁾ Sales designation – see pages 314, 315.

²⁾ The maximum speed indicated is achievable at kerb weight (without driver) plus 200 kg payload. Optional equipment could reduce the specified maximum speed of the vehicle.

318 Technical Data

Performance

(approx. mph / km/h), **Estate**

| Engine ¹⁾ | Z 14 XEP | Z 16 XEP | Z 18 XE | Z 18 XER | Z 20 LEL |
|-----------------------------|----------|----------|----------|----------|----------|
| Maximum speed ²⁾ | | | | | |
| Manual transmission | 111/178 | 115/185 | 123/198 | 128/207 | 135/217 |
| Easytronic | – | 115/185 | – | – | – |
| Automatic transmission | – | – | 115/188 | 115/188 | – |
| Engine ¹⁾ | Z 13 DTH | Z 17 DTH | Z 19 DTL | Z 19 DT | Z 19 DTH |
| Maximum speed ²⁾ | | | | | |
| Manual transmission | 107/172 | 112/180 | 112/180 | 120/193 | 129/207 |
| Easytronic | 107/172 | – | – | – | – |
| Automatic transmission | – | – | – | 116/187 | – |

Performance

(approx. mph / km/h), **TwinTop**

| Engine | Z 16 XEP | Z 18 XER | Z 20 LEL | Z 20 LER | Z 19 DTH |
|-----------------------------|----------|----------|----------|----------|----------|
| Maximum speed ²⁾ | | | | | |
| Manual transmission | 116/186 | 129/209 | 139/224 | 147/237 | 132/213 |
| Easytronic | – | – | – | – | – |
| Automatic transmission | – | – | – | – | – |

¹⁾ Sales designation – see pages 314, 315.

²⁾ The maximum speed indicated is achievable at kerb weight (without driver) plus 200 kg payload. Optional equipment could reduce the specified maximum speed of the vehicle.

**Fuel consumption,
CO₂ emissions**

Directive 80/1268/EEC (last changed by 1999/100/EC) has applied for the measurement of fuel consumption since 1996.

The directive is oriented to actual driving practices: Urban driving is rated at approx. $\frac{1}{3}$ and off-road driving with approx. $\frac{2}{3}$ (urban and extra-urban consumption). Cold starts and acceleration phases are also taken into consideration.

The specification of CO₂ emission is also a constituent of the directive.

The figures given must not be taken as a guarantee for the actual fuel consumption of a particular vehicle.

All values are based on the EU base model with standard equipment.

The calculation of fuel consumption as specified by directive 1999/100/EC takes account of the vehicle's kerb weight, ascertained in accordance with these regulations. Optional extras may result in slightly higher fuel consumption and CO₂ emission levels than those quoted.

To convert l/100 km into mpg, divide 282 by number of litres/100 km.

Saving fuel, protecting the environment
– page 202.

320 Technical Data

Fuel consumption (approx. l/100 km) , **CO₂ emissions** (approx. g/km), **Hatch 5-door** (tyre width up to 205 mm¹⁾)

| Engine ²⁾ | Z 14 XEP | Z 16 XEP | Z 18 XE | Z 18 XER |
|--|------------|------------|-------------|------------|
| Manual/Easytronic/Automatic transmission | | | | |
| urban | 8,2/ 7,7/- | 8,6/ 8,5/- | 10,4/-/11,4 | 9,9/-/10,5 |
| extra-urban | 5,2/ 4,9/- | 5,4/ 5,3/- | 6,1/-/ 6,3 | 5,8/-/6,2 |
| total | 6,3/ 5,9/- | 6,6/ 6,5/- | 7,7/-/ 8,2 | 7,3/-/7,8 |
| CO ₂ | 151/142/- | 158/156/- | 185/-/197 | 175/-/187 |

| Engine ²⁾ | Z 20 LEL | Z 20 LER | Z 13 DTH | Z 17 DTH | Z 19 DTL | Z 19 DT | Z 19 DTH |
|--|----------|----------|-----------------------|----------|----------|---------|----------|
| Manual/Easytronic/Automatic transmission | | | | | | | |
| urban | -/-/- | -/-/- | 6,2/ ³⁾ /- | 6.4/-/- | -/-/- | -/-/- | -/-/- |
| extra-urban | -/-/- | -/-/- | 4,0/ ³⁾ /- | 4.2/-/- | -/-/- | -/-/- | -/-/- |
| total | -/-/- | -/-/- | 4,8/ ³⁾ /- | 5.0/-/- | -/-/- | -/-/- | -/-/- |
| CO ₂ | -/-/- | -/-/- | 130/ ³⁾ /- | 135/-/- | -/-/- | -/-/- | -/-/- |

Fuel consumption (approx. l/100 km), **CO₂ emissions** (approx. g/km), **Hatch 5-door** (tyre width up to 225 mm)

| Engine ²⁾ | Z 14 XEP | Z 16 XEP | Z 18 XE | Z 18 XER |
|--|------------|------------|-------------|-------------|
| Manual/Easytronic/Automatic transmission | | | | |
| urban | 8,4/ 7,9/- | 8,8/ 8,7/- | 10,6/-/11,6 | 10,1/-/10,7 |
| extra-urban | 5,4/ 5,1/- | 5,6/ 5,5/- | 6,3/-/ 6,5 | 6,0/-/ 6,4 |
| total | 6,5/ 6,1/- | 6,8/ 6,7/- | 7,9/-/ 8,4 | 7,5/-/ 8,0 |
| CO ₂ | 156/146/- | 163/161/- | 190/-/ 202 | 180/-/192 |

| Engine ²⁾ | Z 20 LEL | Z 20 LER | Z 13 DTH | Z 17 DTH | Z 19 DTL | Z 19 DT | Z 19 DTH |
|--|----------|----------|----------|----------|----------|------------|----------|
| Manual/Easytronic/Automatic transmission | | | | | | | |
| urban | 12.8/-/- | 13.1/-/- | -/-/- | 6.5/-/- | 7,7/-/- | 7,7/-/ 9,8 | 7.4/-/- |
| extra-urban | 6.8/-/- | 7.1/-/- | -/-/- | 4.3/-/- | 5,0/-/- | 5,0/-/ 5,5 | 4.9/-/- |
| total | 9.0/-/- | 9.3/-/- | -/-/- | 5.1/-/- | 6,0/-/- | 6,0/-/ 7,1 | 5.8/-/- |
| CO ₂ | 216/-/- | 223/-/- | -/-/- | 138/-/- | 162/-/- | 162/-/192 | 157/-/- |

¹⁾ For Z 17 DTH engine - tyre width up to 195 mm.

²⁾ Sales designation – see pages 314, 315.

³⁾ Values not available at time of printing.

Fuel consumption (approx. l/100 km) , **CO₂ emissions** (approx. g/km), **Hatch 3-door** (tyre width up to 205 mm¹⁾)

| Engine ²⁾ | Z 14 XEP | Z 16 XEP | Z 18 XE | Z 18 XER | Z 20 LEL | Z 20 LER | Z 20 LEH |
|---|------------|------------|-----------------------|------------|----------|----------|----------|
| Manual/Easytronic/Automatic transmission | | | | | | | |
| urban | 8,2/ 7,7/- | 8,6/ 8,5/- | 10,4/-/11,3 | 9,9/-/10,4 | -/-/- | -/-/- | -/-/- |
| extra-urban | 5,2/ 4,9/- | 5,4/ 5,3/- | 6,1/-/ 6,2 | 5,8/-/ 6,1 | -/-/- | -/-/- | -/-/- |
| total | 6,3/ 5,9/- | 6,6/ 6,5/- | 7,7/-/ 8,1 | 7,3/-/ 7,7 | -/-/- | -/-/- | -/-/- |
| CO ₂ | 151/142/- | 158/156/- | 185/-/194 | 175/-/185 | -/-/- | -/-/- | -/-/- |
| Engine ²⁾ | | | Z 13 DTH | Z 17 DTH | Z 19 DTL | Z 19 DT | Z 19 DTH |
| Manual /Easytronic/Automatic transmission | | | | | | | |
| urban | | | 6,2/ ³⁾ /- | 6,4/-/- | -/-/- | -/-/- | -/-/- |
| extra-urban | | | 4,0/ ³⁾ /- | 4,2/-/- | -/-/- | -/-/- | -/-/- |
| total | | | 4,8/ ³⁾ /- | 5,0/-/- | -/-/- | -/-/- | -/-/- |
| CO ₂ | | | 130/ ³⁾ /- | 135/-/- | -/-/- | -/-/- | -/-/- |

Fuel consumption (approx. l/100 km), **CO₂ emissions** (approx. g/km), **Hatch 3-door** (tyre width up to 225 mm⁴⁾)

| Engine ²⁾ | Z 14 XEP | Z 16 XEP | Z 18 XE | Z 18 XER | Z 20 LEL | Z 20 LER | Z 20 LEH |
|--|------------|------------|-------------|-------------|----------|------------|----------|
| Manual/Easytronic/Automatic transmission | | | | | | | |
| urban | 8,4/ 7,9/- | 8,8/ 8,7/- | 10,6/-/11,5 | 10,1/-/10,6 | 12,8/-/- | 13,1/-/- | 13,0/-/- |
| extra-urban | 5,4/ 5,1/- | 5,6/ 5,5/- | 6,3/-/ 6,4 | 6,0/-/ 6,3 | 6,8/-/- | 7,1/-/- | 7,0/-/- |
| total | 6,5/ 6,1/- | 6,8/ 6,7/- | 7,9/-/ 8,3 | 7,5/-/ 7,9 | 9,0/-/- | 9,3/-/- | 9,2/-/- |
| CO ₂ | 156/146/- | 163/161/- | 190/-/199 | 180/-/190 | 216/-/- | 223/-/- | 221/-/- |
| Engine ²⁾ | | | Z 13 DTH | Z 17 DTH | Z 19 DTL | Z 19 DT | Z 19 DTH |
| Manual/Easytronic/Automatic transmission | | | | | | | |
| urban | | | -/-/- | 6,5/-/- | 7,7/-/- | 7,7/-/ 9,7 | 7,4/-/- |
| extra-urban | | | -/-/- | 4,3/-/- | 5,0/-/- | 5,0/-/ 5,4 | 4,9/-/- |
| total | | | -/-/- | 5,1/-/- | 6,0/-/- | 6,0/-/ 7,0 | 5,8/-/- |
| CO ₂ | | | -/-/- | 138/-/- | 162/-/- | 162/-/189 | 157/-/- |

1) For Z 17 DTH engine - tyre width up to 195 mm.

2) Sales designation – see pages 314, 315.

3) Values not available at time of printing.

4) For Z 20 LEH engine - tyre width up to 235 mm.

Fuel consumption (approx. l/100 km) , **CO₂ emissions** (approx. g/km), **Estate** (tyre width up to 205 mm¹⁾)

| Engine ²⁾ | Z 14 XEP | Z 16 XEP | Z 18 XE | Z 18 XER | Z 20 LEL | |
|--|----------|-----------------------|-------------|-------------|----------|----------|
| Manual/Easytronic/Automatic transmission | | | | | | |
| urban | 8,2/-/- | 8,7/ 8,6/- | 10,5/-/11,4 | 10,0/-/10,5 | -/-/- | |
| extra-urban | 5,2/-/- | 5,5/ 5,4/- | 6,2/-/ 6,3 | 5,9/-/ 6,2 | -/-/- | |
| total | 6,3/-/- | 6,7/ 6,6/- | 7,8/-/ 8,2 | 7,4/-/ 7,8 | -/-/- | |
| CO ₂ | 151/-/- | 161/158/- | 187/-/197 | 178/-/187 | -/-/- | |
| Engine ²⁾ | Z 20 LER | Z 13 DTH | Z 17 DTH | Z 19 DTL | Z 19 DT | Z 19 DTH |
| Manual/Easytronic/Automatic transmission | | | | | | |
| urban | -/-/- | 6,2/ ³⁾ /- | 6.4/-/- | -/-/- | -/-/- | -/-/- |
| extra-urban | -/-/- | 4,0/ ³⁾ /- | 4.2/-/- | -/-/- | -/-/- | -/-/- |
| total | -/-/- | 4,8/ ³⁾ /- | 5.0/-/- | -/-/- | -/-/- | -/-/- |
| CO ₂ | -/-/- | 130/ ³⁾ /- | 135/-/- | -/-/- | -/-/- | -/-/- |

Fuel consumption (approx. l/100 km), **CO₂ emissions** (approx. g/km), **Estate** (tyre width up to 225 mm)

| Engine ²⁾ | Z 14 XEP | Z 16 XEP | Z 18 XE | Z 18 XER | Z 20 LEL | Z 20 LER |
|--|----------|------------|-------------|-------------|----------|----------|
| Manual/Easytronic/Automatic transmission | | | | | | |
| urban | 8.4/-/- | 8.9/ 8.8/- | 10,7/-/11,6 | 10,2/-/10,7 | 12.9/-/- | 13.2/-/- |
| extra-urban | 5.4/-/- | 5.7/ 5.6/- | 6,4/-/ 6,5 | 6,1/-/ 6,4 | 6.9/-/- | 7.2/-/- |
| total | 6.5/-/- | 6.9/ 6.8/- | 8,0/-/ 8,4 | 7,6/-/ 8,0 | 9.1/-/- | 9.4/-/- |
| CO ₂ | 156/-/- | 166/163/- | 192/-/202 | 182/-/192 | 218/-/- | 226/-/- |
| Engine ²⁾ | Z 13 DTH | Z 17 DTH | Z 19 DTL | Z 19 DT | Z 19 DTH | |
| Manual/Easytronic/Automatic transmission | | | | | | |
| urban | -/-/- | 6.5/-/- | 7,8/-/- | 7,8/-/ 9,8 | 7.5/-/- | |
| extra-urban | -/-/- | 4.3/-/- | 5,1/-/- | 5,1/-/ 5,5 | 5.0/-/- | |
| total | -/-/- | 5.1/-/- | 6,1/-/- | 6,1/-/ 7,1 | 5.9/-/- | |
| CO ₂ | -/-/- | 138/-/- | 165/-/- | 165/-/192 | 159/-/- | |

¹⁾ For Z 17 DTH engine - tyre width up to 195 mm.

²⁾ Sales designation – see pages 314, 315.

³⁾ Values not available at time of printing.

Fuel consumption (approx. l/100 km) , **CO₂ emissions** (approx. g/km) , **TwinTop** (tyre width up to 225 mm)

| Engine ¹⁾ | Z 16 XEP | Z 18 XER | Z 20 LEL | Z 20 LER | Z 19 DTH |
|--|----------|-----------------------|----------|----------|----------|
| Manual/Easytronic/Automatic transmission | | | | | |
| urban | 9,1/-/- | 10,3/-/ ²⁾ | 13,0/-/- | 13,3/-/- | 7,7/-/- |
| extra-urban | 5,8/-/- | 6,2/-/ ²⁾ | 7,0/-/- | 7,3/-/- | 5,2/-/- |
| total | 7,0/-/- | 7,7/-/ ²⁾ | 9,2/-/- | 9,5/-/- | 6,1/-/- |
| CO ₂ | 168/-/- | 185/-/ ²⁾ | 221/-/- | 228/-/- | 165/-/- |

Fuel consumption (approx. l/100 km) , **CO₂ emissions** (approx. g/km) , **Van** (tyre width up to 205 mm)

| Engine ¹⁾ | Z 14 XEP | Z 13 DTH | Z 17 DTH | Z 19 DTL | Z 19 DT | Z 19 DTH |
|--|----------|----------|----------|----------|---------|----------|
| Manual/Easytronic/Automatic transmission | | | | | | |
| urban | 8,0/-/- | 6.2/-/- | 6.4/-/- | -/-/- | -/-/- | -/-/- |
| extra-urban | 5,0/-/- | 4.0/-/- | 4.2/-/- | -/-/- | -/-/- | -/-/- |
| total | 6,1/-/- | 4.8/-/- | 5.0/-/- | -/-/- | -/-/- | -/-/- |
| CO ₂ | 146/-/- | 130/-/- | 135/-/- | -/-/- | -/-/- | -/-/- |

Fuel consumption (approx. l/100 km) , **CO₂ emissions** (approx. g/km) , **Van** (tyre width up to 225 mm)

| Engine ¹⁾ | Z 14 XEP | Z 13 DTH | Z 17 DTH | Z 19 DTL | Z 19 DT | Z 19 DTH |
|--|----------|----------|----------|----------|------------|----------|
| Manual/Easytronic/Automatic transmission | | | | | | |
| urban | 8,2/-/- | -/-/- | 6.5/-/- | 7,4/-/- | 7,4/-/ 9,7 | 7,4/-/- |
| extra-urban | 5,2/-/- | -/-/- | 4.3/-/- | 4,9/-/- | 4,9/-/ 5,4 | 4,9/-/- |
| total | 6,3/-/- | -/-/- | 5.1/-/- | 5,8/-/- | 5,8/-/ 7,0 | 5,8/-/- |
| CO ₂ | 151/-/- | -/-/- | 138/-/- | 157/-/- | 157/-/189 | 157/-/- |

¹⁾ Sales designation – see pages 314, 315.

²⁾ Values not available at time of printing.

Weight (kg), Table 1, kerb weight¹⁾, Hatch 5-door

| Model | Engine ²⁾ | Manual transmission | Easytronic | Automatic transmission |
|---|----------------------|---------------------|------------|------------------------|
| Astra | Z 14 XEP | 1230 | 1230 | – |
| | Z 16 XEP | 1265 | 1265 | – |
| | Z 18 XE, Z 18 XER | 1278 | – | 1310 |
| | Z 13 DTH | 1330 | 3) | – |
| | Z 17 DTH | 1365 | – | – |
| | Z 19 DT | 1395 | – | 1425 |
| | Z 19 DTH | 1393 | – | – |
| Astra with air conditioning system or climate control system | Z 14 XEP | 1250 | 1250 | – |
| | Z 16 XEP | 1285 | 1285 | – |
| | Z 18 XE, Z 18 XER | 1298 | – | 1330 |
| | Z 20 LEL | 1385 | – | – |
| | Z 20 LER | 1385 | – | – |
| | Z 13 DTH | 1345 | 3) | – |
| | Z 17 DTH | 1380 | – | – |
| | Z 19 DT | 1410 | – | 1440 |
| Z 19 DTH | 1408 | – | – | |

1) According to EC Directive, including assumed weights for driver (68 kg), luggage (7 kg) and all fluids (tank 90 % full).

2) Sales designation – see pages 314, 315.

3) Values not available at time of printing.

Weight (kg), Table 1, kerb weight ¹⁾, Hatch 3-door

| Model | Engine ²⁾ | Manual transmission | Easytronic | Automatic transmission |
|---|----------------------|---------------------|---------------|------------------------|
| Astra | Z 14 XEP | 1210 | – | – |
| | Z 16 XEP | 1245 | 1245 | – |
| | Z 18 XE, Z 18 XER | 1265 | – | 1278 |
| | Z 13 DTH | 1310 | ³⁾ | – |
| | Z 17 DTH | 1345 | – | – |
| | Z 19 DT, Z 19 DTL | 1370 | – | 1393 |
| | Z 19 DTH | 1390 | – | – |
| Astra with air conditioning system or climate control system | Z 14 XEP | 1230 | – | – |
| | Z 16 XEP | 1265 | 1265 | – |
| | Z 18 XE, Z 18 XER | 1285 | – | 1298 |
| | Z 20 LEL | 1365 | – | – |
| | Z 20 LER | 1365 | – | – |
| | Z 20 LEH | 1393 | – | – |
| | Z 13 DTH | 1325 | ³⁾ | – |
| | Z 17 DTH | 1360 | – | – |
| | Z 19 DT, Z 19 DTL | 1385 | – | 1408 |
| Z 19 DTH | 1405 | – | – | |

¹⁾ According to EC Directive, including assumed weights for driver (68 kg), luggage (7 kg) and all fluids (tank 90 % full).

²⁾ Sales designation, see pages 314, 315.

³⁾ Values not available at time of printing.

Weights (kg) : Table 1, Kerb weight ¹⁾, Estate

| Model | Engine ²⁾ | Manual transmission | Easytronic | Automatic transmission |
|---|----------------------|---------------------|---------------|------------------------|
| Astra | Z 14 XEP | 1280 | – | – |
| | Z 16 XEP | 1315 | 1315 | – |
| | Z 18 XE, Z 18 XER | 1325 | – | 1350 |
| | Z 13 DTH | 1380 | ³⁾ | – |
| | Z 17 DTH | 1393 | – | – |
| | Z 19 DT | 1435 | – | 1465 |
| | Z 19 DTH | 1450 | – | – |
| Astra with air conditioning system or climate control system | Z 14 XEP | 1300 | – | – |
| | Z 16 XEP | 1335 | 1335 | – |
| | Z 18 XE, Z 18 XER | 1345 | – | 1370 |
| | Z 20 LEL | 1425 | – | – |
| | Z 20 LER | 1425 | – | – |
| | Z 13 DTH | 1395 | ³⁾ | – |
| | Z 17 DTH | 1408 | – | – |
| | Z 19 DT | 1450 | – | 1480 |
| Z 19 DTH | 1465 | – | – | |

¹⁾ According to EC Directive, including assumed weights for driver (68 kg), luggage (7 kg) and all fluids (tank 90 % full).

²⁾ Sales designation, see pages 314, 315.

³⁾ Values not available at time of printing.

Weights (kg) : Table 1, Kerb weight ¹⁾, Van

| Model | Engine ²⁾ | Manual transmission | Easytronic | Automatic transmission |
|---|----------------------|---------------------|------------|------------------------|
| Astra | Z 14 XEP | 1235 | – | – |
| | Z 13 DTH | 1335 | – | – |
| | Z 17 DTH | 1365 | – | – |
| | Z 19 DT | 1385 | – | 1420 |
| | Z 19 DTL | 1385 | – | – |
| | Z 19 DTH | 1395 | – | – |
| Astra with air conditioning system or climate control system | Z 14 XEP | 1250 | – | – |
| | Z 13 DTH | 1350 | – | – |
| | Z 17 DTH | 1380 | – | – |
| | Z 19 DT | 1400 | – | 1435 |
| | Z 19 DTL | 1400 | – | – |
| | Z 19 DTH | 1410 | – | – |

¹⁾ According to EC Directive, including assumed weights for driver (68 kg), luggage (7 kg) and all fluids (tank 90 % full).

²⁾ Sales designation, see pages 314, 315.

Weights (kg) : Table 1, Kerb weight ¹⁾, TwinTop

| Model | Engine ²⁾ | Manual transmission | Easytronic | Automatic transmission |
|---|----------------------|---------------------|------------|------------------------|
| Astra | Z 16 XEP | 1495 | – | – |
| | Z 18 XER | 1500 | – | – |
| | Z 19 DTH | 1613 | – | – |
| Astra with air conditioning system or climate control system | Z 16 XEP | 1515 | – | – |
| | Z 18 XER | 1520 | – | – |
| | Z 20 LEL | 1605 | – | – |
| | Z 20 LER | 1605 | – | – |
| | Z 19 DTH | 1628 | – | – |

¹⁾ According to EC Directive, including assumed weights for driver (68 kg), luggage (7 kg) and all fluids (tank 90 % full).

²⁾ Sales designation, see pages 314, 315.

Weights (kg), Table 2, Additional weight of equipment versions**Hatch**

| Engine¹⁾ | Z 14 XEL | Z 14 XEP | Z 16 XEP | Z 18 XE | Z 18 XER | Z 20 LEL |
|----------------------------|-----------------|-----------------|-----------------|----------------|-----------------|-----------------|
| Club | 2.9 | 2.9 | 2.9 | 2.9 | 2.9 | – |
| Design | 12 | 12 | 12 | 12 | 12 | 12 |
| SXi, SRi | 24.5 | 24.5 | 24.5 | 24.5 | 24.5 | 12.6 |

| Engine¹⁾ | Z 20 LER | Z 20 LEH | Z 13 DTH | Z 17 DTH | Z 19 DTL | Z 19 DT | Z 19 DTH |
|----------------------------|-----------------|-----------------|-----------------|-----------------|-----------------|----------------|-----------------|
| Club | – | – | 2.9 | 2.9 | 2.9 | 2.9 | 2.9 |
| Design | – | – | 12 | 12 | 12 | 12 | 12 |
| SXi, SRi | 12.6 | – | 24.5 | 24.5 | 12.6 | 12.6 | 12.6 |

¹⁾ Sales designation – see pages 314, 315.

Weights (kg) : Table 2, Additional weight of equipment versions
Estate

| Engine¹⁾ | Z 14 XEL | Z 14 XEP | Z 16 XEP | Z 18 XE | Z 18 XER | Z 20 LEL |
|----------------------------|-----------------|-----------------|-----------------|----------------|-----------------|-----------------|
| Club | 2.9 | 2.9 | 2.9 | 2.9 | 2.9 | 2.9 |
| Design | 12 | 12 | 12 | 12 | 12 | 12 |
| SXi, SRi | 24.5 | 24.5 | 24.5 | 24.5 | 24.5 | 12.6 |

| Engine¹⁾ | Z 20 LER | Z 13 DTH | Z 17 DTH | Z 19 DTL | Z 19 DT | Z 19 DTH |
|----------------------------|-----------------|-----------------|-----------------|-----------------|----------------|-----------------|
| Club | – | 2.9 | 2.9 | 2.9 | 2.9 | 2.9 |
| Design | – | 12 | 12 | 12 | 12 | 12 |
| SXi, SRi | 12.6 | 24.5 | 24.5 | 12.6 | 12.6 | 24.5 |

Weights (kg), Table 2, Additional weight of equipment versions
Van

| Engine¹⁾ | Z 14 XEP | Z 13 DTH | Z 17 DTH | Z 19 DTL | Z 19 DT | Z 19 DTH |
|----------------------------|-----------------|-----------------|-----------------|-----------------|----------------|-----------------|
| Club | – | – | – | – | – | – |
| Design | – | – | – | – | – | – |
| SXi, SRi | 24.5 | 24.5 | 24.5 | 12.6 | 12.6 | 24.5 |

¹⁾ Sales designation – see pages 314, 315.

Weights (kg), Table 3, Heavy accessories

| Accessories | Sun roof | Towing equipment | Split rear seat bench |
|--------------------|--|--|--|
| Weight | 25 (Hatch 5-door, Estate) 23 (Hatch 3-door) | 22 (Hatch 5-door, Estate) 20 (Hatch 3-door) 21 (Van) | 10 (Hatch 5-door) 20 (Estate) 9 (Hatch 3-door) |

Tyres

Not all tyres available on the market currently meet the structural requirements. We recommend that you consult a Vauxhall Authorised Repairer concerning suitable tyre makes.

These tyres have undergone special tests to establish their reliability, safety and specific suitability for Vauxhall vehicles. Despite continuous market monitoring, we are unable to assess these attributes for other tyres, even if they have been granted approval by the relevant authorities or in some other form.

Further information – page 230.

Winter tyres *

Tyres of size 215/45 R 17, 225/45 R 17, 225/40 R 18 or 235/35 R 19 are not to be used as winter tyres. Tyres of size 225/45 R 17 may be used as winter tyres on the Astra TwinTop.

If you use winter tyres *, the spare wheel may still be fitted with a summer tyre. If you use the spare wheel the vehicle's handling may be altered. Obtain a replacement for the faulty tyre as soon as possible, and have the wheel balanced and fitted to the vehicle.

Further information – page 236.

Tyre chains *

Tyre chains may be used on the front wheels only.

We recommend the use of Vauxhall-tested fine-mesh tyre chains that add no more than 10 mm to the tyre tread and the inboard sides (including chain lock).

Tyre chains are not permitted on temporary spare wheel 115/70 R 16 or on tyres of size 225/45 R 17, 225/40 R 18 or 235/35 R 19. Tyre chains are permitted on tyres of size 225/45 R 17 for the Astra TwinTop.

Tyre chains are permitted on tyres size 215/45 R 17 only if the vehicle is factory-fitted with 18" wheels.

Further information – page 236.

Wheels

Wheel bolt tightening torque: 110 Nm.

Spare wheel *

Depending on the version, the spare wheel may take the form of a temporary spare wheel *: vehicle driveability may be altered by use of the spare wheel. Obtain a replacement for the faulty tyre as soon as possible, and have the wheel balanced and fitted to the vehicle.

On vehicles with alloy wheels * the spare wheel may have a steel rim.

The spare wheel may be fitted with a smaller tyre ¹⁾ and smaller wheel than the wheels fitted to the vehicle.

Tyre pressure in bar / psi²⁾

The specified tyre pressures are valid for cold tyres. The increased tyre pressure resulting from extensive driving must not be reduced. The tyre pressures specified on the following pages apply to both summer and winter tyres.

Always inflate the spare wheel * to the tyre pressure for full load - see tables on following pages.

Temporary spare wheel * tyre pressure - see tables on next page.

In vehicles with tyre pressure monitoring system * there is an adapter in the valve cap key. Screw adapter to valve before attaching tyre pressure gauge – page 232.

Further information – pages 230 to 237.

¹⁾ Country-specific version: The spare wheel is only to be used as a temporary spare wheel.

²⁾ 1 bar corresponds to 100 kPa / 14.5 psi.

334 Technical Data

(ctd.)
Tyre pressure in bar / psi¹⁾

| Hatch | | Tyre pressure for load of up to 3 persons | | Tyre pressure ECO ²⁾ loaded up to 3 people | | Tyre pressure for full load | |
|-----------------------------------|--|---|--------|---|--------|-----------------------------|--------|
| Engine ³⁾ | Tyres – | Front | Rear | Front | Rear | Front | Rear |
| Z 14 XEP, Z 16 XEP, Z 18 XE | 185/65 R 15, 195/60 R 15 | 2.3/33 | 2.1/30 | – | – | 2.5/36 | 2.9/42 |
| | 195/65 R 15, 205/55 R 16, 225/45 R 17 | 1.9/28 | 1.9/28 | 2.4/35 | 2.4/35 | 2.0/29 | 2.5/36 |
| | 215/45 R 17, 225/40 R 18 | 2.5/36 | 2.3/33 | – | – | 2.5/36 | 2.9/42 |
| Z 18 XER | 185/65 R 15, 195/60 R 15 | 2.3/33 | 2.1/30 | – | – | 2.5/36 | 2.9/42 |
| | 195/65 R 15, 205/55 R 16, 225/45 R 17 | 1.9/28 | 1.9/28 | 2.4/35 | 2.4/35 | 2.0/29 | 2.5/36 |
| Z 20 LEL | 195/65 R 15, 205/55 R 16, 225/45 R 17 | 2.3/33 | 2.1/30 | 2.7/39 | 2.5/36 | 2.5/36 | 2.9/42 |
| | 215/45 R 17, 225/40 R 18 | 2.5/36 | 2.3/33 | – | – | 2.6/38 | 3.0/44 |
| all | T 115/70 R 16 (temporary spare) ⁴⁾ | 4.2/61 | 4.2/61 | – | – | 4.2/61 | 4.2/61 |

¹⁾ 1 bar corresponds to 100 kPa / 14.5 psi.

²⁾ To achieve the smallest amount of fuel consumption possible. Not for use with run-flat tyres.

³⁾ Sales designation – see pages 314, 315.

⁴⁾ For notes on the temporary spare wheel – see page 255.

(ctd.)
Tyre pressure in bar / psi¹⁾

| Engine ³⁾ | Tyres – | Hatch | | Tyre pressure for load of up to 3 persons | | Tyre pressure ECO ²⁾ loaded up to 3 people | | Tyre pressure for full load | |
|----------------------|---|--------|--------|---|--------|---|--------|-----------------------------|------|
| | | Front | Rear | Front | Rear | Front | Rear | Front | Rear |
| Z 20 LER | 195/65 R15, 205/55 R 16, 225/45 R 17 | 2.3/33 | 2.1/30 | 2.7/39 | 2.5/36 | 2.5/36 | 2.9/42 | | |
| | 215/45 R 17, 225/40 R 18 | 2.6/38 | 2.4/35 | – | – | 2.7/39 | 3.1/45 | | |
| Z 20 LEH | 205/50 R 17, 225/40 R 18, 235/35 R 19, 225/45 R 17 ⁴⁾ | 2.4/35 | 2.4/35 | – | – | 2.5/36 | 2.9/42 | | |
| all | T 115/70 R 16 (temporary spare) ⁵⁾ | 4.2/61 | 4.2/61 | – | – | 4.2/61 | 4.2/61 | | |

²⁾ To achieve the smallest amount of fuel consumption possible. Not for use with run-flat tyres.
³⁾ Sales designation – see pages 314, 315.
⁴⁾ To guarantee a correct speed display, the electronic speedometer must be reprogrammed.
⁵⁾ For notes on the temporary spare wheel, see page 255.

¹⁾ 1 bar corresponds to 100 kPa / 14.5 psi.

(ctd.)
Tyre pressure in bar / psi¹⁾

| Hatch | | Tyre pressure for load of up to 3 persons | | Tyre pressure ECO ²⁾ loaded up to 3 people | | Tyre pressure for full load | |
|-----------------------------------|--|---|--------|---|--------|-----------------------------|--------|
| Engine ³⁾ | Tyres – | Front | Rear | Front | Rear | Front | Rear |
| Z 13 DTH | 185/65 R 15, 195/60 R 15 | 2.3/33 | 2.1/30 | – | – | 2.5/36 | 2.9/42 |
| | 195/65 R 15, 205/55 R 16 | 2.1/30 | 2.1/30 | 2.5/36 | 2.5/36 | 2.5/36 | 2.9/42 |
| Z 17 DTH | 195/65 R 15, 205/55 R 16, 225/45 R 17 | 2.1/30 | 2.1/30 | 2.5/36 | 2.5/36 | 2.5/36 | 2.9/42 |
| | 215/45 R 17, 225/40 R 18 | 2.5/36 | 2.3/33 | – | – | 2.6/38 | 3.0/44 |
| Z 19 DTL, Z 19 DT, Z 19 DTH | 205/55 R 16, 225/45 R 17 | 2.3/33 | 2.1/30 | 2.7/39 | 2.5/36 | 2.5/36 | 2.9/42 |
| | 215/45 R 17, 225/40 R 18 | 2.6/38 | 2.4/35 | – | – | 2.7/39 | 3.1/45 |
| all | T 115/70 R 16 (temporary spare) ⁴⁾ | 4.2/61 | 4.2/61 | – | – | 4.2/61 | 4.2/61 |

2) To achieve the smallest amount of fuel consumption possible. Not for use with run-flat tyres.

3) Sales designation – see pages 314, 315.

4) Notes on the temporary spare wheel – see page 255.

¹⁾ 1 bar corresponds to 100 kPa / 14.5 psi.

(ctd.)
Tyre pressure in bar / psi¹⁾

| Estate | | Tyre pressure for load of up to 3 persons | | Tyre pressure ECO ²⁾ loaded up to 3 people | | Tyre pressure for full load | |
|-----------------------------------|---|---|--------|---|--------|-----------------------------|--------|
| | | Front | Rear | Front | Rear | Front | Rear |
| Engine ³⁾ | Tyres – | | | | | | |
| Z 14 XEP, Z 16 XEP, Z 18 XE | 195/65 R 15, 205/55 R 16, 225/45 R 17 | 2.0/29 | 2.0/29 | 2.5/36 | 2.5/36 | 2.1/30 | 2.6/38 |
| | 185/65 R 15, 195/60 R 15, 215/45 R 17, 225/40 R 18 | 2.3/33 | 2.1/30 | – | – | 2.5/36 | 2.9/42 |
| Z 14 XEL, Z 18 XER | 195/65 R 15, 205/55 R 16, 225/45 R 17 | 2.0/29 | 2.0/29 | 2.5/36 | 2.5/36 | 2.1/30 | 2.6/38 |
| | 185/65 R 15, 195/60 R 15 | 2.3/33 | 2.1/30 | – | – | 2.5/36 | 2.9/42 |
| all | T 115/70 R 16 (temporary spare) ⁴⁾ | 4.2/61 | 4.2/61 | – | – | 4.2/61 | 4.2/61 |

²⁾ To achieve the smallest amount of fuel consumption possible. Not for use with run-flat tyres.

³⁾ Sales designation – see pages 314, 315.

⁴⁾ For notes on the temporary spare wheel – see page 255.

¹⁾ 1 bar corresponds to 100 kPa / 14.5 psi.

(ctd.)
Tyre pressure in bar / psi¹⁾

| Estate | | Tyre pressure for load of up to 3 persons | | Tyre pressure ECO ²⁾ loaded up to 3 people | | Tyre pressure for full load | |
|----------------------|--|---|--------|---|--------|-----------------------------|--------|
| Engine ³⁾ | Tyres – | Front | Rear | Front | Rear | Front | Rear |
| Z 20 LEL | 205/55 R 16, 225/45 R 17 | 2.3/33 | 2.1/30 | 2.7/39 | 2.5/36 | 2.5/36 | 2.9/42 |
| | 215/45 R 17, 225/40 R 18 | 2.5/36 | 2.3/33 | – | – | 2.6/38 | 3.0/44 |
| Z 20 LER | 205/55 R 16, 225/45 R 17 | 2.3/33 | 2.1/30 | 2.7/39 | 2.5/36 | 2.5/36 | 2.9/42 |
| | 215/45 R 17, 225/40 R 18 | 2.7/39 | 2.5/36 | – | – | 2.8/41 | 3.1/45 |
| Z 13 DTH | 195/65 R 15, 205/55 R 16 | 2.1/30 | 2.1/30 | 2.5/36 | 2.5/36 | 2.5/36 | 2.9/42 |
| | 185/65 R 15, 195/60 R 15 | 2.3/33 | 2.1/30 | – | – | 2.5/36 | 2.9/42 |
| all | T 115/70 R 16 (temporary spare) ⁴⁾ | 4.2/61 | 4.2/61 | – | – | 4.2/61 | 4.2/61 |

¹⁾ 1 bar corresponds to 100 kPa / 14.5 psi.

²⁾ To achieve the smallest amount of fuel consumption possible. Not for use with run-flat tyres.

³⁾ Sales designation – see pages 314, 315.

⁴⁾ For notes on the temporary spare wheel – see page 255.

(ctd.)
Tyre pressure in bar / psi¹⁾

| Estate | | Tyre pressure for load of up to 3 persons | | Tyre pressure ECO ²⁾ loaded up to 3 people | | Tyre pressure for full load | |
|-----------------------------------|--|---|--------|---|--------|-----------------------------|--------|
| Engine ³⁾ | Tyres – | Front | Rear | Front | Rear | Front | Rear |
| Z 17 DTH | 195/65 R 15, 205/55 R 16, 225/45 R 17 | 2.1/30 | 2.1/30 | 2.5/36 | 2.5/36 | 2.5/36 | 2.9/42 |
| | 215/45 R 17, 225/40 R 18 | 2.5/36 | 2.3/33 | – | – | 2.6/38 | 3.0/44 |
| Z 19 DTL, Z 19 DT, Z 19 DTH | 205/55 R 16, 225/45 R 17 | 2.3/33 | 2.1/30 | 2.7/39 | 2.5/36 | 2.5/36 | 2.9/42 |
| | 215/45 R 17, 225/40 R 18 | 2.7/39 | 2.5/36 | – | – | 2.8/41 | 3.1/45 |
| all | T 115/70 R 16 (temporary spare) ⁴⁾ | 4.2/61 | 4.2/61 | – | – | 4.2/61 | 4.2/61 |

¹⁾ 1 bar corresponds to 100 kPa / 14.5 psi.

²⁾ To achieve the smallest amount of fuel consumption possible. Not for use with run-flat tyres.

³⁾ Sales designation – see pages 314, 315.

⁴⁾ For notes on the temporary spare wheel – see page 255.

(ctd.)
Tyre pressure in bar / psi¹⁾

| Van | | Tyre pressure for load of up to 2 persons | | Tyre pressure ECO ²⁾ loaded up to 2 people | | Tyre pressure for full load | |
|-----------------------------------|---|---|--------|---|--------|-----------------------------|--------|
| Engine ³⁾ | Tyres – | Front | Rear | Front | Rear | Front | Rear |
| Z 14 XEP | 195/65 R 15, 205/55 R 16, 225/45 R 17 | 2.0/29 | 2.0/29 | 2.5/36 | 2.5/36 | 2.1/30 | 2.6/38 |
| | 185/65 R 15, 195/60 R 15, 215/45 R 17, 225/40 R 18 | 2.3/33 | 2.1/30 | – | – | 2.5/36 | 2.9/42 |
| Z 13 DTH | 195/65 R 15, 205/55 R 16 | 2.1/30 | 2.1/30 | 2.5/36 | 2.5/36 | 2.5/36 | 2.9/42 |
| | 185/65 R 15, 195/60 R 15 | 2.3/33 | 2.1/30 | – | – | 2.5/36 | 2.9/42 |
| Z 17 DTH | 195/65 R 15, 205/55 R 16, 225/45 R 17 | 2.1/30 | 2.1/30 | 2.5/36 | 2.5/36 | 2.5/36 | 2.9/42 |
| | 215/45 R 17, 225/40 R 18 | 2.5/36 | 2.3/33 | – | – | 2.6/38 | 3.0/44 |
| Z 19 DTL, Z 19 DT, Z 19 DTH | 205/55 R 16, 225/45 R 17 | 2.3/33 | 2.1/30 | 2.7/39 | 2.5/36 | 2.5/36 | 2.9/42 |
| | 215/45 R 17, 225/40 R 18 | 2.7/39 | 2.5/36 | – | – | 2.8/41 | 3.1/45 |
| all | T 115/70 R 16 (temporary spare) ⁴⁾ | 4.2/61 | 4.2/61 | – | – | 4.2/61 | 4.2/61 |

²⁾ To achieve the smallest amount of fuel consumption possible. Not for use with run-flat tyres.

³⁾ Sales designation – see pages 314, 315.

⁴⁾ For notes on the temporary spare wheel – see page 255.

¹⁾ 1 bar corresponds to 100 kPa / 14.5 psi.

(ctd.)
Tyre pressure in bar / psi¹⁾

| TwinTop | | Tyre pressure for load of up to 3 persons | | Tyre pressure ECO ²⁾ loaded up to 3 people | | Tyre pressure for full load | |
|-----------------------|--|---|--------|---|--------|-----------------------------|--------|
| Engine ³⁾ | Tyres – | Front | Rear | Front | Rear | Front | Rear |
| Z 16 XEP, Z 18 XER | 205/55 R 16, 225/45 R 17 | 2.1/30 | 2.1/30 | 2.5/36 | 2.5/36 | 2,2/32 | 2.6/38 |
| | 225/40 R 18 | 2.3/33 | 2.1/30 | – | – | 2.4/35 | 2.8/41 |
| Z 20 LEL | 205/55 R 16, 225/45 R 17 | 2.3/33 | 2.1/30 | – | – | 2.4/35 | 2.8/41 |
| | 225/40 R 18 | 2.5/36 | 2.3/33 | – | – | 2.6/38 | 3.0/44 |
| Z 20 LER | 205/55 R 16, 225/45 R 17 | 2.5/36 | 2.3/33 | – | – | 2.6/38 | 3.0/44 |
| | 225/40 R 18 | 2.6/38 | 2.4/35 | – | – | 2.7/39 | 3.1/45 |
| Z 19 DTH | 205/55 R 16, 225/45 R 17 | 2.3/33 | 2.1/30 | – | – | 2.4/35 | 2.8/41 |
| | 225/40 R 18 | 2.5/36 | 2.3/33 | – | – | 2.6/38 | 3.0/44 |
| all | T 115/70 R 16 (temporary spare) ⁴⁾ | 4.2/61 | 4.2/61 | – | – | 4.2/61 | 4.2/61 |

²⁾ To achieve the smallest amount of fuel consumption possible. Not for use with run-flat tyres.

³⁾ Sales designation – see pages 314, 315.

⁴⁾ For notes on the temporary spare wheel – see page 255.

¹⁾ 1 bar corresponds to 100 kPa / 14.5 psi.

Electrical system

| | | |
|---------|-----------|--|
| Battery | Voltage | 12 Volt |
| | Amp hours | 36 Ah / 44 Ah * / 55 Ah * / 60 Ah * / 66 Ah * / 70 Ah * |

| | |
|---|----------|
| Battery for radio remote control of central locking system and electronic key of Open&Start system | CR 20 32 |
|---|----------|

Capacities

(approx. litre)

| Engine ¹⁾ | Z 14 XEL | Z 14 XEP | Z 16 XEP | Z 18 XE | Z 18 XER | Z 20 LEL | Z 20 LER |
|--|------------|------------|------------|------------|------------|-------------|-------------|
| Fuel tank (nominal content) | 52 | 52 | 52 | 52 | 52 | 52 | 52 |
| Engine oil with filter change between MIN and MAX on dipstick | 3.5 1.0 | 3.5 1.0 | 4.5 1.0 | 4.5 1.0 | 4.5 1.0 | 4.25 1.0 | 4.25 1.0 |
| Wash fluid reservoir for windscreen wash systemwith headlight wash system | 2.4 4.0 | 2.4 4.0 | 2.4 4.0 | 2.4 4.0 | 2.4 4.0 | 2.4 4.0 | 2.4 4.0 |

¹⁾ Sales designation – see pages 314, 315.

Capacities

(approx. litre)

| Engine ¹⁾ | Z 20 LEH | Z 13 DTH | Z 17 DTH | Z 19 DTL | Z 19 DT | Z 19 DTH |
|--|------------|------------|------------|------------|------------|------------|
| Fuel tank (nominal content) | 52 | 52 | 52 | 52 | 52 | 52 |
| Engine oil with filter change between MIN and MAX on dipstick | 5.0 1.0 | 3.2 1.0 | 5.0 1.0 | 4,3 0,7 | 4,3 0,7 | 4,3 0,7 |
| Wash fluid reservoir for windscreen wash systemwith headlight wash system | 2.4 4.0 | 2.4 4.0 | 2.4 4.0 | 2.4 4.0 | 2.4 4.0 | 2.4 4.0 |

¹⁾ Sales designation – see pages 314, 315.

344 Technical Data

Dimensions

(approx. mm)

| | Hatch 5-door | Hatch 3-door | Estate | Van | TwinTop |
|---------------------------------------|--------------|--------------|--------|-------|---------|
| Overall length | 4249 | 4290 | 4515 | 4515 | 4476 |
| Width | 1753 | 1753 | 1753 | 1753 | 1759 |
| Width with two exterior mirrors | 2033 | 2033 | 2033 | 2033 | 2039 |
| Overall height | 1460 | 1435 | 1500 | 1500 | 1411 |
| Wheelbase | 2614 | 2614 | 2703 | 2703 | 2614 |
| Turning circle diameter ¹⁾ | 11.20 | 11.20 | 11.50 | 11.50 | 11.20 |

¹⁾ In metres.

Installation dimensions of trailer towing equipment with detachable coupling ball bar, Hatch¹⁾

All dimensions refer to factory-fitted towing equipment.

| Dimension | mm |
|-----------|-------|
| A | 342.9 |
| B | 83 |
| C | 513.4 |
| D | 488.6 |
| E | 211.4 |
| F | 94.3 |
| G | 160 |

Warning

Only use towing equipment approved for your vehicle. We recommend entrusting retrofitting of towing equipment to your Vauxhall Authorised Repairer.

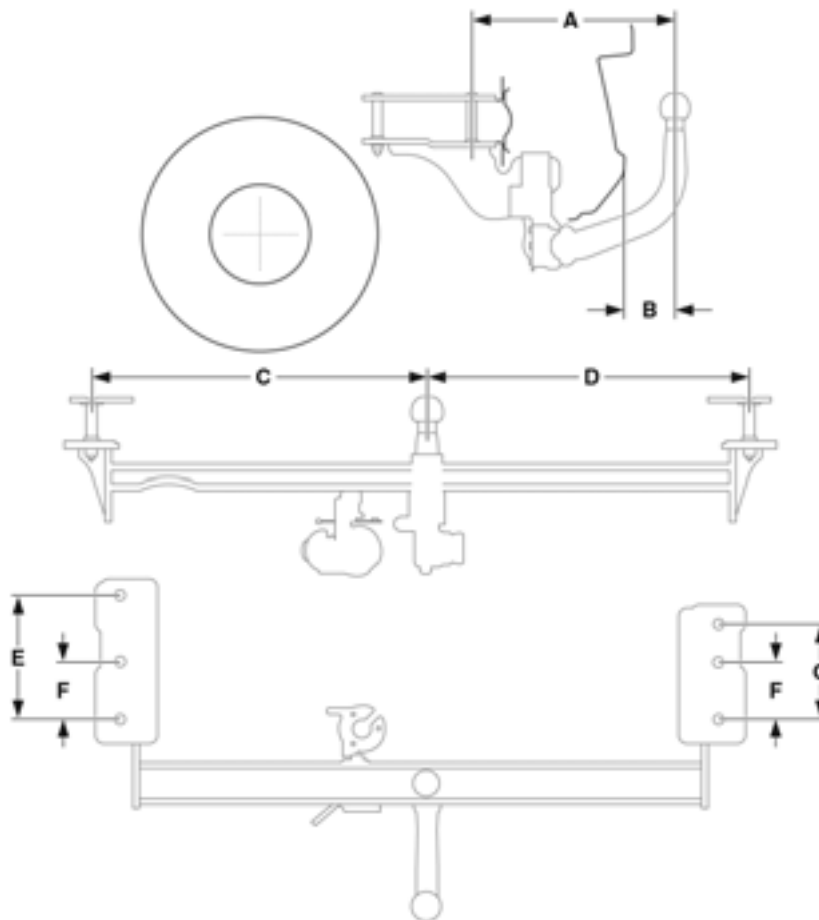

¹⁾ Do not mount towing equipment to vehicles with Z 20 LEH engine. Sales designation – page 314.

Installation dimensions of trailer towing equipment with detachable coupling ball bar, Estate, Van

All dimensions refer to factory-fitted towing equipment.

| Dimension | mm |
|-----------|-------|
| A | 84.0 |
| B | 570.0 |
| C | 515.0 |
| D | 93.5 |
| E | 173.0 |
| F | 307.6 |
| G | 158.0 |
| H | 292.6 |

Warning

Only use towing equipment approved for your vehicle. We recommend entrusting retrofitting of towing equipment to your Vauxhall Authorised Repairer.

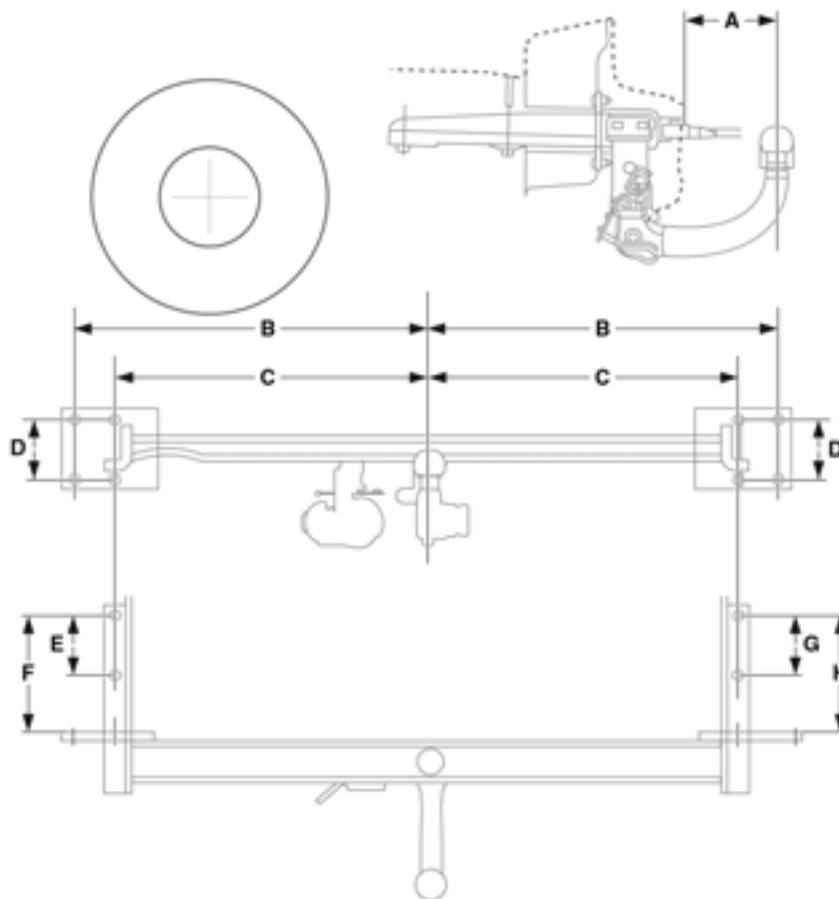

Installation dimensions of trailer towing equipment with detachable coupling ball bar, Astra TwinTop

All measurements refer to Vauxhall-approved towing equipment.

| Dimension | mm |
|-----------|-------|
| A | 68,8 |
| B | 570,0 |
| C | 515,0 |
| D | 485,0 |
| E | 93,5 |
| F | 288,0 |
| G | 245,0 |

Warning

Only use towing equipment approved for your vehicle. We recommend entrusting retrofitting of towing equipment to your Vauxhall Authorised Repairer.

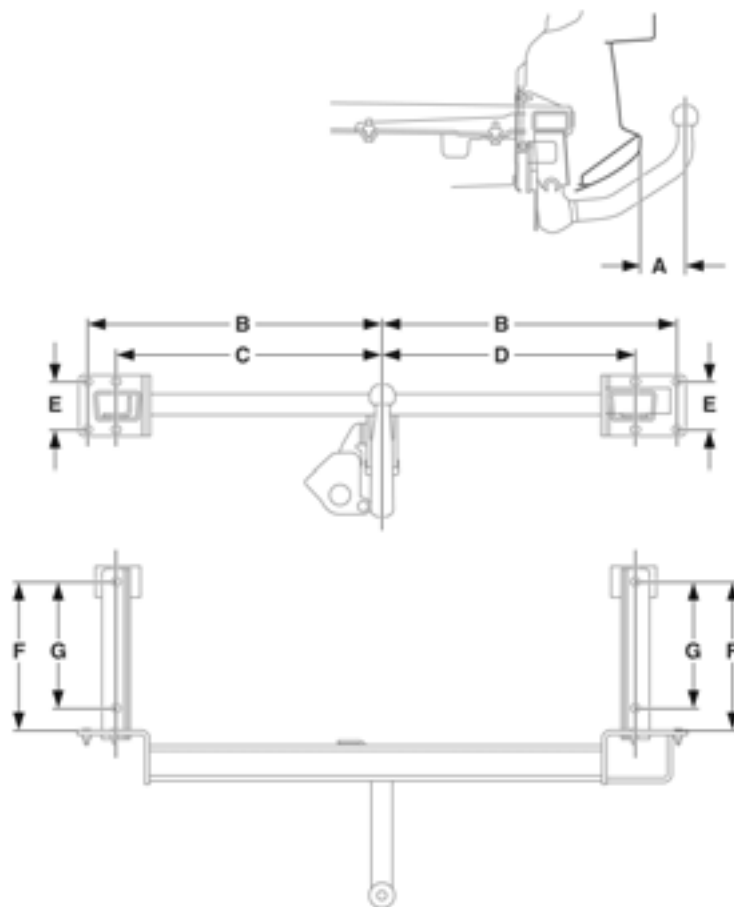

Index

A

ABS (Anti-lock Brake System) 228
 Accessories 130, 135, 252
 Accessory socket 107
 Adaptive Forward Lighting (AFL) 139
 Driving abroad 142
 Air conditioning system 157, 164
 Air intake 177
 Air quality sensor 172
 Air recirculation system 164, 168, 176
 Air vents 159
 Alarm system 83
 Alternator 39
 Antenna 64, 309
 Antifreeze 300
 Antifreeze protection 300, 305
 Anti-knock quality of fuel 204
 Octane number 314, 315
 Anti-theft locking system 77
 Towing equipment 241
 Anti-theft protection 24
 Aquaplaning 234
 Armrest 90, 91, 110
 Ashtray 108, 142
 Automatic
 Anti-dazzle interior mirror 134
 Automatic air recirculation mode 172, 176
 Automatic transmission . 20, 21, 186, 192
 automatic mode 187, 193
 Control indicator 188, 195
 Driving programme 188, 195

Fault 190, 198
 Interruption of power supply.. 191, 199
 Kickdown 189, 196
 manual mode 194
 Selector lever..... 20, 21, 187, 193, 194
 Winter programme 189, 196
 Automatic wiping 17

B

Battery 201, 306, 342
 Interruption of
 power supply 145, 185, 191, 199
 Battery discharge protection 142
 Before starting off 22
 Belt force limiters 112
 Belt tensioners 113
 Bleeding, diesel fuel system 247
 Board information display 46
 Bonnet 86
 Boot, see Luggage compartment .. 81, 91
 Brake assist 226
 Brake light 226
 Brake system 38
 Brakes 226
 ABS 228
 Brake assist 226
 Brake fluid 302
 Brake lights 282
 Brake lights 288
 Brake servo unit 200
 Foot brake 226
 Hand brake 227
 Bulb replacement 272, 274
 Bulbs 135, 272, 274

C

Capacities 343
 Car Pass 2, 66
 Caravan/trailer towing 200, 238
 Care 308
 Cargo box 103
 Catalytic converter 207, 211, 247
 CDC
 (Continuous Damping Control)... 39, 214
 Central locking system 76
 Changing the battery
 Radio remote control 69, 75, 342
 Changing tyre/wheel type 230
 Changing wheels 257
 Chassis number,
 see vehicle identification number 313
 Check control 30, 62
 Child restraint system 130, 135
 Child safety locks 86, 144
 Cigarette lighter 107, 142
 Climate control 157
 Climate control system 158, 171
 Clock 44
 Clutch operation 201
 CO2 emissions 319
 Code numbers 2
 Cold start 201
 Colour information display 46
 Continuous Damping Control 39, 214
 Continuous Damping Control
 (CDC) 39, 214
 Contrast 57

- Control indicator
 ABS (Anti-lock Brake System) 229
 Airbag 123, 132
 Engine electronics 210
 Exhaust 209
 Immobiliser 67
 Parking distance sensor 219
 Transmission 188, 195
 Tyre pressure monitoring system ... 224
- Control indicators 10, 37
 Adaptive Forward Lighting 42
 Adaptive Forward Lighting (AFL) .. 139
 Belt tensioners..... 113
 Brake system 228
 Cruise control..... 216
 DDS 221
 Deflation detection system 221
 ESP (Electronic Stability Program) .. 212
 IDS+ 214, 215
- Coolant 300
 Coolant level 301
 Coolant temperature 39
 Cooled glove compartment 159
 Cooling 165, 170
 Correcting time 50, 56
 Coupling socket load 244
 Courtesy light 141
 Courtesy lights
 Bulb replacement..... 292
- Cruise control 216
 Curtain airbags 122
 Curve lighting 33, 139
- D**
 Dashboard, see Instrument panel 7
 Data 66, 312
 Date 48, 51
 Daytime running lights..... 136
 Decommissioning 307
 Deflation detection system 32, 221
 Deflation Detection System (DDS) 221
 Demisting and defrosting
 Windows 163
 with climate control system 174
 With air conditioning 166, 170
- Diesel fuel filter 300
 Diesel fuel system 247, 300
 Diesel particle filter 42, 160, 201
 Dipped beam 15, 136
 Bulb replacement 275
- Display 45, 46
 Display mode 58
 Door handle lighting 142
 Door locks 66, 311
 Doors 39
 Door-to-door lighting 140
 Driving abroad 204, 294
 Headlights..... 142
 Driving hints 200
- E**
 Easy Load 104
 Easytronic 20, 178
 Driving programmes 181
 fault 184
 Interruption of power supply..... 185
- Kickdown..... 182
 Selector lever 20
 Starting off..... 180
 Winter programme..... 182
- Economical driving..... 200, 202
 Electric sun roof..... 146
 Electric windows 143
 Electrical system 306, 342
 Electro-hydraulic
 power assisted steering..... 200
- Electro-hydraulic
 power-assisted steering
 fluid 313
- Electronic components 306
 Electronic immobiliser 67
 Electronic Stability Program..... 212
 Engine code 313, 314, 315
 Engine control indicator..... 210
 Engine oil 298
 Engine oil change 299
 Engine oil consumption 298
 Engine oil filter 299
 Engine oil level 40, 298
 Engine oil pressure 37
 Engine speed..... 201
 Engine wash 311
 Entry lighting 142
 Environmental protection..... 299, 308
 ESP (Electronic Stability Program)..... 212
 Exhaust control indicator 209
 Exhaust gases..... 210
 Exhaust system 210
 Exterior mirrors 6, 134, 160

F

Fan 3, 161, 297
 Filling station
 Capacities 343
 Engine oil level 298
 Fuel 204, 314, 315
 Ignition key 2
 Opening the bonnet 86
 Tyre pressure 203, 333
 Vehicle data 313
 Windscreen wash system 305
 First-aid kit (cushion) 135, 252
 Flat tyre 261
 FlexOrganizer 102
 Fog lights 137
 Fog lights
 Bulb replacement 281
 Fog tail light 137
 Bulb replacement 282, 288
 Folding roof, see TwinTop 148
 Foot brake 226
 Front passenger airbag 118
 Fuel 204, 205, 314, 315
 Fuel consumption 202, 204, 319
 Fuel filler cap 205
 Fuel filter 300
 Fuel gauge 43
 Fuel level 43
 Fuel system, diesel 247
 Fuse extractor 266
 Fuses 264

G

Gears 20
 Generator, see Alternator 39
 Genuine Vauxhall
 Parts and Accessories 26
 Glasses compartment 110
 Glove compartment 110
 Glove compartment lighting 142
 Bulb replacement 293
 Graphical information display 46
 Gross vehicle weight 324

H

Halogen headlight system
 Driving abroad 142
 Halogen headlight system 274
 Bulb replacement 274
 Hand brake 23, 24, 227
 Hazard warning lights 16, 134
 Head restraints 28, 88, 135
 Headlight flash 15
 Headlight range adjustment 138
 Headlight switch 14, 136, 137
 Headlight wash system 18, 305
 Headlights 14
 Daytime running lights 136
 Driving abroad 142
 Fog lights 137
 Warning device 23
 Headlight range adjustment 274
 Heated exterior mirrors 18, 160
 Heated front seats 160
 Heated rear window 18, 160

Heating 157, 162
 Seats 160
 with climate control system 173
 with the air
 conditioning system 166, 170
 Height adjustment
 seat belts 115
 Steering wheel 7
 High-pressure cleaners 242, 310, 311
 Hill Start Assist 227
 Horn 16

I

Identification plate 312
 IDS+ (Interactive Driving System) 212, 214
 Ignition logic 51, 58
 Ignition system 297, 306
 Immobiliser 67
 Information display 46
 Infotainment system 65
 Inspection system 296
 Instrument display 43
 Instrument illumination 140
 Bulb replacement 293
 Instrument panel 7
 Instruments 36
 Interactive Driving System (IDS+) 212, 214
 Interior mirror 6
 Interruption of power supply . 60, 63, 145
 Easytronic 185
 Electric windows 145
 Selector lever lock 191, 199
 ISOFIX 129

J

- Jack 256
- Jump leads 248

K

- Key
 - extending 66
 - ignition lock..... 14
 - Locking doors 76
 - Remove 24
 - Starting the engine..... 14, 22
- Key numbers 2
- Keys..... 66

L

- Language selection 51, 56
- Lashing eyes 103
- Leather trim 310
- Level control system 220
- Light switch..... 14
- Lighting 14, 40, 136
 - Driving abroad..... 142
- Loading 243, 322, 323
- Locking doors 2, 76
- Locking from the inside 78
- Locks..... 311
- Lubricants 298, 313
- Luggage compartment
 - Bulb replacement..... 293
 - FlexOrganizer 102
 - Lighting 142
 - Loading 106, 243, 324
 - Locking 81

- Safety net..... 99, 101
- Luggage compartment cover 98
- Lumbar support 4

M

- Main beam 15, 136
 - Bulb replacement 276, 278
 - Control indicator 41
- Maintenance..... 26, 296
 - Air conditioning system 177
 - Antifreeze protection..... 300
 - Brake fluid 302
 - Brakes 226
 - Catalytic converter 211
 - Engine oil 298, 299
 - Fuel consumption 203
 - Tyre pressure 232
 - Tyres..... 233, 234
 - Windscreen wipers 303
- Manual transmission, see Transmission 20
- Mirrors 6, 134
- Misted windows 163, 174
- Mobile telephone 65
- Motorway lighting 33, 139
- Muffler, see Exhaust system 210

N

- Neutral, transmission 20
- Number plate lighting 291
- Number plate lights
 - Bulb replacement 291
- Number plates 307

O

- Octane numbers..... 204, 314
- Oil change 299
- Oil consumption 298
- Oil filter change..... 299
- Oil level..... 298
- Oil pressure..... 37
- Oils 298
- Open&Start system 22, 31, 36, 70
- Operating temperature 201
- Outside temperature gauge 47
- Overrun 201, 203

P

- Paintwork damage..... 310
- Panoramic windscreen 34, 146
- Parking 24, 218
- Parking distance sensor..... 218
- Parking lights 14, 140
- Parking lights
 - Bulb replacement..... 277, 280
- Parking the vehicle..... 24
- Parts 26, 135
- Pedals 201
- Performance 319
- Petrol 204, 314, 315
- Pinking 204
- Pollen filter..... 177
- Power assisted steering, see electro-hydraulic power assisted steering 200
- Power steering, see electro-hydraulic power assisted steering 200
- Preheating..... 22, 42

Preheating switch 22
 Puddle light 142
 Pushing, towing 247

Q

Quickheat 162, 169, 173

R

Radio 64
 Radio equipment (CB) 65
 Radio reception 64
 Radio remote control
 Central locking system ... 2, 31, 68, 71
 Rain sensor 17, 303
 Reading lights 141
 Rear light cluster 136
 Bulb replacement 282, 288
 Rear window wash system ... 18, 305, 309
 Refuelling 205
 Fuel filler cap 206
 Remote control
 Central locking system ... 2, 31, 68, 71
 Steering wheel 30, 64
 Replacement keys 66
 Reversing lights
 Bulb replacement 282, 288
 Rollover protection system 152
 Roof lining 34, 146
 Roof load 106, 200, 203, 322, 323
 Roof rack 203, 238, 324
 Roof racks 203, 238, 324
 Run-flat tyres 235
 Running-in 200
 Brakes 226

S

Safeguard
 against unauthorised use 2, 14, 25
 Safety 111
 Safety accessories 130, 135, 252
 Safety net 99, 101
 Safety systems 111
 Saving energy 202
 Seat adjustment 3
 Seat belts 115, 310
 Seat height adjustment 4
 Seat occupancy recognition 124
 Seat position 87
 Seats 3, 4
 heated 160
 Selector lever 179, 187, 193
 Selector lever lock 20, 21, 187, 193
 Self-diagnosis 113, 123, 229
 Self-help 247
 Automatic transmission 191
 Electric sun roof 147
 Electric windows 145
 Information display 48
 Radio remote control 69, 75
 Service Booklet 26
 Service interval display 296
 Service work 26, 296
 Side airbags 120
 Signal system 15, 16
 Spare fuses 265
 Spare keys 66
 Spare wheel 254, 255, 257
 Speed 202, 203

Fuel consumption 202, 203
 Speedometer 43
 Sport mode 39
 Sport programme 32, 214
 Starter switch 14
 Starting the engine 14, 67, 179, 247
 Self-help 247
 Steam-jet cleaners 242, 310, 311
 Steering column lock 14, 24
 Steering wheel adjustment 7
 Steering wheel remote control 30, 64
 Stowage compartments 110
 Sun roof 146
 Sun visors 34, 142, 146
 Sunblind 147
 System settings 50, 55

T

Tables 110
 Tachometer 43
 Tail lights 136
 Bulb replacement 282
 Tail lights
 Bulb replacement 288
 Tailgate 81
 Tank
 Fuel gauge 43
 Technical data 312
 Telephone, see Mobile telephone 65
 Temperature regulation 161, 173
 Tempomat, see cruise control 216
 Temporary spare wheel 237, 255
 The first 600 miles/1000 km 200
 Tightening torque 260, 333

Tilt angle
 seats 4
 Time..... 48, 51
 Tools 256
 Towing 249
 Towing equipment 239
 Towing eye 249, 251
 Trailer Stability Assist (TSA) 244
 Transmission display... 45, 178, 186, 193
 Transmission, automatic 20, 21, 186, 192
 automatic mode 187, 193
 Driving programme 188, 195
 Fault 190, 198
 Interruption of power supply .. 191, 199
 Kickdown..... 189, 196
 Selector lever 20, 187, 193, 194
 Selector lever lock 20
 Winter programme 189, 196
 Transmission, Easytronic..... 178
 Driving programmes 181
 fault 184
 Interruption of power supply 185
 Kickdown..... 182
 Selector lever 20, 180
 Winter programme..... 182
 Transmission, manual 20
 Tread depth 234
 Trip computer 30, 52, 58
 Trip odometer..... 44
 Triple information display 46
 TSA (Trailer Stability Assist) 244
 Turn signal lights 15
 Turn signals
 Bulb replacement..... 281, 282, 288

Twin Audio 31, 64
 TwinTop 148
 Closing the roof 149
 Opening the roof..... 149
 Rollover protection..... 152
 Warning buzzers 150
 Wind deflector 154
 Tyre chains..... 236, 333
 Tyre condition 233
 Tyre pressure 32, 222, 232, 333
 Tyre pressure monitoring system 222
 Tyre repair kit..... 261

U

Units of measure 51, 57
 Unleaded fuel 204, 207, 314
 Used oil 299

V

Valve cap key 232, 333
 Vauxhall alarm system 83
 Vauxhall Service 26, 294
 Vehicle care 308
 Vehicle decommissioning 307
 Vehicle identification number 313
 Vehicle keys, see Keys 66
 Vehicle recommissioning 307
 Vehicle tools 256
 Ventilation 157, 162, 169, 175

W

Warning buzzers 23
 Warning messages..... 49, 54, 55
 Warning triangle 135, 252
 Wash fluid reservoir, windscreen
 wash system 305
 Weights 322, 323
 Wheels..... 230
 Wheels, tyres 230
 Wind deflector 154
 Windows
 Demisting and defrosting..... 163, 166,
 170, 174
 Windscreen wash system 18
 Antifreeze protection 305
 Capacities..... 343
 Wash fluid reservoir 305
 Windscreen wipers 17, 303
 Winter mode
 Starting-off aid 182
 Winter operation
 Battery..... 201
 Coolant, antifreeze..... 300
 Fuel consumption 203
 Fuel for diesel engines..... 205
 Heating..... 157, 166, 170
 Locks..... 311
 Tyre chains 236, 333
 Window demisting and defrosting .. 163
 Windscreen wash system,
 antifreeze protection 305
 Winter programme..... 182, 189, 196
 Winter tyres..... 236, 333

X

| | |
|------------------------------|-----|
| Xenon headlight system | |
| Driving abroad..... | 142 |
| Xenon headlight system | 278 |
| Bulb replacement..... | 278 |



© Copyright by Vauxhall Motors Ltd., England.

Reproduction or translation, in whole or in parts, is not permitted without prior written consent from Vauxhall Motors Ltd.

All rights as understood under the copyright laws are explicitly reserved by Vauxhall Motors Ltd.

All information, illustrations and specifications contained in this manual are based on the latest production information available at the time of publication.

The right is reserved to make changes at any time without notice.

Edition: July 2006.

TS 1612-A-07

