

VAUXHALL Mokka

**Owner's Manual
Model Year 2014.5
Edition: January 2014**

KTA-2749/2-VX-en

Contents

Introduction	2
In brief	6
Keys, doors and windows	19
Seats, restraints	33
Storage	54
Instruments and controls	72
Lighting	103
Climate control	112
Driving and operating	118
Vehicle care	154
Service and maintenance	194
Technical data	197
Customer information	209
Index	212

Introduction

Fuel	Designation	<input type="text"/>		
Engine oil	Grade	<input type="text"/>		
	Viscosity	<input type="text"/>		
Tyre pressure	Tyre size		Front	Rear
	Summer tyres	<input type="text"/>	<input type="text"/>	<input type="text"/>
	Winter tyres	<input type="text"/>	<input type="text"/>	<input type="text"/>
Weights	Gross vehicle weight rating	<input type="text"/>		
	- Kerb weight, basic model	<input type="text"/>		
	= Loading	<input type="text"/>		

Vehicle specific data

Please enter your vehicle's data on the previous page to keep it easily accessible. This information is available in the sections "Service and maintenance" and "Technical data" as well as on the identification plate.

Introduction

Your vehicle is a designed combination of advanced technology, safety, environmental friendliness and economy.

This Owner's Manual provides you with all the necessary information to enable you to drive your vehicle safely and efficiently.

Make sure your passengers are aware of the possible risk of accident and injury which may result from improper use of the vehicle.

You must always comply with the specific laws and regulations of the country that you are in. These laws may differ from the information in this Owner's Manual.

When this Owner's Manual refers to a workshop visit, we recommend your Vauxhall Authorised Repairer. For gas vehicles, we recommend a Vauxhall Authorised Repairer licensed to service gas vehicles.

All Vauxhall Authorised Repairers provide first-class service at reasonable prices. Experienced mechanics trained by Vauxhall work according to specific Vauxhall instructions.

The customer literature pack should always be kept ready to hand in the vehicle.

Using this manual

- This manual describes all options and features available for this model. **Certain descriptions, including those for display and menu functions, may not apply to your vehicle due to model variant, country specifications, special equipment or accessories.**
- The "In brief" section will give you an initial overview.

- The table of contents at the beginning of this manual and within each section shows where the information is located.
- The index will enable you to search for specific information.
- This Owner's Manual depicts left-hand drive vehicles. Operation is similar for right-hand drive vehicles.
- The Owner's Manual uses the factory engine designations. The corresponding sales designations can be found in the section "Technical data".
- Directional data, e.g. left or right, or front or back, always relate to the direction of travel.
- The vehicle display screens may not support your specific language.
- Display messages and interior labelling are written in **bold** letters.

Danger, Warnings and Cautions

Danger

Text marked **△ Danger** provides information on risk of fatal injury. Disregarding this information may endanger life.

Warning

Text marked **△ Warning** provides information on risk of accident or injury. Disregarding this information may lead to injury.

Caution

Text marked **Caution** provides information on possible damage to the vehicle. Disregarding this information may lead to vehicle damage.

Symbols

Page references are indicated with ⇨.
⇨ means "see page".

Thank you for choosing a Vauxhall.

We wish you many hours of pleasurable driving.

Your Vauxhall Team

In brief

Initial drive information

Vehicle unlocking



Press button  to unlock the doors and load compartment. Open the doors by pulling the handles. To open the tailgate, push the touchpad switch below the handle.

Radio remote control ⇨ 20, Central locking system ⇨ 21, Load compartment ⇨ 24.

Seat adjustment

Seat positioning



Pull handle, slide seat, release handle.

Seat position ⇨ 34, Seat adjustment ⇨ 35.

Danger

Do not sit nearer than 25 cm from the steering wheel, to permit safe airbag deployment.

Seat backrests



Pull lever, adjust inclination and release lever. Allow the seat to engage audibly.

Seat position ⇨ 34, Seat adjustment ⇨ 35.

Seat height



Lever pumping motion

up = seat higher
down = seat lower

Seat position ⇨ 34, Seat adjustment ⇨ 35.

Seat inclination



Adjust the inclination by pressing the button.

Head restraint adjustment

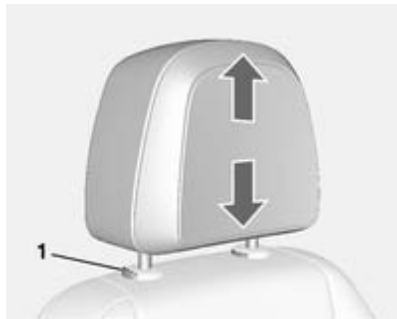

Pull the head restraint upwards. Press the catch (1) to release and push the head restraint downwards.

Head restraints ⇨ 33.

Seat belt



Pull out the seat belt and engage in belt buckle. The seat belt must not be twisted and must fit close against the body. The backrest must not be tilted back too far (maximum approx. 25°).

To release belt, press red button on belt buckle.

Seat position ⇨ 34, Seat belts ⇨ 38, Airbag system ⇨ 41.

Mirror adjustment

Interior mirror



To reduce dazzle, adjust the lever on the underside of the mirror housing.

Interior mirror ⇨ 28, Automatic anti-dazzle interior mirror ⇨ 28.

Exterior mirrors



Select the relevant exterior mirror and adjust it.

Convex exterior mirrors ⇨ 27,
Electric adjustment ⇨ 27, Folding
exterior mirrors ⇨ 27, Heated
exterior mirrors ⇨ 28.

Steering wheel adjustment



Unlock the lever, adjust the steering wheel, then engage the lever and ensure it is fully locked.

Do not adjust the steering wheel unless the vehicle is stationary and the steering wheel lock has been released.

Airbag system ⇨ 41, Ignition
positions ⇨ 119.

Instrument panel overview

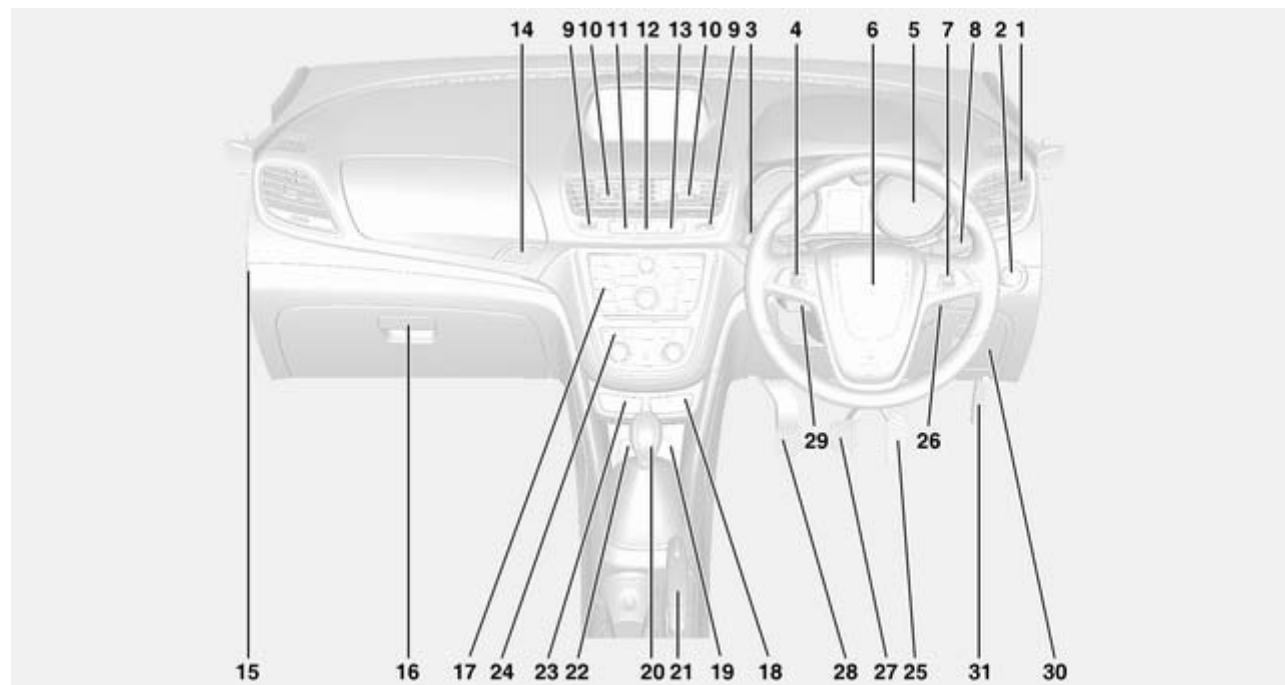

-
- | | | |
|---|---|---|
| 1 Side air vents 116 | 13 Control indicator for airbag
deactivation 84 | 26 Ignition switch with
steering wheel lock 119 |
| 2 Light switch 103 | 14 Instrument panel storage
button 54 | 27 Brake pedal 129 |
| 3 Turn and lane-change
signals 108 | 15 Passenger airbag
deactivation 46 | 28 Clutch pedal 118 |
| Headlight flash 104 | 16 Glovebox 55 | 29 Steering wheel adjustment . . 72 |
| Low beam and high beam . . 104 | 17 Infotainment system | 30 Instrument panel storage 54 |
| 4 Cruise control 133 | 18 Eco button for stop-start
system 120 | 31 Bonnet release lever 156 |
| Speed limiter 134 | Fuel selector 80 | |
| Forward collision alert 136 | 19 AUX input, USB input, SD
card slot | |
| 5 Instruments 79 | 20 Selector lever, manual
transmission 128 | |
| 6 Horn 73 | Automatic transmission 125 | |
| Driver airbag 44 | 21 Parking brake 130 | |
| 7 Steering wheel controls 72 | 22 Power outlet 78 | |
| 8 Windscreen wiper,
windscreen washer system ... 73 | 23 Parking assist 138 | |
| Rear wiper, rear washer
system 75 | Descent control system 86 | |
| 9 Centre air vents adjustment 116 | 24 Climate control system 112 | |
| 10 Centre air vents 116 | 25 Accelerator pedal 119 | |
| 11 Electronic Stability Control . 131 | | |
| 12 Hazard warning flashers 108 | | |

Exterior lighting



Turn light switch:

AUTO = automatic light control: exterior lighting is switched on and off automatically depending on external lighting conditions.

 = activation or deactivation of the automatic light control. Switch turns back to **AUTO**.

 = sidelights

 = low beam

Vehicles without automatic light control:

O = off

Fog lights

Press light switch:

 = front fog lights

 = rear fog light

Lighting ⇨ 103.

Headlight flash, high beam and low beam

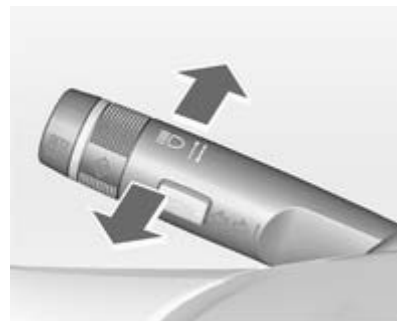

headlight flash = pull lever

high beam = push lever

low beam = push or pull lever

Automatic light control ⇨ 103, High beam ⇨ 104, Headlight flash ⇨ 104, Adaptive forward lighting ⇨ 106.

Turn and lane-change signals



lever up = right turn signal
lever down = left turn signal

Turn and lane-change signals
⇨ 108.

Hazard warning flashers



Operated with the  button.
Hazard warning flashers ⇨ 108.

Horn



Press .

Washer and wiper systems

Windscreen wiper



2 = fast

1 = slow

 = interval wiping or automatic wiping with rain sensor

O = off

For a single wipe when the windscreen wiper is off, press the lever down.

Windscreen wiper ⇨ 73, Wiper blade replacement ⇨ 161.

Windscreen washer systems



Pull lever.

Windscreen washer system ⇨ 73,
Washer fluid ⇨ 159.

Rear window wiper and washer systems



Press the rocker switch to activate the rear window wiper:

upper position = continuous operation
lower position = intermittent operation
middle position = off

Rear window wiper/washer ⇨ 75.



Push lever.

Washer fluid is sprayed on the rear window and the wiper wipes a few times.

Climate control

Heated rear window, heated exterior mirrors



The heating is operated by pressing the  button.

Heated rear window  30.

Demisting and defrosting the windows



Press button .

Set the temperature control to the highest level.

Cooling  on.

Heated rear window  on.

Climate control system  112.

Transmission

Manual transmission

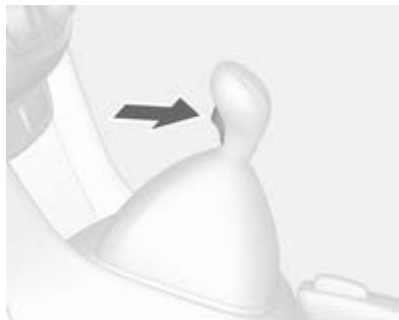

Reverse: with the vehicle stationary, wait 3 seconds after depressing clutch pedal and then press the release button on the selector lever and engage the gear.

If the gear does not engage, set the lever to neutral, release the clutch pedal and depress again; then repeat gear selection.

Manual transmission ↪ 128.

Automatic transmission



P = park
R = reverse
N = neutral
D = drive

Manual mode: Move selector lever to **M**.

+ = higher gear.
- = lower gear.

The selector lever can only be moved out of **P** when the ignition is on and the brake pedal is applied. To engage **P** or **R**, press the release button.

Automatic transmission ↪ 125.

Starting off

Check before starting off

- Tyre pressure and condition ↪ 175, ↪ 207.
- Engine oil level and fluid levels ↪ 156.
- All windows, mirrors, exterior lighting and number plates are free from dirt, snow and ice and are operational.
- Proper position of mirrors, seats, and seat belts ↪ 27, ↪ 34, ↪ 39.
- Brake function at low speed, particularly if the brakes are wet.

Starting the engine

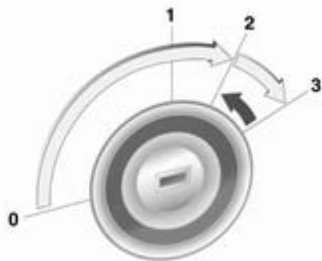

- Turn key to position **1**
 - move the steering wheel slightly to release the steering wheel lock
 - operate clutch and brake
 - automatic transmission in **P** or **N**
 - do not operate accelerator pedal
 - diesel engines: turn the key to position **2** for preheating and wait until control indicator  extinguishes
 - turn key to position **3** and release
- Starting the engine ⇨ 119.

Stop-start system



If the vehicle is at a low speed or at a standstill and certain conditions are fulfilled, activate an Autostop as follows:

- Depress the clutch pedal
- shift the selector lever to **N**
- release the clutch pedal

An Autostop is indicated by the needle at the **AUTOSTOP** position in the tachometer.

To restart the engine, depress the clutch pedal again.

Stop-start system ⇨ 120.

Parking

- Always apply the parking brake. Activate the manual parking brake without pressing the release button. Apply as firmly as possible on a downhill slope or uphill slope. Depress foot brake at the same time to reduce operating force.
- Switch off the engine. Turn the ignition key to position **0** and remove it. Turn the steering wheel until the steering wheel lock is felt to engage.

For vehicles with automatic transmission, the key can only be removed when the selector lever is in position **P**.

- If the vehicle is on a level surface or uphill slope, engage first gear or set the selector lever to position **P** before switching off the ignition. On an uphill slope, turn the front wheels away from the kerb.
- If the vehicle is on a downhill slope, engage reverse gear or set the selector lever to position **P** before

switching off the ignition. Turn the front wheels towards the kerb.

- Lock the vehicle with button  on the radio remote control.

Activate the anti-theft alarm system
⇨ 25.

- Do not park the vehicle on an easily ignitable surface. The high temperature of the exhaust system could ignite the surface.
- Close the windows and the sunroof.
- The engine cooling fans may run after the engine has been switched off ⇨ 155.
- After running at high engine speeds or with high engine loads, operate the engine briefly at a low load or run in neutral for approx. 30 seconds before switching off, in order to protect the turbocharger.

Keys, locks ⇨ 19, Laying the vehicle up for a long period of time ⇨ 154.

Keys, doors and windows

Keys, locks	19
Doors	24
Vehicle security	25
Exterior mirrors	27
Interior mirrors	28
Windows	29
Roof	31

Keys, locks

Keys

Replacement keys

The key number is specified on a detachable tag.

The key number must be quoted when ordering replacement keys as it is a component of the immobiliser system.

Locks ⇨ 191.

Lock cylinders

Designed to free-wheel if they are forcefully rotated without the correct key or if the correct key is not fully inserted. To reset, turn cylinder with the correct key until its slot is vertical, remove key and then re-insert it. If the cylinder still free-wheels, turn the key through 180° and repeat operation.

Key with foldaway key section



Press button to extend.

To fold the key, first press the button.

Radio remote control



Used to operate:

- Central locking system
- Anti-theft alarm system

The radio remote control has a range of approx. 30 metres. It can be restricted by external influences. The hazard warning flashers confirm operation.

Handle with care, protect from moisture and high temperatures and avoid unnecessary operation.

Fault

If the central locking system cannot be operated with the radio remote control, it may be due to the following:

- Range exceeded
- Battery voltage too low
- Frequent, repeated operation of the radio remote control while not in range, which will require re-synchronisation
- Overload of the central locking system by operating at frequent intervals, the power supply is interrupted for a short time
- Interference from higher-power radio waves from other sources

Unlocking ⇨ 21.

Basic settings

Some settings can be changed in the menu **Settings** in the Info-Display. Vehicle personalisation ⇨ 99.

Radio remote control battery replacement

Replace the battery as soon as the range reduces.



Batteries do not belong in household waste. They must be disposed of at an appropriate recycling collection point.

Key with foldaway key section



Extend the key and open the unit. Replace the battery (battery type CR 2032), paying attention to the installation position. Close the unit and synchronise.

Radio remote control synchronisation

After replacing the battery, unlock the door with the key in the driver's door lock. The radio remote control is synchronised when the ignition is switched on.

Memorised settings

Whenever the key is removed from the ignition switch, the following settings are automatically memorised by the key:

- Lighting
- Infotainment system
- Central locking system

The saved settings are automatically used the next time the memorised key is inserted into the ignition switch and turned to position 1 ↷ 119.

A precondition is that **Personalization by driver** is activated in the personal settings of the Graphic-Info-Display. This must be set for each key used. On vehicles equipped with Colour-Info-Display, the personalisation is permanently activated.

Vehicle personalisation ↷ 99.

Central locking system

Unlocks and locks doors, load compartment and fuel filler flap.

A pull on an interior door handle unlocks the respective door. Pulling the handle again opens the door.

Note

In the event of an accident in which airbags or belt pretensioners are deployed, the vehicle is automatically unlocked.

Note

A short time after unlocking with the remote control the doors are locked automatically if no door has been opened.



Unlocking

Radio remote control



Press button .

Two settings are selectable:

- To unlock only the driver's door, load compartment and fuel filler flap; press button  once. To unlock all doors; press button  twice or
- press button  once to unlock all doors, load compartment and fuel filler flap

The setting can be changed in the menu **Settings** in the Info-Display. Vehicle personalisation ↗ 99.

The setting can be saved for the key being used. Memorised settings ↗ 21.

Locking

Close doors, load compartment and fuel filler flap.



Press button .

If the driver's door is not closed properly, the central locking system will not work.

Central locking buttons

Locks or unlocks all doors, the load compartment and fuel filler flap from inside the passenger compartment.



The central locking buttons are located in the driver's door and passenger's door.

Press the  button to lock.

Press the  button to unlock.

Fault in radio remote control system

Unlocking



Manually unlock the driver's door by turning the key in the lock. Switch on the ignition and press the central locking button  to unlock the other doors, load compartment and fuel filler flap. By switching on the ignition, the anti-theft locking system is deactivated.

Locking

Manually lock the driver's door by turning the key in the lock.

Fault in central locking system

Unlocking

Manually unlock the driver's door by turning the key in the lock. The other doors can be opened by pulling the interior handle twice. The load compartment and fuel filler flap cannot be opened. To deactivate the anti-theft locking system, switch on the ignition ⇨ 25.

Locking

Push inside locking knob of all doors except driver's door. Then close the driver's door and lock it from the outside with the key. The fuel filler flap and tailgate cannot be locked.

Delayed locking

This feature will delay the actual locking of the doors and arming of the anti-theft alarm system for five seconds when the power door lock switch or radio remote control is used to lock the vehicle.

This can be changed in the vehicle settings.

Vehicle personalisation ⇨ 99.

ON: When pressing the central locking button, three chimes will sound to signal delayed locking is in use.

The doors will not lock until five seconds after the last door is closed. You can temporarily override delayed locking by pressing the central locking button or the locking button on the radio remote control.

OFF: The doors will lock immediately when pressing the power lock switch or the button  on the radio remote control.

Automatic locking

This security feature can be configured to automatically lock all doors, load compartment and fuel filler flap as soon as a certain speed is exceeded.

Additionally, it is configurable to unlock the driver's door or all doors after the ignition is switched off and the ignition key is removed (manual

transmission) or the selector lever is moved to position **P** (automatic transmission).

Settings can be changed in the menu **Settings** in the Info-Display. Vehicle personalisation ⇨ 99.

The settings can be saved for the key being used ⇨ 21.

Child locks



⚠ Warning

Use the child locks whenever children are occupying the rear seats.

Using a key or suitable screwdriver, turn the child lock in the rear door to the horizontal position. The door cannot be opened from the inside. For deactivation turn the child lock to the vertical position.

Doors**Load compartment****Tailgate****Opening**

After unlocking, push the touchpad switch and open the tailgate.

Closing

Use one of the interior handles.

Do not push the touchpad switch or the brand emblem whilst closing as this will unlock the tailgate again.

Central locking system ↪ 21.

General hints for operating tailgate**⚠ Danger**

Do not drive with the tailgate open or ajar, e.g. when transporting bulky objects, since toxic exhaust gases, which cannot be seen or smelled, could enter the vehicle. This can cause unconsciousness and even death.

Caution

Before opening the tailgate, check overhead obstructions, e.g. a garage door, to avoid damage to the tailgate. Always check the moving area above and behind the tailgate.

Note

The installation of certain heavy accessories onto the tailgate may affect its ability to remain open.

Vehicle security

Anti-theft locking system

Warning

Do not use the system if there are people in the vehicle! The doors cannot be unlocked from the inside.

The system deadlocks all the doors. All doors must be closed otherwise the system cannot be activated.

If the ignition was on, the driver's door must be opened and closed once so that the vehicle can be secured.

Unlocking the vehicle disables the mechanical anti-theft locking system. This is not possible with the central locking button.

Activating



Press  on the radio remote control twice within 5 seconds.

Anti-theft alarm system

The anti-theft alarm system is combined with the central locking system.

It monitors:

- Doors, load compartment, bonnet,
- Ignition.

Unlocking the vehicle deactivates the anti-theft alarm system.

Activation

- Self-activated 30 seconds after locking the vehicle (initialisation of the system)
- Directly by pressing  on the radio remote control once more after locking

Note

Changes to the vehicle interior, e.g. the use of seat covers, and open windows, could impair the function of passenger compartment monitoring.

Status LED



Status LED is integrated in the sensor on top of the instrument panel.

Status during the first 30 seconds of anti-theft alarm system activation:

LED illuminates = test, arming delay.
 LED flashes = doors, tailgate or bonnet not completely closed, or system fault.

Status after system is armed:

LED flashes slowly = system is armed.

Seek the assistance of a workshop in the event of faults.

Deactivation

Unlocking the vehicle deactivates the anti-theft alarm system.

Alarm

The alarm can be silenced by pressing any button of the radio remote control or by switching on the ignition.

The anti-theft alarm system can be deactivated by pressing the button  or switching on the ignition.

Auto door locking

If any of the doors is not opened or the position of the ignition key is not located in position **2** or **3**  119 within 3 minutes after unlocking doors with the radio remote control, all doors are locked and the anti-theft alarm system is activated automatically.

Automatic door unlocking

All doors will be automatically unlocked when impact is delivered to impact sensors while the ignition is switched on.

However, the doors may not be unlocked if mechanical problems occur with the door locking system or battery.

Immobiliser



The system is part of the ignition switch and checks whether the vehicle is allowed to be started with the key being used.

The immobiliser is activated automatically after the key has been removed from the ignition switch.

If the control indicator  flashes when the ignition is on, there is a fault in the system; the engine cannot be started. Switch off the ignition and repeat the start attempt.

If the control indicator continues flashing, attempt to start the engine using the spare key and seek the assistance of a workshop.

Note

The immobiliser does not lock the doors. You should always lock the vehicle after leaving it and switch on the anti-theft alarm system  21,  25.

Control indicator   88.

Exterior mirrors

Convex shape

The convex exterior mirror contains an aspherical area and reduces blind spots. The shape of the mirror makes objects appear smaller, which will affect the ability to estimate distances.

Electric adjustment



Select the relevant exterior mirror by turning the control to left (**L**) or right (**R**). Then swivel the control to adjust the mirror.

In position **0** no mirror is selected.

Folding mirrors

Manual folding



For pedestrian safety, the exterior mirrors will swing out of their normal mounting position if they are struck with sufficient force. Reposition the mirror by applying slight pressure to the mirror housing.

Electric folding



Turn control to **0**, then push the control backwards. Both exterior mirrors will fold in.

Push the control backwards again - both exterior mirrors return to their original position.

Heated mirrors



Operated by pressing the  button. Heating functions with the engine running and is switched off automatically after a short time.

Interior mirrors

Manual anti-dazzle



To reduce dazzle, adjust the lever on the underside of the mirror housing.

Automatic anti-dazzle



Dazzle from following vehicles at night is automatically reduced.

Windows

Windscreen

Heat-reflecting windscreen

The heat-reflecting windscreen has a coating which reflects solar radiation. Also data signals, e.g. from toll stations, might be reflected.

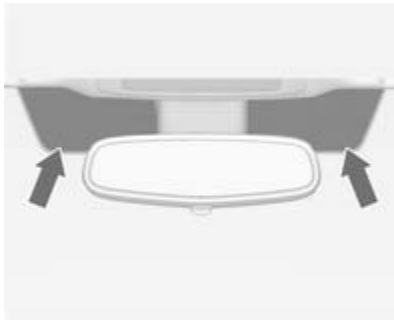

The marked areas of the windscreen behind the interior mirror are not covered with the coating. Devices for electronic data recording and fee payment must be attached in these areas. Otherwise data recording malfunctions may occur.

Windscreen stickers

Do not attach stickers such as toll road stickers or similar on the windscreen in the area of the interior mirror. Otherwise the detection zone of the sensor and the view area of the camera in the mirror housing could be restricted.

Manual windows

The door windows can be opened or closed with the window winders.

Power windows

⚠ Warning

Take care when operating the power windows. Risk of injury, particularly to children.

If there are children on the rear seats, switch on the child safety system for the power windows.

Keep a close watch on the windows when closing them. Ensure that nothing becomes trapped in them as they move.

Switch on ignition to operate power windows.



Operate the switch for the respective window by pushing to open or pulling to close.

Pushing or pulling gently to the first detent: window moves up or down as long as the switch is operated.

Pushing or pulling firmly to the second detent and then releasing: window moves up or down automatically with safety function enabled. To stop movement, operate the switch once more in the same direction.

Safety function

If the window glass encounters resistance above the middle of the window during automatic closing, it is immediately stopped and opened again.

Override safety function

In the event of closing difficulties due to frost or the like, switch on the ignition, then pull the switch to the first detent and hold. The window moves up without safety function enabled. To stop movement, release the switch.

Child safety system for rear windows



Press switch  to deactivate rear power windows.

To activate, press  again.

Overload

If the windows are repeatedly operated within short intervals, the window operation is disabled for some time.

Initialising the power windows

If the windows cannot be closed automatically (e.g. after disconnecting the vehicle battery), activate the window electronics as follows:

1. Close doors.
2. Switch on ignition.
3. Close the window completely and keep the switch pulled for additional 2 seconds.
4. Repeat for each window.

Heated rear window



Operated by pressing the  button. Heating works with the engine running and is switched off automatically after a short time.

Depending on the engine type, the heated rear window comes on automatically when the diesel particle filter is being cleaned.

Sun visors

The sun visors can be folded down or swivelled to the side to prevent dazzling.

The sun visors mirror covers should be closed when driving.

If the sun visors have a vanity mirror lamp, the lamp will illuminate when opening the vanity mirror cover.

Roof

Sunroof

Warning

Take care when operating the sunroof. Risk of injury, particularly to children.

Keep a close eye on the movable parts when operating them. Ensure that nothing becomes trapped in them as they move.

Switch on ignition to operate the sunroof.

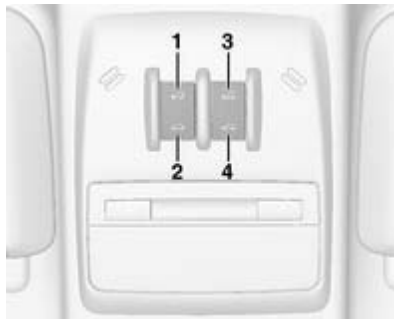

Open or close

Press switch **1** or switch **2** gently to the first detent: sunroof is opened or closed as long as the switch is operated.

Press switch **1** or switch **2** firmly to the second detent and then release: the sunroof is opened or closed automatically with safety function enabled. To stop movement, operate the switch once more.

Raise or close

Press switch **3** or switch **4**: sunroof is raised or closed automatically with safety function enabled.

If the sunroof is raised, it can be opened in one step by pressing switch **1**.

Sunblind

The sunblind is operated manually.

Close or open the sunblind by sliding.

When the sunroof is open, the sunblind is always open.

Dirt and debris may collect on the sunroof seal or in the track that could cause an issue with sunroof

operation, noise or plug the water drainage system. Periodically open the sunroof and remove any obstacles or loose debris. Wipe the sunroof seal and roof sealing area using a clean cloth, mild soap, and water. Do not remove grease from the sunroof.

General hints

Safety function

If the sunroof encounters resistance during automatic closing, it is immediately stopped and opened again.

Override safety function

In the event of closing difficulties due to frost or the like, press and hold switch **2**. The sunroof closes without safety function enabled. To stop movement, release the switch.

Initialising after a power failure

After a power failure, it may only be possible to operate the sunroof to a limited extent. Have the system initialised by your workshop.

Seats, restraints

Head restraints	33
Front seats	34
Seat belts	38
Airbag system	41
Child restraints	47

Head restraints

Position

⚠ Warning

Only drive with the head restraint set to the proper position.



The upper edge of the head restraint should be at upper head level. If this is not possible for extremely tall people, set to highest position, and set to lowest position for small people.

Adjustment

Head restraints on front seats

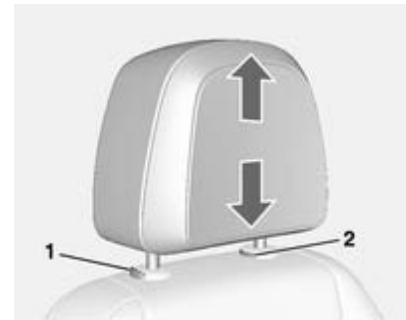

Height adjustment

Pull the head restraint upwards.

To move down, press the catch (1) and push the head restraint downwards

Removing

Raise head restraint to its full height.

Press the catches (1) and (2) at the same time.

Pull up the head restraint.

Horizontal adjustment



To adjust horizontally, pull the head restraint forwards. It engages in three positions.

To return to its rearmost position, pull fully forwards and release.

Head restraints on rear seats

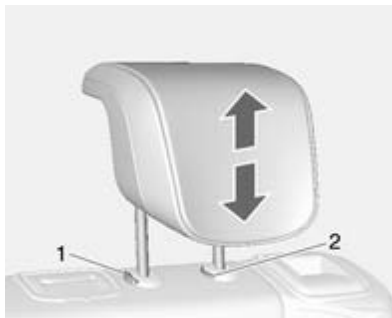

Height adjustment

Pull the head restraint upwards.

To move down, press the catch (1) and push the head restraint downwards.

Removal

Raise head restraint to its full height.

Press the catches (1) and (2) at the same time.

Pull up the head restraint.

Front seats

Seat position

⚠ Warning

Only drive with the seat correctly adjusted.



- Sit with buttocks as far back against the backrest as possible. Adjust the distance between the seat and the pedals so that legs are slightly angled when pressing the pedals. Slide the front passenger seat as far back as possible.

- Sit with shoulders as far back against the backrest as possible. Set the backrest rake so that it is possible to easily reach the steering wheel with arms slightly bent. Maintain contact between shoulders and the backrest when turning the steering wheel. Do not tilt the backrest too far back. We recommend a maximum rake of approx. 25°.
- Adjust the steering wheel ⇨ 72.
- Set seat height high enough to have a clear field of vision on all sides and of all display instruments. There should be at least one hand of clearance between head and the headlining. Your thighs should rest lightly on the seat without pressing into it.
- Adjust the head restraint ⇨ 33.
- Adjust the height of the seat belt ⇨ 39.

- Adjust the thigh support so that there is a space approx. two fingers wide between the edge of the seat and the hollow of the knee.
- Adjust the lumbar support so that it supports the natural shape of the spine.

Seat adjustment

⚠ Danger

Do not sit nearer than 25 cm from the steering wheel, to permit safe airbag deployment.

⚠ Warning

Never adjust seats while driving as they could move uncontrollably.

Drive only with engaged seats and backrests.

Seat positioning



Pull handle, slide seat, release handle.

Seat backrests



Pull lever, adjust inclination and release lever. Allow the backrest to engage audibly.

Seat height



Lever pumping motion
up = seat higher
down = seat lower

Seat inclination



Adjust the inclination by pressing the button.

Lumbar support



Adjust lumbar support using the four-way switch to suit personal requirements.

Moving support up and down: push switch up or down.

Increasing and decreasing support: push switch forwards or backwards.

Adjustable thigh support



Pull the lever and slide the thigh support.

Heating



Adjust heating to the desired setting by pressing the  button for the respective seat one or more times. The control indicator in the button indicates the setting.

Prolonged use of the highest setting for people with sensitive skin is not recommended.

Seat heating is operational when engine is running and during an Autostop.

Stop-start system ⇨ 120.

Seat belts



The seat belts are locked during heavy acceleration or deceleration of the vehicle holding the occupants in the sitting position. Therefore the risk of injury is considerably reduced.

⚠ Warning

Fasten seat belt before each trip. In the event of an accident, people not wearing seat belts endanger their fellow occupants and themselves.

Seat belts are designed to be used by only one person at a time. Child restraint system ⇨ 47.

Periodically check all parts of the belt system for damage and proper functionality.

Have damaged components replaced. After an accident, have the belts and triggered belt pretensioners replaced by a workshop.

Note

Make sure that the belts are not damaged by shoes or sharp-edged objects or trapped. Prevent dirt from getting into the belt retractors.

Seat belt reminder 🚨 ⇨ 84.

Belt force limiters

On the front seats, stress on the body is reduced by the gradual release of the belt during a collision.

Belt pretensioners

In the event of a head-on or rear-end collision of a certain severity, the front seat belts are tightened.

⚠ Warning

Incorrect handling (e.g. removal or fitting of belts) can trigger the belt pretensioners.

Deployment of the belt pretensioners is indicated by continuous illumination of control indicator 🚨 ⇨ 84.

Triggered belt pretensioners must be replaced by a workshop. Belt pretensioners can only be triggered once.

Note

Do not affix or install accessories or other objects that may interfere with the operation of the belt pretensioners. Do not make any modifications to belt pretensioner components as this will invalidate the vehicle type approval.

Three-point seat belt

Fastening



Withdraw the belt from the retractor, guide it untwisted across the body and insert the latch plate into the buckle.

Tighten the lap belt regularly whilst driving by pulling the shoulder belt.



Loose or bulky clothing prevents the belt from fitting snugly. Do not place objects such as handbags or mobile phones between the belt and your body.

⚠ Warning

The belt must not rest against hard or fragile objects in the pockets of your clothing.

Height adjustment



1. Pull belt out slightly.
2. Press button.
3. Adjust height and engage.



Adjust the height so that the belt lies across the shoulder. It must not lie across the throat or upper arm.

⚠ Warning

Do not adjust while driving.

Removing



To release belt, press red button on belt buckle.

Seat belts on the rear seats

The seat belt for the rear centre seat can only be withdrawn from the retractor if the backrest is engaged in upright position.

Using seat belt during pregnancy

⚠ Warning

The lap belt must be positioned as low as possible across the pelvis to prevent pressure on the abdomen.

Airbag system

The airbag system consists of a number of individual systems depending on the scope of equipment.

When triggered, the airbags inflate within milliseconds. They also deflate so quickly that it is often unnoticeable during the collision.

Warning

If handled improperly the airbag systems can be triggered in an explosive manner.

Note



The airbag systems and belt pretensioner control electronics are located in the centre console area. Do not put any magnetic objects in this area.

Do not affix any objects onto the airbag covers and do not cover them with other materials.

Each airbag is triggered only once. Have deployed airbags replaced by a workshop. Furthermore, it may be necessary to have the steering wheel, the instrument panel, parts of the panelling, the door seals, handles and the seats replaced.

Do not make any modifications to the airbag system as this will invalidate the vehicle type approval.

When the airbags inflate, escaping hot gases may cause burns.

Control indicator  for airbag systems  84.

Child restraint systems on front passenger seat with airbag systems

Warning according to ECE R94.02:



EN: NEVER use a rearward-facing child restraint on a seat protected by an ACTIVE AIRBAG in front of it; DEATH or SERIOUS INJURY to the CHILD can occur.

DE: Nach hinten gerichtete Kindersitze NIEMALS auf einem Sitz verwenden, der durch einen davor befindlichen AKTIVEN AIRBAG geschützt ist, da dies den TOD oder SCHWERE VERLETZUNGEN DES KINDES zur Folge haben kann.

FR: NE JAMAIS utiliser un siège d'enfant orienté vers l'arrière sur un siège protégé par un COUSSIN GONFLABLE ACTIF placé devant lui,

sous peine d'infliger des BLESSURES GRAVES, voire MORTELLES à l'ENFANT.

ES: NUNCA utilice un sistema de retención infantil orientado hacia atrás en un asiento protegido por un AIRBAG FRONTAL ACTIVO. Peligro de MUERTE o LESIONES GRAVES para el NIÑO.

RU: ЗАПРЕЩАЕТСЯ устанавливать детское удерживающее устройство лицом назад на сиденье автомобиля, оборудованном фронтальной подушкой безопасности, если ПОДУШКА НЕ ОТКЛЮЧЕНА! Это может привести к СМЕРТИ или СЕРЬЕЗНЫМ ТРАВМАМ РЕБЕНКА.

NL: Gebruik NOOIT een achterwaarts gericht kinderzitje op een stoel met een ACTIEVE AIRBAG ervoor, om DODELIJK of ERNSTIG LETSEL van het KIND te voorkomen.

DA: Brug ALDRIG en bagudvendt autostol på et forsæde med AKTIV AIRBAG, BARNET kan komme i LIVSFARE eller komme ALVORLIGT TIL SKADE.

SV: Använd ALDRIG en bakåtvänd barnstol på ett säte som skyddas med en framförvarande AKTIV AIRBAG. DÖDSFALL eller ALLVARLIGA SKADOR kan drabba BARNET.

FI: ÄLÄ KOSKAAN sijoita taaksepäin suunnattua lasten turvaistuinta istuimelle, jonka edessä on AKTIIVINEN TURVATYYNY, LAPSI VOI KUOLLA tai VAMMAUTUA VAKAVASTI.

NO: Bakovervendt barnesikringsutstyr må ALDRI brukes på et sete med AKTIV KOLLISJONSPUTE foran, da det kan føre til at BARNET utsettes for LIVSFARE og fare for ALVORLIGE SKADER.

PT: NUNCA use um sistema de retenção para crianças voltado para trás num banco protegido com um AIRBAG ACTIVO na frente do

mesmo, poderá ocorrer a PERDA DE VIDA ou FERIMENTOS GRAVES na CRIANÇA.

IT: Non usare mai un sistema di sicurezza per bambini rivolto all'indietro su un sedile protetto da AIRBAG ATTIVO di fronte ad esso: pericolo di MORTE o LESIONI GRAVI per il BAMBINO!

EL: ΠΟΤΕ μη χρησιμοποιείτε παιδικό κάθισμα ασφαλείας με φορά προς τα πίσω σε κάθισμα που προστατεύεται από μετωπικό ΕΝΕΡΓΟ ΑΕΡΟΣΑΚΟ, διότι το παιδί μπορεί να υποστεί ΘΑΝΑΣΙΜΟ ή ΣΟΒΑΡΟ ΤΡΑΥΜΑΤΙΣΜΟ.

PL: NIE WOLNO montować fotelika dziecięcego zwróconego tyłem do kierunku jazdy na fotelu, przed którym znajduje się WŁĄCZONA PODUSZKA POWIETRZNA. Niezastosowanie się do tego zalecenia może być przyczyną ŚMIERCI lub POWAŻNYCH OBRAŻEŃ u DZIECKA.

TR: Arkaya bakan bir çocuk emniyet sistemini KESİNLİKLE önünde bir AKTİF HAVA YASTIĞI ile korumakta olan bir koltukta kullanmayınız. ÇOCUK ÖLEBİLİR veya AĞIR ŞEKİLDE YARALANABİLİR.

UK: НИКОЛИ не використовуйте систему безпеки для дітей, що встановлюється обличчям назад, на сидінні з УВИМКНЕНОЮ ПОДУШКОЮ БЕЗПЕКИ, інакше це може призвести до СМЕРТІ чи СЕРІОЗНОГО ТРАВМУВАННЯ ДИТИНИ.

HU: SOHA ne használjon hátrafelé néző biztonsági gyerekülést előlről AKTÍV LÉGZSÁKKAL védett ülésen, mert a GYERMEK HALÁLÁT vagy KOMOLY SÉRÜLÉSÉT okozhatja.

HR: NIKADA nemojte koristiti sustav zadržavanja za djecu okrenut prema natrag na sjedalu s AKTIVNIM ZRAČNIM JASTUKOM ispred njega, to bi moglo dovesti do SMRTI ili OZBILJNIH OZLJEDA za DIJETE.

SL: NIKOLI ne nameščajte otroškega varnostnega sedeža, obrnjenega v nasprotni smeri vožnje, na sedež z AKTIVNO ČELNO ZRAČNO BLAZINO, saj pri tem obstaja nevarnost RESNIH ali SMRTNIH POŠKODB za OTROKA.

SR: NIKADA ne koristiti bezbednosni sistem za decu u kome su deca okrenuta unazad na sedištu sa AKTIVNIM VAZDUŠNIM JASTUKOM ispred sedišta zato što DETE može da NASTRADA ili da se TEŠKO POVREDI.

MK: НИКОГАШ не користете детско седиште свртено наназад на седиште заштитено со АКТИВНО ВОЗДУШНО ПЕРНИЧЕ пред него, зато што детето може ДА ЗАГИНЕ или да биде ТЕШКО ПОВРЕДЕНО.

BG: НИКОГА не използвайте детска седалка, гледаща назад, върху седалка, която е защитена чрез АКТИВНА ВЪЗДУШНА ВЪЗГЛАВНИЦА пред нея - може да се стигне до СМЪРТ или СЕРИОЗНО НАРАНЯВАНЕ на ДЕТЕТО.

RO: Nu utilizați NICIODATĂ un scaun pentru copil îndreptat spre partea din spate a mașinii pe un scaun protejat de un AIRBAG ACTIV în fața sa; acest lucru poate duce la DECESUL sau VĂTĂMAREA GRAVĂ a COPILULUI.

CS: NIKDY nepoužívejte dětský zádržný systém instalovaný proti směru jízdy na sedadle, které je chráněno před sedadlem AKTIVNÍM AIRBAGEM. Mohlo by dojít k VÁŽNĚMU PORANĚNÍ nebo ÚMRTÍ DÍTĚTE.

SK: NIKDY nepoužívajte detskú sedačku otočenú vzad na sedadle chránenom AKTÍVNÝM AIRBAGOM, pretože môže dôjsť k SMRTI alebo VÁŽNYM ZRANENIAM DIEŤAŤA.

LT: JOKIU BŪDU nemontuokite atgal atgręžtos vaiko tvirtinimo sistemas sėdynėje, prieš kurią įrengta AKTYVI ORO PAGALVĖ, nes VAIKAS GALI ŽŪTI arba RIMTAI SUSIŽALOTI.

LV: NEKĀDĀ GADĪJUMĀ neizmantojiet uz aizmuguri vērstu bērnu sēdekļi sēdvietā, kas tiek aizsargāta ar tās priekšā uzstādītu

AKTĪVU DROŠĪBAS SPILVENU, jo pretējā gadījumā BĒRNS var gūt SMAGAS TRAUMAS vai IET BOJĀ.

ET: ĀRGE kasutage tahapoole suunatud lapseturvaistet istmel, mille ees on AKTIIVSE TURVAPADJAGA kaitstud iste, sest see vōib pōhjustada LAPSE SURMA vōi TŌSISE VIGASTUSE.

MT: QATT tuža tražžin għat-ťfal li jħares lejn in-naħa ta' wara fuq sit protett b'AIRBAG ATTIV quddiemu; dan jista' jikkawħa I-MEWT jew ĠRIEħI SERJI lit-TFAL.

Beyond the warning required by ECE R94.02, for safety reasons never use a forward-facing child restraint system on the passenger seat with an active front airbag.

⚠ Danger

Do not use a child restraint system on the passenger seat with active front airbag.

The warning label is located on both sides of the front passenger sun visor.

Airbag deactivation ⇨ 46.

Front airbag system

The front airbag system consists of one airbag in the steering wheel and one in the instrument panel on the front passenger side. These can be identified by the word **AIRBAG**.

The front airbag system is triggered in the event of a front-end impact of a certain severity. The ignition must be switched on.

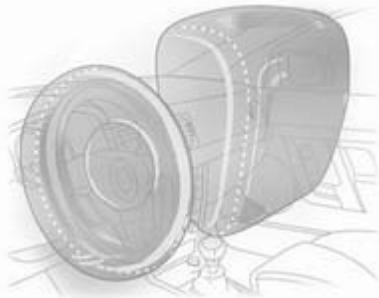

The inflated airbags cushion the impact, thereby reducing the risk of injury to the upper body and head of the front seat occupants considerably.

⚠ Warning

Optimum protection is only provided when the seat is in the proper position.

Seat position ⇨ 34.

Keep the area in which the airbag inflates clear of obstructions.

Fit the seat belt correctly and engage securely. Only then is the airbag able to protect.

Side airbag system



The side airbag system consists of an airbag in each front seat backrest. This can be identified by the word **AIRBAG**.

The side airbag system is triggered in the event of a side impact of a certain severity. The ignition must be switched on.

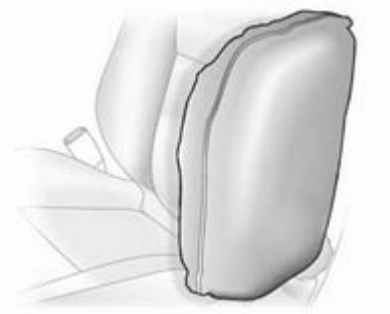

The inflated airbags cushion the impact, thereby reducing the risk of injury to the upper body and pelvis in the event of a side-on collision considerably.

⚠ Warning

Keep the area in which the airbag inflates clear of obstructions.

Note

Only use protective seat covers that have been approved for the vehicle. Be careful not to cover the airbags.

Curtain airbag system

The curtain airbag system consists of an airbag in the roof frame on each side. This can be identified by the word **AIRBAG** on the roof pillars.



The curtain airbag system is triggered in the event of a side-on impact of a certain severity. The ignition must be switched on.

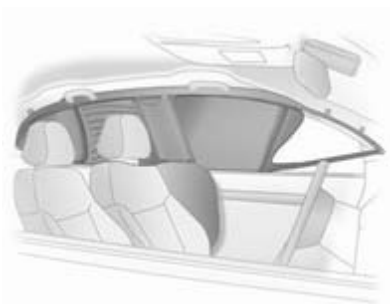

The inflated airbags cushion the impact, thereby reducing the risk of injury to the head in the event of a side-on impact considerably.

Warning

Keep the area in which the airbag inflates clear of obstructions.

The hooks in the roof frame are only suitable for hanging up light articles of clothing, without coat hangers. Do not keep any items in these clothes.

Airbag deactivation

The front passenger airbag system must be deactivated if a child restraint system is to be fitted on this seat. The side airbag and curtain airbag systems, the belt pretensioners and all driver airbag systems will remain active.



The front passenger airbag system can be deactivated via a key-operated switch on the right side of the instrument panel.

Use the ignition key to choose the position:

- OFF** = front passenger airbags are deactivated and will not inflate in the event of a collision. Control indicator **OFF** illuminates continuously in the centre console. A child restraint system can be installed in accordance with the chart **Child restraint installation locations** ⇨ 49. No adult person is allowed to occupy the front passenger seat.
- ON** = front passenger airbags are active. A child restraint system must not be installed.

Danger

Risk of fatal injury for a child using a child restraint system on a seat with activated front passenger airbag.

Risk of fatal injury for an adult person on a seat with deactivated front passenger airbag.



As long as the control indicator  is not illuminated, the front passenger airbag system will inflate in the event of a collision.

Change status only when the vehicle is stopped with the ignition off.

Status remains until the next change.

Control indicator for airbag deactivation ⇨ 84.

Child restraints

Child restraint systems

We recommend the Vauxhall child restraint system which is tailored specifically to the vehicle.

When a child restraint system is being used, pay attention to the following usage and installation instructions and also those supplied with the child restraint system.

Always comply with local or national regulations. In some countries, the use of child restraint systems is forbidden on certain seats.

Warning

When using a child restraint system on the front passenger seat, the airbag systems for the front passenger seat must be deactivated; if not, the triggering of the airbags poses a risk of fatal injury to the child.

This is especially the case if rear-facing child restraint systems are used on the front passenger seat.

Airbag deactivation ⇨ 46.

Airbag label ⇨ 41.

Selecting the right system

The rear seats are the most convenient location to fasten a child restraint system.

Children should travel facing rearwards in the vehicle as long as possible. This makes sure that the child's backbone, which is still very weak, is under less strain in the event of an accident.

Suitable are restraint systems that comply with valid UN ECE regulations. Check local laws and regulations for mandatory use of child restraint systems.

Ensure that the child restraint system to be installed is compatible with the vehicle type.

Ensure that the mounting location of the child restraint system within the vehicle is correct, see following tables.

Allow children to enter and exit the vehicle only on the side facing away from the traffic.

When the child restraint system is not in use, secure the seat with a seat belt or remove it from the vehicle.

Note

Do not affix anything on the child restraint systems and do not cover them with any other materials.

A child restraint system which has been subjected to stress in an accident must be replaced.

Child restraint installation locations

Permissible options for fitting a child restraint system

Weight and age class	On front passenger seat		On rear outboard seats	On rear centre seat
	activated airbag	deactivated airbag		
Group 0: up to 10 kg or approx. 10 months	X	U ¹	U ²	U ²
Group 0+: up to 13 kg or approx. 2 years	X	U ¹	U ²	U ²
Group I: 9 to 18 kg or approx. 8 months to 4 years	X	U ¹	U ²	U ²
Group II: 15 to 25 kg or approx. 3 to 7 years	X	X	U ²	U ²
Group III: 22 to 36 kg or approx. 6 to 12 years	X	X	U ²	U ²

¹ = If the child restraint system is being secured using a three-point seat belt, move seat height adjustment to uppermost position and ensure that vehicle seat belt runs forwards from the upper anchorage point. Adjust seat backrest inclination as far as necessary to a vertical position to ensure that the belt is tight on the buckle side.

² = Move the head restraint to uppermost position. If it interferes with the proper installation of the child restraint system, remove the head restraint ⇨ 33.

U = Universal suitability in conjunction with three-point seat belt.

X = No child restraint system permitted in this weight class.

Permissible options for fitting an ISOFIX child restraint system

Weight class	Size class	Fixture	On front passenger seat	On rear outboard seats	On rear centre seat
Group 0: up to 10 kg	E	ISO/R1	X	IL ¹	X
Group 0+: up to 13 kg	E	ISO/R1	X	IL ¹	X
	D	ISO/R2	X	IL ¹	X
	C	ISO/R3	X	IL ¹	X
Group I: 9 to 18 kg	D	ISO/R2	X	IL ¹	X
	C	ISO/R3	X	IL ¹	X
	B	ISO/F2	X	IL, IUF	X
	B1	ISO/F2X	X	IL, IUF	X
	A	ISO/F3	X	IL, IUF	X
Group II: 15 to 25 kg or approx. 3 to 7 years			X	IL	X
Group III: 22 to 36 kg or approx. 6 to 12 years			X	IL	X

-
- ¹ = Move front passenger seat to the foremost position or adjust front seat backrest inclination as far as necessary to a vertical position to ensure that there is no interference between child restraint system and front seat backrest.
- IL = Suitable for particular ISOFIX restraint systems of the "specific-vehicle", "restricted" or "semi-universal" categories. The ISOFIX restraint system must be approved for the specific vehicle type.
- IUF = Suitable for ISOFIX forward-facing child restraint systems of universal category approved for use in this weight class.
- X = No ISOFIX child restraint system approved in this weight class.

ISOFIX size class and seat device

- A – ISO/F3 = Forward-facing child restraint system for children of maximum size in the weight class 9 to 18 kg.
- B – ISO/F2 = Forward-facing child restraint system for smaller children in the weight class 9 to 18 kg.
- B1 – ISO/F2X = Forward-facing child restraint system for smaller children in the weight class 9 to 18 kg.
- C – ISO/R3 = Rear-facing child restraint system for children of maximum size in the weight class up to 18 kg.
- D – ISO/R2 = Rear-facing child restraint system for smaller children in the weight class up to 18 kg.
- E – ISO/R1 = Rear-facing child restraint system for young children in the weight class up to 13 kg.

ISOFIX child restraint systems

Installation of ISOFIX child restraint systems without permanent guide



Fasten vehicle-approved ISOFIX child restraint systems to the ISOFIX mounting brackets. Specific vehicle ISOFIX child restraint system positions are marked in the table by IL.



ISOFIX mounting brackets are indicated by a label on the backrest.

Installation of ISOFIX child restraint systems with permanent guide



The vehicle might be equipped with guides in front of the mounting brackets to support the installation of the child restraint system.



The covers of the guides will swivel backwards automatically when attaching the child restraint system.

Top-tether fastening eyes

Depending on country specific equipment, the vehicle might have two or three fastening eyes.

Top-Tether fastening eyes are marked with the symbol  for a child restraint.



For non-ISOFIX child restraints, fasten the Top-Tether strap to the Top-Tether fastening eyes. The strap must run between the two guide rods of the head restraint.

For ISOFIX child restraints, fasten the Top-Tether strap to the Top-Tether fastening eyes in addition to the ISOFIX mounting. The strap must run between the two guide rods of the head restraint.

ISOFIX child restraint systems of universal category positions are marked in the table by IUF.

Storage

Storage compartments	54
Load compartment	66
Roof rack system	70
Loading information	70

Storage compartments

⚠ Warning

Do not store heavy or sharp objects in the storage compartments. Otherwise, the storage compartment lid could open and vehicle occupants could be injured by objects being thrown around in the event of hard braking, a sudden change in direction or an accident.

Instrument panel storage



A storage compartment is located next to the steering wheel.

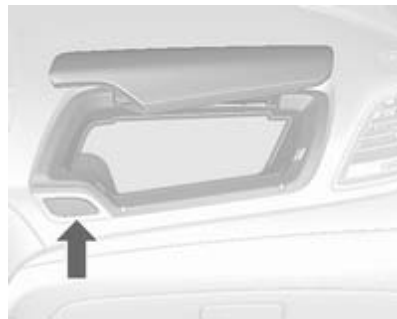

A further storage compartment is located on top of the glovebox.

To open, push the button.

The covers of the storage compartments should be closed while driving.

Glovebox

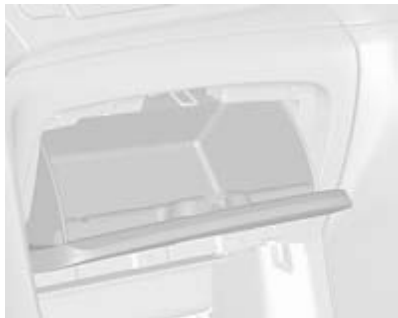

To open, pull the handle.

The glovebox should be closed while driving.

Cupholders



The cupholders are located in the centre console and rear part of the centre console.



To use the rear seat cupholder, pull the strap in the rear seat armrest.

Sunglasses storage

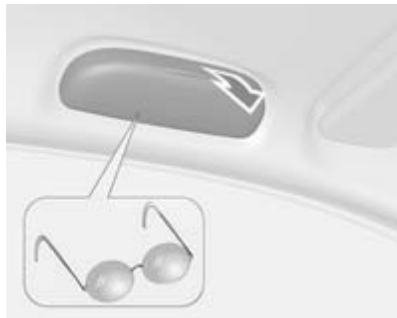

Fold down and open.
Do not use for storing heavy objects.

Underseat storage

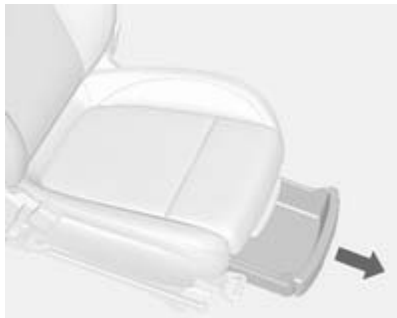

Lift drawer at the front and pull out. To close, push the drawer in and engage.

Centre console storage

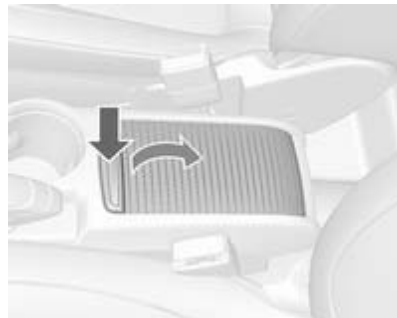

Push down the button and slide cover backwards.

Rear carrier system

Rear carrier system for three bicycles



The rear carrier system (Flex-Fix system) allows one bicycle to be attached to a pull-out carrier integrated into the vehicle floor. It is possible to attach two further bicycles on an adapter. The transportation of other objects is not permitted.

The maximum load of the rear carrier system is 60 kg with attached adapter and 30 kg without attached adapter. This allows the attachment of an

electrically-powered bicycle to the pull-out carrier. The maximum load per bicycle on the adapter is 20 kg. The wheelbase of a bicycle must not exceed 1.15 metres. Otherwise the secure fastening of a bicycle is not possible.

If not in use, the carrier system must be slid back into the vehicle floor.

There must not be any objects on the bicycles that could become loose during transportation.

Caution

If the rear carrier system is extended and the vehicle is fully loaded, the chassis clearance will be reduced.

Drive carefully whenever the road has a strong inclination or when driving over a ramp, bump, etc.

Caution

Consult your bicycle dealer before attaching bicycles with carbon frames. The bicycles might get damaged.

Extending

Open the tailgate.

⚠ Warning

No-one should be in the extension zone of the rear carrier system, risk of injury.

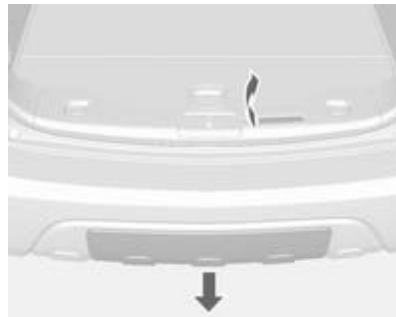

Pull release lever up. The rear carrier system disengages and travels quickly out of the rear bumper.



Completely pull out the rear carrier system until you hear it engage.

Ensure that it is not possible to push in the rear carrier system without pulling the release lever again.

⚠ Warning

It is only permissible to fit objects to the rear carrier system if the system has been correctly engaged. If the rear carrier system

will not engage correctly, do not fit objects to the system and slide the system back. Seek the assistance of a workshop.

Unfold number plate holder



Lift the number plate holder and fold it backwards.

Affix the number plate before first usage of the rear carrier system.

Fold out tail lamps

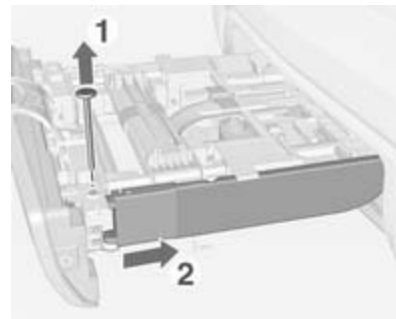

To install the tail lamps, remove both screws (1). Pull tail lamps out of the retainer to the front (2) and downwards and swivel them to the side.

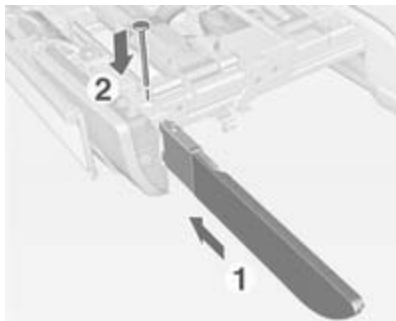

Push the tail lamps into the retainer (1) and reinstall screws (2) to fix the lamps.

Fold out wheel recess



Remove strap and fold out the wheel recess.

Lock the rear carrier system

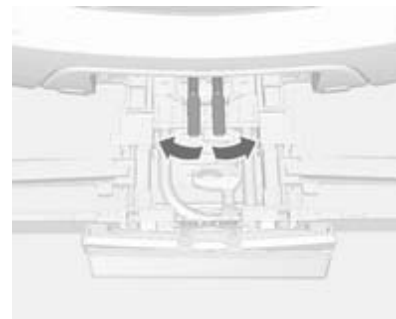

Remove strap and swivel both clamping levers sideways as far as they will go.

Otherwise safe functionality is not guaranteed.

Assembling the bicycle rack

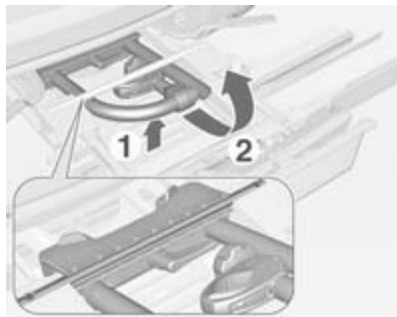

Lift the rack at the rear (1) and pull it backwards.

Fold up the rack (2).

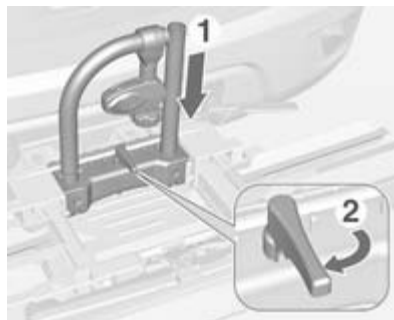

Push down the rack (1) and swivel handle (2) backwards to engage.

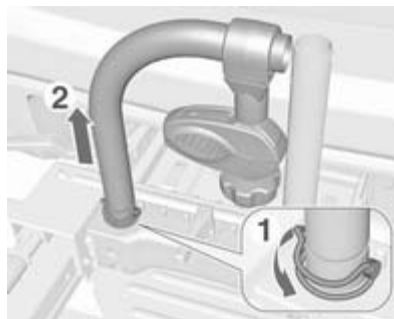

Swivel clamp sideways (1) and pull out locking pin.

Remove left part of rack (2).

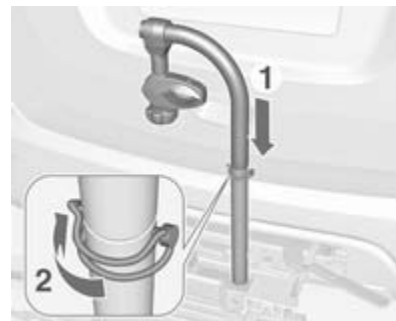

Insert left part of rack into the right part (1).

Insert locking pin in and swivel clamp sideways (2).

Attaching a bicycle



1. Rotate the pedals into position, as shown in the illustration, and put the bicycle on the wheel recess. Make sure that the bicycle stands centrally on the wheel recesses.



2. Attach the short mounting bracket to the bicycle frame. Turn the knob clockwise to fasten.



3. Secure both bicycle wheels to the wheel recesses using the strap retainers.
4. Check the bicycle to make sure it is secure.

Caution

Ensure gap between bicycle and vehicle is at least 5 cm. If necessary, loosen handlebar and swivel sideways.

Attaching the adapter

When carrying more than one bicycle, the adapter must be fixed.



1. Apply the adapter to the rear carrier system, as shown in the illustration.

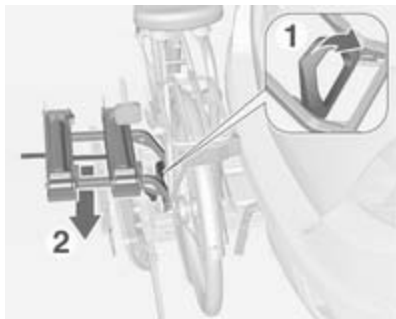

2. Turn the lever (1) forwards and hold, then lower the adapter (2) at the rear.
3. Release lever and check if the adapter is engaged securely.

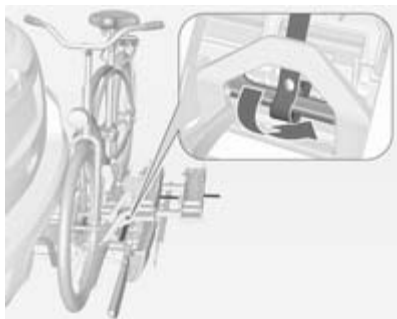

4. Guide the strap attached to the adapter underneath the lever when folding back the rear carrier system. Fasten the strap.

Attaching further bicycles

The attachment of further bicycles is similar to the attachment of the first bicycle. Additionally some steps must be considered:

1. Before putting on the bicycle, always unfold the wheel recesses for the next bicycle if necessary.
2. Always rotate the pedals into an appropriate position before putting on the bicycle.

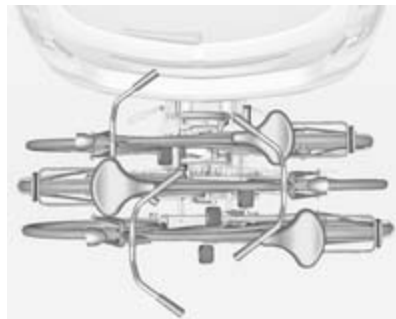

3. Position the bicycles on the rear carrier system alternately aligned to the left and to the right.
4. Align the bicycles to the one attached before. The wheel hubs of the bicycles must not touch each other.
5. Attach the bicycles with mounting brackets and strap retainers as described for the first bicycle. The mounting brackets should be fixed in parallel.

Use the long mounting bracket to attach the second bicycle to the rack.



Use the short accessory mounting bracket to attach the third bicycle. The bracket must be fixed between the frames of the second and third bicycle.

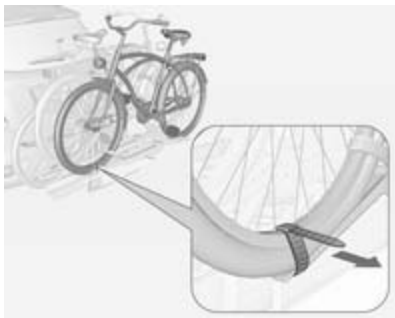

6. Additionally secure both bicycle wheels of the third bicycle to the wheel recesses using the tensioning straps.

It is recommended to attach a warning sign at the rearmost bicycle, to increase visibility.

Fold the rear carrier system backwards

The rear carrier system can be folded backwards to gain access to the load compartment.

- Without attached adapter:

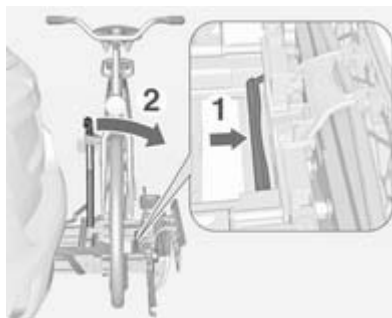

Push the lever (1) to disengage and hold.

Pull the rack (2) backwards to fold the rear carrier system.

- With attached adapter:

Warning

Take care when disengaging the rear carrier system as it will tilt backwards. Risk of injury.

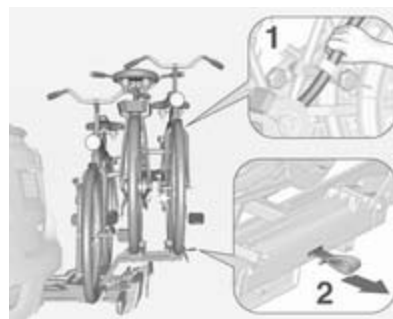

Hold frame (1) of rearmost bicycle with one hand and pull the loop (2) to disengage.

Hold rearmost bicycle with both hands and fold the rear carrier system backwards.

To increase visibility, the tail lights of the vehicle are activated when the rear carrier system is folded back.

⚠ Warning

When folding the rear carrier system forwards again, take care that the system is engaged securely.

Removing bicycles

Undo strap retainers on both bicycle tyres.

Turn knob anti-clockwise and remove mounting brackets.

Detaching adapter

Detach the adapter before removing the bicycle on the rear carrier system.

1. Fold in wheel recesses.

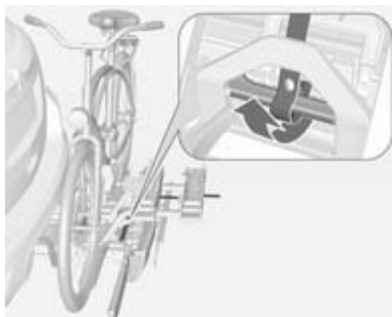

2. Unbutton the strap.



3. Turn the lever (1) forwards and hold.
4. Lift the adapter (2) at the rear and remove.

Disassembling the bicycle rack

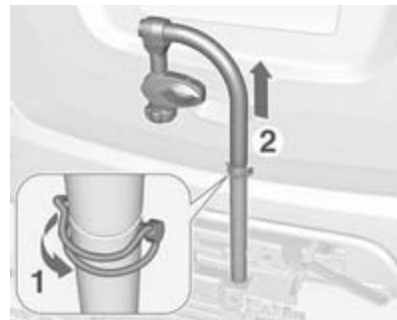

Swivel clamp sideways (1) and pull out locking pin. Remove upper part of rack (2).



Reinstall rack (1). Insert locking pin and swivel clamp sideways (2).

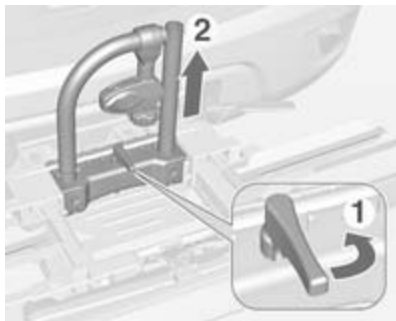

Arrange mounting brackets as shown in the illustration.

Swivel handle (1) sideways to disengage and lift the rack (2).

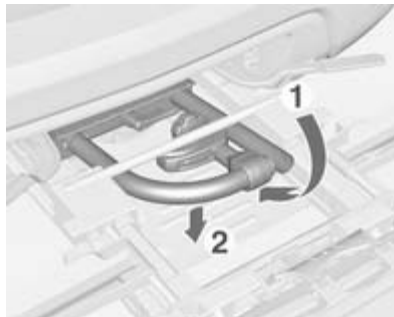

Fold the rack backwards, then push forwards until it stops (1).

Press the rack down at the rear (2).

Fold in wheel recess

Fold in wheel recess. Fasten strap.

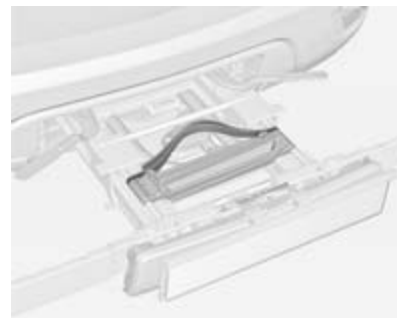

Stow the strap retainers accurately.

Unlock the rear carrier system



Swivel both clamping levers inwards as far as they will go. Fasten strap.

Fold in tail lamps

Remove both screws. Pull tail lamps out of the retainer and swivel them forwards.

Push the tail lamps into the retainer and reinstall screws to fix the lamps

Fold in number plate holder

Lift the number plate holder and fold it forwards.

Retracting the rear carrier system

Caution

Take care that all foldable parts, e.g. wheel recesses and mounting brackets, are stowed accurately. Otherwise the rear carrier system might get damaged when trying to retract it.



Push the release lever up and hold. Lift the system slightly and push it into the bumper until it engages.

Release lever must return to original position.

Warning

If the system cannot be correctly engaged, please seek the assistance of a workshop.

Load compartment

Load compartment extension

Caution

First turn down the rear seat cushion before folding the rear seat backrest.

Disregard may lead to damage to the rear seat.

1. Push head restraints down by pressing the catch.

Note

To ensure enough room for rear seat cushion operation, slide the front seat forward and move the front seat backrest upright.

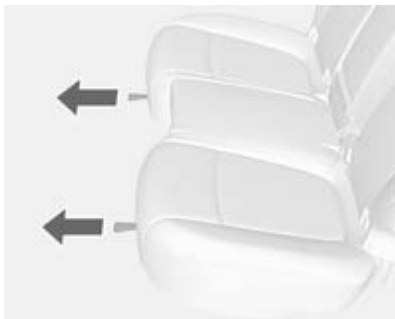

2. Pull the strap under the seat cushion and turn down the seat cushion.



3. Pull the release lever on top of the rear backrest.



4. Fold the backrest forward and down.



5. Put the seat belts for the outboard seats into the belt guides.

To return the backrest to the original position, pull out the seat belt from the belt guides and lift backrest up.

Push backrest firmly into place.

Warning

When folding up, ensure that backrests are securely locked in position before driving. Failure to do so may result in personal injury or damage to the load or vehicle in the event of hard braking or a collision.

Make sure the seat belts are not pinched by the latch.

The centre rear seat belt may lock when you raise the backrest. If this happens, let the belt go back all the way and repeat operation.

If the seat belt is still locked, turn down the seat cushion and try again.

To return the rear seat cushion, put the rear part of the seat cushion in its original position ensuring that the

seat belt buckle straps are not twisted or caught under the seat cushion, then push the front part of the seat cushion firmly down until it latches.

Caution

When returning rear seat backrest to the upright position, place the rear seat belt and buckles between the rear seat backrest and one cushion. Make sure the rear seat belt and buckles do not get pinched under the rear seat cushion.

Make sure the seat belts are not twisted or caught in the seat backrest and are arranged in their proper position.

Load compartment cover



Do not place any objects on the cover.

Removing

Unhook retaining straps from tailgate.

Lift cover at the rear and push it upwards at the front.

Remove the cover.

Fitting

Engage cover in side guides and fold downwards.

Attach retaining straps to tailgate.

Rear floor storage cover

Rear floor cover



Grasp the handle and lift the cover.



Mount the cover to the hook at the sidewall.

Lashing eyes

The lashing eyes are designed to secure items against slippage, e.g. using lashing straps or luggage net.

Warning triangle

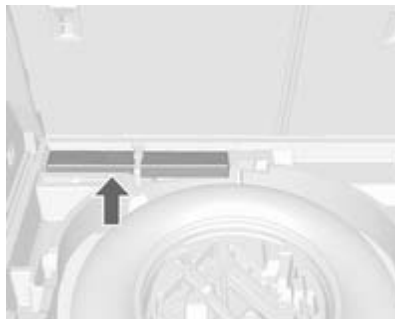

Stow the warning triangle below the floor cover in the load compartment. Secure it by the strap.

First aid kit



Stow the first aid kit in the storage compartment at the left sidewall of the load compartment.

Roof rack system

Roof rack



The roof rack has side rails attached to the roof.

For safety reasons and to avoid damage to the roof, the vehicle approved roof rack system is recommended. For further information contact your workshop.

Loading information

- Heavy objects in the load compartment should be placed against the seat backrests. Ensure the backrests are securely engaged. If objects can be stacked, the heavier objects should be placed at the bottom.
- Secure objects with lashing straps attached to the lashing eyes ⇨ 69.
- Secure loose objects in load compartment to prevent sliding.
- When transporting objects in the load compartment, the backrests of the rear seats must not be angled forward.
- Do not allow the load to protrude above the upper edge of the backrests.
- Do not place any objects on the load compartment cover or the instrument panel, and do not cover the sensor on top of the instrument panel.

- The load must not obstruct the operation of the pedals, parking brake and gear selector, or hinder the freedom of movement of the driver. Do not place any unsecured objects in the interior.
- Do not drive with an open load compartment.

Warning

Always make sure that the load in the vehicle is securely stowed. Otherwise objects can be thrown around inside the vehicle and cause personal injury or damage to the load or vehicle.

- The payload is the difference between the permitted gross vehicle weight (see identification plate ⇨ 197) and the EC kerb weight.

To calculate the payload, enter the data for your vehicle in the Weights table at the front of this manual.

The EC kerb weight includes weights for the driver (68 kg),

luggage (7 kg) and all fluids (tank 90 % full).

Optional equipment and accessories increase the kerb weight.

- Driving with a roof load increases the sensitivity of the vehicle to cross-winds and has a detrimental effect on vehicle handling due to the vehicle's higher centre of gravity. Distribute the load evenly and secure it properly with retaining straps. Adjust the tyre pressure and vehicle speed according to the load conditions. Check and retighten the straps frequently.

Do not drive faster than 75 mph.

- The permissible roof load is 75 kg. The roof load is the combined weight of the roof rack and the load.

Instruments and controls

Controls	72
Warning lights, gauges and indicators	79
Information displays	89
Vehicle messages	94
Trip computer	96
Vehicle personalisation	99

Controls

Steering wheel adjustment



Unlock lever, adjust steering wheel, then engage lever and ensure it is fully locked.

Do not adjust steering wheel unless vehicle is stationary and steering wheel lock has been released.

Steering wheel controls



The Infotainment system and the cruise control can be operated via the controls on the steering wheel.

Further information is available in the Infotainment system manual.

Cruise control ⇨ 133

Heated steering wheel



Activate heating by pressing  button. Activation is indicated by the LED in the button.

Heating is operational when the engine is running.

Horn



Press .

Windscreen wiper/washer

Windscreen wiper

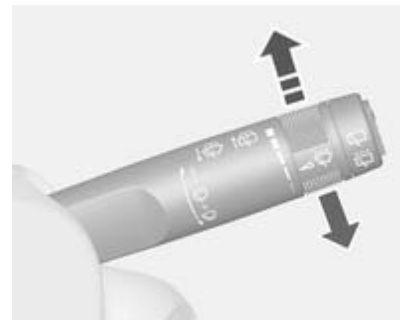

2 = fast

1 = slow

 = interval wiping

 = off

For a single wipe when the windscreen wiper is off, press the lever down.

Do not use if the windscreen is frozen.
Switch off in car washes.

Adjustable wiper interval





Wiper lever in position .

Turn the adjuster wheel to adjust the desired wipe interval:

- short interval = turn adjuster wheel upwards
- long interval = turn adjuster wheel downwards

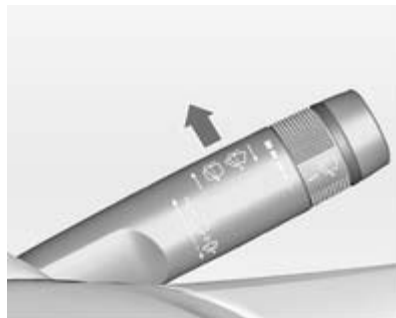
Automatic wiping with rain sensor



 = automatic wiping with rain sensor

The rain sensor detects the amount of water on the windscreen and automatically regulates the frequency of the windscreen wiper.

Adjustable sensitivity of the rain sensor



Turn the adjuster wheel to adjust the sensitivity:

- low sensitivity = turn adjuster wheel downwards
- high sensitivity = turn adjuster wheel upwards

Keep the sensor free from dust, dirt and ice.

Windscreen washer



Pull lever. Washer fluid is sprayed onto the windscreen and the wiper wipes a few times.

Rear window wiper/washer



Press the rocker switch to activate the rear window wiper:

upper position	=	continuous operation
lower position	=	intermittent operation
middle position	=	off



Push lever. Washer fluid is sprayed onto the rear window and the wiper wipes a few times.

Do not use if the rear window is frozen.

Switch off in car washes.

The rear window wiper comes on automatically when the windscreen wiper is switched on and reverse gear is engaged.

Activation or deactivation of this function can be changed in the menu **Settings** in the Info-Display.

Vehicle personalisation ⇨ 99.

The rear window washer system is deactivated when the fluid level is low.

Outside temperature

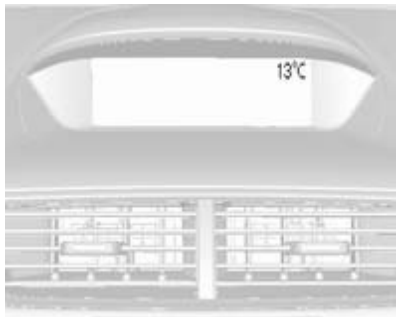

A drop in temperature is indicated immediately and a rise in temperature after a time delay.

If outside temperature drops to 0.5 °C, a warning message is displayed in the Driver Information Centre with Uplevel-Combi-Display.

⚠ Warning

The road surface may already be icy even though the display indicates a few degrees above 0 °C.

Clock

Date and time are shown in the Info-Display.

Set date and time CD 400

Press the **CONFIG** button. The menu **Settings** is displayed.

Select **Time Date**.

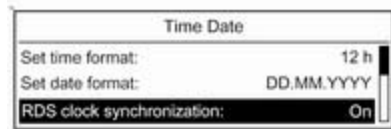

20136

Selectable setting options:

- **Set time:** Changes the time shown on the display.
- **Set date:** Changes the date shown on the display.
- **Set time format:** Changes indication of hours between **12 h** and **24 h**.
- **Set date format:** Changes indication of date between **MM/DD/YYYY** and **DD.MM.YYYY**.

- **Display clock:** Switches on/off indication of time on the display.
- **RDS clock synchronization:** The RDS signal of most VHF transmitters automatically sets the time. RDS time synchronisation can take a few minutes. Some transmitters do not send a correct time signal. In such cases, it is recommended to switch off automatic time synchronisation.

Vehicle personalisation ⇨ 99.

Time and date settings

CD 600/Navì 950

Press the **CONFIG** button and then select the **Time and Date** menu item to display the respective submenu.

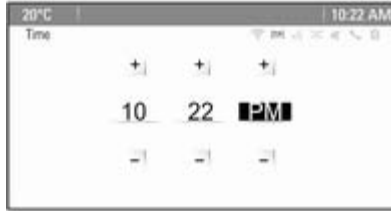

Note

If **RDS Auto Time Adjust** is activated, time and date are automatically set by the system.

See Infotainment system manual for further information.

Set time

To adjust the time settings, select the **Set Time** menu item. Turn the multifunction knob to adjust the first setting.

Press the multifunction knob to confirm the input. The coloured background moves to the next setting.

Adjust all settings.

Set date

To adjust the time settings, select the **Set Date** menu item. Turn the multifunction knob to adjust the first setting.

Press the multifunction knob to confirm the input. The coloured background moves to the next setting.

Adjust all settings.

Time format

To choose the desired time format, select **12 hr / 24 hr Format**. Activate **12 Hour** or **24 Hour**.

Vehicle personalisation ⇨ 99.

Power outlets



A 12 Volt power outlet is located in the front console.

Do not exceed the maximum power consumption of 120 watts.



A 230 Volt power outlet is located in the rear console.

Do not exceed the maximum power consumption of 150 watts.

With ignition off the power outlet is deactivated.

Additionally the power outlet is deactivated in case of low battery voltage.

Electrical accessories that are connected must comply with the electromagnetic compatibility requirements laid down in DIN VDE 40 839.

Caution

Do not connect any current-delivering accessories, e.g. electrical charging devices or batteries.

Do not damage the sockets by using unsuitable plugs.

Warning lights, gauges and indicators

Speedometer



Indicates vehicle speed.

Odometer



The bottom line displays the recorded distance.

Trip odometer

The top line displays the recorded distance since the last reset.

To reset, press the **SET/CLR** button on the turn signal lever for a few seconds ↷ 89.

Trip odometer counts up to a distance of 2000 miles then resets to 0.

Tachometer



Displays the engine speed.

Drive in a low engine speed range for each gear as much as possible.

Caution

If the needle is in the red warning zone, the maximum permitted engine speed is exceeded. Engine at risk.

Fuel gauge



Displays the fuel level or gas level in the tank depending on the operation mode.

Control indicator ● illuminates if the level in the tank is low. Refuel immediately if it flashes.

During liquid gas operation, the system automatically switches over to petrol operation when gas tanks are empty ⇨ 80.

Never run the tank dry.

Because of the fuel remaining in the tank, the top-up quantity may be less than the specified tank capacity.

Fuel selector



Press button **LPG** to switch between petrol and liquid gas operation. The LED in the button shows the current operating mode.

LED off	= petrol operation
LED illuminates	= liquid gas operation
LED flashes	= no switching is possible, one type of fuel is empty

As soon as the liquid gas tank is empty, petrol operation is automatically engaged until the ignition is switched off.

Fuel for liquid gas operation ⇨ 146.

Engine coolant temperature gauge



Displays the coolant temperature.

left area	= engine operating temperature not yet reached
central area	= normal operating temperature
right area	= temperature too high

Caution

If engine coolant temperature is too high, stop vehicle, switch off engine. Danger to engine. Check coolant level.

Service display

The engine oil life system lets you know when to change the engine oil and filter. Based on driving conditions, the interval at which an engine oil and filter change will be indicated can vary considerably.



In the Uplevel-Combi-Display, the remaining oil life duration is displayed in the **Vehicle Information Menu**.

In the Midlevel-Display, the remaining engine oil life duration is displayed by the control indicator , therefore the ignition must be switched on, with the engine off.

The menu and function can be selected via the buttons on the turn signal lever.

To display the remaining engine oil life duration:



Press the **MENU** button to select the **Vehicle Information Menu**.

Turn the adjuster wheel to select **Remaining Oil Life**.

The system must be reset every time the engine oil is changed to ensure proper functionality. Seek the assistance of a workshop.

Press the **SET/CLR** button to reset. Therefore the ignition must be switched on, with the engine off.

When the system has calculated that engine oil life has been diminished, **Change Engine Oil Soon** or a warning code appears in the Driver Information Centre. Have engine oil and filter changed by a workshop within one week or 300 miles (whichever occurs first).

Driver Information Centre ⇨ 89.

Service information ⇨ 194.

Control indicators

The control indicators described are not present in all vehicles. The description applies to all instrument versions. Depending on the equipment, the position of the control indicators may vary. When the

ignition is switched on, most control indicators will illuminate briefly as a functionality test.

The control indicator colours mean:

red = danger, important
reminder

yellow = warning, information, fault

green = confirmation of activation

blue = confirmation of activation

white = confirmation of activation

Control indicators in the instrument cluster

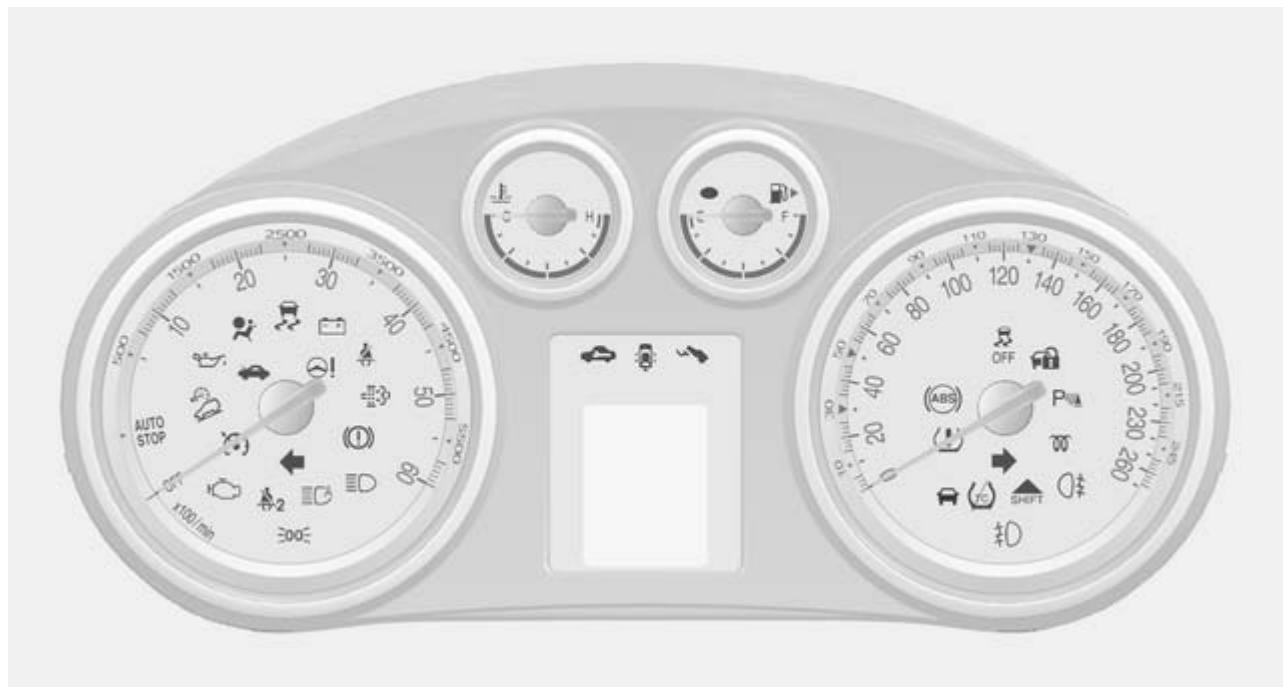

Control indicators in the centre console



Turn signal

↔ illuminates or flashes green.

Illuminates briefly

The parking lights are switched on.

Flashes

A turn signal or the hazard warning flashers are activated.

Rapid flashing: failure of a turn signal light or associated fuse, failure of turn signal light on trailer.

Bulb replacement ↗ 162, Fuses ↗ 168.

Turn signals ↗ 108.

Seat belt reminder

👤 for driver's seat illuminates or flashes red.

👤 for front passenger seat illuminates or flashes red, when seat is occupied.

👤👤 for rear seats illuminate in the Driver Information Centre (DIC).

When the ignition is switched on, the indicator light illuminates for several seconds.

If seat belt becomes unbuckled when the vehicle is moving, the indicator light illuminates.

If the seat belt is buckled, the indicator light extinguishes.

Three-point seat belts ↗ 39.

Airbag and belt tensioners

👤 illuminates red.

When the ignition is switched on, the control indicator illuminates for a few seconds. If it does not illuminate, does not go out after a few seconds or illuminates whilst driving, there is a fault in the airbag system. Seek the assistance of a workshop. The airbags and belt pretensioners may fail to trigger in the event of an accident.

Deployment of the belt pretensioners or airbags is indicated by continuous illumination of 👤.

⚠ Warning

Have the cause of the fault remedied immediately by a workshop.

Belt pretensioners, airbag system ↗ 38, ↗ 41.

Airbag deactivation

👤 illuminates yellow.

The front passenger airbag is activated.

 illuminates yellow.

The front passenger airbag is deactivated ⇨ 46.

Danger

Risk of fatal injury for a child using a child restraint system together with activated front passenger airbag.

Risk of fatal injury for an adult person with deactivated front passenger airbag.

Charging system

 illuminates red.

Illuminates when the ignition is switched on and extinguishes shortly after the engine starts.

Illuminates when the engine is running

Stop, switch off engine. Battery is not charging. Engine cooling may be interrupted. The brake servo unit may cease to be effective. Seek the assistance of a workshop.

Malfunction indicator light

 illuminates or flashes yellow.

Illuminates when the ignition is switched on and extinguishes shortly after the engine starts.

Illuminates when the engine is running

Fault in the emission control system. The permitted emission limits may be exceeded. Seek the assistance of a workshop immediately.

Flashes when the engine is running

Fault that could lead to catalytic converter damage. Ease up on the accelerator until the flashing stops. Seek the assistance of a workshop immediately.

Service vehicle soon

 illuminates yellow.

Additionally a warning message or a warning code is displayed.

The vehicle needs a service.

Seek the assistance of a workshop. Vehicle messages ⇨ 94.

Brake and clutch system

 illuminates red.

The brake and clutch fluid level is too low ⇨ 159.

Warning

Stop. Do not continue your journey. Consult a workshop.

Illuminates after the ignition is switched on if the parking brake is applied ⇨ 130.

Operate pedal

 illuminates or flashes yellow.

Illuminates

Clutch pedal must be depressed to start the engine in Autostop mode. Stop-start system ⇨ 120.

Flashes

Clutch pedal must be depressed for a main start of the engine ↷ 16, ↷ 119.

Antilock brake system (ABS)

 illuminates yellow.

Illuminates for a few seconds after the ignition is switched on. The system is ready for operation when the control indicator extinguishes.

If the control indicator does not extinguish after a few seconds, or if it illuminates while driving, there is a fault in the ABS. The brake system remains operational but without ABS regulation.

Antilock brake system ↷ 129.

Upshift

 illuminates green or is shown as a symbol in the Driver Information Centre with Uplevel-Combi-Display when upshifting is recommended for fuel saving reasons.

ECO drive assistant ↷ 96.

Descent control system

 illuminates or flashes green.

Descent control system ↷ 132

Illuminates

The system is ready for operation.

Flashes

The system is activated.

Power steering

 illuminates yellow.

It illuminates when the ignition is switched on and extinguishes shortly after the engine starts.

If the indicator does not extinguish after a few seconds, or if it illuminates while driving, there is a failure in the power steering system.

Seek the assistance of a workshop.

Lane departure warning

 illuminates green or yellow or flashes yellow.

Illuminates green

System is switched on and ready to operate.

Illuminates yellow

Failure in the system. Seek the assistance of a workshop.

Flashes yellow

System recognises an unintended lane change.

Ultrasonic parking assist

 illuminates yellow.

Fault in system

or

Fault due to sensors that are dirty or covered by ice or snow

or

Interference due to external sources of ultrasound. Once the source of interference is removed, the system will operate normally.

Have the cause of the fault in the system remedied by a workshop.

Ultrasonic parking assist ↷ 138.

Electronic Stability Control off

 illuminates yellow.

The system is deactivated.

Electronic Stability Control and Traction Control system

 illuminates or flashes yellow.



Illuminates

A fault in the system is present. Continued driving is possible. Driving stability, however, may deteriorate depending on road surface conditions.

Have the cause of the fault remedied by a workshop.

Flashes

The system is actively engaged. Engine output may be reduced and the vehicle may be braked automatically to a small degree.

Electronic Stability Control  131,
Traction Control system  131.

Traction Control system off

 illuminates yellow.

The system is deactivated.

Preheating

 illuminates yellow.

Preheating is activated. Only activates when outside temperature is low.

Diesel particle filter

 illuminates or flashes yellow.

The diesel particle filter requires cleaning.

Continue driving until  extinguishes. If possible, do not allow engine speed to drop below 2000 rpm.

Illuminates

The diesel particle filter is full. Start cleaning process as soon as possible.

Flashes

The maximum filling level of the filter is reached. Start cleaning process immediately to avoid damage to the engine.

Diesel particle filter  123, Stop-start system  120.

Tyre pressure monitoring system

 illuminates or flashes yellow.

Illuminates

Tyre pressure loss. Stop immediately and check tyre pressure.

Flashes

Fault in system or tyre without pressure sensor mounted (e.g. spare wheel). After 60-90 seconds the control indicator illuminates continuously. Consult a workshop.

Tyre pressure monitor system  175.

Engine oil pressure

 illuminates red.

Illuminates when the ignition is switched on and extinguishes shortly after the engine starts.

Illuminates when the engine is running

Caution

Engine lubrication may be interrupted. This may result in damage to the engine and/or locking of the drive wheels.

1. Depress clutch.
2. Select neutral gear, set selector lever to **N**.
3. Move out of the flow of traffic as quickly as possible without impeding other vehicles.
4. Switch off ignition.

Warning

When the engine is off, considerably more force is needed to brake and steer. During an Autostop the brake servo unit will still be operational.

Do not remove key until vehicle is stationary, otherwise the steering wheel lock could engage unexpectedly.

Check oil level before seeking the assistance of a workshop  156.

Low fuel

 illuminates or flashes yellow.

Illuminates

Level in fuel tank is too low.

Flashes

Fuel used up. Refuel immediately. Never run the tank dry.

Catalytic converter  124.

Bleeding the diesel fuel system  161.

Immobiliser

 flashes yellow.

Fault in the immobiliser system. The engine cannot be started.

Have the cause of the fault remedied by a repairer.



Exterior light

 illuminates green.

The exterior lights are on  103.

High beam

 illuminates blue.

Illuminates when high beam is on or during headlight flash  104, or when high beam is on with high beam assist, adaptive forward lighting  106.

Adaptive forward lighting

 illuminates or flashes yellow.

Illuminates

The adaptive forward lighting system needs a service.

Seek the assistance of a workshop.
Adaptive forward lighting ⇨ 106.

Flashes

System switched to symmetrical low beam.

Control indicator  flashes for approx. 4 seconds after the ignition is switched on as a reminder that the system has been activated ⇨ 104.
Automatic light control ⇨ 103.

Fog light

 illuminates green.
The front fog lights are on ⇨ 108.

Rear fog light

 illuminates yellow.
The rear fog light is on ⇨ 109.

Cruise control

 illuminates white or green.

Illuminates white

The system is on.

Illuminates green

Cruise control is active.
Cruise control ⇨ 133.

Vehicle detected ahead

 illuminates green.
A vehicle ahead is detected in the same lane.
Forward collision alert ⇨ 136.

Bonnet open

 illuminates when the bonnet is open on vehicles with stop-start system.
Stop-start system ⇨ 120.

Door open

 illuminates red.
A door or the tailgate is open.

Information displays

Driver Information Centre

The Driver Information Centre (DIC) is located in the instrument cluster between speedometer and tachometer. It is available as Midlevel-Display or Uplevel-Combi-Display.



Midlevel-Display indicates:

- overall odometer
- trip odometer
- some control indicators
- vehicle information

- trip/fuel information
- vehicle messages, displayed as code numbers ⇨ 94.



In the Uplevel-Combi-Display, menu pages can be selected by pushing the **MENU** button, Menu symbols are indicated in the top line of the display:

- **Vehicle Information Menu**
- **Trip/Fuel Information Menu**
- **ECO ECO Information Menu**

Some of the displayed functions differ when the vehicle is being driven or at a standstill. Some functions are only available when the vehicle is being driven.

Vehicle personalisation ⇨ 99.
Memorised settings ⇨ 21.

Selecting menus and functions

The menus and functions can be selected via the buttons on the turn signal lever.



Press the **MENU** button to switch between the menus or to return from a submenu to the next higher menu level.



Turn the adjuster wheel to highlight a menu option or to set a numeric value.



Press the **SET/CLR** button to select a function or to confirm a message.

Vehicle Information Menu

Press the **MENU** button to select the **Vehicle Information Menu**, or on Uplevel-Combi-Display select .

Turn the adjuster wheel to select a submenu. Press the **SET/CLR** button to confirm.

Follow the instructions given in the submenus.

Possible submenus can be, depending on the version:

- **Unit:** displayed units can be changed
- **Tyre Pressure:** checks tyre pressure of all wheels during driving ↪ 175
- **Remaining Oil Life:** indicates when to change the engine oil and filter ↪ 81
- **Traffic Sign Assistant:** displays detected traffic signs for the current route section ↪ 141
- **Speed Warning:** if exceeding the preset speed, a warning chime will be activated

Selection and indication can be different between Midlevel- and Uplevel-Combi-Display.

Trip/Fuel Information Menu

Press the **MENU** button to select the **Trip/Fuel Information Menu**, or select  on Uplevel-Combi-Display.

Turn the adjuster wheel to select a submenu. Press the **SET/CLR** button to confirm.

- Trip odometer 1
- Trip odometer 2
- Digital speed

Trip odometer 2 and digital speed are only available on vehicles with Uplevel-Combi-Display.

On vehicles with trip computer more submenus are available.

Selection and indication can be different between Midlevel- and Uplevel-Combi-Display.

Trip/Fuel Information Menu, Trip Computer ↪ 96.

ECO Information Menu

Press the **MENU** button to select **ECO** in the top line of the Uplevel-Combi-Display.

Turn the adjuster wheel to select a submenu. Press the **SET/CLR** button to confirm.

Submenus are:

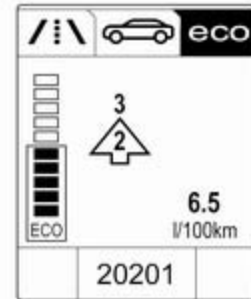

- **Shift indication:** Current gear is indicated inside an arrow. The graphic above recommends upshifting for fuel saving reasons.

Eco index display: The current fuel consumption is indicated on a segment display. For economical

driving, adapt your driving style to keep the filled segments within the Eco area. The more segments are filled, the higher the fuel consumption. Simultaneously the current consumption value is indicated.



- **Top Consumers:** List of top comfort consumers currently switched on is displayed in descending order. Fuel saving potential is indicated. A switched-off consumer disappears from the list and the consumption value will be updated.

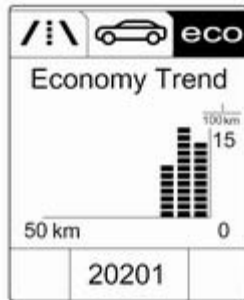

- **Economy Trend:** Displays the average consumption development over a distance of 50 miles. Filled segments display the consumption in 5 mile steps and shows the effect of topography or driving behaviour on fuel consumption.

Graphic-Info-Display, Colour-Info-Display

Depending on the vehicle configuration the vehicle has a Graphic-Info-Display or Colour-Info-Display. The Info-Display is located in the instrument panel above the Infotainment system.

Graphic-Info-Display



20153

Graphic-Info-Display indicates:

- time ⇄ 76
- outside temperature ⇄ 76
- date ⇄ 76

- Infotainment system, see description in the Infotainment system manual
- settings for vehicle personalisation ⇨ 99

Colour-Info-Display



The Colour-Info-Display indicates in colour:

- time ⇨ 76
- outside temperature ⇨ 76
- date ⇨ 76
- Infotainment system, see description in the Infotainment system manual

- navigation, see description in the Infotainment system manual
- system settings
- vehicle messages ⇨ 94
- settings for vehicle personalisation ⇨ 99

The type of information and how it is displayed depends on the equipment of the vehicle and the settings made.

Selecting menus and settings

Menus and settings are accessed via the display.

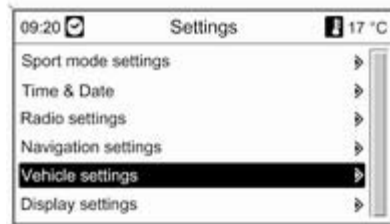

Selections are made via:

- menus
- function buttons and multifunction knob of the Infotainment system

Selecting with the Infotainment system



Select a function via the Infotainment system buttons. The menu of the selected function is displayed.

The multifunction knob is used to select an item and to confirm.

Multifunction knob

The multifunction knob is the central control element for the menus:

Turn

- To mark a menu option
- To set a numeric value or to display a menu option

Press (the outer ring)

- To select or activate the marked option
- To confirm a set value
- To switch a system function on/off

BACK button

Press button to:

- exit a menu without changing settings
- return from a submenu to a higher menu level
- delete the last character in a character sequence

Press and hold the button for a few seconds to delete the entire entry.

Vehicle personalisation ↪ 99.

Vehicle messages

Messages are indicated mainly in the Driver Information Centre (DIC), in some cases together with a warning chime.



Press the **SET/CLR** button, the **MENU** button or turn the adjuster wheel to confirm a message.

Vehicle messages on the Midlevel-Display

The vehicle messages are displayed as code numbers.

No. Vehicle message

No.	Vehicle message
10	Brakes overheated
16	Brake light failure
25	Left front turn signal failure
26	Left rear turn signal failure
27	Right front turn signal failure

No.	Vehicle message
28	Right rear turn signal failure
53	Tighten gas cap
54	Water in diesel fuel filter
S68	Service power steering
S73	Service all-wheel drive system
S75	Service air conditioning
S79	Top up engine oil
S81	Service transmission
S82	Change engine oil soon
S84	Engine power is reduced
S89	Service vehicle soon
128	Bonnet open
134	Park assist fault, clean bumper
S136	Service parking assist
174	Low battery

Note

"S" means "Service vehicle soon". Seek the assistance of a workshop immediately.

Vehicle messages on the Uplevel-Combi-Display

The vehicle messages are displayed as text. Follow the instructions given in the messages.

The system displays messages regarding the following topics:

- Service messages
- Fluid levels
- Anti-theft alarm system

- Brakes
- Drive systems
- Ride control systems
- Driver assistance systems
- Cruise control
- Speed limiter
- Parking assist systems
- Lighting, bulb replacement
- Adaptive forward lighting
- Wiper/washer system
- Doors, windows
- Traffic sign assistant
- Lane departure warning
- Load compartment, boot lid
- Radio remote control
- Seat belts
- Airbag systems
- Engine and transmission
- Tyre pressure
- Diesel particle filter
- Vehicle battery status

Warning chimes

When starting the engine or whilst driving

- If the door or bonnet is open.
- If seat belt is not fastened.
- If a certain speed is exceeded with parking brake applied.
- If a warning message or a warning code appears in the Driver Information Centre.
- If the parking assist detects an object.

When the vehicle is parked and/ or the driver's door is opened

- When the key is in the ignition switch.
- With exterior lights on.

Battery voltage

When the battery voltage is running low, a warning message or warning code 174 will appear in the Driver Information Centre.

1. Switch off immediately any electrical consumers which are not required for a safe ride, e.g. seat heating, heated rear window or other main consumers.
2. Charge the battery by driving continuously for a while or by using a charging device.

The warning message or warning code will disappear after the engine has been started twice consecutively without a voltage drop.

If the battery cannot be recharged, have the cause of the fault remedied by a workshop.

Trip computer

The menus and functions can be selected via the buttons on the turn signal lever ↷ 89.



On Midlevel-Display, press the **MENU** button to select the **Trip/Fuel Information Menu**, or select \swarrow on the Uplevel-Combi-Display.



Trip/Fuel Information Menu on Uplevel-Combi-Display

Turn the adjuster wheel to select the submenus:

/ \		Car icon	
75 km/h			
>>	Fuel pump icon	343	km
Fuel pump icon		9.8	$\frac{L}{100km}$
N	002915		

- Digital speed
- Range
- Instantaneous consumption

/ \		Car icon	
1	/ \	2781.2	km
Fuel pump icon	Ø	6.5	$\frac{L}{100km}$
Ø		99.6	km/h
20201			

- Trip odometer 1
- Average consumption 1
- Average speed 1

/ \		Car icon	
2	/ \	563.2	km
Fuel pump icon	Ø	7.8	$\frac{L}{100km}$
Ø		103.5	km/h
N	002915		

- Trip odometer 2
- Average consumption 2
- Average speed 2
- Route guidance

Trip computer 1 and 2

The information of two trip computers can be reset separately for odometer, average consumption and average speed, making it possible to display different trip information for different drivers.

To reset, press the **SET/CLR** button in each mode for a few seconds.



Trip odometer

Trip odometer displays the recorded distance since a certain reset.

Trip odometer counts up to a distance of 2000 miles then resets to 0.

To reset, press the **SET/CLR** button for a few seconds.

Fuel range

Range is calculated from current fuel tank content and current consumption. The display shows average values.

After refuelling, the range is updated automatically after a brief delay.

When the fuel level in the tank is low, a message appears on vehicles with Uplevel-Combi-Display.

When the tank has to be refuelled immediately, a warning code or warning message is displayed on vehicles with Midlevel- and Uplevel-Combi-Display.

Additionally the control indicator ● in the fuel gauge illuminates or flashes ↻ 88.

Fuel range LPG version

On vehicles with LPG engines and Uplevel-Combi-Display: Display of approximate fuel range available with the remaining fuel in each respective fuel tank of Petrol and LPG fuel, along with a total range of both fuel types together. Switch between the mode by pressing **SET/CLR** button.

Average consumption

Display of average consumption. The measurement can be reset at any time and starts with a default value.

To reset, press the **SET/CLR** button for a few seconds.

On vehicles with LPG engines and Uplevel-Combi-Display: Average consumption is indicated for the currently selected mode (LPG or Petrol).

Instantaneous consumption

Display of the instantaneous consumption.

On vehicles with LPG engines and Uplevel-Combi-Display: Instantaneous consumption is indicated for the currently selected mode (LPG or Petrol).

Average speed

Display of average speed. The measurement can be reset at any time.

To reset, press the **SET/CLR** button for a few seconds.

Digital speed

Digital display of the instantaneous speed.

Route guidance

Additional to the navigation information in the Colour-Info-Display, route guidance is displayed in the Driver Information Centre.

Vehicle personalisation

The vehicle can be personalised by changing the settings in the Infotainment system.

Depending on vehicle equipment some of the functions described below may not be available.

Settings in the Graphic-Info-Display CD 400

Press the **CONFIG** button for the Settings menu.

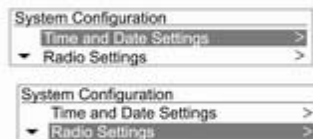

Press the **CONFIG** button, when ignition is on and Infotainment system is activated.

Setting menu is displayed.

To switch the setting menus, turn the **MENU** knob.

To select the setting menus, press the **MENU** button.

To close or back to previous, press the **BACK** button.

The following settings can be selected:

- **Languages**
- **Time Date**
- **Radio settings**
- **Bluetooth settings**
- **Vehicle settings**

In the corresponding submenus the following settings can be changed:

Languages

Selection of the desired language.

Time Date

See Clock ↻ 76.

Radio settings

See Infotainment system manual for further information.

Bluetooth settings

See Infotainment system manual for further information.

Vehicle settings

■ Climate and air quality

Auto fan speed: Modifies the fan regulation. Changed setting will be active after switching the ignition off and on again.

Climate control mode: Activates or deactivates cooling.

Auto demist: Supports windscreen dehumidification by automatically selecting the necessary settings and auto air conditioning mode.

Auto rear demist: Automatic activation of rear heated window.

■ Comfort settings

Chime volume: Changes the volume of warning chimes.

Personalization by driver: Activates or deactivates the personalisation function.

Rear auto wipe in reverse: Activates or deactivates automatic switching on of the rear window wiper when reverse gear is engaged.

■ Exterior ambient lighting

Exterior lighting by unlocking:

Activates or deactivates the entry lighting.

Duration upon exit of vehicle:

Activates or deactivates and changes the duration of exit lighting.

■ Power door locks

Auto door lock: Activates or deactivates the automatic door unlocking function after switching off ignition. Activates or deactivates the automatic door locking function after driving off.

Stop door lock if door open: Activates or deactivates the automatic door locking function while a door is open.

Delayed door lock: Activates or deactivates the delayed door locking function.

■ Remote locking, unlocking, starting

Remote unlock feedback:

Activates or deactivates the hazard warning flasher feedback whilst unlocking.

Remote door unlock: Changes the configuration to unlock only the driver's door or the whole vehicle whilst unlocking.

■ Restore factory settings:

Resets all settings to the default settings.

Settings in the Colour-Info-Display

CD 600/Navi 650/Navi 950

Press the **CONFIG** button on the Infotainment system faceplate to enter the Configuration menu.

Turn the multifunction knob to scroll upwards or downwards in the list. Press the multifunction knob (Navi 950 / Navi 650: press the outer ring) to select a menu item.



- Languages
- Time and Date
- Radio Settings
- Phone Settings
- Navigation Settings
- Display Settings
- Vehicle Settings

In the corresponding submenus the following settings can be changed:

Languages

Selection of the desired language.

Time and Date

See Infotainment system manual for further information.

Radio Settings

See Infotainment system manual for further information.

Phone Settings

See Infotainment system manual for further information.

Navigation Settings

See Infotainment system manual for further information.

Display Settings

■ Home Page Menu:

See Infotainment system manual for further information.

■ Rear Camera Options:

Press to adjust the rear camera options ↻ 139.

■ Display Off:

See Infotainment system manual for further information.

■ Map Settings:

See Infotainment system manual for further information.

Vehicle Settings

■ Climate and Air Quality

Auto Fan Speed: Modifies the fan regulation. Changed setting will be active after switching the ignition off and on again.

Air Conditioning Mode: Activates or deactivates cooling when switching on the ignition or uses the last chosen setting.

Auto Demist: Activates or deactivates auto demist.

Auto Rear Demist: Activates the heated rear window automatically.

■ Comfort and Convenience

Chime Volume: Changes the volume of warning chimes.

Personalisation by Driver:

Activates or deactivates the personalisation function.

Auto Reverse Gear Wiper:

Activates or deactivates automatically switching on of the rear window wiper when reverse gear is engaged.

■ **Collision Detection Systems**

Park Assist: Activates or deactivates the ultrasonic sensors.

■ **Lighting**

Vehicle Locator Lights: Activates or deactivates the entry lighting.

Exit Lighting: Activates or deactivates and changes the duration of exit lighting.

■ **Power Door Locks**

Open Door Anti Lock Out: Activates or deactivates the automatic door locking function while a door is open.

Auto Door Lock: Activates or deactivates the automatic door unlocking function after switching off ignition. Activates or deactivates

the automatic door locking function after driving-off.

Delay Door Lock: Activates or deactivates the delayed door locking function.

■ **Remote Lock/Unlock/Start**

Remote Lock Feedback: Activates or deactivates the hazard warning light feedback whilst locking.

Remote Unlock Feedback: Activates or deactivates the hazard warning flasher feedback whilst unlocking.

Remote Door Unlock: Changes the configuration to unlock only the driver's door or the entire vehicle whilst unlocking.

Relock Remotely Unlocked Doors: Activates or deactivates the automatic relock function after unlocking without opening the vehicle.

■ **Return to Factory Settings?:**

Resets all settings to the default settings.

Lighting

Exterior lighting 103
 Interior lighting 109
 Lighting features 111

Exterior lighting

Light switch



Turn light switch:

AUTO = automatic light control: exterior lighting is switched on and off automatically depending on external lighting conditions.

⏻ = activation or deactivation of the automatic light control. Switch turns back to **AUTO**.

☞☞ = sidelights

☞☞☞ = low beam

Vehicles without automatic light control:

O = off

Tail lights

Tail lights are illuminated together with low beam and sidelights.

Automatic light control



When the automatic light control function is switched on and the engine is running, the system switches between daytime running light and low beam automatically, depending on the lighting conditions.

Daytime running light ⇨ 105.

Automatic headlight activation

During poor lighting conditions the low beam is switched on.

Tunnel detection

When a tunnel is entered the low beam is switched on.

Adaptive forward lighting ⇨ 106.

High beam



To switch from low to high beam, push lever.

To switch to low beam, push lever again or pull.

Headlight flash

To activate the headlight flash, pull lever.

Headlight range adjustment

Manual headlight range adjustment



To adapt headlight range to the vehicle load to prevent dazzling: turn thumb wheel ⇨ to required position.

- 0 = front seats occupied
- 1 = all seats occupied
- 2 = all seats occupied and load compartment laden
- 3 = driver's seat occupied and load compartment laden.

Headlights when driving abroad

The asymmetrical headlight beam extends visibility at the edge of the road at the passenger side.

However, when driving in countries where traffic drives on the opposite side of the road, adjust the headlights to prevent dazzling of oncoming traffic.

Vehicles with halogen headlight system

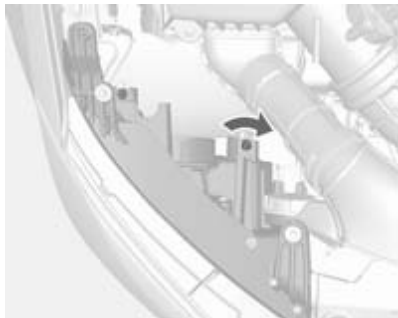

The adjusting screws are located above the headlight.

Turn the adjusting screws with the screwdriver clockwise by half a turn.

For deactivation, turn the adjusting screws counterclockwise by half a turn.

Caution

Have the adjustment of the headlights checked after deactivation.

We recommend consulting a workshop.

Vehicles with adaptive forward lighting system

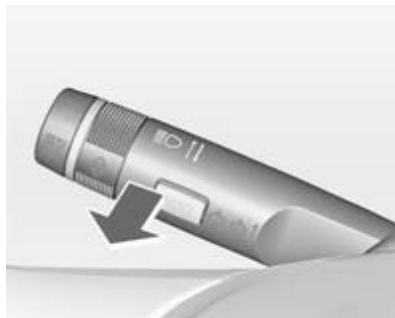

1. Key in ignition switch.
2. Pull turn signal lever and hold (headlight flash).

3. Switch on ignition.
4. After about 3 seconds, a signal sounds.

The headlights are aimed automatically.

Every time the ignition is switched on,  flashes as a reminder for approx. 4 seconds.

For deactivation operate the same procedure as described above.  will not flash when function is deactivated.

Control indicator   88.

Daytime running lights

Daytime running lights increase visibility of the vehicle during daylight.

They are switched on automatically when ignition is on.

Adaptive forward lighting

The Adaptive forward lighting functions are only available with Bi-Xenon headlights. Light range, light distribution and intensity of light are variably triggered depending on the light conditions, weather and road type.

Playstreet lighting

Activated automatically at low speed up to approx. 20 mph. The light beam is turned at an angle of $-5^{\circ}/3^{\circ}$ to the roadside.

Town lighting

Activated automatically at a speed up to approx. 30 mph and when street lights are detected by the light sensor. The light range is reduced by an extended light distribution.

Country lighting

Activated automatically at a speed range between approx. 30 and 72 mph. The beam of light and the brightness is different between the left and the right side.

Motorway lighting

Activated automatically at a speed above approx. 72 mph and minimal steering movements. It switches on after a delay or directly when the vehicle is powerfully accelerated. The light beam is longer and brighter.

Adverse weather lighting

Activated automatically up to a speed of approx. 43 mph, when the rain sensor recognises condensation or the wiper operates continuously. The range, distribution and light intensity is regulated variably depending on visibility.

Dynamic curve lighting



The light beam pivots based on steering wheel angle and speed, improving lighting in curves.

Control indicator   88.

Corner lighting

On tight bends or when turning off, depending on the steering angle or the turn signal light, an additional left or right reflector is switched on which illuminates the road at an right angle to the direction of travel. It is activated up to a speed of 25 mph.

Control indicator   88.

Reversing function

If the headlights are on and reverse gear is engaged, both corner lights are switched on. They remain illuminated for 20 seconds after disengaging reverse gear or until driving faster than 10 mph in a forward gear.

High beam assist

This feature allows high beam as main driving light by night and when vehicle speed is faster than 25 mph.



It switches to low beam when:

- the camera in the windscreen detects the lights of oncoming or preceding vehicles
- the vehicle speed is slower than 12 mph
- it is foggy or snowy
- driving in urban areas

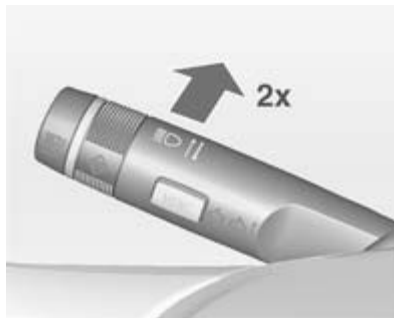
Activation



The high beam assist is activated by pushing the indicator lever twice at a speed above 25 mph.

The green control indicator  illuminates continuously when the assist is activated, the blue one  illuminates when high beam is on.

Control indicator   88.

Deactivation

Push indicator lever once. It is also deactivated when front or rear fog lights are switched on.

If a headlight flash is activated when the high beam is on, the high beam assist will be deactivated.

If a headlight flash is activated when the high beam is off, the high beam assist will remain activated.

High beam assist is always active after the ignition is switched on.

Dynamic automatic headlight levelling

To prevent oncoming traffic from dazzle, headlight levelling is automatically adjusted based on inclination information measured by front and rear axle, acceleration or deceleration and vehicle speed.

Fault in Adaptive forward lighting system

When the system detects a failure in the Adaptive forward lighting system, the system moves to a preset position to avoid dazzling of oncoming traffic. Have the cause of the failure remedied by a workshop as soon as possible.

Hazard warning flashers



Operated with the  button.

Turn and lane-change signals



lever up = right turn signal
lever down = left turn signal

If the lever is moved past the resistance point, the turn signal is switched on constantly. When the steering wheel moves back, the turn signal is automatically deactivated.

For three flashes, e.g. when changing lanes, press the lever until resistance is felt and then release.

Move the lever to the resistance point and hold for longer indication.

Switch the turn signal off manually by moving the lever to its original position.

Front fog lights



Operated with the  button.

Rear fog light



Operated with the  button.

Light switch in position **AUTO**:
switching on rear fog light will switch
headlights on automatically.

Light switch in position : rear fog
light can only be switched on with
front fog lights.

Reversing lights

The reversing light comes on when
the ignition is on and reverse gear is
selected.

Misted light covers

The inside of the light housing may
mist up briefly in poor, wet and cold
weather conditions, in heavy rain or
after washing. The mist disappears
quickly by itself; to help switch on the
headlights.

Interior lighting

Instrument panel illumination control



Brightness of the following lights can
be adjusted when the exterior lights
are on:

- Instrument panel illumination
- Steering wheel controls

Turn thumb wheel  and hold until
the desired brightness is obtained.

Interior lights

Courtesy light

Front



Operate rocker switch:

press  = off

 = automatic switching on and off

press  = on

Rear



Operate rocker switch:

| = on



 = automatic switching on and off

○ = off

Reading lights



The front reading lights are located in the overhead console.

Press  and  to turn each light on or off.

Glove box lighting

Illuminates when the glovebox is opened.

Sunvisor lights

Illuminates when the cover is opened.

Lighting features

Entry lighting

Welcome lighting

Following lights are switched on for a short time by unlocking the vehicle with the radio remote control:

- low beam,
- sidelights,
- tail lights,
- number plate lights,
- instrument panel light,
- interior lights.

This function works only in the dark and facilitates locating the vehicle.

Activation or deactivation of this function can be changed in the menu **Settings** in the Info-Display. Vehicle personalisation ↻ 99.

The following lights will additionally switch on when driver's door is opened:

- some switches,
- some interior lights.

Exit lighting

Low beam, sidelights and tail lights illuminate the surrounding area for an adjustable time after leaving the vehicle.

Switching on

Activation, deactivation and duration of lighting of this function can be changed in the Vehicle Settings. Vehicle personalisation ↻ 99.



1. Switch off ignition.
2. Remove ignition key.
3. Open driver's door.

4. Pull turn signal lever.

5. Close driver's door.

If the driver's door is not closed the lights switch off after a few seconds.

The lighting is switched off immediately if the turn signal lever is pulled while the driver's door is open.

Battery discharge protection

To prevent discharge of the battery when the ignition is switched off, some interior lights are switched off automatically after some time.

Climate control

Climate control systems	112
Air vents	116
Maintenance	117

Climate control systems

Heating and ventilation system



Controls for:

- Air distribution
- Temperature
- Fan speed

: demisting and defrosting



Heated rear window  ⇨ 30.

Temperature

red = warm
blue = cold

Heating will not be fully effective until the engine has reached normal operating temperature.

Air distribution



-  = to windscreen and front door windows
-  = to head area
-  = to foot well

Combination settings are possible.

Fan speed

Adjust the air flow by switching the fan to the desired speed.



Demisting and defrosting

- Press button : fan automatically switches to higher speed, the air distribution is directed towards the windscreen.
- Set temperature control to warmest level.
- Switch on heated rear window .
- Open side air vents as required and direct them towards the door windows.

Air conditioning system



In addition to the heating and ventilation system, the air conditioning system has controls for:

-  = cooling
-  = air recirculation

Cooling

Operated with the  button and is functional only when the engine and fan are running.

The air conditioning system cools and dehumidifies (dries) as soon as the outside temperature is above a

specific level. Therefore condensation may form and drip from under the vehicle.

If no cooling or drying is required, switch off the cooling system for fuel saving reasons. Activated cooling might inhibit Autostops.

Air recirculation system

Operated with the  button.



Warning

The exchange of fresh air is reduced in air recirculation mode. In operation without cooling the air humidity increases, so the windows may mist up from inside. The quality of the passenger compartment air deteriorates, which may cause the vehicle occupants to feel drowsy.



Air distribution to : Air recirculation is deactivated.

Maximum cooling



Briefly open the windows so that hot air can disperse quickly.

- Cooling  on.
- Air recirculation system  on.
- Press air distribution switch .
- Set temperature control to coldest level.
- Set fan speed to highest level.
- Open all vents.

Demisting and defrosting the windows

- Press button : fan automatically switches to higher speed, the air distribution is directed towards the windscreen.
- Switch cooling  on.
- Set temperature control to warmest level.
- Switch on heated rear window .
- Open side air vents as required and direct them towards the door windows.

Note

If the  button is pressed while the engine is running, an Autostop will be inhibited until the  button is pressed again.

If the  button is pressed while the engine is in an Autostop, the engine will restart automatically.

Electronic climate control system



Controls for:

- Air distribution
- Temperature
- Fan speed

AUTO = automatic mode

 = manual air recirculation

 = demisting and defrosting

Heated rear window   30.

The preselected temperature is automatically regulated. In the automatic mode the fan speed and air distribution automatically regulate the air flow.

The system can be manually adapted via the use of air distribution and air flow controls.

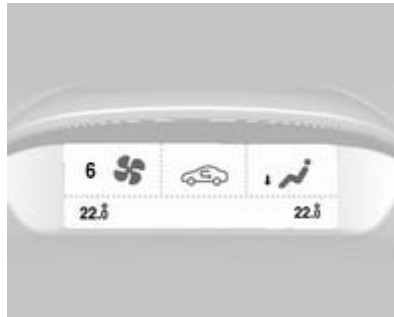

Each change of settings is shown in the Info-Display for a few seconds.

The electronic climate control system is only fully operational when the engine is running.

Automatic mode AUTO



Basic setting for maximum comfort:

- Press **AUTO** button, the air distribution and fan speed are regulated automatically.
- Open all air vents.
- Press  to switch on cooling.
- Set the desired temperature.

Temperature preselection

Temperatures can be set to the desired value.

If the minimum temperature is set, the climate control system runs at maximum cooling.

If the maximum temperature is set, the climate control system runs at maximum heating.



Note



If the temperature will be reduced for climate comfort reasons, an Autostop can be inhibited or the engine will restart automatically, when cooling is switched on.

Stop-start system ⇨ 120.



The temperature can be adjusted separately for driver and front passenger side.

Demisting and defrosting the windows

- Press button .
- Press cooling button .

- Temperature and air distribution are set automatically and the fan runs at high speed.
- Switch on heated rear window .
- To return to automatic mode: press button  or **AUTO**.

Note

If the  button is pressed while the engine is running, an Autostop will be inhibited until the  button is pressed again.

If the  button is pressed while the engine is in an Autostop, the engine will restart automatically.

Manual settings

Climate control system settings can be changed by activating the buttons and rotary knobs as follows. Changing a setting will deactivate the automatic mode.



Fan speed

The selected fan speed is indicated with  and a number in the display. If the fan is switched off the air conditioning is also deactivated.

To return to automatic mode: Press **AUTO** button.

Air distribution , ,

Press appropriate button for desired adjustment. Activation is indicated by the LED in the button.

-  = to windscreen and front door windows.
-  = to head area.
-  = to foot well.

Combination of settings are possible. Return to automatic air distribution: Deactivate corresponding setting or press button **AUTO**.

Cooling

Activate or deactivate with the  button.

The air conditioning system cools and dehumidifies (dries) when outside temperature is above a specific level. Therefore condensation may form and drip from under the vehicle.

If no cooling or drying is required, switch off the cooling system for fuel saving reasons. Activated cooling might inhibit Autostops.

The display will indicate **Eco** when cooling is deactivated.

Air recirculation mode

Press button  once to activate the manual air recirculation mode.

Warning

The exchange of fresh air is reduced in air recirculation mode. In operation without cooling the air humidity increases, so the windows may mist up from inside. The quality of the passenger compartment air deteriorates, which may cause the vehicle occupants to feel drowsy.

Air conditioning with the engine not running

When ignition is off, the residual heat or cooling in the system can be used for climate control in passenger compartment.

Auxiliary heater

Air heater

Quickheat is an electric auxiliary air heater which automatically warms up the passenger compartment more quickly.

Air vents

Adjustable air vents

At least one air vent must be open while the cooling is on.

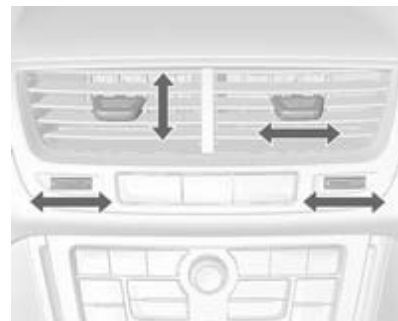

To open the vent, turn the adjuster wheel to the right. Adjust the air amount at the vent outlet by turning the adjuster wheel.

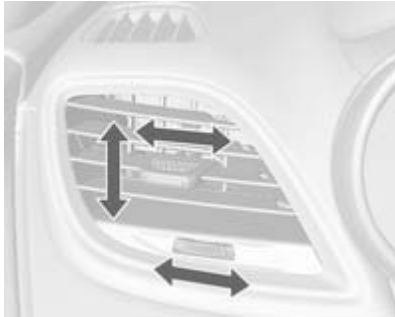

Direct the flow of air by tilting and swivelling the slats.

To close the vent, turn the adjuster wheel to the left.

⚠ Warning

Do not attach any objects to the slats of the air vents. Risk of damage and injury in case of an accident.

Fixed air vents

Additional air vents are located beneath the windscreen and door windows and in the foot wells.

Maintenance

Air intake

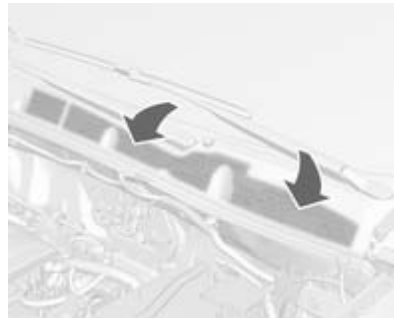

The air intake in front of the windscreen in the engine compartment must be kept clear to allow air intake.

Remove any leaves, dirt or snow.

Pollen filter

The pollen filter cleans dust, soot, pollen and spores from the air entering the vehicle through the air intake.

Air conditioning regular operation

In order to ensure continuously efficient performance, cooling must be operated for a few minutes once a month, irrespective of the weather and time of year. Operation with cooling is not possible when the outside temperature is too low.

Service

For optimal cooling performance, it is recommended to annually check the climate control system, starting three years after initial vehicle registration, including:

- Functionality and pressure test
- Heating functionality
- Leakage check
- Check of drive belts
- Cleaning of condenser and evaporator drainage
- Performance check

Driving and operating

Driving hints	118
Starting and operating	119
Engine exhaust	123
Automatic transmission	125
Manual transmission	128
Drive systems	128
Brakes	129
Ride control systems	131
Driver assistance systems	133
Fuel	145
Trailer hitch	152

Driving hints

Control of the vehicle

Never coast with engine not running (except during Autostop)

Many systems will not function in this situation (e.g. brake servo unit, power steering). Driving in this manner is a danger to yourself and others. All systems function during an Autostop, but there will be a controlled reduction in power steering assist and vehicle speed is reduced.

Stop-start system ⇨ 120.

Pedals

To ensure the pedal travel is uninhibited, there must be no mats in the area of the pedals.

Steering

If power steering assist is lost because the engine stops or due to a system malfunction, the vehicle can be steered but may require increased effort.

Control indicator ⚠ ⇨ 86.

Caution

Vehicles equipped with hydraulic power steering:

If the steering wheel is turned until it reaches the end of its travel, and is held in that position for more than 15 seconds, damage may occur to the power steering system and there may be loss of power steering assist.

Starting and operating

New vehicle running-in

Do not brake unnecessarily hard for the first few journeys.

During the first drive, smoke may occur because of wax and oil evaporating off the exhaust system. Park the vehicle in the open for a while after the first drive and avoid inhaling the fumes.

During the running-in period fuel and engine oil consumption may be higher and the cleaning process of the diesel particle filter may take place more often. Autostop may be inhibited to allow for charging the battery.

Diesel particle filter ⇨ 123.

Ignition switch positions

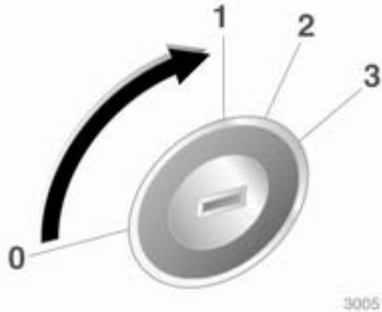

- 0 = Ignition off
- 1 = Steering wheel lock released, ignition off
- 2 = Ignition on, for diesel engine: preheating
- 3 = Starting

Starting the engine

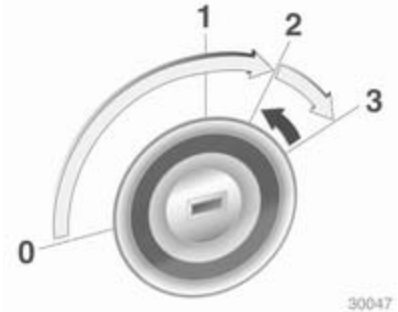

Manual transmission: operate clutch.
Automatic transmission: operate brake and move the selector lever to **P** or **N**.

Do not operate the accelerator pedal.

Diesel engine: turn the key to position **2** for preheating until control indicator  extinguishes.

Turn the key briefly to position **3** and release: an automatic procedure operates the starter with a short delay as long as the engine is running, see Automatic Starter Control.

Before restarting or to switch off the engine, turn the key back to position **0**.

During an Autostop, the engine can be started by depressing the clutch pedal.

Key lock release

Some vehicles with an automatic transmission are equipped with an electronic key lock release system. The key lock release is designed to prevent ignition key removal unless the selector lever is in **P**.

Starting the vehicle at low temperatures

Starting the engine without additional heaters is possible down to -25 °C for diesel engines and -30 °C for petrol engines. Required is an engine oil with the correct viscosity, the correct fuel, performed services and a sufficiently charged battery. With temperatures below -30 °C the automatic transmission requires a warming phase of approx. 5 minutes. The selector lever must be in position **P**.

Automatic Starter Control

This function controls the engine starting procedure. The driver does not have to hold the key in position **3**. Once applied, the system will go on starting automatically until the engine is running. Because of the checking procedure, the engine starts running after a short delay.

Possible reasons for a non-starting engine:

- Clutch pedal not operated (manual transmission)
- Brake pedal not operated or selector lever not in **P** or **N** (automatic transmission)
- Timeout occurred

Turbo engine warm-up

Upon start-up, engine available torque may be limited for a short time, especially when the engine temperature is cold. The limitation is to allow the lubrication system to fully protect the engine.

Overrun cut-off

The fuel supply is automatically cut off during overrun, i.e. when the vehicle is driven with a gear engaged but accelerator is released.

Stop-start system

The stop-start system helps to save fuel and to reduce the exhaust emissions. When conditions allow, it switches off the engine as soon as the vehicle is at a low speed or at a standstill, e.g. at a traffic light or in a traffic jam. It starts the engine automatically as soon as the clutch is depressed. A battery sensor ensures that an Autostop is only performed if the battery is sufficiently charged for a restart.

Activation

The stop-start system is available as soon as the engine is started, the vehicle starts-off and the conditions as stated below in this section are fulfilled.

Deactivation



Deactivate the stop-start system manually by pressing the **eco** button. Deactivation is indicated when the LED in the button extinguishes.

Autostop

If the vehicle is at a low speed or at a standstill, activate an Autostop as follows:

- Depress the clutch pedal
- set the lever in neutral
- release the clutch pedal

The engine will be switched off while the ignition stays on.



An Autostop is indicated by the needle at the **AUTOSTOP** position in the tachometer.

During an Autostop, the heating performance, power steering and brake performance will be maintained.

Conditions for an Autostop

The stop-start system checks if each of the following conditions is fulfilled:

- The stop-start system is not manually deactivated
- the bonnet is fully closed
- the driver's door is closed or the driver's seat belt is fastened

- the battery is sufficiently charged and in good condition
- the engine is warmed up
- the engine coolant temperature is not too high
- the engine exhaust temperature is not too high, e.g. after driving with high engine load
- the ambient temperature is not too low
- the climate control system allows an Autostop
- the brake vacuum is sufficient
- the self-cleaning function of the diesel particle filter is not active
- the vehicle has moved since the last Autostop

Otherwise an Autostop will be inhibited.

Ambient temperature near to the freezing point can inhibit an Autostop.

Certain settings of the climate control system may inhibit an Autostop. See Climate control chapter for more details.

Immediately after motorway driving an Autostop may be inhibited.

New vehicle running-in ⇨ 119.

Battery discharge protection

To ensure reliable engine restarts, several battery discharge protection features are implemented as part of the stop-start system.

Power saving measures

During an Autostop, several electrical features such as auxiliary electric heater or rear window heating are disabled or switched into a power saving mode. The fan speed of the climate control system is reduced to save power.

Restart of the engine by the driver

Depress the clutch pedal to restart the engine.

The engine start is indicated by the needle at the idle speed position in the tachometer.

If the selector lever is shifted out of neutral before depressing the clutch first, control indicator  illuminates or is shown as a message in the Driver Information Centre.

Control indicator  ⇨ 85.

Restart of the engine by the stop-start system

The selector lever has to be in neutral to enable an automatic restart.

If one of the following conditions occurs during an Autostop, the engine will be restarted automatically by the stop-start system:

- The stop-start system is manually deactivated
- the bonnet is opened
- the driver's seat belt is unfastened and the driver's door is opened
- the engine temperature is too low
- the battery is discharged
- the brake vacuum is not sufficient
- the vehicle starts to move

- the climate control system requests an engine start
- the air conditioning is manually switched on

If the bonnet is not fully closed, a warning message is displayed in the Driver Information Centre.

If an electrical accessory, e.g. a portable CD player, is connected to the power outlet, a brief power drop during engine restart might be noticeable.

Parking

- Do not park the vehicle on an easily ignitable surface. The high temperature of the exhaust system could ignite the surface.
- Always apply parking brake without pressing release button. Apply as firmly as possible on downhill or uphill slopes. Depress the foot brake at the same time to reduce operating force.
- Switch off the engine and ignition. Turn the steering wheel until the steering wheel lock engages.

- If the vehicle is on a level surface or uphill slope, engage first gear or set the selector lever to **P** before switching off the ignition. On an uphill slope, turn the front wheels away from the kerb.

If the vehicle is on a downhill slope, engage reverse gear or set the selector lever to **P** before switching off the ignition. Turn the front wheels towards the kerb.

- Lock the vehicle and activate the anti-theft alarm system.

Note

In the event of an accident with airbag deployment, the engine is turned off automatically if the vehicle comes to a standstill within a certain time.

Engine exhaust

⚠ Danger

Engine exhaust gases contain poisonous carbon monoxide, which is colourless and odourless and could be fatal if inhaled.

If exhaust gases enter the interior of the vehicle, open the windows. Have the cause of the fault rectified by a workshop.

Avoid driving with an open load compartment, otherwise exhaust gases could enter the vehicle.

Diesel particle filter

The diesel particle filter system filters harmful soot particles out of the exhaust gases. The system includes a self-cleaning function that runs automatically during driving without any notification. The filter is cleaned by periodically burning off the soot particles at high temperature. This process takes place automatically under set driving conditions and may

take up to 25 minutes. Typically it needs between 7 and 12 minutes. Autostop is not available and fuel consumption may be higher during this period. The emission of smells and smoke during this process is normal.



Under certain driving conditions, e.g. short distances, the system cannot clean itself automatically.

If cleaning of the filter is required and if previous driving conditions did not enable automatic cleaning, it will be indicated by control indicator .

 illuminates when diesel particle filter is full. Start cleaning process as soon as possible.

 flashes when diesel particle filter has reached the maximum filling level. Start cleaning process immediately to avoid damage to the engine.

Cleaning process

To activate cleaning process, continue driving, keep engine speed above 2000 revolutions per minute. Shift down if necessary. Diesel particle filter cleaning is then started. If control indicator  also illuminates, cleaning is not possible: seek the assistance of a workshop.

Caution

If the cleaning process is interrupted, there is a risk of provoking severe engine damage.



Cleaning takes place quickest at high engine speeds and loads.

The control indicator  extinguishes as soon as the self-cleaning operation is complete.

Catalytic converter

The catalytic converter reduces the amount of harmful substances in the exhaust gases.

Caution

Fuel grades other than those listed on pages  145,  202 could damage the catalytic converter or electronic components.

Unburnt petrol will overheat and damage the catalytic converter. Therefore avoid excessive use of the starter, running the fuel tank dry and starting the engine by pushing or towing.

In the event of misfiring, uneven engine running, a reduction in engine performance or other unusual problems, have the cause of the fault rectified by a workshop as soon as possible. In an emergency, driving

can be continued for a short period, keeping vehicle speed and engine speed low.

Automatic transmission

The automatic transmission permits automatic gearshifting (automatic mode) or manual gearshifting (manual mode).

Transmission display

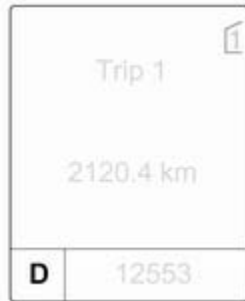

The mode or selected gear is shown in the transmission display.

Selector lever



- P** = park position, wheels are locked, engage only when the vehicle is stationary and the parking brake is applied
- R** = reverse gear, engage only when the vehicle is stationary
- N** = neutral
- D** = automatic mode with all gears
- M** = manual mode

The selector lever is locked in **P** and can only be moved when the ignition is on and the brake pedal is applied.



To engage **P** or **R**, press the release button.

The engine can only be started with the lever in position **P** or **N**. When position **N** is selected, press the brake pedal or apply the parking brake before starting.

Do not accelerate while engaging a gear. Never depress the accelerator pedal and brake pedal at the same time.

When a gear is engaged, the vehicle slowly begins to creep when the brake is released.

Engine braking

To utilise the engine braking effect, select a lower gear in good time when driving downhill, see manual mode.

Rocking the vehicle

Rocking the vehicle is only permissible if the vehicle is stuck in sand, mud or snow. Move the selector lever between **D** and **R** in a repeat pattern. Do not race the engine and avoid sudden acceleration.

Parking

Apply the parking brake and engage **P**.

The ignition key can only be removed when the selector lever is in position **P**.

Manual mode



Move selector lever to position **M**.

Press button on the selector lever:

+ = Shift to a higher gear.

- = Shift to a lower gear.

If a higher gear is selected when vehicle speed is too low, or a lower gear when vehicle speed is too high, the shift is not executed. This can cause a message in the Driver-Info-Display.

In manual mode no automatic shifting to a higher gear takes place at high engine revolutions.

Electronic driving programmes

- Following a cold start, the operating temperature programme increases engine speed to quickly bring the catalytic converter to the required temperature.
- The automatic neutral shift function automatically shifts to idling when the vehicle is stopped with a forward gear engaged and the brake pedal is pressed.
- Special programmes automatically adapt the shifting points when driving up inclines or down hills.

Kickdown

If the accelerator pedal is pressed down completely in automatic mode, the transmission shifts to a lower gear depending on engine speed.

Fault

In the event of a fault,  illuminates. Additionally a code number or a vehicle message is displayed in the Driver Information Centre. Vehicle messages ⇨ 94.

The transmission no longer shifts automatically. Continued travel is possible with manual shifting.

Only the highest gear is available. Depending on the fault, 2nd gear may also be available in manual mode. Shift only when vehicle is at a standstill.

Have the cause of the fault remedied by a workshop.

Interruption of power supply

In the event of an interruption of power supply, the selector lever cannot be moved out of the **P** position. The ignition key cannot be removed from the ignition switch.

If the battery is discharged, start the vehicle using jump leads ⇨ 187.

If the battery is not the cause of the fault, release the selector lever.

1. Turn the ignition off and remove the key.
2. Depress and hold the brake pedal and pull the parking brake lever up.



3. Remove the cap on the console with a thin object such as a screwdriver.



4. Insert a screwdriver into the opening as far as it will go.
5. Shift selector lever to **N**.
6. Remove the screwdriver from the slot.
7. Reinstall the cap.
8. Have the cause of the power supply interruption remedied by a workshop.

Manual transmission

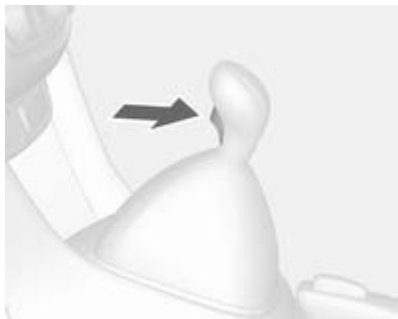

To engage reverse, with the vehicle stationary wait 3 seconds after depressing the clutch pedal and then press the release button on the selector lever and engage the gear.

If the gear does not engage, set the lever to neutral, release the clutch pedal and depress again; then repeat gear selection.

Do not slip the clutch unnecessarily.

When operating, depress the clutch pedal completely. Do not use the pedal as a foot rest.

Caution

It is not advisable to drive with the hand resting on the selector lever.

Drive systems

All-wheel drive

The All-Wheel Drive (AWD) system enhances driving characteristics and stability, and helps to achieve the best possible driveability regardless of ground surface. The system is always active and cannot be deactivated.

The torque is distributed steplessly between the wheels of the front and rear axle, depending on the driving conditions. Additionally the torque between the rear wheels is distributed depending on the surface.

For optimum system performance, the vehicle's tyres should not have varying degrees of wear.

When using a temporary spare wheel, the AWD system is automatically disabled.

The AWD system will also be temporarily disabled to protect the system from overheating if there is excessive wheel spin. When the system cools down, AWD will be restored.

The deactivation of the AWD system will be indicated by a message on the Driver Information Centre.

If a service message or warning code S73 is displayed on the Driver Information Centre, there is a malfunction in the AWD system. Seek the assistance of a workshop.

Vehicle messages ⇨ 94, Towing the vehicle ⇨ 189.

Brakes

The brake system comprises two independent brake circuits.

If a brake circuit fails, the vehicle can still be braked using the other brake circuit. However, braking effect is achieved only when the brake pedal is depressed firmly. Considerably more force is needed for this. The braking distance is extended. Seek the assistance of a workshop before continuing your journey.

When the engine is not running, the support of the brake servo unit disappears once the brake pedal has been depressed once or twice.

Braking effect is not reduced, but braking requires significantly greater force. It is especially important to bear this in mind when being towed.

Control indicator (Ⓢ) ⇨ 85.

Antilock brake system

Antilock brake system (ABS) prevents the wheels from locking.

ABS starts to regulate brake pressure as soon as a wheel shows a tendency to lock. The vehicle remains steerable, even during hard braking.

ABS control is made apparent through a pulse in the brake pedal and the noise of the regulation process.

For optimum braking, keep the brake pedal fully depressed throughout the braking process, despite the fact that the pedal is pulsating. Do not reduce the pressure on the pedal.

After starting off the system performs a self-test which may be audible.

Control indicator (Ⓢ) ⇨ 86.

Adaptive brake light

During full braking, all three brake lights flash for the duration of ABS control.

Fault**⚠ Warning**

If there is a fault in the ABS, the wheels may be liable to lock due to braking that is heavier than normal. The advantages of ABS are no longer available. During hard braking, the vehicle can no longer be steered and may swerve.

Have the cause of the fault remedied by a workshop.

Parking brake

Always apply parking brake firmly without operating the release button, and apply as firmly as possible on a downhill or uphill slope.

To release the parking brake, pull the lever up slightly, press the release button and fully lower the lever.

To reduce the operating forces of the parking brake, depress the foot brake at the same time.

Control indicator (C) ⇨ 85.

Brake assist

If the brake pedal is depressed quickly and forcefully, maximum brake force is automatically applied (full braking).

Maintain steady pressure on the brake pedal for as long as full braking is required. Maximum brake force is automatically reduced when the brake pedal is released.

Hill start assist

The system helps prevent unintended movement when driving away on inclines.

When releasing the foot brake after stopping on an incline, the brakes remain on for a further two seconds. The brakes release automatically as soon as the vehicle begins to accelerate.

The hill start assist is not active during an Autostop.

Ride control systems

Traction Control system

The Traction Control system (TC) is a component of the Electronic Stability Control (ESC) ⇨ 131.

TC improves driving stability when necessary, regardless of the type of road surface or tyre grip, by preventing the drive wheels from spinning.

As soon as the drive wheels starts to spin, engine output is reduced and the wheel spinning the most is braked individually. This considerably improves the driving stability of the vehicle on slippery road surfaces.

TC is operational after each engine start as soon as the control indicator  extinguishes.

When TC operates  flashes.

Warning

Do not let this special safety feature tempt you into taking risks when driving.



Adapt speed to the road conditions.

Control indicator  ⇨ 87.

Deactivation



TC can be switched off when spinning of drive wheels is required:

press button  briefly to deactivate TC,  illuminates. Deactivation is displayed as status message in the Driver Information Centre.

TC is reactivated by pressing the  button again.

TC is also reactivated the next time the ignition is switched on.

Electronic Stability Control

Electronic Stability Control (ESC) improves driving stability when necessary, regardless of the type of road surface or tyre grip. It also prevents the drive wheels from spinning.

As soon as the vehicle starts to swerve (understeer/oversteer), engine output is reduced and the wheels are braked individually. This considerably improves the driving stability of the vehicle on slippery road surfaces.

ESC is operational after each engine start as soon as the control indicator  extinguishes.

When ESC operates  flashes.

Warning

Do not let this special safety feature tempt you into taking risks when driving.

Adapt speed to the road conditions.

Control indicator   87.

Deactivation



For very high-performance driving ESC can be deactivated: hold button  depressed for approx. 5 seconds.

Control indicator  and  illuminate.

ESC is reactivated by pressing the  button again. If the TC system was previously disabled, both TC and ESC are reactivated.

ESC is also reactivated the next time the ignition is switched on.

Descent control system

The Descent control system (DCS) allows the vehicle to travel at a low speed without depressing the foot brake. The vehicle will automatically decelerate to a low speed and remain at that speed when the system is activated. Some noise or vibration from the brake system may be apparent when the system is active.



Caution

Use only when descending steep grades while driving off-road. Do not use when driving on normal road surfaces. Unnecessary usage of the DCS function, such

as while driving on normal roads, may damage the brake system and the ESC function.

Switching on



At speeds below approx. 25 mph, press button . DCS is operational as soon as control indicator  illuminates.

Activation

DCS is active at speeds between 1.2 and 22 mph. Depending on the current speed, the vehicle will be

accelerated or decelerated to a speed between 3 and 12 mph. When DCS is active,  flashes.

DCS will only be activated on roads with a certain incline.

Deactivation

DCS is deactivated if the vehicle is decelerated below 1.2 mph or accelerated above 22 mph.

Switching off

Press button  again. Control indicator  extinguishes.

At speeds above 37 mph the system is deactivated automatically.

Driver assistance systems

Warning

Driver assistance systems are developed to support the driver and not to replace the driver's attention.

The driver accepts full responsibility when driving the vehicle.

When using driver assistance systems, always take care regarding the current traffic situation.

Cruise control

The Cruise control can store and maintain speeds of approx. 20 to 120 mph. Deviations from the stored speeds may occur when driving uphill or downhill.

For safety reasons the cruise control cannot be activated until the foot brake has been operated once. Activating in first gear is not possible.





Do not use the cruise control if it is not advisable to maintain a constant speed.

With automatic transmission, only activate cruise control in automatic mode.

Control indicator   89.

Switching on

Press button : control indicator  in instrument cluster illuminates white.

Activation

Accelerate to the desired speed and turn thumb wheel to **SET/-**: the current speed is stored and maintained. Control indicator  in instrument cluster illuminates green. Accelerator pedal can be released.

Vehicle speed can be increased by depressing the accelerator pedal. When the accelerator pedal is released, the previously stored speed is resumed.

Cruise control remains activated while gearshifting.

Increase speed



With cruise control active, hold thumb wheel turned to **RES/+** or briefly turn to **RES/+** repeatedly: speed increases continuously or in small increments.

Alternatively accelerate to the desired speed and store by turning to **SET/-**.

Reduce speed

With cruise control active, hold thumb wheel turned to **SET/-** or briefly turn to **SET/-** repeatedly: speed decreases continuously or in small increments.

Deactivation

Press button : control indicator  in instrument cluster illuminates white. Cruise control is deactivated. Last used set speed is stored in memory for later speed resume.



Automatic deactivation:

- vehicle speed below approx. 20 mph,
- vehicle speed above approx. 125 mph,
- the brake pedal is depressed,
- the clutch pedal is depressed for a few seconds,
- selector lever in **N**,
- engine speed in a very low range,
- the Traction Control system or Electronic Stability Control is operating.

Resume stored speed

Turn thumb wheel to **RES/+** at a speed above 20 mph. The stored speed will be resumed.

Switching off

Press button : control indicator  in instrument cluster extinguishes. The stored speed is deleted.

Pressing button  for activating speed limiter or switching off the ignition also switches off cruise control and deletes the stored speed.

Speed limiter

The speed limiter prevents the vehicle exceeding a preset maximum speed.



The maximum speed can be set at a speed above 15 mph.

The driver can only accelerate up to the preset speed. Deviations from the limited speed may occur when driving downhill.

The preset speed limit is displayed in the top line of the Driver Information Centre when the system is active.

Activation



Press button . If cruise control or adaptive cruise control has been activated before, it is switched off when speed limiter is activated and the control indicator  extinguishes.

Set speed limit

With speed limiter active, hold thumb wheel turned to **RES/+** or briefly turn to **RES/+** repeatedly until the desired maximum speed is displayed in the Driver Information Centre.

Alternatively accelerate to the desired speed and briefly turn thumb wheel to **SET/-**: the current speed is stored as

maximum speed. Speed limit is displayed in the Driver Information Centre.



Change speed limit

With speed limiter active, turn thumb wheel to **RES/+** to increase or **SET/-** to decrease the desired maximum speed.

Exceeding the speed limit

In the event of an emergency it is possible to exceed the speed limit by depressing the accelerator pedal firmly beyond the point of resistance.

The limited speed will flash in the Driver Information Centre and a chime sounds during this period.

Release the accelerator pedal and the speed limiter function is reactivated once a speed lower than the limit speed is obtained.

Deactivation

Press button : speed limiter is deactivated and the vehicle can be driven without speed limit.

The limited speed is stored and a corresponding message appears in the Driver Information Centre.

Resume limit speed

Turn thumb wheel to **RES/+**. The stored speed limit will be obtained.

Switching off



Press button , the speed limit indication in the Driver Information Centre extinguishes. The stored speed is deleted.

By pressing button  to activate cruise control or adaptive cruise control or by switching off the ignition, speed limiter is also deactivated and the stored speed is deleted.

Forward collision alert

The forward collision alert can help to avoid or reduce the damage caused by front-end crashes. If a vehicle directly ahead is approached too quickly, a warning chime and alert in the Driver Information Centre is provided.



The green illuminated vehicle ahead symbol  appears in the speedometer when the system has detected a vehicle in the driving path. A precondition is that forward collision alert is activated in the vehicle personalisation menu  99 or that it is not deactivated with button  (depending on the system, see following).

Forward collision alert based on front camera system

Forward collision alert uses the front camera system in the windscreen to detect a vehicle directly ahead, in your path, within a distance of approx. 60 metres.



Activation

Forward collision alert operates automatically above 25 mph, if it is not deactivated with button , see below.

Selecting the alert sensitivity

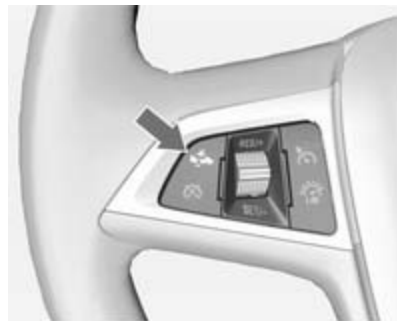
The alert sensitivity can be set to near, medium or far.



Press button : the current setting is shown on the Driver Information Centre. Press button  again to change the alert sensitivity.



Alerting the driver



When approaching another vehicle too rapidly, the collision alert warning page will be indicated in the Driver Information Centre. Simultaneously a warning chime sounds. Depress the brake pedal, if it is required by the situation.

Deactivation

The system can be deactivated. Press button  repeatedly until the following message appears in the Driver Information Centre.

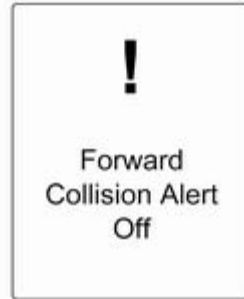

General information

Warning

Forward collision alert is just a warning system and does not apply the brakes. When approaching a vehicle ahead too rapidly, it may not provide you enough time to avoid a collision.

The driver accepts full responsibility for the appropriate following distance based on traffic, weather and visibility conditions.

The complete attention of the driver is always required while driving. The driver must always be ready to take action and apply the brakes.

System limitations

The system is designed to warn only for vehicles, but may react also to other metallic objects.

In the following cases, forward collision alert may not detect a vehicle ahead or sensor performance is limited:

- on winding roads,
- when weather limits visibility, e.g. fog, rain, or snow,
- when the sensor is blocked by snow, ice, slush, mud, dirt, or windscreen damage.

Parking assist

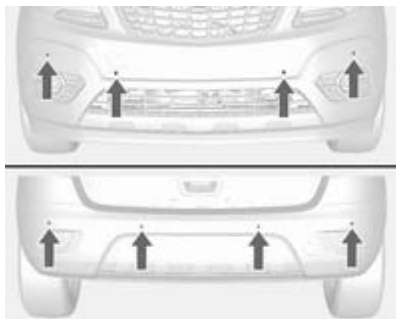

The parking assist makes parking easier by measuring the distance between the vehicle and obstacles, and giving acoustic signals. It is the driver, however, who bears full responsibility for the parking manoeuvre.



The system consists of four ultrasonic parking sensors in the rear bumper. If the vehicle is equipped with a front parking assist the system consists of four additional ultrasonic parking sensors in the front bumper.

Control indicator   86.

Activation





When reverse gear is engaged, the system is activated automatically.

The front parking assist can also be activated at a low speed by pressing the   button.



An illuminated LED in the parking assist button indicates that the system is ready to operate.

An obstacle is indicated by a buzzing sound. The interval between the sounds becomes shorter as the

vehicle gets closer to the obstacle. When the distance is less than 30 cm, the buzzing is continuous.

If the   button is pressed once within an ignition cycle, the front parking assist is always reactivated when the vehicle speed goes below a certain value.



Deactivation



Deactivate the system by pressing the   button.

The LED in the button will go out and **Park Assist Off** will be displayed in the Driver Information Centre.

The system is deactivated automatically at a certain speed.

Fault

In the event of a fault in the system,   illuminates or a vehicle message is displayed in the Driver Information Centre.

Additionally,   illuminates or a vehicle message is displayed in the Driver Information Centre if a

malfunction of the system due to temporary conditions like snow covered sensors is detected.

Vehicle messages ⇨ 94.

Important hints for using the parking assist systems

Warning

Under certain circumstances, various reflective surfaces on objects or clothing as well as external noise sources may cause the system to fail to detect obstacles.

Special attention has to be paid to low obstacles which can damage the lower part of the bumper. If such obstacles leave the detection area of the sensors during approach of the vehicle, a continuous warning tone will sound.

Caution

Performance of the sensor can be reduced when sensors are covered, e.g. by ice or snow.

Performance of the parking assist systems can be reduced due to heavy loading.

Special conditions apply if there are taller vehicles involved (e.g. off-road vehicles, mini vans, vans). Object identification in the upper part of these vehicles cannot be guaranteed.

Objects with a very small reflection cross section, like objects of narrow size or soft materials, may not be detected by the system.

Parking assist will not avoid a collision with objects which are out of the detection range of the sensors.

Note

The parking assist system automatically detects factory-fitted towing equipment. It is deactivated when the connector is plugged in.

The sensor may detect a non-existent object (echo disturbance) caused by external acoustic or mechanical disturbances.

Note

The parking assist is deactivated when the rear carrier system is extended.

Rear view camera

The rear view camera assists the driver when reversing by displaying a view of the area behind the vehicle.

The view of the camera is displayed in the Colour-Info-Display.

Warning

The rear view camera does not replace driver vision. Note that objects that are outside the camera's field of view and the

advanced parking assist sensors, e.g. below the bumper or underneath the vehicle, are not displayed.

Do not reverse the vehicle by only looking at the Info-Display and check the surrounding behind and around the vehicle before reversing.

Activation

Rear view camera is automatically activated when reverse gear is engaged.

Functionality



The camera is mounted in the tailgate handle and has a viewing angle of 130°.

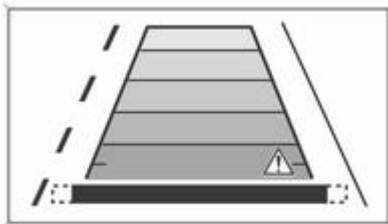

Due to the high position of the camera the rear bumper can be seen on the display as a guide to position.

The area displayed by the camera is limited. The distance of the image that appears on the display differs from the actual distance.

Warning symbols

Warning symbols are indicated as triangles \triangle on the picture which show obstacles detected by the rear sensors of the advanced parking assist.

Display settings

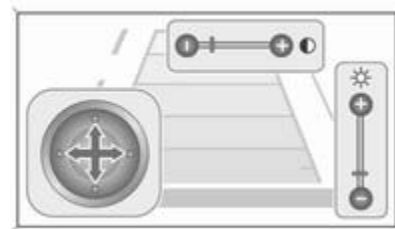

Brightness can be set with the up/down buttons of the multifunction knob.

Contrast can be set with left/right buttons of the multifunction knob.

Deactivation

The camera is deactivated when a certain forward speed is exceeded or if reverse gear is not engaged for approx. 10 seconds.

Activation or deactivation of the rear view camera can be changed in the menu **Settings** in the Info-Display. Vehicle personalisation ↷ 99.

Fault

Fault messages are displayed with a  on the top line of the Info-Display.

The rear view camera may not operate properly when:

- the surrounding is dark,
- the sun or the beam of headlights is shining directly into the camera lens,
- ice, snow, mud, or anything else covers the camera lens. Clean the lens, rinse it with water, and wipe it with a soft cloth,
- the tailgate is not closed correctly,
- the vehicle had a rear end accident,
- there are extreme temperature changes.

Traffic sign assistant

Functionality

The traffic sign assistant system detects designated traffic signs via a front camera and displays them in the Driver Information Centre.



Traffic signs, which will be detected, are:

Limit and no passing signs

- speed limit
- no passing
- end of speed limit
- end of no passing

Road signs

Beginning and end of:

- motorways
- A-roads
- play streets

Add on signs

- additional hints to traffic signs
- restriction of trailer towing
- wet warning
- ice warning
- direction arrows

Speed limit signs are displayed in the Driver Information Centre until the next speed limit sign or end of speed limit is detected or up to a defined sign timeout.



Combinations of more signs in the display are possible.



An exclamation mark in a frame indicates that there is an add on sign detected which cannot be recognised by the system.

The system is active up to a speed of 124 mph depending on the lighting conditions. At night the system is active up to a speed of 99 mph.

As soon as the speed becomes slower than 34 mph the display will be reset and the content of the traffic sign page will be cleared. The next recognised speed indication will be displayed.

Display indication



Traffic signs are displayed on the page **Traffic sign detection** on the Driver Information Centre, chosen via the adjuster wheel on the turn signal lever ↻ 89.

When another function on the Driver Information Centre menu was selected and then **Traffic sign detection** page is chosen again, the last recognised traffic sign will be displayed.

After the traffic sign page is cleared by the system, the following symbol is indicated:



The content of the traffic sign page is also cleared during driving by pressing the **SET/CLR** button on the turn signal lever for a longer time.



Pop-up function

Speed limits and no passing signs are displayed as pop-ups on each page of the Driver Information Centre.

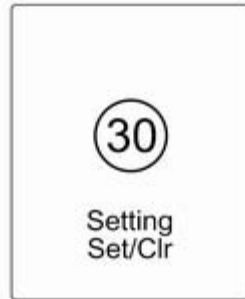

The pop-up function can be deactivated on the traffic sign page by pressing the **SET/CLR** button on the turn signal lever.

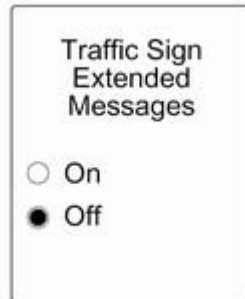

Once setting page is displayed, select **Off** to deactivate pop-up function. Reactivated by selecting **On**. When switching on the ignition, pop-up function is deactivated.

Pop-up indication is displayed for approx. 8 seconds in the Driver Information Centre.

Fault

The traffic sign assistant system may not operate correctly when:

- the area of the windscreen, where the front camera is located, is not clean
- traffic signs are completely or partially covered or difficult to discern
- there are adverse environmental conditions, e.g. heavy rain, snow, direct sunlight or shadows. In this case **No Traffic Sign Detection due to Weather** is indicated on the display

- traffic signs are incorrectly mounted or damaged
- traffic signs do not comply with the Vienna Convention on traffic signs (Wiener Übereinkommen über Straßenverkehrszeichen)

Caution

The system is intended to help the driver within a defined speed range to recognise certain traffic signs. Do not ignore traffic signs which are not displayed by the system.

The system does not recognise any other than the conventional traffic signs that might give or end a speed limit.

Do not let this special feature tempt you into taking risks when driving.

Always adapt speed to the road conditions.

The driver assistance systems do not relieve the driver from full responsibility for vehicle operation.

Lane departure warning

The lane departure warning system observes the lane markings between which the vehicle is driving via a front camera. The system detects lane changes and warns the driver in the event of an unintended lane change via visual and acoustic signals.



Criteria for the detection of an unintended lane change are:

- no operation of turn signals
- no brake pedal operation
- no active accelerator operation or speeding-up
- no active steering

If the driver is active, no warning will be issued.

Activation



The lane departure warning system is activated by pressing the  button. The illuminated LED in the button indicates that the system is switched on. When the control indicator  in the instrument cluster illuminates green, the system is ready to operate. The system is only operable at vehicle speeds above 35 mph and if lane markings are available.

When the system recognises an unintended lane change, the control indicator  changes to yellow and flashes. Simultaneously a chime sound is activated.



Deactivation

The system is deactivated by pressing  button, the LED in the button extinguishes.

At speeds below 35 mph the system is inoperable.

Fault

The lane departure warning system may not operate properly when:

- the windscreen is not clean
- there are adverse environmental conditions like heavy rain, snow, direct sunlight or shadows

The system can not operate when no lane marking is detected.

Fuel

Fuel for petrol engines

Only use unleaded fuel that complies with European standard EN 228 or E DIN 51626-1 or equivalent.

Your engine is capable to run with E10 fuel that fulfills these standards. E10 fuel contains up to 10 % bioethanol.

Use fuel with the recommended octane rating \geq 202. Use of fuel with too low an octane rating can reduce engine power and torque and slightly increases fuel consumption.

Caution

Do not use fuel or fuel additives that contain metallic compounds such as manganese-based additives. This may cause engine damage.

Caution

Use of fuel that does not comply to EN 228 or E DIN 51626-1 or equivalent can lead to deposits or engine damage and may affect your warranty.

Caution

Use of fuel with too low an octane rating could lead to uncontrolled combustion and engine damage.

Fuel for diesel engines

Only use diesel fuel that complies with EN 590.

In countries outside the European Union use Euro-Diesel fuel with a sulphur concentration below 50 ppm.

Caution

Use of fuel that does not comply to EN 590 or similar can lead to engine powerloss, increased wear or engine damage and loss of warranty.

Do not use marine diesel oils, heating oils, Aquazole and similar diesel-water emulsions. Diesel fuels must not be diluted with fuels for petrol engines.

Fuel for liquid gas operation

Liquid gas is known as LPG (Liquefied Petroleum Gas) or under its French name GPL (Gaz de Pétrole Liquéfié). LPG is also known as Autogas.

LPG consists mainly of propane and butane. The octane rating is between 105 and 115, depending on the butane proportion. LPG is stored liquid at around 5 - 10 bar pressure.

The boiling point depends on the pressure and mixing ratio. At ambient pressure, it is between -42 °C (pure propane) and -0.5 °C (pure butane).

Caution

The system works at an ambient temperature of approx. -8 °C to 100 °C.

Full function of the LPG system can only be guaranteed with liquid gas which complies with the minimum requirements of DIN EN 589.

Fuel selector

Pressing the **LPG** button switches between petrol and liquid gas operation as soon as the required parameters (coolant temperature, gas temperature and minimum engine speed) have been reached. The requirements are usually fulfilled after approx. 60 seconds (depending on exterior temperature) and the first firm press on the accelerator. The LED status shows the current operating mode.

LED off	= petrol operation
LED illuminates	= liquid gas operation
LED flashes	= no switching is possible, one type of fuel is empty

As soon as the liquid gas tanks are empty, petrol operation is automatically engaged until the ignition is switched off.

Every six months, run the petrol tank down until control indicator  illuminates, then refuel. This helps maintain fuel quality and system function for petrol operation.

Fill the tank completely at regular intervals to prevent corrosion in the tank.

Faults and remedies

If gas mode is not possible, check the following:

- Is there enough liquid gas present?
- Is there enough petrol present for starting?

Due to extreme temperatures in combination with the gas composition, it may take slightly longer before the system switches from petrol to gas mode.

In extreme situations, the system may also switch back to petrol mode if the minimum requirements are not fulfilled.

Seek the assistance of a workshop in the event of all other faults.

Caution

Repairs and adjustments may only be made by trained specialists in order to maintain the safety and warranty on the LPG system.

Liquid gas is given a particular odour (odorised) so that any leaks can be detected easily.

Warning

If you smell gas in the vehicle or in the immediate vicinity, switch to petrol mode immediately. No smoking. No naked flames or ignition sources.

If the gas odour persists, do not start the engine. Have the cause of the fault remedied by a workshop.

When using underground car parks, follow the instructions of the operator and local laws.

Note

In the event of an accident, switch off the ignition and lights.

Refuelling



⚠ Danger

Before refuelling, switch off engine and any external heaters with combustion chambers. Switch off any mobile phones.

Follow the operating and safety instructions of the filling station when refuelling.

⚠ Danger

Fuel is flammable and explosive. No smoking. No naked flames or sparks.

If you can smell fuel in your vehicle, have the cause of this remedied immediately by a workshop.

Caution

In case of misfuelling, do not switch on ignition.

Fuel filler flap is located at right rear side of vehicle.



The fuel filler flap can only be opened if the vehicle is unlocked. Push flap and open.

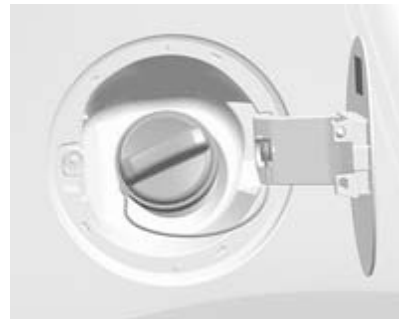

Turn the fuel filler cap slowly anticlockwise to open.

The fuel filler cap can be retained in the bracket on the fuel filler flap.

For refuelling, fully insert the pump nozzle and switch it on.

After automatic cut-off, it can be topped up with max. two doses of fuel.

Caution

Wipe off any overflowing fuel immediately.

To close, turn the fuel filler cap clockwise until it clicks.

Close the flap and let engage.

Liquid gas refuelling

Follow the operating and safety instructions of the filling station when refuelling.

The filling valve for the liquid gas is behind the fuel filler cap.



Unscrew protective cap from the filler neck.



Screw the required adapter hand-tight onto the filler neck.

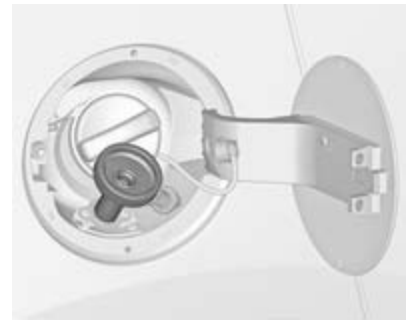

ACME Adapter: Screw the nut of the filling nozzle onto the adapter. Press locking lever on filler nozzle down.

DISH (Italy) filler neck: Place the filler nozzle into the adapter. Press locking lever on filler nozzle down.

Bayonet filler neck: Place filler nozzle on the adapter and turn to the left or right through one quarter turn. Pull locking lever of filler nozzle fully.

EURO filler neck: Press the filler nozzle onto the adapter until it engages.

Press the button of the liquid gas supply point. The filling system stops or begins to run slowly when 80% of the tank volume is reached (maximum fill level).

Release button on filling system and the filling process stops. Release the locking lever and remove the filler nozzle. A small quantity of liquid gas can escape.

Remove adapter and stow in vehicle.

Fit protective cap to prevent the penetration of foreign bodies into the filler opening and the system.

⚠ Warning

Due to the system design, an escape of liquid gas after releasing the locking lever is unavoidable. Avoid inhaling.

⚠ Warning

The liquid gas tank may only be filled to 80% for safety reasons.

The multivalve on the liquid gas tank automatically limits the fill quantity. If a larger quantity is added, we recommend not exposing the vehicle to the sun until the excess amount has been used up.

Filling adapter

As filling systems are not standardised, different adapters are required which are available from Vauxhall Distributors and from Vauxhall Authorised Repairers.

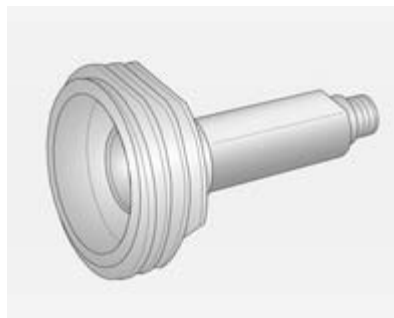

ACME adapter: Belgium, Germany, Ireland, Luxembourg, Switzerland

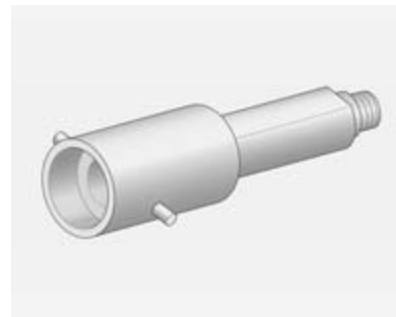

Bayonet adapter: Netherlands, Norway, Spain, United Kingdom

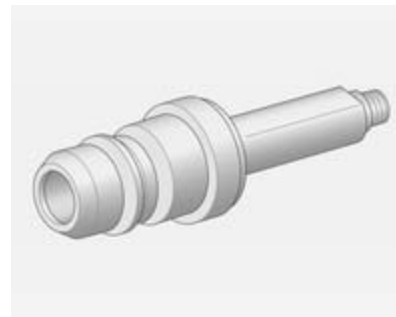

EURO adapter: Spain



DISH (Italy) adapter: Bosnia-Herzegovina, Bulgaria, Denmark, Estonia, France, Greece, Italy, Croatia, Latvia, Lithuania, Macedonia, Austria, Poland, Portugal, Romania, Sweden, Switzerland, Serbia, Slovakia, Slovenia, Czech Republic, Turkey, Ukraine, Hungary

Fuel filler cap

Only use genuine fuel filler caps. Diesel-engined vehicles have special fuel filler caps.

Fuel consumption - CO₂-Emissions

The values for fuel consumption (combined) of the model Vauxhall Mokka is within a range of 37 to 63 mpg.

The values for CO₂ emission (combined) is within a range of 158 to 120 g/km.

For the values specific to your vehicle, refer to the EEC Certificate of Conformity provided with your vehicle or other national registration documents.

General information

The official fuel consumption and specific CO₂ emission figures quoted relate to the EU base model with standard equipment.

Fuel consumption data and CO₂ emission data are determined according to regulation R (EC) No. 715/2007 (in the latest applicable version), taking into

consideration the vehicle weight in running order, as specified by the regulation.

The figures are provided only for the purpose of comparison between different vehicle variants and must not be taken as a guarantee for the actual fuel consumption of a particular vehicle. Additional equipment may result in slightly higher results than the stated consumption and CO₂ figures.

Furthermore, fuel consumption is dependent on personal driving style as well as road and traffic conditions.

Trailer hitch

General information

Only use towing equipment that has been approved for your vehicle.

Entrust retrofitting of towing equipment to a workshop. It may be necessary to make changes that affect the cooling system, heat shields or other equipment.

Fitting of towing equipment could cover the opening of the towing eye. If this is the case, use the coupling ball bar for towing. Always keep the coupling ball bar in the vehicle.

Driving characteristics and towing tips

Before attaching a trailer, lubricate the coupling ball. However, do not do so if a stabiliser, which acts on the coupling ball, is being used to reduce snaking movements.

For trailers with low driving stability and caravan trailers with a permitted gross vehicle weight of more than

1000 kg a speed of 50 mph must not be exceeded; the use of a stabiliser is recommended.

If the trailer starts snaking, drive more slowly, do not attempt to correct the steering and brake sharply if necessary.

When driving downhill, drive in the same gear as if driving uphill and drive at a similar speed.

Adjust tyre pressure to the value specified for full load ⇨ 207.

Trailer towing

Trailer loads

The permissible trailer loads are vehicle and engine-dependent maximum values which must not be exceeded. The actual trailer load is the difference between the actual gross weight of the trailer and the actual coupling socket load with the trailer coupled.

The permissible trailer loads are specified in the vehicle documents. In general, they are valid for gradients up to max. 12 %.

The permitted trailer loads apply up to the specified incline and up to an altitude of 1000 metres above sea level. Since engine power decreases as altitude increases due to the air becoming thinner, therefore reducing climbing ability, the permissible gross train weight also decreases by 10 % for every 1000 metres of additional altitude. The gross train weight does not have to be reduced when driving on roads with slight inclines (less than 8 %, e.g. motorways).

The permissible gross train weight must not be exceeded. This weight is specified on the identification plate ⇨ 197.

Vertical coupling load

The vertical coupling load is the load exerted by the trailer on the coupling ball. It can be varied by changing the weight distribution when loading the trailer.

The maximum permissible vertical coupling load (75 kg) is specified on the towing equipment identification plate and in the vehicle documents. Always aim for the maximum load,

especially in the case of heavy trailers. The vertical coupling load should never fall below 25 kg.

Rear axle load

The permissible axle loads (see identification plate or vehicle documents) must not be exceeded.

Vehicle care

General Information	154
Vehicle checks	155
Bulb replacement	162
Electrical system	168
Vehicle tools	173
Wheels and tyres	174
Jump starting	187
Towing	189
Appearance care	191

General Information

Accessories and vehicle modifications

We recommend the use of genuine parts and accessories and factory approved parts specific for your vehicle type. We cannot assess or guarantee reliability of other products - even if they have a regulatory or otherwise granted approval.

Do not make any modifications to the electrical system, e.g. changes of electronic control units (chip tuning).

Caution

When transporting the vehicle on a train or on a recovery vehicle, the mud flaps might be damaged.

Vehicle storage

Storage for a long period of time

If the vehicle is to be stored for several months:

- Wash and wax the vehicle.
- Have the wax in the engine compartment and underbody checked.
- Clean and preserve the rubber seals.
- Fill up fuel tank completely.
- Change the engine oil.
- Drain the washer fluid reservoir.
- Check the coolant antifreeze and corrosion protection.
- Adjust tyre pressure to the value specified for full load.
- Park the vehicle in a dry, well ventilated place. Engage first or reverse gear or set selector lever to **P**. Prevent the vehicle from rolling.
- Do not apply the parking brake.

- Open the bonnet, close all doors and lock the vehicle.
- Disconnect the clamp from the negative terminal of the vehicle battery. Beware that all systems are not functional, e.g. anti-theft alarm system.

Putting back into operation

When the vehicle is to be put back into operation:

- Connect the clamp to the negative terminal of the vehicle battery. Activate the electronics of the power windows.
- Check tyre pressure.
- Fill up the washer fluid reservoir.
- Check the engine oil level.
- Check the coolant level.
- Fit the number plate if necessary.

End-of-life vehicle recovery

Information on end-of-life vehicle recovery centres and the recycling of end-of-life vehicles is available on our

website, where legally required. Only entrust this work to an authorised recycling centre.

Gas vehicles must be recycled by a service centre authorised for gas vehicles.

Vehicle checks

Performing work



⚠ Warning

Only perform engine compartment checks when the ignition is off.

The cooling fan may start operating even if the ignition is off.

⚠ Danger

The ignition system and Xenon headlights use extremely high voltage. Do not touch.

Bonnet**Opening**

Pull the release lever and return it to its original position.

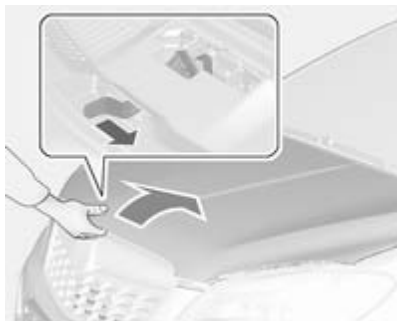

Move the safety catch sideways to the left vehicle side and open the bonnet.

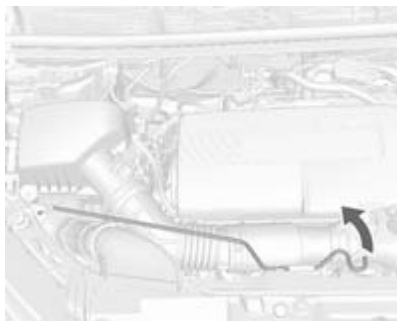

Pull up the support rod lightly from the holder. And then secure it at the left side hook on the bonnet.

If the bonnet is opened during an Autostop, the engine will be restarted automatically for safety reasons.

Closing

Before closing the bonnet, press the support into the holder.

Lower the bonnet and allow it to drop into the catch. Check that the bonnet is engaged.

Engine oil

Check the engine oil level manually on a regular basis to prevent damage to the engine. Ensure that the correct specification of oil is used.

Recommended fluids and lubricants
 ⇨ 195.

Check with the vehicle on a level surface. The engine must be at operating temperature and switched off for at least 5 minutes.

Pull out the dipstick, wipe it clean, insert it to the stop on the handle, pull out and read the engine oil level.

Insert dipstick to the stop on the handle and make half a turn.

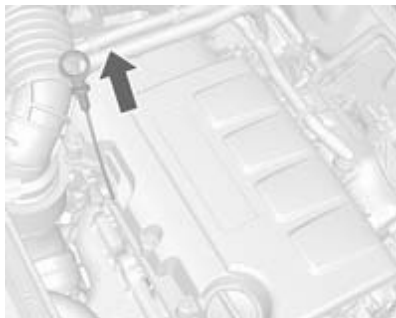

When the engine oil level has dropped to the **MIN** mark, top up engine oil.

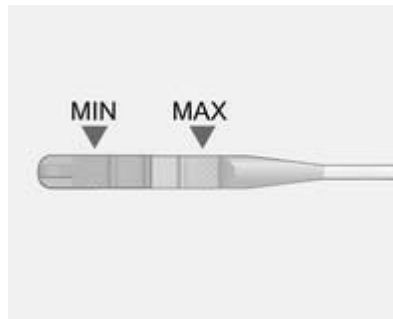

We recommend the use of the same grade of engine oil that was used at last change.

The engine oil level must not exceed the **MAX** mark on the dipstick.



The engine oil filler cap is located on the camshaft cover.

Caution

Overfilled engine oil must be drained or suctioned out.

Capacities ⇨ 206.

Fit the cap on straight and tighten it.

Engine coolant

The coolant provides freeze protection down to approx. -30 °C. In northern countries with very low

temperatures the factory filled coolant provides frost protection down to approx. -40 °C.

Caution

Only use approved antifreeze.

Coolant level

Caution

Too low a coolant level can cause engine damage.



If the cooling system is cold, the coolant level should be above the filling line mark. Top up if the level is low.

Warning

Allow the engine to cool before opening the cap. Carefully open the cap, relieving the pressure slowly.

To top up use a 1:1 mixture of released coolant concentrate mixed with clean tap water. If no coolant concentrate is available, use clean tap water. Install the cap tightly. Have the coolant concentration checked and have the cause of the coolant loss remedied by a workshop.

Power steering fluid

Caution

Extremely small amounts of contamination can cause steering system damage and cause it to not

work properly. Do not allow contaminants to contact the fluid side of the reservoir cap/dipstick or from entering the reservoir.

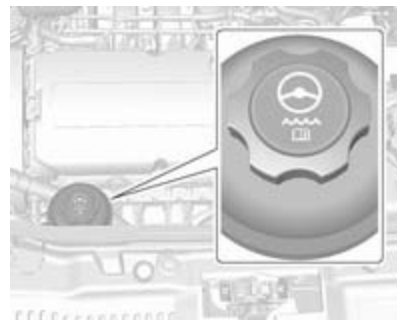

Power steering fluid level normally does not need to be checked. If an unusual noise sounds during steering or the power steering reacts conspicuously, seek the assistance of a workshop.

Washer fluid



Fill with clean water mixed with a suitable quantity of windscreen washer fluid which contains antifreeze.

Caution

Only washer fluid with a sufficient antifreeze concentration provides protection at low temperatures or a sudden drop in temperature.

Brakes

In the event of minimum thickness of the brake lining, a squealing noise sounds during braking.

Continued driving is possible but have the brake lining replaced as soon as possible.

Once new brake linings are installed, do not brake unnecessarily hard for the first few journeys.

Brake fluid

⚠ Warning

Brake fluid is poisonous and corrosive. Avoid contact with eyes, skin, fabrics and painted surfaces.



The brake fluid level must be between the **MIN** and the **MAX** marks.

If fluid level is below **MIN** seek the assistance of a workshop.

Brake and clutch fluid ↗ 195.

Vehicle battery

Vehicles without stop-start system will be equipped with a lead acid battery. Vehicles with stop-start system will be equipped with an AGM battery which is not a lead acid battery.

The vehicle battery is maintenance-free provided that the driving profile allows sufficient charging of the battery. Short-distance-driving and frequent engine starts can discharge the battery. Avoid the use of unnecessary electrical consumers.



Batteries do not belong in household waste. They must be disposed of at an appropriate recycling collection point.

Laying up the vehicle for more than 4 weeks can lead to battery discharge. Disconnect the clamp from the negative terminal of the vehicle battery.

Ensure the ignition is switched off before connecting or disconnecting the vehicle battery.

The anti-theft alarm siren must be deactivated as follows: Switch the ignition on then off, disconnect the vehicle's battery within 15 seconds.

Vehicle battery discharge protection
 ⇨ 111.

Replacing the vehicle battery

Note

Any deviation from the instructions given in this section may lead to temporary deactivation of the stop-start system.

When the vehicle battery is being replaced, please ensure that there are no open ventilation holes in the vicinity of the positive terminal. If a ventilation hole is open in this area, it must be closed off with a dummy cap, and the ventilation in the vicinity of the negative terminal must be opened.

Only use vehicle batteries that allow the fuse box to be mounted above the vehicle battery.

In vehicles with stop-start system, be sure to have the AGM (Absorptive Glass Mat) battery replaced with another AGM battery.



An AGM battery can be identified by the label on the battery. We recommend the use of an original Vauxhall vehicle battery.

Note

Using an AGM vehicle battery different from the original Vauxhall vehicle battery may result in a lower performance of the stop-start system.

We recommend that you have the vehicle battery replaced by a workshop.

Stop-start system ⇨ 120.

Charging the vehicle battery

⚠ Warning

On vehicles with stop-start system, ensure that the charging potential does not exceed 14.6 volts when using a battery charger. Otherwise the vehicle battery might be damaged.

Jump starting ⇨ 187.

Warning label



Meaning of symbols:

- No sparks, naked flames or smoking.
- Always shield eyes. Explosive gases can cause blindness or injury.
- Keep the vehicle battery out of reach of children.
- The vehicle battery contains sulphuric acid which could cause blindness or serious burn injuries.
- See the Owner's Manual for further information.
- Explosive gas may be present in the vicinity of the vehicle battery.

Diesel fuel system bleeding

If the tank has been run dry, the diesel fuel system must be bled. Switch on the ignition three times for 15 seconds at a time. Then crank the engine for a maximum of 40 seconds. Repeat this process after no less than 5 seconds. If the engine fails to start, seek the assistance of a workshop.

Wiper blade replacement

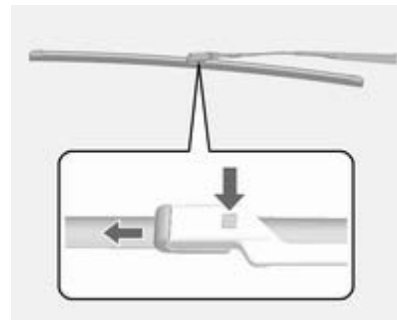

Lift the wiper arm, press button to disengage the wiper blade and remove.

Attach the wiper blade slightly angled to the wiper arm and push until it engages.

Lower wiper arm carefully.

Wiper blade on the rear window



1. Remove the wiper cover from the wiper assembly.

2. Lift wiper blade.

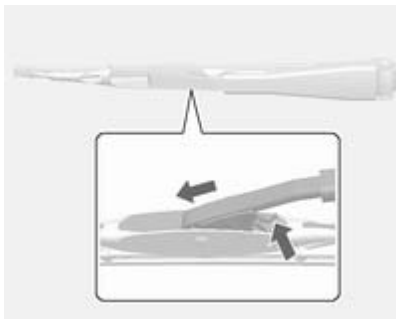

3. Press slider holder pin.
4. Pull wiper blade out.

Bulb replacement

Switch off the ignition and turn off the relevant switch or close the doors.

Only hold a new bulb at the base. Do not touch the bulb glass with bare hands.

Use only the same bulb type for replacement.

Replace headlight bulbs from within the engine compartment.

Halogen headlights

Low beam and high beam



Remove protective cover.

Low beam



1. Disconnect the headlight bulb socket connector.



2. Press spring clip, disengage it.



3. Remove the bulb from the bulb socket and replace the bulb.

4. When fitting a new bulb, engage the lugs in the recesses on the reflector.
5. Reinstall the headlight assembly.
6. Engage the spring clip.
7. Connect the bulb socket connector.
8. Place headlight protective cover in position and close.

High beam



1. Remove the bulb socket by pulling.
2. Remove the bulb from the bulb socket and replace the bulb.

3. When fitting a new bulb, engage the lugs in the recesses on the reflector.
4. Reinstall the headlight assembly.
5. Place headlight protective cover in position and close.

Sidelights



1. Remove the socket from the assembly by turning counterclockwise.
2. Remove bulb socket from reflector.
3. Detach plug connector from bulb.



4. Remove bulb from socket.
5. Insert new bulb.
6. Plug connector onto bulb.
7. Insert socket in reflector.
8. Reinstall the assembly.

Xenon headlights

⚠ Danger

Xenon headlights work under extremely high electrical voltage. Do not touch. Have bulbs replaced by a workshop.

Cornering lights



1. Remove the protective cover.

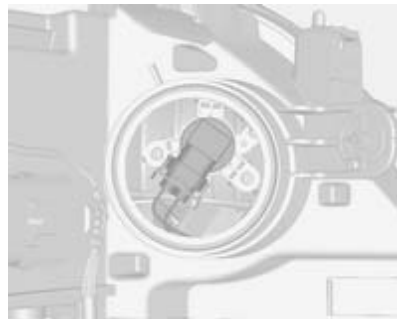

2. Remove the bulb socket by pulling.



3. Remove the bulb from the bulb socket and replace the bulb.
4. When fitting a new bulb, engage the lugs in the recesses on the reflector.
5. Reinstall the headlight assembly.
6. Place headlight protective cover in position and close.

Fog lights

Have bulbs replaced by a workshop.

Front turn signal lights



1. Rotate bulb holder counterclockwise and disengage.



2. Push bulb into socket slightly, rotate counterclockwise, remove and renew bulb.
3. Insert bulb holder in reflector, rotate clockwise to engage.

Tail lights

Left-hand side



1. Remove both covers and unscrew screws. Remove the panel.



2. Remove the cover.

1. Remove the storage door and the tyre repair kit.



2. Remove the cover.

Right-hand side

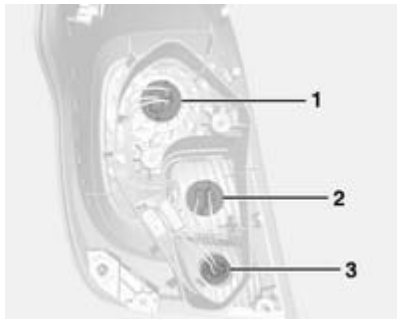

3. Tail/Stop light (1)
Turn signal light (2)
Back-up lamp (3)

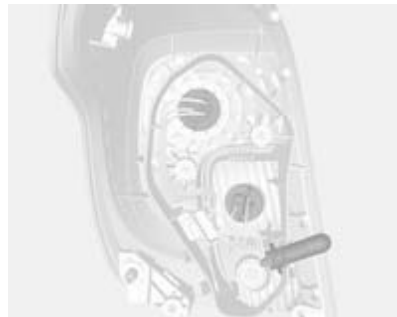

4. Remove bulb holder. Remove and renew bulb.
5. Insert bulb holder into the taillamp assembly. Install tail light assembly in body and tighten. Close covers and engage.
6. Switch on ignition, operate and check all lights.

Side turn signal lights



If the lights do not operate, have them checked by a workshop.

Centre high-mounted brake light



If the centre high-mounted brake light does not operate, have it checked by a workshop.

Number plate light



1. Pry the light out with a screwdriver.
2. Remove bulb housing downward, taking care not to pull on the cable.
Rotate bulb holder counterclockwise to disengage.
3. Remove bulb from holder and renew bulb.
4. Insert bulb holder in bulb housing and rotate clockwise.
5. Insert bulb housing and secure using a screwdriver.

Interior lights

Courtesy lights

1. To remove it, prise the opposite side of the light switch using a flat-blade screwdriver.
2. Remove the bulb.
3. Replace the bulb.
4. Reinstall the light assembly.

Load compartment light

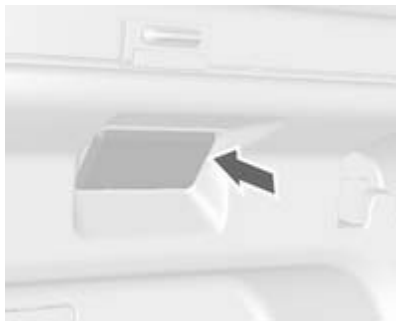

1. Prise the light out with a screwdriver.
2. Remove bulb.

3. Insert new bulb.
4. Install light.

Electrical system

Fuses

Data on the replacement fuse must match the data on the defective fuse.

In a box above the positive terminal of the battery are some main fuses. If necessary have them changed by a workshop.

Before replacing a fuse, turn off the respective switch and the ignition.

A blown fuse can be recognised by its melted wire. Do not replace the fuse until the cause of the fault has been remedied.

Some functions are protected by several fuses.

Fuses may also be inserted without existence of a function.

Note

Not all fuse box descriptions in this manual may apply to your vehicle.

When inspecting the fuse box, refer to the fuse box label.

Fuse extractor

A fuse extractor may be located in the fuse box in the engine compartment.

Place the fuse extractor on the various types of use from the top or side, and withdraw fuse.

Engine compartment fuse box

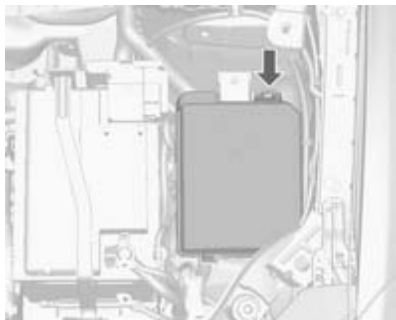

The fuse box is in the engine compartment.

Disengage the cover, lift it upwards and remove.

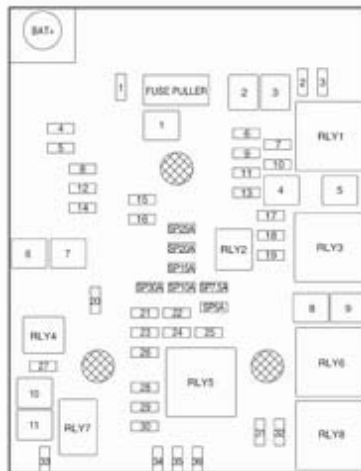

Mini Fuses

No. Circuit

- | No. | Circuit |
|-----|---------------------------------|
| 1 | Sunroof |
| 2 | Exterior mirrors |
| 3 | - |
| 4 | - |
| 5 | Electrical brake control module |
| 6 | Intelligent battery sensor |
| 7 | - |
| 8 | Transmission control module |
| 9 | Body control module |
| 10 | Headlight levelling |
| 11 | Rear window wiper |
| 12 | Heated rear window |
| 13 | Headlight actuator (left hand) |
| 14 | Heated exterior mirrors |
| 15 | - |
| 16 | Seat heating |
| 17 | Transmission control module |

No. Circuit

- 18 Engine control module
- 19 Fuel pump
- 20 –
- 21 Cooling fan
- 22 –
- 23 Ignition coil, Engine control module
- 24 Washer pump
- 25 Headlamp actuator (right hand)
- 26 Engine control module
- 27 –
- 28 Engine control module
- 29 Engine control module
- 30 Exhaust system
- 31 Left-hand high beam
- 32 Right-hand high beam
- 33 Engine control module

No. Circuit

- 34 Horn
- 35 Climate control, air conditioning system
- 36 Front fog lamp

J-cases Fuses

No. Circuit

- 1 Electrical brake control module
- 2 Front wiper
- 3 Engine control module
- 4 Engine control module
- 5 –
- 6 Fuel heater
- 7 –
- 8 Cooling fan
- 9 Cooling fan

No. Circuit

- 10 Engine control module, Glow plug
- 11 Starter

Instrument panel fuse box



Interior fuse block is located on the underside of the driver's side instrument panel.

To access the fuses, remove the storage.

To remove the storage, open and pull it.

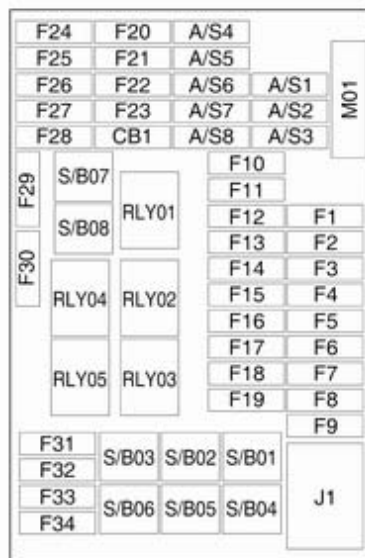

Mini Fuses

No. Circuit

- 1 Body control module
- 2 Body control module
- 3 Body control module
- 4 Body control module
- 5 Body control module
- 6 Body control module
- 7 Body control module
- 8 Body control module
- 9 Door locks
- 10 Safety diagnosis module
- 11 Door locks
- 12 Climate control
- 13 Tailgate
- 14 Park assist
- 15 Lane departure warning, Interior mirror
- 16 Adaptive forward lighting

No. Circuit

- 17 Power window driver
- 18 Rain sensor
- 19 Spare
- 20 Steering wheel
- 21 Transmission control module
- 22 Cigarette lighter
- 23 Spare
- 24 Spare
- 25 Spare
- 26 Display
- 27 Instrument panel cluster
- 28 Adaptive forward lighting
- 29 Spare
- 30 Spare
- 31 Instrument panel cluster
- 32 Infotainment, auxiliary, power outlet

No. Circuit

- 33 Display, Infotainment system
34 Onstar UHP/DAB

S/B Fuses**No. Circuit**

- 01 Spare
02 Spare
03 Power windows front
04 Power windows rear
05 Logistic mode
06 Spare
07 Spare
08 Spare

Load compartment fuse box

Located in the left side of rear compartment.

To access the fuses, remove the cover.

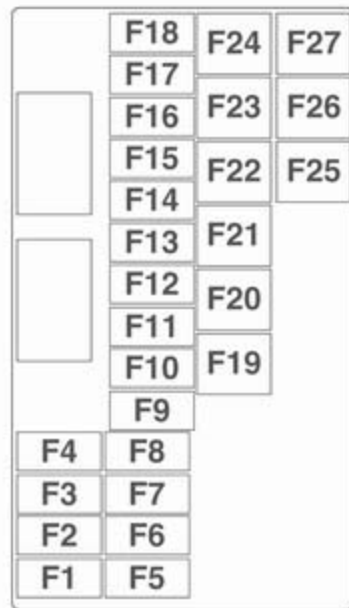
**Mini Fuses**

No. Circuit

- 1 LPG system
- 2 Interior mirror, rear view camera
- 3 Water in fuel sensor
- 4 Spare
- 5 Trailer socket
- 6 Heated steering wheel
- 7 Spare
- 8 Trailer control module
- 9 Seat, lumbar support, driver
- 10 Seat, lumbar support, passenger
- 11 Amplifier
- 12 Trailer socket
- 13 All-wheel drive
- 14 Spare
- 15 LPG system
- 16 Spare

No. Circuit

- 17 Spare
- 18 Spare

S/B Fuses**No. Circuit**

- 19 Power seat driver
- 20 Power seat passenger
- 21 Trailer control module
- 22 Voltage converter
- 23 Ignition system
- 24 Headlight washer
- 25 Spare
- 26 Spare
- 27 Spare

Vehicle tools

Tools

Vehicles with tyre repair kit



The tools and tyre repair kit are in the right side of the load compartment.
 ⇨ 180.

Vehicles with spare wheel



The jack and the tools are in a storage compartment in the load compartment above the spare wheel. Wheel changing ⇨ 183, spare wheel ⇨ 185.

Wheels and tyres

Tyre condition, wheel condition

Drive over edges slowly and at right angles if possible. Driving over sharp edges can cause tyre and wheel damage. Do not trap tyres on the kerb when parking.

Regularly check the wheels for damage. Seek the assistance of a workshop in the event of damage or unusual wear.

Tyres

Tyres of size 195/70 R16 and 215/60 R17 are only to be used as winter tyres.

Winter tyres

Winter tyres improve driving safety at temperatures below 7 °C and should therefore be fitted on all wheels.

In accordance with country-specific regulations, affix the speed sticker in the driver's field of view.

Tyre size 195/70 R 16 is only suitable as winter tyre.

Tyre designations

E.g. **215/60 R 16 95 H**

- 215** = Tyre width, mm
- 60** = Cross-section ratio (tyre height to tyre width), %
- R** = Belt type: Radial
- RF** = Type: RunFlat
- 16** = Wheel diameter, inches
- 95** = Load index e.g. 95 is equivalent to 690 kg
- H** = Speed code letter

Speed code letter:

- Q** = up to 100 mph
- S** = up to 112 mph
- T** = up to 118 mph
- H** = up to 130 mph
- V** = up to 150 mph
- W** = up to 168 mph

Tyre pressure

Check the pressure of cold tyres at least every 14 days and before any long journey. Do not forget the spare wheel. This also applies to vehicles with tyre pressure monitoring system.

Unscrew the valve cap.



Tyre pressure ⇨ 207 and on the label on the driver's door frame.

The tyre pressure data refers to cold tyres. It applies to summer and winter tyres.

Always inflate the spare tyre to the pressure specified for full load.

The ECO tyre pressure serves to achieve the smallest amount of fuel consumption possible.

Incorrect tyre pressures will impair safety, vehicle handling, comfort and fuel economy and will increase tyre wear.

Tyre pressures differ depending on various options. For the correct tyre pressure value, follow the procedure below:

1. Identify the engine identifier code.
Engine data ⇨ 202.
2. Identify the respective tyre.

The tyre pressure tables show all possible tyre combinations ⇨ 207.

For the tyres approved for your vehicle, refer to the EEC Certificate of Conformity provided with your vehicle or other national registration documents.

The driver is responsible for correct adjustment of tyre pressure.

⚠ Warning

If the pressure is too low, this can result in considerable tyre warm-up and internal damage, leading to tread separation and even to tyre blow-out at high speeds.

Tyre pressure monitoring system

The Tyre Pressure Monitoring System (TPMS) uses radio and sensor technology to check tyre pressure levels.

All wheels must be equipped with pressure sensors and the tyres must have the prescribed pressure.

Note

In countries where the tyre pressure monitoring system is legally required, the use of wheels without pressure sensors will invalidate the vehicle type approval.

The TPMS sensors monitor the air pressure in the tyres and transmit tyre pressure readings to a receiver located in the vehicle.

Each tyre, including the spare, should be checked monthly when cold and inflated to the inflation pressure recommended on the tyre pressure label.

Control indicator (⚠) illuminates when one or more tyres are significantly under-inflated.

Check the tyre pressure as soon as possible, and inflate them to the recommended pressure ⇨ 175.

When the system detects a malfunction, (⚠) will flash for approx. one minute and then remain continuously illuminated. This sequence will continue upon subsequent vehicle start-ups as long as the malfunction exists.

When (⚠) is illuminated, the system may not be able to detect or signal low tyre pressure as intended.

Tyre Pressure Monitoring Operation

The TPMS is designed to warn the driver when a low tyre pressure condition exists. TPMS sensors are mounted onto each tyre and wheel assembly, excluding the spare tyre and wheel assembly. The TPMS sensors monitor the air pressure in the tyres and transmit the tyre pressure readings to a receiver located in the vehicle.



When a low tyre pressure condition is detected, (⚠) illuminates. Stop as soon as possible and inflate the tyres to the recommended tyre pressure ⇨ 175.

Additionally a warning message or a warning code is displayed in the Driver Information Centre ⇨ 94.

The low tyre pressure control indicator and a warning message or code come on at each ignition cycle until the tyres are inflated to the correct tyre pressure.

TPMS Malfunction Indicator and Message Code

The TPMS will not function properly if one or more of the TPMS sensors are missing or inoperable. When the system detects a malfunction, (⚠) flashes for approx. one minute and then illuminates. Additionally a warning message or code is displayed.

The indication by the TPMS malfunction indicator and a warning message or code will come on at each ignition cycle until the problem is corrected. Some of the conditions that can cause these to come on are:

- One of the tyres has been replaced with the spare tyre which does not have a TPMS sensor.

- The TPMS sensor matching process was not done or not completed successfully after rotating the tyres. The malfunction light and the warning message or code should go off after successfully completing the sensor matching process. See "TPMS Sensor Matching Process" later in this section.
- One or more TPMS sensors are missing or damaged. The warning message or code and the malfunction light should go off when the TPMS sensors are installed and the sensor matching process is performed successfully. Consult your workshop for service.
- Replacement tyres or wheels do not match the original equipment tyres or wheels. Tyres and wheels other than those recommended could prevent the TPMS from functioning properly.
- Operating electronic devices or being near facilities using radio wave frequencies similar to the

TPMS could cause the TPMS sensors to malfunction.

If the TPMS is not functioning properly, it cannot detect or signal a low tyre condition. Consult your workshop for service if the TPMS malfunction light and a warning message or code come on and stay on.

TPMS Sensor Matching Process

Each TPMS sensor has a unique identification code. The identification code must be matched to a new tyre/wheel position after rotating the tyres or replacing one or more of the TPMS sensors. The TPMS sensor matching process should also be performed after replacing a spare tyre with a road tyre containing the TPMS sensor.

The malfunction light and the warning message or code should go off at the next ignition cycle. The sensors are matched to the tyre/wheel positions, using a TPMS relearn tool, in the following order: driver side front tyre, passenger side front tyre, passenger

side rear tyre, and driver side rear. Consult your workshop for service or to purchase a relearn tool. There are two minutes to match the first tyre/wheel position, and five minutes overall to match all four tyre/wheel positions. If it takes longer, the matching process stops and must be restarted.

The TPMS sensor matching process is:

1. Apply the parking brake.
2. Turn the ignition on.
3. Use the **MENU** button on the turn signal lever to select the **Vehicle Information Menu** in the Driver Information Centre (DIC).
4. Use the thumbwheel to scroll to the tyre pressure menu.
5. Press the **SET/CLR** button to begin the sensor matching process. A message requesting acceptance of the process should display.

6. Press the **SET/CLR** button again to confirm the selection. The horn sounds twice to signal the receiver is in relearn mode.
7. Start with the driver side front tyre.
8. Place the relearn tool against the tyre sidewall, near the valve stem. Then press the button to activate the TPMS sensor. A horn chirp confirms that the sensor identification code has been matched to this tyre and wheel position.
9. Proceed to the passenger side front tyre, and repeat the procedure in Step 8.
10. Proceed to the passenger side rear tyre, and repeat the procedure in Step 8.
11. Proceed to the driver side rear tyre, and repeat the procedure in Step 8. The horn sounds twice to indicate the sensor identification code has been matched to the driver side rear tyre, and the TPMS sensor matching process is no longer active.
12. Turn off the ignition.
13. Set all four tyres to the recommended air pressure level as indicated on the tyre pressure label.

Tread depth

Check tread depth at regular intervals.

Tyres should be replaced for safety reasons at a tread depth of 2-3 mm (4 mm for winter tyres).

For safety reasons it is recommended that the tread depth of the tyres on one axle should not vary by more than 2 mm.



The legally permissible minimum tread depth (1.6 mm) has been reached when the tread has worn down as far as one of the tread wear indicators (TWI). Their position is indicated by markings on the sidewall.

If there is more wear at the front than the rear, swap round front wheels and rear wheels. Ensure that the direction of rotation of the wheels is the same as before.

Tyres age, even if they are not used. We recommend tyre replacement every 6 years.

Changing tyre and wheel size

If tyres of a different size than those fitted at the factory are used, it may be necessary to reprogramme the speedometer as well as the nominal tyre pressure and make other vehicle modifications.

After converting to a different tyre size, have the label with tyre pressures replaced.

⚠ Warning

Use of unsuitable tyres or wheels may lead to accidents and will invalidate the vehicle type approval.

Wheel covers

Wheel covers and tyres that are factory-approved for the respective vehicle and comply with all of the relevant wheel and tyre combination requirements must be used.

If the wheel covers and tyres used are not factory-approved, the tyres must not have a rim protection ridge.

Wheel covers must not impair brake cooling.

⚠ Warning

Use of unsuitable tyres or wheel covers could lead to sudden pressure loss and thereby accidents.

Vehicles with alloy wheels: When mounting steel wheels with alloy wheel nuts, e.g. when changing to winter tyres, the wheel covers cannot be attached to the steel wheels.

Tyre chains



Use tyre chains only on front wheels.

⚠ Warning

Damage may lead to tyre blowout.

Tyre chains are permitted on tyres of size 195/70 R16.

Always use fine mesh chains suitable for sport utility vehicles that add no more than 12 mm to the tyre tread and the inboard sides (including chain lock).

On tyres of size 215/55 R18, special snow chains are only permitted when they are designed with a rotating chain belt on the tyre tread, no chain links on the wheel inboard sides and the chains add no more than 12 mm to the tyre tread. For further information regarding correct snow chain usage for this tyre size, contact a specialized vehicle parts dealer or snow chain manufacturer.

Tyre chains are not permitted on tyres of size 205/70 R16, 215/65 R16, 215/60 R17 and 225/45 R19.

The use of tyre chains is not permitted on the temporary spare wheel.

Tyre repair kit

Minor damage to the tyre tread can be repaired with the tyre repair kit.

Do not remove foreign bodies from the tyres.

Tyre damage exceeding 4 mm or that is at tyre's sidewall cannot be repaired with the tyre repair kit.

⚠ Warning

Do not drive faster than 50 mph.
Do not use for a lengthy period.
Steering and handling may be affected.

If you have a flat tyre:

Apply the parking brake and engage first gear, reverse gear or **P**.



The tyre repair kit is located in the right side of rear compartment.



1. Take the tyre repair kit from the compartment.
2. Remove the compressor.

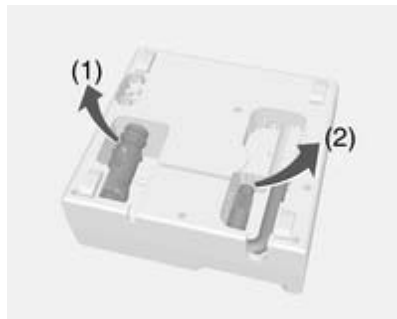

- Remove the electrical connection cable (1) and air hose (2) from the stowage compartments on the underside of the compressor.



- Screw the compressor air hose to the connection on the sealant bottle.
- Fit the sealant bottle into the retainer on the compressor.
Set the compressor near the tyre in such a way that the sealant bottle is upright.

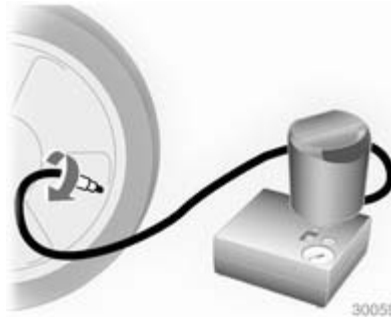

- Unscrew valve cap from defective tyre.
- Screw the filler hose to the tyre valve.
- The switch on the compressor must be set to O.
- Connect the compressor plug to the power outlet or cigarette lighter socket.
To avoid discharging the battery, we recommend running the engine.

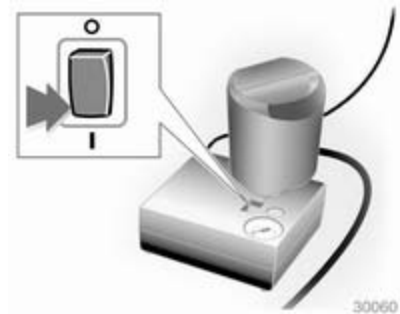

- Set the rocker switch on the compressor to I. The tyre is filled with sealant.
- The compressor pressure gauge briefly indicates up to 6 bar whilst the sealant bottle is emptying (approx. 30 seconds). Then the pressure starts to drop.
- All of the sealant is pumped into the tyre. Then the tyre is inflated.
- The prescribed tyre pressure should be obtained within 10 minutes. Tyre pressure \varnothing 207. When the correct pressure is obtained, switch off the compressor.



If the prescribed tyre pressure is not obtained within 10 minutes, remove the tyre repair kit. Move the vehicle one tyre rotation. Reattach the tyre repair kit and continue the filling procedure for 10 minutes. If the prescribed tyre pressure is still not obtained, the tyre is too badly damaged. Seek the assistance of a workshop.

Drain excess tyre pressure with the button over the pressure indicator.

Do not run the compressor longer than 10 minutes.

14. Detach the tyre repair kit. Push catch on bracket to remove sealant bottle from bracket. Screw the tyre inflation hose to the free connection of the sealant bottle. This prevents sealant from escaping. Stow tyre repair kit in load compartment.
15. Remove any excess sealant using a cloth.
16. Take the label indicating maximum permitted speed from the sealant bottle and affix in the driver's field of view.
17. Continue driving immediately so that sealant is evenly distributed in the tyre. After driving approx. 6 miles (but no more than 10 minutes), stop and check tyre pressure. Screw compressor air hose directly onto tyre valve and compressor when doing this.

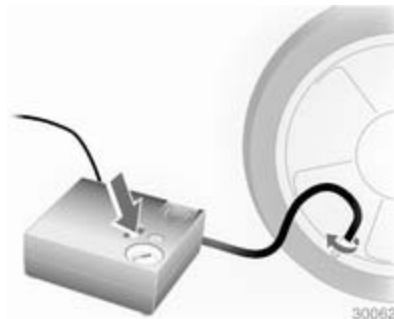

If tyre pressure is more than 1.3 bar, set it to the correct value. Repeat the procedure until there is no more loss of pressure.

If the tyre pressure has fallen below 1.3 bar, the vehicle must not be used. Seek the assistance of a workshop.

18. Stow away tyre repair kit in load compartment.

Note

The driving characteristics of the repaired tyre are severely affected, therefore have this tyre replaced.

If unusual noise is heard or the compressor becomes hot, turn compressor off for at least 30 minutes.

The built-in safety valve opens at a pressure of 102 psi.

Note the expiry date of the kit. After this date its sealing capability is no longer guaranteed. Pay attention to storage information on sealant bottle.

Replace the used sealant bottle. Dispose of the bottle as prescribed by applicable laws.

The compressor and sealant can be used from approx. -30 °C.

The adapters supplied can be used to pump up other items e.g. footballs, air mattresses, inflatable dinghies etc. They are located on the underside of the compressor. To remove, screw on compressor air hose and withdraw adapter.

Wheel changing

Some vehicles are equipped with a tyre repair kit instead of a spare wheel ⇨ 180.

Make the following preparations and observe the following information:

- Park the vehicle on a level, firm and non-skid surface. The front wheels must be in the straight-ahead position.
- Apply the parking brake and engage first gear, reverse gear or P.
- Remove the spare wheel ⇨ 185.
- Never change more than one wheel at once.
- Use the jack only to change wheels in case of puncture, not for seasonal winter or summer tyre change.
- If the ground on which the vehicle is standing is soft, a solid board (max. 1 cm thick) should be placed under the jack.
- Take heavy objects out of the vehicle before jacking up.

- No people or animals may be in the vehicle when it is jacked-up.
- Never crawl under a jacked-up vehicle.
- Do not start the vehicle when it is raised on the jack.
- Clean wheel nuts and thread with a clean cloth before mounting the wheel.

Warning

Do not grease wheel bolt, wheel nut and wheel nut cone.

1. Disengage wheel nut caps with a screwdriver and remove. Pull off the wheel cover.



2. Fold out the wheel wrench and install ensuring that it locates securely and loosen each wheel nut by half a turn.

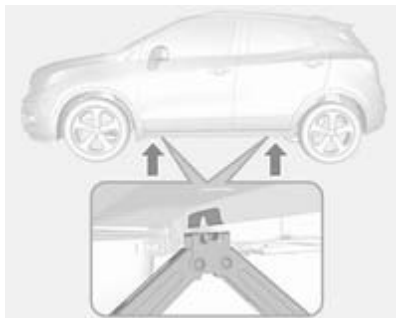

3. Ensure the jack is correctly positioned under the relevant vehicle jacking point.
Depending on the equipment, first remove the covers from the jacking points.
4. Set the jack to the necessary height. Position it directly below the jacking point in a manner that prevents it from slipping.



Attach wheel wrench and with the jack correctly aligned rotate wheel wrench until wheel is clear of the ground.

5. Unscrew the wheel nuts.

6. Change the wheel. Spare wheel ⇨ 185.
7. Screw on the wheel nuts.
8. Lower the vehicle and remove jack.
9. Install the wheel wrench ensuring that it locates securely and tighten each nut in a crosswise sequence. Tightening torque is 140 Nm.
10. Align the valve hole in the wheel cover with the tyre valve before installing.
Install wheel nut caps.
Install centre cap on alloy wheels.
11. Install vehicle jacking point cover on versions with sill panelling.
12. Stow the replaced wheel ⇨ 185 and the vehicle tools ⇨ 173.
13. Check the tyre pressure of the installed tyre and the wheel nut torque as soon as possible.

Have the defective tyre renewed or repaired as soon as possible.

Jacking position for lifting platform



Rear arm position of the lifting platform centrally under the recess of the sill.



Front arm position of the lifting platform at the underbody.

Spare wheel

Some vehicles are equipped with a tyre repair kit instead of a spare wheel.

If mounting a spare wheel, which is different from the other wheels, this wheel might be classified as a temporary spare wheel and the corresponding speed limits apply, even though no label indicates this. Seek the assistance of a workshop to check the applicable speed limit.

The spare wheel always has a steel rim.

Caution

The use of a spare wheel that is smaller than the other wheels or in combination with winter tyres could affect driveability. Have the defective tyre replaced as soon as possible.

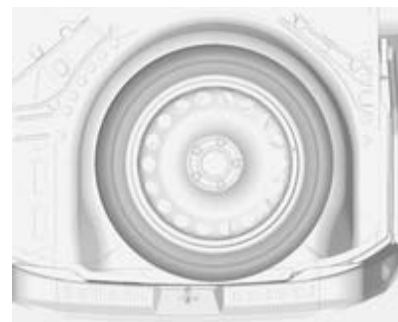

The spare wheel is located in the load compartment beneath the floor covering. It is secured with a wing nut.

Stowing a damaged full size wheel in the load compartment

The spare wheel well is not designed for other tyre sizes than the spare wheel.

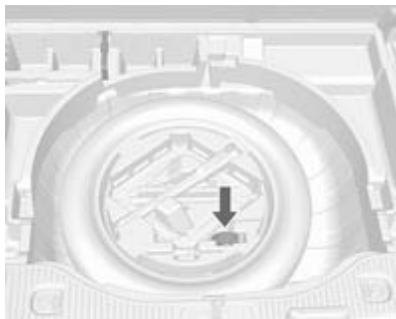

A damaged full size wheel must be stowed in the load compartment and secured with a strap. Vehicle tools ⇨ 173. To secure the wheel:

1. Position the wheel in the middle of the load compartment.
2. Place the loop end of the strap through the lashing eye on one side.

3. Place the hook end of the strap through the loop and pull it until the strap is fastened securely to the lashing eye.



4. Insert the strap through the spokes of the wheel as shown in the illustration.
5. Mount the hook to the opposite lashing eye.
6. Tighten the strap and secure it using the buckle.

⚠ Danger

Always drive with folded up and engaged rear seat backrests when stowing a damaged full size wheel in the load compartment.

Temporary spare wheel

Caution

The use of a spare wheel that is smaller than the other wheels or in combination with winter tyres could affect driveability. Have the defective tyre replaced as soon as possible.

Only mount one temporary spare wheel. Do not drive faster than 50 mph. Take curves slowly. Do not use for a long period of time.

If your vehicle gets a flat tyre on the rear while towing another vehicle, mount the temporary spare wheel in the front and the full size tyre in the rear.

Tyre chains ⇨ 179.

Directional tyres

Fit directional tyres such that they roll in the direction of travel. The rolling direction is indicated by a symbol (e.g. an arrow) on the sidewall.

The following applies to tyres fitted opposing the rolling direction:

- Driveability may be affected. Have the defective tyre renewed or repaired as soon as possible.
- Drive particularly carefully on wet and snow-covered road surfaces.

Jump starting

Do not start with a quick charger.

A vehicle with a discharged battery can be started using jump leads and the battery of another vehicle.

Warning

Be extremely careful when starting with jump leads. Any deviation from the following instructions can lead to injuries or damage caused by battery explosion or damage to the electrical systems of both vehicles.

Warning

Avoid contact of the battery with eyes, skin, fabrics and painted surfaces. The fluid contains sulphuric acid which can cause injuries and damage in the event of direct contact.

- Never expose the battery to naked flames or sparks.

- A discharged battery can already freeze at a temperature of 0 °C. Defrost the frozen battery before connecting jump leads.
- Wear eye protection and protective clothing when handling a battery.
- Use a booster battery with the same voltage (12 Volts). Its capacity (Ah) must not be much less than that of the discharged battery.
- Use jump leads with insulated terminals and a cross section of at least 16 mm² (25 mm² for diesel engines).
- Do not disconnect the discharged battery from the vehicle.
- Switch off all unnecessary electrical consumers.
- Do not lean over the battery during jump starting.
- Do not allow the terminals of one lead to touch those of the other lead.
- The vehicles must not come into contact with each other during the jump starting process.

- Apply the parking brake, transmission in neutral, automatic transmission in **P**.
- Open the positive terminal protection caps of both batteries.



Lead connection order:

1. Connect the red lead to the positive terminal of the booster battery.
2. Connect the other end of the red lead to the positive terminal of the discharged battery.

3. Connect the black lead to the negative terminal of the booster battery.
4. Connect the other end of the black lead to a vehicle grounding point, such as the engine block or an engine mounting bolt. Connect as far away from the discharged battery as possible, however at least 60 cm.

Route the leads so that they cannot catch on rotating parts in the engine compartment.

To start the engine:

1. Start the engine of the vehicle providing the jump.
2. After 5 minutes, start the other engine. Start attempts should be made for no longer than 15 seconds at an interval of 1 minute.
3. Allow both engines to idle for approx. 3 minutes with the leads connected.

4. Switch on electrical consumers (e.g. headlights, heated rear window) of the vehicle receiving the jump start.
5. Reverse above sequence exactly when removing leads.

Towing

Towing the vehicle



Disengage cap by using a screwdriver and remove.

The towing eye is stowed with the vehicle tools ⇨ 173.



Screw in the towing eye as far as it will go until it stops in a horizontal position.

Attach a tow rope – or better still a tow rod – to the towing eye.

The towing eye must only be used for towing and not for recovering the vehicle.

Switch on ignition to release steering wheel lock and to permit operation of brake lights, horn and windscreen wiper.

Transmission in neutral.

Caution

Never tow your vehicle equipped with All Wheel Drive (AWD) with the front or rear tyres on the road. If you tow the vehicle equipped with AWD while the front or rear tyres are rolling on the road the drive system in the vehicle could be severely damaged. When towing vehicles equipped with AWD all 4 tyres may not be in contact with the road.

Caution

Drive slowly. Do not drive jerkily. Excessive tractive force can damage the vehicle.

When the engine is not running, considerably more force is needed to brake and steer.

To prevent the entry of exhaust gases from the towing vehicle, switch on the air recirculation system ⇨ 113 and close the windows.

Vehicles with manual transmission:

The vehicle must be towed facing forwards. The maximum speed is 50 mph. In all other cases, and when the transmission is defective, the front axle must be raised off the ground.

Vehicle with automatic transmission:

Do not tow the vehicle using tow eye. Towing with a tow rope could cause severe automatic transmission damage. When towing vehicle with automatic transmission, use flat bed or wheel lift equipment.

Seek the assistance of a workshop.

After towing, unscrew the towing eye. Insert cap and close cap.

Towing another vehicle



Disengage the cap by using a screwdriver and remove.

The towing eye is stowed with the vehicle tools ⇨ 173.



Screw in the towing eye as far as it will go until it stops in a horizontal position.

The lashing eye at the rear underneath the vehicle must never be used as a towing eye.

Attach a tow rope – or even better a tow bar – to the towing eye.

The towing eye must only be used for towing and not for recovering a vehicle.

Switch on the hazard warning flashers on both vehicles.

Caution

Drive slowly. Do not drive jerkily. Excessive tractive force can damage the vehicle.

After towing, unscrew the towing eye. Insert cap at the bottom and engage cap.

Appearance care**Exterior care****Locks**

The locks are lubricated at the factory using a high quality lock cylinder grease. Use de-icing agent only when absolutely necessary, as this has a degreasing effect and impairs lock function. After using a de-icing agent, have the locks regreased by a workshop.

Washing

The paintwork of your vehicle is exposed to environmental influences. Wash and wax your vehicle regularly. When using automatic vehicle washes, select a programme that includes waxing.

Bird droppings, dead insects, resin, pollen and the like should be cleaned off immediately, as they contain aggressive constituents which can cause paint damage.

If using a vehicle wash, comply with the vehicle wash manufacturer's instructions. The windscreen wiper and rear window wiper must be switched off. Remove antenna and external accessories such as roof racks etc.

If you wash your vehicle by hand, make sure that the insides of the wheel housings are also thoroughly rinsed out.

Clean edges and folds on opened doors and the bonnet as well as the areas they cover.

Caution

Always use a cleaning agent with a pH value of 4 to 9. Do not use cleaning agents on hot surfaces.

Have the door hinges of all doors greased by a workshop.

Do not clean the engine compartment with a steam-jet or high-pressure jet cleaner.

Thoroughly rinse and leather-off the vehicle. Rinse leather frequently. Use separate leathers for painted and glass surfaces: remnants of wax on the windows will impair vision.

Exterior lights

Headlight and other light covers are made of plastic. Do not use any abrasive or caustic agents, do not use an ice scraper, and do not clean them dry.

Polishing and waxing

Wax the vehicle regularly (at the latest when water no longer beads). Otherwise, the paintwork will dry out.

Polishing is necessary only if the paint has become dull or if solid deposits have become attached to it.

Paintwork polish with silicone forms a protective film, making waxing unnecessary.

Plastic body parts must not be treated with wax or polishing agents.

Windows and windscreen wiper blades

Use a soft lint-free cloth or chamois leather together with window cleaner and insect remover.

When cleaning the rear window from inside, always wipe in parallel to the heating element to prevent damage.

For mechanical removal of ice, use a sharp-edged ice scraper. Press the scraper firmly against the glass so that no dirt can get under it and scratch the glass.

Clean smearing wiper blades with a soft cloth and window cleaner.

Wheels and tyres

Do not use high-pressure jet cleaners.

Clean rims with a pH-neutral wheel cleaner.

Rims are painted and can be treated with the same agents as the body.

Paintwork damage

Rectify minor paintwork damage with a touch-up pen before rust forms. Have more extensive damage or rust areas repaired by a workshop.

Underbody

Some areas of the vehicle underbody have a PVC undercoating while other critical areas have a durable protective wax coating.

After the underbody is washed, check the underbody and have it waxed if necessary.

Bitumen/rubber materials could damage the PVC coating. Have underbody work carried out by a workshop.

Before and after winter, wash the underbody and have the protective wax coating checked.

Liquid gas system

Danger

Liquid gas is heavier than air and can collect in sink points.

Take care when performing work at the underbody in a pit.

For painting work and when using a drying booth at a temperature above 60 °C, the liquid gas system must be completely evacuated.

Do not make any modifications to the liquid gas system.

Towing equipment

Do not clean the coupling ball bar with a steam-jet or high-pressure jet cleaner.

Rear carrier system

Clean the rear carrier system with a steam-jet or high-pressure jet cleaner at least once a year.

Operate the rear carrier system periodically if not in regular use, in particular during winter.

Interior care

Interior and upholstery

Only clean the vehicle interior, including the instrument panel fascia and panelling, with a dry cloth or interior cleaner.

Clean the leather upholstery with clear water and a soft cloth. In case of heavy soiling, use leather care.

The instrument cluster and the displays should only be cleaned using a soft damp cloth. If necessary use a weak soap solution.

Clean fabric upholstery with a vacuum cleaner and brush. Remove stains with an upholstery cleaner.

Clothing fabrics may not be colourfast. This could cause visible discolourations, especially on light-coloured upholstery. Removable stains and discolourations should be cleaned as soon as possible.

Clean seat belts with lukewarm water or interior cleaner.

Caution

Close Velcro fasteners as open Velcro fasteners on clothing could damage seat upholstery.

The same applies to clothing with sharp-edged objects, like zips or belts or studded jeans.

Plastic and rubber parts

Plastic and rubber parts can be cleaned with the same cleaner as used to clean the body. Use interior cleaner if necessary. Do not use any other agent. Avoid solvents and petrol in particular. Do not use high-pressure jet cleaners.

Service and maintenance

General information	194
Recommended fluids, lubricants and parts	195

General information

Service information

In order to ensure economical and safe vehicle operation and to maintain the value of your vehicle, it is of vital importance that all maintenance work is carried out at the proper intervals as specified.

The detailed, up-to-date service schedule for your vehicle is available at the workshop.

Service display ⇨ 81.

European service intervals

Maintenance of your vehicle is required every 20,000 miles or after 1 year, whichever occurs first, unless otherwise indicated in the service display.

A shorter service interval can be valid for severe driving behaviour, e.g. for taxis and police cars.

The European service intervals are valid for the following countries:

Andorra, Austria, Belgium, Bosnia-Herzegovina, Bulgaria, Croatia, Cyprus, Czech Republic, Denmark, Estonia, Finland, France, Germany, Greece, Greenland, Hungary, Iceland, Ireland, Italy, Latvia, Lithuania, Luxembourg, Macedonia, Malta, Montenegro, Netherlands, Norway, Poland, Portugal, Romania, Serbia, Slovakia, Slovenia, Spain, Sweden, Switzerland, United Kingdom.

Service display ⇨ 81.

International service intervals

Maintenance of your vehicle is required every 10,000 miles or after 1 year, whichever occurs first, unless otherwise indicated in the service display.

The international service intervals are valid for the countries which are not listed in the European service intervals.

Service display ⇨ 81.

Confirmations

Confirmation of service is recorded in the Service and Warranty Booklet. The date and mileage is completed with the stamp and signature of the servicing workshop.

Make sure that the Service and Warranty Booklet is completed correctly as continuous proof of service is essential if any warranty or goodwill claims are to be met, and is also a benefit when selling the vehicle.

Service interval with remaining engine oil life duration

The service interval is based on several parameters depending on usage.

The service display lets you know when to change the engine oil.

Service display ⇨ 81.

Recommended fluids, lubricants and parts

Recommended fluids and lubricants

Only use products that meet the recommended specifications. Damage resulting from the use of products not in line with these specifications will not be covered by the warranty.

Warning

Operating materials are hazardous and could be poisonous. Handle with care. Pay attention to information given on the containers.

Engine oil

Engine oil is identified by its quality and its viscosity. Quality is more important than viscosity when selecting which engine oil to use. The oil quality ensures e.g. engine cleanliness, wear protection and oil

aging control, whereas viscosity grade gives information on the oil's thickness over a temperature range.

Dexos is the newest engine oil quality that provides optimum protection for gasoline and diesel engines. If it is unavailable, engine oils of other listed qualities have to be used.

Recommendations for gasoline engines are also valid for Compressed Natural Gas (CNG), Liquefied Petroleum Gas (LPG) and Ethanol (E85) fuelled engines.

Select the appropriate engine oil based on its quality and on the minimum ambient temperature ⇨ 199.

Topping up engine oil

Engine oils of different manufacturers and brands can be mixed as long as they comply with the required engine oil quality and viscosity.

Use of engine oil with only ACEA A1/B1 or only A5/B5 quality is prohibited, since it can cause long-term engine damage under certain operating conditions.

Select the appropriate engine oil based on its quality and on the minimum ambient temperature ↻ 199.

Additional engine oil additives

The use of additional engine oil additives could cause damage and invalidate the warranty.

Engine oil viscosity grades

The SAE viscosity grade gives information of the thickness of the oil.

Multigrade oil is indicated by two figures, e.g. SAE 5W-30. The first figure, followed by a W, indicates the low temperature viscosity and the second figure the high temperature viscosity.

Select the appropriate viscosity grade depending on the minimum ambient temperature ↻ 199.

All of the recommended viscosity grades are suitable for high ambient temperatures.

Coolant and antifreeze

Use only organic acid type-long life coolant (LLC) antifreeze approved for the vehicle. Consult a workshop.

The system is factory filled with coolant designed for excellent corrosion protection and frost protection down to approx. -28 °C. In northern countries with very low temperatures the factory filled coolant provides frost protection down to approx. -37 °C. This concentration should be maintained all year round. The use of additional coolant additives that intend to give additional corrosion protection or seal against minor leaks can cause function problems. Liability for consequences resulting from the use of additional coolant additives will be rejected.

Brake and clutch fluid

Over time, brake fluid absorbs moisture which will reduce braking effectiveness. The brake fluid should therefore be replaced at the specified interval.

Technical data

Vehicle identification 197
 Vehicle data 199

Vehicle identification

Vehicle Identification Number

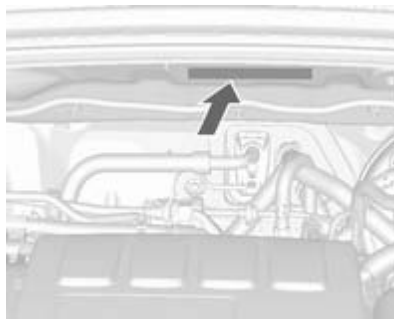

The Vehicle Identification Number is located in the engine compartment.

Identification plate



The identification plate is located on the front left door frame.

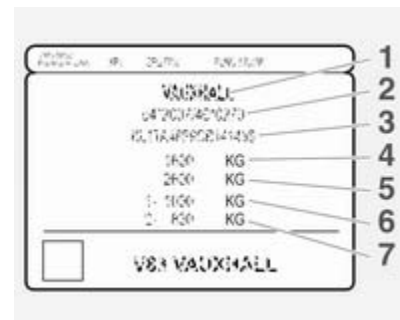

Information on identification label:

- 1 = Manufacturer
- 2 = Type approval number
- 3 = Vehicle Identification Number
- 4 = Permissible gross vehicle weight rating in kg
- 5 = Permissible gross train weight in kg
- 6 = Maximum permissible front axle load in kg
- 7 = Maximum permissible rear axle load in kg

Engine identification

The technical data tables show the engine identifier code. Engine data
↪ 202.

To identify the respective engine, refer to the engine power in the EEC Certificate of Conformity provided with your vehicle or other national registration documents.

Vehicle data

Recommended fluids and lubricants

European service schedule

Required engine oil quality

Engine oil quality	All European countries (except Belarus, Moldova, Russia, Turkey)		Only Israel	
	Petrol engines (including CNG, LPG, E85)	Diesel engines	Petrol engines (including CNG, LPG, E85)	Diesel engines
dexos 1	–	–	✓	–
dexos 2	✓	✓	–	✓

In case dexos quality is unavailable you may use max. 1 litre engine oil quality ACEA C3 for topping up once between each oil change.

Engine oil viscosity grades

All European countries and Israel (except Belarus, Moldova, Russia, Turkey)	
Ambient temperature	Petrol and diesel engines
down to -25 °C	SAE 5W-30 or SAE 5W-40
below -25 °C	SAE 0W-30 or SAE 0W-40

International service schedule

Required engine oil quality

Engine oil quality	All countries outside Europe except Israel		Only Belarus, Moldova, Russia, Turkey	
	Petrol engines (including CNG, LPG, E85)	Diesel engines	Petrol engines (including CNG, LPG, E85)	Diesel engines
dexos 1	✓	–	–	–
dexos 2	–	✓	✓	✓

In case dexos quality is unavailable you may use the oil qualities listed below:

Engine oil quality	All countries outside Europe except Israel		Only Belarus, Moldova, Russia, Turkey	
	Petrol engines (including CNG, LPG, E85)	Diesel engines	Petrol engines (including CNG, LPG, E85)	Diesel engines
GM-LL-A-025	✓	–	✓	–
GM-LL-B-025	–	✓	–	✓

Engine oil quality	All countries outside Europe except Israel		Only Belarus, Moldova, Russia, Turkey	
	Petrol engines (including CNG, LPG, E85)	Diesel engines	Petrol engines (including CNG, LPG, E85)	Diesel engines
ACEA A3/B3	✓	–	✓	–
ACEA A3/B4	✓	✓	✓	✓
ACEA C3	✓	✓	✓	✓
API SM	✓	–	✓	–
API SN resource conserving	✓	–	✓	–

Engine oil viscosity grades

**All countries outside Europe (except Israel),
including Belarus, Moldova, Russia, Turkey**

Ambient temperature	Petrol and diesel engines
down to -25 °C	SAE 5W-30 or SAE 5W-40
below -25 °C	SAE 0W-30 or SAE 0W-40
down to -20 °C	SAE 10W-30 ¹⁾ or SAE 10W-40 ¹⁾

1) Permitted, but usage of SAE 5W-30 or SAE 5W-40 with dexos quality is recommended.

Engine data

Sales designation	1.4	1.4 LPG	1.6	1.7
Engine identifier code	A14NET	B14NET	A16XER	A17DTS
Number of cylinders	4	4	4	4
Piston displacement [cm ³]	1364	1364	1598	1686
Engine power [kW]	103	103	85	96
at rpm	4900-6000	4900-6000	6200	4000
Torque [Nm]	200	200	155	300
at rpm	1850-4900	1850-4900	4000	2000-2500
Fuel type	Petrol	Liquid Gas/Petrol	Petrol	Diesel
Octane rating RON				
recommended	95	95	95	
possible	98	98	98	
Gas	–	LPG	–	–
Engine oil consumption [l/1000 km] ²⁾	0.6	0.6	0.6	0.6

2) Maximum value.

Performance

Engine	A14NET	B14NET LPG	A16XER	A17DTS
Maximum speed ³⁾ [mph]				
Manual transmission	120	120	106	118/115 ⁴⁾
Automatic transmission	116	–	–	114

3) The maximum speed indicated is achievable at kerb weight (without driver) plus 200 kg payload. Optional equipment could reduce the specified maximum speed of the vehicle.

4) Vehicles with All-wheel drive system.

Vehicle weight

Kerb weight, basic model without any optional equipment

	Engine	Manual transmission	Automatic transmission
[kg]	A14NET	1394	1409
	B14NET LPG	1464	–
	A16XER	1355	–
	A17DTS	1449	1462
	A17DTS ⁵⁾	1504	–

⁵⁾ Vehicles with All-wheel drive system.

Optional equipment and accessories increase the kerb weight.

Loading information ⇨ 70.

Vehicle dimensions

Length [mm]	4278
Width without exterior mirrors [mm]	1764
Width with two exterior mirrors [mm]	2038
Height (without antenna) [mm]	1658

Length of load compartment floor [mm]	729
Length of load compartment with folded rear seats [mm]	1428
Load compartment width [mm]	915
Load compartment height [mm]	757
Wheelbase [mm]	2555
Turning circle diameter [m]	11.5

Capacities

Engine oil

Engine	A14NET	B14NET LPG	A16XER	A17DTS
including Filter [l]	4.5	4.5	5.1	5.4
between MIN and MAX [l]	1.0	1.0	1.0	1.0

Fuel tank

Engine	A14NET	B14NET LPG	A16XER	A17DTS
Petrol/diesel, refilling quantity [l]	52	52	52	52
LPG, refilling quantity [l]	–	34	–	–

Tyre pressures

Engine	Tyres	Comfort with up to 3 people		ECO with up to 3 people		With full load	
		front	rear	front	rear	front	rear
		[kPa/bar] ([psi])	[kPa/bar] ([psi])	[kPa/bar] ([psi])	[kPa/bar] ([psi])	[kPa/bar] ([psi])	[kPa/bar] ([psi])
A14NET, B14NET LPG, A16XER, A17DTS	195/70 R16, 205/70 R16	200/2.0 (29)	200/2.0 (29)	270/2.7 (39)	280/2.8 (41)	270/2.7 (39)	280/2.8 (41)
	215/60 R17, 215/65 R16, 215/55 R18	220/2.2 (32)	220/2.2 (32)	270/2.7 (39)	280/2.8 (41)	270/2.7 (39)	280/2.8 (41)
	225/45 R19	240/2.4 (35)	240/2.4 (35)	270/2.7 (39)	280/2.8 (41)	270/2.7 (39)	280/2.8 (41)
All	Temporary spare wheel	420/4.2 (61)	420/4.2 (61)	–	–	420/4.2 (61)	420/4.2 (61)

Towing hitch installation dimensions

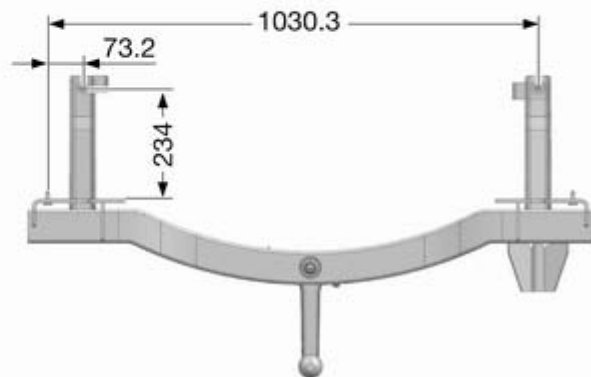
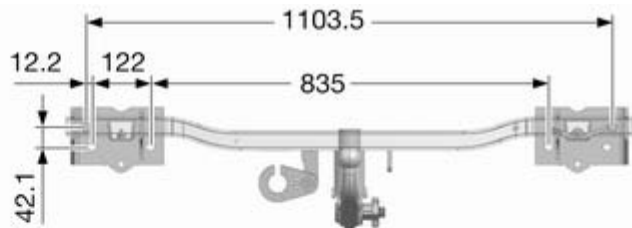
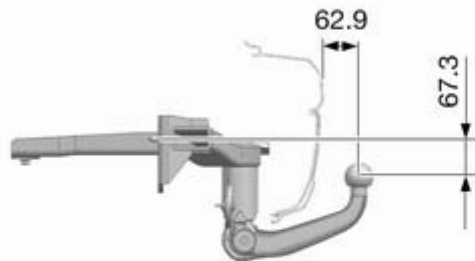

Customer information

Customer information	209
Vehicle data recording and privacy	209

Customer information

Declaration of conformity

This vehicle has systems that transmit and/or receive radio waves subject to Directive 1999/5/EC. These systems are in compliance with the essential requirements and other relevant provisions of Directive 1999/5/EC. Copies of the original Declarations of Conformity can be obtained on our website.

Vehicle data recording and privacy

Event data recorders

Data storage modules in the vehicle

A large number of electronic components of your vehicle contain data storage modules temporarily or permanently storing technical data about the condition of the vehicle, events and errors. In general, this technical information documents the condition of parts, modules, systems or the environment:

- Operating conditions of system components (e.g. filling levels)
- Status messages of the vehicle and its single components (e.g. number of wheel revolutions / rotational speed, deceleration, lateral acceleration)
- Dysfunctions and defects in important system components

- Vehicle reactions in particular driving situations (e.g. inflation of an airbag, activation of the stability regulation system)
- Environmental conditions (e.g. temperature)

These data are exclusively technical and help identifying and correcting errors as well as optimizing vehicle functions.

Motion profiles indicating travelled routes cannot be created with these data.

If services are used (e.g. repair works, service processes, warranty cases, quality assurance), employees of the service network (manufacturer included) are able to read out this technical information from the event and error data storage modules applying special diagnostic devices. If required, you will receive further information at these workshops. After an error has been corrected, the data are deleted from the error storage module or they are constantly overwritten.

When using the vehicle, situations may occur in which these technical data related to other information (accident report, damages on the vehicle, witness statements etc.) may be associated with a specific person - possibly, with the assistance of an expert.

Additional functions contractually agreed upon with the client (e.g. vehicle location in emergency cases) allow the transmission of particular vehicle data from the vehicle.

Radio Frequency Identification (RFID)

RFID technology is used in some vehicles for functions such as tyre pressure monitoring and ignition system security. It is also used in connection with conveniences such as radio remote controls for door locking/unlocking and starting, and in-vehicle transmitters for garage door openers. RFID technology in Vauxhall vehicles does not use or record personal information or link with any other Vauxhall system containing personal information.

Index

- A**
- Accessories and vehicle modifications 154
 - Adaptive forward lighting 88, 106
 - Adjustable air vents 116
 - Airbag and belt tensioners 84
 - Airbag deactivation 46, 84
 - Airbag label..... 41
 - Airbag system 41
 - Air conditioning regular operation 117
 - Air conditioning system 113
 - Air intake 117
 - Air vents..... 116
 - All-wheel drive 128
 - Antilock brake system 129
 - Antilock brake system (ABS) 86
 - Anti-theft alarm system 25
 - Anti-theft locking system 25
 - Appearance care..... 191
 - Automatic anti-dazzle 28
 - Automatic light control 103
 - Automatic locking 23
 - Automatic transmission 125
 - Auxiliary heater..... 116
- B**
- Battery discharge protection 111
 - Battery voltage 96
- C**
- Bicycle rack..... 57
 - Bonnet 156
 - Bonnet open..... 89
 - Brake and clutch fluid..... 195
 - Brake and clutch system 85
 - Brake assist 130
 - Brake fluid 159
 - Brakes 129, 159
 - Breakdown..... 189
 - Bulb replacement 162
- C**
- Capacities 206
 - Catalytic converter 124
 - Central locking system 21
 - Centre console storage 56
 - Centre high-mounted brake light 167
 - Changing tyre and wheel size ... 179
 - Charging system 85
 - Child locks 23
 - Child restraint installation locations 49
 - Child restraints..... 47
 - Child restraint systems 47
 - Climate control 15
 - Climate control systems..... 112
 - Clock 76
 - Code..... 94
 - Control indicators..... 81
 - Control of the vehicle 118

Controls.....	72
Convex shape	27
Coolant and antifreeze.....	195
Cruise control	89, 133
Cupholders	55
Curtain airbag system	45

D

Danger, Warnings and Cautions ...	4
Daytime running lights	105
Declaration of conformity.....	209
Delayed locking.....	23
Descent control system	86, 132
Diesel fuel system bleeding	161
Diesel particle filter.....	87, 123
Door open	89
Doors.....	24
Driver assistance systems.....	133
Driver Information Centre.....	89
Driving characteristics and towing tips	152
Driving hints.....	118

E

Electric adjustment	27
Electrical system.....	168
Electronic climate control system	114
Electronic driving programmes ..	126
Electronic Stability Control.....	131

Electronic Stability Control and Traction Control system.....	87
Electronic Stability Control off.....	87
End-of-life vehicle recovery	155
Engine compartment fuse box ...	169
Engine coolant	157
Engine coolant temperature gauge	80

Engine data	202
Engine exhaust	123
Engine identification.....	198
Engine oil	156, 195, 199
Engine oil pressure	88
Entry lighting	111
Event data recorders.....	209
Exit lighting	111
Exterior care	191
Exterior light	88
Exterior lighting	12, 103
Exterior mirrors.....	27

F

Fault	127
First aid kit	69
Fixed air vents	117
Flex-Fix system.....	57
Fog light	89
Fog lights	165
Folding mirrors	27
Forward collision alert.....	136

Front airbag system	44
Front fog lights	108
Front seats.....	34
Front turn signal lights	165
Fuel.....	145
Fuel consumption - CO ₂ - Emissions	151
Fuel for diesel engines	146
Fuel for liquid gas operation.....	146
Fuel for petrol engines	145
Fuel gauge	80
Fuel selector	80
Fuses	168

G

Gauges.....	79
General information	152
Glovebox	55
Glove box lighting.....	110
Graphic-Info-Display, Colour- Info-Display	92

H

Halogen headlights	162
Hand brake.....	129, 130
Hazard warning flashers	108
Headlight flash	104
Headlight range adjustment	104
Headlights when driving abroad	104
Head restraint adjustment	8

Head restraints	33
Heated mirrors	28
Heated rear window	30
Heated steering wheel	73
Heating	37
Heating and ventilation system .	112
High beam	88, 104
Hill start assist	130
Horn	13, 73
I	
Identification plate	197
Ignition switch positions	119
Immobiliser	26, 88
Indicators.....	79
Information displays.....	89
Initial drive information.....	6
Instrument panel fuse box	170
Instrument panel illumination control	109
Instrument panel overview	10
Instrument panel storage.....	54
Interior care	193
Interior lighting.....	109
Interior lights	110, 168
Interior mirrors.....	28
Interruption of power supply	127
Introduction	3
ISOFIX child restraint systems	52

J	
Jump starting	187
K	
Key, memorised settings.....	21
Keys	19
Keys, locks.....	19
L	
Lane departure warning.....	86, 144
Lashing eyes	69
Lighting features.....	111
Light switch	103
Load compartment	24, 66
Load compartment cover	68
Load compartment fuse box	172
Loading information	70
Low fuel	88
M	
Malfunction indicator light	85
Manual anti-dazzle	28
Manual mode	126
Manual transmission	128
Manual windows	29
Memorised settings.....	21
Mirror adjustment	8
Misted light covers	109

N	
New vehicle running-in	119
Number plate light	167
O	
Object detection systems.....	138
Odometer	79
Oil, engine.....	195, 199
Operate pedal.....	85
Outside temperature	76
Overrun cut-off	120
P	
Parking	17, 122
Parking assist	138
Parking brake	130
Particulate filter.....	123
Performance	203
Performing work	155
Pollen filter	117
Power outlets	78
Power steering.....	86
Power steering fluid.....	158
Power windows	29
Preheating	87
Puncture.....	183

R

Radio Frequency Identification (RFID).....	210
Radio remote control	20
Reading lights	110
Rear carrier system.....	57
Rear floor storage cover	68
Rear fog light	89, 109
Rear view camera	139
Rear window wiper/washer	75
Recommended fluids and lubricants	195, 199
Refuelling	148
Reversing lights	109
Ride control systems.....	131
Roof.....	31
Roof load.....	70
Roof rack	70

S

Seat adjustment	6, 35
Seat belt	8
Seat belt reminder	84
Seat belts	38
Seat position	34
Selector lever	125
Service	117
Service display	81
Service information	194

Service vehicle soon	85
Side airbag system	45
Side turn signal lights	167
Spare wheel	185
Speed limiter.....	134
Speedometer	79
Starting and operating.....	119
Starting off	16
Starting the engine	119
Steering.....	118
Steering wheel adjustment	9, 72
Steering wheel controls	72
Stop-start system.....	120
Storage compartments.....	54
Sunglasses storage	56
Sunroof	31
Sunvisor lights	110
Sun visors	31
Symbols	4

T

Tachometer	79
Tail lights	165
Three-point seat belt	39
Tools	173
Top-tether fastening eyes	53
Tow bar.....	152
Towing.....	152, 189
Towing another vehicle	190

Towing hitch installation dimensions	208
Towing the vehicle	189
Traction Control system	131
Traction Control system off.....	87
Traffic sign assistant.....	141
Trailer towing	152
Transmission	16
Transmission display	125
Tread depth	178
Trip computer	96
Trip odometer	79
Turn and lane-change signals ..	108
Turn signal	84
Tyre chains	179
Tyre designations	174
Tyre pressure	175
Tyre pressure monitoring system.....	87, 175
Tyre pressures	207
Tyre repair kit	180
Tyres	174

U

Ultrasonic parking assist	86, 138
Underseat storage	56
Upholstery.....	193
Upshift.....	86
Using this manual	3

V

Vehicle battery	159
Vehicle checks.....	155
Vehicle data.....	199
Vehicle data recording and privacy.....	209
Vehicle detected ahead.....	89
Vehicle dimensions	204
Vehicle Identification Number	197
Vehicle jack.....	173
Vehicle messages	94
Vehicle personalisation	99
Vehicle security.....	25
Vehicle specific data	3
Vehicle storage.....	154
Vehicle tools.....	173
Vehicle unlocking	6
Vehicle weight	204
Ventilation.....	112

W

Warning chimes	96
Warning lights.....	79
Warning triangle	69
Washer and wiper systems	14
Washer fluid	159
Wheel changing	183
Wheel covers	179
Wheels and tyres	174

Windows.....	29
Windscreen.....	29
Windscreen wiper/washer	73
Winter tyres	174
Wiper blade replacement	161

X

Xenon headlights	164
------------------------	-----