

VAUXHALL Astra GTC

**Infotainment Manual
Model Year 2012
Edition: October 2011
TS 1709-B-12**

Contents

Introduction	2
Radio	24
CD Player	40
AUX input	46
USB port	48
Digital picture frame	52
Navigation	55
Speech recognition	100
Phone	115
Index	136

Introduction

General information	2
Theft-deterrent feature	3
Control elements overview	4
Usage	11
Basic operation	13
Tone settings	18
Volume settings	21
Personalisation	23

General information

The Infotainment system provides you with state-of-the-art in-car infotainment.

For the AM, FM and DAB (not CD 300) wavebands the radio is equipped with twelve automatically assignable channel presets.

Furthermore, 36 channels can be allocated manually (waveband-independent).

The integrated audio player will entertain you with audio CDs and MP3/WMA CDs.

Furthermore, you can connect external data storage devices, e.g. iPod, MP3 player or USB stick (not CD 300), or a portable CD player to the Infotainment system as further audio sources.

The digital sound processor provides you with several preset equalizer modes for sound optimisation.

The navigation system (only Navi 600 / Navi 900) with dynamic route planning will reliably guide you

to your destination, and, if desired, will automatically avoid traffic jams or other traffic problems.

Optionally, the Infotainment system can be operated using controls on the steering wheel or via the speech recognition system (if available).

In addition the Infotainment system can be equipped with a mobile phone portal.

The well-thought-out design of the control elements, the clear displays and a large multifunction knob enable you to control the system easily and intuitively.

Important information on operation and traffic safety

Warning

The Infotainment system has to be used so that the vehicle can be driven safely at all times. In doubt stop your vehicle and operate the Infotainment system while the vehicle is stationary.

Warning

The usage of the navigation system (only Navi 600 / Navi 900) does not release the driver from the responsibility for a correct, vigilant attitude in road traffic. The related traffic regulations must always be followed.

Only make entries (e.g. addresses) with the vehicle stationary.

If a navigation instruction contradicts traffic regulations, the traffic regulations always apply.

Warning

In some areas one-way streets and other roads and entrances (e.g. pedestrian zones) that you are not allowed to turn into are not marked on the map. In such areas the Infotainment system may issue a warning that must be accepted. Here you must pay particular attention to one-way streets, roads and entrances that you are not allowed to drive into.

Radio reception

Radio reception may be disrupted by static, noise, distortion or loss of reception due to

- changes in distance from the transmitter,
- multi-path reception due to reflection,
- shadowing.

Theft-deterrent feature

The Infotainment system is equipped with an electronic security system for the purpose of theft deterrent.

The Infotainment system therefore functions only in your vehicle and is worthless to a thief.

Control elements overview

Instrument panel Navi 600 / Navi 900

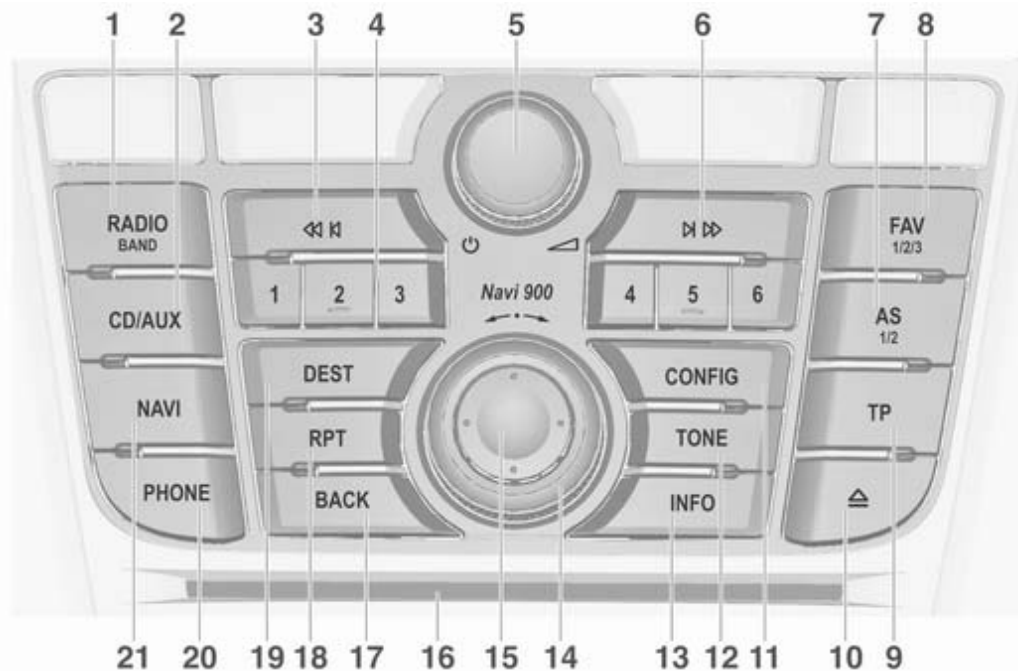

-
- | | | |
|---|---|--|
| 1 RADIO (BAND) 24 | 7 AS (1/2) 25 | 13 INFO 4 |
| Activate radio or change
waveband 24 | Automatic memory levels
(preset radio stations) 25 | Radio: information on the
currently played station 24 |
| 2 CD/AUX 46 | Short press: select
autostore list 25 | CD/MP3/WMA:
information on the
currently inserted CD 42 |
| Start CD/MP3/WMA
replay or change audio
source 46 | 8 FAV (1/2/3) 26 | Digital picture frame:
shows currently selected
picture/photo 52 |
| 3 Search backwards 24 | Lists of favourites (preset
radio stations) 26 | Navigation: information,
e.g., on the current location .. 55 |
| Radio: search backwards 24 | 9 TP 33 | 14 Multifunction knob 13 |
| CD/MP3/WMA: skip track
backwards 42 | Activate or deactivate
radio traffic service 33 | Turn: mark menu options
or set numeric values 13 |
| 4 Radio station buttons 1...6 25 | 10 CD ejection 42 | Press (the outer ring):
select/activate the marked
option; confirm set value;
switch function on/off 13 |
| Long press: save station 25 | 11 CONFIG 21 | 15 Eight-way switch 56 |
| Short press: select station ... 25 | System settings 21 | Navigation: move display
window in map view 56 |
| 5 \odot knob 11 | 12 TONE 18 | 16 CD slot 42 |
| Press: switch on/off | Tone settings 18 | 17 BACK 13 |
| Infotainment system 11 | | Menu: one level back 13 |
| Turn: adjust volume 11 | | Input: delete last character
or entire entry 13 |
| 6 Search forwards 24 | | |
| Radio: search forwards 24 | | |
| CD/MP3/WMA: skip track
forwards 42 | | |

18	RPT	93
	Repeat last navigation message	93
19	DEST	56
	Navigation destination entry	56
20	PHONE	115
	Open telephone menu	128
	Activate/deactivate mute	11
21	NAVI	56
	Display map	56

Instrument panel CD 400

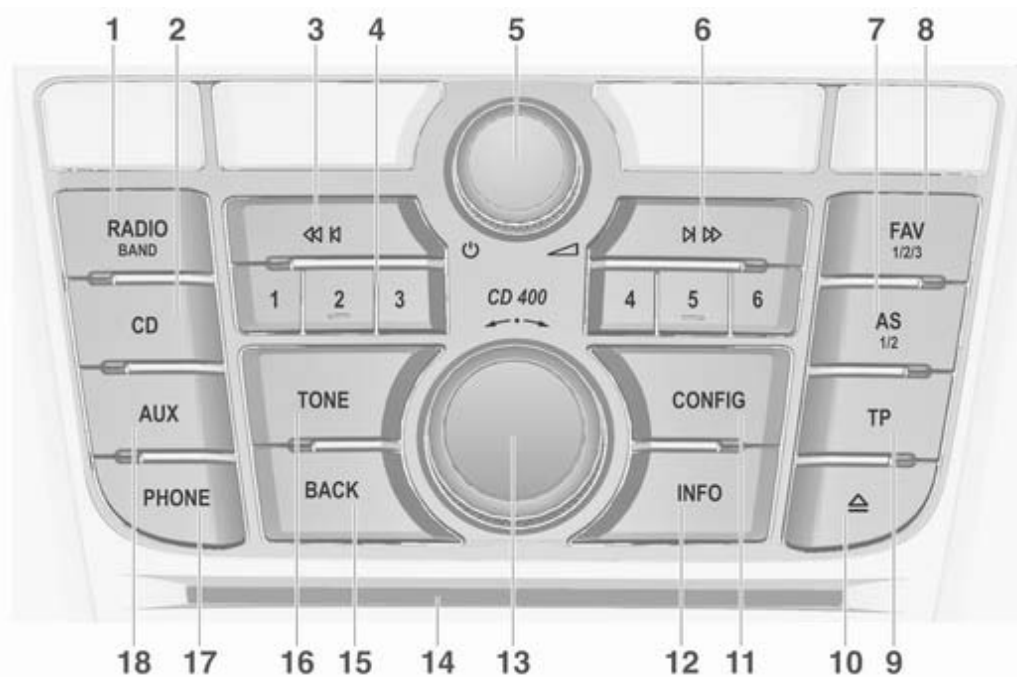

8 Introduction

- | | | |
|---|--|---|
| 1 RADIO (BAND) 24
Activate radio or change waveband 24 | 8 FAV (1/2/3) 26
Lists of favourites (preset radio stations) 26 | 15 BACK 13
Menu: one level back 13
Input: delete last character or entire entry 13 |
| 2 CD 46
Start CD/MP3/WMA replay ... 46 | 9 TP 33
Activate or deactivate radio traffic service 33
If Infotainment system switched off: display time and date 33 | 16 TONE 18
Tone settings 18 |
| 3 Search backwards 24
Radio: search backwards 24
CD/MP3/WMA: skip track backwards 42 | 10 CD ejection 42 | 17 PHONE 115
Open telephone main menu 128
Activate mute 11 |
| 4 Radio station buttons 1...6 ... 25
Long press: save station 25
Short press: select station ... 25 | 11 CONFIG 21
Open settings menu 21 | 18 AUX 46
Change audio source 46 |
| 5 \odot knob 11
Press: switch on/off 11
Infotainment system 11
Turn: adjust volume 11 | 12 INFO 4
Radio: information on the currently played station 24
CD/MP3/WMA: information on the currently inserted CD 42 | |
| 6 Search forwards 24
Radio: search forwards 24
CD/MP3/WMA: skip track forwards 42 | 13 Multifunction knob 13
Turn: mark menu options or set numeric values 13
Press: select/activate the marked option; confirm set value; switch function on/off .. 13 | |
| 7 AS (1/2) 25
Automatic memory levels (preset radio stations) 25
Short press: select autostore list 25
Long press: save stations automatically 25 | 14 CD slot 42 | |

Instrument panel CD 300

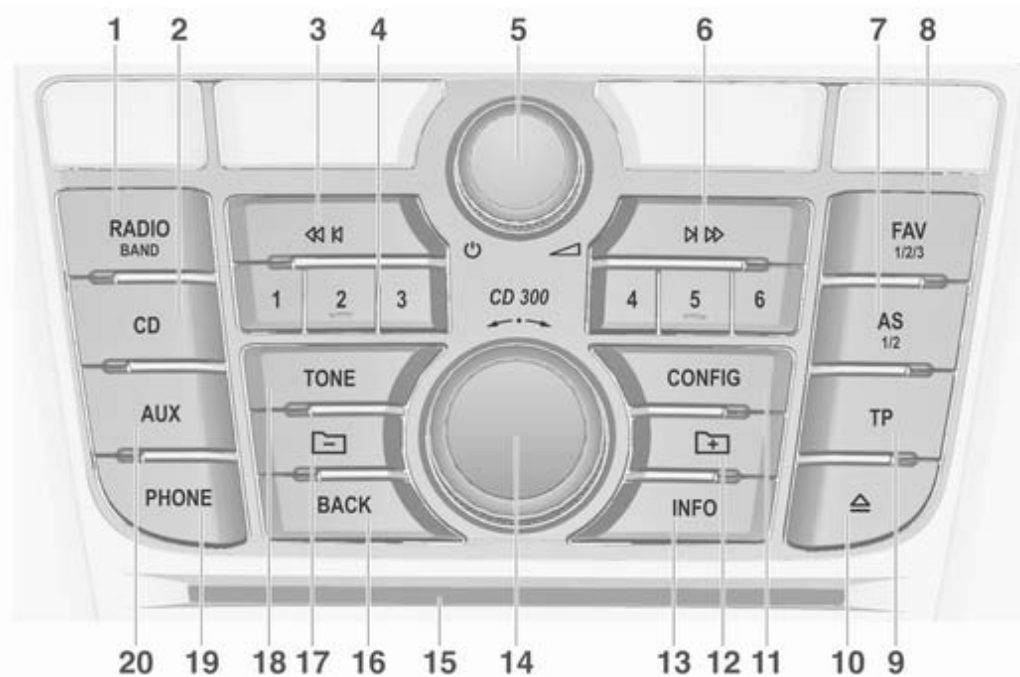

- | | | |
|--|--|---|
| <p>1 RADIO (BAND) 24
 Activate radio or change waveband 24</p> <p>2 CD 46
 Start CD/MP3/WMA replay ... 46</p> <p>3 Search backwards 24
 Radio: search backwards 24
 CD/MP3/WMA: skip track backwards 42</p> <p>4 Radio station buttons 1...6 ... 25
 Long press: save station 25
 Short press: select station ... 25</p> <p>5 \odot knob 11
 Press: switch on/off the Infotainment system 11
 Turn: adjust volume 11</p> <p>6 Search forwards 24
 Radio: search forwards 24
 CD/MP3/WMA: skip track forwards 42</p> <p>7 AS (1/2) 25
 Automatic memory levels (preset radio stations) 25
 Short press: select autostore list 25
 Long press: save stations automatically 25</p> | <p>8 FAV (1/2/3) 26
 Lists of favourites (preset radio stations) 26</p> <p>9 TP 33
 Activate or deactivate radio traffic service 33
 If Infotainment system switched off: display time and date 33</p> <p>10 CD ejection 42</p> <p>11 CONFIG 21
 Open settings menu 21</p> <p>12 MP3: folder level lower 42</p> <p>13 INFO 4
 Radio: information on the currently played station 24
 CD/MP3/WMA: information on the currently inserted CD 42</p> <p>14 Multifunction knob 13
 Turn: mark menu options or set numeric values 13
 Press: select/activate the marked option; confirm set value; switch function on/off .. 13</p> <p>15 CD slot 42</p> | <p>16 BACK 13
 Menu: one level back 13
 Input: delete last character or entire entry 13</p> <p>17 MP3: folder level higher 42</p> <p>18 TONE 18
 Tone settings 18</p> <p>19 PHONE 115
 Open telephone main menu 128
 Activate mute 11</p> <p>20 AUX 46
 Change audio source 46</p> |
|--|--|---|

Steering wheel audio controls

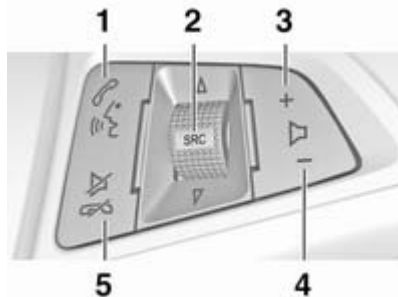

- 1 Short press: take phone call 115
or dial number in call list 128
or activate speech
recognition (if available) 100
Long press: show call list 128
or deactivate speech
recognition (if available) 100

- 2 SRC (Source) 11
Press: select audio source 11
If radio active: turn
upwards/downwards to
select next/previous
preset radio station 24
If CD player active: turn
upwards/downwards to
select next/previous CD/
MP3/WMA track 42
If Phone portal active: turn
upwards/downwards to
select next/previous entry
in call list 128
If Phone portal active and
calls waiting: turn
upwards/downwards to
switch between calls 128
- 3 Increase volume 11
- 4 Reduce volume 11
- 5 Short press: end/decline
call 128
or close call list 128
or activate/deactivate mute ... 11
or deactivate speech
recognition (if available) 100

Usage

Control elements

The Infotainment system is operated via function buttons, multifunctional knobs and menus that are shown on the display.

Inputs are made optionally via:

- the central control unit in the instrument panel ⇨ 4
- controls on the steering wheel ⇨ 4
- the speech recognition system (if available) ⇨ 100

Switching the Infotainment system on or off

Press the \odot knob briefly. After switching on the last selected Infotainment source is active.

Automatic switch-off

If the Infotainment system has been switched on using the \odot knob when the ignition was switched off, it will switch off again automatically after 30 minutes.

Setting the volume

Turn the \odot knob. The current setting is shown on the display.

When the Infotainment system is switched on, the last selected volume is set, if that volume is lower than the maximum start up volume.

The following can be set separately:

- the maximum start up volume \rightarrow 21
- the volume of the traffic announcements \rightarrow 21
- the volume of the navigation messages (only Navi 600 / Navi 900) \rightarrow 56

Speed compensated volume

When speed compensated volume is activated \rightarrow 21 the volume is adapted automatically to make up for the road and wind noise as you drive.

Mute

Press the **PHONE** button (if Phone portal available: press for a few seconds) to mute the audio sources.

To cancel mute again: turn the \odot knob or press the **PHONE** button again (if Phone portal available: press for a few seconds).

Volume limitation at high temperatures

(only CD 300 / CD 400)

At very high temperatures inside the vehicle the Infotainment system limits the maximum adjustable volume. If necessary the volume is decreased automatically.

Modes of operation

Radio

Press the **RADIO** button to open the radio main menu or to change between the different wavebands.

Press the multifunction knob to open a submenu with options for station selection.

Detailed description of the radio functions \rightarrow 24.

Audio players

Press the **CD / AUX / CD/AUX** button to open the CD, USB, iPod or AUX menus (if available) or to swap between these menus.

Press the multifunction knob to open a submenu with options for track selection.

Detailed description of:

- CD player functions \rightarrow 42
- AUX input functions \rightarrow 46
- USB port functions \rightarrow 48

Navigation

(only Navi 600 / Navi 900)

Press the **NAVI** button and then the multifunction knob to open the Navigation menu.

Detailed description of the navigation system functions \rightarrow 56.

Phone

(if Phone portal available)

Press the **PHONE** button to open the telephone menu.

Press the multifunction knob to open a submenu with options for the input or selection of numbers.

Detailed description of the mobile phone portal functions ⇨ 115.

Basic operation

Multifunction knob

The multifunction knob is the central control element for the menus.

Turn the multifunction knob:

- to mark a menu option
- CD 300: to display a menu option
- to set a numeric value

Press the multifunction knob (Navi 600 / Navi 900: press the outer ring):

- to select or activate the marked option
- CD 300: to select or activate the option displayed
- to confirm a set value
- to switch a system function on/off

BACK button

Press the **BACK** button briefly to:

- exit a menu
- return from a submenu to the next higher menu level
- delete the last character in a character sequence

Press and hold the **BACK** button for a few seconds to delete the entire entry.

Examples of menu operation

Navi 600 / Navi 900

Selecting an option

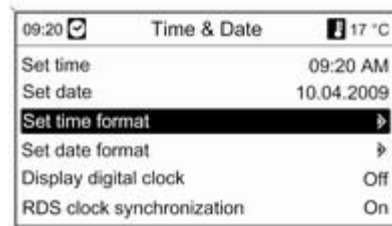

Turn the multifunction knob to move the cursor (= coloured background) to the desired option.

Press the multifunction knob to select the marked option.

Submenus

An arrow on the right-hand edge of the menu indicates that after selection of the option a submenu with further options will be opened.

Activating a setting

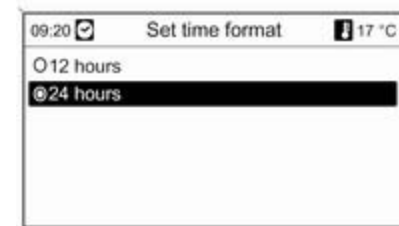

Turn the multifunction knob to mark the desired setting.

Press the multifunction knob to activate the setting.

Setting a value



Turn the multifunction knob to change the current value of the setting.
Press the multifunction knob to confirm the set value.

Switching a function on or off

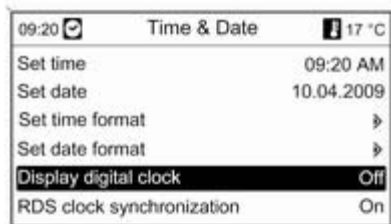

Turn the multifunction knob to mark the function to be switched on or off.
Press the multifunction knob to switch between the settings **On** and **Off**.

Entering a character sequence

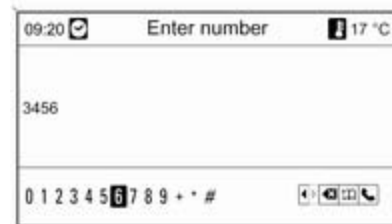

To enter character sequences, e.g. telephone numbers or road names:
Turn the multifunction knob to select the desired character.
The last character in the character sequence can be deleted using the **BACK** button. Pressing and holding the **BACK** button deletes the entire entry.
Press the multifunction knob to confirm the selected character.

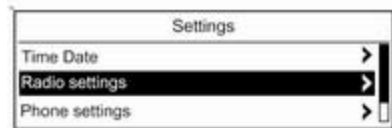
CD 400**Selecting an option**

Turn the multifunction knob to move the cursor (= coloured background) to the desired option.

Press the multifunction knob to select the marked option.

Submenus

An arrow on the right-hand edge of the menu indicates that after selection of the option a submenu with further options will be opened.

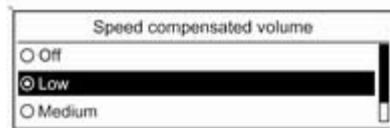
Activating a setting

Turn the multifunction knob to mark the desired setting.

Press the multifunction knob to activate the setting.

Setting a value

Turn the multifunction knob to change the current value of the setting.

Press the multifunction knob to confirm the set value.

Switching a function on or off

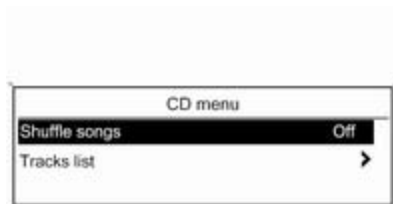

Turn the multifunction knob to mark the function to be switched on or off. Press the multifunction knob to switch between the settings **On** and **Off**.

Entering a character sequence

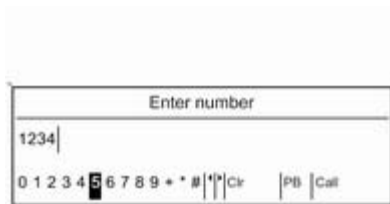

For the input of character sequences, e.g. telephone numbers:

Turn the multifunction knob to select the desired character.

Press the multifunction knob to confirm the selected character.

Using the **BACK** button the last character in the character sequence can be deleted.

CD 300

Menu elements and symbols

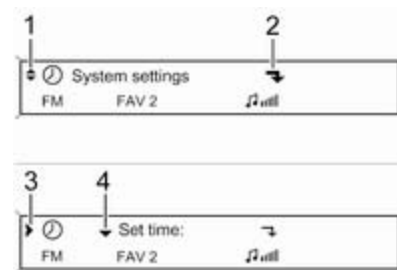

The up and down arrows **1** indicate: the top menu level is active. Further options are available in the active menu.

Turn the multifunction knob to display the other options in the active menu.

The angled arrow **2** indicates: a submenu with further options is available.

Press the multifunction knob to select the option displayed and to open the corresponding submenu.

The arrow pointing to the right **3** indicates: the first submenu level is active (two arrows = second submenu level active).

The down arrow **4** indicates: further options are available in the active submenu.

Activating a setting

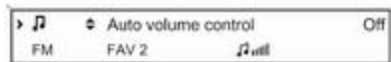

Press the multifunction knob to open the corresponding settings menu.

Turn the multifunction knob to display the desired setting.

Press the multifunction knob to activate the setting.

Setting a value



Press the multifunction knob to open the corresponding settings menu.

Turn the multifunction knob to change the current value of the setting.

Press the multifunction knob to confirm the set value.

Switching a function on or off



Press the multifunction knob to open the corresponding settings menu.

Turn the multifunction knob to mark the setting **On** or **Off**.

Press the multifunction knob to confirm the marked setting.

Entering a character sequence

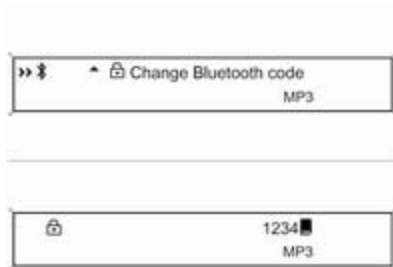

Press the multifunction knob to open the relevant settings menu.

Turn the multifunction knob to change the character at the current cursor position.

Press the multifunction knob to confirm the character displayed.

Using the **BACK** button the last character in the character sequence can be deleted.

Tone settings

Navi 600 / Navi 900

In the tone settings menu the tone characteristic can be set differently for each radio waveband and each audio player source.

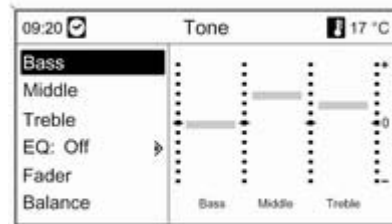

Press the **TONE** button to open the tone menu.

Setting bass, middle and treble

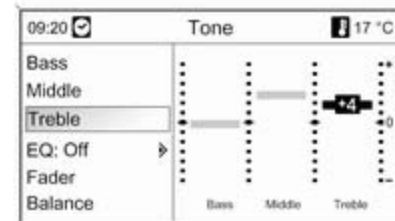

Select **Bass**, **Middle** or **Treble**.

Set the desired value for the option selected.

Setting the volume distribution between front - rear

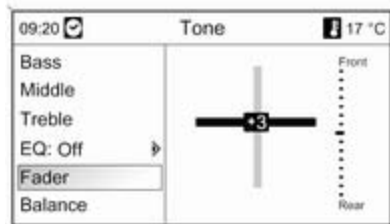

Select **Fader**.

Set the desired value.

Setting the volume distribution between right - left

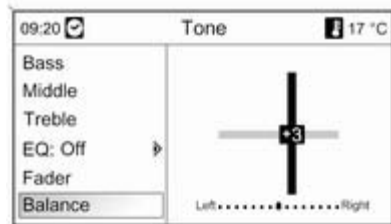

Select **Balance**.

Set the desired value.

Setting an individual setting to "0" or "Off"

Select the desired option and press and hold the multifunction knob for a few seconds.

Setting all settings to "0" or "Off"

Press and hold the **TONE** button for a few seconds.

Optimising the tone for the style of music

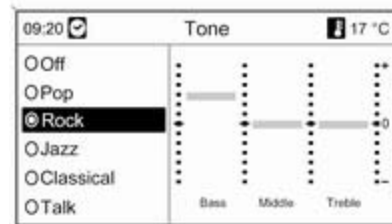

Select **EQ** (Equalizer).

The displayed options offer optimised bass, middle and treble presets for the relevant style of music.

Select the required option.

CD 300 / CD 400

In the tone settings menu the tone characteristics can be set differently for each radio waveband and each audio player source.

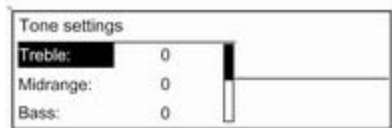

Press the **TONE** button to open the tone menu.

Setting bass, middle and treble

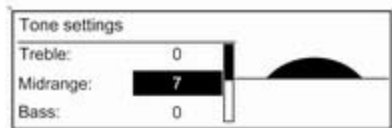

Select **Bass:**, **Midrange:** or **Treble:**.

Set the desired value for the selected option.

Setting the volume distribution between front - rear

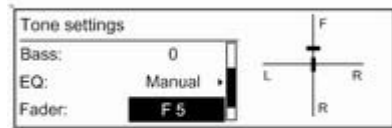

Select **Fader:**.

Set the desired value.

Setting the volume distribution between right - left

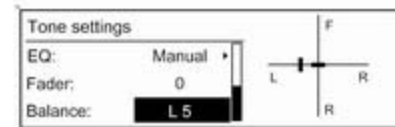

Select **Balance:**.

Set the desired value.

Setting an individual setting to "0" or "Off"

Select the desired option and press and hold the multifunction knob for a few seconds.

Setting all settings to "0" or "Off"

Press and hold the **TONE** button for a few seconds.

Optimizing the tone for the style of music

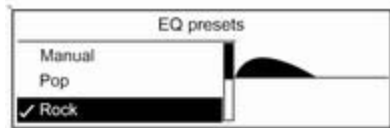

Select **EQ**: (Equalizer).

The displayed options offer optimized bass, middle and treble presettings for the relevant style of music.

Select the desired option.

Volume settings

Navi 600 / Navi 900

Maximum startup volume

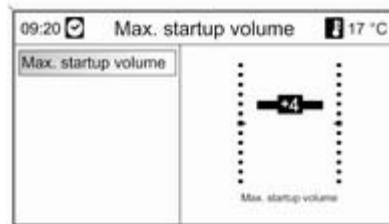

Press the **CONFIG** button to open the system settings menu.

Select **Radio settings** and then **Maximum startup volume**.

Set the desired value.

Speed dependent volume

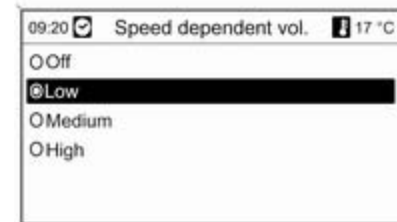

Press the **CONFIG** button to open the system settings menu.

Select **Radio settings** and then **Speed dependent volume**.

Speed dependent volume can be deactivated or the degree of volume adaptation can be selected in the menu displayed.

Select the required option.

Volume of the traffic announcements (TA)

The volume of the traffic announcements can be increased or reduced proportionately to the normal audio volume.

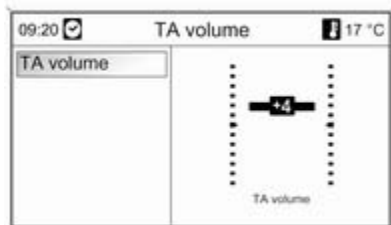

Press the **CONFIG** button to open the system settings menu.

Select **Radio settings**, **RDS options** and **TA volume**.

Set the desired value.

CD 300 / CD 400

Maximum startup volume

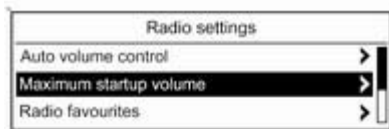

Press the **CONFIG** button to open the system settings menu.

Select **Radio settings** and then **Maximum startup volume**.

CD 300: select **Audio settings** and then **Start up Volume**.

Set the desired value.

Speed compensated volume



Press the **CONFIG** button to open the system settings menu.

Select **Radio settings** and then **Auto volume control**.

CD 300: select **Audio settings** and then **Auto volume control**.

Speed compensated volume can be deactivated or the degree of volume adaptation can be selected in the menu displayed.

Select the desired option.

Volume of the traffic announcements (TA)

The volume of the traffic announcements can be increased or reduced proportionately to the normal audio volume.

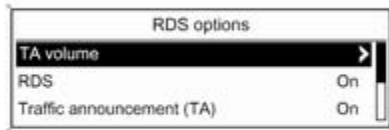

Press the **CONFIG** button to open the system settings menu.

Select **Radio settings**, **RDS options** and **TA volume**.

CD 300: select **Audio settings**, **RDS options** and **TA volume**.

Set the desired value for the volume increase or reduction.

Personalisation

(only CD 400)

Various Infotainment system settings can be separately memorised for each vehicle key (driver) of the car.

Memorised settings

By removing the vehicle key from the ignition switch the following settings are automatically saved for the key being used:

- last volume settings; one volume level for all non-phone audio sources (radio, CD player, AUX, USB) and one for phone audio (if phone portal available)
- all radio station presets
- all tone settings; each of these settings are separately saved for each of the following audio sources (if available): AM, FM, DAB, CD player, AUX, USB
- last active audio source
- last active radio station (separately for each waveband)
- last active display mode

- last position in Audio/MP3 CD including track number and folder
- state of shuffle songs setting (CD player)
- state of TP (Traffic Programme) setting
- cursor position for each menu on the display

Activating/deactivating personalization

Press the **CONFIG** button to open the system settings menu.

Select **Vehicle settings** and then **Comfort settings**.

Set **Personalization by driver** to **On** or **Off**.

Radio

Usage	24
Station search	24
Autostore lists	25
Favourite lists	26
Waveband menus	28
Radio data system (RDS)	33
Digital audio broadcasting	37

Usage

Control buttons

The most important buttons for control of the radio are as follows:

- **RADIO**: Activate radio
- **◀ ▶**: Station search
- **AS**: Autostore lists
- **FAV**: Favourite lists
- **1...6**: Preset buttons
- **TP**: Radio traffic service ⇨ 33

Activating the radio

Press the **RADIO** button to open the radio main menu.

The station last played will be received.

Selecting the waveband

Press the **RADIO** button once or several times to select the desired waveband.

The station last played in that waveband will be received.

Station search

Automatic station search

Briefly press the button **◀ ▶** or **▶ ▶** to play the next station in the station memory.

Manual station search

Navi 600 / Navi 900

Press **◀ ▶** or **▶ ▶** button and keep pressed. Release button when the required frequency has almost been reached on the frequency display.

A search is made for the next station that can be received and it is played automatically.

CD 300 / CD 400

Press the button **◀ ▶** or **▶ ▶** for a few seconds to start a search for the next receivable station in the current waveband.

When the required frequency has been reached the station is played automatically.

Note

Manual station search: If the radio does not find a station, it switches automatically to a more sensitive search level. If it still does not find a station, the frequency that was last active is set again.

Note

FM waveband: when the RDS function is activated, only RDS stations ↻ 33 are searched for, and when the radio traffic service (TP) is activated, only traffic service stations ↻ 33 are searched for.

Manual station tuning**FM waveband**

Only Navi 600 / Navi 900: press the multifunction knob to open the FM menu and select **Manual tuning FM**.

Turn the multifunction knob and set the optimal reception frequency on the popup frequency display.

AM waveband

Turn the multifunction knob and set the optimal reception frequency on the popup frequency display.

DAB waveband

(not available for CD 300)

Press the multifunction knob to open the DAB menu and select **DAB manual tuning**.

Turn the multifunction knob and set the required reception frequency on the popup frequency display.

Autostore lists

The stations that can be received best in a waveband can be searched for and stored automatically via the autostore function.

Navi 600 / Navi 900:

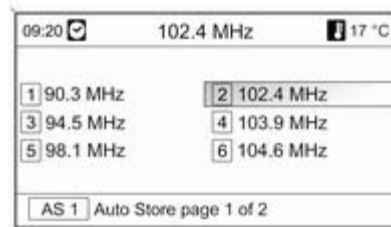
**Note**

The currently received station is highlighted.

CD 400:

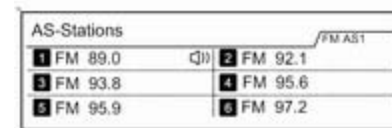
**Note**

The currently received station is marked by 📡.

Each waveband has 2 autostore lists (**AS 1, AS 2**), in each of which 6 stations can be stored.

Automatic station storing

Keep the **AS** button pressed until an autostore message is displayed. The 12 strongest stations in the current waveband will be stored in the 2 autostore lists.

To abort the autostore procedure, press the multifunction knob.

Storing stations manually

Stations can also be stored manually in the autostore lists.

Set the station to be stored.

Briefly press the **AS** button to open an autostore list or to switch to another autostore list.

To store the station in a list position: press the corresponding station button 1...6 until a confirmation message is displayed.

Note

Manually stored stations are overwritten in an automatic station storing process.

Retrieving a station

Briefly press the **AS** button to open an autostore list or to switch to another autostore list.

Briefly press one of the station buttons 1...6, to open the station at the corresponding list position.

Favourite lists

Stations of all wavebands can be stored manually in the favourite lists.

Navi 600 / Navi 900

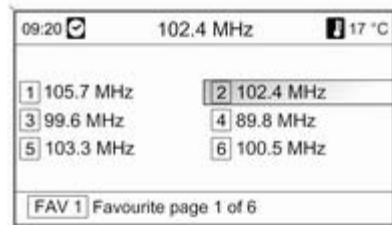

6 stations can be stored in each favourite list. The number of available favourite lists can be set (see below).

Note

The currently received station is highlighted.

Storing a station

Set the station to be stored.

Briefly press the **FAV** button to open a favourite list or to switch to another favourite list.

To store the station in a list position: press the corresponding station button 1...6 until a confirmation message is displayed.

Retrieving a station

Briefly press the **FAV** button to open a favourite list or to switch to another favourite list. Briefly press one of the station buttons 1...6, to open the station at the related list position.

Defining the number of available favourite lists

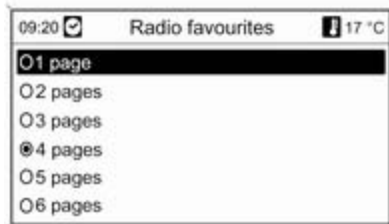

Press **CONFIG** button.

Select **Radio settings** and then **Radio favourites**.

Select the desired number of available favourite lists.

CD 300 / CD 400



6 stations can be stored in each favourite list. The number of available favourite lists can be set (see below).

CD 300: The number of available favourite lists is not configurable.

Note

The currently received station is marked by .

Storing a station

Set the station to be stored.

Briefly press the **FAV** button to open a favourite list or to switch to another favourite list.

To store the station in a list position: press the corresponding station button 1...6 until a confirmation message is displayed.

Retrieving a station

Briefly press the **FAV** button to open a favourite list or to switch to another favourite list.

Briefly press one of the station buttons 1...6, to open the station at the related list position.

Defining the number of available favourite lists (not CD 300)

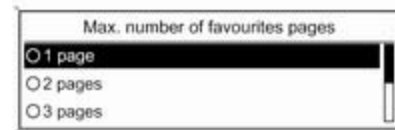

Press the **CONFIG** button.

Select **Radio settings** and then **Radio favourites**.

Select the desired number of available favourite lists.

Waveband menus

Alternative facilities for station selection are available via waveband specific menus.

With the radio main menu active press the multifunction knob to open the relevant waveband menu.

Note

The following FM specific displays are shown as examples.

Navi 600 / Navi 900

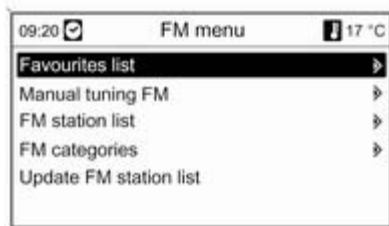

Favourites list

Select **Favourites list**. All stations saved in the favourites lists are displayed.

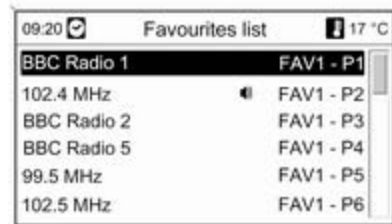

Select the required station.

Note

The currently received station is marked by 📻.

Manual tuning

Description see "Manual station tuning" above.

Station lists

AM/FM waveband

Select **AM station list** or **FM station list**.

All receivable AM/FM stations in the current reception area are displayed.

DAB waveband

Turn the multifunction knob.

All receivable DAB stations ⇨ 37 in the current reception area are displayed.

Note

If no station list has been created beforehand, the Infotainment system performs an automatic station search.



Select the required station.

Note

The currently received station is marked by 📡.

Updating station lists

If the stations stored in a waveband-specific station list can no longer be received:

Select the corresponding command to update a station list.

A station search is started. Once the search is finished, the station previously selected is played.

To cancel the station search: press multifunction knob.

Note

If a waveband specific station list is updated the corresponding category list (if available) is also updated.

Important information on updating the station lists

The dual tuner in the Infotainment system continuously updates the station lists in the background. This ensures that, e.g., the station lists always contain the stations that can be received in the local area during a long motorway journey. As the automatic updating takes a certain amount of time, not all stations that can be received may be available at

once in the station list at a sudden change in reception area. In such circumstances the updating of the station lists can be accelerated using the corresponding command for updating a station list.

Category lists

Numerous RDS stations ⇨ 33 broadcast a PTY code, which specifies the type of programme transmitted (e.g. news). Some stations also change the PTY code depending on the content currently being transmitted.

The Infotainment system stores these stations, sorted by programme type, in the corresponding category list.

To search for a programme type determined by station: select the waveband specific category list option.

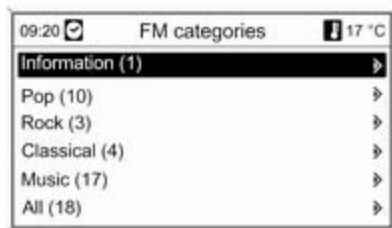

A list of programme types available at the moment is displayed.

Select desired programme type.

A list of stations is displayed that transmit a programme of the selected type.

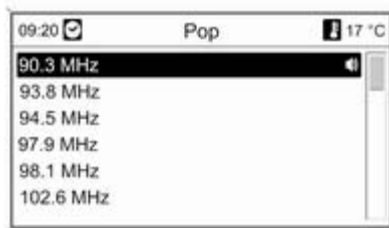

Select the required station.

The category list is also updated when the corresponding waveband specific station list is updated.

Note

The currently received station is marked by .

DAB announcements

Besides their music programmes numerous DAB stations broadcast various announcement categories.

The currently received DAB service (programme) is interrupted when any announcements of previously activated categories are pending.

Activating announcement categories

Select **DAB announcements** in the DAB menu.



Activate the desired announcement categories.

Several announcement categories can be selected at the same time.

Note

DAB announcements can only be received if the DAB waveband is activated.

CD 300 / CD 400

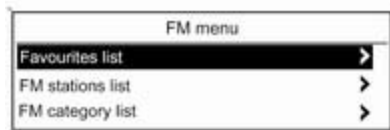
**Favourites list**

Select **Favourites list**. All stations saved in the favourites lists are displayed.

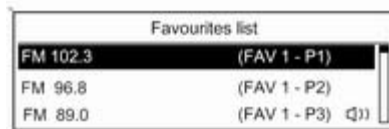

Select the required station.

Note

The currently received station is marked by .

Stationslists**AM/FM waveband**

Select **AM stations list** or **FM stations list**.

All receivable AM/FM stations in the current reception area are displayed.

DAB waveband

(not available for CD 300)

Turn the multifunction knob.

All receivable DAB stations  37 in the current reception area are displayed.

Note

If no station list has been created beforehand, the Infotainment system performs an automatic station search.

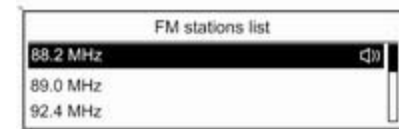

Select the required station.

Note

The currently received station is marked by .

Updating stations lists

If the stations stored in a waveband-specific station list can no longer be received:

Select the corresponding command to update a station list.

CD 400: The dual tuner of the Infotainment system continuously updates the FM stations list in the background. No manual update is required.

A station search is started. Once the search is completed the station last received will be played.

To abort the station search, press the multifunction knob.

Note

If a waveband specific station list is updated the corresponding category list (if available) is also updated.

Category lists

Numerous RDS stations ⇨ 33 broadcast a PTY code, which specifies the type of programme transmitted (e.g. news). Some stations also change the PTY code depending on the content currently being transmitted.

The Infotainment system stores these stations, sorted by programme type, in the corresponding category list.

To search for a programme type determined by station: select the waveband specific category list option.



A list of programme types available at the moment is displayed.

Select the desired programme type.

A list of stations is displayed that transmit a programme of the selected type.

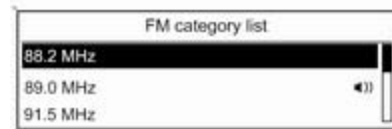

Select the desired station.

CD 300: The next receivable station of the selected type is searched for and is played.

The category list is also updated when the corresponding waveband specific station list is updated.

Note

The currently received station is marked by ↵).

DAB announcements

Besides their music programmes numerous DAB stations ⇨ 37 broadcast various announcement categories.

The currently received DAB service (programme) is interrupted when any announcements of previously activated categories are pending.

Activating announcement categories

Select **DAB announcements** in the DAB menu.

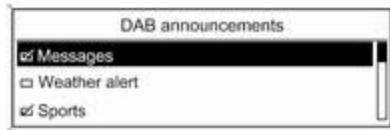

Activate the desired announcement categories.

Several announcement categories can be selected at the same time.

Note

DAB announcements can only be received if the DAB waveband is activated.

Radio data system (RDS)

RDS is a service of FM stations that considerably facilitates the finding of the desired station and its fault-free reception.

Advantages of RDS

- On the display the programme name of the set station appears instead of its frequency.
- On station search the Infotainment system tunes in to RDS stations only.
- The Infotainment system always tunes into the best receivable broadcasting frequency of the set station by means of AF (Alternative Frequency).
- Depending on the station that is received the Infotainment system displays radio text that can contain, for example, information about the current programme.

Navi 600 / Navi 900



Configuring RDS

To open the menu for the RDS configuration:

Press the **CONFIG** button.

Select **Radio settings** and then **RDS options**.

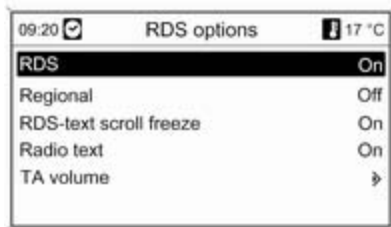

Switching RDS on and off

Set **RDS** to **On** or **Off**.

Switching regionalization on and off
(RDS must be activated for regionalization.)

At certain times some RDS stations broadcast regionally different programmes on different frequencies.

Set **Regional** to **On** or **Off**.

If regionalization is switched on, only alternative frequencies (AF) with the same regional programmes are selected.

If regionalization is switched off, alternative frequencies of the stations are selected without regard to regional programmes.

RDS scrolling text

Some RDS stations use the lines for indicating the name of the programme to also indicate additional information. During this process the programme name is hidden.

To prevent additional information being displayed:

Set **RDS-text scroll freeze** to **On**.

Radio text

If RDS and reception of an RDS station are activated, information about the programme that is currently receivable and about the music track being played at the moment are displayed below the programme name.

To show or hide the information:

Set **Radio text** to **On** or **Off**.

TA volume

The volume of the traffic announcements (TA) can be preset ↵ 21.

Radio traffic service

(TP = Traffic Programme)

Radio traffic service stations are RDS stations that broadcast traffic news.

Switching the radio traffic service on and off

To switch the traffic announcement standby facility of the Infotainment system on and off:

Press the **TP** button.

- If the radio traffic service is switched on, [] is indicated on the display in black (grey if radio traffic service is switched off).
- Only radio traffic service stations are received.
- If the current station is not a radio traffic service station, a search is started automatically for the next radio traffic service station.
- If a radio traffic service station has been found, [TP] is indicated on the display in black. If no radio traffic service stations are found, TP is displayed in grey.
- Traffic announcements are played at the preset TA volume ↵ 21.

- If the radio traffic service is switched on, CD/MP3 replay is interrupted for the duration of the traffic announcement.

Listening to traffic announcements only

Switch on the radio traffic service and completely turn down the volume of the Infotainment system.

Blocking out traffic announcements

To block out a traffic announcement, e.g. during CD/MP3 replay:

Press **TP** button or the multifunction knob to confirm the cancel message on the display.

The traffic announcement is aborted, but the radio traffic service remains switched on.

EON (Enhanced Other Networks)

With EON you can listen to radio traffic announcements even if the station you have set does not broadcast its own radio traffic service. If such a station is set, it is displayed in black as for radio traffic service stations **TP**.

CD 300 / CD 400



Configuring RDS

To open the menu for the RDS configuration:

Press the **CONFIG** button.

Select **Radio settings** and then **RDS options**.

CD 300: Select **Audio settings** and then **RDS options**.

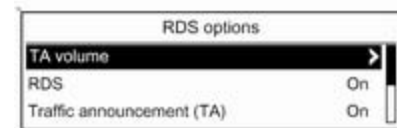

TA volume

The volume of the traffic announcements (TA) can be preset ⇨ 21.

Switching RDS on and off

Set the option **RDS** to **On** or **Off**.

Traffic announcement (TA)

To switch the TA function on or off permanently:

Set the option **Traffic announcement (TA)** to **On** or **Off**.

Switching regionalization on and off (RDS must be activated for regionalization.)

At certain times some RDS stations broadcast regionally different programmes on different frequencies.

Set the option **Regional (REG)** to **On** or **Off**.

If regionalization is switched on, only alternative frequencies (AF) with the same regional programmes are selected.

If regionalization is switched off, alternative frequencies of the stations are selected without regard to regional programmes.

RDS-scrolling text

Some RDS stations hide the programme name in the display line in order to display additional information.

To prevent additional information being displayed:

Set **RDS-Text scroll freeze** to **On**.

Radio text:

If RDS and reception of an RDS station are activated, information about the programme that is currently receivable and about the music track

being played at the moment are displayed below the programme name.

To show or hide the information:

Set the option **Radio text:** to **On** or **Off**.

Radio traffic service

(TP = Traffic Programme)

Radio traffic service stations are RDS stations that broadcast traffic news.

Switching the radio traffic service on and off

To switch the traffic announcement standby facility of the Infotainment system on and off:

Press the **TP** button.

- If the radio traffic service is switched on, [] is displayed in the radio main menu.
- Only radio traffic service stations are received.
- If the current station is not a radio traffic service station, a search is started automatically for the next radio traffic service station.

- If a radio traffic service station has been found, [TP] is displayed in the radio main menu.
- Traffic announcements are played at the preset TA volume ⇨ 21.
- If the radio traffic service is switched on, CD/MP3 replay is interrupted for the duration of the traffic announcement.

Listening to traffic announcements only

Switch on the radio traffic service and completely turn down the volume of the Infotainment system.

Blocking out traffic announcements

To block out a traffic announcement, e.g. during CD/MP3 replay:

Press **TP** button or the multifunction knob to confirm the cancel message on the display.

The traffic announcement is aborted, but the radio traffic service remains switched on.

EON (Enhanced Other Networks)

With EON you can listen to radio traffic announcements even if the station you have set does not broadcast its own radio traffic service. If such a station is set, it is displayed in black as for radio traffic service stations TP.

Digital audio broadcasting

(not available for CD 300)

Digital audio broadcasting (DAB) is an innovative and universal broadcast system.

DAB stations are indicated by the programme name instead of the broadcasting frequency.

Navi 600 / Navi 900:



CD 400:



General information

- With DAB, several radio programmes (services) can be broadcast on a single frequency (ensemble).
- Besides high-quality digital audio services, DAB is also able to transmit programme-associated data and a multitude of other data services including travel and traffic information.
- As long as a given DAB receiver can pick up the signal sent out by a broadcasting station (even if the signal is very weak), sound reproduction is ensured.
- There is no fading (weakening of the sound) that is typical of AM or FM reception. The DAB signal is reproduced at a constant volume.
- If the DAB signal is too weak to be picked up by the receiver, reception is interrupted completely. This incident can be avoided by:
Navi 600 / Navi 900: activating **Auto ensemble linking** in the DAB settings menu.

CD 400: activating **Auto ensemble linking** and/or **Auto linking DAB-FM** in the DAB settings menu.

- Interference caused by stations that are on nearby frequencies (a phenomenon that is typical of AM and FM reception) does not occur in connection with DAB.
- If the DAB signal is reflected by natural obstacles or buildings, the reception quality of DAB is improved, whereas AM or FM reception is considerably impaired in such cases.
- The reception of DAB+ stations is presently not supported by the DAB receiver.

Configuring DAB

Navi 600 / Navi 900

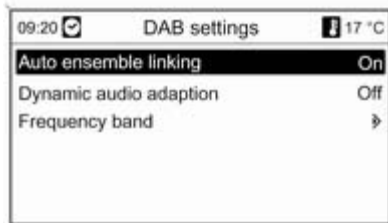

Press the **CONFIG** button.

Select **Radio settings** and then **DAB settings**.

The following options are available in the configuration menu:

- **Auto ensemble linking**: with this function activated, the device switches over to the same service (programme) on another DAB ensemble (frequency, if available) when the DAB signal is too weak to be picked up by the receiver.

- **Dynamic audio adaption**: with this function activated, the dynamic range of the DAB signal is reduced. That means the level of the loud sounds is reduced, but not the level of the quiet sounds. Therefore the volume of the Infotainment system can be raised to a point where the quiet sounds are audible, without the loud sounds being too loud.
- **Frequency band**: after selection of this option the user can define which DAB wavebands are to be received by the Infotainment system.

CD 400

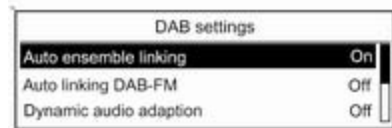

Press the **CONFIG** button.

Select **Radio settings** and then **DAB settings**.

The following options are available in the configuration menu:

- **Auto ensemble linking:** with this function activated, the device switches over to the same service (programme) on another DAB ensemble (frequency, if available) when the DAB signal is too weak to be picked up by the receiver.
- **Auto linking DAB-FM:** with this function activated, the device switches over to a corresponding FM station of the active DAB service (if available) when the DAB signal is too weak to be picked up by the receiver.
- **Dynamic audio adaption:** with this function activated, the dynamic range of the DAB signal is reduced. That means the level of the loud sounds is reduced, but not the level of the quiet sounds. Therefore the volume of the Infotainment system

can be raised to a point where the quiet sounds are audible, without the loud sounds being too loud.

- **Frequency band:** after selection of this option it can be defined which DAB wavebands are to be received by the Infotainment system.

CD Player

General information	40
Usage	42

General information

Navi 600 / Navi 900

The Infotainment system's CD player can replay audio CDs and MP3/WMA CDs.

Important information about audio CDs and MP3/WMA CDs

Caution

Under no circumstances place DVDs, single-CDs with a diameter of 8 cm or shaped CDs in the audio player.

You must not put any stickers on CDs. These discs can get jammed in the CD drive and ruin the drive. An expensive replacement of the device will then be necessary.

- Audio CDs with copy protection, which are not in compliance with the audio CD standard, may not play correctly or not at all.

- Self-recorded CD-Rs and CD-RWs are more vulnerable to mishandling than prerecorded CDs. Correct handling, especially in the case of self-recorded CD-Rs and CD-RWs, must be ensured; see below.
- Self-recorded CD-Rs and CD-RWs may not play correctly or not at all.
- On mixed mode CDs (combinations of audio and data, e.g. MP3), only the audio tracks will be detected and played.
- Avoid leaving fingerprints when you change CDs.
- Put CDs back in their sleeves immediately after removing them from the audio player in order to protect them from damage and dirt.
- Dirt and liquids on CDs can smear the lens of the audio player inside the device and cause faults.
- Protect CDs from heat and direct sunlight.
- The following restrictions apply for the data stored on an MP3/WMA CD:

Maximum folder structure depth:
11 levels.

Maximum number of MP3/WMA
files that can be saved: 1000.

WMA files with Digital Rights
Management (DRM) from online
music shops cannot be played.

WMA files can only be played back
safely if they were created with
Windows Media Player version 8 or
later.

Applicable playlist
extensions: .m3u, .pls

Playlist entries must be in the form
of relative paths.

- This chapter deals only with playing MP3 files since the operation for MP3 and WMA files is identical. When a CD with WMA files is loaded MP3 related menus are displayed.

CD 300 / CD 400

The Infotainment system's CD player can play audio CDs and MP3/WMA CDs.

Important information about audio CDs and MP3/WMA CDs

Caution

Under no circumstances place DVDs, single-CDs with a diameter of 8 cm or shaped CDs in the audio player.

You must not put any stickers on CDs. These discs can get jammed in the CD drive and ruin the drive. An expensive replacement of the device will then be necessary.

- The following CD formats can be used:
CD-ROM Mode 1 and Mode 2.
CD-ROM XA Mode 2, Form 1 and Form 2.
- The following file formats can be used:
ISO9660 Level 1, Level 2, (Romeo, Joliet).
MP3 and WMA files written in any format other than listed above may not play correctly, and their file

names and folder names may not be displayed correctly.

- Audio CDs with copy protection, which are not in compliance with the audio CD standard, may not play correctly or not at all.
- Self-recorded CD-Rs and CD-RWs are more vulnerable to mishandling than prerecorded CDs. Correct handling, especially in the case of self-recorded CD-Rs and CD-RWs, must be ensured. See below.
- Self-recorded CD-Rs and CD-RWs may not play correctly or not at all. In such cases it is not the equipment that is at fault.
- On mixed mode CDs (audio tracks and compressed files, e.g. MP3, are stored), the audio tracks part and the compressed files part can be played separately.
- Avoid leaving fingerprints when you change CDs.
- Put CDs back in their sleeves immediately after removing them from the CD player in order to protect them from damage and dirt.

- Dirt and liquids on CDs can smear the lens of the CD player inside the device and cause faults.
- Protect CDs from heat and direct sunlight.
- The following restrictions apply for the data stored on an MP3/WMA CD:
 - Number of tracks: max. 999.
 - Number of folders: max. 255.
 - Folder structure depth: max. 64 levels (recommended: max. 8 levels).
 - Number of playlists: max. 15.
 - Number of songs per playlist: max. 255.
 - Applicable playlist extensions: .m3u, .pls, .asx, .wpl.
- This chapter deals only with playing MP3 files since the operation for MP3 and WMA files is identical. When a CD with WMA files is loaded MP3 related menus are displayed.

Usage

Navi 600 / Navi 900



Starting CD replay

Push CD with the labelled side upward into the CD slot until it is pulled in.

CD replay starts automatically and the **Audio CD** or **Audio MP3** menu is displayed.

If there is already a CD in the unit, but the **Audio CD** or **Audio MP3** menu is not active:

Press **CD/AUX** button.

The **Audio CD** or **Audio MP3** menu is opened and CD replay is started.

Depending on the data stored on the audio CD or MP3 CD differing information about the CD and the current music track will be shown on the display.

Selecting a track

Turn the multifunction knob to display a list of all tracks on the CD. The currently played track is preselected. Select the desired track.

Skipping to the next track or previous track

Briefly press << K or K >> button once or several times.

Track search forward or backward

Briefly press << K or K >> button and then press << K or K >> button again and keep pressed until the desired track is displayed.

Fast forward or rewind

Press the button << K or K >> and hold it down to fast forward or rewind the current track.

Selecting tracks using the audio CD or MP3 menu

During audio CD replay



Press the multifunction knob to open the audio CD related menu.

To play all tracks in random order: set **Shuffle songs (RDM)** to **On**.

To select a track on the audio CD: select **Track list** and then select the desired track.

During MP3 replay

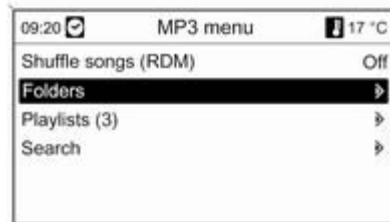

Press the multifunction knob to open the MP3 related menu.

To play all tracks in random order: set **Shuffle songs (RDM)** to **On**.

To select a track from a folder or playlist (if available): select **Folders** or **Playlists**.

Select a folder or playlist and then select the desired track.

Select **Search** to open a menu with additional options for track search and selection.

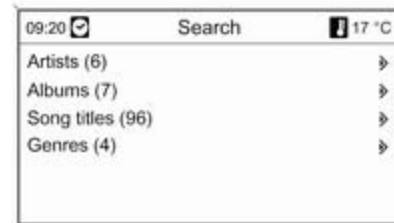

Depending on the amount of tracks saved, the search process may take several minutes.

Select a search option and then select the desired track.

Removing a CD

Press \triangle button.

The CD is pushed out of the CD slot.

If the CD is not removed after ejection, it will be drawn back in again automatically after a few seconds.

CD 300 / CD 400

**Starting CD replay**

Press the **CD** button to open the CD or MP3 menu.

If there is a CD in the CD player, CD replay is started.

Depending on the data stored on the audio CD or MP3 CD differing information about the CD and the current music track will be shown on the display.

Inserting a CD

Insert a CD with the printed side facing up into the CD slot until it is drawn in.

Changing the standard page view
(only CD 300)

During audio CD or MP3 replay: press the multifunction knob and then select **Default CD page view** or **Default MP3 page view**.

Select the desired option.

Changing the folder level
(only CD 300, MP3 replay)

Press the button or to change to a higher or lower folder level.

Skipping to the next track or previous track

Briefly press the button or .

Fast forward or rewind

Press the button or and hold it down to fast forward or rewind the current track.

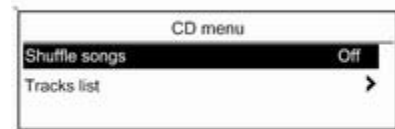
Selecting tracks using the audio CD or MP3 menu**During audio CD replay**

Press the multifunction knob to open the audio CD related menu.

To play all tracks in random order: set **Shuffle songs** to **On**.

To select a track on the audio CD: select **Tracks list** and then select the desired track.

During MP3 replay

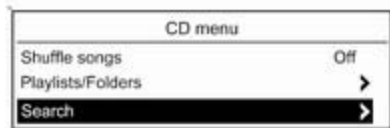

Press the multifunction knob to open the MP3 related menu.

To play all tracks in random order: set **Shuffle songs** to **On**.

To select a track from a folder or playlist (if available): select **Playlists/Folders**.

Select a folder or playlist and then select the desired track.

Note

If a CD contains both audio and MP3 data, the audio data can be selected from **Playlists/Folders**.

To open a menu with additional options for track search and selection: select **Search**. What options are available depends on the data saved on the MP3 CD.

The search process on the MP3 CD may take several minutes. During this time the station last played will be received.

Removing a CD

Press the \triangle button.

The CD is pushed out of the CD slot.

If the CD is not removed after ejection, it will be drawn back in again automatically after a few seconds.

AUX input

General information	46
Usage	46

General information

Navi 600 / Navi 900:



CD 300 / CD 400:



In the centre console there is an AUX socket for the connection of external audio sources.

It is possible, for example, to connect a portable CD player with a 3.5 mm jack plug to the AUX input.

Note

The socket must always be kept clean and dry.

Usage

Press the **CD/AUX** or **AUX** button once or several times to activate the AUX mode.

Navi 600 / Navi 900:



CD 300 / CD 400:



An audio source that is connected to the AUX input can be operated only via the control elements of the audio source.

USB port

General information	48
Playing saved audio files	49

General information

Navi 600 / Navi 900



In the centre console there is a USB socket for the connection of external audio data sources.

Note

The socket must always be kept clean and dry.

An MP3 player, USB drive or an iPod can be connected to the USB port.

Note

Not all MP3 player, USB drive and iPod models are supported by the Infotainment system.

Important information

MP3 player and USB drives

- The MP3 players and USB drives connected must comply with the USB Mass Storage Class specification (USB MSC).
- Only MP3 players and USB drives with a cluster size smaller or equal to 64 kB in the FAT16/FAT32 file system are supported.
- Hard disk drives (HDD) and are not supported.
- USB hubs are not supported.
- The following restrictions apply for the data stored on an MP3 Player or USB device:

Maximum folder structure depth:
11 levels.

Maximum number of MP3/WMA files that can be saved: 1000.

WMA files with Digital Rights Management (DRM) from online music shops cannot be played.

WMA files can only be played back safely if they were created with Windows Media Player version 8 or later.

Applicable playlist extensions: .m3u, .pls

Playlist entries must be in the form of relative paths.

The system attribute for folders/ files that contain audio data must not be set.

CD 400



In the centre console there is a USB socket for the connection of external audio data sources.

Devices connected to the USB port are operated via the controls and menus of the Infotainment system.

Note

The socket must always be kept clean and dry.

Important information

The following devices can be connected to the USB port:

- iPod
- Zune
- PlaysForSure device (PFD)
- USB drive

Note

Not all iPod, Zune, PFD or USB drive models are supported by the Infotainment system.

Playing saved audio files

Navi 600 / Navi 900

MP3 player / USB drives



Press the **CD/AUX** button once or several times to activate the audio USB mode.

Replay of the audio data stored on the USB device is started.

The operation of data sources connected via USB is the same as for an audio MP3/WMA CD ↻ 42.

iPod



Press the **CD/AUX** button once or several times to activate the audio iPod mode.

Replay of the audio data stored on the iPod is started.

The operation of the iPod connected via USB is mainly the same as for an audio MP3/WMA CD ↷ 42.

On the following pages only the aspects of operation that are different/additional are described.

iPod functions

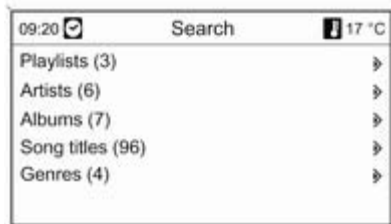

Depending on the data saved, there are various options for the selection and playing of tracks.

Press the multifunction knob and then select **Search** to display the options available.

The search process on the device may take several seconds.

CD 300 / CD 400



Press the **AUX** button once or several times to activate the USB mode.

Replay of the audio data stored on the USB device is started.

The operation of data sources connected via USB is mainly the same as for an audio MP3 CD ↷ 42.

On the following pages only the aspects of operation that are different/additional are described.

Operation and the screen displays are described for USB drives only. Operation of other devices like iPod or Zune is mainly the same.

Selecting tracks using the USB menu

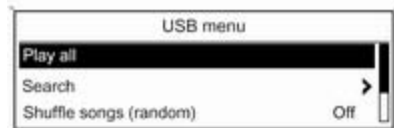

Press the multifunction knob to open the USB related menu.

To play all tracks in succession: select **Play all**.

To display a menu with various additional options for track search and selection: select **Search**.

The search process on the USB device may take several minutes. During this time the station last played will be received.

To play all tracks in random order: set **Shuffle songs (Random)** to **On**.

To repeat the currently played track: set **Repeat** to **On**.

Digital picture frame

General information	52
Usage	52

General information

Using the digital picture frame function (only Navi 600 / Navi 900) you can view your favourite pictures (or photos), one at a time, on the display of the Infotainment system.

You can download your favourite pictures from a USB drive connected to the USB port ↻ 48 of the Infotainment system.

Up to 10 pictures can be stored in the Infotainment system's memory.

The pictures are shown on the display in their original ratio (borders if necessary are black) and orientation.

Important information

- The pictures you want to download need to be stored in the root directory (e.g., "F:\") of the USB drive.
- Only the first 100 pictures (sequentially sorted as stored in the root directory of the USB drive) will be offered for download.

- Only pictures in JPEG standard format (file extensions, e.g., .jpg or .jpeg) are supported.

Example: "F:\myPicture.jpg", where "F:\\" is the root directory of the USB drive.

- The maximum supported resolution of a picture is 12 Mega pixel.

Pictures with higher resolutions are down-scaled (resized) during download.

Pictures with lower resolutions are not up-scaled (not resized) during download and centred in the middle of the display.

Usage

Downloading and/or removing pictures

Connect a USB drive with your favourite pictures (or photos) stored on it to the USB port ↻ 48 of the Infotainment system.

Press the **CONFIG** button, select **Display settings**, and then select **Picture frame**. The menu shown below is displayed.

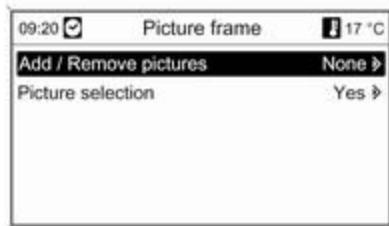

Select **Add / Remove pictures** to open the menu shown below.

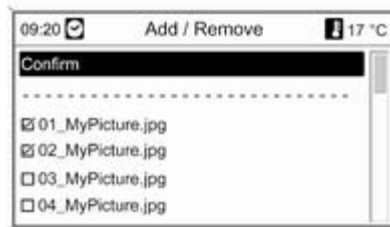

The menu shows a list with the file names of all pictures (note the restrictions described in "Important information" above) stored in the root directory of the connected USB drive.

If pictures were already stored in the Infotainment system's memory, that "old" pictures are listed first on the menu and indicated by **MEM**, see image below.

If you want to have removed "old" pictures, you need to deselect them before downloading new pictures.



Select max. 10 pictures that you want to be downloaded (added) to the Infotainment system's memory or stay stored in that memory.

Select **Confirm** to start the picture download and/or removal.

A message is displayed that shows how many pictures are going to be downloaded and/or removed.

Select **Continue** if you want to start the download and/or removal.

Displaying pictures

Pictures stored in the Infotainment system's memory can be shown on the display one at a time.

Press the **CONFIG** button, select **Display settings**, select **Picture frame**, and then select **Picture selection**. The menu shown below is displayed.



Select the picture you want to be shown on the display.

Press the **INFO** button several times until the currently selected picture is shown on the display.

To display a default Infotainment menu again, press any button on the Infotainment system.

As long as a picture stays selected in the **Picture selection** menu, it can be displayed at any time using the **INFO** button.

Navigation

General information	55
Usage	56
Destination input	67
Guidance	85
Dynamic guidance	93
Maps	94
Symbols overview	96

General information

The navigation system will reliably guide you to your destination without the need to read maps, even if you have no local knowledge whatsoever.

The current traffic situation is taken into account in the route calculation if dynamic route guidance is used. For this purpose the Infotainment system receives traffic announcements in the current reception area via RDS-TMC.

The navigation system cannot, however, take into account traffic incidents, traffic regulations changed at short notice and hazards or problems that arise suddenly (e.g. road works).

Caution

The usage of the navigation system does not release the driver from the responsibility for a correct, vigilant attitude in road traffic. The relevant traffic regulations must always be followed. If a navigation instruction contradicts traffic regulations, the traffic regulations always apply.

Functioning of the navigation system

The position and movement of the vehicle are detected by the navigation system using sensors. The travelled distance is determined by the vehicle's speedometer signal, turning movements on bends by a gyro sensor. The position is determined by the GPS satellites (Global Positioning System).

By comparing the sensor signals with the digital maps on the map SD card, it is possible to determine the position with an accuracy of approx. 10 metres.

The system will also work with poor GPS reception, however, the accuracy of the determination of the position will be reduced.

After the entry of the destination address or point of interest (nearest petrol station, hotel, etc.) the route is calculated from the current location to the destination selected.

The route guidance is provided by voice output and an arrow, as well as with the aid of a multi-colour map display.

TMC traffic information system and dynamic route guidance

The TMC traffic information system receives all current traffic information from TMC radio stations. If dynamic route guidance is active, this information is included in the calculation of the overall route. During this process, the route is planned so that traffic problems related to pre-selected criteria are avoided.

If there is a traffic problem during active route guidance, depending on the pre-settings, a message appears as to whether the route should be changed.

TMC traffic information is displayed in the route guidance display as symbols or as detailed text on the **TMC messages** menu.

To be able to use TMC traffic information, the system has to receive TMC stations in the relevant region.

Dynamic route guidance only works if traffic information is received via the TMC traffic information system.

The dynamic route guidance function can be deactivated in the **Navigation options** menu, see section "Guidance" ↪ 85.

Map data

All required map data is stored on an SD card provided with the Infotainment system.

Detailed descriptions on map SD card handling and replacement, see section "Maps" ↪ 94

Usage

Control elements

The most important navigation-specific control elements are the following:

NAVI button: activate navigation; show current position (if route guidance inactive); show calculated route (if route guidance active); toggle between full map display, arrow display (if route guidance active) and split screen display, see "Information on the display".

DEST button: open menu with options for destination entry.

Eight-way switch: move display window in navigation map view; to select the destination, press in the required direction to position the crosswires over a destination on the map.

RPT button: repeat last route guidance message.

Activating the navigation system

Press the **NAVI** button.

The map of the current location is shown on the display.

Route guidance messages

In addition to the visual instructions on the display (see "Information on the display" below), route guidance messages will be announced when route guidance is active.

Presetting the volume of route guidance messages: see "Setting up the navigation system" below.

Adjusting the volume of route guidance messages while they are announced: turn the \odot knob.

Repeating the last announced route guidance message: press the **RPT NAV** button.

Information on the display

Route guidance not active

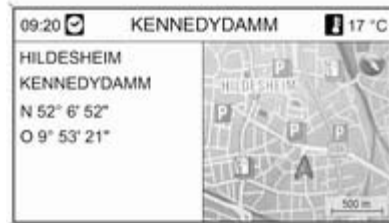

If route guidance is not active, the following information is displayed:

- In the top line: time, street name of current position, exterior temperature.
- Address and geographic coordinates of current position.
- Map display of the area around the current position.
- On the map: current position marked by a red triangle.

A compass symbol that indicates the north direction.

If no GPS signal is available at the current position, a crossed "GPS" symbol is displayed below the compass symbol.

The currently selected map scale (change scale: turn multifunction knob).

Route guidance active

If route guidance is active, the following information is displayed (depending on the current **Navigation options** settings, see section "Guidance" ↗ 85):

Information in the top line



- Time
- Distance to the final destination
- Arrival time or travel time
- Exterior temperature

Information on the arrow display

- A big arrow representing the direction to follow.
- A small arrow representing the next but one driving recommendation.
- Distance to the next intersection.
- Streets leading off the current street to follow.

- Below the arrow symbol: the name of the current street to follow.
- Above the arrow symbol: the name of the street to follow after the next intersection.
- While driving on highways:



Driving direction and distance to the next highway exit, which you need to follow.

Distances to the next service areas, parking areas, intersections and/or exits on the highway.

- When reaching a highway intersection information regarding lane guidance is displayed:

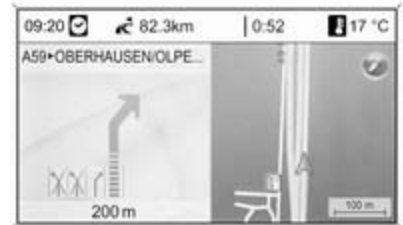

If the option **Highway lane guidance** is activated in the **Display route guidance** menu (see section "Guidance" ⇨ 85) the following type of illustration is displayed:



Information on the map display



On the right side of the display the following information is shown:

- A compass symbol that indicates the north direction.
- If no GPS signal (see section "General information" ↗ 55) is available at the current position: a crossed "GPS" symbol is displayed below the compass symbol.
- The currently selected map scale (change scale: turn multifunction knob).

On the map the following information is shown:

- The route as a blue line.
- The current position as a red triangle.
- The final destination as a chequered flag.
- Various symbols (see section "Symbols overview" ↗ 96) that indicate traffic information and general information or points of interest.

Setting up the navigation system

Press the **CONFIG** button and then select **Navigation settings** to open a menu with navigation-specific settings.

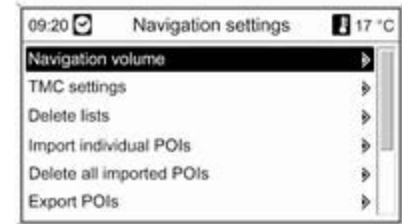

Navigation volume

The relative volumes of the navigation message (**Announcement**) and the audio source (**Background**) during a navigation message can be preset.

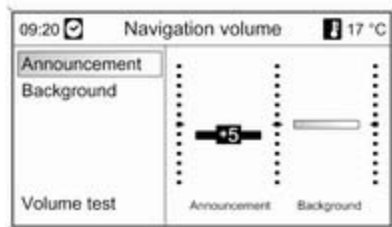

Set the desired values for **Announcement** and **Background**.

To test the current settings: select **Volume test**.

TMC settings

Select **Infotypes** to open a submenu with various options to define whether and which traffic message infotypes are to be displayed on the active route guidance map.

When **User defined** is selected, the infotypes that are to be displayed can be defined.

Sort criteria

Select whether traffic messages are to be displayed in an order based on distance or street name.

Warning messages when route guidance is inactive

Decide whether the Infotainment system should announce warning messages even if no route guidance is active.

Delete lists

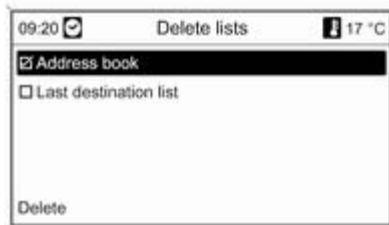

Select whether all entries in the **Address book** or in the **Last destination list** are to be deleted.

Import individual POIs

Only applicable if a USB drive with points of interest (POI) data stored on it is connected to the USB port 48 of the Infotainment system.

Importing POI data from a USB drive, see "Exporting and importing POI data" below.

Delete all imported POIs

Only applicable if POI data were imported to the Infotainment system, see "Exporting and importing POI data" below.

Select this menu item to remove all imported POI data from the myPOIs memory of the Infotainment system.

Note

It is not possible to directly remove individual imported points of interest from the myPOIs memory.

If you want to remove individual imported POIs: import updated POI data to the Infotainment system that do not contain the address data of the regarding POIs.

To remove all imported POIs of a certain category: import an empty POI data file of the regarding category to the Infotainment system.

Export POIs

Exports all POI data stored in the myPOIs memory of the Infotainment system to a USB drive connected to the USB port ↻ 48, see "Exporting and importing POI data" below.

Delete Home address

Deletes the currently set home address (displayed in the **Enter destination** menu, see chapter "Destination input" ↻ 67).

myPOIs announcement

(only Navi 900)

Using this menu option you can activate and set up the myPOIs announcer of the Infotainment system.

If activated and correspondingly set up, the myPOIs announcer will automatically notify you via a message on the display and a beep when the vehicle approaches a point of interest stored in the myPOIs memory, see "myPOIs announcer" below.

Exporting and importing POI data**Introductory explanations****Types of POI data**

The Infotainment system provides the following types of points of interest data:

- **Predefined Points of Interest** stored on the map SD card and indicated by icons on the map display.

You can store such predefined POIs in the address book or as individual POIs in the myPOIs

memory of the Infotainment system, see below.

- **Favourite destination addresses that were stored in the Address book.**

You can export these address book data to a USB drive for later use, e.g., in other cars.

- **Individual POIs:** favourite destination addresses that were stored in the myPOIs memory.

You can export these individual POI data to a USB drive for later use, e.g., in other cars.

- **User defined POIs:** favourite destination addresses that you defined via GPS coordinates (taken, e.g., from a topographical map) and that you entered into text files.

You can store these user defined POI data on a USB drive and later import the data to the myPOIs memory of the Infotainment system, see below.

- **Imported POIs:** favourite destination addresses that were previously stored on a USB drive and then imported to the myPOIs memory of the Infotainment system.

Advantages of POI export and import

The export and import of points of interest data offer you, e.g., the following advantages:

- Define and store your favourite destination addresses only once, and later use these address data in other cars.

See "Exporting and importing individual POIs and address book entries" below.

- Define your favourite destination addresses conveniently at home, and later use them in your car.

See "Creating and importing user defined POIs" below.

- Clearly arrange a large amount of destination addresses, e.g., favourite destination addresses of other family members or destination addresses for your next

journey or business trip in separate submenus.

See "Organizing the POI data in several subfolders" below.

Exporting and importing individual POIs and address book entries

Brief description:

1. Connect a USB drive to the USB port of your car's Infotainment system.
2. Store (export) your favourite destination addresses on the USB drive.
3. Connect the USB drive to the USB port of a car equipped with a Navi 600 or Navi 900 system.
4. Download (import) the address data to the car's Infotainment system.

After the import, the addresses can be selected as destinations for route guidance.

Detailed descriptions see below.

Exporting POI data to a USB drive

Connect a USB drive to the USB port of the Infotainment system, see chapter "USB port" ⇨ 48.

Press the **CONFIG** button, select **Navigation settings** and then select **Export POIs**.

The **Export POIs** menu is displayed.

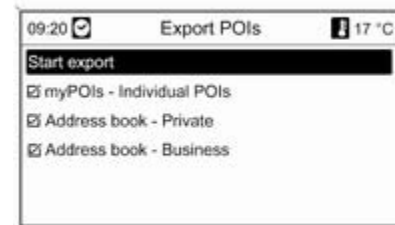

By default all individual POIs stored in the myPOIs memory and all address book entries will be exported.

If desired, deselect the address data types that you do not want to be exported.

Select **Start export** to store the address data of the selected type(s) on the connected USB drive.

The address data will be stored in a folder named **myPOIs** that is located in the root directory of the USB drive.

For each exported POI category, e.g. **Restaurant** or **Private**, you will find a correspondingly named file in that folder.

Examples:

F:\myPOIs\Restaurant_3.poi or

F:\myPOIs\Private_1.poi, where **F:** is the root directory of the USB drive.

Note

If files with POI data of the same category are already stored on the USB drive in the **myPOIs** folder, these old file versions will be overwritten by equally named new file versions.

The folder **myPOIs** and the files with POI data should not be renamed or moved into another folder on the USB drive. Otherwise the Infotainment system will not be able to import the address data again.

Importing POI data from a USB drive

Connect a USB drive with POI data stored on it (details see above) to the USB port of the Infotainment system, see section "USB port" ↪ 48.

To start the import: press the **CONFIG** button, select **Navigation settings**, select **Import individual POIs** and then select **Continue**.

All POI data stored on the USB drive is imported to the myPOIs memory of the Infotainment system.

After the import is finished, the imported POIs are selectable as destinations via the **Enter destination** menu, see chapter "Destination input" ↪ 67.

Creating and importing user defined POIs

User defined points of interest need to be defined via GPS coordinates that can be taken, e.g., from a topographical map.

The GPS coordinates and further address data need to be entered into text files, each file representing a POI category.

Brief description:

1. Create the text files for the POI data.
2. Enter the desired address data into the text files.
3. Store the text files with your POI data on a USB drive.
4. Connect the USB drive to the USB port of your car's Infotainment system.
5. Download (import) the text files with your POI data to the Infotainment system.

After the import, the addresses can be selected as destinations for route guidance.

Detailed descriptions see below.

Creating the text files for POI data

You can assign your favourite destination addresses to 20 different POI categories, with each POI category assigned a number, see "POI categories and assigned numbers" below.

For each POI category you need to create a separate text file.

The text files can be created, e.g., by using a simple text editor software.

Note

The text editor must support the UTF-8 character encoding for Unicode.

Each text file name need to consist of the category name, a single underscore, the category's number and the file extension **.poi**.

Example file names:

- **Business_2.poi**
- **Home & Living_8.poi**
- **Culture_15.poi**

Note

The length of the text file names is limited to 32 characters.

POI categories and assigned numbers:

- (1) **Private**, (2) **Business**, (3) **Restaurant**, (4) **Hotel**, (5) **Automotive**, (6) **Travel**, (7) **Cinema**, (8) **Home & Living**, (9) **Shopping**, (10) **Craft**, (11) **Sport**, (12) **Sight**, (13) **Health care**, (14) **Leisure**, (15) **Culture**, (16) **Nightlife**, (17)

Communication, (18) **News & broking**, (19) **Government office**, (20) **General**.

Entering POI data into the text files

The image below shows a sample text file named **Home & Living_8.poi** with some sample POI data:



The POI data need to be entered into the text files in the following format:

Longitude coordinate, Latitude coordinate, "Name of POI", "Any additional information", "Phone number (optional)"

Example: **7.0350000, 50.6318040, "Michaels Home", "Bonn - Hellweg 6", "02379234567"**, see image above.

The GPS coordinates need to be expressed in decimal degrees.

The maximum length of the POI name is 60 characters. The same applies to the additional information string and the phone number string.

The POI data of each destination address need to be entered in a single separate line, see image above.

Storing the text files on a USB drive

The text files with POI data need to be stored in a folder named **myPOIs** that is located in the root directory of the USB drive.

Example: **F:\myPOIs\Home & Living_8.poi**, where **F:** is the root directory of the USB drive.

After importing the individual POI data to the Infotainment system (see import description further below), the **Imported POIs** menu will show a list of selectable POI categories like the following:



Organizing the POI data in several subfolders

Optionally you can organize the text files in several, arbitrary named, subfolders.

Examples: **F:\myPOIs\AnnsPOIs** or **F:\myPOIs\MyJourney**, where **F:** is the root directory of the USB drive.

After importing individual POI data organized in that way to the Infotainment system (see import description further below), the **Imported POIs** menu will show a list of selectable submenus like the following:

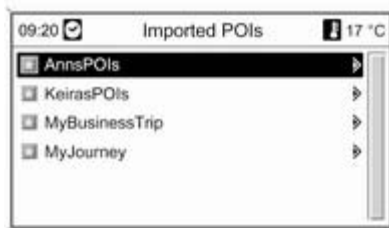

After selecting a submenu, the related list of imported POI categories will be displayed.

Importing the POI data to the Infotainment system

Connect the USB drive with your individual POI data to the USB port of the Infotainment system, see chapter "USB port" ↗ 48.

To start the import: press the **CONFIG** button, select **Navigation settings**, select **Import individual POIs** and then select **Continue**.

All POI data stored on the USB drive is imported to the myPOIs memory of the Infotainment system.

After the import is finished, the imported POIs are selectable as destinations via the **Enter destination** menu, see section "Destination input" below.

myPOIs announcer

(only Navi 900)

Via the myPOIs announcer you can be notified via a message on the display (see image below) and a beep when the vehicle approaches a point of interest (POI) stored in the myPOIs memory of the Infotainment system.

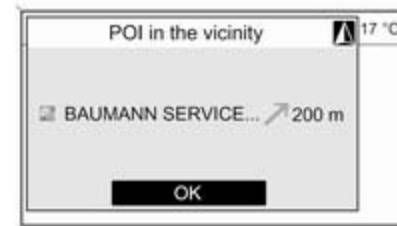

Detailed descriptions on POIs stored in the myPOIs memory, see "Exporting and importing POI data" above and section "Destination input" below.

If route guidance is active, you are notified only when the vehicle approaches a POI which is located next to a road on the calculated route.

If route guidance is inactive, you are notified when the vehicle approaches a POI which is located next to the road you are currently driving on.

Additionally you are notified when the vehicle approaches a POI which is located next to an adjacent road, and if the system considers it very probable that you will turn into that road next.

Setting up the myPOIs announcer

Press the **CONFIG** button, select **Navigation settings** and then select **myPOIs announcement**.

A menu is displayed that shows the POI categories currently stored in the myPOIs memory.

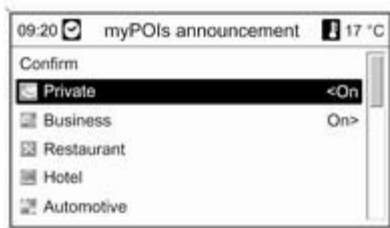

You can now determine, which of the displayed POI categories should be considered by the myPOIs announcer for later notifications.

Select a POI category. The menu shown below is displayed.

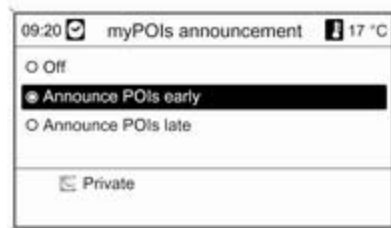

You can now determine in which relative distance to POIs of the selected category you want to be notified when approaching them.

Select **Announce POIs early** if you want to be notified already when the vehicle is still relatively far away (approx. 400 metres) from the location of the regarding POI.

Select **Announce POIs late** if you want to be notified only when the vehicle is already relatively close (approx. 200 metres) to the location of the regarding POI.

After selecting the desired option, the list of POI categories is displayed again.

If you selected **Announce POIs early** for a category, the regarding list entry is now set to **<On**.

If you selected **Announce POIs late** for a category, the regarding list entry is now set to **On>**.

After selecting and setting up all desired POI categories, select **Confirm** to store the new myPOIs announcer settings.

Destination input

Press the **DEST** button to open a menu with various options for entering or selecting a destination.

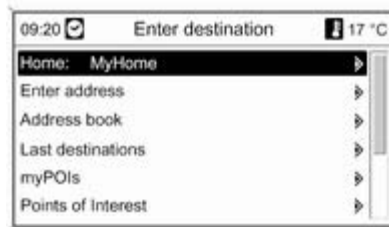

- **Home:** selection of the currently set home address (if available). Setting/changing the home address, see "Setting the home address" below.
After selecting the home address, the Infotainment system immediately calculates a route from the current position to the home address and then starts route guidance.
- **Enter address:** direct entry of a destination address with country, city, street and house number. See "Entering an address directly" below.

- **Address book:** selection of a destination address stored in the address book. See "Selecting an address from the address book" below.

See also "Storing an address in the address book or myPOIs memory" and "Editing or deleting a stored address" below.

- **Last destinations:** selection from a list of recently selected destinations. See "Selecting a previous destination" below.
- **myPOIs:** selection of a destination address stored in the myPOIs memory. See "Selecting an address stored in the myPOIs memory" below.
See also "Storing an address in the address book or myPOIs memory" and "Editing or deleting a stored address" below.
- **Points of Interest:** selection of POIs (addresses of, e.g., restaurants, petrol stations, hospitals etc.) stored on the map SD card of the

Infotainment system. See "Selecting a point of interest" below.

- **Select from map:** selection of a destination from the map display using the eight-way switch ↻ 4. See "Selecting a destination from the map" below.
- **Latitude / Longitude:** selection of a destination using geographic coordinates. See "Selecting a destination via geographic coordinates" below.

Selecting a petrol station as destination after a Fuel level low alert

When the fuel level in the vehicle's tank is low, an alert message is displayed.

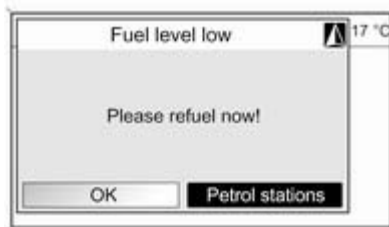

To start a search for petrol stations close to the vehicle's current position: select **Petrol stations**.

After the search is finished, a list of all found petrol stations is displayed.



Below the list detailed information on the currently marked petrol station is displayed: the approximate direction to the petrol station, the address, the distance and the available fuel types (in addition to petrol and Diesel).

Abbreviations used for fuel types:
CNG (Compressed natural gas),
LPG (Liquefied petroleum gas).

Starting route guidance to a petrol station

Select the desired petrol station.

The **Navigation** menu is displayed.

Select **Start navigation** to start route guidance to the displayed address.

Description on route guidance, see section "Guidance" ↗ 85.

Entering an address directly

Press the **DEST** button and then select **Enter address** to open the menu shown below.



To change/select the country: mark the country input field (see image above) and then press the multifunction knob to open the **Countries** menu.



Select the desired country.

Entering an address using the speller function

Mark the **City:** input field and then press the multifunction knob to activate the speller function.

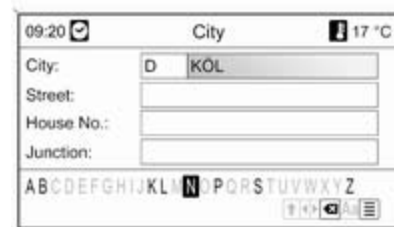

Using the multifunction knob, successively mark and accept the letters for the desired city. During this process the system will automatically block letters that cannot occur next in the city name.

The following symbols can be selected in the bottom line:

- ↑ : Lists with special letters are displayed in the bottom line.
- ◀▶ : Previous/next letter is marked.
- ✕ : Delete last letter.
- Aa : Upper, lower case.

☐ : List function - once two letters have been entered (in some cases just one letter), all names available with these letters are displayed. The more letters are entered, the shorter becomes the list.

OK : Complete entry or accept search term.

By a long press on the **BACK** button all letters entered are deleted at once from the input line.

Repeat the process for the remaining input fields (entering a house number or junction is optional).



After completing the address, select **OK**.

The **Navigation** menu is displayed.

Starting route guidance

Select **Start navigation** to start route guidance to the displayed address.

Description on route guidance, see section "Guidance" ⇨ 85.

Storing the address

Select **Store** if you want to store the displayed address in the address book or myPOIs memory.

The **Store** menu is displayed, see "Storing an address in the address book or myPOIs memory" below.

Selecting an address from the address book

Press the **DEST** button and then select **Address book**.

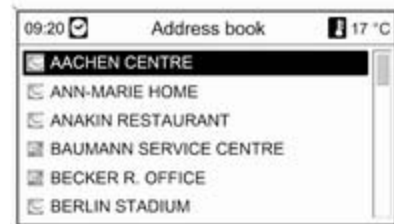

Select the desired address book entry.

The **Navigation** menu is displayed.

Starting route guidance

Select **Start navigation** to start route guidance to the displayed address.

Description on route guidance, see section "Guidance" ⇨ 85.

Selecting a previous destination

Press the **DEST** button and then select **Last destinations** to open the menu shown below.



A list of the most recently used destination addresses is displayed.

Select the desired destination.

The **Navigation** menu is displayed.

Starting route guidance

Select **Start navigation** to start route guidance to the displayed address.

Description on route guidance, see section "Guidance" ↗ 85.

Storing the address

Select **Store** if you want to store the displayed address in the address book or myPOIs memory.

The **Store** menu is displayed, see "Storing an address in the address book or myPOIs memory" below.

Selecting an address stored in the myPOIs memory

Press the **DEST** button and then select **myPOIs** to open the menu shown below.

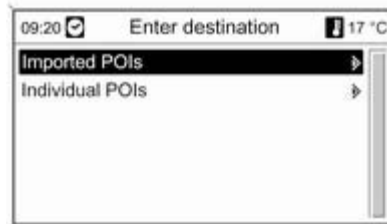

Note

The option **Imported POIs** is only selectable if points of interest (address) data were downloaded from a USB drive, see "Exporting and importing POI data" in section "Usage" above.

Select the desired option. A menu with various sorting options is displayed.

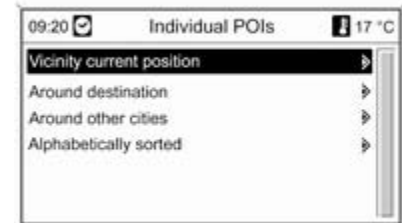

The sorting options determine in which order the addresses of the individual/imported points of interest will be displayed later.

Select the desired sorting option.

A menu with the currently available points of interest categories is displayed.



Select the desired category.

A menu with a list of all available points of interest of the selected category (e.g. **Restaurant**) is displayed.

Note

Points of interest which are far away from the vehicle's current position may not be displayed in the list.



Below the list detailed information on the currently marked point of interest is displayed: the approximate direction to the point of interest, the address and the distance.

Starting route guidance to a point of interest

Select the desired point of interest.

The **Navigation** menu is displayed.

Select **Start navigation** to start route guidance to the displayed address.

Description on route guidance, see section "Guidance" ⇨ 85.

Selecting a point of interest

Press the **DEST** button and then select **Points of Interest**.

A menu with various options for the selection of points of interest (e.g. restaurants, petrol stations, hospitals etc.) is displayed.

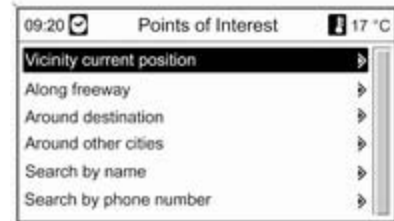

Vicinity current position

Selection of points of interest close to the vehicle's current position.

After selecting the option, a list of all available points of interest categories is displayed.

For example, you are looking for a petrol station:

Select **Petrol station**.

A menu is displayed that provides options for further refinement of the petrol station search.

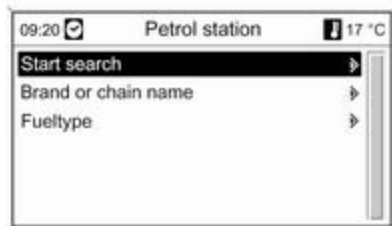

After selecting **Start search**, a search for all petrol stations in the area is started. The search takes into account all petrol stations that meet the currently set filter criteria for **Brand or chain name** and **Fueltype** (changing the filter criteria, see "Setting filters for search refinement" below).

After the search is finished, a list of all found petrol stations is displayed.



Below the list detailed information on the currently marked petrol station is displayed: the approximate direction to the petrol station, the address, the distance and the available fuel types (in addition to petrol and Diesel).

Abbreviations used for fuel types: **CNG** (Compressed natural gas), **LPG** (Liquefied petroleum gas).

Setting filters for search refinement

After selecting **Brand or chain name**, a list is displayed with all available petrol station brands/chains in the area.



The number of petrol stations can be reduced by marking at least one petrol station brand/chain.

After marking the desired brands/chains: select **Start search with selected filters** or, for further refinement of the search, select **Continue with next filter** (fuel types).

After selecting **Fueltype**, a list is displayed with all fuel types available (in addition to petrol and Diesel) at petrol stations in the area.

The number of petrol stations can be reduced by marking at least one fuel type.

After marking the desired fuel types: select **Start search with selected filters** or, for further refinement of the search, select **Continue with next filter** (petrol station brands/chains).

After starting a search, a list of all petrol stations that meet the previously selected filter criteria is displayed.

Select the desired petrol station.

The **Navigation** menu is displayed.

Starting route guidance

Select **Start navigation** to start route guidance to the displayed address.

Description on route guidance, see section "Guidance" ↗ 85.

Storing the address

Select **Store** if you want to store the displayed address in the address book or myPOIs memory.

The **Store** menu is displayed, see "Storing an address in the address book or myPOIs memory" below.

Along freeway

Selection of motorway related points of interest (e.g. petrol stations or service areas) along the route. Only available when you are currently driving on a motorway.

Selecting a point of interest: see example above for „Vicinity current position“.

Around destination

Selection of points of interest close to the destination entered.

Selecting a point of interest: see example above for „Vicinity current position“.

Around other cities

Selection of points of interest around any city.

After selecting the option, a country list is displayed.

Select the desired country. A menu for entering a city name is displayed.



Enter the desired city using the speller function, see "Entering an address using the speller function" above.

Once the entry is specific enough, a list with possible cities is displayed. Sometimes it may be necessary to select  for displaying the list.

Select the desired city. A menu appears on which the points of interest close to the selected city are listed by category.

Selecting a point of interest: see example above for „Vicinity current position“.

Search by name

Selection of points of interest by entering a name.

After selecting the option, a country list is displayed.

Select the desired country. A menu for name input is displayed.

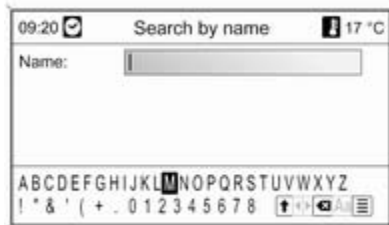

Enter the name of the desired point of interest using the speller function, see "Entering an address using the speller function" above.

Once the entry is specific enough, a list with possible points of interest is displayed. Sometimes it may be necessary to select  for displaying the list.

Select the desired point of interest.

The **Navigation** menu is displayed.

Starting route guidance

Select **Start navigation** to start route guidance to the displayed address.

Description on route guidance, see section "Guidance" ↗ 85.

Storing the address

Select **Store** if you want to store the displayed address in the address book or myPOIs memory.

The **Store** menu is displayed, see "Storing an address in the address book or myPOIs memory" below.

Search by phone number

Selection of points of interest by entering a telephone number.

After selecting the option, a country list is displayed.

Select the desired country. A menu for number input is displayed.



Enter the desired telephone number using the speller function, see "Entering an address using the speller function" above.

Once the entry is specific enough a list with possible telephone numbers (each number representing a point of interest) is displayed. Sometimes it may be necessary to select  for displaying the list.

Select the desired point of interest.

The **Navigation** menu is displayed.

Starting route guidance

Select **Start navigation** to start route guidance to the displayed address.

Description on route guidance, see section "Guidance" ⇨ 85.

Storing the address

Select **Store** if you want to store the displayed address in the address book or myPOIs memory.

The **Store** menu is displayed, see "Storing an address in the address book or myPOIs memory" below.

Selecting a destination from the map

Press the **DEST** button and then select **Select from map**.

A menu with a map showing the area around the current location is displayed.



Note

The map scale can be changed by turning the multifunction knob.

Using the eight-way switch on the multifunction knob ⇨ 4 position the crosswire on a destination on the map.

Press the multifunction knob to confirm the selection.

The **Navigation** menu is displayed.

Starting route guidance

Select **Start navigation** to start route guidance to the displayed address.

Description on route guidance, see section "Guidance" ⇨ 85.

Storing the address

Select **Store** if you want to store the displayed address in the address book or myPOIs memory.

The **Store** menu is displayed, see "Storing an address in the address book or myPOIs memory" below.

Selecting a destination via geographic coordinates

Press the **DEST** button and then select **Latitude / Longitude**.

A menu that allows the input of geographic coordinates as destination address is displayed.

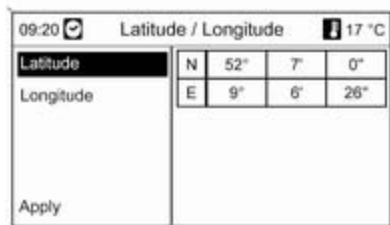

Entering the Latitude coordinate

1. Select **Latitude**.
2. Turn the multifunction knob to select **N** or **S** (north or south of the equator).
3. Press the multifunction knob to confirm the selection.
4. Turn the multifunction knob to enter the desired degrees of latitude.
5. Press the multifunction knob to confirm the entry.
6. Enter the desired values for the latitude minutes and seconds.

Entering the Longitude coordinate

1. Select **Longitude**.
2. Turn the multifunction knob to select **W** or **E** (west or east of the prime meridian in Greenwich).
3. Press the multifunction knob to confirm the entry.
4. Enter and confirm the desired values for the longitude degrees, minutes and seconds.

Select **Apply** to confirm the displayed coordinates.

The **Navigation** menu is displayed.

Starting route guidance

Select **Start navigation** to start route guidance to the displayed address.

Description on route guidance, see section "Guidance" ⇨ 85.

Storing the address

Select **Store** if you want to store the displayed address in the address book or myPOIs memory.

The **Store** menu is displayed, see "Storing an address in the address book or myPOIs memory" below.

Storing an address in the address book or myPOIs memory

The Infotainment system provides two separate memory areas where you can store your favourite destination addresses: the address book and the myPOIs memory.

Before storing an address in one of these memory areas, you need to assign the address to a category:

- If you want to store an address in the address book, you need to assign the address to the categories **Private** or **Business**.
- If you want to store an address in the myPOIs memory, you can choose from 18 categories (e.g. **Restaurant**, **Travel** or **Culture**).

Storing an address in the address book

Press the **DEST** button to open the **Enter destination** menu, and then select an option for the input or selection of a destination address (e.g. **Enter address** or **Last**

destinations), see regarding descriptions on address input or selection above.

After entering or selecting the desired destination address, the **Navigation** menu is displayed.

Select **Store**.

The menu **Store** is displayed, with the previously entered or selected destination address as default name.

The default name can be changed (see example in the image below) using the speller function, see "Entering an address using the speller function" above.



A telephone number can be entered optionally.

The default category **Private** can be changed to **Business**:

Select the displayed category to open a menu with a list of all available address categories.



Note

If you select another category than **Private** or **Business**, the destination address will be stored in the myPOIs memory not in the address book.

Select **Business**.

The menu **Store** is displayed again.

Select **OK** to store the destination address in the address book using the displayed name and category.

A maximum of 100 destination addresses can be stored in the address book.

Storing an address in the myPOIs memory

Storing a destination address in the myPOIs memory functions the same as described above for the address book.

The only difference: select a category different from **Private** or **Business**, e.g. **Restaurant**, **Automotive** or **Shopping**.

Note

If you select one of the categories **Private** or **Business**, the destination address will be stored in the address book not in the myPOIs memory.

Editing or deleting a stored address

Address data (including the category and telephone number) stored in the address book or myPOIs memory can be edited or entirely deleted at any time.

Editing or deleting an address book entry

Press the **DEST** button, select **Address book**, select the desired address entry and then select **Edit**. The **Edit** menu is displayed.

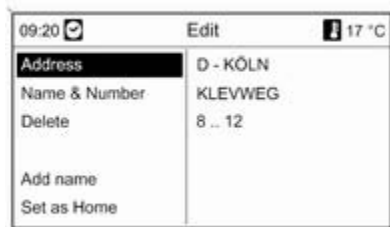

The following options are available:

- **Address**: opens the **Enter address** menu. You can edit the displayed address using the speller function, see "Entering an address using the speller function" above.

After confirming the edited address, the **Navigation** menu is displayed again.

If you want to edit also the name or change the category, you need to select the regarding address in the address book again, see above.

- **Name & Number**: after selecting this option, you can edit the name of the address book entry, edit the telephone number or select a new category, see "Storing an address in the address book" above.
- **Delete**: deletes the displayed address from the address book.
- **Add name** (only Navi 900): assigns a name (voice tag) to the displayed address. The regarding address can be selected later as destination

by simply saying the assigned name, see chapter "Speech recognition".

- **Set as Home**: sets the displayed address as home address, see "Setting the home address" below.

Editing or deleting a myPOIs entry

Press the **DEST** button and then select **myPOIs** to open the menu shown below.

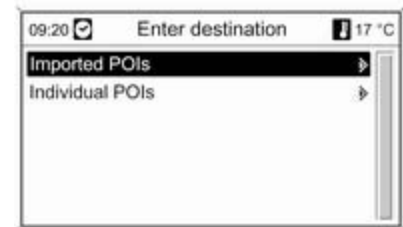

Editing or deleting Individual POIs

Select **Individual POIs**, select the desired sorting option (e.g. **Vicinity current position**), select the desired category (e.g. **Restaurant**), select the desired address and then select **Edit**.

The **Edit** menu is displayed.

Editing or deleting the displayed myPOIs entry functions the same as described for an address book entry, see above.

Notes on Imported POIs

Imported points of interest (POIs downloaded from a USB drive) cannot be edited directly.

If you want to edit the address data of an imported POI:

- You first need to store the address in the address book or as an individual point of interest. Then you can edit the address data of the regarding address book entry or myPOIs entry (selectable via **Individual POIs**).

- Or you can import updated address data from a USB drive, see "Exporting and importing POI data" in section "Usage" above.

It is also not possible to directly remove the address data of individual imported points of interest from the myPOIs memory.

If you want to remove individual imported POIs:

Import updated POI data to the Infotainment system that do not contain the address data of the POIs which you want to be removed.

To remove all imported POIs of a certain category: import an empty POI data file of the regarding category.

Descriptions on importing POI data, see "Exporting and importing POI data" in section "Usage" above.

Deleting all imported POIs at once:

Press the **CONFIG** button, select **Navigation settings** and then select **Delete all imported POIs**.

Setting the home address

Before you can set an address as home address, you need to store this address in the address book or myPOIs memory, see corresponding descriptions above.

Setting an address book entry as home address

Press the **DEST** button, select **Address book**, select the desired address entry, select **Edit** and then select **Set as Home**.

The displayed address is set as new home address and displayed as first option in the **Enter destination** menu.

Setting a myPOIs entry as home address

Press the **DEST** button and then select **myPOIs** to open the menu shown below.

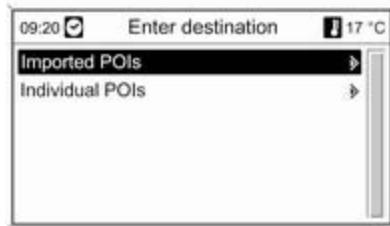

Setting an individual POI as home address

Select **Individual POIs**, select the desired sorting option (e.g. **Vicinity current position**), select the desired category (e.g. **Restaurant**), select the desired address, select **Edit** and then select **Set as Home**.

The displayed address is set as new home address and displayed as first option in the **Enter destination** menu.

Notes on Imported POIs

Imported points of interest (POIs downloaded from a USB drive) cannot be set as home address directly.

If you want to set the address of an imported POI as home address:

You first need to store the address in the address book or as an individual point of interest.

Then you can set the address data of the regarding address book entry or myPOIs entry (selectable via **Individual POIs**) as home address.

Travel guide

(only Navi 900)

Note

If data from the internal memory is used for navigation, the travel guide is only available for the regions saved.

Press the **DEST** button and then select **Travel guide**.

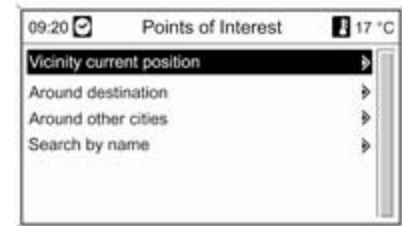

Various options for the selection of points of interest based on travel guide criteria (e.g. accommodation, sights, leisure etc.) are displayed.

Selecting a point of interest based on travel guide criteria: see the corresponding descriptions in „Selecting a point of interest“.

Tours

(only Navi 900)

A tour makes it possible to enter a series of destinations for driving to one after the other. This function is suitable for regular, repetitive tours so that it is not necessary to re-enter

individual destinations. Tours are saved using a name. A maximum of ten tours with 9 intermediate destinations can be saved. An existing tour can be changed by modifying the order of the destinations or by adding or deleting destinations.

Adding a tour



After selecting **New tour**, enter a name for the tour using the speller function ⇨ 67.

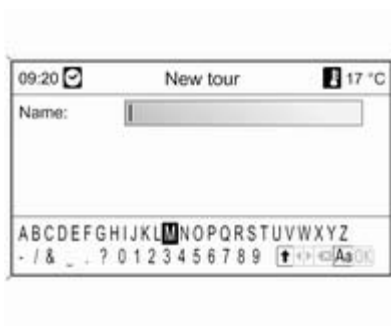

Accept the entered name using **OK**. The name is displayed on the **Tours** menu.

Adding intermediate destinations to the tour

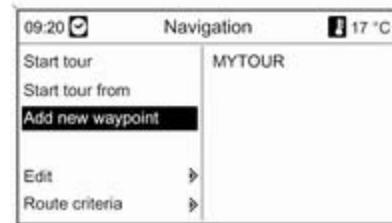

Select the new tour and then **Add new waypoint**.

In the submenu **Add waypoint** the following options for selecting/entering intermediate destinations are displayed:

- **Enter waypoint** (address entry)
- **Address book**
- **Last destinations**
- **Select from map**
- **Points of interest**

Select an option for destination input and then select/enter the desired intermediate destination ↷ 67.

A menu is displayed that shows the address data of the selected/entered intermediate destination.



After selecting **Add** a list with all previously added intermediate destinations is displayed.



By default new waypoints are added at the end of the list. If another position is desired turn the multifunction knob to select another insertion point.

Repeat the described procedure to add further intermediate destinations.

Starting a tour

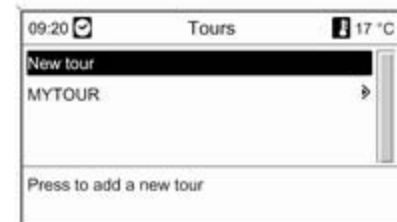

Select a tour in the **Tours** menu. The **Navigation** menu is displayed.

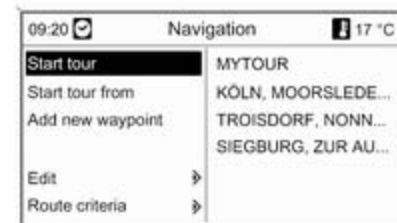

To start route guidance: select **Start tour**. All predefined intermediate destinations are taken into account for route calculation.

If you want to skip predefined intermediate destinations on the tour and start direct route guidance to a certain destination: select **Start tour from**. A list with all predefined intermediate destinations is displayed.



Select the desired next destination. A route is calculated that leads directly to the selected intermediate destination.

Editing a tour

Select a tour in the **Tours** menu and then select **Edit tour** to display a submenu with the following options:



Show tour

Displays a list with all intermediate destinations on the selected tour.

Move waypoints

Displays a list with all intermediate destinations on the selected tour.

Mark the intermediate destination to be moved.

Press the multifunction knob to cut out the marked destination.

To insert the cut out destination at the end of the list: press the multifunction knob again.

To insert the cut out destination before another destination: mark this destination and then press the multifunction knob.

Delete waypoints

Displays a list with all intermediate destinations on the selected tour.

Mark the desired intermediate destination and then press the multifunction knob.

Confirm the displayed message.

Delete tour

Deletes the currently selected tour entirely.

To execute deletion confirm the displayed message.

Edit name

The name of the currently selected tour can be edited using the speller function ⇨ 67.

Guidance

Press the **NAVI** button and then the multifunction knob to display the navigation main menu.

Depending on whether the route guidance is currently inactive or active, different menu options are available.

Functions with route guidance inactive

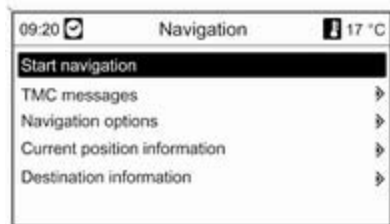

Start navigation

After selecting **Start navigation** the menu shown below is displayed.

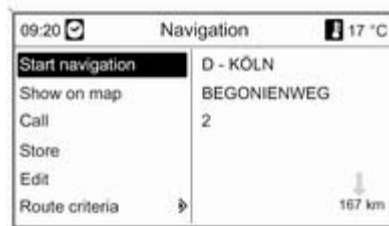

The following options are available:

- **Start navigation:** start route guidance to the displayed address.
- **Show on map:** show the location of the displayed address on the map.
- **Call:** if the address data includes a telephone number and a phone portal is available, the telephone number will be dialed.
- **Store:** store the displayed address in the address book or myPOIs memory, see "Storing an address in the address book or myPOIs memory" in section "Destination input" above.

- **Edit:** change/edit the displayed address, see "Editing or deleting a stored address" in section "Destination input" above.
- **Route criteria:** set/change criteria for route calculation, see "Navigation options" below.

TMC messages

Information on TMC, see section "Dynamic guidance" ⇨ 55.

Select **TMC messages** to display a list of all TMC traffic messages that are currently received.

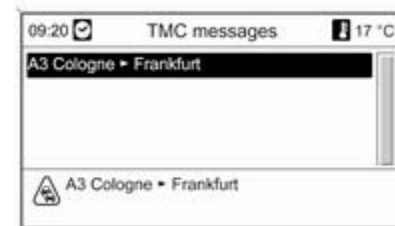

Select a TMC traffic message to display detailed information on the related traffic issue.

Navigation options

The corresponding menu provides options and a multitude of relating submenus for route guidance configuration.

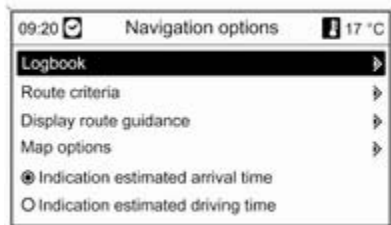

Logbook

(only Navi 900)

The logbook feature allows you to record each trip done with the vehicle.

Note

The logbook function of the Infotainment system meets no official legal requirements.

In case the logbook feature is currently activated (see "Logbook settings" below):

When you switch on the ignition the first time after inserting the ignition key, you are prompted by a message to determine the type of the upcoming trip:

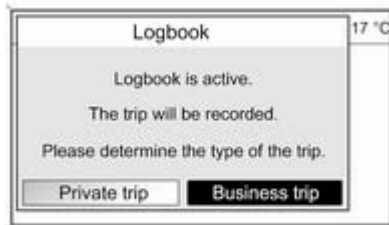

For each trip the following data will automatically be recorded:

- A unique serial number for the trip (for unambiguous labelling of trips).
- Start and destination position (geographic coordinates).
- Start and arrival time.
- Start and destination odometer reading.
- The determined type of the trip.
- An optional descriptive text (see "Logbook settings" below).

Start of a trip: is determined by inserting the ignition key and then switching on the ignition.

End of a trip: is determined by removing the ignition key (not by only switching off the ignition). As long as the ignition key is not removed, the system continues to record the current trip.

Data storage/export: the recorded trip/logbook data will be stored in the Infotainment system's memory. These data can be exported later at

any time to a USB drive connected to the USB port ⇨ 48 of the Infotainment system.

Logbook settings:

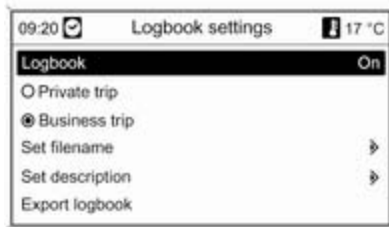

- **Logbook:** activates/deactivates the logbook feature.
- **Private trip / Business trip:** determines the type of an upcoming trip.
The selected type can be changed when starting a trip (see image of logbook message above), or at any time during a trip via this menu.
In the logbook data a private trip is indicated by a "0", a business trip by

a "1", see "Sample logbook data" below.

- **Set filename:** using the speller function (see section "Destination input") you can enter a base filename (max. 15 characters) for storing the logbook data on a USB drive.

The system will add "Logbook" in the beginning and the current date and time at the end of the base filename, e.g., "Logbook_myTrips_2011.09.23_09.45.txt".

- **Set description:** using the speller function, you can enter an optional descriptive text (max. 80 characters) that will be added to the logbook data of a trip, see "Sample logbook data" below.
The description will be added to the logbook data of each upcoming trip as long as the description is not changed.
If you enter/change a description during a trip, the description will be added to the logbook data of the current trip.

- **Export logbook:** exports all recorded trip data currently stored in the Infotainment system's memory to a USB drive connected to the USB port ⇨ 48 of the Infotainment system.

The data will be stored in a simple text file in the root directory of the USB drive.

Example: "F:

\\Logbook_myTrips_2011.09.23_09.45.txt"

- **Erase logbook:** erases all recorded trip data from the Infotainment system's memory.

Sample logbook data:

The following sample data represent a single recorded trip. The data is stored in the exported text file in a single line. The individual data items are separated by semicolons:

```
0000000023; N 52° 07' 01"; E 009° 53' 31"; 22.09.2011; 13:53; 013550; N 52° 07' 00"; E 009° 53' 00"; 22.09.2011; 14:47; 013580; 1; "My trip to XY Company (Project 77)"
```

Description of the individual data items:

- 0000000023 = serial number
- N 52° 07' 01"; E 009° 53' 31" = start position in geographic coordinates (Latitude; Longitude)
- 22.09.2011; 13:53 = start date; time
- 013550 = odometer reading at start position
- N 52° 07' 00"; E 009° 53' 00" = destination coordinates
- 22.09.2011; 14:47 = arrival date; time
- 013580 = odometer reading at destination
- 1 = business trip
- "My trip to ..." = optional descriptive text.

Route criteria

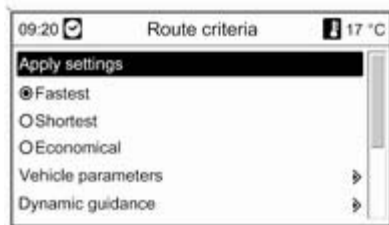

The calculation of the route can be controlled by various criteria.

Select one of the following criteria:

- **Fastest**
- **Shortest**
- **Economical**: an energy-optimized route is calculated, taking into account the vehicle-specific parameters that are currently set in the **Vehicle parameters** menu, see below.

Select **Vehicle parameters** to open a menu for the selection of vehicle-specific parameters.

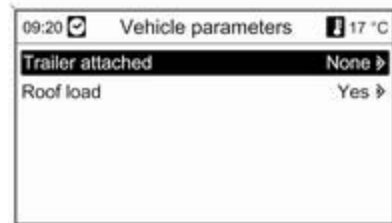

The selected settings will be taken into account for route calculation, if **Economical** is currently selected, see above.

After setting the desired vehicle parameters, press the **BACK** button to leave the menu.

Select **Dynamic guidance** to open a menu for the configuration of dynamic route guidance.

Information on dynamic route guidance, see section "Dynamic guidance" ↗ 93.

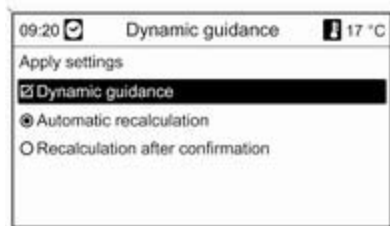

Select **Dynamic guidance** to activate/deactivate dynamic route guidance.

If dynamic route guidance is activated:

Select **Automatic recalibration** if you want the route be recalculated automatically when there are traffic problems.

Select **Recalculation after confirmation** if you want the route be recalculated only after confirming the corresponding message.

Select **Apply settings** to activate the displayed settings and to leave the menu.

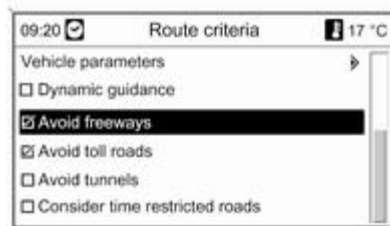

If desired select one or several of the following options in the **Route criteria** menu:

- **Avoid freeways**
- **Avoid toll roads**
- **Avoid tunnels**
- **Avoid ferries**
- **Consider time restricted roads**

Display route guidance

The following options are available for the display of route guidance:

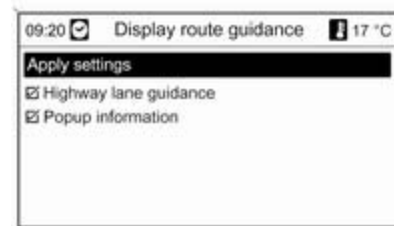

Using the **Highway lane guidance** option, you can determine which type of illustration should be displayed when reaching a highway intersection.

If **Highway lane guidance** is deactivated the following type of illustration will be displayed:



If **Highway lane guidance** is activated the following type of illustration will be displayed:



Using the **Popup information** option, you can select whether route guidance information from the navigation should be displayed in popup windows in other operating modes (e.g. radio). The information is hidden after a set time or by pressing the **BACK** button.

Select **Apply settings** to activate the displayed settings and to return to the **Navigation options** menu.

Map options

Select **Map options** and then **Map mode** to display the following submenu:

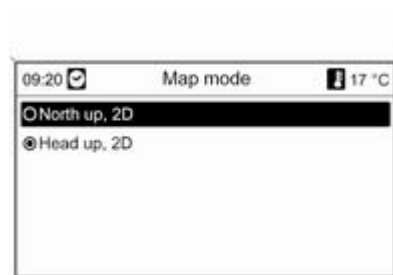

Select between map orientation north up and head up on the map display.

Select **Map options** and then **Show POIs on map** to open a submenu with various options to define whether and which points of interest should be displayed on the map.

When **User defined** is selected the type of points of interest can be defined that should be displayed, e.g. restaurant, hotel, public places, etc.

Display of arrival time or driving time

After selecting the option **Indication estimated driving time** or **Indication estimated arrival time** in the menu **Navigation options**, the corresponding time is shown in the top line on the route guidance screen.

Current position information

The following information on the current position is displayed:

- City
- Street name
- Latitude

- Longitude
- Map display



The current position can be copied to the address book or myPOIs memory using **Store**, see "Storing an address in the address book or myPOIs memory" in section "Destination input" above.

Destination information

Displayed information: same as on the display for **Current position**.

Functions for active route guidance

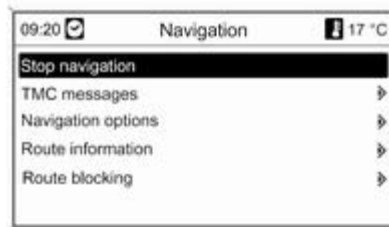

Stop navigation

After selecting **Stop navigation**, the route guidance is deactivated and the menu options for route guidance inactive are displayed, see "Functions with route guidance inactive" above.

TMC messages

Information on TMC, see section "Dynamic guidance" ↗ 55.

After selecting **TMC messages** the **Filtering** menu is displayed.

Select whether **All traffic messages** or only **Traffic messages along route** should be displayed in the **TMC messages** list, see below.

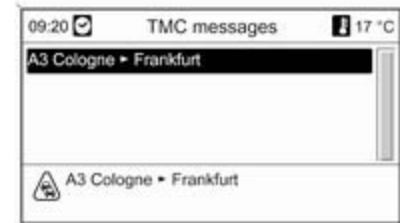

Navigation options

Description, see "Functions with route guidance inactive" above.

Route information

The following information can be accessed on the **Route information** menu:

- **Route list**
- **Current position information**

- Destination information

- Overview current route

Route list

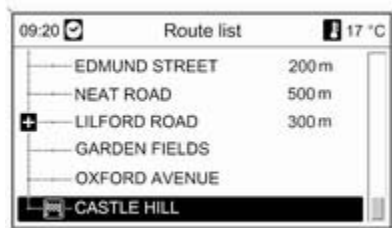

All streets on the calculated route are listed with the related distances.

Route list items marked with a "+" symbol can be expanded by selecting the related list item. After selection, further details on the related list item are displayed.

Current position information

Description, see "Functions with route guidance inactive" above.

Destination information

Description, see "Functions with route guidance inactive" above.

Overview current route

The following information on the current route is displayed:



- Position
- Destination
- Arrival time
- Distance
- Map display

Route blocking

The following options are available to manually exclude certain areas/route sections from the route guidance:

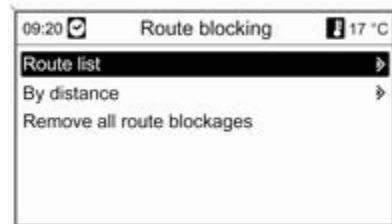
**Route list**

In the list of street names on the currently calculated route, streets can be excluded from the route guidance.

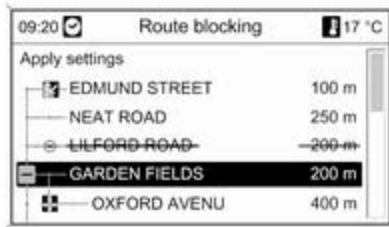

To exclude a street from the route guidance:

Mark the regarding street name and press the multifunction knob. The street name is displayed crossed-out.

If desired, exclude further streets from the route guidance.

Select **Apply settings** and confirm the displayed message.

The route is re-calculated, taking into account the excluded streets.

By distance

By setting a distance the section of route from the current position to the set distance can be excluded from the route guidance.

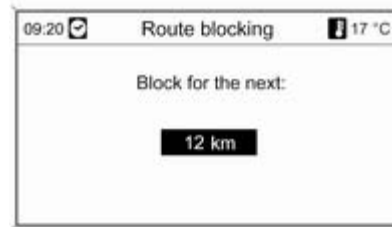

Set the desired distance, press the multifunction knob and then confirm the displayed message.

The route is re-calculated taking into account the excluded route section.

Note

The route blocking entered remains active until a new route calculation is performed.

Remove all route blockages

After selecting this option, all areas/ route sections previously selected as to be excluded from the route guidance will be taken into account again for route guidance.

Dynamic guidance

If dynamic route guidance is active, the entire current traffic situation that the Infotainment system receives via TMC is included in the calculation of the route. The route is suggested taking into account all traffic problems or restrictions as per pre-set criteria (e.g. „shortest route“, „avoid freeways“ etc.).

In the case of a traffic problem (e.g. traffic jam, closed road) on the route driven, a message is displayed and a voice message output indicating the nature of the problem. The driver can decide whether to drive around the traffic problem taking the suggested change to the route or to carry on through the traffic problem.

Nearby traffic problems are also reported if route guidance is not active.

If route guidance is active, the system continuously checks, based on the traffic information, whether it would be better to recalculate the route or take an alternative route taking into account the current traffic situation.

The activation and deactivation of dynamic route guidance, as well as criteria for the calculation of the route and other settings for navigation, are made in the **Navigation options** menu  85.

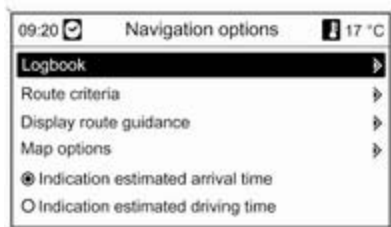

Dynamic route guidance only works if traffic information is received via the RDS-TMC traffic information system.

The possible delay due to a traffic problem calculated by the Infotainment system is based on data that the system receives via the RDS-TMC station currently set. The actual delay may be different to that calculated.

Maps

All map data required for use of the navigation system is stored on an SD card provided with the Infotainment system.

Map SD card

The SD card reader of the Infotainment system can only read the SD card provided specifically for use with the vehicle's navigation system. The SD card reader cannot read any other SD cards.

Due to production date of the map data on the SD card, some new roads may not be included, or some names

and roads may differ from those in use at the time the map data was produced.

To order additional SD cards or an update of the map data, contact a Vauxhall Authorised Repairer.

Replacing a map SD card, see below.

Important information on SD card handling

Caution

Never attempt to use an SD card that has been cracked, deformed or repaired using adhesive tape. Doing so may damage the equipment.

- Handle the SD card with care. Never touch the metal contacts.
- Do not use any conventional cleaner, benzine, thinner, or antistatic spray.
- If you need to clean the SD card, use a soft cloth.

- Do not bend the SD card. Do not use any SD card that is bent or cracked.
- Do not put any sticker or write anything on either surface.
- Do not store the SD card in locations exposed to direct sunlight, or in high temperatures or humidity.
- Always place the SD card in its storage case, when not in use.

Replacing a map SD card

The SD card slot is located in the centre console.

Removing the SD card



Press on the inserted SD card to unlock it, and then carefully pull the SD card out of the SD card slot.

Inserting the SD card



Push the SD card with the cut-out edge on the right side (see image above) carefully into the SD card slot until the card engages.

Note

The SD card and SD card slot must always be kept clean and dry.

Symbols overview



No. Explanation

- 1 Current position
- 2 Destination
- 3 not available
- 4 not available
- 5 not available
- 6 Fog
- 7 Road works
- 8 Slippery road
- 9 Smog
- 10 Snow
- 11 Storm

No. Explanation

- 12 Caution/warning
- 13 Closed road
- 14 Dense traffic
- 15 Traffic jam
- 16 Narrow lanes
- 17 Open list
- 18 Closed list
- 19 Shopping centre
- 20 Toll road
- 21 Tourist information

No. Explanation

- 22 Sight
- 23 Sport & leisure
- 24 Going out
- 25 Museum
- 26 Car rental
- 27 Travel information
- 28 Leisure activity
- 29 Provision of services
- 30 Cash machine
- 31 Bus station
- 32 Camp site



33



41



49



57



34



42



50



58



35



43



51



59



36



44



52



60



37



45



53



61



38



46



54



62



39



47



55



63



40



48



56

No.	Explanation
33	Chemist
34	Cinema
35	Airport
36	Amusement park
37	City
38	Bank
39	Traffic message
40	Ferry
41	Border
42	Tunnel
43	Kiosk
44	Grocery
45	Hotel/motel
46	Motorway exit
47	Car park
48	Park & ride
49	Multi-storey car park

No.	Explanation
50	Petrol station
51	Service area
52	Restaurant
53	WC
54	Historical monument
55	Hospital
56	Emergency
57	Police
58	Harbour
59	Mountain pass
60	Public place
61	Related to the car
62	Garage
63	Cemetery

Speech recognition

General information	100
Navigation control	101
Phone control	110

General information

The speech recognition of the Infotainment system enables you to operate various functions of the navigation system (only Navi 900; inclusive audio system features) and the phone portal via voice input. It recognises commands and numeric sequences independently of the relevant speaker. The commands and numeric sequences can be spoken without a voice pause between the individual words.

You can save destination addresses, radio stations and telephone numbers assigning a name of your choice (voice tag). Using these names, you can later set the destination address for an upcoming trip, select a radio station or set up a telephone connection.

In the event of incorrect operation or commands the speech recognition gives you visual and/or acoustic feedback and requests you to re-enter the desired command. Apart

from this, the speech recognition acknowledges important commands and will enquire if necessary.

To ensure that conversations inside the vehicle do not lead to unintentional triggering of system functions, the speech recognition does not start until it has been activated.

Important notes on language support

- Not all languages available for the display of the Infotainment system are also available for the speech recognition.
- Not all languages available for the speech recognition of the phone portal are also available for the speech recognition of the navigation system (inclusive audio system features).
- Speech recognition of the phone portal: if the currently selected language for the display is not supported by the speech recognition, you need to enter the voice commands in English.

To be able to enter voice commands in English, you first need to activate the phone main menu by pressing the **PHONE** button on the Infotainment system, and then activate the speech recognition of the phone portal by pressing the button  on the steering wheel.

- Speech recognition of the navigation system: if the currently selected language for the display is not supported by the speech recognition, speech recognition will not be available.

In such a case you need to select another language for the display if you want to control the Infotainment system via voice commands:

Press the **CONFIG** button, select the **Languages** menu item and then select, e.g. **English**.

As the English language is one of the languages supported by the speech recognition of the navigation system, speech recognition will then be available.

Note

If you change the language shown on the Infotainment system's display, all names currently assigned to preset stations and/or destination addresses will be deleted.

Navigation control

General information

The speech recognition of the navigation system (only Navi 900; inclusive audio system features) only works if a map SD card with speech recognition data is inserted  94.

Navigation-related voice commands are not available until the initial disclaimer message has been confirmed.

Activating speech recognition

Press the button  on the steering wheel.

The audio system mutes, a voice output message prompts you to say a command, and a help menu with the

most important commands currently available is shown on the display, see "Help menus" further below.

As soon as the speech recognition is ready for voice input, a beep is heard and the red coloured symbol in the upper right corner of the help menu changes to grey colour.

You can now say a voice command to directly initiate a system function (like playing a preset radio station), or to start a dialogue sequence with several dialogue steps (like entering a destination address), see "Operation via voice commands" further below.



After a dialogue sequence is finished, the speech recognition is deactivated automatically. To initiate another dialogue sequence, you need to activate the speech recognition again.

Adjusting the volume for voice output messages

Turn the volume knob on the Infotainment system, or press the + or – button on the steering wheel.

Canceling a dialogue sequence

There are various possibilities to deactivate the speech recognition and to cancel a dialogue sequence:

- Press the button  on the steering wheel or any button on the Infotainment system.
- Press and hold the button  on the steering wheel for a few seconds.
- Say "Cancel".

In the following situations a dialogue sequence is automatically cancelled:

- If you do not say any commands for some time (by default you are prompted three times to say a command).
- If you say commands that are not recognized by the system (by default you are prompted three times to say a correct command).

Breaking up a running voice output message

As an experienced user you can break up a running voice output message by (short) pressing the button  on the steering wheel.

Afterwards, the current dialogue sequence will be continued automatically.

Important notes on voice input

- If experiencing difficulty with the system recognizing a command, confirm that the command is correct. Try saying the command clearly or wait for a brief moment after the beep.
- Background noise such as a climate control fan positioned on high, open windows, and very loud outside noises, even if the windows are closed, can cause voice commands to be misunderstood
- The speech recognition only recognizes commands based on the language currently selected for the Infotainment display.

Visual and acoustic help

After activating speech recognition, you are guided through a dialogue sequence via help menus, voice output messages and on-screen messages.

Help menus

Dependent on the currently active mode of operation (radio, CD player, navigation etc.), a help menu with the most important available voice commands is displayed.

Example: Radio help menus

If the radio mode is currently active, the radio help menu (part 1) shown below is displayed.



As soon as you hear a beep and the symbol in the upper left corner of the help menu (see image above) has changed its colour from red to grey, you can say one of the following commands:

- One of the commands shown on the help menu.
- One of the additional commands available for the radio mode, see image below.

To display these additional commands say "**More help**". The radio help menu (part 2) shown below is displayed.

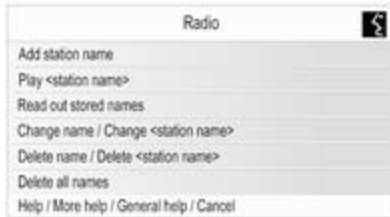

- One of the main commands for the speech recognition, see image below.

Example: General help menu (main commands)

The general help menu primarily shows the commands required to change to another mode of operation, e.g., to change from the radio mode to the CD player mode.

To display the general help menu, say "**General help**".

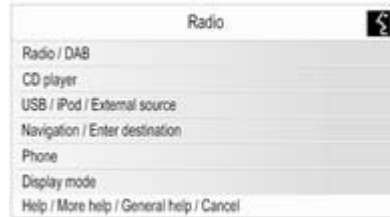

Important notes on commands

- Some command words displayed on the help menus are optional.
Example: when using the command "**Frequency <87.5..108.0> MHz**", you can leave out "**MHz**".

You can simply try out if there are shortened variants available for certain commands.

- For each command shown on the help menus various synonymous command variants are available.

Example: instead of saying "**Show station list**" you could also say "**Show stations**" or "**Display stations**".

You can simply try out if there are synonymous command variants available that suit you more than the displayed default variants.

- Slashes "/" separate several commands on a single help menu line. In some cases you need to combine command words on both sides of a slash.

Example: "**Start / Stop guidance**". In such case, you need to say, e.g., "**Start guidance**". "**Start**" on its own would not be a valid command.

- Pointed brackets "< ... >" indicate placeholder text.

Example: when you want to use the command "**Frequency**

<87.5..108.0>" , you need to exchange "<87.5..108.0>" for a specific figure between 87.5 and 108.0. You could say, e.g., "**Frequency 96 dot 3**".

Help messages

You can induce the system to read out all voice commands currently available.

After saying the command:

- "**Help**": the system reads out the most important commands available for the currently active mode of operation.
- "**More help**": the system reads out all additional commands available for the currently active mode of operation.
- "**General help**": the system reads out all main commands, see "Main help menu" above.

Lists with selectable items

During dialogue sequences you are often prompted to select an item (e.g. a preset radio station or a city name) from a list.

Example: Autostore lists



To select an item from such a list, you only need to say the number in front of the desired list item, e.g. "**5**".

In most cases there are several "pages" of list entries available. To switch from one "page" to another, you need to say "**Next**" or "**Previous**".

On each page the list items are numbered from "1." to "6." (no consecutive numbering).

On-screen messages and acoustic prompts / feedback

During dialogue sequences you are often prompted via on-screen messages (see image below) and voice output messages, which kind of command you need to say next.

Example: Storing a radio station using a name



If the radio mode is active and you say the command "**Add station name**", the on-screen message shown above will be displayed, and the voice output message "**Please say the station name.**" be announced by the system.

As soon as you hear a beep and the symbol in the upper left corner of the on-screen message (see image above) has changed its colour from red to grey, you can say the desired name.

After saying the name, the system gives you visual and acoustic feedback, stating whether the command could be successfully performed or not.

Operation via voice commands

Below you will find descriptions on various typical and/or important examples of dialogue sequences.

Dialogue sequences not described below function almost identical/very similar to the described ones.

Changing to another mode of operation

Situation: the CD player mode is currently active.

Action: the user wants to change to the radio mode.

User: activates speech recognition.

User: **"Radio"**.

System: **"Radio"**.

System: activates the radio mode.

To perform a certain radio function via speech control, the user needs to activate speech recognition again and then say the desired command, see examples below.

Examples on radio control

Situation: the radio mode is currently active.

Changing to another waveband

Action: the user wants to change from the AM to the FM waveband.

User: activates speech recognition.

User: **"FM"**.

System: changes to the FM waveband.

Selecting a station via frequency

Action: the user wants to change to another FM station via entering a frequency.

User: activates speech recognition.

User: **"Frequency 96 dot 3"**.

System: changes to the regarding frequency.

Selecting a preset station

Action: the user wants to select a station stored in the second autostore list (AS2).

User: activates speech recognition.

User: **"Autostore list"**.

System: displays the first autostore list (AS1).

User: **"Next"**.

System: displays the second autostore list (AS2).

User: **"3"**.

System: plays the third station stored in the list.

Assigning a name to a preset station

You can assign names to a maximum of 12 preset stations (stored in the autostore lists or favourite lists, see chapter "Radio").

To be able to assign a name to a preset station, the regarding station must currently be played and the autostore or favourite list where the station is stored in must be shown on the display.

After assigning a name to a station, you can select that station by simply saying the assigned name.

Action: the user wants to assign a name to the currently played (preset) station.

User: activates speech recognition.

User: **"Add station name"**.

System: **"Please say the station name."**

User: **"BBC 2"**.

The regarding station can be selected now at any time by simply saying the assigned name, see below.

Note

If you change the language shown on the Infotainment system's display, all names currently assigned to preset stations and/or destination addresses will be deleted.

Selecting a preset station via the assigned name

Note

If you use a name which was assigned to a station by another person, the name may not be recognized by the speech recognition because of the possibly very different voices and pronunciations.

User: activates speech recognition.

User: **"Play BBC 2"**.

System: plays the regarding station.

Examples on CD player control

Situation: an audio or MP3 CD is already inserted, the CD player mode is currently active.

Selecting an album on an MP3 CD

User: activates speech recognition.

User: **"Album list"**.

System: shows the list of albums on the MP3 CD (if albums available).

User: manually selects the desired album.

Selecting a track on an audio CD

User: activates speech recognition.

User: **"All tracks"**.

System: shows the list of tracks stored on the audio CD.

User: manually selects the desired track.

Alternatively, if you know the number of the desired track:

User: **"Track 14"** (or using single digits: **"Track" "1" "4"**).

System: plays the selected track.

Examples on navigation control

Situation: the navigation mode is currently active, route guidance is not active.

Changing route options

Action: the user wants to change the current settings of some route options for an upcoming trip.

User: activates speech recognition.

User: **"Route options"**.

System: shows the regarding help menu. The currently activated route options are indicated by check marks.



User: **"Economical"**.

User: **"Avoid toll roads"**.

User: **"Use ferries"**.

System: displays check marks next to the new settings.

User: **"Apply"**.

System: stores all changed route option settings.

Selecting a point of interest

Action: user wants to select a nearby petrol station as destination address.

User: activates speech recognition.

User: **"Enter destination"** (if enter destination menu not already active).

User: **"Points of interest"**.

System: shows a list with search options.

User: **"Nearby"**.

System: shows a list with points of interest categories.



User: **"2"**.

System: shows the navigation menu for petrol station search.

User: manually performs the further operating steps, see chapter "Navigation".

Entering an address

Action: user wants to enter the destination address for an upcoming trip.

User: activates speech recognition.

User: **"Enter destination"** (if enter destination menu not already active).

User: **"Enter address"**.

System: shows a menu for address input. The address data of the last calculated destination is used as basis for address input.



Note

The last calculated destination possibly has no valid address elements available that can be used as basis for address input via voice commands.

For example, not all points of interest stored on the map SD card or destinations picked from the map display (see chapter "Navigation") provide the required valid address data.

In such cases an empty or incompletely filled out menu for address input will be displayed.

Situation: the entire address data of the last calculated destination is available, the user needs to change only the street name and the house number to create the desired new destination address.

User: **"Street"**.

System: **"What is the name of the street?"**.

User: says the desired street name.

System: displays an alphabetically ordered list of street names that sound similar to the name the user said.

Note

If the list of street names does not contain the desired street name, you can say **"Spell"**. After a corresponding voice output message, you can then enter the street name by spelling it, e.g. "M" "A" "I" "N" "S" "T" "R" "E" "E" "T".

User: says the number of the line that contains the desired street name, e.g. **"4"**.

System: displays the selected street name on the menu for address input.

User: **"Number"**.

System: **"Which street number do you want to drive to?"**.

User: **"17"**.

System: displays the entered house number on the menu for address input.

User: the user can now say **"Start guidance"** to start route guidance to the displayed address, or say **"Store**

destination" to store the displayed address in the address book or myPOIs memory, see chapter "Navigation".

Address input for destinations in foreign countries

In case you want to enter the address of a destination located in a foreign country, you need to spell the desired city name and street name.

Example: the display language of the Infotainment system is currently set to English and you want to enter the name of a city located in Germany.

In such case the system prompts you to spell the city name.

If a language-specific special letter (e.g. "Ü" or "Ñ") is not available for the currently selected display language, you need to use the closest letter of the alphabet the currently selected display language provides (e.g. "U" or "N"). The match to the special letter will then be done automatically by the system. Hyphens or spaces need not to be entered/spelled.

Example: the language of the Infotainment system is set to English, **Country** is set to "GERMANY (D)", and you want to enter the city name "BAD MÜNDER".

When spelling the city name, you can omit the space and replace the special German letter "Ü" by an "U".

User: "**City**".

System: "**Please spell the city name.**".

User: "B" "A" "D" "M" "U" "N" "D" "E" "R".

System: displays a list with the best matches, e.g.:

"1. BAD MÜNDER"

"2. BAD MÜNSTER"

"3. ..." etc.

User: "**1**" (or "**Yes**").

System: sets **City** to BAD MÜNDER.

Assigning a name to a destination address

You can assign names to a maximum of 20 destination addresses stored in the address book.

Afterwards you can select one of these destination addresses by simply saying the assigned name.

User: manually selects an address in the address book, see section "Destination input" above.

System: displays the **Navigation** menu.

User: manually selects the **Edit** menu item.

System: displays the **Edit** menu.

User: manually selects the **Add name** menu item.

System: "**Please say the destination name.**".

User: can say an arbitrary name.

The regarding destination address can be selected now at any time by simply saying the assigned name: "**Navigate to <name>**".

Note

If you delete an address from the address book, a name (voice tag) possibly assigned to this address will also be deleted.

Note

If you change the language shown on the Infotainment system's display, all names currently assigned to preset stations and/or destination addresses will be deleted.

Examples on phone control

Examples on phone control via speech recognition, see section "Phone control".

General information

When you press the button  on the steering wheel, and the phone portal is currently active (any phone related menu is displayed), the speech recognition of the phone portal will be activated.

As long as the speech recognition of the phone portal is active, you cannot change to another mode of operation (e.g. radio mode) using a voice command.

You need to manually activate another mode of operation by using the corresponding button on the Infotainment system (e.g. the **RADIO** button) or the **SRC** (Source) button on the steering wheel.

Phone control

Activating speech recognition

To activate the speech recognition of the Phone portal, press the button  on the steering wheel. For the duration of the dialogue any active audio source is muted and any traffic news fade-in is cancelled.

Adjusting the volume for voice output

Turn the volume knob on the Infotainment system, or press the + or – button on the steering wheel.

Cancelling a dialogue

There are various possibilities of deactivating the speech recognition and cancelling the dialogue:

- Press the button  on the steering wheel.
- Say **"Cancel"**.
- Do not enter (say) any commands for some time.
- After the third unrecognised command.

Operation

With the aid of the speech recognition the mobile phone can be operated very conveniently via voice input. It is sufficient to activate the speech recognition and to enter (say) the desired command. After input of the command the Infotainment system guides you through the dialogue with appropriate questions and feedback to achieve the desired action.

Main commands

After activation of the speech recognition a short tone signals that the speech recognition is expecting input.

Main commands available:

- **"Dial"**
- **"Call"**
- **"Redialing"**
- **"Save"**
- **"Delete"**
- **"Directory"**
- **"Pair"**
- **"Select device"**
- **"Voice feedback"**

Commands that are frequently available

- **"Help"**: the dialogue is terminated and all commands available within the actual function are enumerated.
- **"Cancel"**: the speech recognition is deactivated.

- **"Yes"**: a suitable action is triggered depending on the context.
- **"No"**: a suitable action is triggered depending on the context.

Entering a telephone number

After the command **"Dial"** the speech recognition requests input of a number.

The telephone number must be spoken in your normal voice without any artificial pauses between the individual numbers.

Recognition works best, if a pause of at least half a second is made after every three to five digits. The Infotainment system then repeats the numbers recognised.

You can then enter further numbers or the following commands:

- **"Dial"**: the inputs are accepted.
- **"Delete"**: the number last entered or the block of numbers last entered is deleted.
- **"Plus"**: a preceding "+" is entered for a call abroad.

- **"Verify"**: the inputs are repeated by the voice output.
- **"Star"**: An asterisk "*" is entered.
- **"Hash"**: A hash "#" is entered.
- **"Help"**
- **"Cancel"**

The maximum length of the telephone number entered is 25 digits.

To be able to make a call abroad you can say the word "Plus" (+) at the beginning of your number. The plus allows you to call from any country without knowing the prefix for calls made abroad in that country. Then say the required country code.

Example of a dialogue

User: **"Dial"**

Voice output: **"Please, say the number to dial"**

User: **"Plus Four Nine"**

Voice output: **"Plus Four Nine"**

User: **"Seven Three One"**

Voice output: **"Seven Three One"**

User: **"One One Nine Nine"**

Voice output: **"One One Nine Nine"**

User: **"Dial"**

Voice output: **"The number is being dialled"**

Entering a name

Using the **"Call"** command a telephone number is entered that has been stored in the telephone book under a name (voice tag).

Commands available:

- **"Yes"**
- **"No"**
- **"Help"**
- **"Cancel"**

Example of a dialogue

User: **"Call"**

Voice output: **"Please, say the nametag to call"**

User: **<Name>**

Voice output: **"Do you want to call <Michael>?"**

User: **"Yes"**

Voice output: **"The number is being dialled"**

Starting a second call

A second call can be started during an active telephone call. To do so, press the button Ⓢ .

Commands available:

- **"Send"**: activate manual DTMF (touch-tone dialling), e.g. for voice mail or telephone banking.
- **"Send nametag"**: activate DTMF (touch-tone dialling) by entering a name (voice tag).
- **"Dial"**
- **"Call"**
- **"Redialing"**
- **"Help"**
- **"Cancel"**

Example of a dialogue

User: <if a telephone call is active: press the Ⓢ button>

User: **"Send"**

Voice output: **"Please, say the number to send."**

(for number input see the dialogue example for **Entering a telephone number**)

User: **"Send"**

Redialing

The number last dialled is redialled with the command **"Redialing"**.

Saving

With the command **"Save"** a telephone number is stored in the telephone book under a name (voice tag).

The name entered must be repeated once. The pitch and pronunciation must be as identical as possible for both name inputs, otherwise the speech recognition will reject the inputs.

A maximum of 50 voice tags can be stored in the telephone book.

Voice tags are speaker-dependent, i.e. only the person who recorded a voice tag can open it.

To avoid the start of the recording of a saved name from being cut off, a short pause should be left after an input request.

To be able to use the voice tag independently of the location, i.e. including other countries, all telephone numbers should be entered with a "plus" character and a country code.

Commands available:

- **"Save"**: the inputs are accepted.
- **"Verify"**: the last input is repeated.
- **"Help"**
- **"Cancel"**

Example of a dialogue

User: **"Save"**

Voice output: **"Please, say the number to save"**

(for number input see the dialogue example for **Entering a telephone number**)

User: **"Save"**

Voice output: **"Please, say the nametag to save"**

User: <Name>

Voice output: **"Please, repeat the nametag to confirm"**

User: <Name>

Voice output: "Saving the nametag"

Deleting

A previously saved voice tag is deleted with the command "Delete".

Commands available:

- "Yes"
- "No"
- "Help"
- "Cancel"

Listening to stored names

The voice output of all stored names (voice tags) is started with the command "Directory".

Commands available during voice output of the voice tags:

- "Call": the telephone number of the voice tag last read aloud is selected.
- "Delete": the entry of the voice tag last read aloud is deleted.

Saving a mobile phone to or deleting it from the device list

With the command "Pair" a mobile phone can be saved to or deleted from the device list of the Phone portal ↗ 119.

Commands available:

- "Add"
- "Delete"
- "Help"
- "Cancel"

Example of a dialogue

User: "Pair"

Voice output: "Do you want to add or delete a device?"

User: "Add"

Voice output: "Using the pair function in the external device, enter <1234> to pair."

Voice output: "Do you want to pair the device?"

User: "Yes"

Voice output: "The device is connected as the number <device_number>"

Selecting a mobile phone from the device list

Using the "Select device" command, a mobile phone can be selected in the device list for setting up a Bluetooth connection.

Example of a dialogue

User: "Select device"

Voice output: "Please, say a device number to select"

User: <device_number>

Voice output: "Do you want to select the device number <device_number>?"

User: "Yes"

Voice output: "Do you want to pair the device?"

User: "Yes"

Voice output: "One moment. The system searches for the selected device"

Voice output: "Device number <dev_num> is selected"

Voice feedback

Each voice input is answered or commented on by the Infotainment system by way of a voice output that is adapted to the situation.

To switch the voice output on or off, enter "**Voice feedback**" or press the button .

Phone

General information	115
Connection	117
Bluetooth connection	119
Emergency call	128
Operation	128
Mobile phones and CB radio equipment	134

General information

The Phone portal provides you with the possibility of having mobile phone conversations via a vehicle microphone and the vehicle loudspeakers as well as operating the most important mobile phone functions via the Infotainment system in the vehicle. To be able to use the Phone portal, the mobile phone has to be connected with it via Bluetooth.

The Phone portal can be operated optionally via the speech recognition system.

The mobile phone can be operated using an external vehicle antenna by inserting it into an adapter that is specific to the phone.

Not all Phone portal functions are supported by every mobile phone. The possible phone functions depend on the relevant mobile phone and network provider. You will find further information on this in the operating instructions for your mobile phone or you can enquire about them with your network provider.

Important information for operation and traffic safety

Warning

Mobile phones have effects on your environment. For this reason safety regulations and directions have been prepared. You should be familiar with the related directions before you use the telephone function.

⚠ Warning

Use of the hands-free facility while driving can be dangerous because your concentration is reduced when telephoning. Park your vehicle before you use the hands-free facility. Follow the stipulations of the country in which you find yourself at present.

Do not forget to follow the special regulations that apply in specific areas and always switch off the mobile phone if the use of mobile phones is prohibited, if interference is caused by the mobile phone or if dangerous situations can occur.

Bluetooth

The Phone portal supports Bluetooth Handsfree Profile V. 1.5 and is specified in accordance with the Bluetooth Special Interest Group (SIG).

You will find further information about the specification on the Internet at <http://www.bluetooth.com>. Additionally, the Phone portal supports SIM Access Profile (SAP).

EU R & TTE Compliance

CE 0700

Hereby, we declare that the **Bluetooth System Transceiver** is in compliance with the essential requirements and other relevant provisions of Directive 1999/5/EC.

Operating the speech recognition

Do not use the speech recognition in emergencies, because in stress situations your voice can change so much that it can no longer be recognised sufficiently to set up the desired connection quickly enough.

Base plate for the telephone specific adapter

Keep the contacts of the base plate free from dust and dirt.

Recharging the phone battery

The phone battery is recharged as soon as the Phone portal is switched on and the phone is inserted into the telephone specific adapter.

Control elements

The most important telephone specific control elements are as follows:

PHONE button: opens the telephone main menu.

Controls on steering wheel:

☎, 🗨: take call, activate speech recognition.

📞, 🚫: end/reject call, deactivate speech recognition.

The Phone portal can be operated optionally via speech recognition ⇨ 100.

Connection

The Phone portal switches itself on and off via the ignition. When the ignition is turned off you can turn the Phone portal on and off via the Infotainment system.

A connection can be set up between the mobile phone and the Phone portal via Bluetooth. For this purpose your mobile phone must support Bluetooth.

To be able to set up a Bluetooth connection the Phone portal must be switched on and Bluetooth must be activated.

For information on the Bluetooth function of your mobile phone please refer to the operating instructions for the mobile phone.

Telephone specific adapters

If you are using a telephone specific adapter, the mobile phone is operated via the external antenna. The adapter also serves as a charging station.

Use only adapters that are approved for your vehicle and your mobile phone.

Mobile phones with connection interface on the bottom edge Installing the adapter

Fasten the adapter to the base plate.

Make sure that the contacts are correctly connected.



First, lower the front side of the adapter as shown in the above figure.

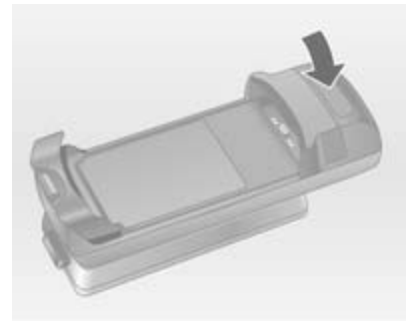

Then lower the back side.

An engaging sound must be audible when the adapter is fastened.

To remove, press the unlocking button on the base plate and lift the back side of the adapter.

Inserting the mobile phone

Insert the mobile phone into the adapter. Make sure that the contacts are correctly connected.



Lower the bottom edge first, as shown in the above figure.

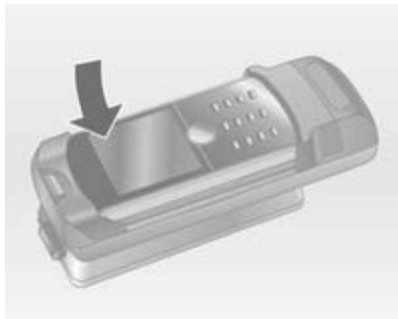

Then lower the top edge. An engaging sound must be audible when the mobile phone engages.

To remove, press the unlocking button on the adapter and lift the top edge of the phone first.

Mobile phones with connection interface on the lateral edge Installing the adapter

Fasten the adapter to the base plate. Make sure that the contacts are correctly connected.

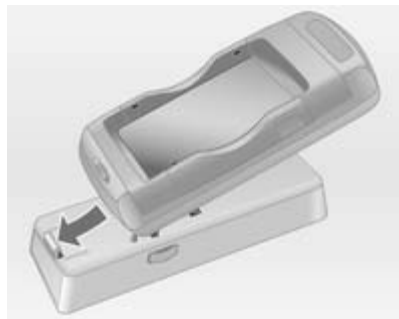

First, lower the front side of the adapter as shown in the above figure.



Then lower the back side.

An engaging sound must be audible when the adapter engages.

To remove, simultaneously press the unlocking buttons on both sides of the base plate.

Inserting the mobile phone

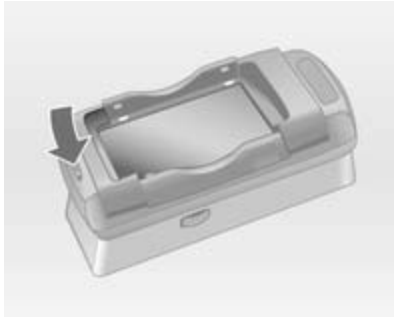

If the side brackets on the adapter are in the closed position, press the button near the front edge of the adapter to open the brackets.



With side brackets of the adapter opened, vertically lower the mobile phone into the adapter as shown in the above figure until the side brackets snap in.

An engaging sound must be audible when the mobile phone engages.

To remove the mobile phone, press the unlocking button on the adapter and lift the mobile phone.

Bluetooth connection

Bluetooth is a radio standard for the wireless connection of, for example, a telephone with other devices.

Information such as a telephone book, call lists, the network operator's name and field strength can be transferred. The functionality can be restricted depending on the telephone type.

To be able to set up a Bluetooth connection with the Phone portal, the Bluetooth function of the mobile phone has to be activated and the mobile phone has to be set to "visible". For further information please refer to the operating instructions for the mobile phone.

Navi 600 / Navi 900

Bluetooth menu

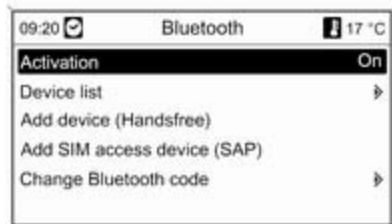

Press **CONFIG** button.

Select **Phone settings** and then **Bluetooth**.

Activating Bluetooth

If the Bluetooth function of the Phone portal is deactivated:

Set **Activation** to **On** and confirm the subsequent message.

Device list

When a mobile phone is connected to the Phone portal via Bluetooth for the first time, the mobile phone is saved in the device list.

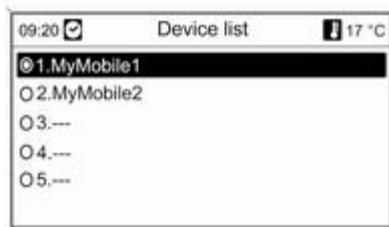

A maximum of 5 mobile phones can be saved in the device list.

Connecting a mobile phone for the first time

There are two options for connecting a mobile phone to the Phone portal: by adding it as a handsfree device or by using the SIM Access Profile (SAP).

Handsfree mode

When the mobile phone is added as a handsfree device the user can make or receive calls and use other functions via the Phone portal. The range of functions available depends on the mobile phone. While it is connected with the Phone portal the mobile phone can be operated as usual.

Note that the mobile phone battery may discharge at a higher speed than usual due to the Bluetooth connection active along with normal operation of the mobile phone.

SAP mode

When using the SAP option, a wider range of functions is available via the Phone portal such as various security and messaging options. The actual range of functions depends on the network provider. Additionally, in the SAP mode the mobile phone is in the standby mode. Only the Bluetooth connection and the SIM card are active, which leads to lower energy consumption of the connected mobile phone.

Connecting a mobile phone as a handsfree device



Select **Add device (Handsfree)**. The Bluetooth code to be entered into the mobile phone is displayed.

The Phone portal can now be detected by other Bluetooth devices.

As soon as the mobile phone has detected the Phone portal the Bluetooth code can be entered on the mobile phone.



As soon as the Phone portal has detected the mobile phone, the connection set-up can be confirmed.

The mobile phone is adopted in the device list and can be operated via the Phone portal.

Changing the Bluetooth code (only relevant for handsfree mode)

The first time a Bluetooth connection to the Phone portal is set up, a default code is displayed. This default code can be changed at any time. For security reasons a four-digit and randomly selected code must be used for pairing devices.

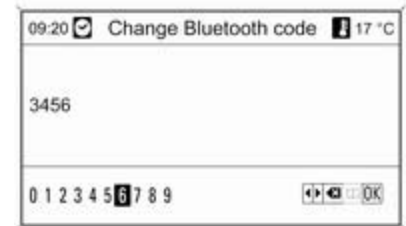

Select **Change Bluetooth code**. On the menu displayed, edit the actual Bluetooth code and accept the modified code using **OK**.

Connecting a mobile phone via SIM Access Profile (SAP)

Select **Add SIM access device (SAP)**. The mobile portal scans for available devices and displays a list of devices found.

Note

The mobile phone must have Bluetooth activated and be set to visible.

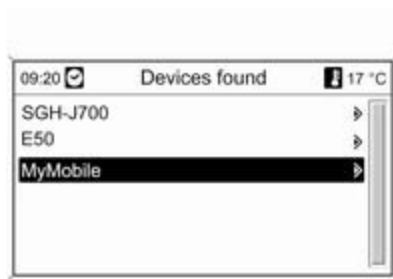

Select the desired mobile phone from the list. The SAP passcode prompt is shown on the Infotainment display containing a 16-digit code.



Enter the displayed SAP passcode in the mobile phone (without spaces). The mobile phone PIN code is shown on the Infotainment display.

If the **PIN request** function is active, the user will have to enter the PIN code of the SIM card in the mobile phone.

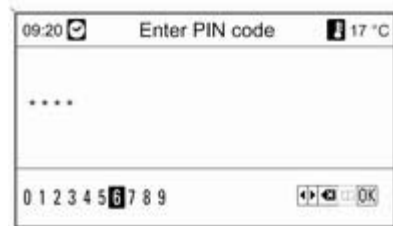

Enter the PIN code of the mobile phone SIM. The mobile phone is paired with the Phone portal. Services of the mobile network provider can be used via the Phone portal.

Connecting a mobile phone saved in the device list

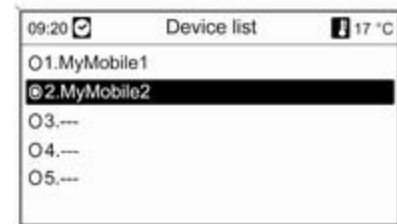

Select the desired mobile phone and then select the option **Select** in the menu displayed.

As soon as the Phone portal has detected the mobile phone, the connection setup can be confirmed.

The mobile phone can be operated via the Phone portal.

Removing a mobile phone from the device list

Select the desired mobile phone from the device list. In the menu displayed select **Delete** and confirm the subsequent message.

Adjusting the ring tone

To change the ring tone characteristic:

Press **CONFIG** button.

Select **Phone settings** and then **Ringtone**.

Select the desired option.

To change the ring tone volume:

While the phone rings turn the \odot knob of the Infotainment system or press the buttons **+ / -** on the steering wheel.

Setting up a connected phone

Various mobile phone settings can be configured in the **Phone settings** menu, if the phone is connected via SAP.

Changing security settings

Press **CONFIG** button.

Select **Phone settings** and then **Security**.

The security dialogue is displayed.

Activating/Deactivating PIN request

Select **PIN request On** or **Off**.

Enter the PIN code of the mobile phone SIM card and confirm.

Note

This option depends on the individual network provider.

Changing the PIN code

Select **Change PIN**.

Enter the current PIN code. Enter the new PIN code. Repeat the new PIN code and confirm. The PIN has been changed.

Configuring network services

Select **Phone settings** and then **Network services**. The Network services dialogue is displayed.

Depending on the network provider and the mobile phone several options are available.

- **Network selection:** choose between automatic or manual network selection.
- **Call waiting:** activate or deactivate call waiting.

- **Call diverting:** select diverting options depending on the situation.
- **Call barring:** configure call barring options depending on the situation.

For details on network services configuration refer to the mobile phone manual or enquire with the mobile network provider.

Configuring SMS centre number

The SMS centre number is a phone number that acts as a gateway for transferring SMS messages between mobile phones. This number is usually preset by the network provider.

To configure the SMS centre number select **Phone settings** and then **SMS center number**. If required, modify the SMS centre number.

Resetting the mobile phone to factory settings

Select **Phone settings** and then **Factory settings**.

CD 300 / CD 400

Bluetooth menu

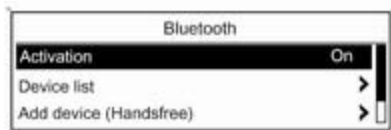

Press the **CONFIG** button.

Select **Phone settings** and then **Bluetooth**.

Activating Bluetooth

If the Bluetooth function of the Phone portal is deactivated: set **Activation** to **On** and confirm the subsequent message.

Device list

When a mobile phone is connected to the Phone portal via Bluetooth for the first time, the mobile phone is stored in the device list.

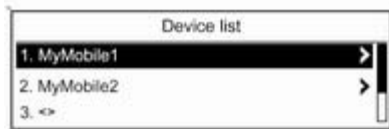

A maximum of 5 mobile phones can be stored in the device list.

Connecting a mobile phone for the first time

There are two options for connecting a mobile phone to the Phone portal: by adding it as a handsfree device or by using the SIM Access Profile (SAP).

Handsfree mode

When the mobile phone is added as a handsfree device the user can make or receive calls and use other functions via the Phone portal. The range of functions available depends on the mobile phone. While it is connected with the Phone portal the mobile phone can be operated as usual. Note that the mobile phone battery may discharge at a higher speed than usual due to the Bluetooth connection active along with normal operation of the mobile phone.

SAP mode

When using the SAP option, a wider range of functions is available via the Phone portal such as various security and messaging options. The actual range of functions depends on the network provider. Additionally, in the SAP mode the mobile phone is in the standby mode. Only the Bluetooth connection and the SIM card are active, which leads to lower energy consumption of the connected mobile phone.

Connecting a mobile phone as a handsfree device

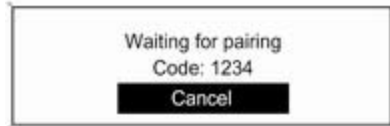

Select **Add device (Handsfree)**. The Bluetooth code to be entered into the mobile phone is displayed.

The Phone portal can now be detected by other Bluetooth devices.

As soon as the mobile phone has detected the Phone portal the Bluetooth code can be entered into the mobile phone.

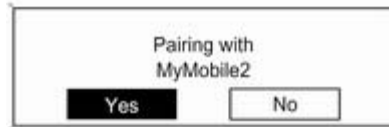

As soon as the Phone portal has detected the mobile phone, the connection set-up can be confirmed. The mobile phone is adopted in the device list and can be operated via the Phone portal.

Changing the Bluetooth code (only relevant for handsfree mode)

The first time a Bluetooth connection to the Phone portal is set up, a default code is displayed. This default code can be changed at any time. For security reasons a four-digit and randomly selected code must be used for pairing devices.

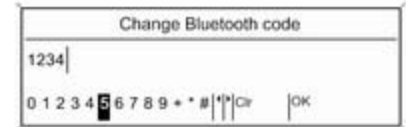

Select **Change Bluetooth code**. On the menu displayed, edit the actual Bluetooth code and accept the modified code using **OK**.

Connecting a mobile phone via SIM Access Profile (SAP) (only CD 400)

Select **Add SIM access device**.

The Phone portal scans for available devices and displays a list of devices found.

Note

The mobile phone must have Bluetooth activated and be set to visible.

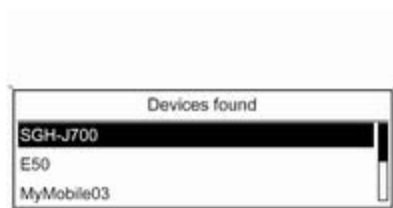

Enter the displayed SAP passcode in the mobile phone (without spaces). The mobile phone PIN code is shown on the Infotainment display.

If the **PIN request** function is active, the user will have to enter the PIN code of the SIM card in the mobile phone.

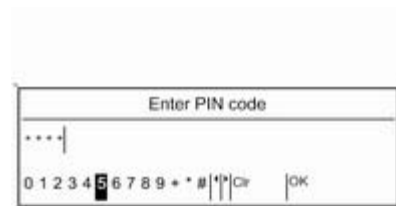

Enter the PIN code of the mobile phone SIM. The mobile phone is paired with the Phone portal. Services of the mobile network provider can be used via the Phone portal.

Connecting a mobile phone saved in the device list

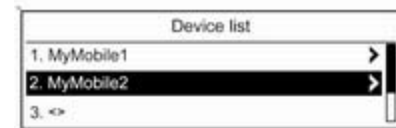

Select the desired mobile phone from the list. The SAP passcode prompt is shown on the Infotainment display containing a 16-digit code.



Select the desired mobile phone and then select the option **Select** in the menu displayed.

As soon as the Phone portal has detected the mobile phone, the connection setup can be confirmed.

The mobile phone can be operated via the Phone portal.

Removing mobile phone from device list

Select the desired mobile phone from the device list. In the menu displayed select **Delete** and confirm the subsequent message.

Adjusting the ring tone

To change the ring tone characteristic:

Press **CONFIG** button.

Select **Phone settings** and then **Ring tone**.

Select the desired option.

To change the ring tone volume:

While the phone rings turn the \odot knob of the Infotainment system or press the buttons **+ / -** on the steering wheel.

Setting up a connected phone

Various mobile phone settings can be configured in the **Phone settings** menu, if the phone is connected via SAP.

Changing security settings

Press **CONFIG** button.

Select **Phone settings** and then **Security**.

The security dialogue is displayed.

Activating/Deactivating PIN request

Select **PIN request On** or **Off**.

Enter the PIN code of the mobile phone SIM card and confirm.

Note

This option depends on the individual network provider.

Changing the PIN code

Select **Change PIN**.

Enter the current PIN code. Enter the new PIN code. Repeat the new PIN code and confirm. The PIN has been changed.

Configuring network services

Select **Phone settings** and then **Network services**. The Network services dialogue is displayed.

Depending on the network provider and mobile phone there are several options available.

- **Network selection:** choose between automatic or manual network selection.
- **Call waiting:** activate or deactivate call waiting.

- **Call diverting:** select diverting options depending on the situation.
- **Call barring:** configure call barring options depending on the situation.

For details on network services configuration refer to the mobile phone manual or enquire with the mobile network provider.

Configuring SMS centre number

The SMS centre number is a phone number that acts as a gateway for transferring SMS messages between mobile phones. This number is usually preset by the network provider.

To configure the SMS centre number select **Phone settings** and then **SMS centre number**. If required, modify the SMS centre number.

Resetting the mobile phone to factory settings

Select **Phone settings** and then **Restore factory settings**.

Emergency call

⚠ Warning

Connection setup cannot be guaranteed in all situations. For this reason you should not rely exclusively on a mobile phone when a vitally important communication (e. g. a medical emergency) is concerned.

In some networks it may be necessary for a valid SIM card to be properly inserted in the mobile phone.

⚠ Warning

Bear in mind that you can make and receive calls with the mobile phone, if it is in a service area with a sufficiently strong signal. Under certain circumstances emergency calls cannot be made on all mobile phone networks; it is possible that they cannot be made when certain network services and/or telephone functions are active. You can enquire about this with the local network operators.

The emergency call number can differ depending on the region and country. Please enquire beforehand about the correct emergency call number for the relevant region.

Making an emergency call

Dial the emergency call number (e.g. **112**).

The telephone connection to the emergency call centre is set up.

Answer when the service personnel questions you about the emergency.

⚠ Warning

Do not end the call until you are requested to do so by the emergency call centre.

Operation

Introduction

As soon as a connection via Bluetooth has been set up between your mobile phone and the Infotainment system, you can also operate many functions of your mobile phone via the Infotainment system.

Via the Infotainment system, you can, e.g., set up a connection to the telephone numbers stored in your mobile phone or change the telephone numbers.

Note

In the handsfree mode mobile phone operation continues to be possible, e. g. taking a call or adjusting the volume.

After setup of a connection between the mobile phone and the Infotainment system the mobile phone data is transmitted to the Infotainment system. This can take some time depending on the phone model. During this period operation of the mobile phone is possible via the Infotainment system only to a limited extent.

Not every telephone supports all functions of the Phone portal. Therefore deviations from the range of functions described with these specific telephones are possible. For further information please refer to the instructions for the telephone specific adapter.

Navi 600 / Navi 900**Setting the volume for hands-free facility**

Turn the  knob of the Infotainment system or press the buttons + / - on the steering wheel.

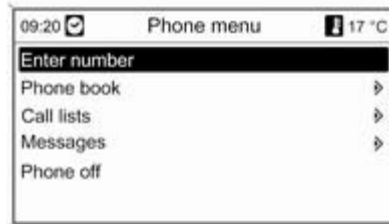
Dialling a telephone number

With the telephone main menu active, press the multifunction knob to open the **Phone menu**.

Several options for dialling telephone numbers, for using the phone book and call lists, for viewing and editing messages are available.

Using the **Phone off** command the connected phone can be detached from the Phone portal.

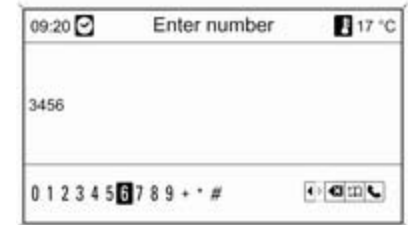
Entering a number manually

Select **Enter number**, then enter the desired number sequence.

To start the dialling process, select .

To open the telephone book menu, select .

Telephone book

After setting up the connection the telephone book is compared with the telephone book in the temporary memory, provided that the same SIM

card or same telephone is concerned. During this period any newly added entries are not displayed.

If the SIM card or telephone are different, the telephone book is reloaded. This process can take a few minutes depending on the phone model.

Selecting a telephone number from the telephone book

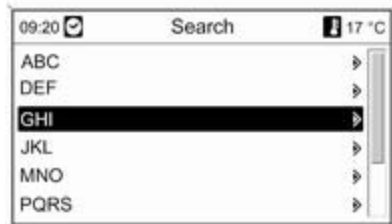

Select **Phone book**.

On the **Search** menu displayed, select the desired first letter range to start a preselection of the telephone book entries that you want to have displayed.

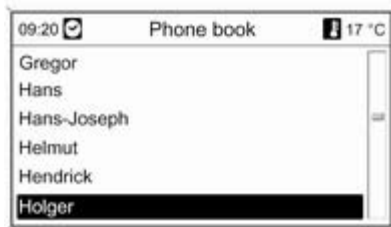

Note

Telephone book entries are carried over as they are transferred from the mobile phone. The presentation and order of the telephone book entries may be different on the Infotainment system's display and the mobile phone's display.

After having performed the preselection: select the desired entry in the telephone book to display the numbers saved under this entry.

Select the desired number to start the dialling process.

Call lists

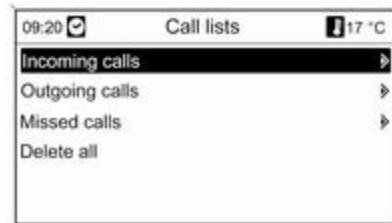

Via the menu **Call lists** the incoming, outgoing and missed calls can be viewed and the relevant numbers can be dialled. The lists can also be deleted in this menu.

To start a dialling process: select the desired call list, an entry in the call list and finally the desired telephone number.

Messaging functions

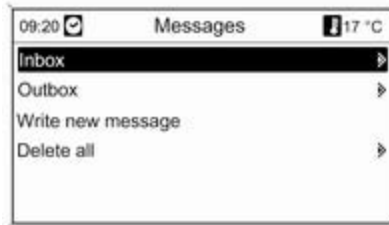

When the mobile phone is paired using the SAP mode, messages can be viewed, composed and sent via the Phone portal. The messages can also be deleted in this menu.

To view received messages: select **Inbox**.

To view sent messages: select **Outbox**.

To compose a message: select **Write new message**.

Note

Messages are limited to 70 characters.

Incoming call

When there is an incoming call a menu is displayed for you to accept or decline the telephone call.

Select the required option.

Functions during a telephone call

If you are currently making a telephone call, press the multifunction knob to open a submenu.

Various options are available depending on the situation and range of functions of the mobile phone:

- **Hang up:** disconnect the telephone connection.
- **Call number:** enter a telephone number to make a second telephone call or perform DTMF (touch-tone dialling), e.g. for voice mail or telephone banking.

- **Detach call:** detach the connection to a conference participant in a telephone conference.
- **Merge calls:** merge two calls when there are several active calls.
- **Switch calls:** switch between calls, if there are several calls.
- **Mute call:** mute a call.

Note

If the ignition is turned off during a telephone call the connection remains active until the telephone call is terminated.

CD 300 / CD 400

Setting the volume for hands-free facility

Turn the \odot knob of the Infotainment system or press the buttons + / - on the steering wheel.

Dialling a telephone number



With the telephone main menu active, press the multifunction knob to open the phone operation menu.

Several options for dialling telephone numbers, for using the phone book and call lists, for viewing and editing messages are available.

Using the **Phone off** command the connected phone can be detached from the Phone portal.

Entering a number manually

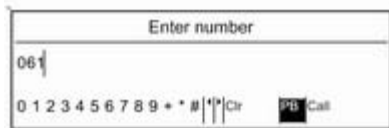

Select **Enter number** and then enter the desired number sequence.

Select **Call** to start the dialling process.

You can switch to the telephone book menu by selecting **PB**.

Telephone book

After setting up the connection the telephone book is compared with the telephone book in the temporary memory, provided that the same SIM card or same telephone is concerned. During this period any newly added entries are not displayed.

If the SIM card or telephone are different, the telephone book is reloaded. This process can take a few minutes depending on the phone model.

Selecting a telephone number from the telephone book

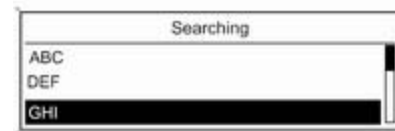

Select **Phone book**. In the displayed menu select the desired first letter range to start a preselection of the telephone book entries that you want to have displayed.

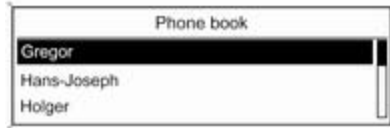

Note

Telephone book entries are carried over as they are transferred from the mobile phone. The presentation and order of the telephone book entries may be different on the Infotainment system's display and the mobile phone's display.

After having performed the preselection: select the desired entry in the telephone book to display the numbers saved under this entry.

Select the desired number to start the dialling process.

Call lists

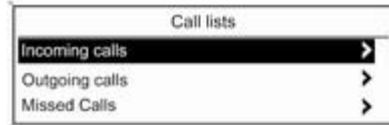

Via the menu **Call lists** the user can view incoming, outgoing and missed calls and dial the relevant numbers. To start a dialling process: select the desired call list, an entry in the call list and finally the desired telephone number.

Messaging functions (only CD 400)

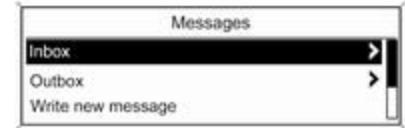

When the mobile phone is paired using the SAP mode, the user can view, compose and send messages via the Phone portal. The messages can also be deleted in this menu.

To view received messages: select **Inbox**.

To view sent messages: select **Outbox**.

To compose a message: select **Write new message**.

Note

Messages are limited to 70 characters.

Incoming call

When there is an incoming call a menu is displayed to accept or decline the telephone call.

Select required option.

Functions during a telephone call

If you currently have a telephone call, press the multifunction knob to open a submenu.

Various options are available depending on the situation and range of functions of the mobile phone:

- **Hang up:** disconnect the telephone connection.
- **Call number:** enter a telephone number to make a second telephone call or perform DTMF (touch-tone dialling), e.g. for voice mail or telephone banking.
- **Detach call:** detach the connection to a conference participant in a telephone conference.
- **Merge calls:** merge two calls when there are several active calls.

- **Switch calls:** switch between calls, if there are several calls.
- **Mute call:** mute a call.

Mobile phones and CB radio equipment

Installation instructions and operating guidelines

The vehicle specific installation instructions and the operating guidelines of the mobile phone and handsfree manufacturer must be observed when installing and operating a mobile telephone. Failure to do so could invalidate the vehicle type approval (EU directive 95/54/EC).

Recommendations for fault-free operation:

- Professionally installed exterior antenna to obtain the maximum range possible,
- Maximum transmission power 10 watts,

- Installation of the phone in a suitable spot, consider relevant Note in the Owner's Manual, section **Airbag system**.

Seek advice on predetermined installation points for the external antenna or equipment holder and ways of using devices with a transmission power exceeding 10 watts.

Use of a handsfree attachment without external antenna with mobile telephone standards GSM 900/1800/1900 and UMTS is only permitted if the maximum transmission power of the mobile telephone is 2 watts for GSM 900 or 1 watt for the other types.

For reasons of safety, do not use the phone while driving. Even use of a handsfree set can be a distraction while driving.

⚠ Warning

Operation of radio equipment and mobile telephones which fail to meet above mentioned mobile telephone standards is only permitted using an antenna located outside of the vehicle.

Caution

Mobile telephones and radio equipment may lead to malfunctions in the vehicle electronics when operated inside the vehicle with no exterior antenna, unless the above mentioned regulations are observed.

Index

- | | | | |
|------------------------------------|----------|---------------------------------|---------------------------------|
| A | | Digital audio broadcasting..... | 37 |
| Activating CD player..... | 42 | Dynamic guidance..... | 93 |
| Activating speech recognition.... | | E | |
| | 101, 110 | Emergency call..... | 128 |
| Activating the navigation system.. | 56 | Enhanced Other Networks..... | 33 |
| Activating the radio..... | 24 | EON..... | 33 |
| Address book..... | 67 | F | |
| Address input..... | 67 | Favourite lists..... | 26 |
| Autostore lists..... | 25 | G | |
| B | | General information..... | |
| BACK button..... | 13 | | 2, 40, 46, 48, 52, 55, 100, 115 |
| Basic operation..... | 13 | Guidance | 85 |
| Bluetooth..... | 115 | H | |
| Bluetooth connection..... | 119 | Handsfree mode..... | 119 |
| C | | Home address..... | 56 |
| CD player | | I | |
| activating..... | 42 | Individual POIs..... | 56 |
| important information..... | 40 | Infotainment system | |
| usage..... | 42 | maximum startup volume..... | 21 |
| Configuring DAB..... | 37 | personalisation..... | 23 |
| Configuring RDS..... | 33 | speed dependent volume..... | 21 |
| Connection..... | 117 | tone settings..... | 18 |
| Control elements overview..... | 4 | volume of the traffic | |
| D | | announcements..... | 21 |
| DAB..... | 37 | volume settings..... | 21 |
| Destination input | 67 | | |

M			
Maps	94	map SD card.....	94
Map SD card		myPOIs.....	67
handling.....	94	myPOIs announcement.....	56
replace.....	94	navigation display.....	56
Menu operation.....	13	navigation options.....	85
Mobile phone adapter.....	117	navigation volume.....	56
Mobile phones and CB radio		Points of Interest.....	67
equipment	134	repeat last navigation message	85
Multifunction knob.....	13	route blocking.....	85
Mute.....	11	route guidance.....	85
myPOIs.....	67	route list.....	85
myPOIs announcement.....	56	start navigation.....	85
N		symbols overview.....	96
Navigation		TMC messages.....	85
activating.....	56	usage.....	56
Address book.....	67	using the speller function.....	67
control elements.....	56	Navigation control.....	101
deleting Home address.....	56	Navigation display.....	56
deleting imported POIs.....	56	Navigation volume.....	56
destination input.....	67	O	
dynamic guidance.....	85, 93	Operation.....	128
fuel level low alert.....	67	P	
functioning.....	55	Personalisation.....	23
highway lane guidance.....	85	Phone	
Home address.....	67	adjusting ring tones.....	119
importing/exporting POIs.....	56	Bluetooth.....	115
Logbook.....	85	Bluetooth connection.....	119
		call lists.....	128
		control elements.....	115
		dialling a number.....	128
		emergency calls.....	128
		functions during a call.....	128
		handsfree mode.....	119
		important information.....	115
		messaging functions.....	128
		recharging the battery.....	115
		setting the volume.....	128
		SIM Access Profile (SAP).....	119
		telephone book.....	128
		telephone specific adapter.....	117
		Phone adapter.....	117
		Phone control.....	110
		Playing saved audio files.....	49
		R	
		Radio	
		Radio data system (RDS).....	33
		activating.....	24
		autostore lists.....	25
		Digital audio broadcasting	
		(DAB).....	37
		favourite lists.....	26
		selecting the waveband.....	24
		station lists.....	28
		station search.....	24
		usage.....	24
		waveband menus.....	28
		Radio data system (RDS)	33

RDS.....	33
Recharging the phone battery....	115
Regionalization.....	33
Retrieving stations.....	25, 26
Route guidance.....	85, 93

S

SAP mode.....	119
SD card.....	94
Selecting the waveband.....	24
Setting the navigation volume....	56
Setting the volume.....	11
SIM Access Profile (SAP).....	119
Speech recognition.....	100, 101, 110
activating.....	101, 110
adjusting volume.....	101
navigation/audio control.....	101
phone control.....	110
usage.....	101, 110
volume for voice output.....	110
Speed compensated volume.....	11
Speller function.....	67
Starting CD replay.....	42
Station search.....	24
Storing stations.....	25, 26
Switching the Infotainment system on or off.....	11
Switching the radio on.....	24
Symbols overview	96

T

Telephone specific adapter.....	117
Theft-deterrent feature	3
Tone settings.....	18
Traffic announcements.....	21

U

Updating station lists.....	28
Usage.....	11, 24, 42, 46, 52, 56
User defined POIs.....	67
Using the AUX input.....	46
Using the CD player.....	42
Using the digital picture frame.....	52
Using the Infotainment system....	11
Using the navigation system.....	56
Using the radio.....	24
Using the USB port.....	48

V

Voice recognition.....	100
Volume for voice output.....	101, 110
Volume settings.....	21

W

Waveband menus.....	28
---------------------	----