

CORSA PRICE/SPECIFICATION GUIDE

19 December 2016 | Model Year 2017.5



**PROUD SPONSOR OF OUR
NATIONAL FOOTBALL TEAMS**



CORSA CUSTOMER OFFERS

At Vauxhall we know that customers appreciate flexibility. Not only do we have an extensive range of Corsa models to choose from, but we have a range of ways to purchase too. Here's an example of our Flexible PCP programme:

LOVE AT FIRST SIGHT ENERGY 1.4i (75PS) ecoFLEX (a/c)



FLEXIBLE PCP* Representative example:

| | |
|--|------------|
| 36 Monthly Payments of | £169 |
| On-the-road cash price including customer saving | £13,385.02 |
| Vauxhall Deposit Contribution | £1,800 |
| Customer Deposit | £1,999 |
| Total Amount of Credit | £9,586.02 |
| Interest Charges | £782.98 |
| First credit arrangement fee | £149 |
| Final credit arrangement fee | £149 |
| Total Amount Payable | £14,466 |
| Optional Final Payment (GFV) | £4,285 |
| Fixed Rate of Interest per year, true | 3.64% |
| Mileage per annum | 8,000 |
| Excess mileage charge, per mile | £0.09 |
| Duration of Agreement | 37 months |
| APR Representative | 5.1% APR |

For even more great deals contact your local Retailer or call 0345 600 1500 or visit www.vauxhall.co.uk/offers

TERMS AND CONDITIONS: *Offer subject to availability at participating Retailers only. Personal Contract Purchase. Finance subject to status, terms and conditions apply. Applicants must be 18+. Finance by Vauxhall Finance, PO Box 6666, CF15 7YT. Customer deposit shown after deduction of Vauxhall contribution. At the end of the agreement there are three options: i) Retain the vehicle: Pay the optional final payment to own the vehicle, ii) Return the vehicle, or iii) Replace: Part Exchange the vehicle, where equity is available. Offer applies to private individuals, Vauxhall Partners and small businesses 1-24 units (purchase only excluding B2B supported units). All other customers are excluded. Offer available on orders or registrations between 19 December 2016 and 3 April 2017.

CORSA RANGE HIGHLIGHTS



STANDARD FEATURES

Infotainment:

- Six speakers

Interior convenience / styling:

- Cruise control
- Speed-sensitive power-assisted steering
- Steering column adjustable for reach / rake
- Steering wheel audio / phone / cruise controls
- Driver's seat height adjuster

Exterior convenience / styling:

- Heated windscreen
- Remote control central locking
- Electrically operated front windows
- Electrically adjustable door mirrors
- Black B-pillars (with certain exterior colours)

Safety / security features:

- Electronic Stability Programme (ESP)
- Anti-lock Braking System (ABS)
- Six airbags
- Hill start assist
- Seatbelt reminders for all seats
- ISOFIX child seat mounting points on outer rear seats
- Tyre pressure monitoring system
- Daytime running lights
- Engine deadlock immobiliser

STING

OTR from £10,155

Additional over standard features:

Infotainment:

- CD 30 BT audio system
 - AM/FM radio
 - CD/MP3 CD player
 - Bluetooth® mobile phone portal
 - USB audio connection
 - Aux-in socket

Interior convenience / styling:

- Leather-covered steering wheel

Exterior convenience / styling:

- Twin white stripes on bonnet, roof and tailgate
- White door mirror housings and front grille bar
- 16-inch white 4-twinspoke alloy wheels



STING R

OTR from £12,055

Features over Sting:

Interior convenience / styling:

- VX-Line styling: Leather-covered flat-bottom steering wheel / gear knob / handbrake lever

Exterior convenience / styling:

- Sports suspension
- Twin black stripes on bonnet, roof and tailgate
- Black door mirror housings and front grille bar
- Chrome-effect exhaust tailpipe extension
- 16-inch black 4-twinspoke alloy wheels

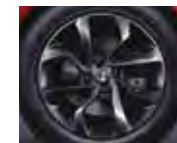

ENERGY

OTR from £12,945

Additional over standard features:

Infotainment:

- IntelliLink audio system
 - 7-inch colour touchscreen
 - AM/FM/DAB digital radio
 - Bluetooth® audio streaming
 - Bluetooth® mobile phone portal
 - Apple CarPlay™ / Android Auto™
 - USB audio connection

Interior convenience / styling:

- Air conditioning (non air-conditioned models available)
- Heated leather-covered steering wheel
- Heated front seats

Exterior convenience / styling:

- Electrically adjustable / heated door mirrors
- Automatic lighting control
- Rain-sensitive windscreen wipers
- Front fog lights
- 16-inch 8-spoke alloy wheels (3-door only)
- 16-inch silver 4-twinspoke alloy wheels (5-door only)

Safety / security features:

- LED daytime running lights



CORSA RANGE HIGHLIGHTS



SRI OTR from £12,550

Additional over standard features:

Infotainment:

- IntelliLink audio system
 - 7-inch colour touchscreen
 - AM/FM/DAB digital radio
 - Bluetooth® audio streaming
 - Bluetooth® mobile phone portal
 - Apple CarPlay™ / Android Auto™
 - USB audio connection

Interior convenience / styling:

- Air conditioning
- Leather-covered steering wheel
- Sports-style front seats

Exterior convenience / styling:

- Rain-sensitive windscreen wipers
- Automatic lighting control
- Electrically adjustable / heated door mirrors
- Front fog lights with chrome-effect surround
- 16-inch black 4-twinspoke alloy wheels (3-door)
 - no-cost option on 5-door models
- 16-inch silver 4-twinspoke alloy wheels (5-door)
 - no-cost option on 3-door models

Safety / security features:

- LED daytime running lights



Sri VX-LINE OTR from £13,585

Features over SRI:

Exterior convenience / styling:

- VX-Line body styling:
 - Front lower spoiler
 - Side sills / rear lower skirt
 - Rear roof spoiler (3-door only)
- Chrome-effect exhaust tailpipe extension
- Sports suspension
- 17-inch alloy wheels



LIMITED EDITION OTR from £15,310

Additional over standard features:

Vauxhall OnStar:

- Automatic crash response / Wi-Fi hotspot / smartphone app / stolen vehicle assistance / vehicle diagnostics

Infotainment:

- IntelliLink audio system
 - 7-inch colour touchscreen
 - AM/FM/DAB digital radio
 - Bluetooth® audio streaming
 - Bluetooth® mobile phone portal
 - Apple CarPlay™ / Android Auto™
 - USB audio connection

Interior convenience / styling:

- Air conditioning
- Sports-style front seats
- VX-Line styling: Leather-covered flat-bottom steering wheel / gear knob / handbrake lever

Exterior convenience / styling:

- VX-Line body styling: Front lower spoiler / side sills / rear skirt / VXR rear roof spoiler (3-door only)
- Roof / door mirrors / front grille bar in black
- Dark-tinted rear windows
- Chrome-effect exhaust tailpipe extension
- Sports suspension
- Front fog lights
- 17-inch black alloy wheels

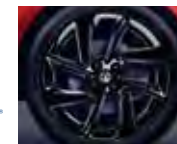

RED EDITION OTR from £17,920

Features over Limited Edition:

- 1.4i Turbo (150PS) Start/Stop
- 17-inch diamond-cut alloy wheels
- Lava Red brilliant paint



BLACK EDITION OTR from £17,920

Features over Limited Edition:

- 1.4i Turbo (150PS) Start/Stop
- 17-inch diamond-cut alloy wheels
- Mineral Black two-coat metallic paint



CORSA RANGE HIGHLIGHTS



DESIGN OTR from £11,880

Additional over standard features:

Infotainment:

- IntelliLink audio system
 - 7-inch colour touchscreen
 - AM/FM/DAB digital radio
 - Bluetooth® audio streaming
 - Bluetooth® mobile phone portal
 - Apple CarPlay™ / Android Auto™
 - USB audio connection

Interior convenience / styling:

- Air conditioning
- Leather-covered steering wheel

Exterior convenience / styling:

- Front fog lights
- 15-inch structure steel wheels with styled wheel covers

Safety / security features:

- LED daytime running lights



SE OTR from £13,445

Features over Design:

Vauxhall OnStar:

- Automatic crash response / Wi-Fi hotspot / smartphone app / stolen vehicle assistance / vehicle diagnostics

Interior convenience / styling:

- Auto anti-dazzle rear-view mirror
- Multi-function trip computer
- Electrically heated leather-covered steering wheel
- Electrically heated front seats
- Graphic Embossed cloth/Morrocana trim
- 60/40 split-folding rear seat back

Exterior convenience / styling:

- Auto lighting / windscreen wipers
- Electrically adjustable / heated door mirrors
- Front / rear parking sensors
- Front fog lights with chrome-effect surround
- Chrome-effect lower side window mouldings (5-door only)
- 16-inch multi-spoke alloy wheels



ELITE OTR from £17,090

Features over SE:

Interior convenience / styling:

- Electronic climate control
- Rear-view camera
- Centre rear seat head restraint

Exterior convenience / styling:

- Bi-xenon headlights
- Dark-tinted rear windows
- Sports suspension (not with optional 16-inch alloy wheels)
- 17-inch diamond-cut alloy wheels

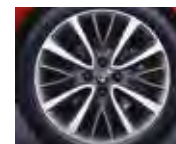

CORSA STING / STING R

| | 3-door hatchback | | 5-door hatchback | |
|--|------------------|------------------------|------------------|------------------------|
| | OTR RRP | CO ₂ (g/km) | OTR RRP | CO ₂ (g/km) |

CORSA STING – ON-THE-ROAD PRICES





| | | | | | |
|--------|---------------------|---------|-----|---|---|
| Petrol | 1.4i (75PS) ecoFLEX | £10,155 | 118 | – | – |
| | 1.4i (90PS) ecoFLEX | £10,400 | 118 | – | – |

CORSA STING R – ON-THE-ROAD PRICES

| | | | | | |
|--------|--------------------------------|---------|-----|---|---|
| Petrol | 1.0i Turbo (115PS) S/S ecoFLEX | £12,055 | 111 | – | – |
|--------|--------------------------------|---------|-----|---|---|

Please note: On-the-road recommended retail prices (RRP) include VAT at 20%, number plates and delivery to Retailer of £700.00 (inc. £116.67 VAT), 12 months' Vehicle Excise Duty and new vehicle first registration fee of £55.00. Excludes fuel and insurance. S/S = Start/Stop.

CORSA STING / STING R – KEY OPTIONS

| | | Total inc. VAT |
|--|---|----------------|
|  Looking good: | Brilliant paint | £285 |
| | Metallic / pearlescent paint | £555 |
|  Easier parking: | Front and rear parking sensors | £460 |
|  Fresh air: | Air conditioning | £535 |
|  Practicality: | 60/40 split-folding rear seat back | £140 |
| | Steel emergency spare wheel (in lieu of emergency tyre inflation kit) | £110 |
| | Remote control alarm | £260 |

For details of these and other options please see Features/Options pages.



CORSA STING – FEATURES

Infotainment:

- CD 30 BT audio system
 - AM/FM radio
 - CD/MP3 CD player
 - Bluetooth® mobile phone portal
 - USB audio connection
 - Aux-in socket
- Six speakers

Interior convenience / styling:

- Cruise control
- Leather-covered steering wheel
- Speed-sensitive power-assisted steering
- Steering column adjustable for reach / rake
- Steering wheel audio / phone / cruise controls
- Driver's seat height adjuster

Exterior convenience / styling:

- Heated windscreen
- Remote control central locking
- Electrically operated front windows
- Electrically adjustable door mirrors
- Twin white stripes on bonnet, roof and tailgate
- White door mirror housings and front grille bar
- Black B-pillars (with certain exterior colours)
- 16-inch white 4-twinspoke alloy wheels

Safety / security features:

- Electronic Stability Programme (ESP)
- Anti-lock Braking System (ABS)
- Six airbags
- Hill start assist
- Seatbelt reminders for all seats
- ISOFIX child seat mounting points on outer rear seats
- Tyre pressure monitoring system
- Daytime running lights
- Engine deadlock immobiliser



CORSA STING R – FEATURES

Interior convenience / styling:

As Corsa Sting, plus:

- VX-Line styling: Leather-covered flat-bottom steering wheel / gear knob / handbrake lever

Exterior convenience / styling:

As Corsa Sting, plus:

- Sports suspension
- Twin black stripes on bonnet, roof and tailgate
- Black door mirror housings and front grille bar
- Chrome-effect exhaust tailpipe extension
- 16-inch black 4-twinspoke alloy wheels

CUSTOMER OFFERS*

Please consult your Retailer for details.

-  **Flexible Personal Lease**

COMPANY CAR INFORMATION

Please see www.vauxhall.co.uk/fleet for details.

-  **P11D price starting at £10,100**
-  **From 19% tax band** / £34 monthly BiK tax****
-  **CO₂ emissions from 111g/km**





* = Terms and conditions apply.

** = 2016/17 tax year.

CORSA DESIGN

| | | 3-door hatchback | | 5-door hatchback | |
|--|---------------------------------------|------------------|------------------------|------------------|------------------------|
| | | OTR RRP | CO ₂ (g/km) | OTR RRP | CO ₂ (g/km) |
| CORSA DESIGN – ON-THE-ROAD PRICES | | | | | |
| <i>Petrol</i> | 1.4i (75PS) ecoFLEX | £11,880 | 120 | £12,480 | 120 |
| | 1.4i (90PS) ecoFLEX | £12,125 | 120 | £12,725 | 120 |
| | 1.4i (90PS) S/S ecoFLEX Easytronic | £12,780 | 112 | £13,380 | 112 |
| | 1.4i (90PS) auto | £13,620 | 137 | £14,220 | 139 |
| | 1.0i Turbo (90PS) S/S ecoFLEX | – | – | £14,210 | 107 |
| <i>Diesel</i> | 1.3CDTi (75PS) S/S ecoFLEX | £14,030 | 104* | £14,630 | 104* |
| | 1.3CDTi (95PS) S/S ecoFLEX | £14,530 | 94* | £15,130 | 94* |
| | 1.3CDTi (95PS) S/S ecoFLEX Easytronic | £15,180 | 91* | £15,780 | 91* |

Please note: On-the-road recommended retail prices (RRP) include VAT at 20%, number plates and delivery to Retailer of £700.00 (inc. £116.67 VAT), 12 months' Vehicle Excise Duty and new vehicle first registration fee of £55.00. Excludes fuel and insurance. S/S = Start/Stop. * = Provisional data.

| CORSA DESIGN – KEY OPTIONS | | Total inc. VAT |
|--|---|----------------|
|  Looking good: | Brilliant paint | £285 |
| | Metallic / pearlescent paint | £555 |
| | 15-inch alloy wheels | £160 |
|  Easier parking: | Front and rear parking sensors | £460 |
| | Rear-view camera | £210 |
|  Driving assistance: | OnStar – Automatic crash response / Wi-Fi / smartphone function / stolen vehicle assistance / vehicle diagnostics | £405 |
| | Driving Assistance Pack – Warns you if you approach other vehicles too fast – Remembers and displays road signs, including speed limits – Warns you if you move out of your lane – Indicates how close you are to the car in front | £660 |
| | Sight and Light Pack – Automatic lights / wipers | from £210 |
|  Warm welcome: | Winter Pack – Heated front seats / steering wheel | £230 |
|  Practicality: | 60/40 split-folding rear seat back | £140 |
| | Full-size steel spare wheel (in lieu of emergency tyre inflation kit) – not available with optional 16-inch steel wheels | £110 |
| | Remote control alarm | £260 |
| | Wireless mobile phone charger | £160 |

For details of these and other options please see Features/Options pages.



CORSA DESIGN – FEATURES

Infotainment:

- IntelliLink audio system
 - 7-inch colour touchscreen
 - AM/FM/DAB digital radio
 - Bluetooth® audio streaming
 - Bluetooth® mobile phone portal
 - Apple CarPlay™ / Android Auto™
 - USB audio connection
- Six speakers

Interior convenience / styling:

- Air conditioning
- Cruise control
- Leather-covered steering wheel
- Speed-sensitive power-assisted steering
- Steering column adjustable for reach / rake
- Steering wheel audio / phone / cruise controls
- Driver's seat height adjuster

Exterior convenience / styling:

- Heated windscreen
- Remote control central locking
- Electrically operated front windows
- Electrically adjustable door mirrors
- Front fog lights
- Black B-pillars (with certain exterior colours)
- 15-inch structure steel wheels with styled wheel covers

Safety / security features:

- Electronic Stability Programme (ESP)
- Anti-lock Braking System (ABS)
- Six airbags
- Hill start assist
- Seatbelt reminders for all seats
- ISOFIX child seat mounting points on outer rear seats
- Tyre pressure monitoring system
- LED daytime running lights
- Engine deadlock immobiliser

CUSTOMER OFFERS**

Please consult your Retailer for details.

-  **Flexible Personal Lease**

COMPANY CAR INFORMATION

Please see www.vauxhall.co.uk/fleet for details.

-  **P11D price starting at £11,825**
-  **From 18% tax band† / £41 monthly BiK tax†**
-  **CO₂ emissions from 90g/km††**





** = Terms and conditions apply.

† = 2016/17 tax year. †† = 1.3CDTi (95PS) S/S ecoFLEX Easytronic with optional 16-inch wheels.

CORSA ENERGY

| | | 3-door hatchback | | 5-door hatchback | |
|--|--|------------------|------------------------|------------------|------------------------|
| | | OTR RRP | CO ₂ (g/km) | OTR RRP | CO ₂ (g/km) |
| CORSA ENERGY – ON-THE-ROAD PRICES | | | | | |
| <i>Petrol</i> | 1.4i (75PS) ecoFLEX | £12,945 | 118 | £13,545 | 118 |
| | 1.4i (90PS) ecoFLEX | £13,190 | 118 | £13,790 | 118 |
| | 1.4i (75PS) ecoFLEX (a/c) | £13,245 | 118 | £13,845 | 118 |
| | 1.4i (90PS) ecoFLEX (a/c) | £13,490 | 118 | £14,090 | 118 |
| | 1.4i (90PS) S/S ecoFLEX Easytronic (a/c) | £14,145 | 110 | £14,745 | 110 |
| | 1.4i (90PS) auto (a/c) | £14,985 | 135 | £15,585 | 137 |
| | 1.4i Turbo (100PS) S/S ecoFLEX (a/c) | £14,145 | 119 | £14,745 | 119 |
| | 1.0i Turbo (115PS) S/S ecoFLEX (a/c) | £14,975 | 111 | £15,575 | 113 |
| <i>Diesel</i> | 1.3CDTi (75PS) S/S ecoFLEX (a/c) | £15,395 | 102* | £15,995 | 102* |

Please note: On-the-road recommended retail prices (RRP) include VAT at 20%, number plates and delivery to Retailer of £700.00 (inc. £116.67 VAT), 12 months' Vehicle Excise Duty and new vehicle first registration fee of £55.00. Excludes fuel and insurance. S/S = Start/Stop. a/c = Air conditioning. * = Provisional data.

| CORSA ENERGY – KEY OPTIONS | | Total inc. VAT |
|--|--|----------------|
|  Looking good: | Brilliant paint | £285 |
| | Metallic / pearlescent paint | £555 |
|  Easier parking: | Front and rear parking sensors | £460 |
| | Advanced park assist | |
| | – Additional sensors help find suitable parking spaces | £505 |
| | – The system automatically steers into the parking space. You just drive forwards or backwards as directed | |
| | Rear-view camera | £210 |
|  Driving assistance: | OnStar | £405 |
| | – Automatic crash response / Wi-Fi / smartphone function / stolen vehicle assistance / vehicle diagnostics | |
| | Driving Assistance Pack | |
| | – Warns you if you approach other vehicles too fast | £660 |
| | – Remembers and displays road signs, including speed limits | |
| | – Warns you if you move out of your lane | |
| | – Indicates how close you are to the car in front | |
| | Sight and Light Pack | from £210 |
| | – Automatic lights / wipers | |
|  Fresh air: | Electronic climate control incorporating air conditioning | £405 |
| | Electrically operated slide/tilt panoramic glass sunroof | £760 |
|  Practicality: | 60/40 split-folding rear seat back | £140 |
| | Remote control alarm | £260 |
| | Flex-Fix® integrated two-bicycle carrier system | £460 |
| | Wireless mobile phone charger | £160 |

For details of these and other options please see Features/Options pages.



CORSA ENERGY – FEATURES

Infotainment:

- IntelliLink audio system
 - 7-inch colour touchscreen
 - AM/FM/DAB digital radio
 - Bluetooth® audio streaming
 - Bluetooth® mobile phone portal
 - Apple CarPlay™ / Android Auto™
 - USB audio connection
- Six speakers

Interior convenience / styling:

- Air conditioning (non air-conditioned models available)
- Heated leather-covered steering wheel
- Heated front seats
- Cruise control
- Speed-sensitive power-assisted steering
- Steering column adjustable for reach / rake
- Steering wheel audio / phone / cruise controls
- Driver's seat height adjuster

Exterior convenience / styling:



- Heated windscreen
- Remote control central locking
- Electrically operated front windows
- Electrically adjustable / heated door mirrors
- Automatic lighting control
- Rain-sensitive windscreen wipers
- Front fog lights
- Black B-pillars (with certain exterior colours)
- 16-inch 8-spoke alloy wheels (3-door only)
- 16-inch silver 4-twinspoke alloy wheels (5-door only)

Safety / security features:

- Electronic Stability Programme (ESP)
- Anti-lock Braking System (ABS)
- Six airbags
- Hill start assist
- Seatbelt reminders for all seats
- ISOFIX child seat mounting points on outer rear seats
- Tyre pressure monitoring system
- LED daytime running lights
- Engine deadlock immobiliser

CUSTOMER OFFERS**



Please consult your Retailer for details.

-  **0% Flexible Finance**
-  **Flexible PCP (3.7% APR) with £1100 Vauxhall Deposit Contribution**
-  **Flexible Personal Lease**

** = Terms and conditions apply.

COMPANY CAR INFORMATION

Please see www.vauxhall.co.uk/fleet for details.

-  **P11D price starting at £12,890**
-  **From 19% tax band† / £43 monthly BiK tax†**
-  **CO₂ emissions from 102g/km**

† = 2016/17 tax year.

CORSA SRi / SRi VX-LINE

| | | 3-door hatchback | | 5-door hatchback | |
|--|--|------------------|------------------------|------------------|------------------------|
| | | OTR RRP | CO ₂ (g/km) | OTR RRP | CO ₂ (g/km) |

CORSA SRi – ON-THE-ROAD PRICES







| | | | | | |
|--------|--------------------------------|---------|-----|---------|------|
| Petrol | 1.4i (75PS) ecoFLEX | £12,550 | 118 | £13,150 | 118 |
| | 1.4i (90PS) ecoFLEX | £12,795 | 118 | £13,395 | 118 |
| | 1.4i (90PS) auto | £14,290 | 135 | £14,890 | 137 |
| | 1.0i Turbo (90PS) S/S ecoFLEX | £14,280 | 102 | £14,880 | 105 |
| | 1.4i Turbo (100PS) S/S ecoFLEX | £13,450 | 119 | £14,050 | 119 |
| Diesel | 1.3CDTi (75PS) S/S ecoFLEX | – | – | £15,300 | 102* |
| | 1.3CDTi (95PS) S/S ecoFLEX | £15,200 | 93* | £15,800 | 93* |

CORSA SRi VX-LINE – ON-THE-ROAD PRICES

| | | | | | |
|--------|--------------------------------|---------|-----|---------|------|
| Petrol | 1.4i (75PS) ecoFLEX | £13,585 | 120 | £14,185 | 120 |
| | 1.4i (90PS) ecoFLEX | £13,830 | 120 | £14,430 | 120 |
| | 1.4i (90PS) auto | £15,325 | 137 | £15,925 | 139 |
| | 1.4i Turbo (100PS) S/S | £14,485 | 122 | £15,085 | 122 |
| | 1.0i Turbo (115PS) S/S ecoFLEX | £15,315 | 113 | £15,915 | 115 |
| Diesel | 1.3CDTi (75PS) S/S ecoFLEX | – | – | £16,335 | 104* |
| | 1.3CDTi (95PS) S/S ecoFLEX | £16,235 | 94* | £16,835 | 94* |

Please note: On-the-road recommended retail prices (RRP) include VAT at 20%, number plates and delivery to Retailer of £700.00 (inc. £116.67 VAT), 12 months' Vehicle Excise Duty and new vehicle first registration fee of £55.00. Excludes fuel and insurance. S/S = Start/Stop. * = Provisional data.

CORSA SRi / SRi VX-LINE – KEY OPTIONS

| | | Total inc. VAT |
|---|--|----------------|
|  | Looking good: | |
| | Brilliant paint | £285 |
| | Metallic / pearlescent paint | £555 |
|  | Easier parking: | |
| | Front and rear parking sensors | £460 |
| | Advanced park assist – Additional sensors help find suitable parking spaces – The system automatically steers into the parking space. You just drive forwards or backwards as directed | £505 |
| | Rear-view camera | £210 |
|  | Driving assistance: | |
| | OnStar – Automatic crash response / Wi-Fi / smartphone function / stolen vehicle assistance / vehicle diagnostics | £405 |
| | Driving Assistance Pack – Warns you if you approach other vehicles too fast – Remembers and displays road signs, including speed limits – Warns you if you move out of your lane – Indicates how close you are to the car in front | £660 |
| | | |
|  | Warm welcome: | |
| | Winter Pack – Heated front seats / steering wheel | £230 |
|  | Fresh air: | |
| | Electronic climate control incorporating air conditioning | £405 |
| | Electrically operated slide/tilt panoramic glass sunroof | £760 |
|  | Practicality: | |
| | Flex-Fix® integrated two-bike carrier system | £460 |
| | Wireless mobile phone charger | £160 |

For details of these and other options please see Features/Options pages.



CORSA SRi – FEATURES

Infotainment:

- IntelliLink audio system
 - 7-inch colour touchscreen
 - AM/FM/DAB digital radio
 - Bluetooth® audio streaming
 - Bluetooth® mobile phone portal
 - Apple CarPlay™ / Android Auto™
 - USB audio connection
- Six speakers

Interior convenience / styling:

- Air conditioning
- Leather-covered steering wheel
- Cruise control
- Steering column adjustable for reach / rake
- Steering wheel audio / phone / cruise controls
- Sports-style front seats
- Driver's seat height adjuster

Exterior convenience / styling:

- Heated windscreen
- Rain-sensitive windscreen wipers
- Automatic lighting control
- Electrically adjustable / heated door mirrors
- Front fog lights with chrome-effect surround
- Black B-pillars (with certain exterior colours)
- 16-inch black 4-twinspoke alloy wheels (3-door)
 - no-cost option on 5-door models
- 16-inch silver 4-twinspoke alloy wheels (5-door)
 - no-cost option on 3-door models

Safety / security features:

- Electronic Stability Programme (ESP)
- Anti-lock Braking System (ABS)
- Six airbags
- Hill start assist
- ISOFIX child seat fixings on outer rear seats
- Tyre pressure monitoring system
- LED daytime running lights
- Engine deadlock immobiliser

CORSA SRi VX-LINE – FEATURES



Exterior convenience / styling:

As Corsa SRi, plus:

- VX-Line body styling
 - Front lower spoiler
 - Side sills / rear lower skirt
 - Rear roof spoiler (3-door only)
- Chrome-effect exhaust tailpipe extension
- Sports suspension
- 17-inch alloy wheels

CUSTOMER OFFERS**

Please consult your Retailer for details.

-  Flexible Personal Lease

COMPANY CAR INFORMATION

Please see www.vauxhall.co.uk/fleet for details.

-  P11D price starting at £12,495
-  From 17% tax band† / £41 monthly BiK tax†
-  CO₂ emissions from 93g/km

** = Terms and conditions apply.

† = 2016/17 tax year.





CORSA LIMITED EDITIONS

| | | 3-door hatchback | | 5-door hatchback | |
|---|--------------------------------|------------------|------------------------|------------------|------------------------|
| | | OTR RRP | CO ₂ (g/km) | OTR RRP | CO ₂ (g/km) |
| CORSA LIMITED EDITION – ON-THE-ROAD PRICES | | | | | |
| Petrol | 1.4i (75PS) ecoFLEX | £15,310 | 120 | £15,910 | 120 |
| | 1.4i (90PS) ecoFLEX | £15,555 | 120 | £16,155 | 120 |
| | 1.4i Turbo (100PS) S/S | £16,210 | 122 | £16,810 | 122 |
| | 1.0i Turbo (115PS) S/S ecoFLEX | £17,040 | 113 | £17,640 | 115 |

| CORSA RED EDITION – ON-THE-ROAD PRICES | | | | | |
|---|------------------------|---------|-----|---------|-----|
| Petrol | 1.4i Turbo (150PS) S/S | £17,920 | 132 | £18,520 | 133 |

| CORSA BLACK EDITION – ON-THE-ROAD PRICES | | | | | |
|---|------------------------|---------|-----|---------|-----|
| Petrol | 1.4i Turbo (150PS) S/S | £17,920 | 132 | £18,520 | 133 |



Please note: On-the-road recommended retail prices (RRP) include VAT at 20%, number plates and delivery to Retailer of £700.00 (inc. £116.67 VAT), 12 months' Vehicle Excise Duty and new vehicle first registration fee of £55.00. Excludes fuel and insurance. S/S = Start/Stop.

| CORSA LIMITED EDITIONS – KEY OPTIONS | | | Total inc. VAT |
|---|----------------------------|---|----------------|
|  | Looking good: | Brilliant paint | £285 |
| | | Metallic / pearlescent paint | £555 |
|  | Easier parking: | Front and rear parking sensors | £460 |
| | | Advanced park assist – Finds parking spaces and steers into them for you | £505 |
| | | Rear-view camera | £210 |
|  | Driving assistance: | Driving Assistance Pack – Warns you if you approach other vehicles too fast – Remembers and displays road signs, including speed limits | £660 |
| | | – Warns you if you move out of your lane – Indicates how close you are to the car in front | |
| | | Bi-xenon headlights with cornering light – Brighter headlights for better visibility | £405 |
| | | | |
|  | Fresh air: | Electrically operated slide/tilt panoramic glass sunroof | £760 |

For details of these and other options please see Features/Options pages.

CUSTOMER OFFERS*

Please consult your Retailer for details.

-  **0% Flexible Finance**
-  **Flexible PCP (3.7% APR) with £1100 Vauxhall Deposit Contribution**
-  **Flexible Personal Lease**

* = Terms and conditions apply.

COMPANY CAR INFORMATION

Please see www.vauxhall.co.uk/fleet for details.

-  **P11D price starting at £15,255**
-  **From 19% tax band** / £54 monthly BiK tax****
-  **CO₂ emissions from 113g/km**

** = 2016/17 tax year.



CORSA LIMITED EDITION – FEATURES

Vauxhall OnStar:

- Automatic crash response / Wi-Fi hotspot / smartphone app / stolen vehicle assistance / vehicle diagnostics

Infotainment:

- IntelliLink audio system
 - 7-inch colour touchscreen
 - AM/FM/DAB digital radio
 - Bluetooth® audio streaming
 - Bluetooth® mobile phone portal
 - Apple CarPlay™ / Android Auto™
 - USB audio connection
- Six speakers

Interior convenience / styling:

- Air conditioning
- Sports-style front seats
- VX-Line styling: Leather-covered flat-bottom steering wheel / gear knob / handbrake lever
- Multi-function trip computer
- Cruise control
- Speed-sensitive power-assisted steering
- Steering column adjustable for reach / rake
- Steering wheel audio / phone / cruise controls
- Driver's seat height adjuster

Exterior convenience / styling:

- VX-Line body styling: Front lower spoiler / side sills / rear skirt / VXR rear roof spoiler (3-door only)
- Roof / door mirrors / front grille bar in black
- Heated windscreen
- Remote control central locking
- Electrically operated front windows
- Electrically adjustable / heated door mirrors
- Dark-tinted rear windows
- Chrome-effect exhaust tailpipe extension
- Sports suspension
- Front fog lights
- 17-inch black alloy wheels

Safety / security features:

- Electronic Stability Programme (ESP)
- Anti-lock Braking System (ABS)
- Six airbags
- Hill start assist
- Seatbelt reminders for all seats
- ISOFIX child seat mounting points on outer rear seats
- Tyre pressure monitoring system
- LED daytime running lights



CORSA RED EDITION – FEATURES

As Corsa Limited Edition, plus:

- 1.4i Turbo (150PS) Start/Stop
- 17-inch diamond-cut alloy wheels
- Lava Red brilliant paint

CORSA BLACK EDITION – FEATURES





As Corsa Limited Edition, plus:

- 1.4i Turbo (150PS) Start/Stop
- 17-inch diamond-cut alloy wheels
- Mineral Black two-coat metallic paint

CORSA SE

| | | 3-door hatchback | | 5-door hatchback | |
|--------------------------------------|--------------------------------|------------------|------------------------|------------------|------------------------|
| | | OTR RRP | CO ₂ (g/km) | OTR RRP | CO ₂ (g/km) |
| CORSA SE – ON-THE-ROAD PRICES | | | | | |
| Petrol | 1.4i (75PS) ecoFLEX | £13,445 | 118 | £14,045 | 118 |
| | 1.4i (90PS) ecoFLEX | £13,690 | 118 | £14,290 | 118 |
| | 1.4i (90PS) auto | £15,185 | 135 | £15,785 | 137 |
| | 1.0i Turbo (90PS) S/S ecoFLEX | £15,175 | 102 | £15,775 | 105 |
| | 1.4i Turbo (100PS) S/S ecoFLEX | £14,345 | 119 | £14,945 | 119 |
| Diesel | 1.3CDTi (75PS) S/S ecoFLEX | – | – | £16,195 | 102* |
| | 1.3CDTi (95PS) S/S ecoFLEX | £16,095 | 93* | £16,695 | 93* |

Please note: On-the-road recommended retail prices (RRP) include VAT at 20%, number plates and delivery to Retailer of £700.00 (inc. £116.67 VAT), 12 months' Vehicle Excise Duty and new vehicle first registration fee of £55.00. Excludes fuel and insurance. S/S = Start/Stop. * = Provisional data.

| CORSA SE – KEY OPTIONS | | Total inc. VAT |
|---|---|----------------|
|  | Looking good: Brilliant paint | £285 |
| | Metallic / pearlescent paint | £555 |
| | 17-inch diamond-cut titan alloy wheels | £410 |
|  | Easier parking: Advanced park assist – Additional sensors help find suitable parking spaces – The system automatically steers into the parking space. You just drive forwards or backwards as directed | £55 |
| | Rear-view camera | £210 |
| | | |
|  | Fresh air: Electronic climate control incorporating air conditioning | £405 |
| | Electrically operated slide/tilt panoramic glass sunroof | £760 |
|  | Driving assistance: Driving Assistance Pack – Warns you if you approach other vehicles too fast – Remembers and displays road signs, including speed limits – Warns you if you move out of your lane – Indicates how close you are to the car in front | £660 |
| | Bi-xenon headlights with cornering light – Brighter headlights for better visibility | £405 |
| | Remote control alarm | £260 |
| | Wireless mobile phone charger | £160 |
| | | |
| | | |

For details of these and other options please see Features/Options pages.



CORSA SE – FEATURES

Vauxhall OnStar:

- Automatic crash response / Wi-Fi hotspot / smartphone app / stolen vehicle assistance / vehicle diagnostics

Infotainment:

- IntelliLink audio system
 - 7-inch colour touchscreen
 - AM/FM/DAB digital radio
 - Bluetooth® audio streaming
 - Bluetooth® mobile phone portal
 - Apple CarPlay™ / Android Auto™
 - USB audio connection
- Six speakers

Interior convenience / styling:

- Air conditioning
- Auto anti-dazzle rear-view mirror
- Multi-function trip computer
- Electrically heated leather-covered steering wheel
- Electrically heated front seats
- Graphic Embossed cloth/Morrocana trim
- 60/40 split-folding rear seat back
- Cruise control
- Speed-sensitive power-assisted steering
- Steering column adjustable for reach / rake
- Steering wheel audio / phone / cruise controls
- Driver's seat height adjuster

Exterior convenience / styling:

- Heated windscreen
- Remote control central locking
- Electrically operated front windows
- Auto lighting / windscreen wipers
- Electrically adjustable / heated door mirrors
- Body-colour exterior door handles
- Front / rear parking sensors
- Front fog lights with chrome-effect surround
- Chrome-effect lower side window mouldings (5-door only)
- 16-inch multi-spoke alloy wheels

Safety / security features:

- Electronic Stability Programme (ESP)
- Anti-lock Braking System (ABS)
- Six airbags
- Hill start assist
- Seatbelt reminders for all seats
- ISOFIX child seat mounting points on outer rear seats
- Tyre pressure monitoring system
- LED daytime running lights
- Engine deadlock immobiliser

CUSTOMER OFFERS**

Please consult your Retailer for details.

-  Flexible Personal Lease

COMPANY CAR DRIVERS

Please see www.vauxhall.co.uk/fleet for details.

-  P11D price starting at £13,390

-  From 17% tax band† / £43 monthly BiK tax†

-  CO₂ emissions from 93g/km







** = Terms and conditions apply.

† = 2016/17 tax year.

CORSA ELITE

| | | 3-door hatchback | | 5-door hatchback | |
|---|--------------------------------------|------------------|------------------------|------------------|------------------------|
| | | OTR RRP | CO ₂ (g/km) | OTR RRP | CO ₂ (g/km) |
| CORSA ELITE – ON-THE-ROAD PRICES | | | | | |
| <i>Petrol</i> | 1.4i (90PS) ecoFLEX | – | – | £17,090 | 120 |
| | 1.4i (90PS) auto | – | – | £18,585 | 139 |
| | 1.0i Turbo (90PS) Start/Stop ecoFLEX | – | – | £18,575 | 107 |
| | 1.4i Turbo (100PS) Start/Stop | – | – | £17,745 | 122 |
| <i>Diesel</i> | 1.3CDTi (95PS) Start/Stop ecoFLEX | – | – | £19,495 | 94* |

Please note: On-the-road recommended retail prices (RRP) include VAT at 20%, number plates and delivery to Retailer of £700.00 (inc. £116.67 VAT), 12 months' Vehicle Excise Duty and new vehicle first registration fee of £55.00. Excludes fuel and insurance. S/S = Start/Stop. * = Provisional data.

| CORSA ELITE – KEY OPTIONS | | Total inc. VAT | |
|--|--|---|-------------|
|  Looking good: | Brilliant paint | £285 | |
| | Metallic / pearlescent paint | £555 | |
|  Easier parking: | Advanced park assist – Additional sensors help find suitable parking spaces – The system automatically steers into the parking space. You just drive forwards or backwards as directed | £55 | |
| |  Sitting comfortably: | Front passenger's seat height adjuster | £65 |
|  Fresh air: | Electrically operated slide/tilt panoramic glass sunroof | £760 | |
|  Driving assistance: | Driving Assistance Pack – Warns you if you approach other vehicles too fast – Remembers and displays road signs, including speed limits – Warns you if you move out of your lane – Indicates how close you are to the car in front – Automatically dips your headlights when oncoming or preceding vehicles are detected | £660 | |
| |  Practicality: | Steel emergency spare wheel (in lieu of emergency tyre inflation kit) | £110 |
| | | Wireless mobile phone charger | £160 |

For details of these and other options please see Features/Options pages.



CORSA ELITE – FEATURES

Vauxhall OnStar:

- Automatic crash response / Wi-Fi hotspot / smartphone app / stolen vehicle assistance / vehicle diagnostics

Infotainment:

- IntelliLink audio system
 - 7-inch colour touchscreen
 - AM/FM/DAB digital radio
 - Bluetooth® audio streaming
 - Bluetooth® mobile phone portal
 - Apple CarPlay™ / Android Auto™
 - USB audio connection
- Six speakers

Interior convenience / styling:

- Electronic climate control
- Rear-view camera
- Centre rear seat head restraint
- Cruise control
- Speed-sensitive power-assisted steering
- Steering column adjustable for reach / rake
- Steering wheel audio / phone / cruise controls
- Driver's seat height adjuster

Exterior convenience / styling:



- Heated windscreen
- Remote control central locking
- Electrically operated front windows
- Electrically adjustable / heated door mirrors
- Bi-xenon headlights
- Dark-tinted rear windows
- Sports suspension (not with optional 16-inch alloy wheels)
- 17-inch diamond-cut alloy wheels

Safety / security features:

- Electronic Stability Programme (ESP)
- Anti-lock Braking System (ABS)
- Six airbags
- Hill start assist
- Seatbelt reminders for all seats
- ISOFIX child seat mounting points on outer rear seats
- Tyre pressure monitoring system
- LED daytime running lights
- Remote control security alarm
- Engine deadlock immobiliser

CUSTOMER OFFERS**

Please consult your Retailer for details.

-  **0% Flexible Finance**
-  **Flexible PCP (3.7% APR) with £1100 Vauxhall Deposit Contribution**
-  **Flexible Personal Lease**

** = Terms and conditions apply.

COMPANY CAR INFORMATION

Please see www.vauxhall.co.uk/fleet for details.

-  **P11D price starting at £17,035**
-  **From 18% tax band† / £56 monthly BiK tax†**
-  **CO₂ emissions from 94g/km**

† = 2016/17 tax year.

CORSA PRICES

| Model 3-door hatchback | Price (£) | VAT (£) | Total (£) | On-the-road RRP (£) | CO ₂ (g/km) |
|--|--------------|------------|--------------|------------------------|---------------------------|
| STING | | | | | |
| 1.4i (75PS) ecoFLEX | 7833.33 | 1566.67 | 9400.00 | 10155.00 | 118 |
| 1.4i (90PS) ecoFLEX | 8037.50 | 1607.50 | 9645.00 | 10400.00 | 118 |
| STING R | | | | | |
| 1.0i Turbo (115PS) Start/Stop ecoFLEX | 9416.67 | 1883.33 | 11300.00 | 12055.00 | 111 |
| ENERGY (SPECIAL EDITION MODEL) | | | | | |
| 1.4i (75PS) ecoFLEX | 10158.33 | 2031.67 | 12190.00 | 12945.00 | 118 |
| 1.4i (90PS) ecoFLEX | 10362.50 | 2072.50 | 12435.00 | 13190.00 | 118 |
| 1.4i (75PS) ecoFLEX (a/c) | 10408.33 | 2081.67 | 12490.00 | 13245.00 | 118 |
| 1.4i (90PS) ecoFLEX (a/c) | 10612.50 | 2122.50 | 12735.00 | 13490.00 | 118 |
| 1.4i (90PS) Start/Stop ecoFLEX Easytronic (a/c) | 11158.33 | 2231.67 | 13390.00 | 14145.00 | 110 |
| 1.4i (90PS) auto (a/c) | 11750.00 | 2350.00 | 14100.00 | 14985.00 | 135 |
| 1.4i Turbo (100PS) Start/Stop ecoFLEX (a/c) | 11158.33 | 2231.67 | 13390.00 | 14145.00 | 119 |
| 1.0i Turbo (115PS) Start/Stop ecoFLEX (a/c) | 11850.00 | 2370.00 | 14220.00 | 14975.00 | 111 |
| <i>Diesel</i> | | | | | |
| 1.3CDTi (75PS) Start/Stop ecoFLEX (a/c) | 12200.00 | 2440.00 | 14640.00 | 15395.00 | 102* |
| LIMITED EDITION (SPECIAL EDITION MODEL) VAUXHALL OnStar | | | | | |
| 1.4i (75PS) ecoFLEX | 12129.17 | 2425.83 | 14555.00 | 15310.00 | 120 |
| 1.4i (90PS) ecoFLEX | 12333.33 | 2466.67 | 14800.00 | 15555.00 | 120 |
| 1.4i Turbo (100PS) Start/Stop | 12879.17 | 2575.83 | 15455.00 | 16210.00 | 122 |
| 1.0i Turbo (115PS) Start/Stop ecoFLEX | 13570.83 | 2714.17 | 16285.00 | 17040.00 | 113 |
| RED EDITION (SPECIAL EDITION MODEL) VAUXHALL OnStar | | | | | |
| 1.4i Turbo (150PS) Start/Stop | 14195.83 | 2839.17 | 17035.00 | 17920.00 | 132 |
| BLACK EDITION (SPECIAL EDITION MODEL) VAUXHALL OnStar | | | | | |
| 1.4i Turbo (150PS) Start/Stop | 14195.83 | 2839.17 | 17035.00 | 17920.00 | 132 |
| DESIGN | | | | | |
| 1.4i (75PS) ecoFLEX | 9270.83 | 1854.17 | 11125.00 | 11880.00 | 120 |
| 1.4i (90PS) ecoFLEX | 9475.00 | 1895.00 | 11370.00 | 12125.00 | 120 |
| 1.4i (90PS) Start/Stop ecoFLEX Easytronic | 10020.83 | 2004.17 | 12025.00 | 12780.00 | 112 |
| 1.4i (90PS) auto | 10612.50 | 2122.50 | 12735.00 | 13620.00 | 137 |
| <i>Diesel</i> | | | | | |
| 1.3CDTi (75PS) Start/Stop ecoFLEX | 11062.50 | 2212.50 | 13275.00 | 14030.00 | 104* |
| 1.3CDTi (95PS) Start/Stop ecoFLEX | 11479.17 | 2295.83 | 13775.00 | 14530.00 | 94* |
| 1.3CDTi (95PS) Start/Stop ecoFLEX Easytronic | 12020.83 | 2404.17 | 14425.00 | 15180.00 | 91* |

| Model 3-door hatchback | Price (£) | VAT (£) | Total (£) | On-the-road RRP (£) | CO ₂ (g/km) |
|---------------------------------------|--------------|------------|--------------|------------------------|---------------------------|
| SRI | | | | | |
| 1.4i (75PS) ecoFLEX | 9829.17 | 1965.83 | 11795.00 | 12550.00 | 118 |
| 1.4i (90PS) ecoFLEX | 10033.33 | 2006.67 | 12040.00 | 12795.00 | 118 |
| 1.4i (90PS) auto | 11170.83 | 2234.17 | 13405.00 | 14290.00 | 135 |
| 1.0i Turbo (90PS) Start/Stop ecoFLEX | 11270.83 | 2254.17 | 13525.00 | 14280.00 | 102 |
| 1.4i Turbo (100PS) Start/Stop ecoFLEX | 10579.17 | 2115.83 | 12695.00 | 13450.00 | 119 |
| <i>Diesel</i> | | | | | |
| 1.3CDTi (95PS) Start/Stop ecoFLEX | 12037.50 | 2407.50 | 14445.00 | 15200.00 | 93* |
| SRI VX-LINE | | | | | |
| 1.4i (75PS) ecoFLEX | 10691.67 | 2138.33 | 12830.00 | 13585.00 | 120 |
| 1.4i (90PS) ecoFLEX | 10895.83 | 2179.17 | 13075.00 | 13830.00 | 120 |
| 1.4i (90PS) auto | 12033.33 | 2406.67 | 14440.00 | 15325.00 | 137 |
| 1.4i Turbo (100PS) Start/Stop | 11441.67 | 2288.33 | 13730.00 | 14485.00 | 122 |
| 1.0i Turbo (115PS) Start/Stop ecoFLEX | 12133.33 | 2426.67 | 14560.00 | 15315.00 | 113 |
| <i>Diesel</i> | | | | | |
| 1.3CDTi (95PS) Start/Stop ecoFLEX | 12900.00 | 2580.00 | 15480.00 | 16235.00 | 94* |
| SE VAUXHALL OnStar | | | | | |
| 1.4i (75PS) ecoFLEX | 10575.00 | 2115.00 | 12690.00 | 13445.00 | 118 |
| 1.4i (90PS) ecoFLEX | 10779.17 | 2155.83 | 12935.00 | 13690.00 | 118 |
| 1.4i (90PS) auto | 11916.67 | 2383.33 | 14300.00 | 15185.00 | 135 |
| 1.0i Turbo (90PS) Start/Stop ecoFLEX | 12016.67 | 2403.33 | 14420.00 | 15175.00 | 102 |
| 1.4i Turbo (100PS) Start/Stop ecoFLEX | 11325.00 | 2265.00 | 13590.00 | 14345.00 | 119 |
| <i>Diesel</i> | | | | | |
| 1.3CDTi (95PS) Start/Stop ecoFLEX | 12783.33 | 2556.67 | 15340.00 | 16095.00 | 93* |

Please note: On-the-road recommended retail prices (RRP) include number plates and delivery to Retailer of £700.00 (inc. £116.67 VAT), 12 months' Vehicle Excise Duty and new vehicle first registration fee of £55.00. Excludes fuel and insurance.

a/c = Air conditioning. * = Provisional data.

Easytronic transmission is a five-speed manual gearbox with a fully automatic mode.

Our ecoFLEX models combine superb performance, reduced CO₂ emissions and highly competitive economy figures.

CORSA PRICES

| Model 5-door hatchback | Price (£) | VAT (£) | Total (£) | On-the-road RRP (£) | CO ₂ (g/km) | Model 5-door hatchback | Price (£) | VAT (£) | Total (£) | On-the-road RRP (£) | CO ₂ (g/km) |
|--|--------------|------------|--------------|------------------------|---------------------------|---------------------------------------|--------------|------------|--------------|------------------------|---------------------------|
| ENERGY (SPECIAL EDITION MODEL) | | | | | | SRI | | | | | |
| 1.4i (75PS) ecoFLEX | 10658.33 | 2131.67 | 12790.00 | 13545.00 | 118 | 1.4i (75PS) ecoFLEX | 10329.17 | 2065.83 | 12395.00 | 13150.00 | 118 |
| 1.4i (90PS) ecoFLEX | 10862.50 | 2172.50 | 13035.00 | 13790.00 | 118 | 1.4i (90PS) ecoFLEX | 10533.33 | 2106.67 | 12640.00 | 13395.00 | 118 |
| 1.4i (75PS) ecoFLEX (a/c) | 10908.33 | 2181.67 | 13090.00 | 13845.00 | 118 | 1.4i (90PS) auto | 11670.83 | 2334.17 | 14005.00 | 14890.00 | 137 |
| 1.4i (90PS) ecoFLEX (a/c) | 11112.50 | 2222.50 | 13335.00 | 14090.00 | 118 | 1.0i Turbo (90PS) Start/Stop ecoFLEX | 11770.83 | 2354.17 | 14125.00 | 14880.00 | 105 |
| 1.4i (90PS) Start/Stop ecoFLEX Easytronic (a/c) | 11658.33 | 2331.67 | 13990.00 | 14745.00 | 110 | 1.4i Turbo (100PS) Start/Stop ecoFLEX | 11079.17 | 2215.83 | 13295.00 | 14050.00 | 119 |
| 1.4i (90PS) auto (a/c) | 12250.00 | 2450.00 | 14700.00 | 15585.00 | 137 | <i>Diesel</i> | | | | | |
| 1.4i Turbo (100PS) Start/Stop ecoFLEX (a/c) | 11658.33 | 2331.67 | 13990.00 | 14745.00 | 119 | 1.3CDTi (75PS) Start/Stop ecoFLEX | 12120.83 | 2424.17 | 14545.00 | 15300.00 | 102* |
| 1.0i Turbo (115PS) Start/Stop ecoFLEX (a/c) | 12350.00 | 2470.00 | 14820.00 | 15575.00 | 113 | 1.3CDTi (95PS) Start/Stop ecoFLEX | 12537.50 | 2507.50 | 15045.00 | 15800.00 | 93* |
| <i>Diesel</i> | | | | | | SRI VX-LINE | | | | | |
| 1.3CDTi (75PS) Start/Stop ecoFLEX (a/c) | 12700.00 | 2540.00 | 15240.00 | 15995.00 | 102* | 1.4i (75PS) ecoFLEX | 11191.67 | 2238.33 | 13430.00 | 14185.00 | 120 |
| LIMITED EDITION (SPECIAL EDITION MODEL) VAUXHALL OnStar | | | | | | 1.4i (90PS) ecoFLEX | 11395.83 | 2279.17 | 13675.00 | 14430.00 | 120 |
| 1.4i (75PS) ecoFLEX | 12629.17 | 2525.83 | 15155.00 | 15910.00 | 120 | 1.4i (90PS) auto | 12533.33 | 2506.67 | 15040.00 | 15925.00 | 139 |
| 1.4i (90PS) ecoFLEX | 12833.33 | 2566.67 | 15400.00 | 16155.00 | 120 | 1.4i Turbo (100PS) Start/Stop | 11941.67 | 2388.33 | 14330.00 | 15085.00 | 122 |
| 1.4i Turbo (100PS) Start/Stop | 13379.17 | 2675.83 | 16055.00 | 16810.00 | 122 | 1.0i Turbo (115PS) Start/Stop ecoFLEX | 12633.33 | 2526.67 | 15160.00 | 15915.00 | 115 |
| 1.0i Turbo (115PS) Start/Stop ecoFLEX | 14070.83 | 2814.17 | 16885.00 | 17640.00 | 115 | <i>Diesel</i> | | | | | |
| RED EDITION (SPECIAL EDITION MODEL) VAUXHALL OnStar | | | | | | 1.3CDTi (75PS) Start/Stop ecoFLEX | 12983.33 | 2596.67 | 15580.00 | 16335.00 | 104* |
| 1.4i Turbo (150PS) Start/Stop | 14695.83 | 2939.17 | 17635.00 | 18520.00 | 133 | 1.3CDTi (95PS) Start/Stop ecoFLEX | 13400.00 | 2680.00 | 16080.00 | 16835.00 | 94* |
| BLACK EDITION (SPECIAL EDITION MODEL) VAUXHALL OnStar | | | | | | SE VAUXHALL OnStar | | | | | |
| 1.4i Turbo (150PS) Start/Stop | 14695.83 | 2939.17 | 17635.00 | 18520.00 | 133 | 1.4i (75PS) ecoFLEX | 11075.00 | 2215.00 | 13290.00 | 14045.00 | 118 |
| DESIGN | | | | | | 1.4i (90PS) ecoFLEX | 11279.17 | 2255.83 | 13535.00 | 14290.00 | 118 |
| 1.4i (75PS) ecoFLEX | 9770.83 | 1954.17 | 11725.00 | 12480.00 | 120 | 1.4i (90PS) auto | 12416.67 | 2483.33 | 14900.00 | 15785.00 | 137 |
| 1.4i (90PS) ecoFLEX | 9975.00 | 1995.00 | 11970.00 | 12725.00 | 120 | 1.0i Turbo (90PS) Start/Stop ecoFLEX | 12516.67 | 2503.33 | 15020.00 | 15775.00 | 105 |
| 1.4i (90PS) Start/Stop ecoFLEX Easytronic | 10520.83 | 2104.17 | 12625.00 | 13380.00 | 112 | 1.4i Turbo (100PS) Start/Stop ecoFLEX | 11825.00 | 2365.00 | 14190.00 | 14945.00 | 119 |
| 1.4i (90PS) auto | 11112.50 | 2222.50 | 13335.00 | 14220.00 | 139 | <i>Diesel</i> | | | | | |
| 1.0i Turbo (90PS) Start/Stop ecoFLEX | 11212.50 | 2242.50 | 13455.00 | 14210.00 | 107 | 1.3CDTi (75PS) Start/Stop ecoFLEX | 12866.67 | 2573.33 | 15440.00 | 16195.00 | 102* |
| <i>Diesel</i> | | | | | | 1.3CDTi (95PS) Start/Stop ecoFLEX | 13283.33 | 2656.67 | 15940.00 | 16695.00 | 93* |
| 1.3CDTi (75PS) Start/Stop ecoFLEX | 11562.50 | 2312.50 | 13875.00 | 14630.00 | 104* | ELITE VAUXHALL OnStar | | | | | |
| 1.3CDTi (95PS) Start/Stop ecoFLEX | 11979.17 | 2395.83 | 14375.00 | 15130.00 | 94* | 1.4i (90PS) ecoFLEX | 13612.50 | 2722.50 | 16335.00 | 17090.00 | 120 |
| 1.3CDTi (95PS) Start/Stop ecoFLEX Easytronic | 12520.83 | 2504.17 | 15025.00 | 15780.00 | 91* | 1.4i (90PS) auto | 14750.00 | 2950.00 | 17700.00 | 18585.00 | 139 |
| | | | | | | 1.0i Turbo (90PS) Start/Stop ecoFLEX | 14850.00 | 2970.00 | 17820.00 | 18575.00 | 107 |
| | | | | | | 1.4i Turbo (100PS) Start/Stop | 14158.33 | 2831.67 | 16990.00 | 17745.00 | 122 |
| | | | | | | <i>Diesel</i> | | | | | |
| | | | | | | 1.3CDTi (95PS) Start/Stop ecoFLEX | 15616.67 | 3123.33 | 18740.00 | 19495.00 | 94* |

Please note: On-the-road recommended retail prices (RRP) include number plates and delivery to Retailer of £700.00 (inc. £116.67 VAT), 12 months' Vehicle Excise Duty and new vehicle first registration fee of £55.00. Excludes fuel and insurance.
a/c = Air conditioning. * = Provisional data.

Easytronic transmission is a five-speed manual gearbox with a fully automatic mode.

Our ecoFLEX models combine superb performance, reduced CO₂ emissions and highly competitive economy figures.

CORSA FEATURES/OPTIONS

SAFETY

Driver/passenger airbags

- Driver's dual-stage airbag • Front passenger's dual-stage airbag • Front seat side-impact airbags
- Full-size curtain airbags

Seating

- Height-adjustable front seat head restraints • Adjustable outer rear seat head restraints
- Centre rear seat head restraint (Elite models only) • Anti-submarining ramps in all seats – Prevents occupants sliding underneath the lap belt during a collision

Seatbelts

- Height-adjustable front seatbelts • Three inertia-reel lap and diagonal rear seatbelts • Front seatbelt pretensioner system – Pretensioners tighten the seatbelt in the event of an accident limiting forward movement • Front seatbelt force limiters – Reduces potential upper body injuries during a frontal impact • Front and rear 'seatbelt unfastened' audible warning and warning light

Child safety

- Deactivation switch for front passenger's airbag – Permits the safe use of a child seat in the front passenger seat • ISOFIX child seat mountings incorporating top tether anchor points located on outer rear seats (does not include child seat) – Allows ISOFIX child safety seats to be securely fixed into the car. The ISOFIX mounting system reduces forward movement in an accident and makes the child seat easier to install • Child-proof locks on rear doors

Driver/passenger safety

- Energy-absorbing steering column • Pedal release system – Reduces potential injury to the driver's legs and feet during a severe frontal impact • Laminated windscreen • Side-impact protection beams • Reinforced passenger safety cell

Pedestrian safety

- Bonnet/headlight/wiper structure – Designed to reduce pedestrian head and upper body injuries
- Upper and lower bumper design – Reduces upper and lower leg injuries

Stability

Electronic Stability Programme (ESP):

– Works in conjunction with the vehicle's electronic braking and engine systems to keep the car stable in many different situations. ESP monitors many different inputs to determine when the car starts to lose traction, it can then immediately respond by varying the brake pressure between up to three wheels and adjust the engine output to help correct the loss of traction and improve stability.

Additional ESP features:

- Traction control • Cornering brake control • Straight line stability control • Drag torque control – Maintain stability on slippery roads when lifting off the accelerator or changing gear

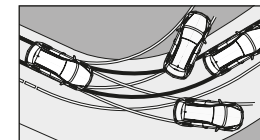

Braking

Anti-lock Braking System (ABS):

– Prevents the vehicle's wheels from locking up under heavy braking by momentarily reducing brake pressure at the appropriate wheel, ensuring that you can maintain control of the steering

Additional braking features:



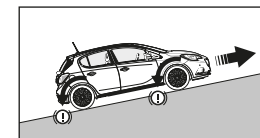





- The same electronic systems used in the ABS and ESP also deliver exceptional braking performance
- Emergency brake assist – When emergency braking is detected the vehicle automatically applies the maximum possible braking assistance • Electronic brakeforce distribution – Automatically apportions the optimum braking force to each wheel • Adaptive brake lights – Automatically warns other road users of heavy braking
- Hill start assist – Briefly maintains rear brake pressure to stop the vehicle rolling back on an incline • Hazard warning lights

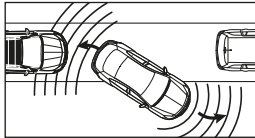

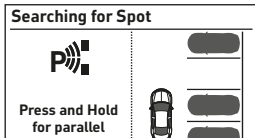
Tyre pressure

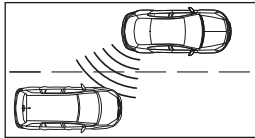

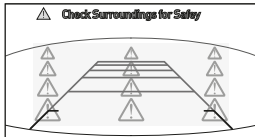

- Tyre pressure monitoring system

CORSA FEATURES/OPTIONS

| DRIVER ASSISTANCE | | Sting | Sting R | Energy | Limited Edition | Red/Black Edition | Design | SRi | SRi VX-Line | SE | Elite | Price (£) exc. VAT | Total (£) inc. VAT |
|---|--|-------|---------|--------|-----------------|-------------------|--------|-----|-------------|----|-------|--------------------|--------------------|
| Cruise control with speed limiter <i>Cruise control feature – enables you to maintain a constant speed – making it ideal for economical motorway driving.</i> • The speed limiter function – can be set to ensure that you do not exceed the speed limit and can be easily overridden if required. • Steering wheel mounted controls | | ● | ● | ● | ● | ● | ● | ● | ● | ● | ● | | |
| Parking sensors • Front and rear parking distance sensors • Audible warning (Design and Energy models upgraded to six speakers) • Distance warning graphic shown in driver information display  | | ○ | ○ | ○ | ○ | ○ | ○ | ○ | ○ | ● | ● | 383.33 | 460.00 |
|  Easier parking | | | | | | | | | | | | | |
| Advanced park assist with side blind spot alert <i>Park assist helps you find suitable parking spaces. The system automatically steers into the parking space, you just drive forwards or backwards as directed.</i> • Ultrasonic side sensors with 3 metre range • Ultrasonic front and rear parking sensors with a 1.5 metre range • Fully automated steering • Detailed forward/reverse instructions are shown in the instrument cluster Please note: Body-colour door mirrors with black mirror frames are added to Energy and SRi models.  | | | | ○ | ○ | ○ | | ○ | ○ | | | 420.83 | 505.00 |
|  Finds suitable parking spaces | | | | | | | | | | | | | |
|  Auto steers into the parking space for you | | | | | | | | | | | | | |
| Side blind spot alert: <i>Side blind spot alert helps prevent potential collisions with other vehicles 'hidden' in the vehicle's side blind spots. If a vehicle enters one of the blind spots a warning light illuminates in the relevant door mirror.</i> • LED warning light in door mirrors • Audible warning is sounded if the indicators are used and the system has detected another vehicle  | | | | | | | | | | ○ | ○ | 45.83 | 55.00 |
|  Warns of vehicles in your blind spot | | | | | | | | | | | | | |
| Rear-view camera <i>The rear-view camera gives a clear view of the area behind your car and helps place the car perfectly, without needing to strain your neck.</i> • Activated when reverse gear selected • Camera view appears in infotainment screen • Rear bumper and one-metre grid lines shown as reference points Please note: Only available in conjunction with parking sensors or advanced park assist. Not available with CD 30 BT audio unit or Flex-Fix® bicycle-carrier options.  | | | | ○ | ○ | ○ | ○ | ○ | ○ | ○ | ● | 175.00 | 210.00 |
|  See what's behind you on the central screen | | | | | | | | | | | | | |

● = Standard equipment. ○ = Optional at extra cost.

CORSA FEATURES/OPTIONS

| | Sting | Sting R | Energy | Limited Edition | Red/Black Edition | Design | SRi | SRi VX-Line | SE | Elite | Price (£) exc. VAT | Total (£) inc. VAT | | | | | | | | | | | | | | | | | | | | | | | | | | | | | | | | | | | | | |
|--|-------|---------|--------|-----------------|-------------------|--------|-----|-------------|----|-------|--------------------|--------------------|--|--|--|--|--|--|--|--|--|--|--------|--------|---|---|---|---|---|---|---|---|---|---|---|--|--|--|--|--|--|--|--|--|--|--|--|--|--|
| DRIVER ASSISTANCE | | | | | | | | | | | | | | | | | | | | | | | | | | | | | | | | | | | | | | | | | | | | | | | | | |
| Driving Assistance Pack (deletes City mode steering) <i>A wide range of class-leading driver assistance and safety features are controlled by the front camera system.</i> | | | | | | | | | | | | | | | | | | | | | | | | | | | | | | | | | | | | | | | | | | | | | | | | | |
| Forward collision alert: <i>The system warns you when approaching another vehicle too quickly – operates at speeds above 25mph.</i> | | | | | | | | | | | | | | | | | | | | | | | | | | | | | | | | | | | | | | | | | | | | | | | | | |
| <ul style="list-style-type: none"> • Visual warnings – projected onto windscreen and shown in the instrument cluster • Audible warning • Sensitivity can be adjusted via a steering wheel mounted control | | | | | | | | | | | | | | | | | | | | | | | | | | | | | | | | | | | | | | | | | | | | | | | | | |
|  | | | | | | | | | | | | | | | | | | | | | | | | | | | | | | | | | | | | | | | | | | | | | | | | | |
| <p>✓ Warns you of potential accidents</p> | | | | | | | | | | | | | | | | | | | | | | | | | | | | | | | | | | | | | | | | | | | | | | | | | |
| Traffic sign recognition: <i>Detects and then displays speed limits, reducing uncertainty and the risk of speeding.</i> | | | | | | | | | | | | | | | | | | | | | | | | | | | | | | | | | | | | | | | | | | | | | | | | | |
| <ul style="list-style-type: none"> • Recognises different road signs, including temporary speed restrictions • Displays reminder in the instrument cluster | | | | | | | | | | | | | | | | | | | | | | | 550.00 | 660.00 | | | | | | | | | | | | | | | | | | | | | | | | | |
|  | | | | | | | | | | | | | | | | | | | | | | | | | | | | | | | | | | | | | | | | | | | | | | | | | |
| <p>✓ Always know the speed limit</p> | | | | | | | | | | | | | | | | | | | | | | | | | | | | | | | | | | | | | | | | | | | | | | | | | |
| Following distance indicator: <i>At speeds above 25mph indicates how many seconds you are behind the vehicle in front – helping you maintain a safe distance.</i> | | | | | | | | | | | | | | | | | | | | | | | | | | | | | | | | | | | | | | | | | | | | | | | | | |
| <ul style="list-style-type: none"> • Timings are shown in the instrument cluster | | | | | | | | | | | | | | | | | | | | | | | | | | | | | | | | | | | | | | | | | | | | | | | | | |
|  | | | | | | | | | | | | | | | | | | | | | | | | | | | | | | | | | | | | | | | | | | | | | | | | | |
| <p>✓ Keeps a safe distance</p> | | | | | | | | | | | | | | | | | | | | | | | | | | | | | | | | | | | | | | | | | | | | | | | | | |
| Lane departure warning: <i>If the driver has not actively steered or signalled, the lane departure warning system warns when the car moves outside of lane markings at speeds above 37mph.</i> | | | | | | | | | | | | | | | | | | | | | | | | | | | | | | | | | | | | | | | | | | | | | | | | | |
| <ul style="list-style-type: none"> • Warning light in instrument cluster • Audible warning • Facia on/off switch | | | | | | | | | | | | | | | | | | | | | | | | | | | | | | | | | | | | | | | | | | | | | | | | | |
|  | | | | | | | | | | | | | | | | | | | | | | | | | | | | | | | | | | | | | | | | | | | | | | | | | |
| <p>✓ Keeps you in lane</p> | | | | | | | | | | | | | | | | | | | | | | | | | | | | | | | | | | | | | | | | | | | | | | | | | |
| Additional features: | | | | | | | | | | | | | | | | | | | | | | | | | | | | | | | | | | | | | | | | | | | | | | | | | |
| <ul style="list-style-type: none"> • Automatically dimming anti-dazzle rear-view mirror • Models with rain-sensitive windscreen wipers, automatic lighting control and bi-xenon headlights additionally feature headlight high beam assist | | | | | | | | | | | | | | | | | | | | | | | | | | | | | | | | | | | | | | | | | | | | | | | | | |
| Steering | | | | | | | | | | | | | | | | | | | | | | | | | | | | | | | | | | | | | | | | | | | | | | | | | |
| <ul style="list-style-type: none"> • Speed-sensitive electric power-assisted steering • City mode button – Provides lighter steering at parking speeds (deleted if Driving Assistance Pack is specified) | | | | | | | | | | | | | | | | | | | | | | | | | | | | | | | | | | | | | | | | | | | | | | | | | |
| <table border="0"> <tr> <td>●</td><td>●</td><td>●</td><td>●</td><td>●</td><td>●</td><td>●</td><td>●</td><td>●</td><td>●</td><td>●</td> <td></td><td></td> </tr> </table> | | | | | | | | | | | | | | | | | | | | | | | | | ● | ● | ● | ● | ● | ● | ● | ● | ● | ● | ● | | | | | | | | | | | | | | |
| ● | | | | | | | | | | | | | | | | | | | | | | | | | ● | ● | ● | ● | ● | ● | ● | ● | ● | ● | | | | | | | | | | | | | | | |
| <table border="0"> <tr> <td>○</td><td>○</td><td>○</td><td>○</td><td>○</td><td>○</td><td>○</td><td>○</td><td>○</td><td>○</td><td>○</td> <td></td><td></td> </tr> </table> | | | | | | | | | | | | | | | | | | | | | | | | | ○ | ○ | ○ | ○ | ○ | ○ | ○ | ○ | ○ | ○ | ○ | | | | | | | | | | | | | | |
| ○ | ○ | ○ | ○ | ○ | ○ | ○ | ○ | ○ | ○ | ○ | | | | | | | | | | | | | | | | | | | | | | | | | | | | | | | | | | | | | | | |

● = Standard equipment. ○ = Optional at extra cost.

CORSA FEATURES/OPTIONS

| | Sting | Sting R | Energy | Limited Edition | Red/Black Edition | Design | SRi | SRi VX-Line | SE | Elite | Price (£) exc. VAT | Total (£) inc. VAT |
|--|-------|---------|--------|-----------------|-------------------|--------|-----|-------------|----|-------|--------------------|--------------------|
| SECURITY | | | | | | | | | | | | |
| Standard security features <ul style="list-style-type: none"> • 'Key left in ignition' audible warning • Electronically protected audio equipment • Engine deadlock immobiliser • Visible Vehicle Identification Number (VIN) • Locking wheel bolts for alloy wheels (where fitted) • Door-to-door illumination | ● | ● | ● | ● | ● | ● | ● | ● | ● | ● | | |
| Central locking <ul style="list-style-type: none"> • Remote control • Operates on doors, tailgate and fuel filler flap • Deadlocking • Central locking activation switch on facia • One folding key/one static key each with integral remote control function | ● | ● | ● | ● | ● | ● | ● | ● | ● | ● | | |
| Security alarm system <ul style="list-style-type: none"> • Remote control (operates in conjunction with central locking) • Ultrasonic interior sensors • Tilt sensor • Thatcham approved | ○ | ○ | ○ | ○ | ○ | ○ | ○ | ○ | ○ | ● | 216.67 | 260.00 |
| DRIVER INFORMATION | | | | | | | | | | | | |
| Instrumentation <ul style="list-style-type: none"> • Speedometer • Rev counter • Digital fuel gauge with low fuel level warning light • Digital water temperature gauge • Instrument panel light dimmer • Shift-up indication light <i>– Indicates when to change gear for optimum fuel economy</i> | ● | ● | ● | ● | ● | ● | ● | ● | ● | ● | | |
| Driver information display (centrally located in instrument cluster) <ul style="list-style-type: none"> • Displays trip computer data • Total mileage • Service-due indicator • Oil life • Tyre pressure monitoring system • Headlight/brake light bulb failure warning | ● | ● | ● | ● | ● | ● | ● | ● | ● | ● | | |
| Red graphics on black background | ● | ● | | | | | | | | | | |
| Red graphics on black background (fitted in lieu of white graphics on 1.4i (75PS) and 1.4i (90PS) models if CD 30 BT audio unit is fitted in lieu of IntelliLink. Where digital speedometer and digital over-speed warning are standard, these features will be deleted. Not available separately. Please note: If optional Driving Assistance Pack or advanced park assist is fitted, then the standard driver information display is retained) | | | ● | ● | | ● | ● | ● | | | | |
| White graphics on black background | | | ● | ● | ● | ● | ● | ● | ● | ● | | |
| Central facia display (format dependent on infotainment unit) <ul style="list-style-type: none"> • Audio information • Digital clock with automatic RDS time adjustment • Outside air temperature with ice warning function • Additional features dependent on infotainment unit (see infotainment for details) | ● | ● | ● | ● | ● | ● | ● | ● | ● | ● | | |
| Multi-function trip computer (displayed on driver information display) <ul style="list-style-type: none"> • Trip mileage • Vehicle range based on remaining fuel • Average speed • Average fuel economy • Instantaneous fuel economy • Digital speedometer • Digital over-speed warning | | | | ● | ● | | ● | ● | ● | ● | | |

● = Standard equipment. ○ = Optional at extra cost.

CORSA FEATURES/OPTIONS

| INTERIOR STYLING | Sting | Sting R | Energy | Limited Edition | Red/Black Edition | Design | SRi | SRi VX-Line | SE | Elite | Price (£) exc. VAT | Total (£) inc. VAT |
|--|-------|---------|--------|-----------------|-------------------|--------|-----|-------------|----|-------|--------------------|--------------------|
| Sting interior décor <i>Steering wheel:</i> • Three-spoke design • Leather-covered • Satin chrome-effect bezel <i>Facia and door trim:</i> • Piano black facia • Black door panels with black Atlantis cloth inserts • Chrome-effect interior door handles <i>Seat trim:</i> • Spot Shimmer black fabric seat trim inserts • Plain black fabric side bolsters and surrounds | ● | | | | | | | | | | | |
| Sting R interior décor <i>Steering wheel:</i> • VX-Line three-spoke design • Leather-covered flat bottom • Satin chrome-effect bezel <i>Gear knob:</i> • VX-Line leather-covered <i>Facia and door trim:</i> • Piano black facia • Black door panels with black Atlantis cloth inserts • Chrome-effect interior door handles <i>Seat trim:</i> • Spot Shimmer black fabric seat trim inserts • Plain black fabric side bolsters and surrounds | | ● | | | | | | | | | | |
| Energy interior décor <i>Steering wheel:</i> • Three-spoke design • Leather-covered • Satin chrome-effect bezel <i>Facia and door trim:</i> • Rhutenium facia with chrome-effect trim inserts • Black door panels with black Atlantis cloth inserts • Chrome-effect interior door handles <i>Seat trim:</i> • Mora black fabric seat trim inserts • Plain black fabric side bolsters and surrounds | | | ● | | | | | | | | | |
| Limited Edition interior décor with Lace cloth seat trim <i>Steering wheel:</i> • VX-Line three-spoke design • Leather-covered flat bottom • Satin chrome-effect bezel <i>Gear knob:</i> • VX-Line leather-covered <i>Facia and door trim:</i> • Piano black facia with white inserts (fitted to Royal Blue, Flaming Yellow, Lime Green and Persian Blue models. All other exterior colours feature red inserts) • Black door panels with black Atlantis cloth inserts • Chrome-effect interior door handles <i>Seat trim:</i> • Black Lace fabric seat trim inserts • Plain black fabric side bolsters and surrounds with accent stitching | | | | ● | | | | | | | | |
| Red Edition/Black Edition interior décor with Lace cloth seat trim <i>Steering wheel:</i> • VX-Line three-spoke design • Leather-covered flat bottom • Satin chrome-effect bezel <i>Gear knob:</i> • VX-Line leather-covered <i>Facia and door trim:</i> • Piano black facia with white inserts (Black Edition models) • Piano black facia with red inserts (Red Edition models) • Black door panels with black Atlantis cloth inserts • Chrome-effect interior door handles <i>Seat trim:</i> • Black Lace fabric seat trim inserts • Plain black fabric side bolsters and surrounds with accent stitching | | | | | ● | | | | | | | |
| Limited Edition/Black Edition interior décor with Network Moonray cloth seat trim (not available on Royal Blue models) <i>Steering wheel:</i> • VX-Line three-spoke design • Leather-covered flat bottom • Satin chrome-effect bezel <i>Facia and door trim:</i> • Piano black facia with white trim inserts • Black door panels with black Atlantis cloth inserts • Chrome-effect interior door handles <i>Seat trim:</i> • Network Moonray cloth seat trim inserts • Piano black facia side bolsters and surrounds | | | | ○ | ○ | | | | | | 133.33 | 160.00 |

● = Standard equipment. ○ = Optional at extra cost.

CORSA FEATURES/OPTIONS

| INTERIOR STYLING | Sting | Sting R | Energy | Limited Edition | Red/Black Edition | Design | SRI | SRI VX-Line | SE | Elite | Price (£) exc. VAT | Total (£) inc. VAT |
|--|-------|---------|--------|-----------------|-------------------|--------|-----|-------------|-----|-------|--------------------|--------------------|
| <p>Limited Edition interior décor with Cityscape cloth seat trim (not available on Royal Blue, Lava Red, Flaming Yellow or Lime Green models)</p> <p>Steering wheel: • VX-Line three-spoke design • Leather-covered flat bottom • Satin chrome-effect bezel</p> <p>Facia and door trim: • Piano black facia with Persian Blue trim inserts • Black door panels with black Atlantis cloth inserts • Chrome-effect interior door handles</p> <p>Seat trim: • Cityscape cloth seat trim inserts • Piano black facia side bolsters and surrounds</p> | | | | ○ | | | | | | | 133.33 | 160.00 |
| <p>Design interior décor</p> <p>Steering wheel: • Three-spoke design • Leather-covered • Satin chrome-effect bezel</p> <p>Facia and door trim: • Rhutenium facia with chrome-effect trim inserts • Black door panels with black Atlantis cloth inserts • Chrome-effect interior door handles</p> <p>Seat trim: • Spot Shimmer black fabric seat trim inserts • Plain black fabric side bolsters and surrounds</p> | | | | | | ● | | | | | | |
| <p>SRI/SRI VX-Line interior décor</p> <p>Steering wheel: • Three-spoke design • Leather-covered with accent stitching • Satin chrome-effect bezel</p> <p>Facia and door trim: • Piano black facia with red trim inserts (except Royal Blue models, which feature a white trim insert) • Black door panels with black Atlantis cloth inserts • Chrome-effect interior door handles</p> <p>Seat trim: • Lace black fabric seat trim inserts • Plain black fabric side bolsters and surrounds with accent stitching</p> | | | | | | | ● | ● | | | | |
| <p>SE/Elite interior décor with Graphic Embossed black cloth/Morrocana seat trim</p> <p>Steering wheel: • Three-spoke design • Leather-covered with accent stitching • Satin chrome-effect bezel</p> <p>Facia and door trim: • Rhutenium facia with chrome-effect trim inserts • Black door panels with black Morrocana inserts • Chrome-effect interior door handles</p> <p>Seat trim: • Graphic Embossed black cloth seat trim inserts • Black Morrocana side bolsters and surrounds</p> <p>Front door sill covers: • Alloy-effect</p> | | | | | | | | | ● | ● | | |
| <p>SE/Elite interior décor with Hysle Embossed Atmosphere cloth/Morrocana seat trim</p> <p>Steering wheel: • Three-spoke design • Leather-covered with accent stitching • Satin chrome-effect bezel</p> <p>Facia and door trim: • Matt Bronze-effect facia with chrome-effect trim inserts • Atmosphere glovebox lid • Black door panels with Atmosphere Morrocana inserts • Chrome-effect interior door handles</p> <p>Seat trim: • Hysle Embossed Atmosphere cloth seat trim inserts • Atmosphere Morrocana side bolsters and surrounds</p> <p>Front door sill covers: • Alloy-effect</p> | | | | | | | | | N/C | N/C | | No-cost option |







● = Standard equipment. ○ = Optional at extra cost. N/C = No-cost option.

CORSA FEATURES/OPTIONS

| INFOTAINMENT | Sting | Sting R | Energy | Limited Edition | Red/Black Edition | Design | SRi | SRi VX-Line | SE | Elite | Price (£) exc. VAT | Total (£) inc. VAT |
|--|-------|---------|--------|-----------------|-------------------|--------|-----|-------------|-----|-------|--------------------|--------------------|
| CD 30 BT Onboard features: • CD/MP3 CD player • AM/FM stereo radio with 36 station presets • RDS with Traffic Programme Media connections: • USB connection with iPod control • Aux-in socket Mobile phone portal: • Bluetooth® connectivity • Handsfree calls via steering wheel controls • Vehicle microphone • Phone book access Please note: On 1.4i (75PS) and 1.4i (90PS) models the trip computer including digital speedometer and digital over-speed warning are deleted. | ● | ● | N/C | N/C | N/C | N/C | N/C | N/C | N/C | | | |
| R4.0 IntelliLink touchscreen infotainment system <i>For use with MP3 players, USB memory sticks, mobile phones and smartphone apps</i> Onboard features: • 7-inch colour touchscreen • DAB digital radio/AM/FM stereo radio with 36 station presets • RDS with Traffic Programme Media connections: • USB connection with iPod control • Bluetooth® A2DP audio streaming (Advanced Audio Distribution Profile) Mobile phone portal: • Bluetooth® connectivity • Handsfree calls via steering wheel controls • Vehicle microphone • Phone book access – <i>Contacts/last calls/missed calls etc. are mirrored on IntelliLink's display and are easily navigated using the touchscreen (features dependent on mobile phone)</i> Smartphone interface: • Apple CarPlay™ • Android Auto™ | | | ● | ● | ● | ● | ● | ● | ● | | | |
| Digital radio | | | ● | ● | ● | ● | ● | ● | ● | ● | | |
| Six speakers | ● | ● | ● | ● | ● | ● | ● | ● | ● | ● | | |
| Wireless charger for mobile devices (only available with R4.0 IntelliLink and Navi 4.0 IntelliLink. Maximum device dimensions 150mm x 79.88mm)  Wireless mobile charging | | | ○ | ○ | ○ | ○ | ○ | ○ | ○ | ○ | 133.33 | 160.00 |
| Steering wheel mounted audio controls | ● | ● | ● | ● | ● | ● | ● | ● | ● | ● | | |



● = Standard equipment. N/C = No-cost option.

CORSA FEATURES/OPTIONS

| INFOTAINMENT | | | | | Sting | Sting R | Energy | Limited Edition | Red/Black Edition | Design | SRi | SRi VX-Line | SE | Elite | Price (£) exc. VAT | Total (£) inc. VAT |
|--|--|---|--|--|-------|---------|--------|-----------------|-------------------|--------|-----|-------------|----|-------|--------------------|--------------------|
|  <p>Automatic Crash Response</p> |  <p>Wi-Fi Hotspot</p> |  <p>Smartphone App</p> |  <p>Stolen Vehicle Assistance</p> |  <p>Vehicle Diagnostics</p> | | | | | | | | | | | | |
| <p>Vauxhall OnStar – your personal on board assistant*</p> <p><i>Many car brands talk about innovation as soon as they improve their cup holders but this innovative system, now available on selected models**, is revolutionary: 24/7, 365 days a year, Vauxhall OnStar puts you in touch with a trained advisor, not a machine. With OnStar you have access to a host of innovations, from Vehicle Diagnostics and Smartphone Function to a fully integrated 4G Wi-Fi Hotspot†. In the event of an accident, Vauxhall OnStar even automatically calls for help, for an incomparable feeling of safety.</i></p> <p>* = Includes 12 months of OnStar services from date of first registration and a 3 month/3 GB Wi-Fi free trial period (whichever comes first) effective from the date the customer accepts the nominated network operator Wi-Fi T's&C's. Does not include destination download feature. Theft alert feature only operates on models fitted with security alarm system.</p> <p>** = The OnStar Services require activation and are subject to mobile network coverage and availability. Wi-Fi Hotspot service requires account with nominated network operator.</p> <p>† = 4G is subject to mobile network coverage and availability. Charges apply after the free trial period. The OnStar subscription packages could be different from the services included in the free trial package. Check www.vauxhall.co.uk/onstar for terms and conditions, details of availability, coverage and charges.</p> | | | | | | | ○ | ● | ● | ○ | ○ | ○ | ● | ● | 337.50 | 405.00 |
|  | | | | | | | | | | | | | | | | |

● = Standard equipment. ○ = Optional at extra cost.

CORSA FEATURES/OPTIONS

| | Sting | Sting R | Energy | Limited Edition | Red/Black Edition | Design | SRi | SRi VX-Line | SE | Elite | Price (£) exc. VAT | Total (£) inc. VAT |
|---|-------|---------|--------|-----------------|-------------------|--------|-----|-------------|----|-------|--------------------|--------------------|
| HEATING AND VENTILATION Air blend heater <ul style="list-style-type: none"> Cabin particulate filter – <i>Removes dust, airborne particles and pollen</i> Four-speed fan • Illuminated controls | ● | ● | | | | | | | | | | |
| Air conditioning <ul style="list-style-type: none"> Air recirculation facility • Cabin particulate filter – <i>Removes dust, airborne particles and pollen</i> Four-speed fan • Illuminated controls Please note: Non air-conditioned Energy 1.4i (75PS) and 1.4i (90PS) manual models are also available. | ○ | ○ | ● | ● | ● | ● | ● | ● | ● | | 445.83 | 535.00 |
| Electronic climate control incorporating air conditioning <ul style="list-style-type: none"> Single-zone control Advanced predictive logic control system using sun sensor Cabin charcoal filter – <i>Removes dust, airborne particles, pollen and unpleasant odours</i> Automatic air direction and fan speed with manual override • LCD temperature display Six-speed fan • Illuminated controls Please note: Not available on non air-conditioned Energy models  Set and forget temperature control | | | ○ | ○ | ○ | ○ | ○ | ○ | ○ | ● | 337.50 | 405.00 |
| Winter Pack <ul style="list-style-type: none"> Heated leather-covered steering wheel • Heated front seats  Warm welcome  | | | ● | ○ | ○ | ○ | ○ | ○ | ● | ● | 191.67 | 230.00 |
| Additional features <ul style="list-style-type: none"> Four adjustable facia vents • Windscreen demist vents • Side window demist vents Heated rear screen with timed cut-off | ● | ● | ● | ● | ● | ● | ● | ● | ● | ● | | |

● = Standard equipment. ○ = Optional at extra cost.

CORSA FEATURES/OPTIONS

| SEATING AND COMFORT | Sting | Sting R | Energy | Limited Edition | Red/Black Edition | Design | SRi | SRi VX-Line | SE | Elite | Price (£) exc. VAT | Total (£) inc. VAT |
|--|-------|---------|--------|-----------------|-------------------|--------|-----|-------------|----|-------|--------------------|--------------------|
| Reach and rake adjustable steering | ● | ● | ● | ● | ● | ● | ● | ● | ● | ● | | |
| Comfort front seats <i>Driver's seat (eight-way adjustable):</i> • Height (up/down) • Reach (fore/aft) • Backrest (upright/recline) • Head restraint (up/down) <i>Front passenger's seat (six-way adjustable):</i> • Reach (fore/aft) • Backrest (upright/recline) • Head restraint (up/down) | ● | ● | ● | | | ● | | | ● | ● | | |
| Sports-style front seats <i>Driver's seat (eight-way adjustable):</i> • Height (up/down) • Reach (fore/aft) • Backrest (upright/recline) • Head restraint (up/down) <i>Front passenger's seat (six-way adjustable):</i> • Reach (fore/aft) • Backrest (upright/recline) • Head restraint (up/down) | | | | ● | ● | | ● | ● | | | | |
| Easy-entry front seats with memory function (three-door models only) | ● | ● | ● | ● | ● | ● | ● | ● | ● | | | |
| Front passenger's seat height adjuster (fitted at no extra cost in conjunction with optional glass sunroof) | ○ | ○ | ○ | ○ | ○ | ○ | ○ | ○ | ○ | ○ | 54.17 | 65.00 |
| Rear seats • Three-person layout • Adjustable backrest • Height-adjustable and removable outer head restraints • ISOFIX child seat mountings incorporating top tether anchor points located on outer rear seats (does not include child seat) – <i>Allows ISOFIX child safety seats to be securely fixed into the car. The ISOFIX mounting system reduces forward movement in an accident and makes the child seat easier to install</i> • Child-proof locks on rear doors | ● | ● | ● | ● | ● | ● | ● | ● | ● | ● | | |
| • Height-adjustable and removable centre head restraint | | | | | | | | | | ● | | |
| • One-piece folding rear seat | ● | ● | ● | ● | ● | ● | ● | ● | | | | |
| • 60/40 split-folding rear seat back | ○ | ○ | ○ | ○ | ○ | ○ | ○ | ○ | ● | ● | 116.67 | 140.00 |

● = Standard equipment. ○ = Optional at extra cost.

CORSA FEATURES/OPTIONS

| | Sting | Sting R | Energy | Limited Edition | Red/Black Edition | Design | SRi | SRi VX-Line | SE | Elite | Price (£) exc. VAT | Total (£) inc. VAT |
|---|-------|---------|--------|-----------------|-------------------|--------|-----|-------------|----|-------|--------------------|--------------------|
| INTERIOR CONVENIENCE | | | | | | | | | | | | |
| Convenience features • Front 12-volt electrical accessory socket • Driver's and front passengers sunvisors • Driver's vanity mirror • Dipping rear-view mirror • Driver's and front passenger's tiltable assist handles • Two rear tiltable passenger assist handles (five-door models only) | ● | ● | ● | ● | ● | ● | ● | ● | ● | ● | | |
| Driver's and front passenger's vanity mirrors with flip-up cover | | | ● | ● | ● | ● | ● | ● | ● | ● | | |
| Automatically dimming anti-dazzle rear-view mirror | | | ● | □ | □ | □ | ● | ● | ● | ● | | |
| Velour floor mats | | | | | | | | | | ● | | |
| Interior lighting • Central front courtesy light • Central rear courtesy light • Fade up/fade down • Front map reading lights • Rear reading light (five-door models only) | ● | ● | ● | ● | ● | ● | ● | ● | ● | ● | | |
| Interior storage • Storage box on driver's side lower facia • Glovebox with lid • Front door pockets • Drinks holder in centre console • Rear door pockets (five-door models only) • Rear bottle holders (three-door models only) | ● | ● | ● | ● | ● | ● | ● | ● | ● | ● | | |
| • Front passenger's underseat storage tray (deleted if optional sunroof is fitted) | | | | | | | ● | ● | | | | |
| • Storage pockets on front seat backs | | | | | | | | | ● | ● | | |
| Luggage area • Luggage compartment cover • Stowage facility for luggage compartment cover behind rear seats • Illuminated luggage area • Interior tailgate handles • Load restraint lashing eyes • Twin gas-assisted tailgate struts | ● | ● | ● | ● | ● | ● | ● | ● | ● | ● | | |
| MECHANICAL | | | | | | | | | | | | |
| Standard features • Front-wheel drive • Gas-pressure dampers • Front anti-roll bar • Speed-sensitive electric power-assisted steering | ● | ● | ● | ● | ● | ● | ● | ● | ● | ● | | |
| Sports suspension (fitted to SE models in conjunction with optional 17-inch wheels. Not available separately. Elite models with optional 16-inch alloy wheels are fitted with standard suspension in place of sports suspension) | | ● | | ● | ● | | | ● | ○ | ● | | |
| Transmissions Five-speed manual gearbox (excluding 1.0i Turbo (90PS)/(115PS) and 1.4i Turbo (100PS) models) | ● | | ● | ● | | ● | ● | ● | ● | ● | | |
| Six-speed manual gearbox (1.0i Turbo (90PS)/(115PS), 1.4i Turbo (100PS) and 1.4i Turbo (150PS) models) | | ● | ● | ● | ● | ● | ● | ● | ● | ● | | |
| Easytronic five-speed transmission with sequential manual gearshift or automatic mode (1.4i (90PS)/1.3CDTi (95PS) models only) | | | ▲ | | | ▲ | | | | | | |
| Six-speed automatic transmission (1.4i (90PS) models only) | | | ▲ | | | ▲ | ▲ | ▲ | ▲ | ▲ | | |

● = Standard equipment. ○ = Optional at extra cost. ▲ = See price pages for details. □ = Available as part of an extra-cost option pack.

CORSA FEATURES/OPTIONS

| EXTERIOR LIGHTING | Sting | Sting R | Energy | Limited Edition | Red/Black Edition | Design | SRi | SRi VX-Line | SE | Elite | Price (£) exc. VAT | Total (£) inc. VAT |
|---|-------|---------|--------|-----------------|-------------------|--------|-----|-------------|----|-------|--------------------|--------------------|
| Standard lighting features <ul style="list-style-type: none"> • Welcome lighting • Lights-on audible warning • Electric headlight beam levelling • High-level LED centre rear brake light • Rear fog light | ● | ● | ● | ● | ● | ● | ● | ● | ● | ● | | |
| Halogen headlights | ● | ● | ● | ● | ● | ● | ● | ● | ● | | | |
| Bi-xenon headlights with cornering light  Brighter headlights for better visibility | | | | ○ | ○ | | | ○ | ○ | ● | 337.50 | 405.00 |
| Daytime running lights | ● | ● | | | | | | | | | | |
| LED daytime running lights | | | ● | ● | ● | ● | ● | ● | ● | ● | | |
| Front fog lights with black surround | | | ● | ● | ● | ● | | | | | | |
| Front fog lights with chrome-effect surround | | | | | | | ● | ● | ● | ● | | |
| Sight and Light Pack One (not available with Driving Assistance Pack) <ul style="list-style-type: none"> • Rain-sensitive windscreen wipers • Automatic lighting control • Automatically dimming anti-dazzle rear-view mirror | | | ● | ○ | ○ | ○ | ● | ● | ● | ● | 200.00 | 240.00 |
| Sight and Light Pack Two (only available with Driving Assistance Pack) <ul style="list-style-type: none"> • Rain-sensitive windscreen wipers • Automatic lighting control | | | ● | ○ | ○ | ○ | ● | ● | ● | ● | 175.00 | 210.00 |

● = Standard equipment. ○ = Optional at extra cost.

CORSA FEATURES/OPTIONS

| EXTERIOR CONVENIENCE | Sting | Sting R | Energy | Limited Edition | Red/Black Edition | Design | SRI | SRI VX-Line | SE | Elite | Price (£) exc. VAT | Total (£) inc. VAT |
|--|-------|---------|--------|-----------------|-------------------|--------|-----|-------------|----|-------|--------------------|--------------------|
| Windscreen wipers • Two-speed windscreen wipers with variable intermittent wipe • Intermittent rear window wash/wipe | ● | ● | ● | ● | ● | ● | ● | ● | ● | ● | | |
| • Rain-sensitive windscreen wipers | | | ● | □ | □ | □ | ● | ● | ● | ● | | |
| Door mirrors • Manually foldable door mirrors | ● | ● | ● | ● | ● | ● | ● | ● | ● | ● | | |
| • Electrically adjustable door mirrors (wide-angle on driver's side), manually foldable | ● | ● | | | | ● | | | | | | |
| • Electrically adjustable/heated door mirrors (wide-angle on driver's side, except in conjunction with advanced park assist), manually foldable | | | ● | ● | ● | | ● | ● | ● | ● | | |
| Windows • Heated windscreen • Electrically operated front windows with safety autoreverse and one-touch facility • Heated rear window | ● | ● | ● | ● | ● | ● | ● | ● | ● | ● | | |
| Electrically operated slide/tilt panoramic glass sunroof • Manually operated interior blind • Non-metallic roof panel covering is coloured black • Front passenger's seat height adjuster Please note: Front passenger's underseat storage tray is deleted on SRI and SRI VX-Line models | | | | | | | | | | | 633.33 | 760.00 |
|  Enjoy fresh air at the touch of a button | | | | | | | | | | | | |
| Flex-Fix® integrated two-bicycle carrier system (not available with rear-view camera or spare wheel) Please note: Bicycle size restrictions apply, please contact your local Retailer for further information. | | | ○ | | | | ○ | | ○ | | 383.33 | 460.00 |







● = Standard equipment. ○ = Optional at extra cost. □ = Available as part of an extra-cost option pack.

CORSA FEATURES/OPTIONS

| EXTERIOR STYLING | Sting | Sting R | Energy | Limited Edition | Red/Black Edition | Design | SRi | SRi VX-Line | SE | Elite | Price (£) exc. VAT | Total (£) inc. VAT |
|--|-------|---------|--------|-----------------|-------------------|--------|-----|-------------|----|-------|--------------------|--------------------|
| Sting styling • Twin white stripes on bonnet, roof and tailgate • White door mirror housings • White front grille bar • Body-colour door handles | ● | | | | | | | | | | | |
| Sting R styling • Twin black stripes on bonnet, roof and tailgate • Mineral Black door mirror housings • Black front grille bar • Body-colour door handles • Chrome-effect exhaust tailpipe extension | | ● | | | | | | | | | | |
| Energy styling • Chrome-effect front grille bar • Body-colour door handles • Chrome-effect exhaust tailpipe extension (1.0i Turbo (115PS) models only) | | | ● | | | | | | | | | |
| Limited Edition/Red/Black Edition styling • Mineral Black door mirror housings • Black front grille bar • Body-colour door handles • Body-colour front lower spoiler/side sills/rear lower skirt • Body-colour rear roof spoiler (3-door models only) • Mineral Black roof • Chrome-effect exhaust tailpipe extension | | | | ● | ● | | | | | | | |
| Design/SRi styling • Chrome-effect front grille bar • Body-colour door handles | | | | | | ● | ● | | | | | |
| SRi VX-Line styling • Chrome-effect front grille bar • Body-colour door mirrors with black mirror frame • Body-colour door handles • Body-colour front lower spoiler/side sills/rear lower skirt • Body-colour rear roof spoiler (3-door models only) • Chrome-effect exhaust tailpipe extension | | | | | | | | ● | | | | |
| SE/ Elite styling • Chrome-effect front grille bar • Body-colour door mirrors with black mirror frame • Body-colour door handles • Chrome-effect lower side window mouldings (5-door models only) • Alloy-effect front door sill covers with 'Vauxhall' lettering | | | | | | | | | ● | ● | | |
| Black foil on B-pillars (not with Royal Blue or optional Mineral Black or Dark Sea Blue exterior colours) | ● | ● | ● | ● | ● | ● | ● | ● | ● | ● | | |
| Windows • Tinted windows | ● | ● | ● | ● | ● | ● | ● | ● | ● | ● | | |
| • Dark-tinted rear windows | | | | ● | ● | | | | | ● | | |

● = Standard equipment. ○ = Optional at extra cost.





CORSA FEATURES/OPTIONS

| EXTERIOR COLOURS | | Sting | Sting R | Energy | Limited Edition | Red/Black Edition | Design | SRi | SRi VX-Line | SE | Elite | Price (£) exc. VAT | Total (£) inc. VAT |
|---|--|-------|---------|--------|-----------------|-------------------|--------|-----|-------------|----|-------|--------------------|--------------------|
|  | Royal Blue • Solid paint • Not available with Network Moonray or Cityscape cloth trims | | | ● | ● | | ● | ● | ● | ● | ● | | |
|  | Flaming Yellow • Brilliant paint • 3-door models only • Not available with Cityscape cloth trim | ● | ● | ○ | ○ | | ○ | | | ○ | | 237.50 | 285.00 |
|  | Lava Red • Brilliant paint • Not available with Cityscape cloth trim • Standard on Red Edition models, not available on Black Edition models | ○ | ○ | ○ | ○ | ● | ○ | ○ | ○ | ○ | ○ | 237.50 | 285.00 |
|  | Summit White • Brilliant paint | | ○ | ○ | ○ | | ○ | ○ | ○ | ○ | ○ | 237.50 | 285.00 |
|  | Mineral Black • Two-coat metallic paint • Standard on Black Edition models, not available on Red Edition models | ○ | | ○ | ○ | ● | ○ | ○ | ○ | ○ | ○ | 462.50 | 555.00 |
|  | Sovereign Silver • Two-coat metallic paint | | ○ | ○ | ○ | | ○ | ○ | ○ | ○ | ○ | 462.50 | 555.00 |
|  | Satin Steel Grey • Two-coat metallic paint | | ○ | ○ | ○ | | ○ | ○ | ○ | ○ | ○ | 462.50 | 555.00 |

● = Standard equipment. ○ = Optional at extra cost.

The colours reproduced may vary slightly from the actual paint colour. As a result they should be used as a guide only. Your Vauxhall Retailer has a comprehensive display of our paint samples.





CORSA FEATURES/OPTIONS

| EXTERIOR COLOURS | | Sting | Sting R | Energy | Limited Edition | Red/Black Edition | Design | SRi | SRi VX-Line | SE | Elite | Price (£) exc. VAT | Total (£) inc. VAT |
|---|--|-------|---------|--------|-----------------|-------------------|--------|-----|-------------|----|-------|--------------------|--------------------|
|  | Persian Blue • Two-coat metallic paint | | | ○ | ○ | | ○ | | | ○ | ○ | 462.50 | 555.00 |
|  | Quantum Grey • Two-coat metallic paint | ○ | | ○ | ○ | | ○ | ○ | ○ | ○ | ○ | 462.50 | 555.00 |
|  | Dark Sea Blue • Two-coat pearlescent paint | ○ | | ○ | | | ○ | ○ | ○ | ○ | ○ | 462.50 | 555.00 |
|  | Lime Green • Two-coat pearlescent paint • Not available with Cityscape cloth trim | ○ | ○ | ○ | ○ | | ○ | | | | | 462.50 | 555.00 |

● = Standard equipment. ○ = Optional at extra cost.





The colours reproduced may vary slightly from the actual paint colour. As a result they should be used as a guide only. Your Vauxhall Retailer has a comprehensive display of our paint samples.

CORSA FEATURES/OPTIONS

| WHEELS AND TYRES | | Sting | Sting R | Energy | Limited Edition | Red/Black Edition | Design | SRi | SRi VX-Line | SE | Elite | Price (£) exc. VAT | Total (£) inc. VAT |
|---|---|-------|---------|--------|-----------------|-------------------|--------|-----|-------------|----|-------|--------------------|--------------------|
| Steel emergency spare wheel (in lieu of emergency tyre inflation kit) – on Design models, only available with optional 16-inch steel wheels | | ○ | ○ | ○ | | | ○ | ○ | | ○ | ○ | 91.67 | 110.00 |
| Full-size steel spare wheel (in lieu of emergency tyre inflation kit) – not available with optional 16-inch steel wheels | | | | | | | ○ | | | | | 91.67 | 110.00 |
|  | 15-inch structure steel wheels with styled covers <ul style="list-style-type: none"> • 185/65 R 15 tyres • Emergency tyre inflation kit (in lieu of spare wheel) | | | | | | ● | | | | | | |
|  | 15-inch alloy wheels <ul style="list-style-type: none"> • 185/65 R 15 tyres • Emergency tyre inflation kit (in lieu of spare wheel) | | | | | | ○ | | | | | 133.33 | 160.00 |
|  | 16-inch steel wheels with flush covers <ul style="list-style-type: none"> • 195/55 R 16 tyres • Emergency tyre inflation kit (in lieu of spare wheel) • Only available in conjunction with 1.3CDTi (95PS) Easytronic models | | | | | | ○ | | | | | 133.33 | 160.00 |
|  | 16-inch 8-spoke alloy wheels <ul style="list-style-type: none"> • 195/55 R 16 tyres • Emergency tyre inflation kit (in lieu of spare wheel) • Standard on 3-door models only. Not available on 5-door models | | | ● | | | | | | | | | |
|  | 16-inch white 4-twinspoke alloy wheels <ul style="list-style-type: none"> • 195/55 R 16 tyres • Emergency tyre inflation kit (in lieu of spare wheel) | ● | | | | | | | | | | | |



● = Standard equipment. ○ = Optional at extra cost.

CORSA FEATURES/OPTIONS

| WHEELS AND TYRES | | Sting | Sting R | Energy | Limited Edition | Red/Black Edition | Design | SRi | SRi VX-Line | SE | Elite | Price (£) exc. VAT | Total (£) inc. VAT |
|---|---|-------|---------|--------|-----------------|-------------------|--------|-----|-------------|----|-------|--------------------|--------------------|
|  | 16-inch silver 4-twinspoke alloy wheels <ul style="list-style-type: none"> • 195/55 R 16 tyres • Emergency tyre inflation kit (in lieu of spare wheel) • Standard on Energy 5-door models only. Not available on Energy 3-door models • Standard on SRi 5-door models, no-cost option on SRi 3-door models | | | ● | | | | ● | | | | | |
|  | 16-inch black 4-twinspoke alloy wheels <ul style="list-style-type: none"> • 195/55 R 16 tyres • Emergency tyre inflation kit (in lieu of spare wheel) • Standard on SRi 3-door models, no-cost option on SRi 5-door models | | ● | | | | | ● | | | | | |
|  | 16-inch alloy wheels <ul style="list-style-type: none"> • 195/55 R 16 tyres • Emergency tyre inflation kit (in lieu of spare wheel) | | | | | | | | | ● | N/C | | |
|  | 17-inch alloy wheels <ul style="list-style-type: none"> • 215/45 R 17 tyres • Emergency tyre inflation kit (in lieu of spare wheel) | | | | | | | | ● | | | | |
|  | 17-inch black alloy wheels <ul style="list-style-type: none"> • 215/45 R 17 tyres • Emergency tyre inflation kit (in lieu of spare wheel) | | | | ● | | | | | | | | |



● = Standard equipment. N/C = No-cost option.

CORSA FEATURES/OPTIONS

| WHEELS AND TYRES | | Sting | Sting R | Energy | Limited Edition | Red/Black Edition | Design | SRi | SRi VX-Line | SE | Elite | Price (£) exc. VAT | Total (£) inc. VAT |
|---|--|-------|---------|--------|-----------------|-------------------|--------|-----|-------------|----|-------|--------------------|--------------------|
|  | 17-inch diamond-cut black alloy wheels <ul style="list-style-type: none"> • 215/45 R 17 tyres • Emergency tyre inflation kit (in lieu of spare wheel) | | | | | ● | | | | | | | |
|  | 17-inch diamond-cut titan alloy wheels <ul style="list-style-type: none"> • 215/45 R 17 tyres • Emergency tyre inflation kit (in lieu of spare wheel) | | | | | | | | | ○ | ● | 341.67 | 410.00 |

● = Standard equipment. ○ = Optional at extra cost.

TYRE RATING

| Tyre size | Fuel efficiency group | Wet grip performance | External noise | |
|-------------|-----------------------|----------------------|----------------|--|
| | | | Measured (dB) | Group |
| 185/65 R 15 | B-C | B | 69-70 |  |
| 195/55 R 16 | B-C | B | 68-71 |  |
| 215/45 R 17 | C | B | 71 |  |

Tyre rating according to EU Regulation 1222/2009

CORSA SPECIFICATIONS

PETROL ENGINES

| | 1.4i (75PS) ecoFLEX | 1.4i (90PS) ecoFLEX | 1.4i Turbo (100PS) Start/Stop |
|-----------------------|--|--|--|
| Capacity | 1398cc | 1398cc | 1364cc |
| Maximum power | 75PS (55kW) @ 4200-6000rpm | 90PS (66kW) @ 6000rpm | 100PS (74kW) @ 3500-6000rpm |
| Maximum torque | 130Nm (96 lb.ft.) @ 4000rpm | 130Nm (96 lb.ft.) @ 4000rpm | 200Nm (147 lb.ft.) @ 1850-3500rpm |
| Configuration | 4 cylinders, 4 valves per cylinder, double overhead camshafts | 4 cylinders, 4 valves per cylinder, double overhead camshafts | 4 cylinders, 4 valves per cylinder, double overhead camshafts |
| Fuel/induction system | Naturally aspirated with Variable Valve Timing, Multi-point sequential fuel injection | Naturally aspirated with Variable Valve Timing, Multi-point sequential fuel injection | Turbocharger with intercooler, Variable Valve Timing, Multi-point sequential fuel injection |
| Emission compliance | Euro 6 | Euro 6 | Euro 6 |
| Service interval | 20,000 miles or 1 year (whichever occurs sooner) | 20,000 miles or 1 year (whichever occurs sooner) | 20,000 miles or 1 year (whichever occurs sooner) |

| | 1.0i Turbo (90PS) Start/Stop ecoFLEX | 1.0i Turbo (115PS) Start/Stop ecoFLEX | 1.4i Turbo (150PS) Start/Stop |
|-----------------------|--|--|--|
| Capacity | 999cc | 999cc | 1364cc |
| Maximum power | 90PS (67kW) @ 3700-6000rpm | 115PS (85kW) @ 5000-6000rpm | 150PS (110kW) @ 5000rpm |
| Maximum torque | 170Nm (125 lb.ft.) @ 1800-3700rpm | 170Nm (125 lb.ft.) @ 1800-4500rpm | 220Nm (162 lb.ft.) @ 2750-4500rpm |
| Configuration | 3 cylinders, 4 valves per cylinder, double overhead camshafts | 3 cylinders, 4 valves per cylinder, double overhead camshafts | 4 cylinders, 4 valves per cylinder, double overhead camshafts |
| Fuel/induction system | Turbocharger with intercooler, Direct fuel injection | Turbocharger with intercooler, Direct fuel injection | Turbocharger with intercooler, Multi-point fuel injection |
| Emission compliance | Euro 6 | Euro 6 | Euro 6 |
| Service interval | 20,000 miles or 1 year (whichever occurs sooner) | 20,000 miles or 1 year (whichever occurs sooner) | 20,000 miles or 1 year (whichever occurs sooner) |

DIESEL ENGINES

| | 1.3CDTi (75PS) Start/Stop ecoFLEX | 1.3CDTi (95PS) Start/Stop ecoFLEX |
|-----------------------|--|--|
| Capacity | 1248cc | 1248cc |
| Maximum power | 75PS (55kW) @ 3750rpm | 95PS (70kW) @ 3750rpm |
| Maximum torque | 190Nm (140 lb.ft.) @ 1500-2500rpm | 190Nm (140 lb.ft.) @ 1500-3500rpm |
| Configuration | 4 cylinders, 4 valves per cylinder, double overhead camshafts | 4 cylinders, 4 valves per cylinder, double overhead camshafts |
| Fuel/induction system | Turbocharger with intercooler, Common rail fuel injection | Variable geometry turbocharger with intercooler, Common rail fuel injection |
| Emission compliance | Euro 6 with Diesel Particulate Filter | Euro 6 with Diesel Particulate Filter |
| Service interval | 20,000 miles or 1 year (whichever occurs sooner) | 20,000 miles or 1 year (whichever occurs sooner) |

CORSA SPECIFICATIONS

PERFORMANCE, FUEL ECONOMY AND EMISSIONS

| | Wheel size (inches) | Performance (manufacturer's figures) | | Fuel economy mpg (litres/100km)# | | | CO ₂ emissions g/km# | Vehicle Excise Duty* | | Benefit in kind company car taxation rates – 2016/17 tax year |
|--|---------------------|--------------------------------------|----------------------------|----------------------------------|---------------------|-----------------|---------------------------------|----------------------|---------------|---|
| | | Maximum speed (mph) | Acceleration 0-62mph (sec) | Urban driving | Extra-urban driving | Combined figure | | First year rate | Standard rate | |
| Manual | | | | | | | | | | |
| 1.4i (75PS) ecoFLEX | 15/17 | 101 | 15.5 | 40.9 (6.9) | 67.3 (4.2) | 54.3 (5.2) | 120 | £0 | £30 | 21% |
| 1.4i (75PS) ecoFLEX | 16 | 101 | 15.5 | 41.5 (6.8) | 68.9 (4.1) | 55.4 (5.1) | 118 | £0 | £30 | 20% |
| 1.4i (90PS) ecoFLEX | 15/17 | 109 | 13.2 | 41.5 (6.8) | 65.7 (4.3) | 54.3 (5.2) | 120 | £0 | £30 | 21% |
| 1.4i (90PS) ecoFLEX (excluding Elite) | 16 | 109 | 13.2 | 42.2 (6.7) | 67.3 (4.2) | 55.4 (5.1) | 118 | £0 | £30 | 20% |
| 1.4i (90PS) ecoFLEX Elite | 16 | 109 | 13.2 | 41.5 (6.8) | 65.7 (4.3) | 54.3 (5.2) | 120 | £0 | £30 | 21% |
| 1.0i Turbo (90PS) S/S ecoFLEX 3-door | 15/17 | 112 | 11.9 | 51.4 (5.5) | 72.4 (3.9) | 62.8 (4.5) | 104 | £0 | £20 | 17% |
| 1.0i Turbo (90PS) S/S ecoFLEX 3-door | 16 | 112 | 11.9 | 51.4 (5.5) | 74.3 (3.8) | 64.2 (4.4) | 102 | £0 | £20 | 17% |
| 1.0i Turbo (90PS) S/S ecoFLEX 5-door | 15/17 | 112 | 11.9 | 50.4 (5.6) | 68.9 (4.1) | 61.4 (4.6) | 107 | £0 | £20 | 18% |
| 1.0i Turbo (90PS) S/S ecoFLEX 5-door (excluding Elite) | 16 | 112 | 11.9 | 51.4 (5.5) | 70.6 (4.0) | 61.4 (4.6) | 105 | £0 | £20 | 18% |
| 1.0i Turbo (90PS) S/S ecoFLEX 5-door Elite | 16 | 112 | 11.9 | 50.4 (5.6) | 68.9 (4.1) | 61.4 (4.6) | 107 | £0 | £20 | 18% |
| 1.4i Turbo (100PS) S/S ecoFLEX (excluding Elite) | 16 | 115 | 11.0 | 44.1 (6.4) | 65.7 (4.3) | 55.4 (5.1) | 119 | £0 | £30 | 20% |
| 1.4i Turbo (100PS) S/S Elite | 16 | 115 | 11.0 | 42.8 (6.6) | 64.2 (4.4) | 54.3 (5.2) | 122 | £0 | £110 | 21% |
| 1.4i Turbo (100PS) S/S | 17 | 115 | 11.0 | 42.8 (6.6) | 64.2 (4.4) | 54.3 (5.2) | 122 | £0 | £110 | 21% |
| 1.0i Turbo (115PS) S/S ecoFLEX 3-door | 16 | 121 | 10.3 | 47.9 (5.9) | 67.3 (4.2) | 58.9 (4.8) | 111 | £0 | £30 | 19% |
| 1.0i Turbo (115PS) S/S ecoFLEX 3-door | 17 | 121 | 10.3 | 47.1 (6.0) | 67.3 (4.2) | 57.6 (4.9) | 113 | £0 | £30 | 19% |
| 1.0i Turbo (115PS) S/S ecoFLEX 5-door | 16 | 121 | 10.3 | 47.9 (5.9) | 67.3 (4.2) | 58.9 (4.8) | 113 | £0 | £30 | 19% |
| 1.0i Turbo (115PS) S/S ecoFLEX 5-door | 17 | 121 | 10.3 | 46.3 (6.1) | 65.7 (4.3) | 56.5 (5.0) | 115 | £0 | £30 | 20% |
| 1.4i Turbo (150PS) S/S 3-door | 17 | 129 | 8.9 | 38.2 (7.4) | 58.9 (4.8) | 49.6 (5.7) | 132 | £130 | £130 | 23% |
| 1.4i Turbo (150PS) S/S 5-door | 17 | 129 | 8.9 | 38.2 (7.4) | 58.9 (4.8) | 48.7 (5.8) | 133 | £130 | £130 | 23% |
| 1.3CDTi (75PS) S/S ecoFLEX** | 15/17 | 102 | 14.8 | 58.9 (4.8) | 83.1 (3.4) | 72.4 (3.9) | 104 | £0 | £20 | 20% |
| 1.3CDTi (75PS) S/S ecoFLEX** | 16 | 102 | 14.8 | 60.1 (4.7) | 83.1 (3.4) | 72.4 (3.9) | 102 | £0 | £20 | 20% |
| 1.3CDTi (95PS) S/S ecoFLEX** | 15/17 | 113 | 11.9 | 68.9 (4.1) | 88.3 (3.2) | 78.5 (3.6) | 94 | £0 | £0 | 18% |
| 1.3CDTi (95PS) S/S ecoFLEX (excluding Elite)** | 16 | 113 | 11.9 | 68.9 (4.1) | 88.3 (3.2) | 80.7 (3.5) | 93 | £0 | £0 | 18% |
| 1.3CDTi (95PS) S/S ecoFLEX Elite** | 16 | 113 | 11.9 | 68.9 (4.1) | 88.3 (3.2) | 78.5 (3.6) | 94 | £0 | £0 | 18% |

* = Correct at time of publication. ** = Fuel economy and emissions data is provisional. S/S = Start/Stop.

= Fuel consumption information is official government environmental data, tested in accordance with the relevant EU directive. Official EU-regulated test data is provided for comparison purposes and actual performance will depend on driving style, road conditions and other non-technical factors.

CORSA SPECIFICATIONS

PERFORMANCE, FUEL ECONOMY AND EMISSIONS

| | Wheel size (inches) | Performance (manufacturer's figures) | | Fuel economy mpg (litres/100km) [#] | | | CO ₂ emissions g/km [#] | Vehicle Excise Duty* | | Benefit in kind company car taxation rates – 2016/17 tax year |
|---------------------------------------|---------------------|--------------------------------------|----------------------------|--|---------------------|-----------------|---|----------------------|---------------|---|
| | | Maximum speed (mph) | Acceleration 0-62mph (sec) | Urban driving | Extra-urban driving | Combined figure | | First year rate | Standard rate | |
| Easytronic | | | | | | | | | | |
| 1.4i (90PS) S/S ecoFLEX Design 3-door | 15 | 109 | 13.9 | 47.9 (5.9) | 68.9 (4.1) | 58.9 (4.8) | 112 | £0 | £30 | 19% |
| 1.4i (90PS) S/S ecoFLEX Design 5-door | 15 | 109 | 13.9 | 48.7 (5.8) | 68.9 (4.1) | 58.9 (4.8) | 112 | £0 | £30 | 19% |
| 1.4i (90PS) S/S ecoFLEX Energy | 16 | 109 | 13.9 | 48.7 (5.8) | 70.6 (4.0) | 60.1 (4.7) | 110 | £0 | £20 | 19% |
| 1.3CDTi (95PS) S/S ecoFLEX** | 15 | 113 | 13.5 | 70.6 (4.0) | 91.1 (3.1) | 83.1 (3.4) | 91 | £0 | £0 | 18% |
| 1.3CDTi (95PS) S/S ecoFLEX** | 16 | 113 | 13.5 | 72.4 (3.9) | 91.1 (3.1) | 83.1 (3.4) | 90 | £0 | £0 | 18% |
| Automatic | | | | | | | | | | |
| 1.4i (90PS) 3-door | 15/17 | 106 | 13.9 | 35.8 (7.9) | 58.9 (4.8) | 47.9 (5.9) | 137 | £130 | £130 | 24% |
| 1.4i (90PS) 3-door | 16 | 106 | 13.9 | 36.2 (7.8) | 60.1 (4.7) | 47.9 (5.9) | 135 | £130 | £130 | 24% |
| 1.4i (90PS) 5-door | 15/17 | 106 | 13.9 | 35.3 (8.0) | 57.6 (4.9) | 47.1 (6.0) | 139 | £130 | £130 | 24% |
| 1.4i (90PS) 5-door (excluding Elite) | 16 | 106 | 13.9 | 35.8 (7.9) | 58.9 (4.8) | 47.9 (5.9) | 137 | £130 | £130 | 24% |
| 1.4i (90PS) 5-door Elite | 16 | 106 | 13.9 | 35.3 (8.0) | 57.6 (4.9) | 47.1 (6.0) | 139 | £130 | £130 | 24% |

* = Correct at time of publication. ** = Fuel economy and emissions data is provisional. S/S = Start/Stop.

= Fuel consumption information is official government environmental data, tested in accordance with the relevant EU directive. Official EU-regulated test data is provided for comparison purposes and actual performance will depend on driving style, road conditions and other non-technical factors.

CORSA SPECIFICATIONS

TRANSMISSION

Five-speed manual gearbox

Petrol engines: 1.4i (75PS), 1.4i (90PS) models

Diesel engines: All

Six-speed manual gearbox

Petrol engines: 1.0i Turbo (90PS),

1.4i Turbo (100PS), 1.0i Turbo (115PS),

1.4i Turbo (150PS) models

Five-speed Easytronic transmission

Optional on 1.4i (90PS) and 1.3CDTi (95PS) models.

Easytronic transmission is a five-speed manual gearbox with a fully automatic mode. In manual mode you simply push the lever forward or back to shift gears up or down sequentially. The fascia display tells you what gear you're in – 1 to 5, N for Neutral or A for Auto. Switch to fully automatic mode and it has many of the features of a regular automatic including a kickdown function. There's no clutch pedal so you can drive it on an automatic-only driving licence.

Six-speed automatic transmission

Optional on 1.4i (90PS) models. Electronically controlled with adaptive driving function that adjusts to the driving style and prevailing road conditions. Fluid drive with torque converter, lock-up clutch, neutral control fuel-saving feature and Active Select.

SUSPENSION

Front: Independent. Lightweight MacPherson struts with gas-pressure dampers and coil springs. Anti-roll bar.

Rear: Compound crank with coil springs and gas-pressure dampers.

- Sports suspension on Sting R/Limited Edition/SRi VX-Line/Elite models, and on SE models fitted with optional 17-inch alloy wheels

BRAKES

- Anti-lock Braking System (ABS)
- Electronic brakeforce distribution
- Emergency brake assist
- Cornering brake control
- Straight line stability control
- Dual circuit, diagonally split, dual rate servo-assisted system
- Low brake fluid level warning light

1.4i (75PS)

Front ventilated discs: 257mm diameter

Rear drums: 228mm diameter

1.4i (90PS)

Front ventilated discs: 257mm diameter

Rear drums: 228mm diameter

1.0i Turbo (90PS) ecoFLEX

Front ventilated discs: 284mm diameter

Rear discs: 264mm diameter

1.4i Turbo (100PS)

Front ventilated discs: 284mm diameter

Rear discs: 264mm diameter

1.0i Turbo (115PS) ecoFLEX

Front ventilated discs: 284mm diameter

Rear discs: 264mm diameter

1.4i Turbo (150PS)

Front ventilated discs: 308mm diameter

Rear discs: 264mm diameter

1.3CDTi (75PS) ecoFLEX

Front ventilated discs: 284mm diameter

Rear drums: 228mm diameter

1.3CDTi (95PS) ecoFLEX

Front ventilated discs: 284mm diameter

Rear drums: 228mm diameter

BODY

- Aerodynamic drag co-efficient: Cd 0.33

FUEL TANK CAPACITY

- 45 litres (9.9 gallons)

WEIGHTS AND TOWING DATA kg

| | Gross vehicle weight | | Maximum towing weights Trailer with brakes (without brakes) | |
|---|----------------------|--------|--|------------|
| | 3-door | 5-door | 3-door | 5-door |
| 1.4i (75PS) Energy | 1585 | 1605 | 800 (550) | 800 (550) |
| 1.4i (75PS) Sting | 1585 | – | 800 (550) | – |
| 1.4i (75PS) Limited Edition/Design/SRi/SRi VX-Line/SE | 1600 | 1620 | 800 (550) | 800 (550) |
| 1.4i (90PS) Sting/Energy | 1585 | 1615 | 800 (550) | 800 (550) |
| 1.4i (90PS) Limited Edition/Design/SRi/SRi VX-Line/SE/Elite | 1600 | 1630 | 800 (550) | 800 (550) |
| 1.4i (90PS) Easytronic | 1620 | 1640 | 800 (550) | 800 (550) |
| 1.4i (90PS) auto | 1630 | 1660 | 800 (550) | 800 (550) |
| 1.0i Turbo (90PS) | 1650 | 1680 | 1200 (560) | 1200 (560) |
| 1.4i Turbo (100PS) | 1680 | 1710 | 1150 (580) | 1150 (580) |
| 1.0i Turbo (115PS) Sting R | 1635 | – | 1200 (560) | – |
| 1.0i Turbo (115PS) Energy/Limited Edition/SRi VX-Line | 1650 | 1680 | 1200 (560) | 1200 (560) |
| 1.4i Turbo (150PS) | 1690 | 1720 | 1200 (580) | 1200 (580) |
| 1.3CDTi (75PS) Energy/Design/SRi/SRi VX-Line/SE | 1680 | 1710 | 900 (580) | 900 (580) |
| 1.3CDTi (95PS) | 1680 | 1710 | 1150 (580) | 1150 (580) |
| 1.3CDTi (95PS) Easytronic | 1690 | 1710 | 1150 (580) | 1150 (580) |

Please note: For Sting, Sting R and Energy models fitted with optional air conditioning 15kg must be added to gross vehicle weight. **Gross vehicle weight** is the total permissible weight of the vehicle including passengers and their luggage. The **maximum roof rack loading** should not exceed 75kg. The **maximum towing weights** are based on the ability of the car, with two occupants of 75kg each, to restart on a 12% gradient, which is approximately 1 in 8.3, at sea level. The permitted trailer load applies up to the specified incline and up to an altitude of 1000 metres above sea level. The permissible gross train weight decreases by 10% for every 1000 metres of additional altitude. At altitudes above 1500 metres, the engine output may drop with a corresponding reduction in towing capability. Any extra weight, such as luggage or additional passengers, should be deducted from the maximum towing weight. With a trailer fully loaded, **maximum noseweight** should not exceed 55kg. Always fit Vauxhall towing attachments and accessories available from your Vauxhall Retailer. They are designed specifically for Vauxhall models and carry a 12-month guarantee.

CORSA SPECIFICATIONS

EXTERIOR DIMENSIONS millimetres (inches)

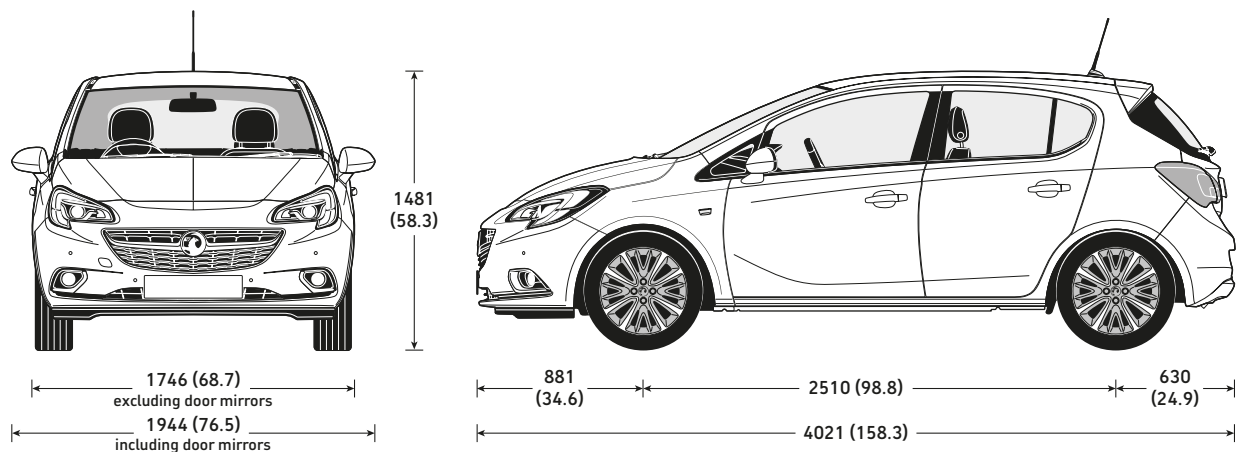
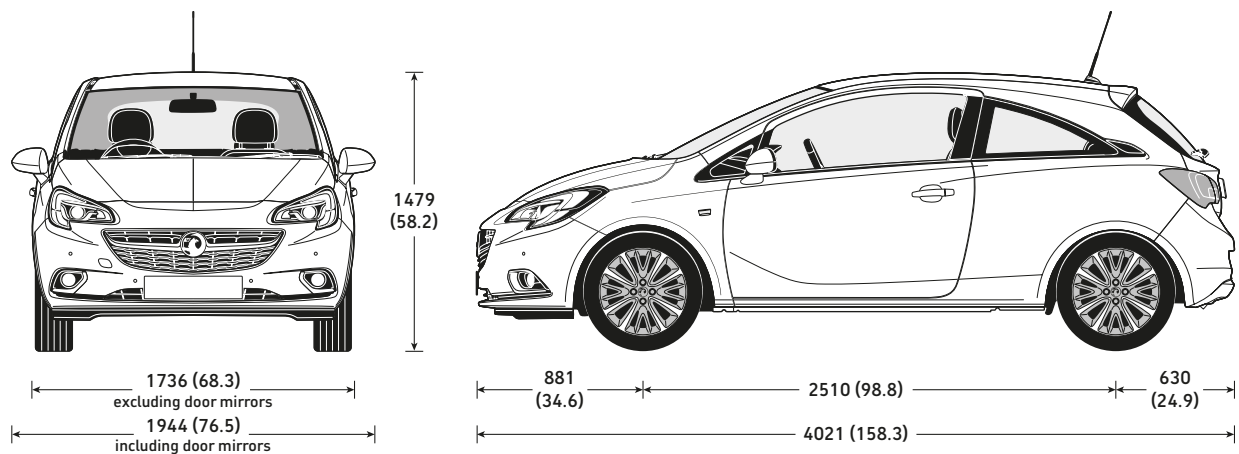

LOADSPACE DIMENSIONS mm (inches)

| 3-door | |
|---------------------------|-------------|
| Maximum length (seats up) | 705 (27.8) |
| Maximum length* | 1372 (54.0) |
| Maximum width | 944 (37.2) |
| Maximum height | 843 (33.2) |
| 5-door | |
| Maximum length (seats up) | 705 (27.8) |
| Maximum length* | 1372 (54.0) |
| Maximum width | 944 (37.2) |
| Maximum height | 876 (34.5) |

* = Behind front seats.

LOADSPACE CAPACITIES** litres (cu.ft.)

| 3-door | |
|-------------------------------|-------------|
| Rear seat up | 280 (9.9) |
| Rear seat down (to glassline) | 750 (26.5) |
| Rear seat down (to roof) | 1090 (38.5) |
| 5-door | |
| Rear seat up | 285 (10.0) |
| Rear seat down (to glassline) | 710 (25.1) |
| Rear seat down (to roof) | 1120 (39.5) |

** = ECIE method.

FLEX-FIX® KEY DIMENSIONS mm (inches)

| | |
|--|-----------|
| Maximum circumference around rim and tyre of bicycle | 225 (8.9) |
| Maximum crank arm width | 52 (2.0) |
| Maximum crank arm depth | 25 (1.0) |
| Maximum crank arm length | no limit |

CORSA ACCESSORIES

CHILD SEATS¹

| | Total (inc. VAT) |
|--|------------------|
| BABY-SAFE ² – 0-13kg/birth to 15 months | £132.00 |
| – ISOFIX base | £227.00 |
| DUO ISOFIX ² – 9-18kg/9 months to 4 years | |
| with top tether kit | £347.00 |
| KID ³ – 15-36kg or 4 to 12 years | £157.00 |

1 = Restrictions apply to the use of child seats, please consult your Vauxhall Retailer or request a copy of the Child seats brochure.

2 = Without transponder.

SAFETY

| | |
|---|---------|
| Privacy shades – rear side windows (3-dr) | £73.00 |
| Privacy shades – tailgate window (3-dr) | £89.00 |
| Privacy shades – rear side windows (5-dr) | £91.00 |
| Privacy shades – tailgate window (5-dr) | £91.00 |
| Parking sensors | |
| – four fully flush front bumper mounted sensors | |
| – painted | £350.00 |
| – four fully flush rear bumper mounted sensors | |
| – painted | £330.00 |
| Safety Pack – first aid kit, warning triangle, hi-visibility vest, Vauxhall bag | £35.00 |
| First aid kit | £14.00 |
| Warning triangle | £17.00 |
| Hi-visibility vest | £9.00 |
| Fire extinguisher – 2kg | £36.00 |
| Temporary tyre inflation kit | £149.00 |
| Tyre sealant | £65.00 |

FLEXCONNECT RANGE

| | |
|-----------------------------------|--------|
| FlexConnect bracket | £20.00 |
| FlexConnect hook | £25.00 |
| FlexConnect coat hanger | £50.00 |
| FlexConnect folding table | £65.00 |
| FlexConnect iPad Mini cradle | £91.00 |
| FlexConnect iPad (1-4) cradle | £99.00 |
| FlexConnect iPad Air cradle | £99.00 |
| FlexConnect Samsung Galaxy cradle | £89.00 |

SECURITY

| | Total (inc. VAT) |
|-----------------------------------|------------------|
| Locking wheel bolts – set of four | £42.00 |

PRACTICAL

| | |
|---|--------|
| Spare bulb kit | £27.00 |
| Spare bulb kit – ultra white | £37.00 |
| Jump leads | |
| – petrol engines (16mm standard) | £46.00 |
| – petrol/diesel engines (25mm heavy duty) | £82.00 |
| Stretch tow rope – 3000kg | £34.00 |
| Towing bar – 2500kg | £83.00 |

PROTECTION

| | |
|--|---------|
| Carpet floor mats – set of four | £41.00 |
| Rubber floor mats – front pair | £48.00 |
| Rubber floor mats – rear pair | £30.00 |
| Velour floor mats – set of four | £61.00 |
| Cargo liner | £75.00 |
| Luggage storage box – with dividers | £99.00 |
| Universal luggage net | £26.00 |
| Load-restraining floor net | £44.00 |
| Rear bumper protection foil | £70.00 |
| Mudflaps – front and rear set ³ | £120.00 |

3 = Not available with certain exterior styling accessories.

TRANSPORT SYSTEMS

| | Total (inc. VAT) |
|-------------------|------------------|
| Roof base carrier | £140.00 |

Roof carriers (requires base carrier)

| | |
|--|---------|
| Bike roof carrier – Thule Freeride 532 | £76.00 |
| Surf board roof carrier – Thule 833 | £101.00 |
| Kayak roof carrier – Thule 837 | £168.00 |
| Ski roof carrier (400mm wide) | |
| – Thule Deluxe 726 | £138.00 |
| Ski roof carrier (600mm wide) | |
| – Thule 739 | £235.00 |

Hard shell roof boxes (requires base carrier)

| | |
|---|--------------|
| Thule Ocean 80 (320 litre / 1330 x 860 x 370mm) | £235.00 |
| Thule Ocean 200 (390 litre / 1750 x 820 x 450mm) | £316.00 |
| Thule Pacific 200 (460 litre) | £372.00 |
| Thule Pacific 700 (460 litre) | £426.00 |
| Thule Dynamic M (320 litre / 2060 x 840 x 340mm) | from £625.00 |
| Thule Dynamic L (430 litre / 2350 x 940 x 350mm) | £846.00 |
| Thule Excellence (520 litre / 2180 x 940 x 400mm) | £898.00 |
| Thule Motion 800 (460 litre / 2050 x 840 x 450mm) | from £515.00 |
| Thule Touring 200 (400 litre / 1750 x 820 x 450mm) | £372.00 |
| Thule Touring 780 (430 litre / 2320 x 700 x 420mm) | £460.00 |

Soft roof boxes (requires base carrier)

| | |
|--|---------|
| Thule Ranger 90 (280 litre / 1100 x 800 x 400mm) | £285.00 |
| Thule Ranger 500 (300 litre / 1900 x 500 x 300mm) | £378.00 |

Tailgate carrier

| | |
|--|---------|
| Bike tailgate carrier – Thule BacPac 973 | £282.00 |
| Fitting kit | £48.00 |

ALLOY WHEELS (set of four with centre caps)⁴

| | |
|---------------------------------|----------|
| 15-inch 8-spoke – silver | £717.00 |
| 16-inch 4-double-spoke – white | £866.00 |
| 16-inch 4-double-spoke – black | £862.00 |
| 16-inch 6-double-spoke – silver | £866.00 |
| 17-inch 5-twin-spoke – silver | £1007.00 |
| 17-inch 8-spoke – Titan gloss | £980.00 |

4 = Fitting time is based on four wheels fitted and includes static wheel balancing. Different tyres and locking wheel nuts may be required. Price excludes new tyres and locking wheel nuts.

Please note:

Prices shown are a fully fitted and painted, where applicable and include VAT. Please check with your local Vauxhall Retailer for details. It is advisable to ensure your insurance policy is adequate to cover additional fitted accessories. Prices correct at time of publication.

CORSA OFFERS IN DETAIL – TERMS AND CONDITIONS

Unless otherwise stated, all offers described are available on orders or registrations between 19 December 2016 and 3 April 2017. Offer prices quoted are correct at the time of publication (December 2016). Prices are subject to change. In line with Vauxhall's policy of price transparency, the offer price shown is an on-the-road price including VAT on cars (excluding VAT on Commercial Vehicles), number plates and delivery to Retailer of £700.00 (£583.33 excluding VAT), 12 months' Government Vehicle Excise Duty (variable depending upon model – refer to the individual model price guides online) and the DVLA's new vehicle first registration fee of £55.00. Excludes fuel and insurance. Offers may not apply to Retailer stocks and are subject to availability. Restrictions may apply. Contact your Retailer for details. General Motors UK Limited trading as Vauxhall Motors reserves the right to change, amend or withdraw these offers at any point in time.

FLEXIBLE FINANCE

Available on selected models only, at participating Retailers. Conditional sale. Finance subject to status. Terms and Conditions apply. Applicants must be 18+. Finance supplied by Vauxhall Finance, PO Box 6666, CF15 7YT. Vauxhall Deposit Contributions vary and exclude certain models and are only available when vehicle is financed through Vauxhall Finance. 24-60 month term. Offer will apply to private individuals, Vauxhall Partners and small businesses 1-24 units (purchase only, excluding B2B supported units). All other customers are excluded. Refer to www.vauxhall.co.uk/offers or contact your local Vauxhall Retailer for details.

FLEXIBLE PCP

Offer subject to availability at participating Retailers only. Personal Contract Purchase. Finance subject to status. Terms and Conditions apply. Applicants must be 18+. Finance by Vauxhall Finance, PO Box 6666, CF15 7YT. Customer deposit shown after deduction of Vauxhall contribution. Vauxhall deposit contribution only available when vehicle financed through Vauxhall Finance. At the end of the agreement there are three options: i) Retain the vehicle: Pay the optional final payment to own the vehicle, ii) Return the vehicle, or iii) Replace: Part Exchange the vehicle, where equity is available. Offer applies to private individuals, Vauxhall Partners and small businesses 1-24 units (purchase only excluding B2B supported units). All other customers are excluded.

PERSONAL CONTRACT HIRE

Personal contract hire offer on orders received before 31 March 2017, subject to availability and status. Age 18+ only. Figures based on a non-maintenance contract hire package. Excess miles over contracted mileage of 24,000 over 36 months charged at 7.24 pence per mile for VIVA, 7.31 pence per mile for ADAM, 6.64 pence per mile for Corsa, 10.46 pence per mile for Astra, 12.06 pence per mile for Cascada and 11.08 pence per mile for New Mokka X. Excess charges also apply if you breach manufacturer servicing or maintenance guidelines or if the car exceeds BVRLA Fair Wear & Tear guidelines for its age/mileage when it is returned to Vauxhall Leasing. Package includes Road Fund Licence and Vauxhall Assistance. Guarantee/indemnity may be required. Prices and details are subject to change without notice. For full specification and Ts&Cs contact your local Retailer. **You will not own the car.** ALD Automotive Ltd., trading as Vauxhall Leasing, BS16 3JA. Authorised and regulated by the Financial Conduct Authority.

Please note not all offers apply to all models.

CORSA COMPANY CAR DRIVER/FLEET INFORMATION

DESIGN AND TECH LINE HIGH SPEC, LOW P11D

Specifically developed for businesses and company car drivers alike, our Design and Tech Line models are seriously fit for Fleet.

Design models (Insignia, Astra and Corsa) all feature very low P11D values, generous standard specification with a choice of high tech ecoFLEX engines for great fuel economy and low emissions including the 'whisper diesel' 1.6CDTi (from 88g/km and 85.6mpg combined).

For even more standard specification, step up to our Tech Line range (Insignia, Astra, Mokka, Zafira Tourer and Meriva) again you are guaranteed low P11D values, plus great standard kit including Sat Nav (in lieu of parking sensors and Winter Pack on Meriva), Bluetooth®, USB connection, aux-in socket and digital radio (excluding Meriva).

With Design and Tech Line you can take for granted low Whole Life Costs and low company car driver taxation.

COMPANY CAR DRIVER FREE* 3 DAY TEST DRIVE

Our free* 3 Day Test Drive programme is open to all Company Car Drivers which allows you to choose any model in the current Vauxhall line-up (excluding all VXR models and Commercial Vehicles), with full insurance cover provided, to give you a meaningful length of time to make an informed decision about your next company car.

Click below to book your free* test drive www.vauxhall3dtd.co.uk or call 0870 240 4848**



BENEFIT IN KIND COMPANY CAR TAXATION†

The car benefit charge will be the car's list price (including VAT, options and accessories fitted, delivery to Retailer and number plates, but excluding Vehicle Excise Duty and new vehicle first registration fee) multiplied by the percentage charge for the CO₂ emissions band in which the car falls (see table opposite). Multiply this figure by your personal income tax rate (20% for Basic Rate, 40% for Higher Rate) to calculate your annual benefit in kind tax liability.

Example:

Corsa Design 1.3CDTi (95PS) Start/Stop ecoFLEX 5-door hatchback
(CO₂ emissions 94g/km)

| | |
|---------------------------------------|------------------|
| On-the-road RRP | £15130.00 |
| Deduct: Vehicle Excise Duty | (£0.00) |
| New vehicle first registration fee | (£55.00) |
| Effective list price | £15075.00 |
| Add: Optional two-coat metallic paint | £555.00 |

List price for tax purposes (P11D value)
£15630.00

| | |
|---|----------|
| Car benefit charge | |
| 2016-17 tax year (18%) | £2813.00 |
| Benefit in kind tax liability (2016-17 tax year) | |
| Basic Rate (20%) tax payer | £562.60 |
| Higher Rate (40%) tax payer | £1125.20 |

† = Please note this Price Guide provides taxation information as a guide only. Vauxhall does not provide taxation guidance. Drivers should always take professional advice on their own tax position.

| CO ₂ emissions in grams per kilometre | Percentage of car's price to be taxed | |
|--|---------------------------------------|-------------------------|
| | Petrol 2016-17 tax year | Diesel 2016-17 tax year |
| up to 50 | 7 | 10 |
| 51-75 | 11 | 14 |
| 76-94 | 15 | 18 |
| 95-99 | 16 | 19 |
| 100-104 | 17 | 20 |
| 105-109 | 18 | 21 |
| 110-114 | 19 | 22 |
| 115-119 | 20 | 23 |
| 120-124 | 21 | 24 |
| 125-129 | 22 | 25 |
| 130-134 | 23 | 26 |
| 135-139 | 24 | 27 |
| 140-144 | 25 | 28 |
| 145-149 | 26 | 29 |
| 150-154 | 27 | 30 |
| 155-159 | 28 | 31 |
| 160-164 | 29 | 32 |
| 165-169 | 30 | 33 |
| 170-174 | 31 | 34 |
| 175-179 | 32 | 35 |
| 180-184 | 33 | 36 |
| 185-189 | 34 | 37 |
| 190-194 | 35 | 37 |
| 195-199 | 36 | 37 |
| 200 and above | 37 | 37 |

To calculate your own personal liability a car tax calculator is available at: <https://www.vauxhallfleet.co.uk/toolbox>

*The free 3 Day Test Drive programme is open to Company Car Drivers and excludes fuel and lubricants; congestion charges; parking and speeding fines and the £250 insurance excess (if applicable). It features a wide selection of models from the Vauxhall range (excluding all VXR models and Commercial Vehicles and subject to availability). Drivers must be aged 25 years or over, have held a full driving licence for at least a year and hold a major credit card. You will need to have your driving licence (and proof of identity (i.e. passport) where the driving licence is not a photocard licence) when your car is delivered. While every effort will be made to ensure that at least 3 days are provided for the test drive, this cannot always be guaranteed due to delivery and collection dates and timings. Available for UK Mainland only. Terms and conditions apply. **Telephone lines open Monday-Friday 9.00am to 5.00pm excluding Bank Holidays. Calls may be recorded or monitored for quality and/or training purposes.

FLEET TOOLBOX

Discover the facts in our online Toolbox for both Company Car Drivers and Fleet Decision Makers. The Fleet Toolbox has a host of useful calculators, comparators, interactive listings and information. Visit the Fleet Toolbox by going to www.vauxhall-toolbox.co.uk



ROADTRIP APP

The Vauxhall RoadTrip App is a free app that calculates and logs your mileage expenses for any UK business trips and generates reports to help you complete your mileage claims. Available for both iPhone and Android, visit www.vauxhall-toolbox.co.uk or visit the iPhone or Android stores and search for Vauxhall RoadTrip to download it to your smartphone or tablet.



CONTACT VAUXHALL FLEET

Please contact one of our dedicated sales teams who will be happy to help with your particular enquiry.

Company Car Drivers

Call: 0345 111 2020

Email: company-car@vauxhallinfo.co.uk

Telephone lines are open

– Monday to Friday 8.00am-9.00pm

– Saturday and Sunday 9.00am-6.00pm

Fleet Decision Makers

Depending on the size of your fleet of vehicles, we have a dedicated team to handle your enquiries. The lines are open Monday to Friday excluding Bank Holidays.

1-24 vehicles

Call: 0845 076 2254 (8.30am-5.00pm)

Email: b2bsales@vauxhall.co.uk

25+ vehicles

Call: 0870 010 0651 (8.30am-5.00pm)

Email: vauxhallfleet@vauxhall.co.uk

Special Vehicles (Police, Fire and Ambulance)

Call: 01525 408 320 (8.30am-5.00pm)

Email: vauxhallspecialvehicles@vauxhall.co.uk

CORSA ADDITIONAL INFORMATION

ON-THE-ROAD PRICES

To eliminate uncertainty about hidden costs when buying a new car, Vauxhall publishes on-the-road recommended retail prices (RRP) and these are shown in the pricing tables within this price guide. These prices include the recommended cost of number plates and delivery to a Vauxhall Retailer of £700.00 (including £116.67 VAT), 12 months' Government Vehicle Excise Duty (see opposite for details) and the DVLA new vehicle first registration fee of £55.00*.

Please note: The on-the-road recommended retail price (RRP) does not include fuel supplied by the Retailer, motor insurance or any other goods or services supplied by agreement between the Retailer and the customer.

PRICE PROTECTION

Order a new Vauxhall for build in the current model year (as confirmed by your Retailer) for delivery no more than three months in advance and the price you are quoted is the price you pay. This is irrespective of any subsequent price rises between placing your order and delivery of your new car, but you must take delivery as soon as the car is available. General Motors UK Limited is not liable for price adjustments caused by Government changes in the rate of VAT (currently 20%), Vehicle Excise Duty, DVLA new vehicle first registration fee or by any other applicable legislation or regulations.

VEHICLE EXCISE DUTY

The amount of Vehicle Excise Duty (road fund licence) payable on new cars varies depending on the level of carbon dioxide (CO₂) emissions produced by the vehicle. CO₂ emissions are measured in grammes (g) per kilometre (km) travelled and divided into 13 charging bands shown in the table below.

From 1 April 2010 the Government introduced a new 'first year rate' of Vehicle Excise Duty payable on all new cars. In subsequent years the amount of Vehicle Excise Duty payable will revert to the standard rate.

Vehicle Excise Duty*

| | CO ₂ emissions (g/km) | First year rate | Standard rate |
|--------|----------------------------------|-----------------|---------------|
| Band A | up to 100 | £0.00 | £0.00 |
| Band B | 101-110 | £0.00 | £20.00 |
| Band C | 111-120 | £0.00 | £30.00 |
| Band D | 121-130 | £0.00 | £110.00 |
| Band E | 131-140 | £130.00 | £130.00 |
| Band F | 141-150 | £145.00 | £145.00 |
| Band G | 151-165 | £185.00 | £185.00 |
| Band H | 166-175 | £300.00 | £210.00 |
| Band I | 176-185 | £355.00 | £230.00 |
| Band J | 186-200 | £500.00 | £270.00 |
| Band K | 201-225 | £650.00 | £295.00 |
| Band L | 226-255 | £885.00 | £500.00 |
| Band M | over 255 | £1120.00 | £515.00 |

* = Correct at time of issue.

E10 FUEL

E10 fuel is cleared for use in all petrol-engined Vauxhall vehicles excluding models with the 2.2 litre direct injection petrol engine (code Z22YH) used in Vectra, Signum and Zafira models. Owners of these vehicles should continue to use regular unleaded or premium unleaded petrol.

PROTECTING THE ENVIRONMENT

Vauxhall's commitment to the environment is demonstrated by our products' many environmental awards. For even more information on Vauxhall's efforts to achieve an environmentally sustainable future, and how to dispose of your end-of-life vehicle, see www.vauxhall.co.uk/recycling

VAUXHALL ASSISTANCE

Vauxhall Assistance is provided automatically with every new Vauxhall for 12 months from first registration and covers everything from accident assistance, roadside recovery and 'at home' service to flat tyres. With Vauxhall Assistance help is literally just a free** phone call away, 24 hours a day, 365 days a year!

** = Mobile phone users will be charged at their standard tariff.

VAUXHALL LEASING

As Vauxhall's own contract hire and fleet management operation, Vauxhall Leasing provides a one-stop-shop for competitive car and van leasing solutions – for business users and private individuals. Working with the Vauxhall Retailer network, we combine the support of a national contract with the convenience of a local contact.

For further information, please see your local Vauxhall Retailer or call us on **0870 737 2557**. Alternatively, you can visit our website at www.vauxhall-leasing.co.uk

IN THE EVENT OF AN ACCIDENT...

Vauxhall Accident Management helps keep you mobile following an accident. Benefits include vehicle recovery, Vauxhall-approved repairs and contacting your insurer. For more details, visit vauxhall.co.uk/AccidentManagement

VAUXHALL SERVICE PLAN

Vauxhall Retailers offer a great service for owners of all Vauxhall cars. Value for money, regular offers and free check-ups, combined with the peace of mind that comes from using Vauxhall-trained technicians and genuine parts, help keep your car in peak condition at all times.

FOR MORE PRODUCT INFORMATION

For a brochure on any Vauxhall model (up to a maximum of three per caller) or location of your nearest Vauxhall Retailer please call **0345 600 1500**. Alternatively, details can be found on our website at www.vauxhall.co.uk

JOIN US ONLINE:



VAUXHALL INSURANCE WITH ADDED REASSURANCE

Comprehensive cover – Summary of benefits*

- Competitive premiums
- Repairs by a Vauxhall technician
- Genuine Vauxhall parts, guaranteed for three years when we repair your car within our Approved Repairer Network
- Free courtesy car as standard when using an Approved Repairer**
- 24 hour claims helpline
- Personal Accident benefit
- Cover for audio equipment
- Windscreen cover

Call for a quote on 0844 463 2670†

*The benefits listed above are for comprehensive cover only. For details of Third Party, Fire and Theft cover, please call our sales team.
**Should your car need repairing following an accident we provide a courtesy car (subject to availability) for the duration of the repair. Only genuine Vauxhall parts are used. Terms and conditions apply.
†Calls may be recorded. Vauxhall Motor Insurance is underwritten by Ageas Insurance Limited.

Every effort has been made to ensure that the contents of this document were accurate and up-to-date at the time of publication – 19 December 2016. The invoice price, including delivery to Retailer, factory-fitted options, accessories fitted by the Retailer and number plates, is subject to VAT. The right is reserved to alter specifications and prices, and withdraw products from sale, without notice. Please note that Vauxhall Retailers are not the agents of General Motors UK Limited and are not authorised to bind General Motors UK Limited by any specific or implied undertaking or representation. It is advisable to ensure that your motor insurance policy provides adequate cover for additional fitted options and accessories. All rights reserved. No part of this publication may be reproduced in any form or by any means, without the prior written permission of General Motors UK Limited.

General Motors UK Limited t/a Vauxhall, Griffin House, UK1-101-135, Osborne Road, Luton, Bedfordshire, LU1 3YT. www.vauxhall.co.uk

©2016 General Motors UK Limited



VAUXHALL