

NEW CORSA PRICE/SPECIFICATION GUIDE

2 July 2015



Proud Sponsor of Home Nations Football



NEW CORSA CUSTOMER OFFERS

At Vauxhall we know that customers appreciate flexibility. Not only do we have an extensive range of New Corsa models to choose from, but we have a range of ways to purchase too. Here's an example on our Flexible PCP programme:

LOVE AT FIRST SIGHT EXCITE 1.4i 90PS ecoFLEX (a/c)



FLEXIBLE PCP* Representative example:

23 Monthly Payments of	£169
On-the-road cash price	£13,935
Vauxhall Deposit Contribution	£500
Customer Deposit	£3,316.27
Amount of Credit	£10,118.73
Interest Charges	£478.27
First credit arrangement fee	£149
Final credit arrangement fee	£149
Total Amount Payable	£14,711.27
Optional Final Payment (GFV)	£6,710
Fixed Rate of Interest per year, true	2.84%
Mileage per annum	8,000
Excess mileage charge, per mile	£0.09
Duration of Agreement	24 months
Representative APR	4.7% APR

For even more great deals contact your local retailer or call 0345 600 1500 or visit www.vauxhall.co.uk/offers

TERMS AND CONDITIONS: *Offer subject to availability at participating Retailers only. Offer applies to pre-model year 2016 vehicles only. See Retailers for further details. Personal Contract Purchase. Finance subject to status, terms and conditions apply. Applicants must be 18 years or over. Finance by Vauxhall Finance, PO Box 6666, Cardiff, CF15 7YT. Customer deposit shown after deduction of Vauxhall contribution. Vauxhall Deposit Contribution only available when vehicle financed through Vauxhall Finance. At the end of the agreement there are three options: i) Retain the vehicle: Pay the optional final payment to own the vehicle. ii) Return the vehicle, or iii) Replace: Part Exchange the vehicle, where equity is available. Offer applies to private individuals, Vauxhall Partners and small businesses 1-24 units (purchase only excluding B2B supported units). All other customers are excluded. Offer available on orders or registrations between 2 July 2015 and 7 October 2015.

NEW CORSA COMPANY CAR DRIVER/FLEET INFORMATION

DESIGN, TECH LINE AND TECH LINE GT. HIGH SPEC, LOW P11D

Specifically developed for businesses and company car drivers alike, our Design, Tech Line and Tech Line GT models are seriously fit for Fleet.

Design models (Insignia, Astra and New Corsa) all feature very low P11D values, generous standard specification with a choice of high tech ecoFLEX engines for great fuel economy and low emissions including the new 'whisper diesel' 1.6CDTi (from 97g/km and 7.3mpg combined).

For even more standard specification, step up to our Tech Line range (Insignia, Astra, Mokka, Zafira Tourer and Meriva) again you are guaranteed low P11D values, plus great standard kit including Sat Nav (in lieu of parking sensors and Winter Pack on Meriva), Bluetooth®, USB connection, aux-in socket and digital radio (excluding Meriva).

For maximum impact, take a look at the Astra Tech Line GT with its dynamic sports styling.

With Design, Tech Line or Tech Line GT you can take for granted low Whole Life Costs and low company car driver taxation.

COMPANY CAR DRIVER FREE* 3 DAY TEST DRIVE

Our free* 3 Day Test Drive programme is open to all Company Car Drivers which allows you to choose any model in the current Vauxhall line-up (excluding Ampera, all VXR models and Commercial Vehicles), with full insurance cover provided, to give you a meaningful length of time to make an informed decision about your next company car.

Click below to book your free* test drive

www.vauxhall3dtd.co.uk

or call 0870 240 4848**



BENEFIT IN KIND COMPANY CAR TAXATION†

The car benefit charge will be the car's list price (including VAT, options and accessories fitted, delivery to retailer and number plates, but excluding Vehicle Excise Duty and new vehicle first registration fee) multiplied by the percentage charge for the CO₂ emissions band in which the car falls (see table opposite). Multiply this figure by your personal income tax rate (20% for Basic Rate, 40% for Higher Rate) to calculate your annual benefit in kind tax liability.

Example:

New Corsa Design 1.3CDTi 95PS Start/Stop ecoFLEX 5-door hatchback
(CO₂ emissions 89g/km)

On-the-road RRP £14430.00

Deduct: Vehicle Excise Duty (£0.00)

New vehicle first registration fee (£55.00)

Effective list price £14375.00

Add: Optional two-coat metallic paint
£545.00

List price for tax purposes (P11D value)
£14920.00

Car benefit charge

2015-16 tax year (16%) £2387.00

Benefit in kind tax liability (2015-16 tax year)

Basic Rate (20%) tax payer £477.40

Higher Rate (40%) tax payer £954.80

† = Please note this Price Guide provides taxation information as a guide only. Vauxhall does not provide taxation guidance. Drivers should always take professional advice on their own tax position.

CO ₂ emissions in grams per kilometre	Percentage of car's price to be taxed	
	Petrol 2015-16 tax year	Diesel 2015-16 tax year
up to 50	5	8
51-75	9	12
76-94	13	16
95-99	14	17
100-104	15	18
105-109	16	19
110-114	17	20
115-119	18	21
120-124	19	22
125-129	20	23
130-134	21	24
135-139	22	25
140-144	23	26
145-149	24	27
150-154	25	28
155-159	26	29
160-164	27	30
165-169	28	31
170-174	29	32
175-179	30	33
180-184	31	34
185-189	32	35
190-194	33	36
195-199	34	37
200-204	35	37
205-209	36	37
210 and above	37	37

To calculate your own personal liability a car tax calculator is available at:
<https://www.vauxhallfleet.co.uk/toolbox>

*The free 3 Day Test Drive programme is open to Company Car Drivers and excludes fuel and lubricants; congestion charges; parking and speeding fines and the £250 insurance excess (if applicable). It features a wide selection of models from the Vauxhall range (excluding Ampera, all VXR models and Commercial Vehicles and subject to availability). Drivers must be aged 25 years or over, have held a full driving licence for at least a year and hold a major credit card. You will need to have your driving licence (and proof of identity (i.e. passport) where the driving licence is not a photocard licence) when your car is delivered. While every effort will be made to ensure that at least 3 days are provided for the test drive, this cannot always be guaranteed due to delivery and collection dates and timings. Available for UK Mainland only. Terms and conditions apply. **Telephone lines open Monday-Friday 9.00am to 5.00pm excluding Bank Holidays. Calls may be recorded or monitored for quality and/or training purposes.

FLEET TOOLBOX

Discover the facts in our online Toolbox for both Company Car Drivers and Fleet Decision Makers. The Fleet Toolbox has a host of useful calculators, comparators, interactive listings and information. Visit the Fleet Toolbox by going to www.vauxhall-toolbox.co.uk



ROADTRIP APP

The Vauxhall RoadTrip App is a free app that calculates and logs your mileage expenses for any UK business trips and generates reports to help you complete your mileage claims. Available for both iPhone and Android, visit www.vauxhall-toolbox.co.uk or visit the iPhone or Android stores and search for Vauxhall RoadTrip to download it to your smartphone or tablet.



CONTACT VAUXHALL FLEET

Please contact one of our dedicated sales teams who will be happy to help with your particular enquiry.

Company Car Drivers

Call: 0345 111 2020

Email: company-car@vauxhallinfo.co.uk

Telephone lines are open

– Monday to Friday 8.00am-9.00pm

– Saturday and Sunday 9.00am-6.00pm

Fleet Decision Makers

Depending on the size of your fleet of vehicles, we have a dedicated team to handle your enquiries.

The lines are open Monday to Friday excluding Bank Holidays.

1-24 vehicles

Call: 0845 076 2254 (8.30am-5.00pm)

Email: b2bsales@vauxhall.co.uk

25+ vehicles

Call: 0870 010 0651 (8.30am-5.00pm)

Email: vauxhallfleet@vauxhall.co.uk

Special Vehicles (Police, Fire and Ambulance)

Call: 01525 408 320 (8.30am-5.00pm)

Email: vauxhallspecialvehicles@vauxhall.co.uk

NEW CORSA RANGE HIGHLIGHTS

LIFE £11,080-£13,930

- Heated windscreen
- Remote control central locking
- Electrically operated front windows
- Tyre pressure monitoring system
- Electronic stability programme
- Hill start assist
- Anti-lock Braking System
- Six airbags
- Electronic engine deadlock immobiliser
- Stereo radio and aux-in socket
- Steering column adjustable for reach and rake
- Speed-sensitive power-assisted steering
- Electrically adjustable door mirrors
- 14-inch steel wheels (petrol models)
- 15-inch steel wheels (diesel models)

STING £9175-£10,120

Features over Life

- Bluetooth® connectivity
- 16-inch white alloy wheels
- LED daytime running lights
- Body-colour exterior door handles
- Twin white stripes on bonnet, roof and tailgate
- White door mirror housings and front grille bar
- Black foil on door pillars (not with Dark Sea Blue or Carbon Flash)
- Leather-covered steering wheel
- CD/MP3 CD player/stereo radio and aux-in socket
- USB connection with iPod control
- Six speakers
- Steering wheel mounted audio controls
- Cruise control
- Driver's seat height adjuster

STING R £11,175

Features over Sting

- 16-inch black alloy wheels
- Twin black stripes on bonnet, roof and tailgate
- Black door mirror housings and front grille bar
- VX-Line leather-covered flat-bottom steering wheel
- VX-Line leather-covered gear knob/handbrake lever
- Sports pedals
- Chrome-effect exhaust tailpipe extension
- Sports suspension

EXCITE £12,145-£15,295

Features over Life

- Bluetooth® connectivity
- 16-inch alloy wheels
- LED daytime running lights
- Air conditioning (non air-conditioned 1.2i and 1.4i manual models also available)
- Front fog lights
- IntelliLink audio system with digital radio
- USB connection with iPod control
- Steering wheel mounted audio controls
- Rain-sensitive windscreen wipers
- Automatic lighting control
- Electrically heated leather-covered steering wheel
- Electrically heated front seats
- Cruise control
- Driver's seat height adjuster
- Black foil on door pillars (except with Royal Blue, Dark Sea Blue, Emerald Green or Carbon Flash)
- Body-colour exterior door handles

LIMITED EDITION £13,985-£16,415

Features over Life

- Bluetooth® connectivity
- 17-inch black alloy wheels
- LED daytime running lights
- Body-colour front lower spoiler, side sills, rear roof spoiler (3-door only) and rear lower skirt
- Chrome-effect exhaust tailpipe extension
- Black roof and door mirror housings
- Black front grille bar
- Black foil on door pillars (not with Carbon Flash)
- Electrically adjustable/heated door mirrors
- Sports suspension
- Front fog lights with chrome-effect surround
- Sports-style front seats
- Dark-tinted rear windows
- Air conditioning
- IntelliLink audio system with digital radio
- USB connection with iPod control
- Steering wheel mounted audio controls
- Cruise control and multi-function trip computer
- Sports pedals
- Leather-covered steering wheel

DESIGN £11,080-£14,430

Features over Life

- Bluetooth® connectivity
- 15-inch structure wheels
- LED daytime running lights
- IntelliLink audio system with digital radio
- USB connection with iPod control
- Six speakers
- Steering wheel mounted audio controls
- Leather-covered steering wheel
- Cruise control
- Driver's seat height adjuster
- Air conditioning
- Black foil on door pillars (except with Royal Blue, Dark Sea Blue, Emerald Green or Carbon Flash)
- Body-colour exterior door handles
- Front fog lights

SRI £11,775-£15,125

Features over Life

- Bluetooth® connectivity
- 16-inch black alloy wheels
- LED daytime running lights
- Air conditioning
- Front fog lights with chrome-effect surround
- Sports-style front seats
- Sports pedals
- Leather-covered steering wheel
- IntelliLink audio system with digital radio
- USB connection with iPod control
- Steering wheel mounted audio controls
- Cruise control
- Multi-function trip computer
- Electrically adjustable/heated door mirrors
- Rain-sensitive windscreen wipers
- Automatic lighting control
- Black foil on door pillars (except with Dark Sea Blue, Emerald Green or Carbon Flash)
- Body-colour exterior door handles
- 60/40 split-folding rear seat back
- Driver's seat height adjuster

SRI VX-LINE £12,810-£16,160

Features over SRI

- 17-inch alloy wheels
- Body-colour front lower spoiler, side sills, rear roof spoiler (3-door only) and rear lower skirt
- Body-colour door mirrors
- Chrome-effect exhaust tailpipe extension
- Sports suspension

SE £12,420-£15,770

Features over Design

- 16-inch alloy wheels
- Electrically heated leather-covered steering wheel
- Electrically heated front seats
- Front and rear seats with Morrocana side bolsters
- 60/40 split-folding rear seat back
- Multi-function trip computer
- Electrically adjustable/heated door mirrors
- Rain-sensitive windscreen wipers
- Automatic lighting control
- Front fog lights with chrome-effect surround
- Chrome-effect lower side window mouldings (5-door only)
- Chrome-effect inserts in exterior door handles
- Body-colour door mirrors
- Front and rear parking distance sensors

NEW CORSA PRICES

Model 3-door hatchback	Price (£)	VAT (£)	Total (£)	On-the-road RRP (£)	CO ₂ (g/km)
LIFE					
1.2i 70PS	8604.17	1720.83	10325.00	11080.00	126
1.4i 90PS	8891.67	1778.33	10670.00	11425.00	121
<i>Diesel</i>					
1.3CDTi 75PS S/S ecoFLEX	10479.17	2095.83	12575.00	13330.00	100
STING					
1.2i 70PS	7016.67	1403.33	8420.00	9175.00	124
1.4i 90PS ecoFLEX	7304.17	1460.83	8765.00	9520.00	119
STING R					
1.0i 115PS Direct Injection Turbo S/S ecoFLEX	8683.33	1736.67	10420.00	11175.00	114
EXCITE (SPECIAL EDITION MODEL)					
1.2i 70PS	9491.67	1898.33	11390.00	12145.00	124
1.4i 90PS ecoFLEX	9779.17	1955.83	11735.00	12490.00	119
1.2i 70PS (a/c)	9741.67	1948.33	11690.00	12445.00	124
1.4i 90PS ecoFLEX (a/c)	10029.17	2005.83	12035.00	12790.00	119
1.4i 90PS S/S ecoFLEX Easytronic (a/c)	10575.00	2115.00	12690.00	13445.00	110
1.4i 90PS auto (a/c)	11166.67	2233.33	13400.00	14285.00	139
1.4i 100PS Turbo S/S ecoFLEX (a/c)	10575.00	2115.00	12690.00	13445.00	119
1.0i 115PS Direct Injection Turbo S/S ecoFLEX (a/c)	11266.67	2253.33	13520.00	14275.00	114
<i>Diesel</i>					
1.3CDTi 75PS S/S ecoFLEX (a/c)	11616.67	2323.33	13940.00	14695.00	99
LIMITED EDITION (SPECIAL EDITION MODEL)					
1.2i 70PS	11025.00	2205.00	13230.00	13985.00	126
1.4i 90PS	11312.50	2262.50	13575.00	14330.00	121
1.4i 100PS Turbo S/S	11858.33	2371.67	14230.00	14985.00	122
1.0i 115PS Direct Injection Turbo S/S ecoFLEX	12550.00	2510.00	15060.00	15815.00	115
DESIGN					
1.2i 70PS	8604.17	1720.83	10325.00	11080.00	126
1.4i 90PS	8891.67	1778.33	10670.00	11425.00	121
1.4i 90PS S/S ecoFLEX Easytronic	9437.50	1887.50	11325.00	12080.00	112
1.4i 90PS auto	10029.17	2005.83	12035.00	12920.00	140
1.0i 90PS Direct Injection Turbo S/S ecoFLEX	10129.17	2025.83	12155.00	12910.00	102
<i>Diesel</i>					
1.3CDTi 75PS S/S ecoFLEX	10479.17	2095.83	12575.00	13330.00	100
1.3CDTi 95PS S/S ecoFLEX	10895.83	2179.17	13075.00	13830.00	87

Model 3-door hatchback	Price (£)	VAT (£)	Total (£)	On-the-road RRP (£)	CO ₂ (g/km)
SRI					
1.2i 70PS	9183.33	1836.67	11020.00	11775.00	124
1.4i 90PS ecoFLEX	9470.83	1894.17	11365.00	12120.00	119
1.4i 90PS auto	10608.33	2121.67	12730.00	13615.00	139
1.0i 90PS Direct Injection Turbo S/S ecoFLEX	10708.33	2141.67	12850.00	13605.00	100
1.4i 100PS Turbo S/S ecoFLEX	10016.67	2003.33	12020.00	12775.00	119
<i>Diesel</i>					
1.3CDTi 75PS S/S ecoFLEX	11058.33	2211.67	13270.00	14025.00	99
1.3CDTi 95PS S/S ecoFLEX	11475.00	2295.00	13770.00	14525.00	85
SRI VX-LINE					
1.2i 70PS	10045.83	2009.17	12055.00	12810.00	126
1.4i 90PS	10333.33	2066.67	12400.00	13155.00	121
1.4i 90PS auto	11470.83	2294.17	13765.00	14650.00	140
1.4i 100PS Turbo S/S	10879.17	2175.83	13055.00	13810.00	122
1.0i 115PS Direct Injection Turbo S/S ecoFLEX	11570.83	2314.17	13885.00	14640.00	115
<i>Diesel</i>					
1.3CDTi 75PS S/S ecoFLEX	11920.83	2384.17	14305.00	15060.00	100
1.3CDTi 95PS S/S ecoFLEX	12337.50	2467.50	14805.00	15560.00	87
SE					
1.2i 70PS	9720.83	1944.17	11665.00	12420.00	124
1.4i 90PS ecoFLEX	10008.33	2001.67	12010.00	12765.00	119
1.4i 90PS auto	11145.83	2229.17	13375.00	14260.00	139
1.0i 90PS Direct Injection Turbo S/S ecoFLEX	11245.83	2249.17	13495.00	14250.00	100
1.4i 100PS Turbo S/S ecoFLEX	10554.17	2110.83	12665.00	13420.00	119
<i>Diesel</i>					
1.3CDTi 75PS S/S ecoFLEX	11595.83	2319.17	13915.00	14670.00	99
1.3CDTi 95PS S/S ecoFLEX	12012.50	2402.50	14415.00	15170.00	85

Please note: On-the-road recommended retail prices (RRP) include number plates and delivery to retailer of £700.00 (inc. £116.67 VAT), 12 months' Vehicle Excise Duty and new vehicle first registration fee of £55.00. Excludes fuel and insurance.
a/c = Air conditioning. S/S = Start/Stop.

Easytronic transmission is a five-speed manual gearbox with a fully automatic mode.
Our ecoFLEX models combine superb performance, reduced CO₂ emissions and highly competitive economy figures.

NEW CORSA PRICES

Model 5-door hatchback	Price (£)	VAT (£)	Total (£)	On-the-road RRP (£)	CO ₂ (g/km)
LIFE					
1.2i 70PS	9104.17	1820.83	10925.00	11680.00	126
1.4i 90PS	9391.67	1878.33	11270.00	12025.00	122
<i>Diesel</i>					
1.3CDTi 75PS S/S ecoFLEX	10979.17	2195.83	13175.00	13930.00	100
STING					
1.2i 70PS	7516.67	1503.33	9020.00	9775.00	124
1.4i 90PS ecoFLEX	7804.17	1560.83	9365.00	10120.00	120
EXCITE (SPECIAL EDITION MODEL)					
1.2i 70PS	9991.67	1998.33	11990.00	12745.00	124
1.4i 90PS ecoFLEX	10279.17	2055.83	12335.00	13090.00	120
1.2i 70PS (a/c)	10241.67	2048.33	12290.00	13045.00	124
1.4i 90PS ecoFLEX (a/c)	10529.17	2105.83	12635.00	13390.00	120
1.4i 90PS S/S ecoFLEX Easytronic (a/c)	11075.00	2215.00	13290.00	14045.00	110
1.4i 90PS auto (a/c)	11666.67	2333.33	14000.00	14885.00	139
1.4i 100PS Turbo S/S ecoFLEX (a/c)	11075.00	2215.00	13290.00	14045.00	120
1.0i 115PS Direct Injection Turbo S/S ecoFLEX (a/c)	11766.67	2353.33	14120.00	14875.00	115
<i>Diesel</i>					
1.3CDTi 75PS S/S ecoFLEX (a/c)	12116.67	2423.33	14540.00	15295.00	99
LIMITED EDITION (SPECIAL EDITION MODEL)					
1.2i 70PS	11525.00	2305.00	13830.00	14585.00	126
1.4i 90PS	11812.50	2362.50	14175.00	14930.00	122
1.4i 100PS Turbo S/S	12358.33	2471.67	14830.00	15585.00	123
1.0i 115PS Direct Injection Turbo S/S ecoFLEX	13050.00	2610.00	15660.00	16415.00	117
DESIGN					
1.2i 70PS	9104.17	1820.83	10925.00	11680.00	126
1.4i 90PS	9391.67	1878.33	11270.00	12025.00	122
1.4i 90PS S/S ecoFLEX Easytronic	9937.50	1987.50	11925.00	12680.00	112
1.4i 90PS auto	10529.17	2105.83	12635.00	13520.00	140
1.0i 90PS Direct Injection Turbo S/S ecoFLEX	10629.17	2125.83	12755.00	13510.00	106
<i>Diesel</i>					
1.3CDTi 75PS S/S ecoFLEX	10979.17	2195.83	13175.00	13930.00	100
1.3CDTi 95PS S/S ecoFLEX	11395.83	2279.17	13675.00	14430.00	89

Model 5-door hatchback	Price (£)	VAT (£)	Total (£)	On-the-road RRP (£)	CO ₂ (g/km)
SRI					
1.2i 70PS	9683.33	1936.67	11620.00	12375.00	124
1.4i 90PS ecoFLEX	9970.83	1994.17	11965.00	12720.00	120
1.4i 90PS auto	11108.33	2221.67	13330.00	14215.00	139
1.0i 90PS Direct Injection Turbo S/S ecoFLEX	11208.33	2241.67	13450.00	14205.00	104
1.4i 100PS Turbo S/S ecoFLEX	10516.67	2103.33	12620.00	13375.00	120
<i>Diesel</i>					
1.3CDTi 75PS S/S ecoFLEX	11558.33	2311.67	13870.00	14625.00	99
1.3CDTi 95PS S/S ecoFLEX	11975.00	2395.00	14370.00	15125.00	87
SRI VX-LINE					
1.2i 70PS	10545.83	2109.17	12655.00	13410.00	126
1.4i 90PS	10833.33	2166.67	13000.00	13755.00	122
1.4i 90PS auto	11970.83	2394.17	14365.00	15250.00	140
1.4i 100PS Turbo S/S	11379.17	2275.83	13655.00	14410.00	123
1.0i 115PS Direct Injection Turbo S/S ecoFLEX	12070.83	2414.17	14485.00	15240.00	117
<i>Diesel</i>					
1.3CDTi 75PS S/S ecoFLEX	12420.83	2484.17	14905.00	15660.00	100
1.3CDTi 95PS S/S ecoFLEX	12837.50	2567.50	15405.00	16160.00	89
SE					
1.2i 70PS	10220.83	2044.17	12265.00	13020.00	124
1.4i 90PS ecoFLEX	10508.33	2101.67	12610.00	13365.00	120
1.4i 90PS auto	11645.83	2329.17	13975.00	14860.00	139
1.0i 90PS Direct Injection Turbo S/S ecoFLEX	11745.83	2349.17	14095.00	14850.00	104
1.4i 100PS Turbo S/S ecoFLEX	11054.17	2210.83	13265.00	14020.00	120
<i>Diesel</i>					
1.3CDTi 75PS S/S ecoFLEX	12095.83	2419.17	14515.00	15270.00	99
1.3CDTi 95PS S/S ecoFLEX	12512.50	2502.50	15015.00	15770.00	87

Please note: On-the-road recommended retail prices (RRP) include number plates and delivery to retailer of £700.00 (inc. £116.67 VAT), 12 months' Vehicle Excise Duty and new vehicle first registration fee of £55.00. Excludes fuel and insurance.
a/c = Air conditioning. S/S = Start/Stop.

Easytronic transmission is a five-speed manual gearbox with a fully automatic mode.
Our ecoFLEX models combine superb performance, reduced CO₂ emissions and highly competitive economy figures.

NEW CORSA FEATURES/OPTIONS

SAFETY

Standard features

Airbags: • Driver's dual-stage airbag • Front passenger's dual-stage airbag • Deactivation switch for front passenger's airbag • Front seat side-impact airbags • Full-size curtain airbags

Seating: • ISOFIX child seat restraint system for outer rear seats incorporating top tether – Secures specially designed ISOFIX child safety seats to the vehicle itself, virtually eliminating the dangers that can result from improper installation (does not include child seat) • Height-adjustable front seat head restraints • Height-adjustable front seatbelts • Front seatbelt pretensioner system • Driver's and front passenger's seatbelt force limiters – Reduces potential upper body injuries during a frontal impact • Adjustable outer rear seat head restraints • Three inertia-reel lap and diagonal rear seatbelts • Anti-submarining ramps in all seats – Help prevent occupants sliding underneath the lap belt during a collision • Seatbelt unfastened audible warning for all seats

Electronic: • Electronic Stability Programme-plus (ESP-plus) with traction control – Reduces the possibility of losing control of the vehicle • Anti-lock Braking System (ABS) with electronic brakeforce distribution • Straight line stability control • Cornering brake control • Emergency brake assist • Adaptive brake lights • Drag torque control – Helps maintain stability when suddenly lifting off the accelerator • Tyre pressure monitoring system • Hill start assist

Body: • Pedal release system – Reduces potential injury to the driver's legs and feet during a severe frontal impact • Laminated windscreen • Reinforced passenger safety cell • Side-impact protection beams • Fuel tank located ahead of rear axle • Child-proof locks on rear doors

Additional features	Life	Sting	Sting R	Excite	Limited Edition	Design	SRi	SRi Vx-Line	SE	Price (£) exc. VAT	Total (£) inc. VAT
Technical Pack One • Forward collision alert • Traffic sign recognition • Lane departure warning • Following distance indicator • Electro-chromatic anti-dazzle rear-view mirror • Rear-view camera									○	708.33	850.00
Technical Pack Two ¹ • Forward collision alert • Traffic sign recognition • Lane departure warning • Following distance indicator • Electro-chromatic anti-dazzle rear-view mirror • Rear-view camera • Front and rear parking distance sensors				○	○	○	○	○		1083.33	1300.00

SECURITY

Standard features • Remote control central locking (doors, tailgate, fuel flap) with security deadlocks • Electronic theft protection for audio equipment • Electronic engine deadlock immobiliser • 'Key left in ignition' audible warning • Visible Vehicle Identification Number (VIN) • Locking wheel bolts for alloy wheels (where fitted) • Door-to-door illumination

HEATING AND VENTILATION

Standard features • Side window demist vents and four adjustable heating and ventilation outlets • Air blend heater with four-speed fan and illuminated controls • Interior pollen filter

Additional features	Life	Sting	Sting R	Excite	Limited Edition	Design	SRi	SRi Vx-Line	SE	Price (£) exc. VAT	Total (£) inc. VAT
Interior odour-reducing activated charcoal filter	● ²	● ²	● ²								
Air conditioning (includes air recirculation facility)	○	○	○	● ³	●	●	●	●	●	437.50	525.00
Electronic climate control incorporating air conditioning				○ ⁴	○		○	○	○	329.17	395.00

● = Standard equipment. ○ = Optional at extra cost.

1 = Not available in conjunction with optional bi-xenon headlights. 2 = Activated charcoal filter is deleted if optional air conditioning is specified. 3 = Non air-conditioned 1.2i and 1.4i 90PS manual models also available. 4 = Only available on models fitted with air conditioning.

NEW CORSA FEATURES/OPTIONS

FACIA, INSTRUMENTS AND CONTROLS

Standard features • Multi-function display panel showing time, date, audio information and outside air temperature (with ice warning function) • Digital clock with automatic RDS time adjustment • Adjustable speed limit audible warning – Allows the driver to set the speed above which an alarm sounds • Steering column adjustable for reach and rake • City mode button providing lighter steering at parking speeds (deleted if Technical Pack One or Two is specified) • Shift-up indication light • Trip odometer • Rev counter • Electronically controlled fuel gauge • Low fuel level warning light • Headlight/brake light bulb failure warning light • Service-due indicator • Handbrake-on warning light • Instrument panel light dimmer • Glovebox with lid • Electrical accessory socket

	Life	Sting	Sting R	Excite	Limited Edition	Design	SRI	SRI VX-Line	SE	Price (£) exc. VAT	Total (£) inc. VAT
Additional features											
Leather-covered steering wheel		●			●	●	●	●			
VX-Line leather-covered flat-bottom sports steering wheel, gear knob and handbrake lever			●								
Leather-covered gear knob					●		●	●	●		
Winter Pack • Electrically heated front seats • Electrically heated leather-covered steering wheel				●	○	○	○	○	●	183.33	220.00
Multi-function trip computer (instantaneous fuel consumption, average fuel consumption, amount of fuel used, average speed, distance travelled, range remaining, stopwatch)					●		●	●	●		
Cruise control		●	●	●	●	●	●	●	●		

SEATING AND UPHOLSTERY

Standard features • Reclining front seats • Adjustable rear seat backrest • Easy-entry front seats with memory function (three-door models only)

	Life	Sting	Sting R	Excite	Limited Edition	Design	SRI	SRI VX-Line	SE	Price (£) exc. VAT	Total (£) inc. VAT
Additional features											
Driver's seat height adjuster		●	●	●	●	●	●	●	●		
Front passenger's seat height adjuster ⁵		○	○	○	○	○	○	○	○	45.83	55.00
Front passenger's underseat storage tray (deleted if optional sunroof is fitted)							●	●			
Sports-style front seats					●		●	●			
Map pockets on front seat backs									●		
Electrically heated front seats (part of Winter Pack)				●	□	□	□	□	●		
Spot Shimmer Black cloth seat trim	●	●	●	●		●					
Network Moonray cloth seat trim					●		●				
Network Sunbeam cloth seat trim					N/C ⁶						
Graphic Embossed Black cloth/Morrocana seat trim									●		
Hysle Embossed Atmosphere cloth/Morrocana seat trim									N/C		
One-piece folding rear seat	●	●	●	●	●	●					
60/40 split-folding rear seat back							●	●	●		

● = Standard equipment. ○ = Optional at extra cost. □ = Available as part of an extra-cost option pack. N/C = No-cost option.

⁵ = Also fitted at no extra cost in conjunction with optional panoramic glass sunroof. ⁶ = Not available with Flame Red, Peppermint Green or Lime Green exterior colours.

NEW CORSA FEATURES/OPTIONS

ADDITIONAL INTERIOR FEATURES

Standard features • Front door pockets • Rear door pockets (five-door models only) • Rear bottle holders (three-door models only) • Chrome-effect door handles • Drinks holder in centre console • Driver's and front passenger's tiltable assist handles • Two rear tiltable passenger assist handles (five-door models only) • Dipping rear-view mirror • Twin sunvisors, driver's with vanity mirror and cover • Front map reading lights • Rear reading light (five-door models only) • Luggage compartment cover • Stowage facility for luggage compartment cover behind rear seats • Illuminated luggage area • Load restraint lashing eyes • Interior tailgate handles • Chrome-effect handbrake button

Additional features	<i>Life</i>	<i>Sting</i>	<i>Sting R</i>	<i>Excite</i>	<i>Limited Edition</i>	<i>Design</i>	<i>SRI</i>	<i>SRI Vx-Line</i>	<i>SE</i>	Price (£) exc. VAT	Total (£) inc. VAT
Chrome-effect trim on instrument surrounds									●		
Chrome-effect gear knob trim		●	●	●	●	●	●	●	●		
Gunpowder grey facia	●										
Piano black facia		●	●		N/C ⁷		● ⁸	● ⁸			
Rhutenium facia with chrome-effect inserts				●		●			● ⁹		
Matt bronze-effect facia with chrome-effect inserts									● ¹⁰		
Piano black facia with white inserts (only with Network Moonray cloth trim)					● ¹¹						
Piano black facia with red inserts (only with Network Moonray cloth trim)					● ¹²		● ¹³	● ¹³			
Piano black facia with Flaming Yellow inserts (only with Network Sunbeam cloth trim)					N/C ¹⁴						
Piano black facia with Limelight Green inserts (Limelight Green models with Network Sunbeam cloth trim only)					N/C						
Ambient lighting							●	●			
Electro-chromatic anti-dazzle rear-view mirror (part of Sight and Light Pack One)				●	□	□	●	●	●		
Sports pedals			●		●		●	●			

MECHANICAL

Standard features • Front-wheel drive • Gas-pressure dampers • Front anti-roll bar • Speed-sensitive electric power-assisted steering

Additional features	<i>Life</i>	<i>Sting</i>	<i>Sting R</i>	<i>Excite</i>	<i>Limited Edition</i>	<i>Design</i>	<i>SRI</i>	<i>SRI Vx-Line</i>	<i>SE</i>	Price (£) exc. VAT	Total (£) inc. VAT
Five-speed manual gearbox (excluding 1.0i 90PS/115PS Turbo and 1.4i 100PS Turbo models)	●	●		●	●	●	●	●	●		
Six-speed manual gearbox (1.0i 90PS/115PS Turbo and 1.4i 100PS Turbo models)		●	●	●	●	●	●	●	●		
Easytronic five-speed transmission with sequential manual gearshift or automatic mode (1.4i 90PS models only)				▲		▲					
Six-speed automatic transmission (1.4i 90PS models only)				▲		▲	▲	▲	▲		
Sports suspension			●		●			●	○ ¹⁵		

● = Standard equipment. ○ = Optional at extra cost. ▲ = See price pages for details. □ = Available as part of an extra-cost option pack. N/C = No-cost option.

7 = Only available in conjunction with Network Moonray cloth trim. 8 = Standard on Limelight Green, Flaming Yellow, Emerald Green, Dark Sea Blue, Peppermint Green and Lime Green models. Available with all other exterior colours as a no-cost option. 9 = Only available with Graphic cloth/Morrocana trim. 10 = Only available with Hysle cloth/Morrocana trim. 11 = Standard with all exterior colours except Flame Red, where it is not available. 12 = Standard on Flame Red models only. Not available with other exterior colours. 13 = Standard on Flame Red, Summit White, Sovereign Silver, Carbon Flash, Pepperdust, Asteroid Grey and Shiny Rock models. Not available with other exterior colours. 14 = Not available on Flame Red, Limelight Green, Peppermint Green or Lime Green models. 15 = Fitted in conjunction with optional 17-inch alloy wheels. Not available separately.

NEW CORSA FEATURES/OPTIONS

EXTERIOR AND CONVENIENCE FEATURES

Standard features • Heated windscreen • Electrically operated front windows with safety autoreverse and one-touch facility • Heated rear window • Intermittent rear window wash/wipe • Two-speed windscreen wipers with variable intermittent wipe • Tinted glass • Manually foldable door mirrors

	Life	Sting	Sting R	Excite	Limited Edition	Design	SRI	SRI VX-Line	SE	Price (£) exc. VAT	Total (£) inc. VAT
Additional features											
Rain-sensitive windscreen wipers (part of Sight and Light Packs)				●	□	□	●	●	●		
Electrically adjustable door mirrors (wide-angle on driver's side)	●	●	●	● ¹⁶		●					
Electrically adjustable/heated door mirrors (wide-angle on driver's side) ¹⁶				●	●	●	●	●	●		
Folding key		●	●	●	●	●	●	●	●		
Panoramic glass sunroof with interior blind ¹⁷				○	○		○	○	○	625.00	750.00
Front and rear parking distance sensors		○	○	○	○	○	○	○	●	375.00	450.00
Advanced park assist with automatic steering including side blind spot detection and front and rear parking distance sensors				○ ¹⁸	○		○	○		412.50	495.00
Advanced park assist with automatic steering including side blind spot detection									○	37.50	45.00
Rear-view camera with coloured guidelines and warning signs for detected obstacles (part of Technical Packs)				□	□	□	□	□	□		
Flex-Fix [®] integrated carrier system ¹⁹				○			○		○	375.00	450.00

EXTERIOR LIGHTING

Standard features • Halogen headlights • Lights-on audible warning • Electric headlight beam levelling • High-level LED centre brake light • Rear fog light

	Life	Sting	Sting R	Excite	Limited Edition	Design	SRI	SRI VX-Line	SE	Price (£) exc. VAT	Total (£) inc. VAT
Additional features											
Daytime running lights	●										
LED daytime running lights		●	●	●	●	●	●	●	●		
Welcome lighting		●	●	●	●	●	●	●	●		
Bi-xenon headlights with cornering light ²⁰					○			○	○	329.17	395.00
Automatic lighting control (part of Sight and Light Packs)				●	□	□	●	●	●		
Front fog lights				●		●					
Front fog lights with chrome-effect surround					●		●	●	●		
Sight and Light Pack One ²¹ • Rain-sensitive windscreen wipers • Automatic lighting control • Electro-chromatic anti-dazzle rear-view mirror				●	○	○	●	●	●	191.67	230.00
Sight and Light Pack Two ²² • Rain-sensitive windscreen wipers • Automatic lighting control				●	○	○	●	●	●	166.67	200.00

● = Standard equipment. ○ = Optional at extra cost. □ = Available as part of an extra-cost option pack.

¹⁶ = Wide-angle facility is removed when optional advanced park assist is specified. ¹⁷ = Also includes front passenger's seat height adjuster and front map reading lights. Deletes front passenger's underseat storage tray on SRI and SRI VX-Line models. Non-metallic roof panel covering is coloured black. ¹⁸ = Includes body-colour door mirrors. ¹⁹ = Not available in conjunction with Technical Packs or optional spare wheel. Includes two-bicycle carrier attachment. Please note, bicycle size restrictions apply, please contact your local retailer for further information. ²⁰ = Not available in conjunction with Technical Pack Two. ²¹ = Not available with Technical Packs. ²² = Only available in conjunction with Technical Packs.

NEW CORSA FEATURES/OPTIONS

EXTERIOR PROTECTION AND STYLING

Features	Life	Sting	Sting R	Excite	Limited Edition	Design	SRi	SRi VX-Line	SE	Price (£) exc. VAT	Total (£) inc. VAT
Twin white stripes on bonnet, roof and tailgate		●									
Twin black stripes on bonnet, roof and tailgate			●								
White door mirror housings		●									
Black Carbon Flash door mirror housings			●		●						
White front grille bar		●									
Black front grille bar			●		●						
Body-colour door handles		●	●	●	●	●	●	●	●		
Body-colour door mirrors				○ ²³				●	●		
Body-colour rear roof spoiler (3-door models only)					●			●			
Body-colour front lower spoiler/side sills/rear lower skirt					●			●			
Chrome-effect inserts in door handles									●		
Chrome-effect lower side window mouldings (5-door models only)									●		
Dark-tinted rear windows					●						
Black foil on B-pillars (not with Royal Blue or optional Carbon Flash, Dark Sea Blue or Emerald Green exterior colours)		●	●	●	●	●	●	●	●		
Black Carbon Flash roof					●						
Alloy-effect front door sill covers with 'Vauxhall' lettering									●		
Chrome-effect exhaust tailpipe extension			●	● ²⁴	●			●			
Brilliant paint	○	○	○	○	○	○	○	○	○	229.17	275.00
Two-coat metallic or pearlescent paint	○	○	○	○	○	○	○	○	○	454.17	545.00

● = Standard equipment. ○ = Optional at extra cost.

²³ = Fitted in conjunction with optional advanced park assist. Not available separately. ²⁴ = 1.0i 115PS Direct Injection Turbo models only.

NEW CORSA FEATURES/OPTIONS

AUDIO, COMMUNICATION AND NAVIGATION

Features	Life	Sting	Sting R	Excite	Limited Edition	Design	SRi	SRi VX-Line	SE	Price (£) exc. VAT	Total (£) inc. VAT
R 30 • AM/FM stereo radio with 36 station presets • Aux-in socket • RDS with Traffic Programme • 20 watts per channel output • 4 speakers	●										
CD 30 BT • CD/MP3 CD player • USB connection with iPod control • Aux-in socket • AM/FM stereo radio with 36 station presets • RDS with Traffic Programme • 20 watts per channel output • 6 speakers		●	●	N/C ²⁵	N/C ²⁵	N/C ²⁵	N/C ²⁵	N/C ²⁵	N/C ²⁵		
IntelliLink • Touch-screen infotainment system • Internet, internet radio and navigation via smartphone screen scraping • Music/video playback via USB or aux-in • Music streaming via Bluetooth® • Digital radio • AM/FM stereo radio with 36 station presets • RDS with Traffic Programme • 7-inch colour monitor • 20 watts per channel output • 6 speakers				●	●	●	●	●	●		
Bluetooth® connectivity		●	●	●	●	●	●	●	●		
Steering wheel mounted audio controls		●	●	●	●	●	●	●	●		

● = Standard equipment. N/C = No-cost option.

²⁵ = Fitted in lieu of IntelliLink audio system.

INTELLILINK

IntelliLink is Vauxhall's next-generation in-car infotainment system. It features a 7-inch colour touch-screen that enables access to, and operation of, a wide range of functions including music, video, phone, navigation and internet services.

The system isn't equipped with a CD or DVD player. Instead, it's designed to support the latest media sources including Bluetooth® and USB devices, together with smartphones and their applications. All of these features are accessed through the touch-screen's Home menu.

Since many of these features are accessed via smartphone, the IntelliLink unit is designed to allow application updates as and when they become available, thus enabling it to make use of the latest smartphone developments as they happen.

Music can be played either through the radio or from personal music players via USB connection, aux-in or Bluetooth® audio streaming. When played via USB, IntelliLink's built-in Gracenote® link provides song information and album artwork. Films and slide shows can also be viewed via the USB connection, but this facility is disabled when the car is moving.

IntelliLink is able to pair with up to four Bluetooth® phones simultaneously, with each phone's address book downloaded to the audio unit so that the car effectively becomes the phone. Phone priority can then be set through the touch-screen display.

The smartphone link provides access to approved applications* such as Stitcher™, BringGo navigation and TuneIn Radio. Together, these give access to satellite navigation and a wide range of internet radio stations.

*Access to specific applications depends on the type of phone.

DIGITAL RADIO

Now widely available in the UK, digital audio broadcasts offer the user a variety of advantages over traditional FM, starting with the digital quality sound which is immune to any hiss or crackle.

You'll often find a broader range of stations on offer too, many of which are not available on FM, and listening to them couldn't be easier – you simply select the station, by name, from the displayed list, thus removing the need to retune or look for stations when travelling around. Some stations will even display the artists' names and song titles on the car's graphic display, while they're played.

BLUETOOTH® CONNECTIVITY

All models (except Life) include built-in Bluetooth®, allowing transfer of phonebook contents, call history and caller ID. On models fitted with IntelliLink simply tap the touch-screen to accept an incoming call and hear your caller through the stereo speakers. To make an outgoing call, choose a name from the phonebook via the touch-screen display, then carry on your conversation hands-free. The unit features an in-built microphone to pick up your voice. You can even stream music directly from your compatible mobile phone.

USB CONNECTION





Fitted as standard to all models (except Life), the USB connection provides iPod/iPhone control and read-out of iPod/iPhone functions through the audio system display. Traditional aux-in sockets only allow control of the volume through the car's audio system. The USB connection also means that the iPod/iPhone will charge whilst it is connected. If you prefer to store your music on a memory stick this is no problem, you simply plug it in and play.

AUX-IN SOCKET

The aux-in socket allows you to connect your portable MP3 music player directly into the car's audio system. All you need is your music player and a suitable connecting lead and you can listen to all your favourite tunes through your car's speaker system. Using your MP3 music player in the car couldn't be easier – use it to select the music, as you would normally do, while controlling the volume via the car's regular volume controls.

NEW CORSA FEATURES/OPTIONS

WHEELS AND TYRES





	Life	Sting	Sting R	Excite	Limited Edition	Design	SRi	SRi VX-Line	SE	Price (£) exc. VAT	Total (£) inc. VAT
Emergency tyre inflation kit (in lieu of spare wheel)	●	●	●	●	●	●	●	●	●		
Full-size steel spare wheel (in lieu of emergency tyre inflation kit)	○					○				91.67	110.00
Steel space-saver spare wheel (in lieu of emergency tyre inflation kit)		○	○	○			○		○	91.67	110.00
 14-inch steel wheels with flush covers ²⁶ : 185/70 R 14 tyres	●										
 15-inch steel wheels with flush covers ²⁷ : 185/65 R 15 tyres	●										
 15-inch structure wheels with flush covers: 185/65 R 15 tyres						●					
 15-inch alloy wheels: 185/65 R 15 tyres						○				125.00	150.00

● = Standard equipment. ○ = Optional at extra cost.

²⁶ = Fitted to petrol models only. ²⁷ = Fitted to diesel models only.

NEW CORSA FEATURES/OPTIONS



WHEELS AND TYRES

	Life	Sting	Sting R	Excite	Limited Edition	Design	SRi	SRi VX-Line	SE	Price (£) exc. VAT	Total (£) inc. VAT
 <p>16-inch alloy wheels: 195/55 R 16 tyres</p>				●							
 <p>16-inch alloy wheels: 195/55 R 16 tyres</p>								●			
 <p>16-inch white alloy wheels: 195/55 R 16 tyres</p>		●									
 <p>16-inch black alloy wheels: 195/55 R 16 tyres</p>			●			●					

● = Standard equipment.





NEW CORSA FEATURES/OPTIONS

WHEELS AND TYRES

	Life	Sting	Sting R	Excite	Limited Edition	Design	SRi	SRi VX-Line	SE	Price (£) exc. VAT	Total (£) inc. VAT
 17-inch alloy wheels: 215/45 R 17 tyres								●			
 17-inch black alloy wheels: 215/45 R 17 tyres					●						
 17-inch diamond-cut titan alloy wheels: 215/45 R 17 tyres								○	333.33	400.00	

● = Standard equipment. ○ = Optional at extra cost.

TYRE RATING

Tyre size	Fuel efficiency group	Wet grip performance	External noise	
			Measured (dB)	Group
185/70 R 14	C	B	70	
185/65 R 15	B-C	B	69-70	
195/55 R 16	B-C	B	68-71	
215/45 R 17	C	B	71	

Tyre rating according to EU Regulation 1222/2009

NEW CORSA SPECIFICATIONS

PETROL ENGINES

	1.2i	1.4i	1.4i Turbo Start/Stop
Capacity	1229cc	1398cc	1364cc
Maximum power	70PS (51kW) @ 5600rpm	90PS (66kW) @ 6000rpm	100PS (74kW) @ 3500-6000rpm
Maximum torque	115Nm (85 lb.ft.) @ 4000rpm	130Nm (96 lb.ft.) @ 4000rpm	200Nm (147 lb.ft.) @ 1850-3500rpm
Configuration	4 cylinders, 4 valves per cylinder, double overhead camshafts	4 cylinders, 4 valves per cylinder, double overhead camshafts	4 cylinders, 4 valves per cylinder, double overhead camshafts
Fuel/induction system	Naturally aspirated with Variable Valve Timing. Multi-point sequential fuel injection	Naturally aspirated with Variable Valve Timing. Multi-point sequential fuel injection	Turbocharger with intercooler. Variable Valve Timing. Multi-point sequential fuel injection
Emission compliance	Euro 6	Euro 6	Euro 6
Service interval	20,000 miles or 1 year (whichever occurs sooner)	20,000 miles or 1 year (whichever occurs sooner)	20,000 miles or 1 year (whichever occurs sooner)

	1.0i Direct Injection Turbo ecoFLEX Start/Stop	1.0i Direct Injection Turbo ecoFLEX Start/Stop
Capacity	999cc	999cc
Maximum power	90PS (67kW) @ 3700-6000rpm	115PS (85kW) @ 5000-6000rpm
Maximum torque	170Nm (125 lb.ft.) @ 1800-3700rpm	170Nm (125 lb.ft.) @ 1800-4500rpm
Configuration	3 cylinders, 4 valves per cylinder, double overhead camshafts	3 cylinders, 4 valves per cylinder, double overhead camshafts
Fuel/induction system	Turbocharger with intercooler. Direct fuel injection	Turbocharger with intercooler. Direct fuel injection
Emission compliance	Euro 6	Euro 6
Service interval	20,000 miles or 1 year (whichever occurs sooner)	20,000 miles or 1 year (whichever occurs sooner)

NEW CORSA SPECIFICATIONS

DIESEL ENGINES

	1.3CDTi 75PS ecoFLEX Start/Stop	1.3CDTi 95PS ecoFLEX Start/Stop
Capacity	1248cc	1248cc
Maximum power	75PS (55kW) @ 3750rpm	95PS (70kW) @ 3750rpm
Maximum torque	190Nm (140 lb.ft.) @ 1500-2500rpm	190Nm (140 lb.ft.) @ 1500-3500rpm
Configuration	4 cylinders, 4 valves per cylinder, double overhead camshafts	4 cylinders, 4 valves per cylinder, double overhead camshafts
Fuel/induction system	Turbocharger with intercooler. Common rail fuel injection	Variable geometry turbocharger with intercooler. Common rail fuel injection
Emission compliance	Euro 6 with Diesel Particulate Filter	Euro 6 with Diesel Particulate Filter
Service interval	20,000 miles or 1 year (whichever occurs sooner)	20,000 miles or 1 year (whichever occurs sooner)

START/STOP TECHNOLOGY

New Corsa's Start/Stop system offers real benefits by improving fuel economy and reducing CO₂ emissions, particularly in town. It does this by automatically stopping the engine when you come to a standstill, and then restarting as you prepare to move off.

Before automatically stopping the engine a number of system checks are carried out to ensure that it is both safe and practical to do so. To ensure safety, the driver must depress the clutch pedal, shift in to neutral, and then release the clutch pedal. System checks carried out before Auto Stop activates include:

- Start/Stop system is not manually deactivated via the facia button
- Sufficient brake vacuum is available to prevent the car rolling down an incline
- Battery is in good condition and charged
- Outside air temperature and engine temperature are above specified minima

- Electronic climate control (where fitted) is not in maximum heating or maximum cooling mode
- Self-cleaning function of the diesel particulate filter is not active

If all of these conditions are satisfied then the vehicle will Auto Stop.

When you are ready to pull away from standstill, Auto Restart is activated by depressing the clutch pedal.

Whilst at a standstill the vehicle is continually monitored. If necessary, the engine will automatically be restarted. Conditions that would initiate an Auto Restart include:

- Low battery level
- Brake vacuum below specified minimum
- Start/Stop system is manually deactivated
- Stationary for 5.5 minutes

NEW CORSA SPECIFICATIONS

PERFORMANCE, FUEL ECONOMY AND EMISSIONS

	Wheel size (inches)	Performance (manufacturer's figures)		Fuel economy mpg (litres/100km)#			CO ₂ emissions g/km#	Vehicle Excise Duty* First year rate	Standard rate	Benefit in kind company car taxation rates – 2015/16 tax year
		Maximum speed (mph)	Acceleration 0-62mph (sec)	Urban driving	Extra-urban driving	Combined figure				
Manual										
1.2i 70PS	14/15/17	101	16.0	42.2 (6.7)	61.4 (4.6)	52.3 (5.4)	126	£0	£110	20%
1.2i 70PS	16	101	16.0	42.8 (6.6)	62.8 (4.5)	53.3 (5.3)	124	£0	£110	19%
1.4i 90PS 3-door	14/15/17	109	13.2	42.8 (6.6)	65.7 (4.3)	54.3 (5.2)	121	£0	£110	19%
1.4i 90PS ecoFLEX 3-door	16	109	13.2	43.5 (6.5)	65.7 (4.3)	55.4 (5.1)	119	£0	£30	18%
1.4i 90PS 5-door	14/15/17	109	13.2	42.8 (6.6)	64.2 (4.4)	54.3 (5.2)	122	£0	£110	19%
1.4i 90PS ecoFLEX 5-door	16	109	13.2	43.5 (6.5)	65.7 (4.3)	55.4 (5.1)	120	£0	£30	19%
1.4i 100PS Turbo S/S ecoFLEX 3-door	16	115	11.0	44.1 (6.4)	65.7 (4.3)	55.4 (5.1)	119	£0	£30	18%
1.4i 100PS Turbo S/S 3-door	17	115	11.0	42.8 (6.6)	64.2 (4.4)	54.3 (5.2)	122	£0	£110	19%
1.4i 100PS Turbo S/S ecoFLEX 5-door	16	115	11.0	44.1 (6.4)	65.7 (4.3)	55.4 (5.1)	120	£0	£30	19%
1.4i 100PS Turbo S/S 5-door	17	115	11.0	43.5 (6.5)	62.8 (4.5)	53.3 (5.3)	123	£0	£110	19%
1.0i 90PS Direct Injection Turbo S/S ecoFLEX 3-door	15/17	112	11.9	52.3 (5.4)	76.3 (3.7)	65.7 (4.3)	102	£0	£20	15%
1.0i 90PS Direct Injection Turbo S/S ecoFLEX 3-door	16	112	11.9	52.3 (5.4)	76.3 (3.7)	65.7 (4.3)	100	£0	£0	15%
1.0i 90PS Direct Injection Turbo S/S ecoFLEX 5-door	15/17	112	11.9	51.4 (5.5)	72.4 (3.9)	62.8 (4.5)	106	£0	£20	16%
1.0i 90PS Direct Injection Turbo S/S ecoFLEX 5-door	16	112	11.9	51.4 (5.5)	74.3 (3.8)	64.2 (4.4)	104	£0	£20	15%
1.0i 115PS Direct Injection Turbo S/S ecoFLEX 3-door	16	121	10.3	47.1 (6.0)	67.3 (4.2)	57.6 (4.9)	114	£0	£30	17%
1.0i 115PS Direct Injection Turbo S/S ecoFLEX 3-door	17	121	10.3	47.1 (6.0)	65.7 (4.3)	57.6 (4.9)	115	£0	£30	18%
1.0i 115PS Direct Injection Turbo S/S ecoFLEX 5-door	16	121	10.3	47.1 (6.0)	65.7 (4.3)	57.6 (4.9)	115	£0	£30	18%
1.0i 115PS Direct Injection Turbo S/S ecoFLEX 5-door	17	121	10.3	46.3 (6.1)	65.7 (4.3)	56.5 (5.0)	117	£0	£30	18%
1.3CDTi 75PS S/S ecoFLEX	15/17	102	14.8	61.4 (4.6)	85.6 (3.3)	74.3 (3.8)	100	£0	£0	18%
1.3CDTi 75PS S/S ecoFLEX	16	102	14.8	62.8 (4.5)	85.6 (3.3)	76.3 (3.7)	99	£0	£0	17%
1.3CDTi 95PS S/S ecoFLEX 3-door	15/17	113	11.9	76.3 (3.7)	94.2 (3.0)	85.6 (3.3)	87	£0	£0	16%
1.3CDTi 95PS S/S ecoFLEX 3-door	16	113	11.9	76.3 (3.7)	94.2 (3.0)	88.3 (3.2)	85	£0	£0	16%
1.3CDTi 95PS S/S ecoFLEX 5-door	15/17	113	11.9	74.3 (3.8)	91.1 (3.1)	83.1 (3.4)	89	£0	£0	16%
1.3CDTi 95PS S/S ecoFLEX 5-door	16	113	11.9	74.3 (3.8)	94.2 (3.0)	85.6 (3.3)	87	£0	£0	16%
Easytronic										
1.4i 90PS S/S ecoFLEX Design 3-door	15	109	13.9	47.9 (5.9)	68.9 (4.1)	58.9 (4.8)	112	£0	£30	17%
1.4i 90PS S/S ecoFLEX Design 5-door	15	109	13.9	48.7 (5.8)	68.9 (4.1)	58.9 (4.8)	112	£0	£30	17%
1.4i 90PS S/S ecoFLEX Excite	16	109	13.9	48.7 (5.8)	70.6 (4.0)	60.1 (4.7)	110	£0	£20	17%
Automatic										
1.4i 90PS	15/17	106	13.9	36.2 (7.8)	57.6 (4.9)	47.1 (6.0)	140	£130	£130	23%
1.4i 90PS 3-door	16	106	13.9	36.7 (7.7)	57.6 (4.9)	47.1 (6.0)	139	£130	£130	22%
1.4i 90PS 5-door	16	106	13.9	36.7 (7.7)	57.6 (4.9)	47.9 (5.9)	139	£130	£130	22%

= Official Government Test Environmental Data. Official EU-regulated test data is provided for comparison purposes and actual performance will depend on driving style, road conditions and other non-technical factors.

* = Correct at time of publication. S/S = Start/Stop.

NEW CORSA SPECIFICATIONS

STEERING

- Rack and pinion
- Speed-sensitive electric power-assisted steering standard on all models. Variable ratio on all models except 1.2i and 1.4i manual/Easytronic
- Turning circle (kerb-to-kerb): 10.6m (34.8ft)

SUSPENSION

Front: Independent. Lightweight MacPherson struts with gas-pressure dampers and coil springs.

Anti-roll bar.

Rear: Compound crank with coil springs and gas-pressure dampers.

- Sports suspension on Sting R/Limited Edition/SRi VX-Line models, and on SE models fitted with optional 17-inch alloy wheels

BRAKES

- Anti-lock Braking System (ABS)
- Electronic brakeforce distribution
- Emergency brake assist
- Cornering brake control
- Straight line stability control
- Dual circuit, diagonally split, dual rate servo-assisted system

- Low brake fluid level warning light

1.0i 90PS Direct Injection Turbo ecoFLEX

Front ventilated discs: 284mm diameter

Rear discs: 264mm diameter

1.2i 70PS

Front ventilated discs: 257mm diameter

Rear drums: 228mm diameter

1.4i 90PS

Front ventilated discs: 257mm diameter

Rear drums: 228mm diameter

1.4i 100PS Turbo

Front ventilated discs: 284mm diameter

Rear discs: 264mm diameter

1.0i 115PS Direct Injection Turbo ecoFLEX

Front ventilated discs: 284mm diameter

Rear discs: 264mm diameter

1.3CDTi 75PS ecoFLEX

Front ventilated discs: 284mm diameter

Rear discs: 264mm diameter

1.3CDTi 95PS ecoFLEX

Front ventilated discs: 284mm diameter

Rear discs: 264mm diameter

BODY

- Aerodynamic drag co-efficient: Cd 0.33

FUEL TANK CAPACITY

- 45 litres (9.9 gallons)

WEIGHTS AND TOWING DATA kg

	Gross vehicle weight		Max. towing weights Trailer with brakes (without brakes)	
	3-door	5-door	3-door	5-door
1.2i 70PS Life/Sting/Excite	1575	1605	700 (540)	700 (540)
1.2i 70PS Limited Edition/Design/SRi/SRi VX-Line/SE	1590	1620	700 (540)	700 (540)
1.4i 90PS Life/Sting/Excite	1585	1615	800 (550)	800 (550)
1.4i 90PS Limited Edition/Design/SRi/SRi VX-Line/SE	1600	1630	800 (550)	800 (550)
1.4i 90PS Easytronic	1620	1640	800 (550)	800 (550)
1.4i 90PS auto	1630	1660	800 (550)	800 (550)
1.4i 100PS Turbo	1680	1710	1150 (580)	1150 (580)
1.0i 90PS Direct Injection Turbo	1650	1680	1200 (560)	1200 (560)
1.0i 115PS Direct Injection Turbo Sting R	1635	1665	1200 (560)	1200 (560)
1.0i 115PS Direct Injection Turbo Excite/Limited Edition/SRi VX-Line	1650	1680	1200 (560)	1200 (560)
1.3CDTi 75PS Life	1665	1695	900 (580)	900 (580)
1.3CDTi 75PS Excite/Design/SRi/SRi VX-Line/SE	1680	1710	900 (580)	900 (580)
1.3CDTi 95PS	1680	1710	1150 (580)	1150 (580)

Please note: For Life, Sting, Sting R and Excite models fitted with optional air conditioning 15kg must be added to gross vehicle weight.

Gross vehicle weight is the total permissible weight of the vehicle including passengers and their luggage. The **maximum roof rack loading** should not exceed 75kg. The **maximum towing weights** are based on the ability of the car, with two occupants of 75kg each, to restart on a 12% gradient, which is approximately 1 in 8.3, at sea level. At altitudes above 1500 metres, the engine output may drop with a corresponding reduction in towing capability. Any extra weight, such as luggage or additional passengers, should be deducted from the maximum towing weight. With a trailer fully loaded, **maximum noseweight** should not exceed 55kg. Always fit Vauxhall towing attachments and accessories available from your Vauxhall retailer. They are designed specifically for Vauxhall models and carry a 12-month guarantee.

NEW CORSA SPECIFICATIONS

EXTERIOR DIMENSIONS millimetres (inches)

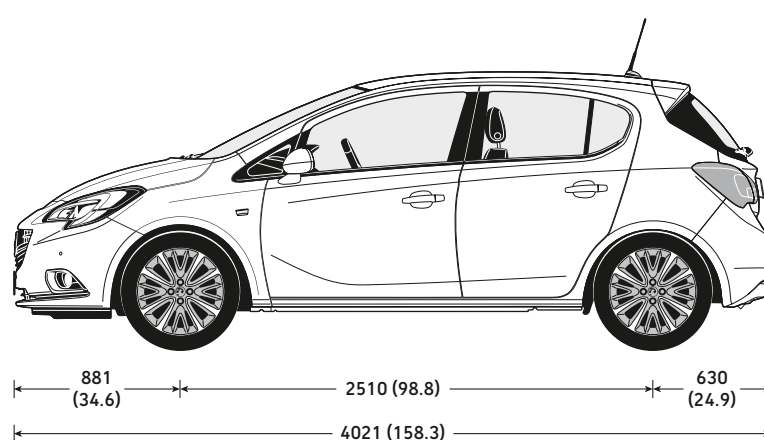
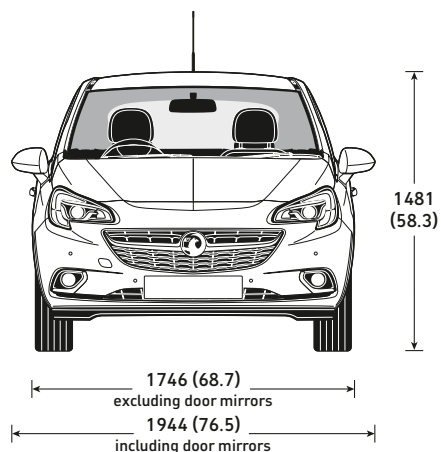
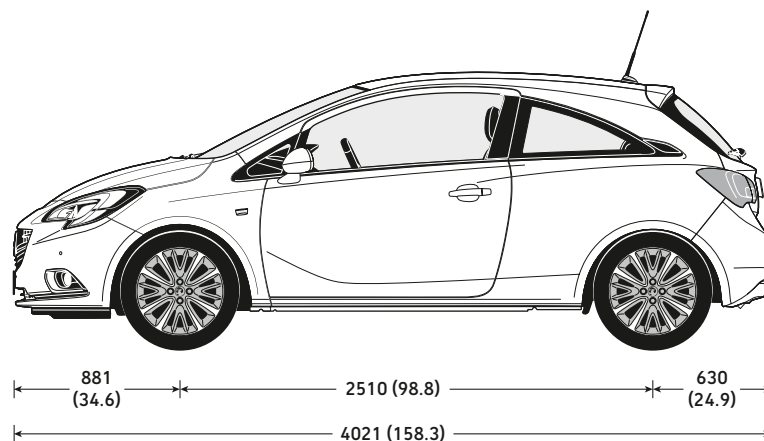
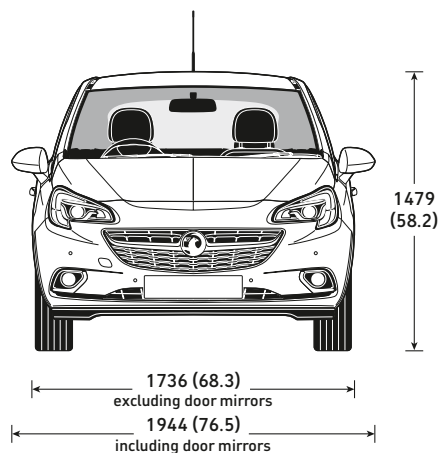

LOADSPACE DIMENSIONS millimetres (inches)

3-door

Maximum length (seats up)	705 (27.8)
Maximum length*	1372 (54.0)
Maximum width	944 (37.2)
Maximum height	843 (33.2)

5-door

Maximum length (seats up)	705 (27.8)
Maximum length*	1372 (54.0)
Maximum width	944 (37.2)
Maximum height	876 (34.5)

* = Behind front seats.

LUGGAGE CAPACITIES** litres (cu.ft.)

3-door

Rear seat up	280 (9.9)
Rear seat down (to glassline)	750 (26.5)
Rear seat down (to roof)	1090 (38.5)

5-door

Rear seat up	285 (10.0)
Rear seat down (to glassline)	710 (25.1)
Rear seat down (to roof)	1120 (39.5)

** = ECIE method.

FLEX-FIX® KEY

DIMENSIONS millimetres (inches)

Maximum circumference around rim and tyre of bicycle	225 (8.9)
Maximum crank arm width	52 (2.0)
Maximum crank arm depth	25 (1.0)
Maximum crank arm length	no limit

NEW CORSA ACCESSORIES

	Total (inc. VAT)
INFOTAINMENT	
Jabra Bluetooth kits®	
Jabra Drive in-car speakerphone	£49.00
Jabra Tour in-car speakerphone	£79.00
Jabra Freeway in-car speakerphone	£89.00
FlexConnect Range	
FlexConnect bracket	£19.00
FlexConnect table	£60.00
FlexConnect coat hanger	£47.00
FlexConnect iPad cradle (1-4)	£93.00
FlexConnect iPad mini cradle	£84.00
FlexConnect hook	£23.00
FlexConnect Samsung Galaxy cradle	£83.00
FlexConnect iPad Air cradle	£92.00
Bury Bluetooth® phone kits	
Classic – Fully integrated, phone charging function, illuminated controls	£129.00
TomTom Portable Sat Navs	
TomTom Start 20	£109.00
TomTom Start 50	£139.00
TomTom GO 50	£159.00
TomTom GO 5000	£269.00
Digital radio	
Fully integrated digital radio	£195.00
Sat Nav updates¹	
Please consult your retailer for latest map updates or visit www.vauxhall.co.uk/accessories .	

1 = For use with optional factory-fit satellite navigation systems.

	Total (inc. VAT)
CHILD SEATS²	
BABY-SAFE ³ – 0-13kg/birth to 15 months	£119.00
– ISOFIX base	£208.00
DUO ISOFIX ³ – 9-18kg/9 months to 4 years	
with top tether kit	£316.00
KID ³ – 15-36kg or 4 to 12 years	£143.00
2 = Restrictions apply to the use of child seats, please consult your Vauxhall retailer.	
3 = Without transponder.	
SAFETY	
Privacy shades – rear side windows (3-dr)	£53.00
Privacy shades – tailgate window (3-dr)	£66.00
Privacy shades – rear side windows (5-dr)	£68.00
Privacy shades – tailgate window (5-dr)	£68.00
Parking sensors	
– four fully flush front bumper mounted sensors	
– unpainted	£320.00
– painted	£350.00
– four fully flush rear bumper mounted sensors	
– unpainted	£300.00
– painted	£330.00
Safety Pack – first aid kit, warning triangle, hi-visibility vest, Vauxhall bag	
First aid kit	£32.00
Warning triangle	£13.00
Hi-visibility vest	£16.00
Hi-visibility vest	£8.00
Fire extinguisher – 2kg	£33.00
Temporary tyre inflation kit	£130.00
Tyre sealant	£48.00

	Total (inc. VAT)
SECURITY	
Locking wheel bolts – set of four	£37.00
Steering wheel security bar	£79.00
PRACTICAL	
Spare bulb kit	£17.00
Jump leads	
– petrol engines (16mm standard)	£42.00
– petrol/diesel engines (25mm heavy duty)	£76.00
Fuel can – 5-litre	£20.00
Fuel can – 10-litre	£24.00
Stretch tow rope – 2 tonne	£31.00
PROTECTION	
Economy floor mats – set of four	£37.00
Rubber floor mats – front pair	£44.00
Rubber floor mats – rear pair	£41.00
Velour floor mats – set of four	£55.00
Front passenger seat back storage net	£34.00
Anti-slip mat – 915mm x 915mm	£22.00
Cargo liner	£68.00
Mudflaps – front and rear set ⁴	£114.00
4 = Not available with certain exterior styling accessories.	

	Total (inc. VAT)
TOURING	
Base carrier – all models	£124.00
Thule aluminium bicycle carrier ⁵	£103.00
Thule ski carrier ⁵	from £126.00
Thule extendable ski carrier ⁵	£216.00
Thule aluminium surfboard carrier ⁵	£92.00
Thule roof boxes ⁵	
– Ocean 80 hard roof box (340 litres)	£215.00
– Pacific 200 hard roof box (460 litres)	from £320.00
– Ranger 90 soft roof box (340 litres)	£260.00
Two-bicycle tow bar carrier with rear lights – requires rear number plate	
Removable Tow Bar with 13-pin Electrics	£344.00
Removable Tow Bar with 7-pin Adaptor	£660.00
Removable Tow Bar with 12S Electrics	£674.00
Removable Tow Bar with 12S Electrics	£736.00
5 = Must be used in conjunction with a base carrier.	
ALLOY WHEELS (set of four with centre caps)⁶	
17-inch 5-twin-spoke – silver	£914.00
16-inch 4-double-spoke – black	£784.00
16-inch 6-double-spoke – silver	£787.00
15-inch 8-spoke – silver	£657.00
16-inch 4-double-spoke – white	£787.00
17-inch 8-spoke – Titan gloss	£886.00
6 = Fitting time is based on four wheels fitted and includes static wheel balancing. Different tyres and locking wheel nuts may be required. Price excludes new tyres and locking wheel nuts.	

Please note:

Prices shown are a fully fitted and painted, where applicable and include VAT. Please check with your local Vauxhall retailer for details. It is advisable to ensure your insurance policy is adequate to cover additional fitted accessories. Prices correct at time of publication.

NEW CORSA ADDITIONAL INFORMATION

ON-THE-ROAD PRICES

To eliminate uncertainty about hidden costs when buying a new car, Vauxhall publishes on-the-road recommended retail prices (RRP) and these are shown in the pricing tables within this price guide. These prices include the recommended cost of number plates and delivery to a Vauxhall retailer of £700.00 (including £116.67 VAT), 12 months' Government Vehicle Excise Duty (see opposite for details) and the DVLA new vehicle first registration fee of £55.00*.

Please note: The on-the-road recommended retail price (RRP) does not include fuel supplied by the retailer, motor insurance or any other goods or services supplied by agreement between the retailer and the customer.

PRICE PROTECTION

Order a new Vauxhall for build in the current model year (as confirmed by your retailer) for delivery no more than three months in advance and the price you are quoted is the price you pay. This is irrespective of any subsequent price rises between placing your order and delivery of your new car, but you must take delivery as soon as the car is available. General Motors UK Limited is not liable for price adjustments caused by Government changes in the rate of VAT (currently 20%), Vehicle Excise Duty, DVLA new vehicle first registration fee or by any other applicable legislation or regulations.

VEHICLE EXCISE DUTY

The amount of Vehicle Excise Duty (road fund licence) payable on new cars varies depending on the level of carbon dioxide (CO₂) emissions produced by the vehicle. CO₂ emissions are measured in grammes (g) per kilometre (km) travelled and divided into 13 charging bands shown in the table below.

From 1 April 2010 the Government introduced a new 'first year rate' of Vehicle Excise Duty payable on all new cars. In subsequent years the amount of Vehicle Excise Duty payable will revert to the standard rate.

Vehicle Excise Duty*

	CO ₂ emissions (g/km)	First year rate	Standard rate
Band A	up to 100	£0.00	£0.00
Band B	101-110	£0.00	£20.00
Band C	111-120	£0.00	£30.00
Band D	121-130	£0.00	£110.00
Band E	131-140	£130.00	£130.00
Band F	141-150	£145.00	£145.00
Band G	151-165	£180.00	£180.00
Band H	166-175	£295.00	£205.00
Band I	176-185	£350.00	£225.00
Band J	186-200	£490.00	£265.00
Band K	201-225	£640.00	£290.00
Band L	226-255	£870.00	£490.00
Band M	over 255	£1100.00	£505.00

* = Correct at time of issue.

E10 FUEL

E10 fuel is cleared for use in all petrol-engined Vauxhall vehicles excluding models with the 2.2 litre direct injection petrol engine (code Z22YH) used in Vectra, Signum and Zafira models. Owners of these vehicles should continue to use regular unleaded or premium unleaded petrol.

PROTECTING THE ENVIRONMENT

Vauxhall's commitment to the environment is demonstrated by our products' many environmental awards. For even more information on Vauxhall's efforts to achieve an environmentally sustainable future, see www.vauxhall.co.uk/recycling

VAUXHALL ASSISTANCE

Vauxhall Assistance is provided automatically with every new Vauxhall for 12 months from first registration and covers everything from accident assistance, roadside recovery and 'at home' service to flat tyres. With Vauxhall Assistance help is literally just a free** phone call away, 24 hours a day, 365 days a year!

** = Mobile phone users will be charged at their standard tariff.

VAUXHALL LEASING

As Vauxhall's own contract hire and fleet management operation, Vauxhall Leasing provides a one-stop-shop for competitive car and van leasing solutions – for business users and private individuals. Working with the Vauxhall retailer network, we combine the support of a national contract with the convenience of a local contact.

For further information, please see your local Vauxhall retailer or call us on **0870 737 2557**. Alternatively, you can visit our website at www.vauxhall-leasing.co.uk

IN THE EVENT OF AN ACCIDENT...

Vauxhall Accident Support helps keep you mobile following an accident. Benefits include scene-of-accident advice, message service, assistance with claims and vehicle recovery. For further details call **0800 010 304**.

Alternatively, details can be found on our website at www.vauxhall.co.uk

VAUXHALL SERVICE PLAN

Vauxhall retailers offer a great service for owners of all Vauxhall cars. Value for money, regular offers and free check-ups, combined with the peace of mind that comes from using Vauxhall-trained technicians and genuine parts, help keep your car in peak condition at all times.

FOR MORE PRODUCT INFORMATION

For a brochure on any Vauxhall model (up to a maximum of three per caller) or location of your nearest Vauxhall retailer please call **0345 600 1500**. Alternatively, details can be found on our website at www.vauxhall.co.uk

VAUXHALL INSURANCE WITH ADDED REASSURANCE

Comprehensive cover – Summary of benefits*

- Competitive premiums
- Repairs by a Vauxhall-trained technician
- Genuine Vauxhall parts, guaranteed for three years when we repair your car within our Approved Repairer Network
- Free courtesy car as standard when using an Approved Repairer**
- 24 hour claims helpline
- Personal Accident benefit
- Cover for audio equipment
- Windscreen cover

Call for a quote on **0844 463 2670†**

*The benefits listed above are for comprehensive cover only. For details of Third Party, Fire and Theft cover, please call our sales team.
**Should your car need repairing following an accident we provide a courtesy car (subject to availability) for the duration of the repair. Only genuine Vauxhall parts are used. Terms and conditions apply.
†Calls may be recorded. Vauxhall Motor Insurance is underwritten by Ageas Insurance Limited.

Every effort has been made to ensure that the contents of this document were accurate and up-to-date at the time of publication – 2 July 2015. The invoice price, including delivery to retailer, factory-fitted options, accessories fitted by the retailer and number plates, is subject to VAT. The right is reserved to alter specifications and prices, and withdraw products from sale, without notice. Please note that Vauxhall retailers are not the agents of General Motors UK Limited t/a Vauxhall and are not authorised to bind General Motors UK Limited by any specific or implied undertaking or representation. It is advisable to ensure that your motor insurance policy provides adequate cover for additional fitted options and accessories. All rights reserved. No part of this publication may be reproduced in any form or by any means, without the prior written permission of General Motors UK Limited.

Base information prepared by Graymatter. General Motors UK Limited, Luton LU1 3YT www.vauxhall.co.uk

©2015 General Motors UK Limited



VAUXHALL