



CORSA

Price and Specification Guide | 24 October 2018 | Model Year 2019



VAUXHALL
British Brand since 1903



CONTENTS

RANGE HIGHLIGHTS

Explore the Corsa range and find your perfect model.

MODELS

Find all the information you need about your chosen model.

PRICES

Find on-the-road recommended retail prices.

FEATURES/OPTIONS

Tailor your chosen model to suit your needs with everything from a satellite navigation to rear-view camera and parking sensors.

EXTERIOR COLOURS

Add some sparkle to your car with a metallic paint.

WHEELS AND TYRES

Why not upgrade to a set of distinctive alloy wheels to give your car more presence.

PERFORMANCE, FUEL ECONOMY AND EMISSIONS

Know how many miles you will get around town, the CO₂ figures and the 0–60 time.

DIMENSIONS

Ensure your car will fit in the garage and know how much luggage you can take for a long weekend away.

SPECIFICATIONS

Towing weights, engine details and other useful details you may need to know.

ACCESSORIES

Add some practical touches to your car with our range of quality accessories.

COMPANY CAR INFORMATION

Benefit in Kind company car tax, 3 day test drives and P11D.

FURTHER INFORMATION

Insurance groups, vehicle excise duty, our range of additional products and much more.



CORSA RANGE HIGHLIGHTS



STANDARD FEATURES

Standard features include:

Infotainment:

- Six speakers

Interior convenience / styling:

- Cruise control
- Speed-sensitive power-assisted steering
- Steering column adjustable for reach / rake
- Steering wheel audio / phone / cruise controls
- Driver's seat height adjuster

Exterior convenience / styling:

- Heated windscreen
- Remote control central locking
- Electrically operated front windows
- Electrically adjustable door mirrors
- Black B-pillars (with certain exterior colours)

Safety / security features:

- Electronic Stability Programme (ESP)
- Anti-lock Braking System (ABS)
- Six airbags
- Hill start assist
- Seatbelt reminders for all seats
- ISOFIX child seat mounting points on outer rear seats
- Tyre pressure monitoring system
- Daytime running lights
- Engine deadlock immobiliser

ACTIVE

OTR from £11,290

Additional over standard features:

Infotainment:

- CD 30 BT audio system
 - AM/FM radio
 - CD/MP3 CD player
 - Bluetooth® mobile phone portal
 - USB audio connection
 - Aux-in socket

Interior convenience / styling:

- Leather-covered steering wheel

Exterior convenience / styling:

- 15-inch silver 8-spoke alloy wheels

DESIGN

OTR from £13,015

Additional over standard features:

Infotainment:

- IntelliLink audio system
 - 7-inch colour touchscreen
 - AM/FM/DAB digital radio
 - Bluetooth® audio streaming
 - Bluetooth® mobile phone portal
 - Apple CarPlay™ / Android Auto™
 - USB audio connection

Interior convenience / styling:

- Air conditioning
- Leather-covered steering wheel

Exterior convenience / styling:

- Front fog lights
- 15-inch structure steel wheels with styled wheel covers

Safety / security features:

- LED daytime running lights

ENERGY

OTR from £14,380

Additional over standard features:

Infotainment:

- IntelliLink audio system
 - 7-inch colour touchscreen
 - AM/FM/DAB digital radio
 - Bluetooth® audio streaming
 - Bluetooth® mobile phone portal
 - Apple CarPlay™ / Android Auto™
 - USB audio connection

Interior convenience / styling:

- Air conditioning
- Heated leather-covered steering wheel
- Heated front seats

Exterior convenience / styling:

- Electrically adjustable / heated door mirrors
- Automatic lighting control
- Rain-sensitive windscreen wipers
- Front fog lights
- 16-inch silver 4-twinspoke alloy wheels

Safety / security features:

- LED daytime running lights



CORSA RANGE HIGHLIGHTS



STANDARD FEATURES

Standard features include:

Infotainment:

- Six speakers

Interior convenience / styling:

- Cruise control
- Speed-sensitive power-assisted steering
- Steering column adjustable for reach / rake
- Steering wheel audio / phone / cruise controls
- Driver's seat height adjuster

Exterior convenience / styling:

- Heated windscreen
- Remote control central locking
- Electrically operated front windows
- Electrically adjustable door mirrors
- Black B-pillars (with certain exterior colours)

Safety / security features:

- Electronic Stability Programme (ESP)
- Anti-lock Braking System (ABS)
- Six airbags
- Hill start assist
- Seatbelt reminders for all seats
- ISOFIX child seat mounting points on outer rear seats
- Tyre pressure monitoring system
- Daytime running lights
- Engine deadlock immobiliser

GRIFFIN

OTR from £11,695

Additional over standard features:

Infotainment:

- Navi 4.0 IntelliLink satellite navigation system
 - Fully integrated European satellite navigation system
 - 7-inch colour touchscreen
 - AM/FM/DAB digital radio
 - Bluetooth® audio streaming
 - Bluetooth® mobile phone portal
 - Apple CarPlay™ / Android Auto™
 - USB audio connection

Interior convenience / styling:

- Air conditioning
- Auto anti-dazzle rear-view mirror
- Sports-style heated front seats
- Leather-covered heated steering wheel
- Front and rear floor mats (front Griffin-branded)

Exterior convenience / styling:

- Roof / door mirrors / front grille bar in black
- Auto lighting / windscreen wipers
- 16-inch black 4-twinspoke alloy wheels
- Dark-tinted rear windows
- Front fog lights
- Electrically adjustable / heated door mirrors

Safety / security features:

- LED daytime running lights

SPORT

OTR from £15,355

Additional over standard features:

Infotainment:

- IntelliLink audio system
 - 7-inch colour touchscreen
 - AM/FM/DAB digital radio
 - Bluetooth® audio streaming
 - Bluetooth® mobile phone portal
 - Apple CarPlay™ / Android Auto™
 - USB audio connection

Interior convenience / styling:

- Air conditioning
- Leather-covered steering wheel
- Sports-style front seats
- Alloy-effect sports pedals

Exterior convenience / styling:

- Electrically adjustable / heated door mirrors
- Dark-tinted rear windows
- 16-inch silver 4-twinspoke alloy wheels

Safety / security features:

- LED daytime running lights

SRi NAV

OTR from £16,355

Additional over standard features:

Infotainment:

- Navi 4.0 IntelliLink satellite navigation system
 - Fully integrated European satellite navigation system
 - 7-inch colour touchscreen
 - AM/FM/DAB digital radio
 - Bluetooth® audio streaming
 - Bluetooth® mobile phone portal
 - Apple CarPlay™ / Android Auto™
 - USB audio connection

Interior convenience / styling:

- Air conditioning
- Leather-covered steering wheel
- Sports-style front seats

Exterior convenience / styling:

- Rain-sensitive windscreen wipers
- Automatic lighting control
- Electrically adjustable / heated door mirrors
- Front fog lights with chrome-effect surround
- 16-inch black 4-twinspoke alloy wheels (3-door)
 - no-cost option on 5-door models
- 16-inch silver 4-twinspoke alloy wheels (5-door)
 - no-cost option on 3-door models

Safety / security features:

- LED daytime running lights



CORSA RANGE HIGHLIGHTS



STANDARD FEATURES

Standard features include:

Infotainment:

- Six speakers

Interior convenience / styling:

- Cruise control
- Speed-sensitive power-assisted steering
- Steering column adjustable for reach / rake
- Steering wheel audio / phone / cruise controls
- Driver's seat height adjuster

Exterior convenience / styling:

- Heated windscreen
- Remote control central locking
- Electrically operated front windows
- Electrically adjustable door mirrors
- Black B-pillars (with certain exterior colours)

Safety / security features:

- Electronic Stability Programme (ESP)
- Anti-lock Braking System (ABS)
- Six airbags
- Hill start assist
- Seatbelt reminders for all seats
- ISOFIX child seat mounting points on outer rear seats
- Tyre pressure monitoring system
- Daytime running lights
- Engine deadlock immobiliser

SE NAV

OTR from £15,425

Additional over standard features:

Infotainment:

- Navi 4.0 IntelliLink satellite navigation system
 - Fully integrated European satellite navigation system
 - 7-inch colour touchscreen
 - AM/FM/DAB digital radio
 - Bluetooth® audio streaming
 - Bluetooth® mobile phone portal
 - Apple CarPlay™ / Android Auto™
 - USB audio connection

Interior convenience / styling:

- Air conditioning
- Auto anti-dazzle rear-view mirror
- Multi-function trip computer
- Heated leather-covered steering wheel
- Heated front seats
- Graphic Embossed cloth/premium leather-effect trim
- 60/40 split-folding rear seat back

Exterior convenience / styling:

- Auto lighting / windscreen wipers
- Electrically adjustable / heated door mirrors
- Front / rear parking sensors
- Front fog lights with chrome-effect surround
- Chrome-effect lower side window mouldings (5-door only)
- 16-inch multi-spoke alloy wheels

SRi VX-LINE Nav Black

OTR from £17,045

Additional over standard features:

Infotainment:

- Navi 4.0 IntelliLink satellite navigation system
 - Fully integrated European satellite navigation system
 - 7-inch colour touchscreen
 - AM/FM/DAB digital radio
 - Bluetooth® audio streaming
 - Bluetooth® mobile phone portal
 - Apple CarPlay™ / Android Auto™
 - USB audio connection

Interior convenience / styling:

- Air conditioning
- Auto anti-dazzle rear-view mirror
- Sports-style front seats
- VX-Line styling: Leather-covered flat-bottom steering wheel / gear knob / handbrake lever

Exterior convenience / styling:

- Auto lighting / windscreen wipers
- VX-Line body styling: Front lower spoiler / side sills / rear skirt / VXR rear roof spoiler (3-door only)
- Roof / door mirrors / front grille bar in black
- Dark-tinted rear windows
- Sports suspension
- Front fog lights
- 17-inch black alloy wheels

GSi

OTR from £18,995

Additional over standard features:

Infotainment:

- IntelliLink audio system
 - 7-inch colour touchscreen
 - AM/FM/DAB digital radio
 - Bluetooth® audio streaming
 - Bluetooth® mobile phone portal
 - Apple CarPlay™ / Android Auto™
 - USB audio connection

Interior convenience / styling:

- Air conditioning
- Sports-style front seats
- GSi styling: Leather-covered flat-bottom steering wheel / gear knob / handbrake lever

Exterior convenience / styling:

- GSi body styling: Front lower spoiler / side sills / rear skirt / rear roof spoiler
- Carbon-effect door mirrors / front grille bar
- Dark-tinted rear windows
- Sports suspension
- 17-inch 5-spoke bi-colour alloy wheels



ACTIVE



ACTIVE ON-THE-ROAD PRICES

		3-door hatchback	
		OTR RRP	CO ₂ (g/km)
Petrol	1.4i (75PS)	£11,290	131

Please note: On-the-road recommended retail prices (RRP) include VAT at 20%, number plates and delivery to Retailer of £700.00 (inc. £116.67 VAT), 12 months' Vehicle Excise Duty and new vehicle first registration fee of £55.00. Excludes fuel and insurance.

FEATURES

Infotainment:

- CD 30 BT audio system
 - AM/FM radio
 - CD/MP3 CD player
 - Bluetooth® mobile phone portal
 - USB audio connection
 - Aux-in socket
- Six speakers

Interior convenience / styling:

- Cruise control
- Leather-covered steering wheel
- Speed-sensitive power-assisted steering
- Steering column adjustable for reach / rake
- Steering wheel audio / phone / cruise controls
- Driver's seat height adjuster

Exterior convenience / styling:

- Heated windscreen
- Remote control central locking
- Electrically operated front windows
- Electrically adjustable door mirrors
- Black B-pillars (with certain exterior colours)
- 15-inch silver 8-spoke alloy wheels

Safety / security features:

- Electronic Stability Programme (ESP)
- Anti-lock Braking System (ABS)
- Six airbags
- Hill start assist
- Seatbelt reminders for all seats
- ISOFIX child seat fixings on outer rear seats
- Tyre pressure monitoring system
- Daytime running lights
- Engine deadlock immobiliser



DESIGN



DESIGN ON-THE-ROAD PRICES

		3-door hatchback		5-door hatchback	
		OTR RRP	CO ₂ (g/km)	OTR RRP	CO ₂ (g/km)
Petrol	1.4i (75PS)	£13,015	131	£13,575	130
	1.4i (90PS)	-	-	£13,820	130
	1.4i (90PS) automatic	-	-	£15,225	150

Please note: On-the-road recommended retail prices (RRP) include VAT at 20%, number plates and delivery to Retailer of £700.00 (inc. £116.67 VAT), 12 months' Vehicle Excise Duty and new vehicle first registration fee of £55.00. Excludes fuel and insurance.

FEATURES

Infotainment:

- IntelliLink audio system
 - 7-inch colour touchscreen
 - AM/FM/DAB digital radio
 - Bluetooth® audio streaming
 - Bluetooth® mobile phone portal
 - Apple CarPlay™ / Android Auto™
 - USB audio connection
- Six speakers

Interior convenience / styling:

- Air conditioning
- Cruise control
- Leather-covered steering wheel
- Speed-sensitive power-assisted steering
- Steering column adjustable for reach / rake
- Steering wheel audio / phone / cruise controls
- Driver's seat height adjuster

Exterior convenience / styling:

- Heated windscreen
- Remote control central locking
- Electrically operated front windows
- Electrically adjustable door mirrors
- Front fog lights
- Black B-pillars (with certain exterior colours)
- 15-inch structure steel wheels with styled wheel covers

Safety / security features:

- Electronic Stability Programme (ESP)
- Anti-lock Braking System (ABS)
- Six airbags
- Hill start assist
- Seatbelt reminders for all seats
- ISOFIX child seat fixings on outer rear seats
- Tyre pressure monitoring system
- LED daytime running lights
- Engine deadlock immobiliser



ENERGY



ENERGY ON-THE-ROAD PRICES

		3-door hatchback		5-door hatchback	
		OTR RRP	CO ₂ (g/km)	OTR RRP	CO ₂ (g/km)
Petrol	1.4i (75PS)	£14,380	131	£14,940	130
	1.4i (90PS)	£14,625	131	£15,185	130
	1.4i (90PS) automatic	£15,990	142	£16,590	150
	1.4i Turbo (100PS) S/S	-	-	£15,840	128

Please note: On-the-road recommended retail prices (RRP) include VAT at 20%, number plates and delivery to Retailer of £700.00 (inc. £116.67 VAT), 12 months' Vehicle Excise Duty and new vehicle first registration fee of £55.00. Excludes fuel and insurance.

S/S = Start/Stop.

FEATURES

Infotainment:

- IntelliLink audio system
 - 7-inch colour touchscreen
 - AM/FM/DAB digital radio
 - Bluetooth® audio streaming
 - Bluetooth® mobile phone portal
 - Apple CarPlay™ / Android Auto™
 - USB audio connection
- Six speakers

Interior convenience / styling:

- Air conditioning
- Heated leather-covered steering wheel
- Heated front seats
- Cruise control
- Speed-sensitive power-assisted steering
- Steering column adjustable for reach / rake
- Steering wheel audio / phone / cruise controls
- Driver's seat height adjuster

Exterior convenience / styling:

- Heated windscreen
- Remote control central locking
- Electrically operated front windows
- Electrically adjustable / heated door mirrors
- Automatic lighting control
- Rain-sensitive windscreen wipers
- Front fog lights
- Black B-pillars (with certain exterior colours)
- 16-inch silver 4-twinspoke alloy wheels

Safety / security features:

- Electronic Stability Programme (ESP)
- Anti-lock Braking System (ABS)
- Six airbags
- Hill start assist
- Seatbelt reminders for all seats
- ISOFIX child seat fixings on outer rear seats
- Tyre pressure monitoring system
- LED daytime running lights
- Engine deadlock immobiliser



GRIFFIN



GRIFFIN ON-THE-ROAD PRICES

		3-door hatchback		5-door hatchback	
		OTR RRP	CO ₂ (g/km)	OTR RRP	CO ₂ (g/km)
Petrol	1.4i (75PS)	£11,695	131	£12,255	130
	1.4i (90PS)	£11,940	131	£12,500	130

Please note: On-the-road recommended retail prices (RRP) include VAT at 20%, number plates and delivery to Retailer of £700.00 (inc. £116.67 VAT), 12 months' Vehicle Excise Duty and new vehicle first registration fee of £55.00. Excludes fuel and insurance.

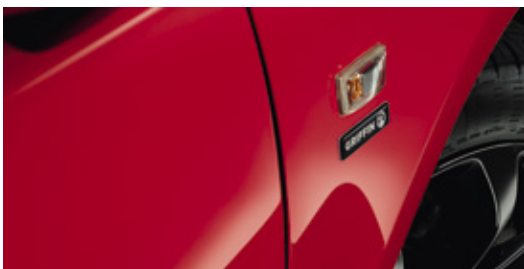

FEATURES

Infotainment:

- Navi 4.0 IntelliLink satellite navigation system
 - Fully integrated European satellite navigation system
 - 7-inch colour touchscreen
 - AM/FM/DAB digital radio
 - Bluetooth® audio streaming
 - Bluetooth® mobile phone portal
 - Apple CarPlay™ / Android Auto™
 - USB audio connection
- Six speakers

Interior convenience / styling:

- Air conditioning
- Sports-style heated front seats
- Leather-covered heated steering wheel
- Multi-function trip computer
- Cruise control
- Speed-sensitive power-assisted steering
- Steering column adjustable for reach / rake
- Steering wheel audio / phone / cruise controls
- Driver's seat height adjuster
- Front and rear floor mats (front Griffin-branded)

Exterior convenience / styling:

- Automatic lighting control
- Rain-sensitive windscreen wipers
- Roof / door mirrors / front grille bar in black
- Heated windscreen
- Remote control central locking
- Electrically operated front windows
- Electrically adjustable / heated door mirrors
- Dark-tinted rear windows
- Front fog lights
- 16-inch black alloy wheels

Safety / security features:

- Electronic Stability Programme (ESP)
- Anti-lock Braking System (ABS)
- Six airbags
- Hill start assist
- Seatbelt reminders for all seats
- ISOFIX child seat fixings on outer rear seats
- Tyre pressure monitoring system
- LED daytime running lights



SPORT



SPORT ON-THE-ROAD PRICES

		3-door hatchback		5-door hatchback	
		OTR RRP	CO ₂ (g/km)	OTR RRP	CO ₂ (g/km)
Petrol	1.4i (75PS)	£15,355	131	£15,915	130
	1.4i (90PS)	£15,600	131	£16,160	130

Please note: On-the-road recommended retail prices (RRP) include VAT at 20%, number plates and delivery to Retailer of £700.00 (inc. £116.67 VAT), 12 months' Vehicle Excise Duty and new vehicle first registration fee of £55.00. Excludes fuel and insurance.

FEATURES

Infotainment:

- IntelliLink audio system
 - 7-inch colour touchscreen
 - AM/FM/DAB digital radio
 - Bluetooth® audio streaming
 - Bluetooth® mobile phone portal
 - Apple CarPlay™ / Android Auto™
 - USB audio connection
- Six speakers

Interior convenience / styling:

- Air conditioning
- Leather-covered steering wheel
- Cruise control
- Steering column adjustable for reach / rake
- Steering wheel audio / phone / cruise controls
- Sports-style front seats
- Alloy-effect sports pedals
- Driver's seat height adjuster

Exterior convenience / styling:

- Heated windscreen
- Electrically adjustable / heated door mirrors
- Black B-pillars (with certain exterior colours)
- Dark-tinted rear windows
- 16-inch silver 4-twinspoke alloy wheels

Safety / security features:

- Electronic Stability Programme (ESP)
- Anti-lock Braking System (ABS)
- Six airbags
- Hill start assist
- ISOFIX child seat fixings on outer rear seats
- Tyre pressure monitoring system
- LED daytime running lights
- Engine deadlock immobiliser



SRI NAV



SRI NAV ON-THE-ROAD PRICES

		3-door hatchback		5-door hatchback	
		OTR RRP	CO ₂ (g/km)	OTR RRP	CO ₂ (g/km)
Petrol	1.4i (75PS)	£16,355	131	£16,915	130
	1.4i (90PS)	£16,600	131	£17,160	130
	1.4i (90PS) automatic	-	-	£18,565	150
	1.4i Turbo (100PS) S/S	£17,215	128	£17,815	128

Please note: On-the-road recommended retail prices (RRP) include VAT at 20%, number plates and delivery to Retailer of £700.00 (inc. £116.67 VAT), 12 months' Vehicle Excise Duty and new vehicle first registration fee of £55.00. Excludes fuel and insurance.

S/S = Start/Stop.

FEATURES

Infotainment:

- Navi 4.0 IntelliLink satellite navigation system
 - Fully integrated European satellite navigation system
 - 7-inch colour touchscreen
 - AM/FM/DAB digital radio
 - Bluetooth® audio streaming
 - Bluetooth® mobile phone portal
 - Apple CarPlay™ / Android Auto™
 - USB audio connection
- Six speakers

Interior convenience / styling:

- Air conditioning
- Leather-covered steering wheel
- Cruise control
- Steering column adjustable for reach / rake
- Steering wheel audio / phone / cruise controls
- Sports-style front seats
- Driver's seat height adjuster

Exterior convenience / styling:

- Heated windscreen
- Rain-sensitive windscreen wipers
- Automatic lighting control
- Electrically adjustable / heated door mirrors
- Front fog lights with chrome-effect surround
- Black B-pillars (with certain exterior colours)
- 16-inch black 4-twinspoke alloy wheels (3-door)
 - no-cost option on 5-door models
- 16-inch silver 4-twinspoke alloy wheels (5-door)
 - no-cost option on 3-door models

Safety / security features:

- Electronic Stability Programme (ESP)
- Anti-lock Braking System (ABS)
- Six airbags
- Hill start assist
- ISOFIX child seat fixings on outer rear seats
- Tyre pressure monitoring system
- LED daytime running lights
- Engine deadlock immobiliser



SE NAV



SE NAV ON-THE-ROAD PRICES

		3-door hatchback		5-door hatchback	
		OTR RRP	CO ₂ (g/km)	OTR RRP	CO ₂ (g/km)
Petrol	1.4i (75PS)	-	-	£15,740	130
	1.4i (90PS)	£15,425	131	£15,985	130
	1.4i (90PS) automatic	£16,790	142	£17,390	150
	1.4i Turbo (100PS) S/S	-	-	£16,640	128

Please note: On-the-road recommended retail prices (RRP) include VAT at 20%, number plates and delivery to Retailer of £700.00 (inc. £116.67 VAT), 12 months' Vehicle Excise Duty and new vehicle first registration fee of £55.00. Excludes fuel and insurance.

S/S = Start/Stop.

FEATURES

Infotainment:

- Navi 4.0 IntelliLink satellite navigation system
 - Fully integrated European satellite navigation system
 - 7-inch colour touchscreen
 - AM/FM/DAB digital radio
 - Bluetooth® audio streaming
 - Bluetooth® mobile phone portal
 - Apple CarPlay™ / Android Auto™
 - USB audio connection
- Six speakers

Interior convenience / styling:

- Air conditioning
- Auto anti-dazzle rear-view mirror
- Multi-function trip computer
- Heated leather-covered steering wheel
- Heated front seats
- Graphic Embossed cloth/premium leather-effect trim
- 60/40 split-folding rear seat back
- Cruise control
- Speed-sensitive power-assisted steering
- Steering column adjustable for reach / rake
- Steering wheel audio / phone / cruise controls
- Driver's seat height adjuster

Exterior convenience / styling:

- Heated windscreen
- Remote control central locking
- Electrically operated front windows
- Auto lighting / windscreen wipers
- Electrically adjustable / heated door mirrors
- Body-colour exterior door handles
- Front / rear parking sensors
- Front fog lights with chrome-effect surround
- Chrome-effect lower side window mouldings (5-door only)
- 16-inch multi-spoke alloy wheels

Safety / security features:

- Electronic Stability Programme (ESP)
- Anti-lock Braking System (ABS)
- Six airbags
- Hill start assist
- Seatbelt reminders for all seats
- ISOFIX child seat fixings on outer rear seats
- Tyre pressure monitoring system
- LED daytime running lights
- Engine deadlock immobiliser



SRI VX-LINE NAV BLACK



SRI VX-LINE NAV BLACK ON-THE-ROAD PRICES

		3-door hatchback		5-door hatchback	
		OTR RRP	CO ₂ (g/km)	OTR RRP	CO ₂ (g/km)
Petrol	1.4i (75PS)	£17,045	131	£17,605	130
	1.4i (90PS)	£17,290	131	£17,850	130

Please note: On-the-road recommended retail prices (RRP) include VAT at 20%, number plates and delivery to Retailer of £700.00 (inc. £116.67 VAT), 12 months' Vehicle Excise Duty and new vehicle first registration fee of £55.00. Excludes fuel and insurance.

FEATURES

Infotainment:

- Navi 4.0 IntelliLink satellite navigation system
 - Fully integrated European satellite navigation system
 - 7-inch colour touchscreen
 - AM/FM/DAB digital radio
 - Bluetooth® audio streaming
 - Bluetooth® mobile phone portal
 - Apple CarPlay™ / Android Auto™
 - USB audio connection
- Six speakers

Interior convenience / styling:

- Air conditioning
- Sports-style front seats
- VX-Line styling: Leather-covered flat-bottom steering wheel / gear knob / handbrake lever
- Multi-function trip computer
- Cruise control
- Speed-sensitive power-assisted steering
- Steering column adjustable for reach / rake
- Steering wheel audio / phone / cruise controls
- Driver's seat height adjuster

Exterior convenience / styling:

- VX-Line body styling: Front lower spoiler / side sills / rear skirt / rear roof spoiler (3-door only)
- Roof / door mirrors / front grille bar in black
- Heated windscreen
- Remote control central locking
- Electrically operated front windows
- Electrically adjustable / heated door mirrors
- Dark-tinted rear windows
- Sports suspension
- Front fog lights
- 17-inch black alloy wheels

Safety / security features:

- Electronic Stability Programme (ESP)
- Anti-lock Braking System (ABS)
- Six airbags
- Hill start assist
- Seatbelt reminders for all seats
- ISOFIX child seat fixings on outer rear seats
- Tyre pressure monitoring system
- LED daytime running lights



GSi



GSi ON-THE-ROAD PRICES

		3-door hatchback	
		OTR RRP	CO ₂ (g/km)
Petrol	1.4i Turbo (150PS) S/S	£18,995	138

Please note: On-the-road recommended retail prices (RRP) include VAT at 20%, number plates and delivery to Retailer of £700.00 (inc. £116.67 VAT), 12 months' Vehicle Excise Duty and new vehicle first registration fee of £55.00. Excludes fuel and insurance.

S/S = Start/Stop.

FEATURES

Infotainment:

- IntelliLink audio system
 - 7-inch colour touchscreen
 - AM/FM/DAB digital radio
 - Bluetooth® audio streaming
 - Bluetooth® mobile phone portal
 - Apple CarPlay™ / Android Auto™
 - USB audio connection

- Six speakers

Interior convenience / styling:

- Air conditioning
- Sports-style front seats
- GSi styling: Leather-covered flat-bottom steering wheel / gear knob / handbrake lever
- Multi-function trip computer
- Cruise control
- Speed-sensitive power-assisted steering
- Steering column adjustable for reach / rake
- Steering wheel audio / phone / cruise controls
- Driver's seat height adjuster

Exterior convenience / styling:

- GSi body styling: Front lower spoiler / side sills / rear skirt / rear roof spoiler
- Carbon-effect door mirrors / front grille bar
- Heated windscreen
- Remote control central locking
- Electrically operated front windows
- Electrically adjustable / heated door mirrors
- Dark-tinted rear windows
- Sports suspension
- 17-inch 5-spoke bi-colour alloy wheels

Safety / security features:

- Electronic Stability Programme (ESP)
- Anti-lock Braking System (ABS)
- Six airbags
- Hill start assist
- Seatbelt reminders for all seats
- ISOFIX child seat fixings on outer rear seats
- Tyre pressure monitoring system
- LED daytime running lights
- Remote control security alarm



CORSA 3-DOOR HATCHBACK PRICES

	Fuel Type	Price (£)	VAT (£)	Total (£)	On-the-road RRP (£)	CO ₂ (g/km)
ACTIVE						
1.4i (75PS)	Petrol	8,608.33	1,721.67	10,330.00	11,290.00	131
DESIGN						
1.4i (75PS)	Petrol	10,045.83	2,009.17	12,055.00	13,015.00	131
ENERGY						
1.4i (75PS)	Petrol	11,183.33	2,236.67	13,420.00	14,380.00	131
1.4i (90PS)	Petrol	11,387.50	2,277.50	13,665.00	14,625.00	131
1.4i (90PS) automatic	Petrol	12,525.00	2,505.00	15,030.00	15,990.00	142
GRIFFIN (SPECIAL EDITION MODEL)						
1.4i (75PS)	Petrol	8,945.83	1,789.17	10,735.00	11,695.00	131
1.4i (90PS)	Petrol	9,150.00	1,830.00	10,980.00	11,940.00	131
SPORT						
1.4i (75PS)	Petrol	11,995.83	2,399.17	14,395.00	15,355.00	131
1.4i (90PS)	Petrol	12,200.00	2,440.00	14,640.00	15,600.00	131
SRi NAV						
1.4i (75PS)	Petrol	12,829.17	2,565.83	15,395.00	16,355.00	131
1.4i (90PS)	Petrol	13,033.33	2,606.67	15,640.00	16,600.00	131
1.4i Turbo (100PS) Start/Stop	Petrol	13,579.17	2,715.83	16,295.00	17,215.00	128



CORSA 3-DOOR HATCHBACK PRICES

	Fuel Type	Price (£)	VAT (£)	Total (£)	On-the-road RRP (£)	CO ₂ (g/km)
SE NAV						
1.4i (90PS)	Petrol	12,054.17	2,410.83	14,465.00	15,425.00	131
1.4i (90PS) automatic	Petrol	13,191.67	2,638.33	15,830.00	16,790.00	142
SRI VX-LINE NAV BLACK						
1.4i (75PS)	Petrol	13,404.17	2,680.83	16,085.00	17,045.00	131
1.4i (90PS)	Petrol	13,608.33	2,721.67	16,330.00	17,290.00	131
GSi						
1.4i Turbo (150PS) Start/Stop	Petrol	15,029.17	3,005.83	18,035.00	18,995.00	138



CORSA 5-DOOR HATCHBACK PRICES

	Fuel Type	Price (£)	VAT (£)	Total (£)	On-the-road RRP (£)	CO ₂ (g/km)
DESIGN						
1.4i (75PS)	Petrol	10,545.83	2,109.17	12,655.00	13,575.00	130
1.4i (90PS)	Petrol	10,750.00	2,150.00	12,900.00	13,820.00	130
1.4i (90PS) automatic	Petrol	11,887.50	2,377.50	14,265.00	15,225.00	150
ENERGY						
1.4i (75PS)	Petrol	11,683.33	2,336.67	14,020.00	14,940.00	130
1.4i (90PS)	Petrol	11,887.50	2,377.50	14,265.00	15,185.00	130
1.4i (90PS) automatic	Petrol	13,025.00	2,605.00	15,630.00	16,590.00	150
1.4i Turbo (100PS) Start/Stop	Petrol	12,433.33	2,486.67	14,920.00	15,840.00	128
GRIFFIN (SPECIAL EDITION MODEL)						
1.4i (75PS)	Petrol	9,445.83	1,889.17	11,335.00	12,255.00	130
1.4i (90PS)	Petrol	9,650.00	1,930.00	11,580.00	12,500.00	130
SPORT						
1.4i (75PS)	Petrol	12,495.83	2,499.17	14,995.00	15,915.00	130
1.4i (90PS)	Petrol	12,700.00	2,540.00	15,240.00	16,160.00	130
SRI NAV						
1.4i (75PS)	Petrol	13,329.17	2,665.83	15,995.00	16,915.00	130
1.4i (90PS)	Petrol	13,533.33	2,706.67	16,240.00	17,160.00	130
1.4i (90PS) automatic	Petrol	14,670.83	2,934.17	17,605.00	18,565.00	150
1.4i Turbo (100PS) Start/Stop	Petrol	14,079.17	2,815.83	16,895.00	17,815.00	128



CORSA 5-DOOR HATCHBACK PRICES

	Fuel Type	Price (£)	VAT (£)	Total (£)	On-the-road RRP (£)	CO ₂ (g/km)
SE NAV						
1.4i (75PS)	Petrol	12,350.00	2,470.00	14,820.00	15,740.00	130
1.4i (90PS)	Petrol	12,554.17	2,510.83	15,065.00	15,985.00	130
1.4i (90PS) automatic	Petrol	13,691.67	2,738.33	16,430.00	17,390.00	150
1.4i Turbo (100PS) Start/Stop	Petrol	13,100.00	2,620.00	15,720.00	16,640.00	128
SRI VX-LINE NAV BLACK						
1.4i (75PS)	Petrol	13,904.17	2,780.83	16,685.00	17,605.00	130
1.4i (90PS)	Petrol	14,108.33	2,821.67	16,930.00	17,850.00	130



FEATURES/OPTIONS

SAFETY

	Active	Design	Energy	Griffin	Sport	SRI Nav	SE Nav	SRI VX-Line Nav Black	GSI	Price (£) exc. VAT	Price (£) inc. VAT
Driver / passenger airbags <ul style="list-style-type: none"> • Driver's dual-stage airbag • Front passenger's dual-stage airbag • Front seat side-impact airbags • Full-size curtain airbags 	●	●	●	●	●	●	●	●	●		
Seating <ul style="list-style-type: none"> • Height-adjustable front seat head restraints • Adjustable outer rear seat head restraints • Anti-submarining ramps in all seats – Helps prevent occupants sliding underneath the lap belt during a collision. 	●	●	●	●	●	●	●	●	●		
Seatbelts <ul style="list-style-type: none"> • Height-adjustable front seatbelts • Three inertia-reel lap and diagonal rear seatbelts • Front seatbelt pretensioner system – Pretensioners tighten the seatbelt in the event of an accident limiting forward movement. • Front seatbelt force limiters – Reduces potential upper body injuries during a frontal impact. • Front and rear 'seatbelt unfastened' audible warning and warning light 	●	●	●	●	●	●	●	●	●		
Child safety <ul style="list-style-type: none"> • Deactivation switch for front passenger's airbag – Permits the safe use of a child seat in the front passenger seat. • ISOFIX child seat mountings incorporating top tether anchor points located on outer rear seats (does not include child seat) – Allows ISOFIX child safety seats to be securely fixed into the car. The ISOFIX mounting system reduces forward movement in an accident and makes the child seat easier to install. • Child-proof locks on rear doors 	●	●	●	●	●	●	●	●	●		
Driver/passenger safety <ul style="list-style-type: none"> • Energy-absorbing steering column • Pedal release system – Reduces potential injury to the driver's legs and feet during a severe frontal impact. • Laminated windscreen • Side-impact protection beams • Reinforced passenger safety cell 	●	●	●	●	●	●	●	●	●		
Pedestrian safety <ul style="list-style-type: none"> • Bonnet/headlight/wiper structure – Designed to reduce pedestrian head and upper body injuries. • Upper and lower bumper design – Reduces upper and lower leg injuries. 	●	●	●	●	●	●	●	●	●		

● = Standard equipment.



FEATURES/OPTIONS

SAFETY CONTINUED

	Active	Design	Energy	Griffin	Sport	SRI Nav	SE Nav	SRI VX-Line Nav Black	GSI	Price (£) exc. VAT	Price (£) inc. VAT
<p>Stability</p> <ul style="list-style-type: none"> • Electronic Stability Programme (ESP) – Works in conjunction with the vehicle’s electronic braking and engine systems to keep the car stable in many different situations. ESP monitors many different inputs to determine when the car starts to lose traction, it can then immediately respond by varying the brake pressure between up to three wheels and adjust the engine output to help correct the loss of traction and improve stability. <p>Additional ESP features:</p> <ul style="list-style-type: none"> • Traction control • Cornering brake control • Straight line stability control • Drag torque control – Maintain stability on slippery roads when lifting off the accelerator or changing gear. 	●	●	●	●	●	●	●	●	●		
<p>Braking</p> <ul style="list-style-type: none"> • Anti-lock Braking System (ABS) – Prevents the vehicle’s wheels from locking up under heavy braking by momentarily reducing brake pressure at the appropriate wheel, ensuring that you can maintain control of the steering. <p>Additional braking features:</p> <p>The same electronic systems used in the ABS and ESP also deliver exceptional braking performance.</p> <ul style="list-style-type: none"> • Emergency brake assist – When emergency braking is detected the vehicle automatically applies the maximum possible braking assistance. • Electronic brakeforce distribution – Automatically apportions the optimum braking force to each wheel. • Adaptive brake lights – Automatically warns other road users of heavy braking • Hill start assist – Briefly maintains rear brake pressure to stop the vehicle rolling back on an incline. • Hazard warning lights 	●	●	●	●	●	●	●	●	●		
<p>Tyre pressure</p> <ul style="list-style-type: none"> • Tyre pressure monitoring system 	●	●	●	●	●	●	●	●	●		

● = Standard equipment.



FEATURES/OPTIONS

DRIVER ASSISTANCE

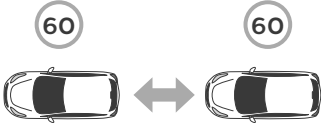
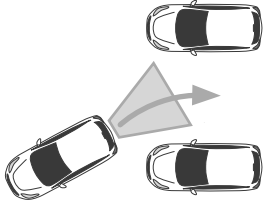
	Active	Design	Energy	Griffin	Sport	SRI Nav	SE Nav	SRI VX-Line Nav Black	GSI	Price (£) exc. VAT	Price (£) inc. VAT
Steering <ul style="list-style-type: none"> • Speed-sensitive electric power-assisted steering • City mode button – Provides lighter steering at parking speeds. 	●	●	●	●	●	●	●	●	●		
Cruise control with speed limiter <p>Enables you to maintain a constant speed – making it ideal for economical motorway driving.</p> <ul style="list-style-type: none"> • The speed limiter function – Can be set to ensure that you do not exceed the speed limit and can be easily overridden if required. • Steering wheel mounted controls 	●	●	●	●	●	●	●	●	●		
Parking sensors <ul style="list-style-type: none"> • Rear parking distance sensors • Audible warning 	○	○	○		○	○	●	○	○	250.00	300.00
<ul style="list-style-type: none"> • Front and rear parking distance sensors • Audible warning • Distance warning graphic shown in driver information display 	○	○	○		○	○	●	○	○	387.50	465.00
Rear-view camera <p>The rear-view camera gives a clear view of the area behind your car and helps place the car perfectly, without needing to strain your neck.</p> <ul style="list-style-type: none"> • Activated when reverse gear selected • Camera view appears in infotainment screen • Rear bumper and one-metre grid lines shown as reference points <p>Please note: Only available in conjunction with parking sensors. Not available with CD 30 BT audio unit.</p> 		○	○		○	○	○	○	○	208.33	250.00



FEATURES/OPTIONS

SECURITY

	Active	Design	Energy	Griffin	Sport	SRI Nav	SE Nav	SRI VX-Line Nav Black	GSI	Price (£) exc. VAT	Price (£) inc. VAT
Standard security features <ul style="list-style-type: none"> • 'Key left in ignition' audible warning • Electronically protected audio equipment • Engine deadlock immobiliser • Visible Vehicle Identification Number (VIN) • Locking wheel bolts for alloy wheels (where fitted) • Door-to-door illumination 	●	●	●	●	●	●	●	●	●		
Central locking <ul style="list-style-type: none"> • Remote control • Operates on doors, tailgate and fuel filler flap • Deadlocking • Central locking activation switch on facia • One folding key/one static key each with integral remote control function 	●	●	●	●	●	●	●	●	●		
Security alarm system – 1.4i Turbo (100/150PS) models only. <ul style="list-style-type: none"> • Remote control (operates in conjunction with central locking) • Tilt sensor • Thatcham approved 						○	○		●	216.67	260.00



FEATURES/OPTIONS

DRIVER INFORMATION

	Active	Design	Energy	Griffin	Sport	SRI Nav	SE Nav	SRI VX-Line Nav Black	GSI	Price (£) exc. VAT	Price (£) inc. VAT
Instrumentation											
<ul style="list-style-type: none"> • Speedometer • Rev counter • Digital fuel gauge with low fuel level warning light • Digital water temperature gauge • Instrument panel light dimmer • Shift-up indication light – Indicates when to change gear for optimum fuel economy 	●	●	●	●	●	●	●	●	●		
Driver information display (centrally located in instrument cluster)											
<ul style="list-style-type: none"> • Displays trip computer data • Total mileage • Service-due indicator • Oil life • Tyre pressure monitoring system • Headlight/brake light bulb failure warning 	●	●	●	●	●	●	●	●	●		
Red graphics on black background	●										
Red graphics on black background (fitted in lieu of white graphics on 1.4i (75PS) and 1.4i (90PS) models if CD 30 BT audio unit is fitted in lieu of IntelliLink. Where digital speedometer and digital over-speed warning are standard, these features will be deleted. Not available separately).		●	●		●	●		●			
White graphics on black background		●	●	●	●	●	●	●	●		
Central facia display (format dependent on infotainment unit)											
<ul style="list-style-type: none"> • Audio information • Digital clock with automatic RDS time adjustment • Outside air temperature with ice warning function • Additional features dependent on infotainment unit (see infotainment for details) 	●	●	●	●	●	●	●	●	●		
Multi-function trip computer (displayed on driver information display)											
<ul style="list-style-type: none"> • Trip mileage • Vehicle range based on remaining fuel • Average speed • Average fuel economy • Instantaneous fuel economy • Digital speedometer • Digital over-speed warning 				●	●	●	●	●	●		



FEATURES/OPTIONS

INTERIOR STYLING

	Active	Design	Energy	Griffin	Sport	SRI Nav	SE Nav	SRI VX-Line Nav Black	GSI	Price (£) exc. VAT	Price (£) inc. VAT
<p>Active interior décor</p> <p>Steering wheel:</p> <ul style="list-style-type: none"> • Three-spoke design • Leather-covered • Satin chrome-effect bezel <p>Facia and door trim:</p> <ul style="list-style-type: none"> • Piano black facia • Black door panels with black Atlantis cloth inserts • Chrome-effect interior door handles <p>Seat trim:</p> <ul style="list-style-type: none"> • Spot Shimmer black fabric seat trim inserts • Plain black fabric side bolsters and surrounds 	●										
<p>Design / Energy interior décor</p> <p>Steering wheel:</p> <ul style="list-style-type: none"> • Three-spoke design • Leather-covered • Satin chrome-effect bezel <p>Facia and door trim:</p> <ul style="list-style-type: none"> • Rhutenium facia with chrome-effect trim inserts • Black door panels with black Atlantis cloth inserts • Chrome-effect interior door handles <p>Seat trim:</p> <ul style="list-style-type: none"> • Spot Shimmer black fabric seat trim inserts • Plain black fabric side bolsters and surrounds 		●	●								
<p>Griffin interior décor</p> <p>Steering wheel:</p> <ul style="list-style-type: none"> • Three-spoke design • Leather-covered with accent stitching • Satin chrome-effect bezel <p>Facia and door trim:</p> <ul style="list-style-type: none"> • Piano black facia with red/white inserts (dependent on exterior colour) • Black door panels with black Atlantis cloth inserts • Chrome-effect interior door handles <p>Seat trim:</p> <ul style="list-style-type: none"> • Black lace fabric seat trim inserts • Plain black fabric side bolsters and surrounds with accent stitching 				●							



FEATURES/OPTIONS

INTERIOR STYLING

	Active	Design	Energy	Griffin	Sport	SRI Nav	SE Nav	SRI VX-Line Nav Black	GSi	Price (£) exc. VAT	Price (£) inc. VAT
<p>Sport interior décor</p> <p>Steering wheel:</p> <ul style="list-style-type: none"> • Three-spoke design • Leather-covered • Satin chrome-effect bezel <p>Facia and door trim:</p> <ul style="list-style-type: none"> • Piano black facia with red/white inserts (dependent on exterior colour) • Black door panels with black Atlantis cloth inserts • Chrome-effect interior door handles <p>Seat trim:</p> <ul style="list-style-type: none"> • Black Lace fabric seat trim inserts • Plain black fabric side bolsters and surrounds with accent stitching 					●						
<p>SRI Nav interior décor</p> <p>Steering wheel:</p> <ul style="list-style-type: none"> • Three-spoke design • Leather-covered with accent stitching • Satin chrome-effect bezel <p>Facia and door trim:</p> <ul style="list-style-type: none"> • Piano black facia with red trim inserts (except Aegean Blue models, which feature a white trim insert) • Black door panels with black Atlantis cloth inserts • Chrome-effect interior door handles <p>Seat trim:</p> <ul style="list-style-type: none"> • Black lace fabric seat trim inserts • Plain black fabric side bolsters and surrounds with accent stitching 						●					
<p>SE Nav interior décor</p> <p>Steering wheel:</p> <ul style="list-style-type: none"> • Three-spoke design • Leather-covered with accent stitching • Satin chrome-effect bezel <p>Facia and door trim:</p> <ul style="list-style-type: none"> • Rhutenium facia with chrome-effect trim inserts • Black door panels with black premium leather-effect inserts • Chrome-effect interior door handles <p>Seat trim:</p> <ul style="list-style-type: none"> • Graphic Embossed black cloth seat trim inserts • Black premium leather-effect side bolsters and surrounds <p>Front door sill covers:</p> <ul style="list-style-type: none"> • Alloy-effect 							●				

● = Standard equipment.



FEATURES/OPTIONS

INTERIOR STYLING

	Active	Design	Energy	Griffin	Sport	SRI Nav	SE Nav	SRI VX-Line Nav Black	GSI	Price (£) exc. VAT	Price (£) inc. VAT
<p>SRI VX-Line Nav Black interior décor with Lace cloth seat trim</p> <p>Steering wheel:</p> <ul style="list-style-type: none"> VX-Line three-spoke design • Leather-covered flat bottom Satin chrome-effect bezel <p>Gear knob:</p> <ul style="list-style-type: none"> VX-Line leather-covered <p>Facia and door trim:</p> <ul style="list-style-type: none"> Piano black facia with white trim inserts Black door panels with black Atlantis cloth inserts Chrome-effect interior door handles <p>Seat trim:</p> <ul style="list-style-type: none"> Black Lace fabric seat trim inserts Plain black fabric side bolsters and surrounds with accent stitching 								●			
<p>SRI VX-Line Nav Black interior décor with Network Moonray cloth seat trim</p> <p>Steering wheel:</p> <ul style="list-style-type: none"> VX-Line three-spoke design • Leather-covered flat bottom Satin chrome-effect bezel <p>Gear knob:</p> <ul style="list-style-type: none"> VX-Line leather-covered <p>Facia and door trim:</p> <ul style="list-style-type: none"> Piano black facia with white trim inserts Black door panels with black Atlantis cloth inserts Chrome-effect interior door handles <p>Seat trim:</p> <ul style="list-style-type: none"> Network Moonray cloth seat trim inserts Piano black facia side bolsters and surrounds 								○	133.33	160.00	

● = Standard equipment. ○ = Optional at extra cost.



FEATURES/OPTIONS

INTERIOR STYLING

	Active	Design	Energy	Griffin	Sport	SRI Nav	SE Nav	SRI/VX-Line Nav Black	GSi	Price (£) exc. VAT	Price (£) inc. VAT
<p>GSi interior décor with Lace cloth seat trim</p> <p>Steering wheel:</p> <ul style="list-style-type: none"> • GSi three-spoke design • Leather-covered flat bottom • Satin chrome-effect bezel <p>Gear knob:</p> <ul style="list-style-type: none"> • GSi leather-covered <p>Facia and door trim:</p> <ul style="list-style-type: none"> • Piano black facia with white trim inserts • Black door panels with black Atlantis cloth inserts • Chrome-effect interior door handles <p>Seat trim:</p> <ul style="list-style-type: none"> • Black Lace fabric seat trim inserts • Plain black fabric side bolsters and surrounds with accent stitching 									●		
<p>GSi interior décor with Nappa leather seat trim</p> <p>Steering wheel:</p> <ul style="list-style-type: none"> • GSi three-spoke design • Leather-covered flat bottom • Satin chrome-effect bezel <p>Gear knob:</p> <ul style="list-style-type: none"> • GSi leather-covered <p>Facia and door trim:</p> <ul style="list-style-type: none"> • Piano black facia with white trim inserts • Black door panels with black Rhodos vinyl inserts • Chrome-effect interior door handles <p>Seat trim:</p> <ul style="list-style-type: none"> • Recaro seats • Black Nappa leather seat trim inserts • Black leather-effect side bolsters and surrounds 									○	879.17	1,055.00



FEATURES/OPTIONS

INFOTAINMENT

	Active	Design	Energy	Griffin	Sport	SRI Nav	SE Nav	SRI VX-Line Nav Black	GSI	Price (£) exc. VAT	Price (£) inc. VAT
<p>CD 30 BT</p> <p>Onboard features:</p> <ul style="list-style-type: none"> • CD/MP3 CD player • AM/FM stereo radio with 36 station presets • RDS with Traffic Programme <p>Media connections:</p> <ul style="list-style-type: none"> • USB connection with iPod control • Aux-in socket <p>Mobile phone portal:</p> <ul style="list-style-type: none"> • Bluetooth® connectivity • Handsfree calls via steering wheel controls • Vehicle microphone • Phone book access <p>Please note: On 1.4i (75PS) and 1.4i (90PS) models the trip computer including digital speedometer and digital over-speed warning are deleted.</p>	●	N/C	N/C		N/C	N/C	N/C	N/C	N/C	No-cost option	
<p>R4.0 IntelliLink touchscreen infotainment system</p> <p>For use with media players, USB memory sticks, mobile phones and smartphone apps.</p> <p>Onboard features:</p> <ul style="list-style-type: none"> • 7-inch colour touchscreen • DAB digital radio/AM/FM stereo radio with 36 station presets • RDS with Traffic Programme <p>Media connections:</p> <ul style="list-style-type: none"> • USB connection with iPod control • Bluetooth® A2DP audio streaming (Advanced Audio Distribution Profile) <p>Mobile phone portal:</p> <ul style="list-style-type: none"> • Bluetooth® connectivity • Handsfree calls via steering wheel controls • Vehicle microphone • Phone book access – The majority of the phone's functions – contacts/last calls/missed calls etc. – are mirrored on IntelliLink's display and are easily navigated using the touchscreen (features dependent on mobile phone). <p>Smartphone interface:</p> <ul style="list-style-type: none"> • Apple CarPlay™ • Android Auto™ – Smartphone projection that allows operations via voice command, touchscreen and buttons to control apps and music playback. 		●	●		●			●			



FEATURES/OPTIONS







INFOTAINMENT

	Active	Design	Energy	Griffin	Sport	SRI Nav	SE Nav	SRI VX-Line Nav Black	GSI	Price (£) exc. VAT	Price (£) inc. VAT
<p>Navi 4.0 IntelliLink touchscreen navigation and infotainment system</p> <p>For use with media players, USB memory sticks, mobile phones and smartphone apps</p> <p>Onboard features:</p> <ul style="list-style-type: none"> • 7-inch colour touchscreen • DAB digital radio/AM/FM stereo radio with 36 station presets • RDS with Traffic Programme <p>Navigation features:</p> <ul style="list-style-type: none"> • Satellite navigation system • 2D street level mapping • European coverage • Structured or one-box destination entry • Points-of-interest search • Eco routing • Map updates via USB <p>Media connections:</p> <ul style="list-style-type: none"> • USB connection with iPod control • Bluetooth® A2DP audio streaming (Advanced Audio Distribution Profile) <p>Mobile phone portal:</p> <ul style="list-style-type: none"> • Bluetooth® connectivity • Handsfree calls via steering wheel controls • Vehicle microphone • Phone book access – The majority of the phone’s functions – contacts/last calls/missed calls etc. – are mirrored on IntelliLink’s display and are easily navigated using the touchscreen (features dependent on mobile phone). <p>Smartphone interface:</p> <ul style="list-style-type: none"> • Apple CarPlay™ • Android Auto™ – Smartphone projection that allows operations via voice command, touchscreen and buttons to control apps and music playback. <p>Gallery – only available when vehicle is stationary:</p> <ul style="list-style-type: none"> • Photo gallery with slide show feature • Video playback with soundtrack played through car speakers 		○	○	●	○	●	●	●	○	541.67	650.00
Six speakers	●	●	●	●	●	●	●	●	●		
Steering wheel mounted audio controls	●	●	●	●	●	●	●	●	●		



FEATURES/OPTIONS

ONSTAR

	Active	Design	Energy	Griffin	Sport	SRI Nav	SE Nav	SRI VX-Line Nav Black	GSI	Price (£) exc. VAT	Price (£) inc. VAT
<div style="display: flex; justify-content: space-between;"> <div style="text-align: center;">  Automatic Crash Response </div> <div style="text-align: center;">  Wi-Fi Hotspot </div> <div style="text-align: center;">  Smartphone App </div> <div style="text-align: center;">  Stolen Vehicle Assistance </div> <div style="text-align: center;">  Vehicle Diagnostics </div> <div style="text-align: center;">  Destination Download </div> </div> <p>OnStar – Your personal on board assistant*</p> <p>Many car brands talk about innovation as soon as they improve their cup holders but this innovative system, now available on selected models**, is revolutionary: 24/7, 365 days a year, OnStar puts you in touch with a trained advisor, not a machine. With OnStar you have access to a host of innovations, from Vehicle Diagnostics and Smartphone Function to a fully integrated 4G Wi-Fi Hotspot[†]. In the event of an accident, OnStar even automatically calls for help, for an incomparable feeling of safety. OnStar – Your personal connectivity and service assistant.</p> <div style="text-align: center;">  </div>		O	O		O	O	O	O	O	345.83	415.00

*Includes 12 months of OnStar services from date of first registration and a 3 month/3 GB Wi-Fi free trial period (whichever comes first) effective from the date the customer accepts the nominated network operator Wi-Fi T's&C's. Theft alert feature only operates on models fitted with security alarm system. Destination download feature only operates on models fitted with Navi 4.0 IntelliLink satellite navigation system.

**The OnStar Services require activation and are subject to mobile network coverage and availability. Wi-Fi Hotspot service requires account with nominated network operator.

[†]4G is subject to mobile network coverage and availability. Charges apply after the free trial period. The OnStar subscription packages could be different from the services included in the free trial package. Check www.vauxhall.co.uk/onstar for terms and conditions, details of availability, coverage and charges.

All OnStar services and Wi-Fi services will cease to be available on 31 December 2020. No trial or paid subscriptions or services, including emergency response services, will be available after that date.

O = Optional at extra cost.



FEATURES/OPTIONS

HEATING AND VENTILATION

	Active	Design	Energy	Griffin	Sport	SRI Nav	SE Nav	SRI VX-Line Nav Black	GSI	Price (£) exc. VAT	Price (£) inc. VAT
Air blend heater <ul style="list-style-type: none"> Cabin particulate filter – Removes dust, airborne particles and pollen Four-speed fan • Illuminated controls 	●										
Air conditioning <ul style="list-style-type: none"> Air recirculation facility Cabin particulate filter – Removes dust, airborne particles and pollen Four-speed fan • Illuminated controls 	○	●	●	●	●	●	●	●	●	445.83	535.00
Electronic climate control incorporating air conditioning <ul style="list-style-type: none"> Single-zone control • Advanced predictive logic control system using sun sensor Cabin charcoal filter – Removes dust, airborne particles, pollen and unpleasant odours Automatic air direction and fan speed with manual override LCD temperature display • Six-speed fan • Illuminated controls 			○		○	○	○	○	○	345.83	415.00
Additional features <ul style="list-style-type: none"> Four adjustable facia vents • Windscreen demist vents • Side window demist vents 	●	●	●	●	●	●	●	●	●		



FEATURES/OPTIONS

SEATING AND COMFORT

	Active	Design	Energy	Griffin	Sport	SRI Nav	SE Nav	SRI VX-Line Nav Black	GSI	Price (£) exc. VAT	Price (£) inc. VAT
Reach and rake adjustable steering	●	●	●	●	●	●	●	●	●		
Comfort front seats											
Driver's seat (eight-way adjustable): • Height (up/down) • Reach (fore/aft) • Backrest (upright/recline) • Head restraint (up/down)	●	●	●				●				
Front passenger's seat (six-way adjustable): • Reach (fore/aft) • Backrest (upright/recline) • Head restraint (up/down)											
Sports-style front seats											
Driver's seat (eight-way adjustable): • Height (up/down) • Reach (fore/aft) • Backrest (upright/recline) • Head restraint (up/down)				●	●	●		●	●		
Front passenger's seat (six-way adjustable): • Reach (fore/aft) • Backrest (upright/recline) • Head restraint (up/down)											
Easy-entry front seats with memory function (three-door models only)	●	●	●	●	●	●	●	●	●		
Front passenger's seat height adjuster	○	○	○		○	○	○	○	○	62.50	75.00
Rear seats											
• Three-person layout • Adjustable backrest • Height-adjustable and removable outer head restraints • ISOFIX child seat mountings incorporating top tether anchor points located on outer rear seats (does not include child seat) – Allows ISOFIX child safety seats to be securely fixed into the car. The ISOFIX mounting system reduces forward movement in an accident and makes the child seat easier to install. • Child-proof locks on rear doors	●	●	●	●	●	●	●	●	●		
• One-piece folding rear seat	●	●	●	●	●	●		●	●		
• 60/40 split-folding rear seat back	○	○	○		○	○	●	○	○	116.67	140.00

● = Standard equipment. ○ = Optional at extra cost.



FEATURES/OPTIONS

INTERIOR CONVENIENCE

	Active	Design	Energy	Griffin	Sport	SRI Nav	SE Nav	SRI VX-Line Nav Black	GSI	Price (£) exc. VAT	Price (£) inc. VAT
Convenience features											
• Front 12-volt electrical accessory socket	●	●	●	●	●	●	●	●	●		
• Driver's and front passengers sunvisors											
• Driver's vanity mirror • Dipping rear-view mirror											
• Driver's and front passenger's tilttable assist handles											
• Two rear tilttable passenger assist handles (five-door models only)											
Driver's and front passenger's vanity mirrors with flip-up cover		●	●	●	●	●	●	●	●		
Automatically dimming anti-dazzle rear-view mirror		□	●	●	●	●	●	●	●		
Velour floor mats							□				
Front and rear floor mats (front Griffin-branded)				●							
Interior lighting											
• Central front courtesy light • Central rear courtesy light • Fade up/fade down	●	●	●	●	●	●	●	●	●		
• Front map reading lights • Rear reading light (five-door models only)											
Interior storage											
• Storage box on driver's side lower facia • Glovebox with lid • Front door pockets	●	●	●	●	●	●	●	●	●		
• Drinks holder in centre console • Rear door pockets (five-door models only)											
• Rear bottle holders (three-door models only)											
• Front passenger's underseat storage tray					●	●					
• Storage pockets on front seat backs							●				
Luggage area											
• Luggage compartment cover	●	●	●	●	●	●	●	●	●		
• Stowage facility for luggage compartment cover behind rear seats											
• Illuminated luggage area • Interior tailgate handles											
• Load restraint lashing eyes • Twin gas-assisted tailgate struts											



FEATURES/OPTIONS

MECHANICAL

	Active	Design	Energy	Griffin	Sport	SRI Nav	SE Nav	SRI VX-Line Nav Black	GSI	Price (£) exc. VAT	Price (£) inc. VAT
Standard features	●	●	●	●	●	●	●	●	●		
• Front-wheel drive • Gas-pressure dampers • Front anti-roll bar • Speed-sensitive electric power-assisted steering											
• Sports suspension								●	●		
Transmissions	●	●	●	●	●	●	●	●			
• Five-speed manual gearbox (excluding 1.4i Turbo (100PS) models)											
• Six-speed manual gearbox (1.4i Turbo (100/150PS) models)			●			●	●	●	●		
• Six-speed automatic transmission (1.4i (90PS) models only)		▲	▲				▲	▲			



FEATURES/OPTIONS

EXTERIOR LIGHTING

	Active	Design	Energy	Griffin	Sport	SRI Nav	SE Nav	SRI VX-Line Nav Black	GSI	Price (£) exc. VAT	Price (£) inc. VAT
Standard lighting features	●	●	●	●	●	●	●	●	●		
• Welcome lighting • Lights-on audible warning • Electric headlight beam levelling • High-level LED centre rear brake light • Rear fog light											
Halogen headlights	●	●	●	●	●	●	●	●	●		
Bi-xenon headlights with cornering light							○	○	○	354.17	425.00
Daytime running lights	●										
LED daytime running lights		●	●	●	●	●	●	●	●		
Front fog lights with black surround		●	●	●				●			
Front fog lights with chrome-effect surround						●	●				



FEATURES/OPTIONS

EXTERIOR CONVENIENCE

	Active	Design	Energy	Griffin	Sport	SRI Nav	SE Nav	SRI VX-Line Nav Black	GSI	Price (£) exc. VAT	Price (£) inc. VAT
Windscreen wipers											
<ul style="list-style-type: none"> • Two-speed windscreen wipers with variable intermittent wipe • Intermittent rear window wash/wipe 	●	●	●	●	●	●	●	●	●		
<ul style="list-style-type: none"> • Rain-sensitive windscreen wipers 		□	●	●	□	●	●	●	□		
Door mirrors											
<ul style="list-style-type: none"> • Electrically adjustable door mirrors (wide-angle on driver's side), manually foldable 	●	●									
<ul style="list-style-type: none"> • Electrically adjustable/heated door mirrors (wide-angle on driver's side, except in conjunction with advanced park assist), manually foldable 			●	●	●	●	●	●	●		
Windows											
<ul style="list-style-type: none"> • Heated windscreen • Electrically operated front windows with safety autoreverse and one-touch facility • Heated rear window 	●	●	●	●	●	●	●	●	●		



FEATURES/OPTIONS

EXTERIOR STYLING

	Active	Design	Energy	Griffin	Sport	SRi Nav	SE Nav	SRi VX-Line Nav Black	GSi	Price (£) exc. VAT	Price (£) inc. VAT
Active/Design/Energy/Sport/SRi Nav styling • Chrome-effect front grille bar • Body-colour door mirrors • Body-colour door handles	●	●	●		●	●					
Griffin styling • Mineral Black door mirror housings • Black front grille bar • Body-colour door handles • Mineral Black roof				●							
SE Nav styling • Chrome-effect front grille bar • Body-colour door mirrors • Body-colour door handles • Chrome-effect lower side window mouldings (5-door models only) • Alloy-effect front door sill covers with 'Vauxhall' lettering							●				
SRi VX-Line Nav Black styling • Mineral Black door mirror housings • Black front grille bar • Body-colour door handles • Body-colour front lower spoiler/side sills/rear lower skirt • Rear roof spoiler (3-door models only) • Mineral Black roof								●			
GSi styling • Carbon-effect door mirror housings and front grille bar • Body-colour door handles • Body-colour front lower spoiler/side sills/rear lower skirt • Rear roof spoiler									●		
Black foil on B-pillars (not with Aegean Blue or optional Mineral Black or Darkmoon Blue exterior colours)	●	●	●	●	●	●	●	●	●		
Windows • Tinted windows	●	●	●	●	●	●	●	●	●		
• Dark-tinted rear windows		○	○	●	●	○	○	●	●	237.50	285.00







FEATURES/OPTIONS

OPTION PACKS

	Active	Design	Energy	Griffin	Sport	SRI Nav	SE Nav	SRI VX-Line Nav Black	GSi	Price (£) exc. VAT	Price (£) inc. VAT
SE Nav Lux Pack <ul style="list-style-type: none"> • Electronic climate control incorporating air conditioning • Security alarm system (1.4i Turbo (100PS) models only) • Velour floor mats • Bi-xenon headlights with cornering light • Dark-tinted rear windows • Rear-view camera (not available with CD 30 BT infotainment system) • 17-inch black multispoke alloy wheels 							○			1,291.67	1,550.00
Sight and Light Pack <ul style="list-style-type: none"> • Rain-sensitive windscreen wipers • Automatic lighting control • Automatically dimming anti-dazzle rear-view mirror 		○	●	●	○	●	●	●	○	200.00	240.00
Winter Pack <ul style="list-style-type: none"> • Heated leather-covered steering wheel • Heated front seats 		○	●	●	○	○	●	○	○	303.17	365.00
GSi Plus Pack <ul style="list-style-type: none"> • Recaro leather seats • 18-inch diamond-cut alloy wheels • Bi-xenon headlights with cornering light 									○	1,583.33	1,900.00



EXTERIOR COLOURS





			Active	Design	Energy	Griffin	Sport	SRI Nav	SE Nav	SRI VX-Line Nav Black	GSI	Price (£) exc. VAT	Price (£) inc. VAT
Solid		Aegean Blue • Not available with Network Moonray cloth trim	●	●	●	●	●	●	●	●			
Brilliant		Mandarina • Only available with Network Moonray cloth trim								○	●		
		Lava Red	○	○	○	○	○	○	○	○	○	245.83	295.00
		Summit White	○	○	○	○	○	○	○	○	○		

The colours reproduced may vary slightly from the actual paint colour. As a result they should be used as a guide only. Your Vauxhall Retailer has a comprehensive display of our paint samples.

● = Standard equipment. ○ = Optional at extra cost.

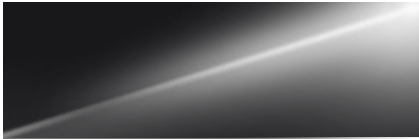

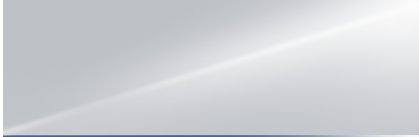
EXTERIOR COLOURS

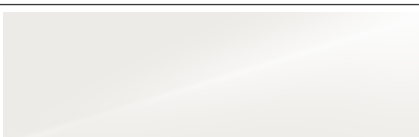

		Active	Design	Energy	Griffin	Sport	SRI Nav	SE Nav	SRI VX-Line Nav Black	GSI	Price (£) exc. VAT	Price (£) inc. VAT	
Two-coat		Mineral Black metallic										470.83	565.00
		Satin Steel Grey metallic											
		Sovereign Silver metallic											
		Persian Blue metallic											
		Darkmoon Blue premium											
Tri-coat		Abalone White Premium • 5-door models only										604.17	725.00

The colours reproduced may vary slightly from the actual paint colour. As a result they should be used as a guide only. Your Vauxhall Retailer has a comprehensive display of our paint samples.

● = Standard equipment. ○ = Optional at extra cost.







WHEELS AND TYRES

	Active	Design	Energy	Griffin	Sport	SRI Nav	SE Nav	SRI VX-Line Nav Black	GSI	Price (£) exc. VAT	Price (£) inc. VAT
 <p>15-inch structure steel wheels with styled covers</p> <ul style="list-style-type: none"> • 185/65 R 15 tyres • Emergency tyre inflation kit (in lieu of spare wheel) 		●									
 <p>15-inch alloy wheels</p> <ul style="list-style-type: none"> • 185/65 R 15 tyres • Emergency tyre inflation kit (in lieu of spare wheel) 	●	○							166.67	200.00	
 <p>16-inch silver 4-twinspoke alloy wheels</p> <ul style="list-style-type: none"> • 195/55 R 16 tyres • Emergency tyre inflation kit (in lieu of spare wheel) • Standard on SRI Nav 5-door models, no-cost option on SRI Nav 3-door models 			●		●	●					
 <p>16-inch black 4-twinspoke alloy wheels</p> <ul style="list-style-type: none"> • 195/55 R 16 tyres • Emergency tyre inflation kit (in lieu of spare wheel) • Standard on SRI Nav 3-door models, no-cost option on SRI Nav 5-door models 				●		●					

● = Standard equipment. ○ = Optional at extra cost.





WHEELS AND TYRES

	Active	Design	Energy	Griffin	Sport	SRI Nav	SE Nav	SRI VX-Line Nav Black	GSI	Price (£) exc. VAT	Price (£) inc. VAT
 <p>16-inch alloy wheels</p> <ul style="list-style-type: none"> • 195/55 R 16 tyres • Emergency tyre inflation kit (in lieu of spare wheel) 							●				
 <p>17-inch silver alloy wheels</p> <ul style="list-style-type: none"> • 215/45 R 17 tyre • Emergency tyre inflation kit (in lieu of spare wheel) 			○							341.67	410.00
 <p>17-inch Gloss black alloy wheels</p> <ul style="list-style-type: none"> • 215/45 R 17 tyres • Emergency tyre inflation kit (in lieu of spare wheel) 								●			
 <p>17-inch black multispoke alloy wheels</p> <ul style="list-style-type: none"> • 215/45 R 17 tyres • Emergency tyre inflation kit (in lieu of spare wheel) • Available as part of SE Nav Lux Pack 							○			400.00	480.00



WHEELS AND TYRES

	Active	Design	Energy	Griffin	Sport	SRI Nav	SE Nav	SRI VX-Line Nav Black	GSI	Price (£) exc. VAT	Price (£) inc. VAT
 <p>17-inch 5-spoke bi-colour alloy wheels</p> <ul style="list-style-type: none"> • 215/45 R 17 tyres • Emergency tyre inflation kit (in lieu of spare wheel) 									●		
 <p>18-inch 5-Y-spoke diamond-cut, Titan alloy wheels</p> <ul style="list-style-type: none"> • 215/40 R 18 tyres • Emergency tyre inflation kit (in lieu of spare wheel) • Available as part of GSi Plus Pack 									○	425.00	510.00
Steel emergency spare wheel (in lieu of emergency tyre inflation kit)			○		○	○	○			91.67	110.00
Full-size steel spare wheel (in lieu of emergency tyre inflation kit)	○	○								91.67	110.00



PERFORMANCE, FUEL ECONOMY AND EMISSIONS

	Performance (manufacturer's figures)				Fuel economy mpg (litres/100km) [#]			CO ₂ emissions g/km [#]	Vehicle Excise Duty*		Benefit in kind company car taxation rates - 2018/19 tax year
	Fuel Type	Wheel size (inches)	Maximum speed (mph)	Acceleration 0-62mph (sec)	Urban driving	Extra-urban driving	Combined figure		First year rate	Standard rate	
CORSA											
1.4i (75PS) 3-door	Petrol	15/16/17	101	15.5	39.2 (7.2)	57.7 (4.9)	49.6 (5.7)	131	£205	£140	27%
1.4i (75PS) 5-door	Petrol	15/16/17	101	15.5	39.8 (7.1)	58.9 (4.8)	49.6 (5.7)	130	£165	£140	27%
1.4i (90PS) 3-door	Petrol	15/16/17	109	13.2	39.2 (7.2)	58.9 (4.8)	49.6 (5.7)	131	£205	£140	27%
1.4i (90PS) 5-door	Petrol	15/16/17	109	13.2	39.2 (7.2)	58.9 (4.8)	49.6 (5.7)	130	£165	£140	27%
1.4i Turbo (100PS) Start/Stop	Petrol	16/17	115	11.0	40.4 (7.0)	58.9 (4.8)	50.4 (5.6)	128	£165	£140	26%
1.4i Turbo (150PS) Start/Stop	Petrol	17	129	8.9	36.7 (7.7)	55.4 (5.1)	47.1 (6.0)	138	£205	£140	28%
1.4i Turbo (150PS) Start/Stop	Petrol	18	129	8.9	35.3 (8.0)	51.4 (5.5)	44.1 (6.4)	147	£205	£140	30%
1.4i (90PS) 3-door automatic	Petrol	15/16/17	106	13.9	36.7 (7.7)	52.3 (5.4)	45.6 (6.2)	142	£205	£140	29%
1.4i (90PS) 5-door automatic	Petrol	15/16/17	106	13.9	34.4 (8.2)	49.6 (5.7)	42.8 (6.6)	150	£205	£140	31%

*Correct at time of publication.

[#]Fuel consumption data and CO₂ emission data are determined using the Worldwide harmonized Light vehicles Test Procedure (WLTP), and the relevant values are translated back to allow the comparability into NEDC, according to regulations R (EC) No. 715/2007, R (EU) No. 2017/1153 and R (EU) No. 2017/1151. The values do not take into account in particular use and driving conditions, equipment or options and may vary depending on the format of tyres. For more information on official fuel consumption and CO₂ emission values, please read the guidelines at <http://carfueldata.dft.gov.uk/> and for more information on WLTP please see www.vauxhall.co.uk/wltp



DIMENSIONS

CORSA	3-DOOR	5-DOOR
Loadspace Dimensions millimetres (inches)		
Maximum length (seats up)	705 (27.8)	705 (27.8)
Maximum length*	1372 (54.0)	1372 (54.0)
Maximum width	944 (37.2)	944 (37.2)
Maximum height	843 (33.2)	876 (34.5)
Luggage Capacities** litres (cu.ft.)		
Rear seat up	280 (9.9)	285 (10.0)
Rear seat down (to glassline)	750 (26.5)	710 (25.1)
Rear seat down (to roof)	1090 (38.5)	1120 (39.5)

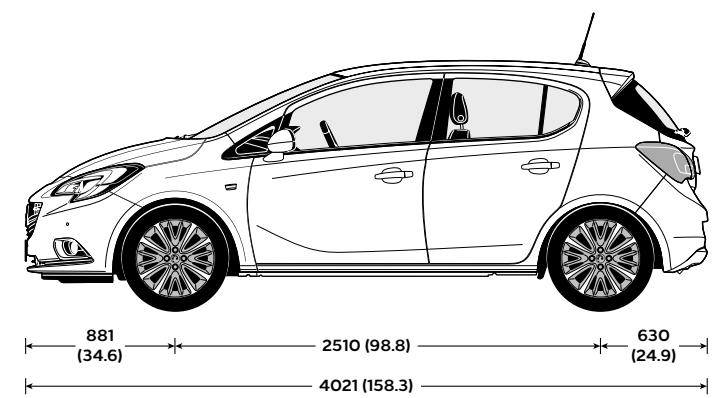
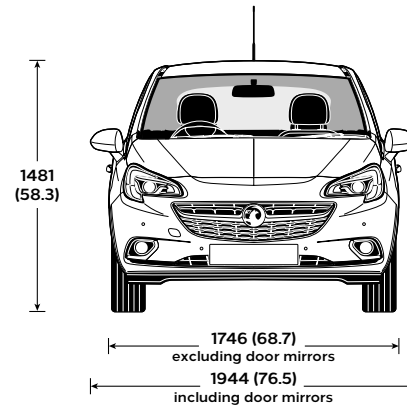
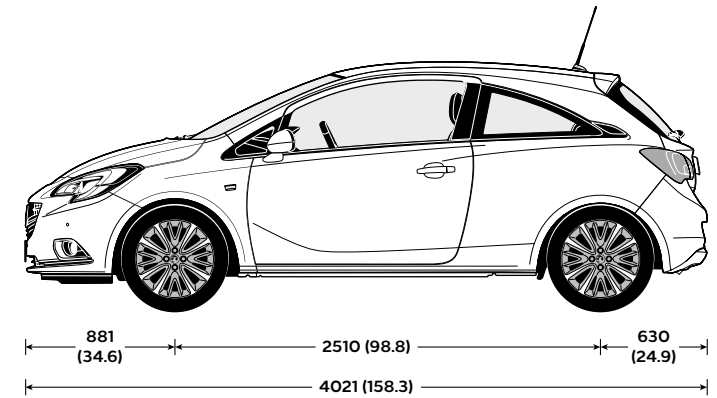
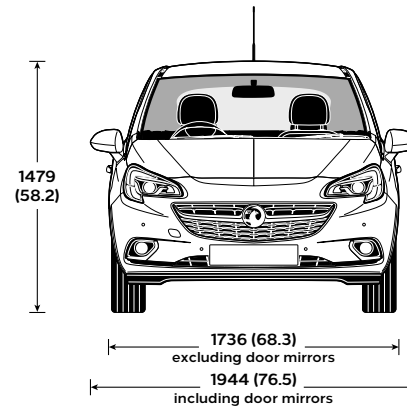

All measurements are in mm (inches) unless stated otherwise.

*Behind front seats.

**Measured using the ECIE method.



SPECIFICATIONS

Transmission

Five-speed manual gearbox:
1.4i (75PS), 1.4i (90PS) models

Six-speed manual gearbox:
1.4i Turbo (100PS), 1.4i Turbo (150PS) models

Six-speed automatic transmission with Active Select function:
Available at extra cost on certain 1.4i (90PS) models. Electronically controlled with adaptive driving function and fuel-saving eco mode. Fluid drive with torque converter, lock-up clutch and Active Select.

Suspension

Front: Independent. Lightweight MacPherson struts with gas-pressure dampers and coil springs.

Anti-roll bar.

Rear: Compound crank with coil springs and gas-pressure dampers

- Sports suspension on SRi VX-Line Nav Black, GSi models.

Body

- Aerodynamic drag co-efficient: Cd 0.33

Fuel Tank Capacity

- 45 litres (9.9 gallons)

Brakes

- Anti-lock Braking System (ABS)
- Electronic brakeforce distribution
- Emergency brake assist
- Cornering brake control
- Straight line stability control
- Dual circuit, diagonally split, dual rate servo-assisted system
- Low brake fluid level warning light

1.4i (75PS)

Front ventilated discs: 257mm diameter

Rear drums: 228mm diameter

1.4i (90PS)

Front ventilated discs: 257mm diameter

Rear drums: 228mm diameter

1.4i Turbo (100PS)

Front ventilated discs: 284mm diameter

Rear discs: 264mm diameter

1.4i Turbo (150PS)

Front ventilated discs: 308mm diameter

Rear discs: 264mm diameter

Weights and Towing Data kg

	Gross vehicle weight		Maximum towing weights Trailer with brakes (without brakes)	
	3-door	5-door	3-door	5-door
1.4i (75PS) Active	1585	-	800 (550)	-
1.4i (75PS) (excluding Active models)	1600	1620	800 (550)	800 (550)
1.4i (90PS) automatic	1630	1660	800 (550)	800 (550)
1.4i Turbo (100PS)	1680	1710	1150 (580)	1150 (580)
1.4i Turbo (150PS)	1690	-	1200 (580)	-

Please note: For Active models fitted with optional air conditioning 15kg must be added to gross vehicle weight. Gross vehicle weight is the total permissible weight of the vehicle including passengers and their luggage. The maximum roof rack loading should not exceed 75kg. The maximum towing weights are based on the ability of the car, with two occupants of 75kg each, to restart on a 12% gradient, which is approximately 1 in 8.3, at sea level. The permitted trailer load applies up to the specified incline and up to an altitude of 1000 metres above sea level. The permissible gross train weight decreases by 10% for every 1000 metres of additional altitude. At altitudes above 1500 metres, the engine output may drop with a corresponding reduction in towing capability. Any extra weight, such as luggage or additional passengers, should be deducted from the maximum towing weight. With a trailer fully loaded, maximum noseweight should not exceed 55kg. Always fit Vauxhall towing attachments and accessories available from your Vauxhall Retailer. They are designed specifically for Vauxhall models and carry a 12-month guarantee.



PETROL ENGINES

Engine	1.4i (75PS)	1.4i (90PS)	1.4i Turbo (100PS) Start/Stop
Capacity	1398cc	1398cc	1364cc
Maximum power	75PS (55kW) @ 4200-6000rpm	90PS (66kW) @ 6000rpm	100PS (74kW) @ 3500-6000rpm
Maximum torque	130Nm (96 lb.ft.) @ 4000rpm	130Nm (96 lb.ft.) @ 4000rpm	200Nm (147 lb.ft.) @ 1850-3500rpm
Configuration	4 cylinders, 4 valves per cylinder, double overhead camshafts	4 cylinders, 4 valves per cylinder, double overhead camshafts	4 cylinders, 4 valves per cylinder, double overhead camshafts
Fuel/induction system	Naturally aspirated with Variable Valve Timing. Multi-point sequential fuel injection	Naturally aspirated with Variable Valve Timing. Multi-point sequential fuel injection	Turbocharger with intercooler. Variable Valve Timing. Multi-point sequential fuel injection
Emission compliance	Euro 6d-TEMP (6.2)	Euro 6d-TEMP (6.2)	Euro 6d-TEMP (6.2)
Service interval	20,000 miles or 1 year (whichever occurs sooner)	20,000 miles or 1 year (whichever occurs sooner)	20,000 miles or 1 year (whichever occurs sooner)

Engine	1.4i Turbo (150PS) Start/Stop
Capacity	1364cc
Maximum power	150PS (110kW) @ 5000rpm
Maximum torque	220Nm (162lb.ft.) @ 2750-4500
Configuration	4 cylinders, 4 valves per cylinder, double overhead camshafts
Fuel/induction system	Turbocharger with intercooler. Variable Valve Timing. Multi-point sequential fuel injection
Emission compliance	Euro 6d-TEMP (6.2)
Service interval	20,000 miles or 1 year (whichever occurs sooner)



ACCESSORIES

CHILD SEATS ¹	Total (inc. VAT)	PRACTICAL	Total (inc. VAT)	TRANSPORT SYSTEMS	Total (inc. VAT)	ALLOY WHEELS (set of four with centre caps) ⁵	Total (inc. VAT)
BABY-SAFE ² – 0-13kg/birth to 15 months	£135.00	Spare bulb kit – ultra white	£37.00	Roof base carrier	£145.00	15-inch 8-spoke – silver	£637.00
– ISOFIX base	£234.00	Stretch tow rope – 3000kg	£34.00	Roof carriers (requires base carrier)		16-inch 4-double-spoke – white or silver	£757.00
DUO ISOFIX ² – 9-18kg/9 months to 4 years with top tether kit	£358.00	Flexible cupholder	£16.00	Bike roof carrier – Thule Freeride 532	£76.00	16-inch 4-double-spoke – black	£876.00
KID ² – 15-36kg or 4 to 12 years	£162.00	Foldable armrest with storage	£104.00	Surf board roof carrier – Thule 833	£80.00	16-inch 6-double-spoke – silver	£757.00
SAFETY		PROTECTION		Kayak roof carrier – Thule 837	£168.00	17-inch 5-twin-spoke – silver	£1,102.00
Privacy shades – rear side windows (3-dr)	£73.00	Carpet floor mats – set of four	£32.00	Ski roof carrier (400mm wide) – Thule Deluxe 726	£141.00	17-inch 8-spoke – Titan gloss	£1,058.00
Privacy shades – rear window (3-dr)	£89.00	Rubber floor mats – front pair	£38.00	Ski roof carrier (600mm wide) – Thule 739	£205.00		
Privacy shades – rear side windows (5-dr)	£91.00	Rubber floor mats – rear pair	£26.00	Hard shell roof boxes (requires base carrier)			
Parking sensors		Velour floor mats – set of four	£62.00	Thule Ocean 80			
– four fully flush front bumper mounted sensors		Cargo liner	£76.00	(320 litre / 1330 x 860 x 370mm)	£150.00		
– painted ³	£318.00	Luggage storage box – with dividers	£110.00	Thule Ocean 200			
– four fully flush rear bumper mounted sensors		Rear bumper protection foil	£56.00	(390 litre / 1750 x 820 x 450mm)	£316.00		
– painted	£318.00	Splash Guards – front and rear set ⁴	£110.00	Thule Dynamic 800			
Safety Pack – first aid kit, warning triangle, hi-visibility vest, Vauxhall bag	£36.00	Stainless steel door sills 3dr	£68.00	(320 litre / 2060 x 840 x 340mm)	£625.00		
First aid kit	£15.00	Stainless steel door sills 5dr	£68.00	Thule Dynamic 900			
Warning triangle	£17.00	Illuminated door sills 3dr	£145.00	(430 litre / 2350 x 940 x 350mm)	£750.00		
Hi-visibility vest	£9.00	STYLING		Thule Excellence			
Fire extinguisher – 2kg	£38.00	Decal Package Sport Bonnet, Roof & Tailgate		(520 litre / 2180 x 940 x 400mm)	£898.00		
Tyre sealant	£75.00	– 3dr White	£188.00	Thule Motion 800			
FLEXCONNECT RANGE		Stainless steel pedal covers – manual	£158.00	(460 litre / 2050 x 840 x 450mm)	from £452.00		
FlexConnect bracket	£21.00	Exhaust tip	£58.00	Thule Touring 200			
FlexConnect hook	£31.00	Exterior Mirror Cap Carbon Flash	£42.00	(400 litre / 1750 x 820 x 450mm)	£330.00		
FlexConnect coat hanger	£33.00			Thule Touring 780			
FlexConnect folding table	£74.00			(430 litre / 2320 x 700 x 420mm)	£370.00		
FlexConnect iPad Mini cradle	£105.00			Soft roof boxes (requires base carrier)			
FlexConnect iPad (1-4) cradle	£113.00			Thule Ranger 90			
FlexConnect iPad Air cradle	£112.00			(280 litre / 1100 x 800 x 400mm)	£285.00		
FlexConnect Samsung Galaxy cradle	£102.00			Thule Ranger 500			
				(300 litre / 1900 x 500 x 300mm)	£378.00		

Please note: Prices shown are fully fitted and painted, where applicable and include VAT. Please check with your local Vauxhall Retailer for details. It is advisable to ensure your insurance policy is adequate to cover additional fitted accessories. Prices correct at time of publication.

1 = Restrictions apply to the use of child seats, please consult your Vauxhall Retailer or request a copy of the Child seats brochure. 2 = Without transponder. 3 = For use in conjunction with rear parking sensors. 4 = Not available with certain exterior styling accessories. 5 = Fitting time is based on four wheels fitted and includes static wheel balancing. Different tyres and locking wheel nuts may be required. Price excludes new tyres and locking wheel nuts.



COMPANY CAR DRIVER AND FLEET INFORMATION

Design and Tech Line High Spec Low P11D

Specifically developed for businesses and company car drivers alike, our Design and Tech Line models are seriously fit for Fleet.

Design models all feature very low P11D values, generous standard specification with a choice of high tech ecoTEC engines for great fuel economy and low emissions.

For even more standard specification, step up to our Tech Line range again you are guaranteed low P11D values, plus great standard kit including Sat Nav, Bluetooth®, USB connection and digital radio. With Design and Tech Line you can take for granted low Whole Life Costs and low company car driver taxation.

Company Car Driver Free 3 Day Test Drive

Our free* 3 Day Test Drive programme is open to all Company Car Drivers which allows you to choose any model in the current Vauxhall line-up (exclusions apply). With full insurance cover provided, it gives you a meaningful length of time to make an informed decision about your next company car.

Click below to book your free* test drive www.vauxhall3dtd.co.uk or call **0330 587 8221****

*The free 3 Day Test Drive programme is open to Company Car Drivers and Fleet Decision Makers. Available for UK Mainland only. Terms and conditions apply. Full terms and conditions can be found at vauxhallfleet.co.uk/testdrive/index/terms.

**Telephone lines open Monday to Friday 9:00am to 5:00pm excluding Bank Holidays. Calls may be recorded or monitored for quality and/or training purposes.

Benefit in kind company car taxation†

The car benefit charge will be the car's list price (including VAT, options and accessories fitted, delivery to Retailer and number plates, but excluding Vehicle Excise Duty and new vehicle first registration fee) multiplied by the percentage charge for the CO₂ emissions band in which the car falls (see table opposite). Multiply this figure by your personal income tax rate (20%†† for Basic Rate, 40%†† for Higher Rate) to calculate your annual benefit in kind tax liability.

Example:

Corsa SE Nav 1.4i Turbo (100PS) Start/Stop 5-door hatchback (CO₂ emissions 128g/km)

On-the-road RRP	£16,640.00
Deduct: Vehicle Excise Duty	(£165.00)
New vehicle first registration fee	(£55.00)
Effective list price	£16,420.00
Add: Optional two-coat metallic paint	£565.00
List price for tax purposes (P11D value)	£16,985.00
Car benefit charge 2018-19 tax year (26%)	£4,416.00
Benefit in kind tax liability (2018-19 tax year)	
Basic Rate (20%) tax payer	£883.20
Higher Rate (40%) tax payer	£1,766.40

†Please note this Price Guide provides taxation information as a guide only. Vauxhall does not provide taxation guidance. Drivers should always take professional advice on their own tax position. ††Excludes residents of Scotland.

BIK FOR SCOTTISH RESIDENTS

Effective 6 April 2018 the Scottish Government have introduced their own BIK taxation structure. This only applies to Company Car Drivers that are Scottish taxpayers. HMRC will determine whether or not an individual is a Scottish taxpayer based on where their main place of residence is.

The BIK rates for Scotland are:

- Over £11,850-£13,850 Starter Rate 19%
- Over £13,850-£24,000 Basic Rate 20%
- Over £24,000-£43,430 Intermediate Rate 21%
- Over £43,430-£150,000 Higher Rate 41%
- Above £150,000 Top Rate 46%

Benefit in kind company car taxation table

CO ₂ emissions in grams per kilometre	Percentage of cars price to be taxed	
	Non-Diesel† 2018-19 tax year	Diesel†† 2018-19 tax year
Up to 50	13	17
51-75	16	20
76-94	19	23
95-99	20	24
100-104	21	25
105-109	22	26
110-114	23	27
115-119	24	28
120-124	25	29
125-129	26	30
130-134	27	31
135-139	28	32
140-144	29	33
145-149	30	34
150-154	31	35
155-159	32	36
160-164	33	37
165-169	34	37
170-174	35	37
175-179	36	37
180 and above	37	37

†Also applies to diesel vehicles that meet the Real Driving Emissions Step 2 (RDE2). ††Applies to vehicles that do not meet the Real Driving Emissions Step 2 (RDE2).

To calculate your own personal liability a car tax calculator is available at:

<https://www.vauxhallfleet.co.uk/toolbox>

Fleet Toolbox

Discover the facts in our online Toolbox for both Company Car Drivers and Fleet Decision Makers. The Fleet Toolbox has a host of useful calculators, comparators, interactive listings and information. Visit the Fleet Toolbox by going to www.vauxhall-toolbox.co.uk

RoadTrip App

The Vauxhall RoadTrip App is a free app that calculates and logs your mileage expenses for any UK business trips and generates reports to help you complete your mileage claims. Available for both iPhone and Android, visit www.vauxhall-toolbox.co.uk or visit the iPhone or Android stores and search for Vauxhall RoadTrip to download it to your smartphone or tablet.

Contact Vauxhall Fleet

Please contact one of our dedicated sales teams who will be happy to help with your particular enquiry.

Company Car Drivers

Call: **0345 111 2020**

Email: company-car@vauxhallinfo.co.uk

Telephone lines are open

– Monday to Friday 8:00am–9:00pm

– Saturday and Sunday 9:00am–6:00pm

Fleet Decision Makers

Depending on the size of your fleet of vehicles, we have a dedicated team to handle your enquiries.

The lines are open Monday to Friday excluding Bank Holidays.

1-24 vehicles

Call: **0845 076 2254** (8:30am–5:00pm)

Email: b2bsales@vauxhall.co.uk

25+ vehicles

Call: **0330 587 8222** (8:30am–5:00pm)

Email: vauxhallfleet@vauxhall.co.uk

Special Vehicles (Police, Fire and Ambulance)

Call: **01582 409999** (8:30am–5:00pm)

Email: vauxhallspecialvehicles@vauxhall.co.uk



FURTHER INFORMATION

On-the-road prices

To eliminate uncertainty about hidden costs when buying a new car, Vauxhall publishes on-the-road recommended retail prices (RRP) and these are shown in the pricing tables within this price guide. These prices include VAT, number plates and delivery to Retailer of £700.00 (including £116.67 VAT), 12 months' Government Vehicle Excise Duty (see opposite for details) and the DVLA new vehicle first registration fee of £55.00.*

Please note: The on-the-road recommended retail price (RRP) does not include fuel supplied by the Retailer, motor insurance or any other goods or services supplied by agreement between the Retailer and the customer.

Price protection

Order a new Vauxhall for build in the current model year (as confirmed by your Retailer) for delivery no more than three months in advance and the price you are quoted is the price you pay. This is irrespective of any subsequent price rises between placing your order and delivery of your new car, but you must take delivery as soon as the car is available. Vauxhall Motors Limited is not liable for price adjustments caused by Government changes in the rate of VAT (currently 20%), Vehicle Excise Duty, DVLA new vehicle first registration fee or by any other applicable legislation or regulations.

Vauxhall Finance Leasing

Vauxhall Finance Leasing is a trading style of Vauxhall Finance plc. Working with the Vauxhall Retailer network we provide competitive car and van leasing solutions for business users and private individuals. We combine the support of a national contract with the convenience of a local contact. For further information, please contact your local Vauxhall Retailer or visit www.vauxhall.co.uk/leasing

In the event of an accident

Vauxhall Accident Management helps keep you mobile following an accident. Benefits include vehicle recovery, Vauxhall-approved repairs and contacting your insurer. For more details, visit www.vauxhall.co.uk/AccidentManagement

Vehicle Excise Duty

The amount of Vehicle Excise Duty (road fund licence) payable on new cars varies depending on the level of carbon dioxide (CO₂) emissions produced by the vehicle. CO₂ emissions are measured in grams per kilometre (g/km) travelled and divided into 13 charging bands shown in the table opposite.

A 'first year rate' of Vehicle Excise Duty is payable on all new cars and in subsequent years the amount payable reverts to the 'standard rate'. From 1 April 2017 the breakpoints for each of these bands have been revised. Also, for vehicles with a list price over £40,000, including factory-fitted options, an additional £310 is payable for the first five years of standard rate payments.

Vehicle Excise Duty*

Band	CO ₂ emissions in grams per kilometre	First year rate		
		Petrol [#]	Diesel [†]	Standard rate
A	0	£0	£0	£0
B	1-50	£10	£25	£140
C	51-75	£25	£105	£140
D	76-90	£105	£125	£140
E	91-100	£125	£145	£140
F	101-110	£145	£165	£140
G	111-130	£165	£205	£140
H	131-150	£205	£515	£140
I	151-170	£515	£830	£140
J	171-190	£830	£1,240	£140
K	191-225	£1,240	£1,760	£140
L	226-255	£1,760	£2,070	£140
M	over 255	£2,070	£2,070	£140

Tyre Rating

Tyre size	Fuel efficiency group	Wet grip performance	External noise	
			Measured (dB)	Group
185/65 R 15	B-C	B	69-70	
195/55 R 16	B-C	B	68-71	
215/45 R 17	C	B	71	

Tyre rating according to EU Regulation 1222/2009

*Correct at time of issue.

[#]Also applies to diesel vehicles that meet the Real Driving Emissions Step 2 (RDE2).

[†]Applies to vehicles that do not meet the Real Driving Emissions Step 2 (RDE2).



FURTHER INFORMATION

Insurance Groups*

	Active	Design	Energy	Griffin	Sport	SRi Nav	SE Nav	SRi VX-Line Nav Black	GSi
1.4i (75PS)	3E	3E	3E	4E	4E	4E	4E	4E	-
1.4i (90PS)	-	6E	6E	7E	7E	8E	7E	8E	-
1.4i (90PS) automatic	-	6E	6E	-	-	7E	7E	-	-
1.4i Turbo (100PS) S/S	-	-	11E	-	-	11E	11E	-	-
1.4i Turbo (150PS) S/S	-	-	-	-	-	-	-	-	20E



FURTHER INFORMATION

Customer Care Commitment

For added peace of mind, Vauxhall has an innovative Customer Care Commitment that offers the following:

- Three-year vehicle warranty consisting of a one-year/unlimited mileage manufacturer's warranty and a second and third year manufacturer's warranty with a 60,000 miles limitation
- Vauxhall Assistance for 12 months from first registration
- Six years' body panel anti-perforation warranty

Please note: Warranty is only available on vehicles sourced from Vauxhall Motors Limited. Terms and conditions apply. Please see your Vauxhall Retailer for details.

Vauxhall Assistance

Vauxhall Assistance is provided automatically with every new Vauxhall for 12 months from first registration and covers everything from accident assistance, roadside recovery and 'at home' service to flat tyres. With Vauxhall Assistance help is literally just a free* phone call away, 24 hours a day, 365 days a year!

*Mobile phone users will be charged at their standard tariff.

Protecting the environment

Vauxhall's commitment to the environment is demonstrated by our products' many environmental awards. For even more information on Vauxhall's efforts to achieve an environmentally sustainable future, and how to dispose of your end-of-life vehicle, see www.vauxhall.co.uk/recycling

Vauxhall Service Plan

- Fixed monthly payments for the plan duration
- Easy to budget and interest-free
- Genuine parts fitted by Vauxhall-trained technicians
Plus on Gold plans:
- Valet and courtesy car
- Full AA cover
- Engine flush and fuel treatments
- Litre of oil for top ups between services

Full details can be obtained from your local participating Vauxhall Retailer.

Vauxhall Insurance with added reassurance

Comprehensive cover – Summary of benefits**

- Competitive premiums
- Repairs by a Vauxhall-trained technician
- Genuine Vauxhall parts, guaranteed for three years when we repair your car within our Approved Repairer Network
- Free courtesy car as standard when using an Approved Repairer†
- 24 hour claims helpline
- Personal Accident benefit
- Cover for audio equipment
- Windscreen cover

Call for a quote on **0844 463 2670**††

**The benefits listed above are for comprehensive cover only. For details of Third Party, Fire and Theft cover, please call our sales team.

†Should your car need repairing following an accident we provide a courtesy car (subject to availability) for the duration of the repair. Only genuine Vauxhall parts are used. Terms and conditions apply.

††Calls may be recorded. Vauxhall Insurance is underwritten by Ageas Insurance Limited.

For more product information

For a brochure on any Vauxhall model (up to a maximum of three per caller) or location of your nearest Vauxhall Retailer please call **0345 600 1500**. Alternatively, details can be found on our website at www.vauxhall.co.uk

Join us online



VAUXHALL

vauxhall.co.uk

©2018 Vauxhall Motors Limited

Published 24 October 2018 Vauxhall Motors Limited