



CORSA

Price and Specification Guide | 28 January 2019 | Model Year 2019.5



VAUXHALL
British Brand since 1903



CONTENTS

RANGE HIGHLIGHTS

Explore the Corsa range and find your perfect model.

MODELS

Find all the information you need about your chosen model.

PRICES

Find on-the-road recommended retail prices.

FEATURES/OPTIONS

Tailor your chosen model to suit your needs with everything from a satellite navigation to rear-view camera and parking sensors.

EXTERIOR COLOURS

Add some sparkle to your car with a metallic paint.

WHEELS AND TYRES

Why not upgrade to a set of distinctive alloy wheels to give your car more presence.

PERFORMANCE, FUEL ECONOMY AND EMISSIONS

Know how many miles you will get around town, the CO₂ figures and the 0–60 time.

DIMENSIONS

Ensure your car will fit in the garage and know how much luggage you can take for a long weekend away.

SPECIFICATIONS

Towing weights, engine details and other useful details you may need to know.

ACCESSORIES

Add some practical touches to your car with our range of quality accessories.

COMPANY CAR INFORMATION

Benefit in Kind company car tax, 3 day test drives and P11D.

FURTHER INFORMATION

Insurance groups, vehicle excise duty, our range of additional products and much more.



CORSA RANGE HIGHLIGHTS



STANDARD FEATURES

Standard features include:

Infotainment:

- Six speakers

Interior convenience / styling:

- Cruise control
- Speed-sensitive power-assisted steering
- Steering column adjustable for reach / rake
- Steering wheel audio / phone / cruise controls
- Driver's seat height adjuster

Exterior convenience / styling:

- Heated windscreen
- Remote control central locking
- Electrically operated front windows
- Electrically adjustable door mirrors
- Black B-pillars (with certain exterior colours)

Safety / security features:

- Electronic Stability Programme (ESP)
- Anti-lock Braking System (ABS)
- Six airbags
- Hill start assist
- Seatbelt reminders for all seats
- ISOFIX child seat mounting points on outer rear seats
- Tyre pressure monitoring system
- Daytime running lights
- Engine deadlock immobiliser

ACTIVE

OTR from £11,730

Additional over standard features:

Infotainment:

- CD 30 BT audio system
 - AM/FM radio
 - CD/MP3 CD player
 - Bluetooth® mobile phone portal
 - USB audio connection
 - Aux-in socket

Interior convenience / styling:

- Leather-covered steering wheel

Exterior convenience / styling:

- 15-inch silver 8-spoke alloy wheels

DESIGN

OTR from £13,460

Additional over standard features:

Infotainment:

- IntelliLink audio system
 - 7-inch colour touchscreen
 - AM/FM/DAB digital radio
 - Bluetooth® audio streaming
 - Bluetooth® mobile phone portal
 - Apple CarPlay™ / Android Auto™
 - USB audio connection

Interior convenience / styling:

- Air conditioning
- Leather-covered steering wheel

Exterior convenience / styling:

- Front fog lights
- 15-inch structure steel wheels with styled wheel covers

Safety / security features:

- LED daytime running lights

ENERGY

OTR from £14,820

Additional over standard features:

Infotainment:

- IntelliLink audio system
 - 7-inch colour touchscreen
 - AM/FM/DAB digital radio
 - Bluetooth® audio streaming
 - Bluetooth® mobile phone portal
 - Apple CarPlay™ / Android Auto™
 - USB audio connection

Interior convenience / styling:

- Air conditioning
- Heated leather-covered steering wheel
- Heated front seats

Exterior convenience / styling:

- Electrically adjustable / heated door mirrors
- Automatic lighting control
- Rain-sensitive windscreen wipers
- Front fog lights
- 16-inch silver 4-twinspoke alloy wheels

Safety / security features:

- LED daytime running lights



CORSA RANGE HIGHLIGHTS



STANDARD FEATURES

Standard features include:

Infotainment:

- Six speakers

Interior convenience / styling:

- Cruise control
- Speed-sensitive power-assisted steering
- Steering column adjustable for reach / rake
- Steering wheel audio / phone / cruise controls
- Driver's seat height adjuster

Exterior convenience / styling:

- Heated windscreen
- Remote control central locking
- Electrically operated front windows
- Electrically adjustable door mirrors
- Black B-pillars (with certain exterior colours)

Safety / security features:

- Electronic Stability Programme (ESP)
- Anti-lock Braking System (ABS)
- Six airbags
- Hill start assist
- Seatbelt reminders for all seats
- ISOFIX child seat mounting points on outer rear seats
- Tyre pressure monitoring system
- Daytime running lights
- Engine deadlock immobiliser

GRIFFIN

OTR from £12,420

Additional over standard features:

Infotainment:

- Navi 4.0 IntelliLink satellite navigation system
 - Fully integrated European satellite navigation system
 - 7-inch colour touchscreen
 - AM/FM/DAB digital radio
 - Bluetooth® audio streaming
 - Bluetooth® mobile phone portal
 - Apple CarPlay™ / Android Auto™
 - USB audio connection

Interior convenience / styling:

- Air conditioning
- Auto anti-dazzle rear-view mirror
- Sports-style heated front seats
- Leather-covered heated steering wheel
- Front and rear floor mats (front Griffin-branded)

Exterior convenience / styling:

- Roof / door mirrors / front grille bar in black
- Auto lighting / windscreen wipers
- 16-inch black 4-twin spoke alloy wheels
- Dark-tinted rear windows
- Front fog lights

Safety / security features:

- LED daytime running lights

Colours and model variants for Griffin special edition subject to availability. Please check with your Vauxhall Retailer.

SPORT

OTR from £15,800

Additional over standard features:

Infotainment:

- IntelliLink audio system
 - 7-inch colour touchscreen
 - AM/FM/DAB digital radio
 - Bluetooth® audio streaming
 - Bluetooth® mobile phone portal
 - Apple CarPlay™ / Android Auto™
 - USB audio connection

Interior convenience / styling:

- Air conditioning
- Leather-covered steering wheel
- Sports-style front seats
- Alloy-effect sports pedals

Exterior convenience / styling:

- Electrically adjustable / heated door mirrors
- Dark-tinted rear windows
- 16-inch silver 4-twin spoke alloy wheels

Safety / security features:

- LED daytime running lights

SRI NAV

OTR from £16,800

Additional over standard features:

Infotainment:

- Navi 4.0 IntelliLink satellite navigation system
 - Fully integrated European satellite navigation system
 - 7-inch colour touchscreen
 - AM/FM/DAB digital radio
 - Bluetooth® audio streaming
 - Bluetooth® mobile phone portal
 - Apple CarPlay™ / Android Auto™
 - USB audio connection

Interior convenience / styling:

- Air conditioning
- Leather-covered steering wheel
- Sports-style front seats

Exterior convenience / styling:

- Rain-sensitive windscreen wipers
- Automatic lighting control
- Electrically adjustable / heated door mirrors
- Front fog lights with chrome-effect surround
- 16-inch black 4-twin spoke alloy wheels (3-door)
 - no-cost option on 5-door models
- 16-inch silver 4-twin spoke alloy wheels (5-door)
 - no-cost option on 3-door models

Safety / security features:

- LED daytime running lights



CORSA RANGE HIGHLIGHTS



STANDARD FEATURES

Standard features include:

Infotainment:

- Six speakers

Interior convenience / styling:

- Cruise control
- Speed-sensitive power-assisted steering
- Steering column adjustable for reach / rake
- Steering wheel audio / phone / cruise controls
- Driver's seat height adjuster

Exterior convenience / styling:

- Heated windscreen
- Remote control central locking
- Electrically operated front windows
- Electrically adjustable door mirrors
- Black B-pillars (with certain exterior colours)

Safety / security features:

- Electronic Stability Programme (ESP)
- Anti-lock Braking System (ABS)
- Six airbags
- Hill start assist
- Seatbelt reminders for all seats
- ISOFIX child seat mounting points on outer rear seats
- Tyre pressure monitoring system
- Daytime running lights
- Engine deadlock immobiliser

SE NAV

OTR from £15,870

Additional over standard features:

Infotainment:

- Navi 4.0 IntelliLink satellite navigation system
 - Fully integrated European satellite navigation system
 - 7-inch colour touchscreen
 - AM/FM/DAB digital radio
 - Bluetooth® audio streaming
 - Bluetooth® mobile phone portal
 - Apple CarPlay™ / Android Auto™
 - USB audio connection

Interior convenience / styling:

- Air conditioning
- Auto anti-dazzle rear-view mirror
- Multi-function trip computer
- Heated leather-covered steering wheel
- Heated front seats
- Graphic Embossed cloth/premium leather-effect trim
- 60/40 split-folding rear seat back

Exterior convenience / styling:

- Auto lighting / windscreen wipers
- Electrically adjustable / heated door mirrors
- Front / rear parking sensors
- Front fog lights
- Chrome-effect lower side window mouldings (5-door only)
- 16-inch multi-spoke alloy wheels

SRi VX-LINE Nav Black

OTR from £17,490

Additional over standard features:

Infotainment:

- Navi 4.0 IntelliLink satellite navigation system
 - Fully integrated European satellite navigation system
 - 7-inch colour touchscreen
 - AM/FM/DAB digital radio
 - Bluetooth® audio streaming
 - Bluetooth® mobile phone portal
 - Apple CarPlay™ / Android Auto™
 - USB audio connection

Interior convenience / styling:

- Air conditioning
- Auto anti-dazzle rear-view mirror
- Sports-style front seats
- VX-Line styling: Leather-covered flat-bottom steering wheel / gear knob / handbrake lever

Exterior convenience / styling:

- Auto lighting / windscreen wipers
- VX-Line body styling: Front lower spoiler / side sills / rear skirt / VXR rear roof spoiler (3-door only)
- Roof / door mirrors / front grille bar in black
- Dark-tinted rear windows
- Sports suspension
- Front fog lights
- 17-inch black alloy wheels

GSi

OTR from £19,440

Additional over standard features:

Infotainment:

- IntelliLink audio system
 - 7-inch colour touchscreen
 - AM/FM/DAB digital radio
 - Bluetooth® audio streaming
 - Bluetooth® mobile phone portal
 - Apple CarPlay™ / Android Auto™
 - USB audio connection

Interior convenience / styling:

- Air conditioning
- Sports-style front seats
- GSi styling: Leather-covered flat-bottom steering wheel / gear knob / handbrake lever

Exterior convenience / styling:

- GSi body styling: Front lower spoiler / side sills / rear skirt / rear roof spoiler
- Carbon-effect door mirrors / front grille bar
- Dark-tinted rear windows
- Sports suspension
- 17-inch 5-spoke bi-colour alloy wheels



ACTIVE



ACTIVE ON-THE-ROAD PRICES

| | | 3-door hatchback | |
|--------|-------------|------------------|------------------------|
| | | OTR RRP | CO ₂ (g/km) |
| Petrol | 1.4i (75PS) | £11,730 | 128 |

Please note: On-the-road recommended retail prices (RRP) include VAT at 20%, number plates and delivery to Retailer of £700.00 (inc. £116.67 VAT), 12 months' Vehicle Excise Duty and new vehicle first registration fee of £55.00. Excludes fuel and insurance.

FEATURES

Infotainment:

- CD 30 BT audio system
 - AM/FM radio
 - CD/MP3 CD player
 - Bluetooth® mobile phone portal
 - USB audio connection
 - Aux-in socket
- Six speakers

Interior convenience / styling:

- Cruise control
- Leather-covered steering wheel
- Speed-sensitive power-assisted steering
- Steering column adjustable for reach / rake
- Steering wheel audio / phone / cruise controls
- Driver's seat height adjuster

Exterior convenience / styling:

- Heated windscreen
- Remote control central locking
- Electrically operated front windows
- Electrically adjustable door mirrors
- Black B-pillars (with certain exterior colours)
- 15-inch silver 8-spoke alloy wheels

Safety / security features:

- Electronic Stability Programme (ESP)
- Anti-lock Braking System (ABS)
- Six airbags
- Hill start assist
- Seatbelt reminders for all seats
- ISOFIX child seat fixings on outer rear seats
- Tyre pressure monitoring system
- Daytime running lights
- Engine deadlock immobiliser



DESIGN



DESIGN ON-THE-ROAD PRICES

| | | 3-door hatchback | | 5-door hatchback | |
|--------|-----------------------|------------------|------------------------|------------------|------------------------|
| | | OTR RRP | CO ₂ (g/km) | OTR RRP | CO ₂ (g/km) |
| Petrol | 1.4i (75PS) | £13,460 | 128 | £14,020 | 128 |
| | 1.4i (90PS) | - | - | £14,260 | 128 |
| | 1.4i (90PS) automatic | - | - | £15,670 | 143 |

Please note: On-the-road recommended retail prices (RRP) include VAT at 20%, number plates and delivery to Retailer of £700.00 (inc. £116.67 VAT), 12 months' Vehicle Excise Duty and new vehicle first registration fee of £55.00. Excludes fuel and insurance.

FEATURES

Infotainment:

- IntelliLink audio system
 - 7-inch colour touchscreen
 - AM/FM/DAB digital radio
 - Bluetooth® audio streaming
 - Bluetooth® mobile phone portal
 - Apple CarPlay™ / Android Auto™
 - USB audio connection
- Six speakers

Interior convenience / styling:

- Air conditioning
- Cruise control
- Leather-covered steering wheel
- Speed-sensitive power-assisted steering
- Steering column adjustable for reach / rake
- Steering wheel audio / phone / cruise controls
- Driver's seat height adjuster

Exterior convenience / styling:

- Heated windscreen
- Remote control central locking
- Electrically operated front windows
- Electrically adjustable door mirrors
- Front fog lights
- Black B-pillars (with certain exterior colours)
- 15-inch structure steel wheels with styled wheel covers

Safety / security features:

- Electronic Stability Programme (ESP)
- Anti-lock Braking System (ABS)
- Six airbags
- Hill start assist
- Seatbelt reminders for all seats
- ISOFIX child seat fixings on outer rear seats
- Tyre pressure monitoring system
- LED daytime running lights
- Engine deadlock immobiliser



ENERGY



ENERGY ON-THE-ROAD PRICES

| | | 3-door hatchback | | 5-door hatchback | |
|--------|------------------------|------------------|------------------------|------------------|------------------------|
| | | OTR RRP | CO ₂ (g/km) | OTR RRP | CO ₂ (g/km) |
| Petrol | 1.4i (75PS) | £14,820 | 128 | £15,380 | 128 |
| | 1.4i (90PS) | £15,070 | 128 | £15,630 | 128 |
| | 1.4i (90PS) automatic | £16,430 | 136 | £17,030 | 143 |
| | 1.4i Turbo (100PS) S/S | - | - | £16,240 | 125 |

Please note: On-the-road recommended retail prices (RRP) include VAT at 20%, number plates and delivery to Retailer of £700.00 (inc. £116.67 VAT), 12 months' Vehicle Excise Duty and new vehicle first registration fee of £55.00. Excludes fuel and insurance.

S/S = Start/Stop.

FEATURES

Infotainment:

- IntelliLink audio system
 - 7-inch colour touchscreen
 - AM/FM/DAB digital radio
 - Bluetooth® audio streaming
 - Bluetooth® mobile phone portal
 - Apple CarPlay™ / Android Auto™
 - USB audio connection
- Six speakers

Interior convenience / styling:

- Air conditioning
- Heated leather-covered steering wheel
- Heated front seats
- Cruise control
- Speed-sensitive power-assisted steering
- Steering column adjustable for reach / rake
- Steering wheel audio / phone / cruise controls
- Driver's seat height adjuster

Exterior convenience / styling:

- Heated windscreen
- Remote control central locking
- Electrically operated front windows
- Electrically adjustable / heated door mirrors
- Automatic lighting control
- Rain-sensitive windscreen wipers
- Front fog lights
- Black B-pillars (with certain exterior colours)
- 16-inch silver 4-twinspoke alloy wheels

Safety / security features:

- Electronic Stability Programme (ESP)
- Anti-lock Braking System (ABS)
- Six airbags
- Hill start assist
- Seatbelt reminders for all seats
- ISOFIX child seat fixings on outer rear seats
- Tyre pressure monitoring system
- LED daytime running lights
- Engine deadlock immobiliser



GRIFFIN



GRIFFIN ON-THE-ROAD PRICES

| | | 3-door hatchback | | 5-door hatchback | |
|--------|-------------|------------------|------------------------|------------------|------------------------|
| | | OTR RRP | CO ₂ (g/km) | OTR RRP | CO ₂ (g/km) |
| Petrol | 1.4i (75PS) | £12,420 | 128 | £12,980 | 128 |
| | 1.4i (90PS) | £12,670 | 128 | £13,230 | 128 |

Please note: On-the-road recommended retail prices (RRP) include VAT at 20%, number plates and delivery to Retailer of £700.00 (inc. £116.67 VAT), 12 months' Vehicle Excise Duty and new vehicle first registration fee of £55.00. Excludes fuel and insurance.

Colours and model variants for Griffin special edition subject to availability. Please check with your Vauxhall Retailer.



FEATURES

Infotainment:

- Navi 4.0 IntelliLink satellite navigation system
 - Fully integrated European satellite navigation system
 - 7-inch colour touchscreen
 - AM/FM/DAB digital radio
 - Bluetooth® audio streaming
 - Bluetooth® mobile phone portal
 - Apple CarPlay™ / Android Auto™
 - USB audio connection
- Six speakers

Interior convenience / styling:

- Air conditioning
- Sports-style heated front seats
- Leather-covered heated steering wheel
- Multi-function trip computer
- Cruise control
- Speed-sensitive power-assisted steering
- Steering column adjustable for reach / rake
- Steering wheel audio / phone / cruise controls
- Driver's seat height adjuster
- Front and rear floor mats (front Griffin-branded)

Exterior convenience / styling:

- Automatic lighting control
- Rain-sensitive windscreen wipers
- Roof / door mirrors / front grille bar in black
- Heated windscreen
- Remote control central locking
- Electrically operated front windows
- Dark-tinted rear windows
- Front fog lights
- 16-inch black alloy wheels

Safety / security features:

- Electronic Stability Programme (ESP)
- Anti-lock Braking System (ABS)
- Six airbags
- Hill start assist
- Seatbelt reminders for all seats
- ISOFIX child seat fixings on outer rear seats
- Tyre pressure monitoring system
- LED daytime running lights



SPORT



SPORT ON-THE-ROAD PRICES

| | | 3-door hatchback | | 5-door hatchback | |
|--------|-------------|------------------|------------------------|------------------|------------------------|
| | | OTR RRP | CO ₂ (g/km) | OTR RRP | CO ₂ (g/km) |
| Petrol | 1.4i (75PS) | £15,800 | 128 | £16,360 | 128 |
| | 1.4i (90PS) | £16,040 | 128 | £16,600 | 128 |

Please note: On-the-road recommended retail prices (RRP) include VAT at 20%, number plates and delivery to Retailer of £700.00 (inc. £116.67 VAT), 12 months' Vehicle Excise Duty and new vehicle first registration fee of £55.00. Excludes fuel and insurance.

FEATURES

Infotainment:

- IntelliLink audio system
 - 7-inch colour touchscreen
 - AM/FM/DAB digital radio
 - Bluetooth® audio streaming
 - Bluetooth® mobile phone portal
 - Apple CarPlay™ / Android Auto™
 - USB audio connection

- Six speakers

Interior convenience / styling:

- Air conditioning
- Leather-covered steering wheel
- Cruise control
- Steering column adjustable for reach / rake
- Steering wheel audio / phone / cruise controls
- Sports-style front seats
- Alloy-effect sports pedals
- Driver's seat height adjuster

Exterior convenience / styling:

- Heated windscreen
- Electrically adjustable / heated door mirrors
- Black B-pillars (with certain exterior colours)
- Dark-tinted rear windows
- 16-inch silver 4-twinspoke alloy wheels

Safety / security features:

- Electronic Stability Programme (ESP)
- Anti-lock Braking System (ABS)
- Six airbags
- Hill start assist
- ISOFIX child seat fixings on outer rear seats
- Tyre pressure monitoring system
- LED daytime running lights
- Engine deadlock immobiliser



SRI NAV

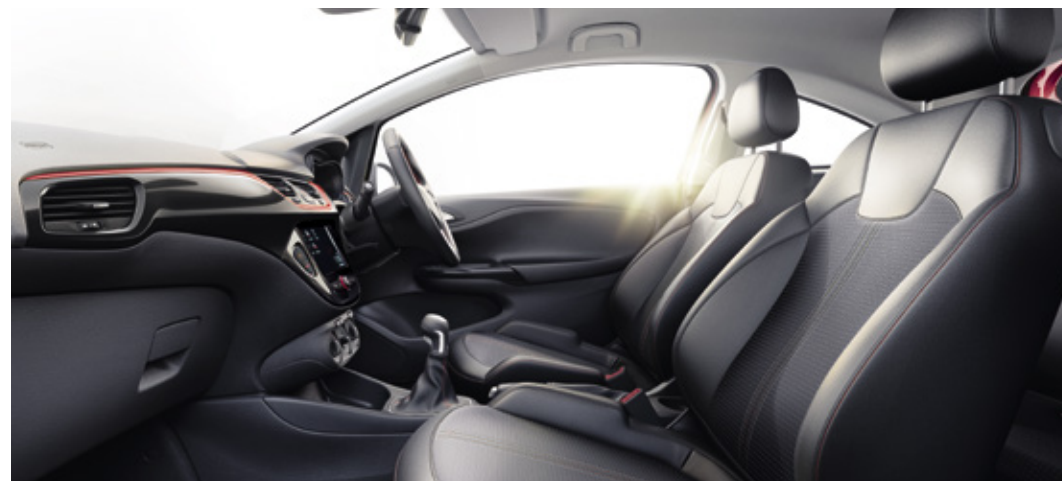

SRI NAV ON-THE-ROAD PRICES

| | | 3-door hatchback | | 5-door hatchback | |
|--------|------------------------|------------------|------------------------|------------------|------------------------|
| | | OTR RRP | CO ₂ (g/km) | OTR RRP | CO ₂ (g/km) |
| Petrol | 1.4i (75PS) | £16,800 | 128 | £17,360 | 128 |
| | 1.4i (90PS) | £17,040 | 128 | £17,600 | 128 |
| | 1.4i (90PS) automatic | - | - | £19,010 | 143 |
| | 1.4i Turbo (100PS) S/S | £17,910 | 125 | £18,510 | 125 |

Please note: On-the-road recommended retail prices (RRP) include VAT at 20%, number plates and delivery to Retailer of £700.00 (inc. £116.67 VAT), 12 months' Vehicle Excise Duty and new vehicle first registration fee of £55.00. Excludes fuel and insurance.

S/S = Start/Stop.

FEATURES

Infotainment:

- Navi 4.0 IntelliLink satellite navigation system
 - Fully integrated European satellite navigation system
 - 7-inch colour touchscreen
 - AM/FM/DAB digital radio
 - Bluetooth® audio streaming
 - Bluetooth® mobile phone portal
 - Apple CarPlay™ / Android Auto™
 - USB audio connection
- Six speakers

Interior convenience / styling:

- Air conditioning
- Leather-covered steering wheel
- Cruise control
- Steering column adjustable for reach / rake
- Steering wheel audio / phone / cruise controls
- Sports-style front seats
- Driver's seat height adjuster

Exterior convenience / styling:

- Heated windscreen
- Rain-sensitive windscreen wipers
- Automatic lighting control
- Electrically adjustable / heated door mirrors
- Front fog lights with chrome-effect surround
- Black B-pillars (with certain exterior colours)
- 16-inch black 4-twinspoke alloy wheels (3-door)
 - no-cost option on 5-door models
- 16-inch silver 4-twinspoke alloy wheels (5-door)
 - no-cost option on 3-door models

Safety / security features:

- Electronic Stability Programme (ESP)
- Anti-lock Braking System (ABS)
- Six airbags
- Hill start assist
- ISOFIX child seat fixings on outer rear seats
- Tyre pressure monitoring system
- LED daytime running lights
- Engine deadlock immobiliser



SE NAV



SE NAV ON-THE-ROAD PRICES

| | | 3-door hatchback | | 5-door hatchback | |
|--------|------------------------|------------------|------------------------|------------------|------------------------|
| | | OTR RRP | CO ₂ (g/km) | OTR RRP | CO ₂ (g/km) |
| Petrol | 1.4i (75PS) | - | - | £16,180 | 128 |
| | 1.4i (90PS) | £15,870 | 128 | £16,430 | 128 |
| | 1.4i (90PS) automatic | £17,230 | 136 | £17,830 | 143 |
| | 1.4i Turbo (100PS) S/S | - | - | £17,330 | 125 |

Please note: On-the-road recommended retail prices (RRP) include VAT at 20%, number plates and delivery to Retailer of £700.00 (inc. £116.67 VAT), 12 months' Vehicle Excise Duty and new vehicle first registration fee of £55.00. Excludes fuel and insurance.

S/S = Start/Stop.

FEATURES

Infotainment:

- Navi 4.0 IntelliLink satellite navigation system
 - Fully integrated European satellite navigation system
 - 7-inch colour touchscreen
 - AM/FM/DAB digital radio
 - Bluetooth® audio streaming
 - Bluetooth® mobile phone portal
 - Apple CarPlay™ / Android Auto™
 - USB audio connection
- Six speakers

Interior convenience / styling:

- Air conditioning
- Auto anti-dazzle rear-view mirror
- Multi-function trip computer
- Heated leather-covered steering wheel
- Heated front seats
- Graphic Embossed cloth/premium leather-effect trim
- 60/40 split-folding rear seat back
- Cruise control
- Speed-sensitive power-assisted steering
- Steering column adjustable for reach / rake
- Steering wheel audio / phone / cruise controls
- Driver's seat height adjuster

Exterior convenience / styling:

- Heated windscreen
- Remote control central locking
- Electrically operated front windows
- Auto lighting / windscreen wipers
- Electrically adjustable / heated door mirrors
- Body-colour exterior door handles
- Front / rear parking sensors
- Front fog lights
- Chrome-effect lower side window mouldings (5-door only)
- 16-inch multi-spoke alloy wheels

Safety / security features:

- Electronic Stability Programme (ESP)
- Anti-lock Braking System (ABS)
- Six airbags
- Hill start assist
- Seatbelt reminders for all seats
- ISOFIX child seat fixings on outer rear seats
- Tyre pressure monitoring system
- LED daytime running lights
- Engine deadlock immobiliser



SRI VX-LINE NAV BLACK



SRI VX-LINE NAV BLACK ON-THE-ROAD PRICES

| | | 3-door hatchback | | 5-door hatchback | |
|--------|-----------------------|------------------|------------------------|------------------|------------------------|
| | | OTR RRP | CO ₂ (g/km) | OTR RRP | CO ₂ (g/km) |
| Petrol | 1.4i (75PS) | £17,490 | 131 | £18,050 | 130 |
| | 1.4i (90PS) | £17,730 | 131 | £18,290 | 130 |
| | 1.4 Turbo (100PS) S/S | £18,590 | 128 | £19,190 | 128 |

Please note: On-the-road recommended retail prices (RRP) include VAT at 20%, number plates and delivery to Retailer of £700.00 (inc. £116.67 VAT), 12 months' Vehicle Excise Duty and new vehicle first registration fee of £55.00. Excludes fuel and insurance.

FEATURES

Infotainment:

- Navi 4.0 IntelliLink satellite navigation system
 - Fully integrated European satellite navigation system
 - 7-inch colour touchscreen
 - AM/FM/DAB digital radio
 - Bluetooth® audio streaming
 - Bluetooth® mobile phone portal
 - Apple CarPlay™ / Android Auto™
 - USB audio connection
- Six speakers

Interior convenience / styling:

- Air conditioning
- Sports-style front seats
- VX-Line styling: Leather-covered flat-bottom steering wheel / gear knob / handbrake lever
- Multi-function trip computer
- Cruise control
- Speed-sensitive power-assisted steering
- Steering column adjustable for reach / rake
- Steering wheel audio / phone / cruise controls
- Driver's seat height adjuster

Exterior convenience / styling:

- VX-Line body styling: Front lower spoiler / side sills / rear skirt / rear roof spoiler (3-door only)
- Roof / door mirrors / front grille bar in black
- Heated windscreen
- Remote control central locking
- Electrically operated front windows
- Electrically adjustable / heated door mirrors
- Dark-tinted rear windows
- Sports suspension
- Front fog lights
- 17-inch black alloy wheels

Safety / security features:

- Electronic Stability Programme (ESP)
- Anti-lock Braking System (ABS)
- Six airbags
- Hill start assist
- Seatbelt reminders for all seats
- ISOFIX child seat fixings on outer rear seats
- Tyre pressure monitoring system
- LED daytime running lights



GSi



GSi ON-THE-ROAD PRICES

| | | 3-door hatchback | |
|--------|------------------------|------------------|------------------------|
| | | OTR RRP | CO ₂ (g/km) |
| Petrol | 1.4i Turbo (150PS) S/S | £19,440 | 140 |

Please note: On-the-road recommended retail prices (RRP) include VAT at 20%, number plates and delivery to Retailer of £700.00 (inc. £116.67 VAT), 12 months' Vehicle Excise Duty and new vehicle first registration fee of £55.00. Excludes fuel and insurance.

S/S = Start/Stop.

FEATURES

Infotainment:

- IntelliLink audio system
 - 7-inch colour touchscreen
 - AM/FM/DAB digital radio
 - Bluetooth® audio streaming
 - Bluetooth® mobile phone portal
 - Apple CarPlay™ / Android Auto™
 - USB audio connection
- Six speakers

Interior convenience / styling:

- Air conditioning
- Sports-style front seats
- GSi styling: Leather-covered flat-bottom steering wheel / gear knob / handbrake lever
- Multi-function trip computer
- Cruise control
- Speed-sensitive power-assisted steering
- Steering column adjustable for reach / rake
- Steering wheel audio / phone / cruise controls
- Driver's seat height adjuster

Exterior convenience / styling:

- GSi body styling: Front lower spoiler / side sills / rear skirt / rear roof spoiler
- Carbon-effect door mirrors / front grille bar
- Heated windscreen
- Remote control central locking
- Electrically operated front windows
- Electrically adjustable / heated door mirrors
- Dark-tinted rear windows
- Sports suspension
- 17-inch 5-spoke bi-colour alloy wheels

Safety / security features:

- Electronic Stability Programme (ESP)
- Anti-lock Braking System (ABS)
- Six airbags
- Hill start assist
- Seatbelt reminders for all seats
- ISOFIX child seat fixings on outer rear seats
- Tyre pressure monitoring system
- LED daytime running lights
- Remote control security alarm



CORSA 3-DOOR HATCHBACK PRICES

| | Fuel Type | Price (£) | VAT (£) | Total (£) | On-the-road RRP (£) | CO ₂ (g/km)* |
|--|-----------|-----------|----------|-----------|---------------------|-------------------------|
| ACTIVE | | | | | | |
| 1.4i (75PS) | Petrol | 9,008.33 | 1,801.67 | 10,810.00 | 11,730.00 | 128 |
| DESIGN | | | | | | |
| 1.4i (75PS) | Petrol | 10,450.00 | 2,090.00 | 12,540.00 | 13,460.00 | 128 |
| ENERGY | | | | | | |
| 1.4i (75PS) | Petrol | 11,583.33 | 2,316.67 | 13,900.00 | 14,820.00 | 128 |
| 1.4i (90PS) | Petrol | 11,791.67 | 2,358.33 | 14,150.00 | 15,070.00 | 128 |
| 1.4i (90PS) auto | Petrol | 12,891.67 | 2,578.33 | 15,470.00 | 16,430.00 | 136 |
| GRIFFIN (SPECIAL EDITION MODEL) | | | | | | |
| 1.4i (75PS) | Petrol | 9,583.33 | 1,916.67 | 11,500.00 | 12,420.00 | 128 |
| 1.4i (90PS) | Petrol | 9,791.67 | 1,958.33 | 11,750.00 | 12,670.00 | 128 |
| SPORT | | | | | | |
| 1.4i (75PS) | Petrol | 12,400.00 | 2,480.00 | 14,880.00 | 15,800.00 | 128 |
| 1.4i (90PS) | Petrol | 12,600.00 | 2,520.00 | 15,120.00 | 16,040.00 | 128 |
| SRI NAV | | | | | | |
| 1.4i (75PS) | Petrol | 13,233.33 | 2,646.67 | 15,880.00 | 16,800.00 | 128 |
| 1.4i (90PS) | Petrol | 13,433.33 | 2,686.67 | 16,120.00 | 17,040.00 | 128 |
| 1.4i Turbo (100PS) Start/Stop | Petrol | 14,158.33 | 2,831.67 | 16,990.00 | 17,910.00 | 125 |
| SE NAV | | | | | | |
| 1.4i (90PS) | Petrol | 12,458.33 | 2,491.67 | 14,950.00 | 15,870.00 | 128 |
| 1.4i (90PS) auto | Petrol | 13,558.33 | 2,711.67 | 16,270.00 | 17,230.00 | 136 |
| SRI VX-LINE NAV BLACK | | | | | | |
| 1.4i (75PS) | Petrol | 13,775.00 | 2,755.00 | 16,530.00 | 17,490.00 | 131 |
| 1.4i (90PS) | Petrol | 13,975.00 | 2,795.00 | 16,770.00 | 17,730.00 | 131 |
| 1.4i Turbo (100PS) Start/Stop | Petrol | 14,725.00 | 2,945.00 | 17,670.00 | 18,590.00 | 128 |
| GSi | | | | | | |
| 1.4i (150PS) | Petrol | 15,400.00 | 3,080.00 | 18,480.00 | 19,440.00 | 140 |

Colours and model variants for Griffin special edition subject to availability. Please check with your Vauxhall Retailer.

Please note: On-the-road recommended retail prices (RRP) include number plates and delivery to retailer of £700.00 (inc. £116.67 VAT), 12 months' Vehicle Excise Duty and new vehicle first registration fee of £55.00. Excludes fuel and insurance. * = CO₂ emissions figures are determined according to the WLTP test cycle however, a Government formula is then applied to translate these figures back to what they would have been under the outgoing NEDC test cycle, which WLTP replaces. The correct tax treatment is then applied. Figures are intended for comparability purposes only. The fuel consumption you achieve under real life driving conditions and CO₂ produced will depend upon a number of factors, including the accessories fitted after registration, variations in driving styles, weather conditions and vehicle load. Only compare fuel consumption and CO₂ with other vehicles tested using the same technical procedures. For more information contact your local Vauxhall Retailer.



CORSA 5-DOOR HATCHBACK PRICES

| | Fuel Type | Price (£) | VAT (£) | Total (£) | On-the-road RRP (£) | CO ₂ (g/km)* |
|--|-----------|-----------|----------|-----------|---------------------|-------------------------|
| DESIGN | | | | | | |
| 1.4i (75PS) | Petrol | 10,916.67 | 2,183.33 | 13,100.00 | 14,020.00 | 128 |
| 1.4i (90PS) | Petrol | 11,116.67 | 2,223.33 | 13,340.00 | 14,260.00 | 128 |
| 1.4i (90PS) auto | Petrol | 12,258.33 | 2,451.67 | 14,710.00 | 15,670.00 | 143 |
| ENERGY | | | | | | |
| 1.4i (75PS) | Petrol | 12,050.00 | 2,410.00 | 14,460.00 | 15,380.00 | 128 |
| 1.4i (90PS) | Petrol | 12,258.33 | 2,451.67 | 14,710.00 | 15,630.00 | 128 |
| 1.4i (90PS) auto | Petrol | 13,391.67 | 2,678.33 | 16,070.00 | 17,030.00 | 143 |
| 1.4i Turbo (100PS) Start/Stop | Petrol | 12,766.67 | 2,553.33 | 15,320.00 | 16,240.00 | 125 |
| GRIFFIN (SPECIAL EDITION MODEL) | | | | | | |
| 1.4i (75PS) | Petrol | 10,050.00 | 2,010.00 | 12,060.00 | 12,980.00 | 128 |
| 1.4i (90PS) | Petrol | 10,258.33 | 2,051.67 | 12,310.00 | 13,230.00 | 128 |
| SPORT | | | | | | |
| 1.4i (75PS) | Petrol | 12,866.67 | 2,573.33 | 15,440.00 | 16,360.00 | 128 |
| 1.4i (90PS) | Petrol | 13,066.67 | 2,613.33 | 15,680.00 | 16,600.00 | 128 |
| SRI NAV | | | | | | |
| 1.4i (75PS) | Petrol | 13,700.00 | 2,740.00 | 16,440.00 | 17,360.00 | 128 |
| 1.4i (90PS) | Petrol | 13,900.00 | 2,780.00 | 16,680.00 | 17,600.00 | 128 |
| 1.4i (90PS) auto | Petrol | 15,041.67 | 3,008.33 | 18,050.00 | 19,010.00 | 143 |
| 1.4i Turbo (100PS) Start/Stop | Petrol | 14,658.33 | 2,931.67 | 17,590.00 | 18,510.00 | 125 |
| SE NAV | | | | | | |
| 1.4i (75PS) | Petrol | 12,716.67 | 2,543.33 | 15,260.00 | 16,180.00 | 128 |
| 1.4i (90PS) | Petrol | 12,925.00 | 2,585.00 | 15,510.00 | 16,430.00 | 128 |
| 1.4i (90PS) auto | Petrol | 14,058.33 | 2,811.67 | 16,870.00 | 17,830.00 | 143 |
| 1.4i Turbo (100PS) Start/Stop | Petrol | 13,675.00 | 2,735.00 | 16,410.00 | 17,330.00 | 125 |
| SRI VX-LINE NAV BLACK | | | | | | |
| 1.4i (75PS) | Petrol | 14,275.00 | 2,855.00 | 17,130.00 | 18,050.00 | 130 |
| 1.4i (90PS) | Petrol | 14,475.00 | 2,895.00 | 17,370.00 | 18,290.00 | 130 |
| 1.4i Turbo (100PS) Start/Stop | Petrol | 15,225.00 | 3,045.00 | 18,270.00 | 19,190.00 | 128 |

Colours and model variants for Griffin special edition subject to availability. Please check with your Vauxhall Retailer.

Please note: On-the-road recommended retail prices (RRP) include number plates and delivery to retailer of £700.00 (inc. £116.67 VAT), 12 months' Vehicle Excise Duty and new vehicle first registration fee of £55.00. Excludes fuel and insurance. * = CO₂ emissions figures are determined according to the WLTP test cycle however, a Government formula is then applied to translate these figures back to what they would have been under the outgoing NEDC test cycle, which WLTP replaces. The correct tax treatment is then applied. Figures are intended for comparability purposes only. The fuel consumption you achieve under real life driving conditions and CO₂ produced will depend upon a number of factors, including the accessories fitted after registration, variations in driving styles, weather conditions and vehicle load. Only compare fuel consumption and CO₂ with other vehicles tested using the same technical procedures. For more information contact your local Vauxhall Retailer.



FEATURES/OPTIONS

SAFETY

| | Active | Design | Energy | Griffin | Sport | SRI Nav | SE Nav | SRI VX-Line Nav Black | GSI | Price (£) exc. VAT | Price (£) inc. VAT |
|---|--------|--------|--------|---------|-------|---------|--------|--------------------------|-----|-----------------------|-----------------------|
| Driver / passenger airbags <ul style="list-style-type: none"> • Driver's dual-stage airbag • Front passenger's dual-stage airbag • Front seat side-impact airbags • Full-size curtain airbags | ● | ● | ● | ● | ● | ● | ● | ● | ● | | |
| Seating <ul style="list-style-type: none"> • Height-adjustable front seat head restraints • Adjustable outer rear seat head restraints • Anti-submarining ramps in all seats – Helps prevent occupants sliding underneath the lap belt during a collision. | ● | ● | ● | ● | ● | ● | ● | ● | ● | | |
| Seatbelts <ul style="list-style-type: none"> • Height-adjustable front seatbelts • Three inertia-reel lap and diagonal rear seatbelts • Front seatbelt pretensioner system – Pretensioners tighten the seatbelt in the event of an accident limiting forward movement. • Front seatbelt force limiters – Reduces potential upper body injuries during a frontal impact. • Front and rear 'seatbelt unfastened' audible warning and warning light | ● | ● | ● | ● | ● | ● | ● | ● | ● | | |
| Child safety <ul style="list-style-type: none"> • Deactivation switch for front passenger's airbag – Permits the safe use of a child seat in the front passenger seat. • ISOFIX child seat mountings incorporating top tether anchor points located on outer rear seats (does not include child seat) – Allows ISOFIX child safety seats to be securely fixed into the car. The ISOFIX mounting system reduces forward movement in an accident and makes the child seat easier to install. • Child-proof locks on rear doors | ● | ● | ● | ● | ● | ● | ● | ● | ● | | |
| Driver/passenger safety <ul style="list-style-type: none"> • Energy-absorbing steering column • Pedal release system – Reduces potential injury to the driver's legs and feet during a severe frontal impact. • Laminated windscreen • Side-impact protection beams • Reinforced passenger safety cell | ● | ● | ● | ● | ● | ● | ● | ● | ● | | |
| Pedestrian safety <ul style="list-style-type: none"> • Bonnet/headlight/wiper structure – Designed to reduce pedestrian head and upper body injuries. • Upper and lower bumper design – Reduces upper and lower leg injuries. | ● | ● | ● | ● | ● | ● | ● | ● | ● | | |

● = Standard equipment.



FEATURES/OPTIONS

SAFETY CONTINUED

| | Active | Design | Energy | Griffin | Sport | SRI Nav | SE Nav | SRI VX-Line Nav Black | GSI | Price (£) exc. VAT | Price (£) inc. VAT |
|---|--------|--------|--------|---------|-------|---------|--------|--------------------------|-----|-----------------------|-----------------------|
| <p>Stability</p> <ul style="list-style-type: none"> • Electronic Stability Programme (ESP) – Works in conjunction with the vehicle’s electronic braking and engine systems to keep the car stable in many different situations. ESP monitors many different inputs to determine when the car starts to lose traction, it can then immediately respond by varying the brake pressure between up to three wheels and adjust the engine output to help correct the loss of traction and improve stability. <p>Additional ESP features:</p> <ul style="list-style-type: none"> • Traction control • Cornering brake control • Straight line stability control • Drag torque control – Maintain stability on slippery roads when lifting off the accelerator or changing gear. | ● | ● | ● | ● | ● | ● | ● | ● | | | |
| <p>Braking</p> <ul style="list-style-type: none"> • Anti-lock Braking System (ABS) – Prevents the vehicle’s wheels from locking up under heavy braking by momentarily reducing brake pressure at the appropriate wheel, ensuring that you can maintain control of the steering. <p>Additional braking features:</p> <p>The same electronic systems used in the ABS and ESP also deliver exceptional braking performance.</p> <ul style="list-style-type: none"> • Emergency brake assist – When emergency braking is detected the vehicle automatically applies the maximum possible braking assistance. • Electronic brakeforce distribution – Automatically apportions the optimum braking force to each wheel. • Adaptive brake lights – Automatically warns other road users of heavy braking • Hill start assist – Briefly maintains rear brake pressure to stop the vehicle rolling back on an incline. • Hazard warning lights | ● | ● | ● | ● | ● | ● | ● | ● | | | |
| <p>Tyre pressure</p> <ul style="list-style-type: none"> • Tyre pressure monitoring system | ● | ● | ● | ● | ● | ● | ● | ● | | | |



FEATURES/OPTIONS

DRIVER ASSISTANCE

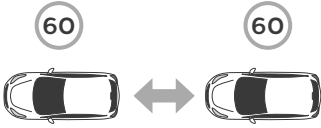
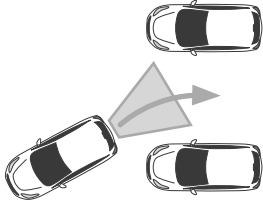
| | Active | Design | Energy | Griffin | Sport | SRI Nav | SE Nav | SRI VX-Line Nav Black | GSI | Price (£) exc. VAT | Price (£) inc. VAT |
|--|--------|--------|--------|---------|-------|---------|--------|-----------------------|-----|--------------------|--------------------|
| Steering <ul style="list-style-type: none"> • Speed-sensitive electric power-assisted steering • City mode button – Provides lighter steering at parking speeds. | ● | ● | ● | ● | ● | ● | ● | ● | ● | | |
| Cruise control with speed limiter <p>Enables you to maintain a constant speed – making it ideal for economical motorway driving.</p> <ul style="list-style-type: none"> • The speed limiter function – Can be set to ensure that you do not exceed the speed limit and can be easily overridden if required. • Steering wheel mounted controls | ● | ● | ● | ● | ● | ● | ● | ● | ● | | |
|  | | | | | | | | | | | |
| Parking sensors <ul style="list-style-type: none"> • Rear parking distance sensors • Audible warning | ○ | ○ | ○ | | ○ | ○ | ● | ○ | ○ | 250.00 | 300.00 |
| <ul style="list-style-type: none"> • Front and rear parking distance sensors • Audible warning • Distance warning graphic shown in driver information display | ○ | ○ | ○ | | ○ | ○ | ● | ○ | ○ | 387.50 | 465.00 |
| Rear-view camera <p>The rear-view camera gives a clear view of the area behind your car and helps place the car perfectly, without needing to strain your neck.</p> <ul style="list-style-type: none"> • Activated when reverse gear selected • Camera view appears in infotainment screen • Rear bumper and one-metre grid lines shown as reference points <p>Please note: Only available in conjunction with parking sensors. Not available with CD 30 BT audio unit.</p> | | ○ | ○ | | ○ | ○ | ○ | ○ | ○ | 208.33 | 250.00 |
|  | | | | | | | | | | | |



FEATURES/OPTIONS

SECURITY

| | Active | Design | Energy | Griffin | Sport | SRI Nav | SE Nav | SRI VX-Line Nav Black | GSI | Price (£) exc. VAT | Price (£) inc. VAT |
|---|--------|--------|--------|---------|-------|---------|--------|--------------------------|-----|-----------------------|-----------------------|
| Standard security features <ul style="list-style-type: none"> • 'Key left in ignition' audible warning • Electronically protected audio equipment • Engine deadlock immobiliser • Visible Vehicle Identification Number (VIN) • Locking wheel bolts for alloy wheels (where fitted) • Door-to-door illumination | ● | ● | ● | ● | ● | ● | ● | ● | ● | | |
| Central locking <ul style="list-style-type: none"> • Remote control • Operates on doors, tailgate and fuel filler flap • Deadlocking • Central locking activation switch on facia • One folding key/one static key each with integral remote control function | ● | ● | ● | ● | ● | ● | ● | ● | ● | | |
| Security alarm system – 1.4i Turbo (100/150PS) models only. <ul style="list-style-type: none"> • Remote control (operates in conjunction with central locking) • Tilt sensor • Thatcham approved | | | | | | ○ | ○ | | ● | 216.67 | 260.00 |



FEATURES/OPTIONS

DRIVER INFORMATION

| | Active | Design | Energy | Griffin | Sport | SRI Nav | SE Nav | SRI VX-Line Nav Black | GSI | Price (£) exc. VAT | Price (£) inc. VAT |
|---|--------|--------|--------|---------|-------|---------|--------|-----------------------|-----|--------------------|--------------------|
| Instrumentation • Speedometer • Rev counter • Digital fuel gauge with low fuel level warning light • Digital water temperature gauge • Instrument panel light dimmer • Shift-up indication light – Indicates when to change gear for optimum fuel economy | ● | ● | ● | ● | ● | ● | ● | ● | ● | | |
| Driver information display (centrally located in instrument cluster) • Displays trip computer data • Total mileage • Service-due indicator • Oil life • Tyre pressure monitoring system • Headlight/brake light bulb failure warning | ● | ● | ● | ● | ● | ● | ● | ● | ● | | |
| Red graphics on black background | ● | | | | | | | | | | |
| Red graphics on black background (fitted in lieu of white graphics on 1.4i (75PS) and 1.4i (90PS) models if CD 30 BT audio unit is fitted in lieu of IntelliLink. Where digital speedometer and digital over-speed warning are standard, these features will be deleted. Not available separately). | | ● | ● | ● | ● | ● | | ● | | | |
| White graphics on black background | | ● | ● | ● | ● | ● | ● | ● | ● | | |
| Central fascia display (format dependent on infotainment unit) • Audio information • Digital clock with automatic RDS time adjustment • Outside air temperature with ice warning function • Additional features dependent on infotainment unit (see infotainment for details) | ● | ● | ● | ● | ● | ● | ● | ● | ● | | |
| Multi-function trip computer (displayed on driver information display) • Trip mileage • Vehicle range based on remaining fuel • Average speed • Average fuel economy • Instantaneous fuel economy • Digital speedometer • Digital over-speed warning | | | | ● | ● | ● | ● | ● | ● | | |



FEATURES/OPTIONS

INTERIOR STYLING

| | Active | Design | Energy | Griffin | Sport | SRI Nav | SE Nav | SRI VX-Line Nav Black | GSI | Price (£) exc. VAT | Price (£) inc. VAT |
|---|--------|--------|--------|---------|-------|---------|--------|--------------------------|-----|-----------------------|-----------------------|
| <p>Active interior décor</p> <p>Steering wheel:</p> <ul style="list-style-type: none"> • Three-spoke design • Leather-covered • Satin chrome-effect bezel <p>Facia and door trim:</p> <ul style="list-style-type: none"> • Piano black facia • Black door panels with black Atlantis cloth inserts • Chrome-effect interior door handles <p>Seat trim:</p> <ul style="list-style-type: none"> • Spot Shimmer black fabric seat trim inserts • Plain black fabric side bolsters and surrounds | ● | | | | | | | | | | |
| <p>Design / Energy / SE Nav interior décor</p> <p>Steering wheel:</p> <ul style="list-style-type: none"> • Three-spoke design • Leather-covered • Satin chrome-effect bezel <p>Facia and door trim:</p> <ul style="list-style-type: none"> • Rhutenium facia with chrome-effect trim inserts • Black door panels with black Atlantis cloth inserts • Chrome-effect interior door handles <p>Seat trim:</p> <ul style="list-style-type: none"> • Spot Shimmer black fabric seat trim inserts • Plain black fabric side bolsters and surrounds | | ● | ● | | | | ● | | | | |
| <p>Griffin interior décor</p> <p>Steering wheel:</p> <ul style="list-style-type: none"> • Three-spoke design • Leather-covered with accent stitching • Satin chrome-effect bezel <p>Facia and door trim:</p> <ul style="list-style-type: none"> • Piano black facia with red/white inserts (dependent on exterior colour) • Black door panels with black Atlantis cloth inserts • Chrome-effect interior door handles <p>Seat trim:</p> <ul style="list-style-type: none"> • Black lace fabric seat trim inserts • Plain black fabric side bolsters and surrounds with accent stitching | | | | ● | | | | | | | |



FEATURES/OPTIONS

INTERIOR STYLING

| | Active | Design | Energy | Griffin | Sport | SRI Nav | SE Nav | SRI VX-Line Nav Black | GSI | Price (£) exc. VAT | Price (£) inc. VAT |
|--|--------|--------|--------|---------|-------|---------|--------|-----------------------|-----|--------------------|--------------------|
| <p>Sport interior décor</p> <p>Steering wheel:</p> <ul style="list-style-type: none"> • Three-spoke design • Leather-covered • Satin chrome-effect bezel <p>Facia and door trim:</p> <ul style="list-style-type: none"> • Piano black facia with red/white inserts (dependent on exterior colour) • Black door panels with black Atlantis cloth inserts • Chrome-effect interior door handles <p>Seat trim:</p> <ul style="list-style-type: none"> • Black Lace fabric seat trim inserts • Plain black fabric side bolsters and surrounds with accent stitching | | | | | ● | | | | | | |
| <p>SRI Nav interior décor</p> <p>Steering wheel:</p> <ul style="list-style-type: none"> • Three-spoke design • Leather-covered with accent stitching • Satin chrome-effect bezel <p>Facia and door trim:</p> <ul style="list-style-type: none"> • Piano black facia with red trim inserts (except Aegean Blue models, which feature a white trim insert) • Black door panels with black Atlantis cloth inserts • Chrome-effect interior door handles <p>Seat trim:</p> <ul style="list-style-type: none"> • Black lace fabric seat trim inserts • Plain black fabric side bolsters and surrounds with accent stitching | | | | | | ● | | | | | |
| <p>SRI VX-Line Nav Black interior décor with Lace cloth seat trim</p> <p>Steering wheel:</p> <ul style="list-style-type: none"> • VX-Line three-spoke design • Leather-covered flat bottom • Satin chrome-effect bezel <p>Gear knob:</p> <ul style="list-style-type: none"> • VX-Line leather-covered <p>Facia and door trim:</p> <ul style="list-style-type: none"> • Piano black facia with white trim inserts • Black door panels with black Atlantis cloth inserts • Chrome-effect interior door handles <p>Seat trim:</p> <ul style="list-style-type: none"> • Black Lace fabric seat trim inserts • Plain black fabric side bolsters and surrounds with accent stitching | | | | | | | | ● | | | |

● = Standard equipment.



FEATURES/OPTIONS

INTERIOR STYLING

| | Active | Design | Energy | Griffin | Sport | SRI Nav | SE Nav | SRI VX-Line Nav Black | GSI | Price (£) exc. VAT | Price (£) inc. VAT |
|--|--------|--------|--------|---------|-------|---------|--------|-----------------------|-----|--------------------|--------------------|
| <p>SRI VX-Line Nav Black interior décor with Network Moonray cloth seat trim</p> <p>Steering wheel:</p> <ul style="list-style-type: none"> VX-Line three-spoke design Leather-covered flat bottom Satin chrome-effect bezel <p>Gear knob:</p> <ul style="list-style-type: none"> VX-Line leather-covered <p>Facia and door trim:</p> <ul style="list-style-type: none"> Piano black facia with white trim inserts Black door panels with black Atlantis cloth inserts Chrome-effect interior door handles <p>Seat trim:</p> <ul style="list-style-type: none"> Network Moonray cloth seat trim inserts Piano black facia side bolsters and surrounds | | | | | | | | O | | 133.33 | 160.00 |
| <p>GSI interior décor with Lace cloth seat trim</p> <p>Steering wheel:</p> <ul style="list-style-type: none"> GSI three-spoke design Leather-covered flat bottom Satin chrome-effect bezel <p>Gear knob:</p> <ul style="list-style-type: none"> GSI leather-covered <p>Facia and door trim:</p> <ul style="list-style-type: none"> Piano black facia with white trim inserts Black door panels with black Atlantis cloth inserts Chrome-effect interior door handles <p>Seat trim:</p> <ul style="list-style-type: none"> Black Lace fabric seat trim inserts Plain black fabric side bolsters and surrounds with accent stitching | | | | | | | | ● | | | |



FEATURES/OPTIONS

INTERIOR STYLING

| | Active | Design | Energy | Griffin | Sport | SRI Nav | SE Nav | SRI VX-Line Nav Black | GSi | Price (£) exc. VAT | Price (£) inc. VAT |
|--|--------|--------|--------|---------|-------|---------|--------|--------------------------|-----|-----------------------|-----------------------|
| GSi interior décor with Nappa leather seat trim | | | | | | | | | | | |
| Steering wheel: | | | | | | | | | | | |
| • GSi three-spoke design • Leather-covered flat bottom | | | | | | | | | | | |
| • Satin chrome-effect bezel | | | | | | | | | | | |
| Gear knob: | | | | | | | | | | | |
| • GSi leather-covered | | | | | | | | | | | |
| Facia and door trim: | | | | | | | | | | | |
| • Piano black facia with white trim inserts | | | | | | | | | | | |
| • Black door panels with black Rhodos vinyl inserts | | | | | | | | | | | |
| • Chrome-effect interior door handles | | | | | | | | | | | |
| Seat trim: | | | | | | | | | | | |
| • Recaro seats • Black Nappa leather seat trim inserts | | | | | | | | | | | |
| • Black leather-effect side bolsters and surrounds | | | | | | | | | O | 879.17 | 1,055.00 |

O = Optional at extra cost.



FEATURES/OPTIONS

INFOTAINMENT

| | Active | Design | Energy | Griffin | Sport | SRI Nav | SE Nav | SRI/VX-Line Nav Black | GSI | Price (£) exc. VAT | Price (£) inc. VAT |
|---|--------|--------|--------|---------|-------|---------|--------|-----------------------|-----|--------------------|--------------------|
| <p>CD 30 BT</p> <p>Onboard features:</p> <ul style="list-style-type: none"> • CD/MP3 CD player • AM/FM stereo radio with 36 station presets • RDS with Traffic Programme <p>Media connections:</p> <ul style="list-style-type: none"> • USB connection with iPod control • Aux-in socket <p>Mobile phone portal:</p> <ul style="list-style-type: none"> • Bluetooth® connectivity • Handsfree calls via steering wheel controls • Vehicle microphone • Phone book access <p>Please note: On 1.4i (75PS) and 1.4i (90PS) models the trip computer including digital speedometer and digital over-speed warning are deleted.</p> | ● | N/C | N/C | | N/C | N/C | N/C | N/C | N/C | No-cost option | |
| <p>R4.0 IntelliLink touchscreen infotainment system</p> <p>For use with media players, USB memory sticks, mobile phones and smartphone apps.</p> <p>Onboard features:</p> <ul style="list-style-type: none"> • 7-inch colour touchscreen • DAB digital radio/AM/FM stereo radio with 36 station presets • RDS with Traffic Programme <p>Media connections:</p> <ul style="list-style-type: none"> • USB connection with iPod control • Bluetooth® A2DP audio streaming (Advanced Audio Distribution Profile) <p>Mobile phone portal:</p> <ul style="list-style-type: none"> • Bluetooth® connectivity • Handsfree calls via steering wheel controls • Vehicle microphone • Phone book access – The majority of the phone's functions – contacts/last calls/missed calls etc. – are mirrored on IntelliLink's display and are easily navigated using the touchscreen (features dependent on mobile phone). <p>Smartphone interface:</p> <ul style="list-style-type: none"> • Apple CarPlay™ • Android Auto™ – Smartphone projection that allows operations via voice command, touchscreen and buttons to control apps and music playback. | | ● | ● | | ● | | | ● | | | |



FEATURES/OPTIONS

INFOTAINMENT

| | Active | Design | Energy | Griffin | Sport | SRI Nav | SE Nav | SRI VX-Line Nav Black | GSI | Price (£) exc. VAT | Price (£) inc. VAT |
|---|--------|--------|--------|---------|-------|---------|--------|-----------------------|-----|--------------------|--------------------|
| <p>Navi 4.0 IntelliLink touchscreen navigation and infotainment system</p> <p>For use with media players, USB memory sticks, mobile phones and smartphone apps</p> <p>Onboard features:</p> <ul style="list-style-type: none"> • 7-inch colour touchscreen • DAB digital radio/AM/FM stereo radio with 36 station presets • RDS with Traffic Programme <p>Navigation features:</p> <ul style="list-style-type: none"> • Satellite navigation system • 2D street level mapping • European coverage • Structured or one-box destination entry • Points-of-interest search • Eco routing • Map updates via USB <p>Media connections:</p> <ul style="list-style-type: none"> • USB connection with iPod control • Bluetooth® A2DP audio streaming (Advanced Audio Distribution Profile) <p>Mobile phone portal:</p> <ul style="list-style-type: none"> • Bluetooth® connectivity • Handsfree calls via steering wheel controls • Vehicle microphone • Phone book access – The majority of the phone's functions – contacts/last calls/missed calls etc. – are mirrored on IntelliLink's display and are easily navigated using the touchscreen (features dependent on mobile phone). <p>Smartphone interface:</p> <ul style="list-style-type: none"> • Apple CarPlay™ • Android Auto™ – Smartphone projection that allows operations via voice command, touchscreen and buttons to control apps and music playback. <p>Gallery – only available when vehicle is stationary:</p> <ul style="list-style-type: none"> • Photo gallery with slide show feature • Video playback with soundtrack played through car speakers | | ○ | ○ | ● | ○ | ● | ● | ● | ○ | 541.67 | 650.00 |
| Six speakers | ● | ● | ● | ● | ● | ● | ● | ● | ● | | |
| Steering wheel mounted audio controls | ● | ● | ● | ● | ● | ● | ● | ● | ● | | |



FEATURES/OPTIONS

HEATING AND VENTILATION

| | Active | Design | Energy | Griffin | Sport | SRI Nav | SE Nav | SRI VX-Line Nav Black | GSI | Price (£) exc. VAT | Price (£) inc. VAT |
|---|--------|--------|--------|---------|-------|---------|--------|-----------------------|-----|--------------------|--------------------|
| Air blend heater <ul style="list-style-type: none"> Cabin particulate filter – Removes dust, airborne particles and pollen Four-speed fan • Illuminated controls | ● | | | | | | | | | | |
| Air conditioning <ul style="list-style-type: none"> Air recirculation facility Cabin particulate filter – Removes dust, airborne particles and pollen Four-speed fan • Illuminated controls | | ● | ● | ● | ● | ● | ● | ● | ● | 445.83 | 535.00 |
| Electronic climate control incorporating air conditioning <ul style="list-style-type: none"> Single-zone control • Advanced predictive logic control system using sun sensor Cabin charcoal filter – Removes dust, airborne particles, pollen and unpleasant odours Automatic air direction and fan speed with manual override LCD temperature display • Six-speed fan • Illuminated controls | | | ○ | | ○ | ○ | ○ | ○ | ○ | 345.83 | 415.00 |
| Additional features <ul style="list-style-type: none"> Four adjustable facia vents • Windscreen demist vents • Side window demist vents | ● | ● | ● | ● | ● | ● | ● | ● | ● | | |



FEATURES/OPTIONS

SEATING AND COMFORT

| | Active | Design | Energy | Griffin | Sport | SRI Nav | SE Nav | SRI VX-Line Nav Black | GSI | Price (£) exc. VAT | Price (£) inc. VAT |
|--|--------|--------|--------|---------|-------|---------|--------|--------------------------|-----|-----------------------|-----------------------|
| Reach and rake adjustable steering | ● | ● | ● | | ● | ● | ● | ● | ● | | |
| Comfort front seats | | | | | | | | | | | |
| Driver's seat (eight-way adjustable): • Height (up/down) • Reach (fore/aft) • Backrest (upright/recline) • Head restraint (up/down) | ● | ● | ● | | | | ● | | | | |
| Front passenger's seat (six-way adjustable): • Reach (fore/aft) • Backrest (upright/recline) • Head restraint (up/down) | | | | | | | | | | | |
| Sports-style front seats | | | | | | | | | | | |
| Driver's seat (eight-way adjustable): • Height (up/down) • Reach (fore/aft) • Backrest (upright/recline) • Head restraint (up/down) | | | | ● | ● | ● | | ● | ● | | |
| Front passenger's seat (six-way adjustable): • Reach (fore/aft) • Backrest (upright/recline) • Head restraint (up/down) | | | | | | | | | | | |
| Easy-entry front seats with memory function (three-door models only) | ● | ● | ● | ● | ● | ● | ● | ● | ● | | |
| Front passenger's seat height adjuster | ○ | ○ | ○ | | ○ | ○ | ○ | ○ | ○ | 62.50 | 75.00 |
| Rear seats | | | | | | | | | | | |
| • Three-person layout • Adjustable backrest • Height-adjustable and removable outer head restraints • ISOFIX child seat mountings incorporating top tether anchor points located on outer rear seats (does not include child seat) – Allows ISOFIX child safety seats to be securely fixed into the car. The ISOFIX mounting system reduces forward movement in an accident and makes the child seat easier to install. • Child-proof locks on rear doors | ● | ● | ● | ● | ● | ● | ● | ● | ● | | |
| • One-piece folding rear seat | ● | ● | ● | ● | ● | ● | | ● | ● | | |
| • 60/40 split-folding rear seat back | ○ | ○ | ○ | | ○ | ○ | ● | ○ | ○ | 116.67 | 140.00 |

● = Standard equipment. ○ = Optional at extra cost.



FEATURES/OPTIONS

INTERIOR CONVENIENCE

| | Active | Design | Energy | Griffin | Sport | SRI Nav | SE Nav | SRI VX-Line Nav Black | GSI | Price (£) exc. VAT | Price (£) inc. VAT |
|---|--------|--------|--------|---------|-------|---------|--------|--------------------------|-----|-----------------------|-----------------------|
| Convenience features <ul style="list-style-type: none"> • Front 12-volt electrical accessory socket • Driver's and front passengers sunvisors • Passenger's vanity mirror • Dipping rear-view mirror • Driver's and front passenger's tilttable assist handles • Two rear tilttable passenger assist handles (five-door models only) | ● | ● | ● | ● | ● | ● | ● | ● | ● | | |
| Automatically dimming anti-dazzle rear-view mirror | | □ | ● | ● | ● | ● | ● | ● | ● | | |
| Front and rear floor mats (front Griffin-branded) | | | | ● | | | | | | | |
| Interior lighting <ul style="list-style-type: none"> • Central front courtesy light • Central rear courtesy light • Fade up/fade down • Front map reading lights • Rear reading light (five-door models only) | ● | ● | ● | ● | ● | ● | ● | ● | ● | | |
| Interior storage <ul style="list-style-type: none"> • Storage box on driver's side lower facia • Glovebox with lid • Front door pockets • Drinks holder in centre console • Rear door pockets (five-door models only) • Rear bottle holders (three-door models only) | ● | ● | ● | ● | ● | ● | ● | ● | ● | | |
| Luggage area <ul style="list-style-type: none"> • Luggage compartment cover • Stowage facility for luggage compartment cover behind rear seats • Illuminated luggage area • Interior tailgate handles • Load restraint lashing eyes • Twin gas-assisted tailgate struts | ● | ● | ● | ● | ● | ● | ● | ● | ● | | |



FEATURES/OPTIONS

EXTERIOR LIGHTING

| | Active | Design | Energy | Griffin | Sport | SRI Nav | SE Nav | SRI VX-Line Nav Black | GSI | Price (£) exc. VAT | Price (£) inc. VAT |
|--|--------|--------|--------|---------|-------|---------|--------|--------------------------|-----|-----------------------|-----------------------|
| Standard lighting features • Welcome lighting • Lights-on audible warning • Electric headlight beam levelling • High-level LED centre rear brake light • Rear fog light | ● | ● | ● | ● | ● | ● | ● | ● | ● | | |
| Halogen headlights | ● | ● | ● | ● | ● | ● | ● | ● | ● | | |
| Bi-xenon headlights with cornering light | | | | | | | ○ | ○ | ○ | 354.17 | 425.00 |
| Daytime running lights | ● | | | | | | | | | | |
| LED daytime running lights | | ● | ● | ● | ● | ● | ● | ● | ● | | |
| Front fog lights with black surround | | ● | ● | ● | | | ● | ● | | | |
| Front fog lights with chrome-effect surround | | | | | | ● | | | | | |



FEATURES/OPTIONS

EXTERIOR CONVENIENCE

| | Active | Design | Energy | Griffin | Sport | SRI Nav | SE Nav | SRI VX-Line Nav Black | GSI | Price (£) exc. VAT | Price (£) inc. VAT |
|---|--------|--------|--------|---------|-------|---------|--------|--------------------------|-----|-----------------------|-----------------------|
| Windscreen wipers • Two-speed windscreen wipers with variable intermittent wipe • Intermittent rear window wash/wipe | ● | ● | ● | ● | ● | ● | ● | ● | ● | | |
| • Rain-sensitive windscreen wipers | | □ | ● | ● | □ | ● | ● | ● | □ | | |
| Door mirrors • Electrically adjustable door mirrors (wide-angle on driver's side), manually foldable | ● | ● | | ● | | | | | | | |
| • Electrically adjustable/heated door mirrors (wide-angle on driver's side), manually foldable | | | ● | | ● | ● | ● | ● | ● | | |
| Windows • Heated windscreen • Electrically operated front windows with safety autoreverse and one-touch facility • Heated rear window | ● | ● | ● | ● | ● | ● | ● | ● | ● | | |



FEATURES/OPTIONS

EXTERIOR STYLING

| | Active | Design | Energy | Griffin | Sport | SRI Nav | SE Nav | SRI VX-Line Nav Black | GSI | Price (£) exc. VAT | Price (£) inc. VAT |
|---|--------|--------|--------|---------|-------|---------|--------|-----------------------|-----|--------------------|--------------------|
| Active/Design/Energy/Sport/SRI Nav styling • Chrome-effect front grille bar • Body-colour door mirrors • Body-colour door handles | ● | ● | ● | | ● | ● | | | | | |
| Griffin styling • Mineral Black door mirror housings • Black front grille bar • Body-colour door handles • Mineral Black roof | | | | ● | | | | | | | |
| Griffin styling • Body-colour door mirror housings • Black front grille bar • Body-colour door handles • Body-colour roof | | | | N/C | | | | | | | |
| SE Nav styling • Chrome-effect front grille bar • Body-colour door mirrors • Body-colour door handles • Chrome-effect lower side window mouldings (5-door models only) | | | | | | | ● | | | | |
| SRI VX-Line Nav Black styling • Mineral Black door mirror housings • Black front grille bar • Body-colour door handles • Body-colour front lower spoiler/side sills/rear lower skirt • Rear roof spoiler (3-door models only) • Mineral Black roof | | | | | | | | ● | | | |
| GSI styling • Carbon-effect door mirror housings and front grille bar • Body-colour door handles • Body-colour front lower spoiler/side sills/rear lower skirt • Rear roof spoiler | | | | | | | | | ● | | |
| Black foil on B-pillars (not with Aegean Blue or optional Mineral Black or Darkmoon Blue exterior colours) | ● | ● | ● | ● | ● | ● | ● | ● | ● | | |
| Windows • Tinted windows | ● | ● | ● | ● | ● | ● | ● | ● | ● | | |
| • Dark-tinted rear windows | | ○ | ○ | ● | ● | ○ | ○ | ● | ● | 237.50 | 285.00 |







FEATURES/OPTIONS

OPTION PACKS

| | Active | Design | Energy | Griffin | Sport | SRI Nav | SE Nav | SRI VX-Line Nav Black | GSi | Price (£) exc. VAT | Price (£) inc. VAT |
|---|--------|--------|--------|---------|-------|---------|--------|-----------------------|-----|--------------------|--------------------|
| Sight and Light Pack <hr/> <ul style="list-style-type: none"> • Rain-sensitive windscreen wipers • Automatic lighting control • Automatically dimming anti-dazzle rear-view mirror | | ○ | ● | ● | ○ | ● | ● | ● | ○ | 200.00 | 240.00 |
| Winter Pack <hr/> <ul style="list-style-type: none"> • Heated leather-covered steering wheel • Heated front seats | | ○ | ● | ● | ○ | ○ | ● | ○ | ○ | 303.17 | 365.00 |
| GSi Plus Pack <hr/> <ul style="list-style-type: none"> • Recaro leather seats • 18-inch diamond-cut alloy wheels • Bi-xenon headlights with cornering light | | | | | | | | | ○ | 1,583.33 | 1,900.00 |

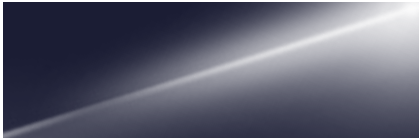

EXTERIOR COLOURS







| | | | Active | Design | Energy | Griffin | Sport | SRI Nav | SE Nav | SRI VX-Line Nav Black | GSI | Price (£) exc. VAT | Price (£) inc. VAT |
|-----------|--|---|--------|--------|--------|---------|-------|---------|--------|-----------------------|-----|--------------------|--------------------|
| Solid |  | Aegean Blue • Not available with Network Moonray cloth trim | ● | ● | ● | ● | ● | ● | ● | ● | | | |
| Brilliant |  | Mandarina • Only available with Network Moonray cloth trim | | | | | | | | ○ | ● | | |
| |  | Lava Red | ○ | ○ | ○ | ○ | ○ | ○ | ○ | ○ | ○ | 245.83 | 295.00 |
| |  | Summit White | ○ | ○ | ○ | ○ | ○ | ○ | ○ | ○ | ○ | | |

The colours reproduced may vary slightly from the actual paint colour. As a result they should be used as a guide only. Your Vauxhall Retailer has a comprehensive display of our paint samples. Colours and model variants for Griffin special edition subject to availability. Please check with your Vauxhall Retailer.

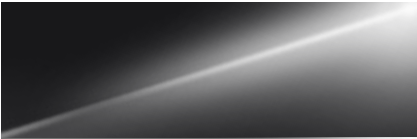
● = Standard equipment. ○ = Optional at extra cost.

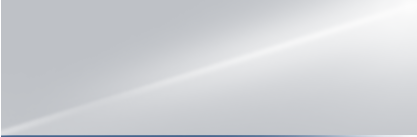





EXTERIOR COLOURS

| | | Active | Design | Energy | Griffin | Sport | SRI Nav | SE Nav | SRI VX-Line Nav Black | GSI | Price (£) exc. VAT | Price (£) inc. VAT | |
|----------|---|--|--------|--------|---------|-------|---------|--------|-----------------------|-----|--------------------|--------------------|--------|
| Two-coat |  | Mineral Black metallic | | | | | | | | | | 470.83 | 565.00 |
| |  | Satin Steel Grey metallic | | | | | | | | | | | |
| |  | Sovereign Silver metallic | | | | | | | | | | | |
| |  | Persian Blue metallic | | | | | | | | | | | |
| |  | Darkmoon Blue premium | | | | | | | | | | | |
| Tri-coat |  | Abalone White Premium • 5-door models only | | | | | | | | | | 604.17 | 725.00 |

The colours reproduced may vary slightly from the actual paint colour. As a result they should be used as a guide only. Your Vauxhall Retailer has a comprehensive display of our paint samples.
Colours and model variants for Griffin special edition subject to availability. Please check with your Vauxhall Retailer.





● = Standard equipment. ○ = Optional at extra cost.

WHEELS AND TYRES

| | Active | Design | Energy | Griffin | Sport | SRI Nav | SE Nav | SRI VX-Line Nav Black | GSI | Price (£) exc. VAT | Price (£) inc. VAT |
|--|--------|--------|--------|---------|-------|---------|--------|--------------------------|--------|-----------------------|-----------------------|
|  <p>15-inch structure steel wheels with styled covers</p> <ul style="list-style-type: none"> • 185/65 R 15 tyres • Emergency tyre inflation kit (in lieu of spare wheel) | | ● | | | | | | | | | |
|  <p>15-inch alloy wheels</p> <ul style="list-style-type: none"> • 185/65 R 15 tyres • Emergency tyre inflation kit (in lieu of spare wheel) | ● | ○ | | | | | | | 166.67 | 200.00 | |
|  <p>16-inch silver 4-twinspoke alloy wheels</p> <ul style="list-style-type: none"> • 195/55 R 16 tyres • Emergency tyre inflation kit (in lieu of spare wheel) • Standard on SRI Nav 5-door models, no-cost option on SRI Nav 3-door models | | | ● | | ● | ● | | | | | |
|  <p>16-inch black 4-twinspoke alloy wheels</p> <ul style="list-style-type: none"> • 195/55 R 16 tyres • Emergency tyre inflation kit (in lieu of spare wheel) • Standard on SRI Nav 3-door models, no-cost option on SRI Nav 5-door models | | | | ● | | ● | | | | | |



WHEELS AND TYRES

| | Active | Design | Energy | Griffin | Sport | SRI Nav | SE Nav | SRI VX-Line Nav Black | GSI | Price (£) exc. VAT | Price (£) inc. VAT |
|--|--------|--------|--------|---------|-------|---------|--------|-----------------------|-----|--------------------|--------------------|
|  <p>16-inch alloy wheels</p> <ul style="list-style-type: none"> • 195/55 R 16 tyres • Emergency tyre inflation kit (in lieu of spare wheel) | | | | | | | ● | | | | |
|  <p>17-inch silver alloy wheels</p> <ul style="list-style-type: none"> • 215/45 R 17 tyre • Emergency tyre inflation kit (in lieu of spare wheel) | | | ○ | | | | | | | 341.67 | 410.00 |
|  <p>17-inch Gloss black alloy wheels</p> <ul style="list-style-type: none"> • 215/45 R 17 tyres • Emergency tyre inflation kit (in lieu of spare wheel) | | | | | | | ● | | | | |
|  <p>17-inch 5-spoke bi-colour alloy wheels</p> <ul style="list-style-type: none"> • 215/45 R 17 tyres • Emergency tyre inflation kit (in lieu of spare wheel) | | | | | | | | ● | | | |



WHEELS AND TYRES

| | Active | Design | Energy | Griffin | Sport | SRI Nav | SE Nav | SRI VX-Line Nav Black | GSI | Price (£) exc. VAT | Price (£) inc. VAT |
|---|--------|--------|--------|---------|-------|---------|--------|-----------------------|-----|--------------------|--------------------|
|  <p>18-inch 5-Y-spoke diamond-cut, Titan alloy wheels</p> <ul style="list-style-type: none"> • 215/40 R 18 tyres • Emergency tyre inflation kit (in lieu of spare wheel) • Available as part of GSi Plus Pack | | | | | | | | | ○ | 425.00 | 510.00 |
| Steel emergency spare wheel (in lieu of emergency tyre inflation kit) | | | ○ | | ○ | ○ | ○ | | | 91.67 | 110.00 |
| Full-size steel spare wheel (in lieu of emergency tyre inflation kit) | ○ | ○ | | | | | | | | 91.67 | 110.00 |



PERFORMANCE, FUEL ECONOMY AND EMISSIONS

| | Performance (manufacturer's figures) | | | | Fuel economy mpg (litres/100km)# | | CO ₂ emissions g/km* | Vehicle Excise Duty** | | Benefit in kind company car taxation rates - 2018/19 tax year |
|--------------------------------------|---|------------------------|------------------------|-------------------------------|-------------------------------------|------------------|------------------------------------|--------------------------|------------------|---|
| | Fuel Type | Wheel size (inches) | Maximum speed (mph) | Acceleration 0-62mph (sec) | Combined Low | Combined High | | First year rate | Standard rate | |
| CORSA | | | | | | | | | | |
| 1.4i (75PS) | Petrol | 15/16 | 101 | 15.5 | 42.2 (6.7) | 44.1 (6.4) | 128 | £165 | £140 | 26% |
| 1.4i (75PS) | Petrol | 17 | 101 | 15.5 | 42.2 (6.7) | 44.1 (6.4) | 131 | £205 | £140 | 27% |
| 1.4i (90PS) | Petrol | 15/16 | 109 | 13.2 | 41.5 (6.8) | 44.1 (6.4) | 128 | £165 | £140 | 26% |
| 1.4i (90PS) | Petrol | 17 | 109 | 13.2 | 41.5 (6.8) | 44.1 (6.4) | 131 | £205 | £140 | 27% |
| 1.4i Turbo (100PS) Start/Stop | Petrol | 16 | 115 | 11.0 | 42.8 (6.6) | 44.1 (6.4) | 125 | £165 | £140 | 26% |
| 1.4i Turbo (100PS) Start/Stop | Petrol | 17 | 115 | 11.0 | 42.8 (6.6) | 44.1 (6.4) | 128 | £165 | £140 | 26% |
| 1.4i Turbo (150PS) Start/Stop | Petrol | 17 | 129 | 8.9 | 40.9 (6.9) | 43.5 (6.5) | 140 | £205 | £140 | 29% |
| 1.4i Turbo (150PS) Start/Stop | Petrol | 18 | 129 | 8.9 | 40.9 (6.9) | 43.5 (6.5) | 148 | £205 | £140 | 30% |
| 1.4i (90PS) automatic 3-door | Petrol | 15/16 | 106 | 13.9 | 37.7 (7.5) | 40.9 (6.9) | 136 | £205 | £140 | 28% |
| 1.4i (90PS) automatic 5-door | Petrol | 15/16 | 106 | 13.9 | 37.7 (7.5) | 40.9 (6.9) | 143 | £205 | £140 | 29% |
| 1.4i (90PS) automatic 3-door | Petrol | 17 | 106 | 13.9 | 37.7 (7.5) | 40.9 (6.9) | 142 | £205 | £140 | 29% |
| 1.4i (90PS) automatic 5-door | Petrol | 17 | 106 | 13.9 | 37.7 (7.5) | 40.9 (6.9) | 150 | £205 | £140 | 31% |

#Fuel consumption figures are determined according to the WLTP test cycle. Full data relating to WLTP test cycles can be found at: www.vauxhall.co.uk/wltp

*CO₂ emissions figures are determined according to the WLTP test cycle however, a Government formula is then applied to translate these figures back to what they would have been under the outgoing NEDC test cycle, which WLTP replaces. The correct tax treatment is then applied. Figures are intended for comparability purposes only. The fuel consumption you achieve under real life driving conditions and CO₂ produced will depend upon a number of factors, including the accessories fitted after registration, variations in driving styles, weather conditions and vehicle load. Only compare fuel consumption and CO₂ with other vehicles tested using the same technical procedures. For more information contact your local Vauxhall Retailer.

**Correct at time of publication.



DIMENSIONS

| CORSA | 3-DOOR | 5-DOOR |
|--|-------------|-------------|
| Loadspace Dimensions millimetres (inches) | | |
| Maximum length (seats up) | 705 (27.8) | 705 (27.8) |
| Maximum length* | 1372 (54.0) | 1372 (54.0) |
| Maximum width | 944 (37.2) | 944 (37.2) |
| Maximum height | 843 (33.2) | 876 (34.5) |
| Luggage Capacities** litres (cu.ft.) | | |
| Rear seat up | 280 (9.9) | 285 (10.0) |
| Rear seat down (to glassline) | 750 (26.5) | 710 (25.1) |
| Rear seat down (to roof) | 1090 (38.5) | 1120 (39.5) |

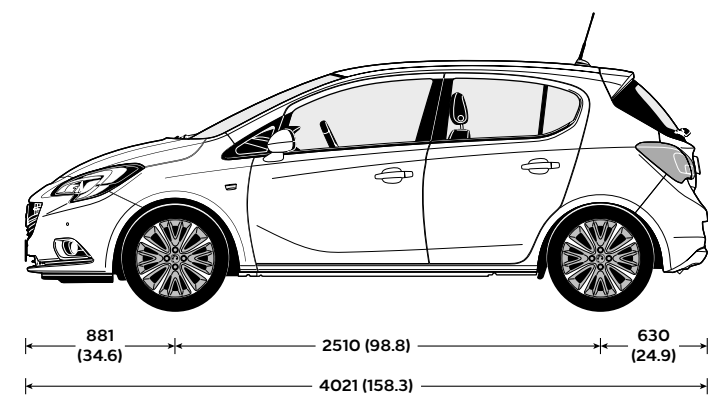
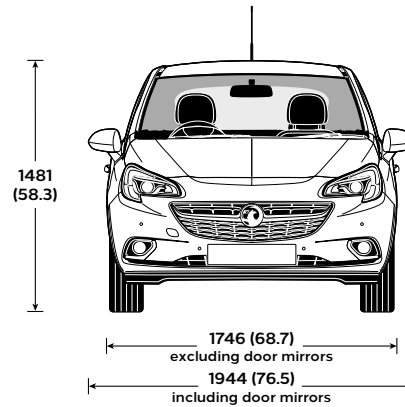
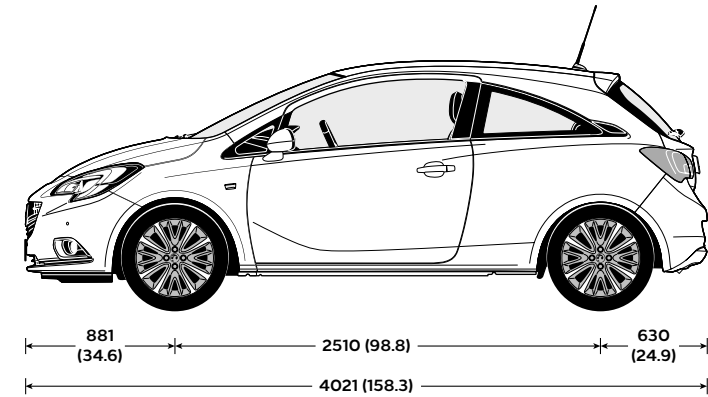
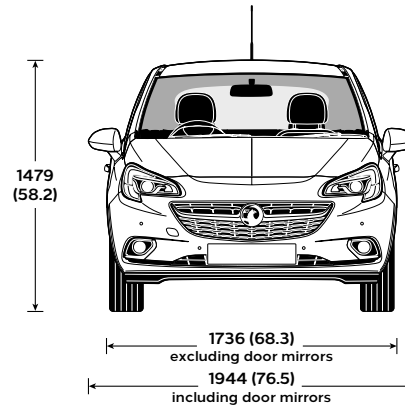

All measurements are in mm (inches) unless stated otherwise.

*Behind front seats.

**Measured using the ECIE method.



SPECIFICATIONS

Transmission

Five-speed manual gearbox:
1.4i (75PS), 1.4i (90PS) models

Six-speed manual gearbox:
1.4i Turbo (100PS), 1.4i Turbo (150PS) models

Six-speed automatic transmission with Active Select function:
Available at extra cost on certain 1.4i (90PS) models. Electronically controlled with adaptive driving function and fuel-saving eco mode. Fluid drive with torque converter, lock-up clutch and Active Select.

Suspension

Front: Independent. Lightweight MacPherson struts with gas-pressure dampers and coil springs.

Anti-roll bar.

Rear: Compound crank with coil springs and gas-pressure dampers

- Sports suspension on SRi VX-Line Nav Black, GSi models.

Body

- Aerodynamic drag co-efficient: Cd 0.33

Fuel Tank Capacity

- 45 litres (9.9 gallons)

Brakes

- Anti-lock Braking System (ABS)
- Electronic brakeforce distribution
- Emergency brake assist
- Cornering brake control
- Straight line stability control
- Dual circuit, diagonally split, dual rate servo-assisted system
- Low brake fluid level warning light

1.4i (75PS)

Front ventilated discs: 257mm diameter

Rear drums: 228mm diameter

1.4i (90PS)

Front ventilated discs: 257mm diameter

Rear drums: 228mm diameter

1.4i Turbo (100PS)

Front ventilated discs: 284mm diameter

Rear discs: 264mm diameter

1.4i Turbo (150PS)

Front ventilated discs: 308mm diameter

Rear discs: 264mm diameter

Weights and Towing Data kg

| | Gross vehicle weight | | Maximum towing weights Trailer with brakes (without brakes) | |
|---------------------------------------|----------------------|--------|---|------------|
| | 3-door | 5-door | 3-door | 5-door |
| 1.4i (75PS) Active | 1585 | - | 800 (550) | - |
| 1.4i (75PS) (excluding Active models) | 1600 | 1620 | 800 (550) | 800 (550) |
| 1.4i (90PS) automatic | 1630 | 1660 | 800 (550) | 800 (550) |
| 1.4i Turbo (100PS) | 1680 | 1710 | 1150 (580) | 1150 (580) |
| 1.4i Turbo (150PS) | 1690 | - | 1200 (580) | - |

Please note: Gross vehicle weight is the total permissible weight of the vehicle including passengers and their luggage. The maximum roof rack loading should not exceed 75kg. The maximum towing weights are based on the ability of the car, with two occupants of 75kg each, to restart on a 12% gradient, which is approximately 1 in 8.3, at sea level. The permitted trailer load applies up to the specified incline and up to an altitude of 1000 metres above sea level. The permissible gross train weight decreases by 10% for every 1000 metres of additional altitude. At altitudes above 1500 metres, the engine output may drop with a corresponding reduction in towing capability. Any extra weight, such as luggage or additional passengers, should be deducted from the maximum towing weight. With a trailer fully loaded, maximum noseweight should not exceed 55kg. Always fit Vauxhall towing attachments and accessories available from your Vauxhall Retailer. They are designed specifically for Vauxhall models and carry a 12-month guarantee.



PETROL ENGINES

| Engine | 1.4i (75PS) | 1.4i (90PS) | 1.4i Turbo (100PS) Start/Stop |
|-----------------------|---|---|---|
| Capacity | 1398cc | 1398cc | 1364cc |
| Maximum power | 75PS (55kW) @ 4200-6000rpm | 90PS (66kW) @ 6000rpm | 100PS (74kW) @ 3500-6000rpm |
| Maximum torque | 130Nm (96 lb.ft.) @ 4000rpm | 130Nm (96 lb.ft.) @ 4000rpm | 200Nm (147 lb.ft.) @ 1850-3500rpm |
| Configuration | 4 cylinders, 4 valves per cylinder, double overhead camshafts | 4 cylinders, 4 valves per cylinder, double overhead camshafts | 4 cylinders, 4 valves per cylinder, double overhead camshafts |
| Fuel/induction system | Naturally aspirated with Variable Valve Timing. Multi-point sequential fuel injection | Naturally aspirated with Variable Valve Timing. Multi-point sequential fuel injection | Turbocharger with intercooler. Variable Valve Timing. Multi-point sequential fuel injection |
| Emission compliance | Euro 6d-TEMP (6.2) | Euro 6d-TEMP (6.2) | Euro 6d-TEMP (6.2) |
| Service interval | 20,000 miles or 1 year (whichever occurs sooner) | 20,000 miles or 1 year (whichever occurs sooner) | 20,000 miles or 1 year (whichever occurs sooner) |

| Engine | 1.4i Turbo (150PS) Start/Stop |
|-----------------------|---|
| Capacity | 1364cc |
| Maximum power | 150PS (110kW) @ 5000rpm |
| Maximum torque | 220Nm (162lb.ft.) @ 2750-4500 |
| Configuration | 4 cylinders, 4 valves per cylinder, double overhead camshafts |
| Fuel/induction system | Turbocharger with intercooler. Variable Valve Timing. Multi-point sequential fuel injection |
| Emission compliance | Euro 6d-TEMP (6.2) |
| Service interval | 20,000 miles or 1 year (whichever occurs sooner) |



ACCESSORIES

| CHILD SEATS ¹ | Total (inc. VAT) | PRACTICAL | Total (inc. VAT) | TRANSPORT SYSTEMS | Total (inc. VAT) | ALLOY WHEELS (set of four with centre caps) ⁵ | Total (inc. VAT) |
|---|------------------|---|------------------|--|------------------|---|------------------|
| BABY-SAFE ² – 0-13kg/birth to 15 months | £132 | Spare bulb kit – ultra white | £38 | Roof base carrier | £149 | 15-inch 8-spoke – silver | £653 |
| – ISOFIX base | £240 | Stretch tow rope – 3000kg | £35 | Roof carriers (requires base carrier) | | 16-inch 4-double-spoke – white or silver | £773 |
| DUO ISOFIX ² – 9-18kg/9 months to 4 years | | Flexible cupholder | £16 | Bike roof carrier – Thule Freeride 532 | £78 | 16-inch 4-double-spoke – black | £897 |
| with top tether kit | £367 | Foldable armrest with storage | £106 | Surf board roof carrier – Thule 833 | £82 | 16-inch 6-double-spoke – silver | £773 |
| KID ² – 15-36kg or 4 to 12 years | £166 | | | Kayak roof carrier – Thule 837 | £172 | 17-inch 5-twin-spoke – silver | £1,128 |
| | | PROTECTION | | Ski roof carrier (up to 4 pairs) | | 17-inch 8-spoke – Titan gloss | £1,114 |
| SAFETY | | Carpet floor mats – set of four | £33 | – Thule Deluxe 7324 | £161 | | |
| Privacy shades – rear side windows (3-dr) | £75 | Rubber floor mats – front pair | £39 | Ski roof carrier (up to 6 pairs) | | | |
| Privacy shades – rear window (3-dr) | £92 | Rubber floor mats – rear pair | £26 | – Thule 7326 | £190 | | |
| Privacy shades – rear side windows (5-dr) | £94 | Velour floor mats – set of four | £64 | Hard shell roof boxes (requires base carrier) | | | |
| Parking sensors | | Cargo liner | £78 | Thule Ocean 80 | | | |
| – four fully flush front bumper mounted sensors | | Luggage storage box – with dividers | £112 | (320 litre / 1330 x 860 x 370mm) | £154 | | |
| – painted ³ | £323 | Rear bumper protection foil | £58 | Thule Ocean 200 | | | |
| – four fully flush rear bumper mounted sensors | | Splash Guards – front and rear set ⁴ | £112 | (450 litre / 1750 x 820 x 450mm) | £323 | | |
| – painted | £323 | Stainless steel door sills 3dr | £69 | Thule Motion 800 | | | |
| Safety Pack – first aid kit, warning triangle, hi-visibility vest, Vauxhall bag | £37 | Stainless steel door sills 5dr | £69 | (460 litre / 2050 x 840 x 450mm) | from £463 | | |
| First aid kit | £15 | Illuminated door sills 3dr | £157 | Thule Touring 200 | | | |
| Warning triangle | £18 | STYLING | | (400 litre / 1750 x 820 x 450mm) | £338 | | |
| Fire extinguisher – 2kg | £39 | Decal Package Sport Bonnet, Roof & Tailgate | | Thule Touring 780 | | | |
| Hi-visibility vest | £9 | – 3dr White | £192 | (430 litre / 2320 x 700 x 420mm) | £378 | | |
| Tyre sealant | £77 | Stainless steel pedal covers – manual | £162 | | | | |
| | | Exhaust tip | £67 | | | | |
| | | Exterior Mirror Cap Carbon Flash | £42 | | | | |
| FLEXCONNECT RANGE | | | | | | | |
| FlexConnect bracket | £21 | | | | | | |
| FlexConnect hook | £31 | | | | | | |
| FlexConnect coat hanger | £34 | | | | | | |
| FlexConnect folding table | £76 | | | | | | |
| FlexConnect iPad Mini cradle | £107 | | | | | | |
| FlexConnect iPad (1-4) cradle | £116 | | | | | | |
| FlexConnect iPad Air cradle | £115 | | | | | | |
| FlexConnect Samsung Galaxy cradle | £105 | | | | | | |

Please note: Prices shown are fully fitted and painted, where applicable and include VAT. Please check with your local Vauxhall Retailer for details. It is advisable to ensure your insurance policy is adequate to cover additional fitted accessories. Prices correct at time of publication.

1 = Restrictions apply to the use of child seats, please consult your Vauxhall Retailer or request a copy of the Child seats brochure. 2 = Without transponder. 3 = For use in conjunction with rear parking sensors. 4 = Not available with certain exterior styling accessories. 5 = Fitting time is based on four wheels fitted and includes static wheel balancing. Different tyres and locking wheel nuts may be required. Price excludes new tyres and locking wheel nuts.



COMPANY CAR DRIVER AND FLEET INFORMATION

Design and Tech Line High Spec Low P11D

Specifically developed for businesses and company car drivers alike, our Design and Tech Line Nav models are seriously fit for Fleet.

Design models all feature very low P11D values, generous standard specification, including Sat Nav on Design Nav models, and a choice of high tech ecoTEC engines for great fuel economy and low emissions.

For even more standard specification, step up to our Tech Line Nav range. Again you are guaranteed low P11D values, plus great standard kit including Sat Nav, Bluetooth®, USB connection, aux-in socket and digital radio.

With Design and Tech Line Nav you can take for granted low Whole Life Costs and low company car driver taxation.

Company Car Driver Free 3 Day Test Drive

Our free* 3 Day Test Drive programme is open to all Company Car Drivers which allows you to choose any model in the current Vauxhall line-up (exclusions apply). With full insurance cover provided, it gives you a meaningful length of time to make an informed decision about your next company car.

Search Vauxhall 3DTD to book your FREE* test drive or click the link the below:

[Vauxhall 3 Day Test Drive](#)

*The free 3 Day Test Drive programme is open to Company Car Drivers and Fleet Decision Makers. Available for UK Mainland only. Terms and conditions apply. Full terms and conditions can be found at vauxhallfleet.co.uk/testdrive/index/terms.

Benefit in kind company car taxation†

The car benefit charge will be the car's list price (including VAT, options and accessories fitted, delivery to Retailer and number plates, but excluding Vehicle Excise Duty and new vehicle first registration fee) multiplied by the percentage charge for the CO₂ emissions band in which the car falls (see table opposite). Multiply this figure by your personal income tax rate (20%^{††} for Basic Rate, 40%^{††} for Higher Rate) to calculate your annual benefit in kind tax liability.

Example:

Corsa SE Nav 1.4i Turbo (100PS) Start/Stop 5-door hatchback (CO₂ emissions 128g/km)

| | |
|--|------------|
| On-the-road RRP | £17,330.00 |
| Deduct: Vehicle Excise Duty | (£165.00) |
| New vehicle first registration fee | (£55.00) |
| Effective list price | £17,110.00 |
| Add: Optional two-coat metallic paint | £565.00 |
| List price for tax purposes (P11D value) | £17,675.00 |
| Car benefit charge 2018-19 tax year (26%) | £4,596.00 |
| Benefit in kind tax liability (2018-19 tax year) | |
| Basic Rate (20%) tax payer | £919.20 |
| Higher Rate (40%) tax payer | £1,838.40 |

†Please note this Price Guide provides taxation information as a guide only. Vauxhall does not provide taxation guidance. Drivers should always take professional advice on their own tax position. ††Excludes residents of Scotland.

BIK FOR SCOTTISH RESIDENTS

Effective 6 April 2018 the Scottish Government have introduced their own BIK taxation structure. This only applies to Company Car Drivers that are Scottish taxpayers. HMRC will determine whether or not an individual is a Scottish taxpayer based on where their main place of residence is.

The BIK rates for Scotland are:

- Over £11,850-£13,850 Starter Rate 19%
- Over £13,850-£24,000 Basic Rate 20%
- Over £24,000-£43,430 Intermediate Rate 21%
- Over £43,430-£150,000 Higher Rate 41%
- Above £150,000 Top Rate 46%

Benefit in kind company car taxation table

| CO ₂ emissions in grams per kilometre | Percentage of cars price to be taxed | |
|--|--|---------------------------------------|
| | Non-Diesel [†] 2018-19 tax year | Diesel ^{††} 2018-19 tax year |
| Up to 50 | 13 | 17 |
| 51-75 | 16 | 20 |
| 76-94 | 19 | 23 |
| 95-99 | 20 | 24 |
| 100-104 | 21 | 25 |
| 105-109 | 22 | 26 |
| 110-114 | 23 | 27 |
| 115-119 | 24 | 28 |
| 120-124 | 25 | 29 |
| 125-129 | 26 | 30 |
| 130-134 | 27 | 31 |
| 135-139 | 28 | 32 |
| 140-144 | 29 | 33 |
| 145-149 | 30 | 34 |
| 150-154 | 31 | 35 |
| 155-159 | 32 | 36 |
| 160-164 | 33 | 37 |
| 165-169 | 34 | 37 |
| 170-174 | 35 | 37 |
| 175-179 | 36 | 37 |
| 180 and above | 37 | 37 |

†Also applies to diesel vehicles that meet the Real Driving Emissions Step 2 (RDE2). ††Applies to vehicles that do not meet the Real Driving Emissions Step 2 (RDE2).

To calculate your own personal liability, search: **Vauxhall BiK**, or click the link below: [Vauxhall BiK Tool](#)

Fleet Toolbox

Discover the facts in our online Toolbox for both Company Car Drivers and Fleet Decision Makers. The Fleet Toolbox has a host of useful calculators, comparators, interactive listings and information.

Search Vauxhall Fleet Tools or click the link below: [Vauxhall Fleet Tool Box](#)

Contact Vauxhall Fleet

Please contact one of our dedicated sales teams who will be happy to help with your particular enquiry.

Company Car Drivers

Call: 0345 111 2020

Email: company-car@vauxhallinfo.co.uk

Telephone lines are open

– Monday to Friday 8:00am-9:00pm

– Saturday and Sunday 9:00am-6:00pm

Fleet Decision Makers

Depending on the size of your fleet of vehicles, we have a dedicated team to handle your enquiries. The lines are open Monday to Friday excluding Bank Holidays.

1-24 vehicles

Call: 0845 076 2254 (8:30am-5:00pm)

25+ vehicles

Call: 0330 587 8222 (8:30am-5:00pm)

Email: vauxhallfleet@vauxhall.co.uk

Special Vehicles (Police, Fire and Ambulance)

Call: 01582 409999 (8:30am-5:00pm)

Email: vauxhallspecialvehicles@vauxhall.co.uk



FURTHER INFORMATION

On-the-road prices

To eliminate uncertainty about hidden costs when buying a new car, Vauxhall publishes on-the-road recommended retail prices (RRP) and these are shown in the pricing tables within this price guide. These prices include VAT, number plates and delivery to Retailer of £700.00 (including £116.67 VAT), 12 months' Government Vehicle Excise Duty (see opposite for details) and the DVLA new vehicle first registration fee of £55.00.*

Please note: The on-the-road recommended retail price (RRP) does not include fuel supplied by the Retailer, motor insurance or any other goods or services supplied by agreement between the Retailer and the customer.

Price protection

Order a new Vauxhall for build in the current model year (as confirmed by your Retailer) for delivery no more than three months in advance and the price you are quoted is the price you pay. This is irrespective of any subsequent price rises between placing your order and delivery of your new car, but you must take delivery as soon as the car is available. Vauxhall Motors Limited is not liable for price adjustments caused by Government changes in the rate of VAT (currently 20%), Vehicle Excise Duty, DVLA new vehicle first registration fee or by any other applicable legislation or regulations.

Vauxhall Finance Leasing

Vauxhall Finance Leasing is a trading style of Vauxhall Finance plc. Working with the Vauxhall Retailer network we provide competitive car and van leasing solutions for business users and private individuals. We combine the support of a national contract with the convenience of a local contact. For further information, please contact your local Vauxhall Retailer or visit www.vauxhall.co.uk/leasing

In the event of an accident

Vauxhall Accident Management helps keep you mobile following an accident. Benefits include vehicle recovery, Vauxhall-approved repairs and contacting your insurer. For more details, visit www.vauxhall.co.uk/AccidentManagement

Vehicle Excise Duty

The amount of Vehicle Excise Duty (road fund licence) payable on new cars varies depending on the level of carbon dioxide (CO₂) emissions produced by the vehicle. CO₂ emissions are measured in grams per kilometre (g/km) travelled and divided into 13 charging bands shown in the table opposite.

A 'first year rate' of Vehicle Excise Duty is payable on all new cars and in subsequent years the amount payable reverts to the 'standard rate'. From 1 April 2017 the breakpoints for each of these bands have been revised. Also, for vehicles with a list price over £40,000, including factory-fitted options, an additional £310 is payable for the first five years of standard rate payments.

Vehicle Excise Duty*

| Band | CO ₂ emissions in grams per kilometre | First year rate | | |
|------|--|---------------------|---------------------|---------------|
| | | Petrol [#] | Diesel [†] | Standard rate |
| A | 0 | £0 | £0 | £0 |
| B | 1-50 | £10 | £25 | £140 |
| C | 51-75 | £25 | £105 | £140 |
| D | 76-90 | £105 | £125 | £140 |
| E | 91-100 | £125 | £145 | £140 |
| F | 101-110 | £145 | £165 | £140 |
| G | 111-130 | £165 | £205 | £140 |
| H | 131-150 | £205 | £515 | £140 |
| I | 151-170 | £515 | £830 | £140 |
| J | 171-190 | £830 | £1,240 | £140 |
| K | 191-225 | £1,240 | £1,760 | £140 |
| L | 226-255 | £1,760 | £2,070 | £140 |
| M | over 255 | £2,070 | £2,070 | £140 |

*Correct at time of issue.

[#]Also applies to diesel vehicles that meet the Real Driving Emissions Step 2 (RDE2).

[†]Applies to vehicles that do not meet the Real Driving Emissions Step 2 (RDE2).



FURTHER INFORMATION

Insurance Groups*

| | Active | Design | Energy | Griffin | Sport | SRI Nav | SE Nav | SRI VX-Line Nav Black | GSI |
|------------------------|--------|--------|--------|---------|-------|---------|--------|--------------------------|-----|
| 1.4i (75PS) | 3E | 3E | 3E | 4E | 4E | 4E | 4E | 4E | - |
| 1.4i (90PS) | - | 6E | 6E | 7E | 7E | 8E | 7E | 8E | - |
| 1.4i (90PS) automatic | - | 6E | 6E | - | - | 7E | 7E | - | - |
| 1.4i Turbo (100PS) S/S | - | - | 11E | - | - | 11E | 11E | 12E | - |
| 1.4i Turbo (150PS) S/S | - | - | - | - | - | - | - | - | 20E |



FURTHER INFORMATION

Customer Care Commitment

For added peace of mind, Vauxhall has an innovative Customer Care Commitment that offers the following:

- Three-year vehicle warranty consisting of a one-year/unlimited mileage manufacturer's warranty and a second and third year manufacturer's warranty with a 60,000 miles limitation
- Vauxhall Assistance for 12 months from first registration
- Six years' body panel anti-perforation warranty

Please note: Warranty is only available on vehicles sourced from Vauxhall Motors Limited. Terms and conditions apply. Please see your Vauxhall Retailer for details.

Vauxhall Assistance

Vauxhall Assistance is provided automatically with every new Vauxhall for 12 months from first registration and covers everything from accident assistance, roadside recovery and 'at home' service to flat tyres. With Vauxhall Assistance help is literally just a free* phone call away, 24 hours a day, 365 days a year!

*Mobile phone users will be charged at their standard tariff.

Protecting the environment

Vauxhall's commitment to the environment is demonstrated by our products' many environmental awards. For even more information on Vauxhall's efforts to achieve an environmentally sustainable future, and how to dispose of your end-of-life vehicle, see www.vauxhall.co.uk/recycling

Vauxhall Service Plan

- Fixed monthly payments for the plan duration
- Easy to budget and interest-free
- Genuine parts fitted by Vauxhall-trained technicians
Plus on Gold plans:
- Valet and courtesy car
- Full AA cover
- Engine flush and fuel treatments
- Litre of oil for top ups between services

Full details can be obtained from your local participating Vauxhall Retailer.

Vauxhall Insurance with added reassurance

Comprehensive cover – Summary of benefits**

- Competitive premiums
- Repairs by a Vauxhall-trained technician
- Genuine Vauxhall parts, guaranteed for three years when we repair your car within our Approved Repairer Network
- Free courtesy car as standard when using an Approved Repairer†
- 24 hour claims helpline
- Personal Accident benefit
- Cover for audio equipment
- Windscreen cover

Call for a quote on **0844 463 2670**††

**The benefits listed above are for comprehensive cover only. For details of Third Party, Fire and Theft cover, please call our sales team.

†Should your car need repairing following an accident we provide a courtesy car (subject to availability) for the duration of the repair. Only genuine Vauxhall parts are used. Terms and conditions apply.

††Calls may be recorded. Vauxhall Insurance is underwritten by Ageas Insurance Limited.

For more product information

For further information on the Vauxhall range or location of your nearest Vauxhall Retailer please call **0345 600 1500**. Alternatively, details can be found on our website at www.vauxhall.co.uk

Join us online



Privacy Policy – for full details visit www.vauxhall.co.uk/privacy

The invoice price, including delivery to Retailer, factory-fitted options, accessories fitted by the Retailer and number plates, is subject to VAT. Some feature descriptions in this guide may refer to, and some illustrations may show, optional equipment not included in the standard delivery. The information contained in this guide was accurate at the time of publication. We reserve the right to make changes in design and equipment. Please note that Vauxhall Retailers are not the agents of Vauxhall Motors Limited and are not authorised to bind Vauxhall Motors Limited by any specific or implied undertaking or representation. It is advisable to ensure that your motor insurance policy provides adequate cover for additional fitted options and accessories. The colours in this guide are only approximate actual colours. Illustrated optional equipment is available at extra charge. Availability, technical features and equipment provided on our vehicles can vary by model. For precise information on the equipment provided on our vehicles, please contact your local Vauxhall Retailer.

VAUXHALL

vauxhall.co.uk

©2019 Vauxhall Motors Limited

Published 28 January 2019 (Amended 7 February 2019) Vauxhall Motors Limited