

CORSA

PRICE/SPECIFICATION GUIDE

1 April 2018 | Model Year 2018.5



Contents:

Model Year 2018.5 (pages 2-41)

Pre-current Model Year (pages 43-72)





VAUXHALL

CORSA RANGE HIGHLIGHTS



STANDARD FEATURES
<p>Infotainment:</p> <ul style="list-style-type: none"> • Six speakers <p>Interior convenience / styling:</p> <ul style="list-style-type: none"> • Cruise control • Speed-sensitive power-assisted steering • Steering column adjustable for reach / rake • Steering wheel audio / phone / cruise controls • Driver's seat height adjuster <p>Exterior convenience / styling:</p> <ul style="list-style-type: none"> • Heated windscreen • Remote control central locking • Electrically operated front windows • Electrically adjustable door mirrors • Black B-pillars (with certain exterior colours) <p>Safety / security features:</p> <ul style="list-style-type: none"> • Electronic Stability Programme (ESP) • Anti-lock Braking System (ABS) • Six airbags • Hill start assist • Seatbelt reminders for all seats • ISOFIX child seat mounting points on outer rear seats • Tyre pressure monitoring system • Daytime running lights • Engine deadlock immobiliser

STING	OTR from £11,050
<p><i>Additional over standard features:</i></p> <p>Infotainment:</p> <ul style="list-style-type: none"> • CD 30 BT audio system <ul style="list-style-type: none"> – AM/FM radio – CD/MP3 CD player – Bluetooth® mobile phone portal – USB audio connection – Aux-in socket <p>Interior convenience / styling:</p> <ul style="list-style-type: none"> • Leather-covered steering wheel <p>Exterior convenience / styling:</p> <ul style="list-style-type: none"> • Twin white stripes on bonnet, roof and tailgate • White door mirror housings and front grille bar • 16-inch white 4-twinspoke alloy wheels 	
	

ENERGY	OTR from £13,840
<p><i>Additional over standard features:</i></p> <p>Infotainment:</p> <ul style="list-style-type: none"> • IntelliLink audio system <ul style="list-style-type: none"> – 7-inch colour touchscreen – AM/FM/DAB digital radio – Bluetooth® audio streaming – Bluetooth® mobile phone portal – Apple CarPlay™ / Android Auto™ – USB audio connection <p>Interior convenience / styling:</p> <ul style="list-style-type: none"> • Air conditioning (non air-conditioned models available) • Heated leather-covered steering wheel • Heated front seats <p>Exterior convenience / styling:</p> <ul style="list-style-type: none"> • Electrically adjustable / heated door mirrors • Automatic lighting control • Rain-sensitive windscreen wipers • Front fog lights • 16-inch 8-spoke alloy wheels <p>Safety / security features:</p> <ul style="list-style-type: none"> • LED daytime running lights 	
	

CORSA RANGE HIGHLIGHTS



SRI OTR from £13,445

Additional over standard features:

Infotainment:

- IntelliLink audio system
 - 7-inch colour touchscreen
 - AM/FM/DAB digital radio
 - Bluetooth® audio streaming
 - Bluetooth® mobile phone portal
 - Apple CarPlay™ / Android Auto™
 - USB audio connection

Interior convenience / styling:

- Air conditioning
- Leather-covered steering wheel
- Sports-style front seats

Exterior convenience / styling:

- Rain-sensitive windscreen wipers
- Automatic lighting control
- Electrically adjustable / heated door mirrors
- Front fog lights with chrome-effect surround
- 16-inch black 4-twinspoke alloy wheels (3-door)
 - no-cost option on 5-door models
- 16-inch silver 4-twinspoke alloy wheels (5-door)
 - no-cost option on 3-door models

Safety / security features:

- LED daytime running lights



SRI VX-LINE OTR from £14,480

Features over SRI:

Exterior convenience / styling:

- VX-Line body styling:
 - Front lower spoiler
 - Side sills / rear lower skirt
 - Rear roof spoiler (3-door only)
- Chrome-effect exhaust tailpipe extension
- Sports suspension
- 17-inch alloy wheels



LIMITED EDITION OTR from £16,205

Additional over standard features:

OnStar:

- Automatic crash response / Wi-Fi hotspot / smartphone app / stolen vehicle assistance / vehicle diagnostics

Infotainment:

- IntelliLink audio system
 - 7-inch colour touchscreen
 - AM/FM/DAB digital radio
 - Bluetooth® audio streaming
 - Bluetooth® mobile phone portal
 - Apple CarPlay™ / Android Auto™
 - USB audio connection

Interior convenience / styling:

- Air conditioning
- Sports-style front seats
- VX-Line styling: Leather-covered flat-bottom steering wheel / gear knob / handbrake lever

Exterior convenience / styling:

- VX-Line body styling: Front lower spoiler / side sills / rear skirt / VXR rear roof spoiler (3-door only)
- Roof / door mirrors / front grille bar in black
- Dark-tinted rear windows
- Chrome-effect exhaust tailpipe extension
- Sports suspension
- Front fog lights
- 17-inch black alloy wheels



RED EDITION OTR from £18,725

Features over Limited Edition:

- Lava Red brilliant paint
- 1.4i Turbo (150PS) engine
- 17-inch diamond-cut alloy wheels



BLACK EDITION OTR from £18,725

Features over Red Edition:

- Mineral Black two-coat metallic paint



WHITE EDITION OTR from £18,725

Features over Red Edition:



- Summit White brilliant paint



CORSA RANGE HIGHLIGHTS



DESIGN	OTR from £12,775
<i>Additional over standard features:</i>	
Infotainment:	
<ul style="list-style-type: none"> • IntelliLink audio system <ul style="list-style-type: none"> – 7-inch colour touchscreen – AM/FM/DAB digital radio – Bluetooth® audio streaming – Bluetooth® mobile phone portal – Apple CarPlay™ / Android Auto™ – USB audio connection 	
Interior convenience / styling:	
<ul style="list-style-type: none"> • Air conditioning • Leather-covered steering wheel 	
Exterior convenience / styling:	
<ul style="list-style-type: none"> • Front fog lights • 15-inch structure steel wheels with styled wheel covers 	
Safety / security features:	
<ul style="list-style-type: none"> • LED daytime running lights 	
	





SE	OTR from £14,340
<i>Features over Design:</i>	
OnStar:	
<ul style="list-style-type: none"> • Automatic crash response / Wi-Fi hotspot / smartphone app / stolen vehicle assistance / vehicle diagnostics 	
Interior convenience / styling:	
<ul style="list-style-type: none"> • Auto anti-dazzle rear-view mirror • Multi-function trip computer • Heated leather-covered steering wheel • Heated front seats • Graphic Embossed cloth/Morrocana trim • 60/40 split-folding rear seat back 	
Exterior convenience / styling:	
<ul style="list-style-type: none"> • Auto lighting / windscreen wipers • Electrically adjustable / heated door mirrors • Front / rear parking sensors • Front fog lights with chrome-effect surround • Chrome-effect lower side window mouldings (5-door only) • 16-inch multi-spoke alloy wheels 	
	
	

ELITE	OTR from £17,985
<i>Features over SE:</i>	
Interior convenience / styling:	
<ul style="list-style-type: none"> • Electronic climate control • Rear-view camera 	
Exterior convenience / styling:	
<ul style="list-style-type: none"> • Bi-xenon headlights • Dark-tinted rear windows • Sports suspension (not with optional 16-inch alloy wheels) • 17-inch diamond-cut alloy wheels 	
	
	

CORSA STING

		3-door hatchback		5-door hatchback	
		OTR RRP	CO ₂ (g/km)	OTR RRP	CO ₂ (g/km)
STING – ON-THE-ROAD PRICES					
Petrol	1.4i (75PS)	£11,050	118	–	–
	1.4i (90PS)	£11,295	118	–	–

Please note: On-the-road recommended retail prices (RRP) include VAT at 20%, number plates and delivery to Retailer of £700.00 (inc. £116.67 VAT), 12 months' Vehicle Excise Duty and new vehicle first registration fee of £55.00. Excludes fuel and insurance.

KEY OPTIONS		Total inc. VAT
 Looking good:	Brilliant paint	£285
	Metallic / pearlescent paint	£565
 Easier parking:	Front and rear parking sensors	£465
 Fresh air:	Air conditioning	£535
 Practicality:	60/40 split-folding rear seat back	£140
	Steel emergency spare wheel (in lieu of emergency tyre inflation kit)	£110
	Remote control alarm	£260

For details of these and other options please see Features/Options pages.



STING – FEATURES

Infotainment:

- CD 30 BT audio system
 - AM/FM radio
 - CD/MP3 CD player
 - Bluetooth® mobile phone portal
 - USB audio connection
 - Aux-in socket
- Six speakers

Interior convenience / styling:

- Cruise control
- Leather-covered steering wheel
- Speed-sensitive power-assisted steering
- Steering column adjustable for reach / rake
- Steering wheel audio / phone / cruise controls
- Driver's seat height adjuster



Exterior convenience / styling:

- Heated windscreen
- Remote control central locking
- Electrically operated front windows
- Electrically adjustable door mirrors
- Twin white stripes on bonnet, roof and tailgate
- White door mirror housings and front grille bar
- Black B-pillars (with certain exterior colours)
- 16-inch white 4-twinspoke alloy wheels

Safety / security features:

- Electronic Stability Programme (ESP)
- Anti-lock Braking System (ABS)
- Six airbags
- Hill start assist
- Seatbelt reminders for all seats
- ISOFIX child seat mounting points on outer rear seats
- Tyre pressure monitoring system
- Daytime running lights
- Engine deadlock immobiliser



CUSTOMER OFFERS*

-  Flexible Personal Lease
-  Flexible PCP (5.9% APR)

Please consult your Retailer for details.

* = Terms and conditions apply.

COMPANY CAR INFORMATION

-  P11D price starting at £10,830
-  From 24% tax band**
-  From £44 monthly BiK tax**
-  CO₂ emissions from 118g/km





Please see www.vauxhall.co.uk/fleet for details.

** = 2018/19 tax year.

CORSA DESIGN

		3-door hatchback		5-door hatchback	
		OTR RRP	CO ₂ (g/km)	OTR RRP	CO ₂ (g/km)
DESIGN – ON-THE-ROAD PRICES					
<i>Petrol</i>	1.4i (75PS)	£12,775	120	£13,375	120
	1.4i (90PS)	£13,020	120	£13,620	120
	1.4i (90PS) S/S Easytronic	£13,775	112	£14,375	112
	1.4i (90PS) auto	£14,425	137	£15,025	139
	1.0i Turbo (90PS) S/S ecoTEC	–	–	£15,085	107
<i>Diesel</i>	1.3CDTi (75PS) S/S	£14,925	104	£15,525	104
	1.3CDTi (95PS) S/S ecoTEC	£15,405	94	£16,005	94
	1.3CDTi (95PS) S/S ecoTEC Easytronic	£16,155	91	£16,755	91

Please note: On-the-road recommended retail prices (RRP) include VAT at 20%, number plates and delivery to Retailer of £700.00 (inc. £116.67 VAT), 12 months' Vehicle Excise Duty and new vehicle first registration fee of £55.00. Excludes fuel and insurance. S/S = Start/Stop.

KEY OPTIONS		Total inc. VAT
 Looking good:	Brilliant paint	£285
	Metallic / pearlescent paint	£565
	15-inch alloy wheels	£200
 Easier parking:	Front and rear parking sensors	£465
	Rear-view camera	£250
 Driving assistance:	OnStar – Automatic crash response / Wi-Fi / smartphone function / stolen vehicle assistance / vehicle diagnostics	£415
	Sight and Light Pack – Automatic lights / wipers / auto anti-dazzle rear-view mirror	£240
 Warm welcome:	Winter Pack – Heated front seats / steering wheel	£365
 Practicality:	60/40 split-folding rear seat back	£140
	Full-size steel spare wheel (in lieu of emergency tyre inflation kit) – not available with optional 16-inch steel wheels	£110
	Remote control alarm	£260

For details of these and other options please see Features/Options pages.



FEATURES

Infotainment:

- IntelliLink audio system
 - 7-inch colour touchscreen
 - AM/FM/DAB digital radio
 - Bluetooth® audio streaming
 - Bluetooth® mobile phone portal
 - Apple CarPlay™ / Android Auto™
 - USB audio connection
- Six speakers

Interior convenience / styling:

- Air conditioning
- Cruise control
- Leather-covered steering wheel
- Speed-sensitive power-assisted steering
- Steering column adjustable for reach / rake
- Steering wheel audio / phone / cruise controls
- Driver's seat height adjuster



Exterior convenience / styling:

- Heated windscreen
- Remote control central locking
- Electrically operated front windows
- Electrically adjustable door mirrors
- Front fog lights
- Black B-pillars (with certain exterior colours)
- 15-inch structure steel wheels with styled wheel covers

Safety / security features:





- Electronic Stability Programme (ESP)
- Anti-lock Braking System (ABS)
- Six airbags
- Hill start assist
- Seatbelt reminders for all seats
- ISOFIX child seat mounting points on outer rear seats
- Tyre pressure monitoring system
- LED daytime running lights
- Engine deadlock immobiliser

CUSTOMER OFFERS*

-  Flexible Personal Lease
-  Flexible PCP (5.9% APR)

Please consult your Retailer for details.

COMPANY CAR INFORMATION

-  P11D price starting at £12,555
-  From 22% tax band**
-  From £52 monthly BiK tax**
-  CO₂ emissions from 90g/km†

Please see www.vauxhall.co.uk/fleet for details.





* = Terms and conditions apply.

** = 2018/19 tax year. † = 1.3CDTi (95PS) S/S ecoTEC Easytronic with optional 16-inch wheels.

CORSA ENERGY

		3-door hatchback		5-door hatchback	
		OTR RRP	CO ₂ (g/km)	OTR RRP	CO ₂ (g/km)
ENERGY – ON-THE-ROAD PRICES					
<i>Petrol</i>	1.4i (75PS)	£13,840	118	£14,440	118
	1.4i (90PS)	£14,085	118	£14,685	118
	1.4i (75PS) (a/c)	£14,140	118	£14,740	118
	1.4i (90PS) (a/c)	£14,385	118	£14,985	118
	1.4i (90PS) S/S Easytronic (a/c)	£15,120	110	£15,720	110
	1.4i (90PS) auto (a/c)	£15,790	135	£16,390	137
	1.4i Turbo (100PS) S/S (a/c)	£15,040	119	£15,640	119
	1.0i Turbo (115PS) S/S (a/c)	£15,870	111	£16,470	113
	<i>Diesel</i>	1.3CDTi (75PS) S/S (a/c)	£16,290	102	£16,890

Please note: On-the-road recommended retail prices (RRP) include VAT at 20%, number plates and delivery to Retailer of £700.00 (inc. £116.67 VAT), 12 months' Vehicle Excise Duty and new vehicle first registration fee of £55.00. Excludes fuel and insurance. S/S = Start/Stop. a/c = Air conditioning.

KEY OPTIONS		Total inc. VAT
 Looking good:	Brilliant paint	£285
	Metallic / pearlescent paint	£565
 Easier parking:	Front and rear parking sensors	£465
	Advanced park assist – Additional sensors help find suitable parking spaces – The system automatically steers into the parking space. You just drive forwards or backwards as directed	£550
	Rear-view camera	£250
 Driving assistance:	OnStar – Automatic crash response / Wi-Fi / smartphone function / stolen vehicle assistance / vehicle diagnostics	£415
	 Fresh air:	Electronic climate control incorporating air conditioning
Electrically operated slide/tilt panoramic glass sunroof		£890
 Practicality:	60/40 split-folding rear seat back	£140
	Remote control alarm	£260

For details of these and other options please see Features/Options pages.



FEATURES

Infotainment:

- IntelliLink audio system
 - 7-inch colour touchscreen
 - AM/FM/DAB digital radio
 - Bluetooth® audio streaming
 - Bluetooth® mobile phone portal
 - Apple CarPlay™ / Android Auto™
 - USB audio connection
- Six speakers

Interior convenience / styling:

- Air conditioning (non air-conditioned models available)
- Heated leather-covered steering wheel
- Heated front seats
- Cruise control
- Speed-sensitive power-assisted steering
- Steering column adjustable for reach / rake
- Steering wheel audio / phone / cruise controls
- Driver's seat height adjuster



Exterior convenience / styling:

- Heated windscreen
- Remote control central locking
- Electrically operated front windows
- Electrically adjustable / heated door mirrors
- Automatic lighting control
- Rain-sensitive windscreen wipers
- Front fog lights
- Black B-pillars (with certain exterior colours)
- 16-inch 8-spoke alloy wheels

Safety / security features:

- Electronic Stability Programme (ESP)
- Anti-lock Braking System (ABS)
- Six airbags
- Hill start assist
- Seatbelt reminders for all seats
- ISOFIX child seat mounting points on outer rear seats
- Tyre pressure monitoring system
- LED daytime running lights
- Engine deadlock immobiliser



CUSTOMER OFFERS*

-  2 Year 0% APR PCP
-  Flexible PCP (5.9% APR) with £1800 Vauxhall Deposit Contribution
-  Flexible Personal Lease

Please consult your Retailer for details.

* = Terms and conditions apply.

COMPANY CAR INFORMATION

-  P11D price starting at £13,620
-  From 23% tax band**
-  From £55 monthly BiK tax**
-  CO₂ emissions from 102g/km

Please see www.vauxhall.co.uk/fleet for details.





** = 2018/19 tax year.

CORSA SRi / SRi VX-LINE

		3-door hatchback		5-door hatchback	
		OTR RRP	CO ₂ (g/km)	OTR RRP	CO ₂ (g/km)
SRi – ON-THE-ROAD PRICES					
Petrol	1.4i (75PS)	£13,445	118	£14,045	118
	1.4i (90PS)	£13,690	118	£14,290	118
	1.4i (90PS) auto	£15,095	135	£15,695	137
	1.0i Turbo (90PS) S/S ecoTEC	£15,155	102	£15,755	105
	1.4i Turbo (100PS) S/S	£14,345	119	£14,945	119
Diesel	1.3CDTi (75PS) S/S	–	–	£16,195	102
	1.3CDTi (95PS) S/S ecoTEC	£16,075	93	£16,675	93

SRi VX-LINE – ON-THE-ROAD PRICES					
Petrol	1.4i (75PS)	£14,480	120	£15,080	120
	1.4i (90PS)	£14,725	120	£15,325	120
	1.4i (90PS) auto	£16,130	137	£16,730	139
	1.4i Turbo (100PS) S/S	£15,380	122	£15,980	122
	1.0i Turbo (115PS) S/S	£16,210	113	£16,810	115
Diesel	1.3CDTi (75PS) S/S	–	–	£17,230	104
	1.3CDTi (95PS) S/S ecoTEC	£17,110	94	£17,710	94

Please note: On-the-road recommended retail prices (RRP) include VAT at 20%, number plates and delivery to Retailer of £700.00 (inc. £116.67 VAT), 12 months' Vehicle Excise Duty and new vehicle first registration fee of £55.00. Excludes fuel and insurance. S/S = Start/Stop.

KEY OPTIONS		Total inc. VAT
	Looking good: Brilliant paint	£285
	Metallic / pearlescent paint	£565
	Easier parking: Front and rear parking sensors	£465
	Advanced park assist – Additional sensors help find suitable parking spaces – The system automatically steers into the parking space. You just drive forwards or backwards as directed	£550
	Rear-view camera	£250
	Driving assistance: OnStar – Automatic crash response / Wi-Fi / smartphone function / stolen vehicle assistance / vehicle diagnostics	£415
	Warm welcome: Winter Pack – Heated front seats / steering wheel	£365
	Fresh air: Electronic climate control incorporating air conditioning	£415
	Electrically operated slide/tilt panoramic glass sunroof	£890

For details of these and other options please see Features/Options pages.



SRi – FEATURES

Infotainment:

- IntelliLink audio system
 - 7-inch colour touchscreen
 - AM/FM/DAB digital radio
 - Bluetooth® audio streaming
 - Bluetooth® mobile phone portal
 - Apple CarPlay™ / Android Auto™
 - USB audio connection
- Six speakers

Interior convenience / styling:

- Air conditioning
- Leather-covered steering wheel
- Cruise control
- Steering column adjustable for reach / rake
- Steering wheel audio / phone / cruise controls
- Sports-style front seats
- Driver's seat height adjuster

Exterior convenience / styling:

- Heated windscreen
- Rain-sensitive windscreen wipers
- Automatic lighting control
- Electrically adjustable / heated door mirrors
- Front fog lights with chrome-effect surround
- Black B-pillars (with certain exterior colours)
- 16-inch black 4-twinspoke alloy wheels (3-door)
 - no-cost option on 5-door models
- 16-inch silver 4-twinspoke alloy wheels (5-door)
 - no-cost option on 3-door models

Safety / security features:

- Electronic Stability Programme (ESP)
- Anti-lock Braking System (ABS)
- Six airbags
- Hill start assist
- ISOFIX child seat fixings on outer rear seats
- Tyre pressure monitoring system
- LED daytime running lights
- Engine deadlock immobiliser



SRi VX-LINE – FEATURES



Exterior convenience / styling:

- As Corsa SRi, plus:
- VX-Line body styling:
 - Front lower spoiler
 - Side sills / rear lower skirt
 - Rear roof spoiler (3-door only)
 - Chrome-effect exhaust tailpipe extension
 - Sports suspension
 - 17-inch alloy wheels

CUSTOMER OFFERS*

-  Flexible Personal Lease
-  Flexible PCP (5.9% APR)

Please consult your Retailer for details.

* = Terms and conditions apply.

COMPANY CAR INFORMATION

-  P11D price starting at £13,225
-  From 21% tax band**
-  From £53 monthly BiK tax**
-  CO₂ emissions from 93g/km

Please see www.vauxhall.co.uk/fleet for details.



** = 2018/19 tax year.

CORSA LIMITED EDITIONS

		3-door hatchback		5-door hatchback	
		OTR RRP	CO ₂ (g/km)	OTR RRP	CO ₂ (g/km)
LIMITED EDITION – ON-THE-ROAD PRICES					
Petrol	1.4i (75PS)	£16,205	120	£16,805	120
	1.4i (90PS)	£16,450	120	£17,050	120
	1.4i Turbo (100PS) S/S	£17,105	122	£17,705	122
	1.0i Turbo (115PS) S/S	£17,935	113	£18,535	115

RED / BLACK / WHITE EDITIONS – ON-THE-ROAD PRICES					
Petrol	1.4i Turbo (150PS) S/S	£18,725	132	£19,325	133

Please note: On-the-road recommended retail prices (RRP) include VAT at 20%, number plates and delivery to Retailer of £700.00 (inc. £116.67 VAT), 12 months' Vehicle Excise Duty and new vehicle first registration fee of £55.00. Excludes fuel and insurance. S/S = Start/Stop.

KEY OPTIONS		Total inc. VAT
	Looking good: Brilliant paint	£285
	Metallic / pearlescent paint	£565
	Easier parking: Front and rear parking sensors	£465
	Advanced park assist – Finds parking spaces and steers into them for you	£550
	Rear-view camera	£250
	Driving assistance: Bi-xenon headlights with cornering light – Brighter headlights for better visibility	£425
	Fresh air: Electrically operated slide/tilt panoramic glass sunroof	£890

For details of these and other options please see Features/Options pages.



LIMITED EDITION – FEATURES

OnStar:

- Automatic crash response / Wi-Fi hotspot / smartphone app / stolen vehicle assistance / vehicle diagnostics

Infotainment:

- IntelliLink audio system
 - 7-inch colour touchscreen
 - AM/FM/DAB digital radio
 - Bluetooth® audio streaming
 - Bluetooth® mobile phone portal
 - Apple CarPlay™ / Android Auto™
 - USB audio connection
- Six speakers

Interior convenience / styling:

- Air conditioning
- Sports-style front seats
- VX-Line styling: Leather-covered flat-bottom steering wheel / gear knob / handbrake lever
- Multi-function trip computer
- Cruise control
- Speed-sensitive power-assisted steering
- Steering column adjustable for reach / rake
- Steering wheel audio / phone / cruise controls
- Driver's seat height adjuster

Exterior convenience / styling:

- VX-Line body styling: Front lower spoiler / side sills / rear skirt / VXR rear roof spoiler (3-door only)
- Roof / door mirrors / front grille bar in black
- Heated windscreen
- Remote control central locking
- Electrically operated front windows
- Electrically adjustable / heated door mirrors
- Dark-tinted rear windows
- Chrome-effect exhaust tailpipe extension
- Sports suspension
- Front fog lights
- 17-inch black alloy wheels

Safety / security features:

- Electronic Stability Programme (ESP)
- Anti-lock Braking System (ABS)
- Six airbags
- Hill start assist
- Seatbelt reminders for all seats
- ISOFIX child seat mounting points on outer rear seats
- Tyre pressure monitoring system
- LED daytime running lights



RED EDITION FEATURES

As Limited Edition, plus:

- 1.4i Turbo (150PS) engine
- 17-inch diamond-cut alloy wheels
- Lava Red brilliant paint

BLACK EDITION FEATURES

As Limited Edition, plus:



- 1.4i Turbo (150PS) engine
- 17-inch diamond-cut alloy wheels
- Mineral Black metallic paint

WHITE EDITION FEATURES

As Limited Edition, plus:



- 1.4i Turbo (150PS) engine
- 17-inch diamond-cut alloy wheels
- Summit White brilliant paint

CUSTOMER OFFERS*

-  2 Year 0% APR PCP
-  Flexible PCP (5.9% APR) with Vauxhall Deposit Contribution (£3000 on Red, Black, White Editions and £1800 on Limited Edition)
-  Flexible Personal Lease

Please consult your Retailer for details.

COMPANY CAR INFORMATION

-  P11D price starting at £15,985
-  From 23% tax band**
-  From £67 monthly BiK tax**
-  CO₂ emissions from 113g/km

Please see www.vauxhall.co.uk/fleet for details.





* = Terms and conditions apply.

** = 2018/19 tax year.

CORSA SE

		3-door hatchback		5-door hatchback	
		OTR RRP	CO ₂ (g/km)	OTR RRP	CO ₂ (g/km)
SE – ON-THE-ROAD PRICES					
<i>Petrol</i>	1.4i (75PS)	£14,340	118	£14,940	118
	1.4i (90PS)	£14,585	118	£15,185	118
	1.4i (90PS) auto	£15,990	135	£16,590	137
	1.0i Turbo (90PS) S/S ecoTEC	£16,050	102	£16,650	105
	1.4i Turbo (100PS) S/S	£15,240	119	£15,840	119
<i>Diesel</i>	1.3CDTi (75PS) S/S	–	–	£17,090	102
	1.3CDTi (95PS) S/S ecoTEC	£16,970	93	£17,570	93

Please note: On-the-road recommended retail prices (RRP) include VAT at 20%, number plates and delivery to Retailer of £700.00 (inc. £116.67 VAT), 12 months' Vehicle Excise Duty and new vehicle first registration fee of £55.00. Excludes fuel and insurance. S/S = Start/Stop.

KEY OPTIONS		Total inc. VAT
 Looking good:	Brilliant paint	£285
	Metallic / pearlescent paint	£565
	17-inch diamond-cut titan alloy wheels	£480
 Easier parking:	Advanced park assist – Additional sensors help find suitable parking spaces – The system automatically steers into the parking space. You just drive forwards or backwards as directed	£250
	Rear-view camera	£250
	 Fresh air:	Electronic climate control incorporating air conditioning
Electrically operated slide/tilt panoramic glass sunroof		£890
 Driving assistance:	Bi-xenon headlights with cornering light – Brighter headlights for better visibility	£425
	 Practicality:	Steel emergency spare wheel (in lieu of emergency tyre inflation kit)
Remote control alarm		£260

For details of these and other options please see Features/Options pages.



FEATURES

OnStar:

- Automatic crash response / Wi-Fi hotspot / smartphone app / stolen vehicle assistance / vehicle diagnostics

Infotainment:

- IntelliLink audio system
 - 7-inch colour touchscreen
 - AM/FM/DAB digital radio
 - Bluetooth® audio streaming
 - Bluetooth® mobile phone portal
 - Apple CarPlay™ / Android Auto™
 - USB audio connection
- Six speakers

Interior convenience / styling:

- Air conditioning
- Auto anti-dazzle rear-view mirror
- Multi-function trip computer
- Heated leather-covered steering wheel
- Heated front seats
- Graphic Embossed cloth/Morrocana trim
- 60/40 split-folding rear seat back
- Cruise control
- Speed-sensitive power-assisted steering
- Steering column adjustable for reach / rake
- Steering wheel audio / phone / cruise controls
- Driver's seat height adjuster



Exterior convenience / styling:

- Heated windscreen
- Remote control central locking
- Electrically operated front windows
- Auto lighting / windscreen wipers
- Electrically adjustable / heated door mirrors
- Body-colour exterior door handles
- Front / rear parking sensors
- Front fog lights with chrome-effect surround
- Chrome-effect lower side window mouldings (5-door only)
- 16-inch multi-spoke alloy wheels

Safety / security features:

- Electronic Stability Programme (ESP)
- Anti-lock Braking System (ABS)
- Six airbags
- Hill start assist
- Seatbelt reminders for all seats
- ISOFIX child seat mounting points on outer rear seats
- Tyre pressure monitoring system
- LED daytime running lights
- Engine deadlock immobiliser



CUSTOMER OFFERS*

-  Flexible Personal Lease
-  Flexible PCP (5.9% APR)

Please consult your Retailer for details.

* = Terms and conditions apply.

COMPANY CAR INFORMATION

-  P11D price starting at £14,120
-  From 21% tax band**
-  From £56 monthly BiK tax**
-  CO₂ emissions from 93g/km





Please see www.vauxhall.co.uk/fleet for details.

** = 2018/19 tax year.

CORSA ELITE

		3-door hatchback		5-door hatchback	
		OTR RRP	CO ₂ (g/km)	OTR RRP	CO ₂ (g/km)
ELITE – ON-THE-ROAD PRICES					
Petrol	1.4i (90PS)	–	–	£17,985	120
	1.4i (90PS) auto	–	–	£19,390	139
	1.0i Turbo (90PS) S/S ecoTEC	–	–	£19,450	107
	1.4i Turbo (100PS) S/S	–	–	£18,640	122
Diesel	1.3CDTi (95PS) S/S ecoTEC	–	–	£20,370	94

Please note: On-the-road recommended retail prices (RRP) include VAT at 20%, number plates and delivery to Retailer of £700.00 (inc. £116.67 VAT), 12 months' Vehicle Excise Duty and new vehicle first registration fee of £55.00. Excludes fuel and insurance. S/S = Start/Stop.

KEY OPTIONS		Total inc. VAT
	Looking good: Brilliant paint	£285
	Metallic / pearlescent paint	£565
	Easier parking: Advanced park assist – Additional sensors help find suitable parking spaces – The system automatically steers into the parking space. You just drive forwards or backwards as directed	£250
	Sitting comfortably: Front passenger's seat height adjuster	£75
	Fresh air: Electrically operated slide/tilt panoramic glass sunroof	£890
	Practicality: Steel emergency spare wheel (in lieu of emergency tyre inflation kit)	£110

For details of these and other options please see Features/Options pages.



FEATURES

OnStar:

- Automatic crash response / Wi-Fi hotspot / smartphone app / stolen vehicle assistance / vehicle diagnostics

Infotainment:

- IntelliLink audio system
 - 7-inch colour touchscreen
 - AM/FM/DAB digital radio
 - Bluetooth® audio streaming
 - Bluetooth® mobile phone portal
 - Apple CarPlay™ / Android Auto™
 - USB audio connection
- Six speakers

Interior convenience / styling:

- Electronic climate control
- Rear-view camera
- Cruise control
- Speed-sensitive power-assisted steering
- Heated leather-covered steering wheel
- Heated front seats
- Steering column adjustable for reach / rake
- Steering wheel audio / phone / cruise controls
- Driver's seat height adjuster



Exterior convenience / styling:

- Heated windscreen
- Remote control central locking
- Electrically operated front windows
- Electrically adjustable / heated door mirrors
- Bi-xenon headlights
- Dark-tinted rear windows
- Sports suspension (not with optional 16-inch alloy wheels)
- 17-inch diamond-cut alloy wheels

Safety / security features:

- Electronic Stability Programme (ESP)
- Anti-lock Braking System (ABS)
- Six airbags
- Hill start assist
- Seatbelt reminders for all seats
- ISOFIX child seat mounting points on outer rear seats
- Tyre pressure monitoring system
- LED daytime running lights
- Remote control security alarm
- Engine deadlock immobiliser



CUSTOMER OFFERS*

-  2 Year 0% APR PCP
-  Flexible PCP (5.9% APR) with £1800 Vauxhall Deposit Contribution
-  Flexible Personal Lease

Please consult your Retailer for details.

* = Terms and conditions apply.





COMPANY CAR INFORMATION

-  P11D price starting at £17,765
-  From 22% tax band**
-  From £71 monthly BiK tax**
-  CO₂ emissions from 94g/km





Please see www.vauxhall.co.uk/fleet for details.



** = 2018/19 tax year.

CORSA PRICES

Model 3-door hatchback	Price (£)	VAT (£)	Total (£)	On-the-road RRP (£)	CO ₂ (g/km)	Model 3-door hatchback	Price (£)	VAT (£)	Total (£)	On-the-road RRP (£)	CO ₂ (g/km)
STING						SRi					
1.4i (75PS)	8441.67	1688.33	10130.00	11050.00	118	1.4i (75PS)	10437.50	2087.50	12525.00	13445.00	118
1.4i (90PS)	8645.83	1729.17	10375.00	11295.00	118	1.4i (90PS)	10641.67	2128.33	12770.00	13690.00	118
ENERGY (SPECIAL EDITION MODEL)						1.4i (90PS) auto					
1.4i (75PS)	10766.67	2153.33	12920.00	13840.00	118	1.0i Turbo (90PS) Start/Stop ecoTEC	11779.17	2355.83	14135.00	15095.00	135
1.4i (90PS)	10970.83	2194.17	13165.00	14085.00	118	1.4i Turbo (100PS) Start/Stop	11879.17	2375.83	14255.00	15155.00	102
1.4i (75PS) (a/c)	11016.67	2203.33	13220.00	14140.00	118	<i>Diesel</i>					
1.4i (90PS) (a/c)	11220.83	2244.17	13465.00	14385.00	118	1.3CDTi (95PS) Start/Stop ecoTEC	12645.83	2529.17	15175.00	16075.00	93
1.4i (90PS) Start/Stop Easytronic (a/c)	11850.00	2370.00	14220.00	15120.00	110	SRi VX-LINE					
1.4i (90PS) auto (a/c)	12358.33	2471.67	14830.00	15790.00	135	1.4i (75PS)	11300.00	2260.00	13560.00	14480.00	120
1.4i Turbo (100PS) Start/Stop (a/c)	11766.67	2353.33	14120.00	15040.00	119	1.4i (90PS)	11504.17	2300.83	13805.00	14725.00	120
1.0i Turbo (115PS) Start/Stop (a/c)	12458.33	2491.67	14950.00	15870.00	111	1.4i (90PS) auto	12641.67	2528.33	15170.00	16130.00	137
<i>Diesel</i>						1.4i Turbo (100PS) Start/Stop					
1.3CDTi (75PS) Start/Stop (a/c)	12808.33	2561.67	15370.00	16290.00	102	1.0i Turbo (115PS) Start/Stop	12050.00	2410.00	14460.00	15380.00	122
LIMITED EDITION (SPECIAL EDITION MODEL) 						1.0i Turbo (115PS) Start/Stop					
1.4i (75PS)	12737.50	2547.50	15285.00	16205.00	120	<i>Diesel</i>					
1.4i (90PS)	12941.67	2588.33	15530.00	16450.00	120	1.3CDTi (95PS) Start/Stop ecoTEC	13508.33	2701.67	16210.00	17110.00	94
1.4i Turbo (100PS) Start/Stop	13487.50	2697.50	16185.00	17105.00	122	SE 					
1.0i Turbo (115PS) Start/Stop	14179.17	2835.83	17015.00	17935.00	113	1.4i (75PS)	11183.33	2236.67	13420.00	14340.00	118
RED EDITION (SPECIAL EDITION MODEL) 						1.4i (90PS)					
1.4i Turbo (150PS) Start/Stop	14804.17	2960.83	17765.00	18725.00	132	1.4i (90PS) auto	12525.00	2505.00	15030.00	15990.00	135
BLACK EDITION (SPECIAL EDITION MODEL) 						1.0i Turbo (90PS) Start/Stop ecoTEC					
1.4i Turbo (150PS) Start/Stop	14804.17	2960.83	17765.00	18725.00	132	1.4i Turbo (100PS) Start/Stop	12625.00	2525.00	15150.00	16050.00	102
WHITE EDITION (SPECIAL EDITION MODEL) 						<i>Diesel</i>					
1.4i Turbo (150PS) Start/Stop	14804.17	2960.83	17765.00	18725.00	132	1.3CDTi (95PS) Start/Stop ecoTEC	13391.67	2678.33	16070.00	16970.00	93
DESIGN						Please note: On-the-road recommended retail prices (RRP) include number plates and delivery to Retailer of £700.00 (inc. £116.67 VAT), 12 months' Vehicle Excise Duty and new vehicle first registration fee of £55.00. Excludes fuel and insurance. a/c = Air conditioning.					
1.4i (75PS)	9879.17	1975.83	11855.00	12775.00	120	Easytronic transmission is a five-speed manual gearbox with a fully automatic mode.					
1.4i (90PS)	10083.33	2016.67	12100.00	13020.00	120	Our ecoTEC models combine superb performance, reduced CO₂ emissions and highly competitive economy figures.					
1.4i (90PS) Start/Stop Easytronic	10712.50	2142.50	12855.00	13775.00	112						
1.4i (90PS) auto	11220.83	2244.17	13465.00	14425.00	137						
<i>Diesel</i>											
1.3CDTi (75PS) Start/Stop	11670.83	2334.17	14005.00	14925.00	104						
1.3CDTi (95PS) Start/Stop ecoTEC	12087.50	2417.50	14505.00	15405.00	94						
1.3CDTi (95PS) Start/Stop ecoTEC Easytronic	12712.50	2542.50	15255.00	16155.00	91						

CORSA PRICES

Model 5-door hatchback	Price (£)	VAT (£)	Total (£)	On-the-road RRP (£)	CO ₂ (g/km)
ENERGY (SPECIAL EDITION MODEL)					
1.4i (75PS)	11266.67	2253.33	13520.00	14440.00	118
1.4i (90PS)	11470.83	2294.17	13765.00	14685.00	118
1.4i (75PS) (a/c)	11516.67	2303.33	13820.00	14740.00	118
1.4i (90PS) (a/c)	11720.83	2344.17	14065.00	14985.00	118
1.4i (90PS) Start/Stop Easytronic (a/c)	12350.00	2470.00	14820.00	15720.00	110
1.4i (90PS) auto (a/c)	12858.33	2571.67	15430.00	16390.00	137
1.4i Turbo (100PS) Start/Stop (a/c)	12266.67	2453.33	14720.00	15640.00	119
1.0i Turbo (115PS) Start/Stop (a/c)	12958.33	2591.67	15550.00	16470.00	113
<i>Diesel</i>					
1.3CDTi (75PS) Start/Stop (a/c)	13308.33	2661.67	15970.00	16890.00	102
LIMITED EDITION (SPECIAL EDITION MODEL) 					
1.4i (75PS)	13237.50	2647.50	15885.00	16805.00	120
1.4i (90PS)	13441.67	2688.33	16130.00	17050.00	120
1.4i Turbo (100PS) Start/Stop	13987.50	2797.50	16785.00	17705.00	122
1.0i Turbo (115PS) Start/Stop	14679.17	2935.83	17615.00	18535.00	115
RED EDITION (SPECIAL EDITION MODEL) 					
1.4i Turbo (150PS) Start/Stop	15304.17	3060.83	18365.00	19325.00	133
BLACK EDITION (SPECIAL EDITION MODEL) 					
1.4i Turbo (150PS) Start/Stop	15304.17	3060.83	18365.00	19325.00	133
WHITE EDITION (SPECIAL EDITION MODEL) 					
1.4i Turbo (150PS) Start/Stop	15304.17	3060.83	18365.00	19325.00	133
DESIGN					
1.4i (75PS)	10379.17	2075.83	12455.00	13375.00	120
1.4i (90PS)	10583.33	2116.67	12700.00	13620.00	120
1.4i (90PS) Start/Stop Easytronic	11212.50	2242.50	13455.00	14375.00	112
1.4i (90PS) auto	11720.83	2344.17	14065.00	15025.00	139
1.0i Turbo (90PS) Start/Stop ecoTEC	11820.83	2364.17	14185.00	15085.00	107
<i>Diesel</i>					
1.3CDTi (75PS) Start/Stop	12170.83	2434.17	14605.00	15525.00	104
1.3CDTi (95PS) Start/Stop ecoTEC	12587.50	2517.50	15105.00	16005.00	94
1.3CDTi (95PS) Start/Stop ecoTEC Easytronic	13212.50	2642.50	15855.00	16755.00	91

Model 5-door hatchback	Price (£)	VAT (£)	Total (£)	On-the-road RRP (£)	CO ₂ (g/km)
SRi					
1.4i (75PS)	10937.50	2187.50	13125.00	14045.00	118
1.4i (90PS)	11141.67	2228.33	13370.00	14290.00	118
1.4i (90PS) auto	12279.17	2455.83	14735.00	15695.00	137
1.0i Turbo (90PS) Start/Stop ecoTEC	12379.17	2475.83	14855.00	15755.00	105
1.4i Turbo (100PS) Start/Stop	11687.50	2337.50	14025.00	14945.00	119
<i>Diesel</i>					
1.3CDTi (75PS) Start/Stop	12729.17	2545.83	15275.00	16195.00	102
1.3CDTi (95PS) Start/Stop ecoTEC	13145.83	2629.17	15775.00	16675.00	93
SRi VX-LINE					
1.4i (75PS)	11800.00	2360.00	14160.00	15080.00	120
1.4i (90PS)	12004.17	2400.83	14405.00	15325.00	120
1.4i (90PS) auto	13141.67	2628.33	15770.00	16730.00	139
1.4i Turbo (100PS) Start/Stop	12550.00	2510.00	15060.00	15980.00	122
1.0i Turbo (115PS) Start/Stop	13241.67	2648.33	15890.00	16810.00	115
<i>Diesel</i>					
1.3CDTi (75PS) Start/Stop	13591.67	2718.33	16310.00	17230.00	104
1.3CDTi (95PS) Start/Stop ecoTEC	14008.33	2801.67	16810.00	17710.00	94
SE 					
1.4i (75PS)	11683.33	2336.67	14020.00	14940.00	118
1.4i (90PS)	11887.50	2377.50	14265.00	15185.00	118
1.4i (90PS) auto	13025.00	2605.00	15630.00	16590.00	137
1.0i Turbo (90PS) Start/Stop ecoTEC	13125.00	2625.00	15750.00	16650.00	105
1.4i Turbo (100PS) Start/Stop	12433.33	2486.67	14920.00	15840.00	119
<i>Diesel</i>					
1.3CDTi (75PS) Start/Stop	13475.00	2695.00	16170.00	17090.00	102
1.3CDTi (95PS) Start/Stop ecoTEC	13891.67	2778.33	16670.00	17570.00	93
Elite 					
1.4i (90PS)	14220.83	2844.17	17065.00	17985.00	120
1.4i (90PS) auto	15358.33	3071.67	18430.00	19390.00	139
1.0i Turbo (90PS) Start/Stop ecoTEC	15458.33	3091.67	18550.00	19450.00	107
1.4i Turbo (100PS) Start/Stop	14766.67	2953.33	17720.00	18640.00	122
<i>Diesel</i>					
1.3CDTi (95PS) Start/Stop ecoTEC	16225.00	3245.00	19470.00	20370.00	94

Please note: On-the-road recommended retail prices (RRP) include number plates and delivery to Retailer of £700.00 (inc. £116.67 VAT), 12 months' Vehicle Excise Duty and new vehicle first registration fee of £55.00. Excludes fuel and insurance.
a/c = Air conditioning.

Easytronic transmission is a five-speed manual gearbox with a fully automatic mode.
Our ecoTEC models combine superb performance, reduced CO₂ emissions and highly competitive economy figures.

CORSA FEATURES/OPTIONS

SAFETY

Driver/passenger airbags

- Driver's dual-stage airbag
- Front passenger's dual-stage airbag
- Front seat side-impact airbags
- Full-size curtain airbags

Seating

- Height-adjustable front seat head restraints
- Adjustable outer rear seat head restraints
- Anti-submarining ramps in all seats – Helps prevent occupants sliding underneath the lap belt during a collision.

Seatbelts

- Height-adjustable front seatbelts
- Three inertia-reel lap and diagonal rear seatbelts
- Front seatbelt pretensioner system – Pretensioners tighten the seatbelt in the event of an accident limiting forward movement.
- Front seatbelt force limiters – Reduces potential upper body injuries during a frontal impact.
- Front and rear 'seatbelt unfastened' audible warning and warning light

Child safety

- Deactivation switch for front passenger's airbag – Permits the safe use of a child seat in the front passenger seat.
- ISOFIX child seat mountings incorporating top tether anchor points located on outer rear seats (does not include child seat) – Allows ISOFIX child safety seats to be securely fixed into the car. The ISOFIX mounting system reduces forward movement in an accident and makes the child seat easier to install.
- Child-proof locks on rear doors

Driver/passenger safety

- Energy-absorbing steering column
- Pedal release system – Reduces potential injury to the driver's legs and feet during a severe frontal impact.
- Laminated windscreen
- Side-impact protection beams
- Reinforced passenger safety cell

Pedestrian safety

- Bonnet/headlight/wiper structure – Designed to reduce pedestrian head and upper body injuries.
- Upper and lower bumper design – Reduces upper and lower leg injuries.

Stability

Electronic Stability Programme (ESP):

– Works in conjunction with the vehicle's electronic braking and engine systems to keep the car stable in many different situations. ESP monitors many different inputs to determine when the car starts to lose traction, it can then immediately respond by varying the brake pressure between up to three wheels and adjust the engine output to help correct the loss of traction and improve stability.

Additional ESP features:

- Traction control
- Cornering brake control
- Straight line stability control
- Drag torque control – Maintain stability on slippery roads when lifting off the accelerator or changing gear.

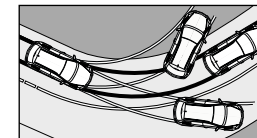

Braking

Anti-lock Braking System (ABS):

– Prevents the vehicle's wheels from locking up under heavy braking by momentarily reducing brake pressure at the appropriate wheel, ensuring that you can maintain control of the steering.

Additional braking features:



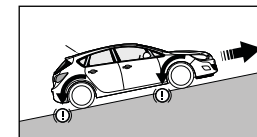



- The same electronic systems used in the ABS and ESP also deliver exceptional braking performance.
- Emergency brake assist – When emergency braking is detected the vehicle automatically applies the maximum possible braking assistance.
- Electronic brakeforce distribution – Automatically apportions the optimum braking force to each wheel.
- Adaptive brake lights – Automatically warns other road users of heavy braking
- Hill start assist – Briefly maintains rear brake pressure to stop the vehicle rolling back on an incline.
- Hazard warning lights

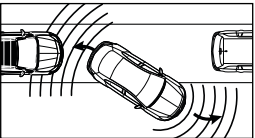

Tyre pressure

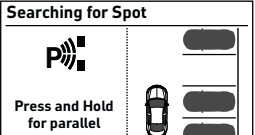
- Tyre pressure monitoring system

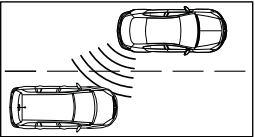
CORSA FEATURES/OPTIONS

DRIVER ASSISTANCE	Sting	Energy	Limited Edition	Red/Black/White Ed	Design	SRi	SRi VX-Line	SE	Elite	Price (£) exc. VAT	Total (£) inc. VAT
Steering <ul style="list-style-type: none"> Speed-sensitive electric power-assisted steering City mode button – Provides lighter steering at parking speeds 	●	●	●	●	●	●	●	●	●		
Cruise control with speed limiter <p>Enables you to maintain a constant speed – making it ideal for economical motorway driving.</p> <ul style="list-style-type: none"> The speed limiter function – can be set to ensure that you do not exceed the speed limit and can be easily overridden if required. Steering wheel mounted controls 	●	●	●	●	●	●	●	●	●		
Parking sensors <ul style="list-style-type: none"> Rear parking distance sensors 	○	○	○	○	○	○	○	●	●	250.00	300.00
<ul style="list-style-type: none"> Front and rear parking distance sensors Audible warning Distance warning graphic shown in driver information display 	○	○	○	○	○	○	○	●	●	387.50	465.00
 Easier parking											
Advanced park assist with side blind spot alert <p>Park assist helps you find suitable parking spaces. The system automatically steers into the space, you just drive forwards or backwards as directed.</p> <ul style="list-style-type: none"> Ultrasonic side sensors with 3 metre range Ultrasonic front and rear parking sensors with a 1.5 metre range Fully automated steering Detailed forward/reverse instructions are shown in the instrument cluster <p>Please note: Body-colour door mirrors with black mirror frames are added to Energy and SRi models.</p> 		○	○	○		○	○			458.33	550.00
 Finds suitable parking spaces  Auto steers into the parking space for you											
Side blind spot alert: <p>Side blind spot alert helps prevent potential collisions with other vehicles 'hidden' in the vehicle's side blind spots. If a vehicle enters one of the blind spots a warning light illuminates in the relevant door mirror.</p> <ul style="list-style-type: none"> LED warning light in door mirrors Audible warning is sounded if the indicators are used and the system has detected another vehicle 								○	○	208.33	250.00
 Warns of vehicles in your blind spot											
Rear-view camera <p>The rear-view camera gives a clear view of the area behind your car and helps place the car perfectly, without needing to strain your neck.</p> <ul style="list-style-type: none"> Activated when reverse gear selected Camera view appears in infotainment screen Rear bumper and one-metre grid lines shown as reference points <p>Please note: Only available in conjunction with parking sensors or advanced park assist. Not available with CD 30 BT audio unit.</p> 		○	○	○	○	○	○	○	●	208.33	250.00

● = Standard equipment. ○ = Optional at extra cost.

CORSA FEATURES/OPTIONS

SECURITY	Sting	Energy	Limited Edition	Red/Black/White Ed	Design	SRI	SRI VX-Line	SE	Elite	Price (£) exc. VAT	Total (£) inc. VAT
Standard security features <ul style="list-style-type: none"> • 'Key left in ignition' audible warning • Electronically protected audio equipment • Engine deadlock immobiliser • Visible Vehicle Identification Number (VIN) • Locking wheel bolts for alloy wheels (where fitted) • Door-to-door illumination 	●	●	●	●	●	●	●	●	●		
Central locking <ul style="list-style-type: none"> • Remote control • Operates on doors, tailgate and fuel filler flap • Deadlocking • Central locking activation switch on facia • One folding key/one static key each with integral remote control function 	●	●	●	●	●	●	●	●	●		
Security alarm system <ul style="list-style-type: none"> • Remote control (operates in conjunction with central locking) • Tilt sensor • Thatcham approved 	○	○	○	○	○	○	○	○	●	216.67	260.00

DRIVER INFORMATION

Instrumentation <ul style="list-style-type: none"> • Speedometer • Rev counter • Digital fuel gauge with low fuel level warning light • Digital water temperature gauge • Instrument panel light dimmer • Shift-up indication light – Indicates when to change gear for optimum fuel economy 	●	●	●	●	●	●	●	●	●		
Driver information display (centrally located in instrument cluster) <ul style="list-style-type: none"> • Displays trip computer data • Total mileage • Service-due indicator • Oil life • Tyre pressure monitoring system • Headlight/brake light bulb failure warning 	●	●	●	●	●	●	●	●	●		
Red graphics on black background	●										
Red graphics on black background (fitted in lieu of white graphics on 1.4i (75PS) and 1.4i (90PS) models if CD 30 BT audio unit is fitted in lieu of IntelliLink. Where digital speedometer and digital over-speed warning are standard, these features will be deleted. Not available separately). <i>Please note: If optional advanced park assist is fitted, then the standard driver information display is retained.</i>		●	●		●	●	●				
White graphics on black background		●	●	●	●	●	●	●	●		
Central facia display (format dependent on infotainment unit) <ul style="list-style-type: none"> • Audio information • Digital clock with automatic RDS time adjustment • Outside air temperature with ice warning function • Additional features dependent on infotainment unit (see infotainment for details) 	●	●	●	●	●	●	●	●	●		
Multi-function trip computer (displayed on driver information display) <ul style="list-style-type: none"> • Trip mileage • Vehicle range based on remaining fuel • Average speed • Average fuel economy • Instantaneous fuel economy • Digital speedometer • Digital over-speed warning 			●	●		●	●	●	●		

● = Standard equipment. ○ = Optional at extra cost.

CORSA FEATURES/OPTIONS

INTERIOR STYLING	Sting	Energy	Limited Edition	Red/Black/White Ed	Design	SRI	SRI VX-Line	SE	Elite	Price (£) exc. VAT	Total (£) inc. VAT
Sting interior décor Steering wheel: • Three-spoke design • Leather-covered • Satin chrome-effect bezel Facia and door trim: • Piano black facia • Black door panels with black Atlantis cloth inserts • Chrome-effect interior door handles Seat trim: • Spot Shimmer black fabric seat trim inserts • Plain black fabric side bolsters and surrounds	●										
Energy interior décor Steering wheel: • Three-spoke design • Leather-covered • Satin chrome-effect bezel Facia and door trim: • Rhutenium facia with chrome-effect trim inserts • Black door panels with black Atlantis cloth inserts • Chrome-effect interior door handles Seat trim: • Select black fabric seat trim inserts • Plain black fabric side bolsters and surrounds		●									
Limited Edition interior décor with Lace cloth seat trim Steering wheel: • VX-Line three-spoke design • Leather-covered flat bottom • Satin chrome-effect bezel Gear knob: • VX-Line leather-covered Facia and door trim: • Piano black facia with white inserts (fitted to Aegean Blue, Flaming Yellow, Lime Green and Persian Blue models. All other exterior colours feature red inserts) • Black door panels with black Atlantis cloth inserts • Chrome-effect interior door handles Seat trim: • Black Lace fabric seat trim inserts • Plain black fabric side bolsters and surrounds with accent stitching			●								
Red Edition/Black Edition/White Edition interior décor with Lace cloth seat trim Steering wheel: • VX-Line three-spoke design • Leather-covered flat bottom • Satin chrome-effect bezel Gear knob: • VX-Line leather-covered Facia and door trim: • Piano black facia with white inserts (Black Edition models) • Piano black facia with red inserts (Red Edition/White Edition models) • Black door panels with black Atlantis cloth inserts • Chrome-effect interior door handles Seat trim: • Black Lace fabric seat trim inserts • Plain black fabric side bolsters and surrounds with accent stitching				●							
Limited Edition/Red Edition/Black Edition/White Edition interior décor with Network Moonray cloth seat trim (not available on Aegean Blue models) Steering wheel: • VX-Line three-spoke design • Leather-covered flat bottom • Satin chrome-effect bezel Facia and door trim: • Piano black facia with white trim inserts (red trim inserts on Red Edition) • Black door panels with black Atlantis cloth inserts • Chrome-effect interior door handles Seat trim: • Network Moonray cloth seat trim inserts • Piano black facia side bolsters and surrounds			○	○						133.33	160.00

● = Standard equipment. ○ = Optional at extra cost.

CORSA FEATURES/OPTIONS

INTERIOR STYLING	<i>Sting</i>	<i>Energy</i>	<i>Limited Edition</i>	<i>Red/Black/White Ed</i>	<i>Design</i>	<i>SRI</i>	<i>SRI VX-Line</i>	<i>SE</i>	<i>Elite</i>	Price (£) exc. VAT	Total (£) inc. VAT
Design interior décor Steering wheel: • Three-spoke design • Leather-covered • Satin chrome-effect bezel Facia and door trim: • Rhutenium facia with chrome-effect trim inserts • Black door panels with black Atlantis cloth inserts • Chrome-effect interior door handles Seat trim: • Spot Shimmer black fabric seat trim inserts • Plain black fabric side bolsters and surrounds					●						
SRI/SRI VX-Line interior décor Steering wheel: • Three-spoke design • Leather-covered with accent stitching • Satin chrome-effect bezel Facia and door trim: • Piano black facia with red trim inserts (except Aegean Blue models, which feature a white trim insert) • Black door panels with black Atlantis cloth inserts • Chrome-effect interior door handles Seat trim: • Lace black fabric seat trim inserts • Plain black fabric side bolsters and surrounds with accent stitching						●	●				
SE/Elite interior décor Steering wheel: • Three-spoke design • Leather-covered with accent stitching • Satin chrome-effect bezel Facia and door trim: • Rhutenium facia with chrome-effect trim inserts • Black door panels with black Morrocana inserts • Chrome-effect interior door handles Seat trim: • Graphic Embossed black cloth seat trim inserts • Black Morrocana side bolsters and surrounds Front door sill covers: • Alloy-effect								●	●		

● = Standard equipment.

CORSA FEATURES/OPTIONS

INFOTAINMENT	Sting	Energy	Limited Edition	Red/Black/White Ed	Design	SRI	SRI VX-Line	SE	Elite	Price (£) exc. VAT	Total (£) inc. VAT
<p>CD 30 BT</p> <p>Onboard features:</p> <ul style="list-style-type: none"> • CD/MP3 CD player • AM/FM stereo radio with 36 station presets • RDS with Traffic Programme <hr/> <p>Media connections:</p> <ul style="list-style-type: none"> • USB connection with iPod control • Aux-in socket <hr/> <p>Mobile phone portal:</p> <ul style="list-style-type: none"> • Bluetooth® connectivity • Handsfree calls via steering wheel controls • Vehicle microphone • Phone book access <p><i>Please note: On 1.4i (75PS) and 1.4i (90PS) models the trip computer including digital speedometer and digital over-speed warning are deleted.</i></p>	●	N/C	N/C	N/C	N/C	N/C	N/C	N/C			
<p>R4.0 IntelliLink touchscreen infotainment system</p> <p><i>For use with media players, USB memory sticks, mobile phones and smartphone apps.</i></p> <p>Onboard features:</p> <ul style="list-style-type: none"> • 7-inch colour touchscreen • DAB digital radio/AM/FM stereo radio with 36 station presets • RDS with Traffic Programme <hr/> <p>Media connections:</p> <ul style="list-style-type: none"> • USB connection with iPod control • Bluetooth® A2DP audio streaming (Advanced Audio Distribution Profile) <hr/> <p>Mobile phone portal:</p> <ul style="list-style-type: none"> • Bluetooth® connectivity • Handsfree calls via steering wheel controls • Vehicle microphone • Phone book access – <i>The majority of the phone's functions – contacts/last calls/missed calls etc. – are mirrored on IntelliLink's display and are easily navigated using the touchscreen (features dependent on mobile phone).</i> <hr/> <p>Smartphone interface:</p> <ul style="list-style-type: none"> • Apple CarPlay™ • Android Auto™ – <i>Smartphone projection that allows operations via voice command, touchscreen and buttons to control apps and music playback.</i> 		●	●	●	●	●	●	●			







● = Standard equipment. N/C = No-cost option.

CORSA FEATURES/OPTIONS

INFOTAINMENT	Sting	Energy	Limited Edition	Red/Black/White Ed	Design	SRI	SRI VX-Line	SE	Elite	Price (£) exc. VAT	Total (£) inc. VAT
Navi 4.0 IntelliLink touchscreen navigation and infotainment system <i>For use with media players, USB memory sticks, mobile phones and smartphone apps.</i> Onboard features: • 7-inch colour touchscreen • DAB digital radio/AM/FM stereo radio with 36 station presets • RDS with Traffic Programme Navigation features: • Satellite navigation system • 2D street level mapping • European coverage • Structured or one-box destination entry • Points-of-interest search • Eco routing • Map updates via USB Media connections: • USB connection with iPod control • Bluetooth® A2DP audio streaming (Advanced Audio Distribution Profile) Mobile phone portal: • Bluetooth® connectivity • Handsfree calls via steering wheel controls • Vehicle microphone • Phone book access – <i>The majority of the phone's functions – contacts/last calls/missed calls etc. – are mirrored on IntelliLink's display and are easily navigated using the touchscreen (features dependent on mobile phone).</i> Smartphone interface: • Apple CarPlay™ • Android Auto™ – <i>Smartphone projection that allows operations via voice command, touchscreen and buttons to control apps and music playback.</i> Gallery – only available when vehicle is stationary: • Photo gallery with slide show feature • Video playback with soundtrack played through car speakers		○	○	○	○	○	○	○	○	541.67	650.00
Six speakers	●	●	●	●	●	●	●	●	●		
Steering wheel mounted audio controls	●	●	●	●	●	●	●	●	●		

● = Standard equipment. ○ = Optional at extra cost.

CORSA FEATURES/OPTIONS

ONSTAR						Sting	Energy	Limited Edition	Red/Black/White Ed	Design	SRI	SRI VX-Line	SE	Elite	Price (£) exc. VAT	Total (£) inc. VAT
																
Automatic Crash Response	Wi-Fi Hotspot	Smartphone App	Stolen Vehicle Assistance	Vehicle Diagnostics	Destination Download		○	●	●	○	○	○	●	●	345.83	415.00
<p>OnStar – your personal on board assistant*</p> <p>Many car brands talk about innovation as soon as they improve their cup holders but this innovative system, now available on selected models**, is revolutionary: 24/7, 365 days a year, OnStar puts you in touch with a trained advisor, not a machine. With OnStar you have access to a host of innovations, from Vehicle Diagnostics and Smartphone Function to a fully integrated 4G Wi-Fi Hotspot†. In the event of an accident, OnStar even automatically calls for help, for an incomparable feeling of safety.</p> <p>* = Includes 12 months of OnStar services from date of first registration and a 3 month/3 GB Wi-Fi free trial period (whichever comes first) effective from the date the customer accepts the nominated network operator Wi-Fi T's&C's. Theft alert feature only operates on models fitted with security alarm system. Destination download feature only operates on models fitted with Navi 4.0 IntelliLink satellite navigation system.</p> <p>** = The OnStar Services require activation and are subject to mobile network coverage and availability. Wi-Fi Hotspot service requires account with nominated network operator.</p> <p>† = 4G is subject to mobile network coverage and availability. Charges apply after the free trial period. The OnStar subscription packages could be different from the services included in the free trial package. Check www.vauxhall.co.uk/onstar for terms and conditions, details of availability, coverage and charges.</p> 																
<p>OnStar – delete standard-fit</p> <p>– Please note, cannot be deleted retrospectively and must be selected at time of ordering.</p>								N/C	N/C				N/C	N/C	No-cost option	

● = Standard equipment. ○ = Optional at extra cost. N/C = No-cost option.

CORSA FEATURES/OPTIONS

	Sting	Energy	Limited Edition	Red/Black/White Ed	Design	SRI	SRI VX-Line	SE	Elite	Price (£) exc. VAT	Total (£) inc. VAT
HEATING AND VENTILATION Air blend heater • Cabin particulate filter – Removes dust, airborne particles and pollen • Four-speed fan • Illuminated controls	●										
Air conditioning • Air recirculation facility • Cabin particulate filter – Removes dust, airborne particles and pollen • Four-speed fan • Illuminated controls <i>Please note: Non air-conditioned Energy 1.4i (75PS) and 1.4i (90PS) manual models are also available.</i>	○	●	●	●	●	●	●	●		445.83	535.00
Electronic climate control incorporating air conditioning • Single-zone control • Advanced predictive logic control system using sun sensor • Cabin charcoal filter – Removes dust, airborne particles, pollen and unpleasant odours • Automatic air direction and fan speed with manual override • LCD temperature display • Six-speed fan • Illuminated controls <i>Please note: Not available on non air-conditioned Energy models.</i>		○	○	○		○	○	○	●	345.83	415.00
<div style="background-color: #e0e0e0; padding: 2px; display: inline-block;"> Set and forget temperature control</div>											
Winter Pack • Heated leather-covered steering wheel • Heated front seats <div style="display: flex; align-items: center; gap: 10px;"> <div style="background-color: #e0e0e0; padding: 2px; display: inline-block;"> Warm welcome</div> </div>		●	○	○	○	○	○	●	●	304.17	365.00
Additional features • Four adjustable facia vents • Windscreen demist vents • Side window demist vents	●	●	●	●	●	●	●	●	●		

● = Standard equipment. ○ = Optional at extra cost.

CORSA FEATURES/OPTIONS

SEATING AND COMFORT	Sting	Energy	Limited Edition	Red/Black/White Ed	Design	SRI	SRI VX-Line	SE	Elite	Price (£) exc. VAT	Total (£) inc. VAT
Reach and rake adjustable steering	●	●	●	●	●	●	●	●	●		
Comfort front seats Driver's seat (eight-way adjustable): • Height (up/down) • Reach (fore/aft) • Backrest (upright/recline) • Head restraint (up/down) Front passenger's seat (six-way adjustable): • Reach (fore/aft) • Backrest (upright/recline) • Head restraint (up/down)	●	●			●			●	●		
Sports-style front seats Driver's seat (eight-way adjustable): • Height (up/down) • Reach (fore/aft) • Backrest (upright/recline) • Head restraint (up/down) Front passenger's seat (six-way adjustable): • Reach (fore/aft) • Backrest (upright/recline) • Head restraint (up/down)			●	●		●	●				
Easy-entry front seats with memory function (three-door models only)	●	●	●	●	●	●	●	●			
Front passenger's seat height adjuster (fitted at no extra cost in conjunction with optional glass sunroof)	○	○	○	○	○	○	○	○	○	62.50	75.00
Rear seats • Three-person layout • Adjustable backrest • Height-adjustable and removable outer head restraints • ISOFIX child seat mountings incorporating top tether anchor points located on outer rear seats (does not include child seat) – <i>Allows ISOFIX child safety seats to be securely fixed into the car. The ISOFIX mounting system reduces forward movement in an accident and makes the child seat easier to install.</i> • Child-proof locks on rear doors	●	●	●	●	●	●	●	●	●		
• One-piece folding rear seat	●	●	●	●	●	●	●				
• 60/40 split-folding rear seat back	○	○	○	○	○	○	○	●	●	116.67	140.00



● = Standard equipment. ○ = Optional at extra cost.

CORSA FEATURES/OPTIONS

	Sting	Energy	Limited Edition	Red/Black/White Ed	Design	SRI	SRI VX-Line	SE	Elite	Price (£) exc. VAT	Total (£) inc. VAT
INTERIOR CONVENIENCE											
Convenience features • Front 12-volt electrical accessory socket • Driver's and front passengers sunvisors • Driver's vanity mirror • Dipping rear-view mirror • Driver's and front passenger's tiltable assist handles • Two rear tiltable passenger assist handles (five-door models only)	●	●	●	●	●	●	●	●	●		
Driver's and front passenger's vanity mirrors with flip-up cover		●	●	●	●	●	●	●	●		
Automatically dimming anti-dazzle rear-view mirror		●	□	□	□	●	●	●	●		
Velour floor mats									●		
Interior lighting • Central front courtesy light • Central rear courtesy light • Fade up/fade down • Front map reading lights • Rear reading light (five-door models only)	●	●	●	●	●	●	●	●	●		
Interior storage • Storage box on driver's side lower fascia • Glovebox with lid • Front door pockets • Drinks holder in centre console • Rear door pockets (five-door models only) • Rear bottle holders (three-door models only)	●	●	●	●	●	●	●	●	●		
• Front passenger's underseat storage tray (deleted if optional sunroof is fitted)						●	●				
• Storage pockets on front seat backs								●	●		
Luggage area • Luggage compartment cover • Stowage facility for luggage compartment cover behind rear seats • Illuminated luggage area • Interior tailgate handles • Load restraint lashing eyes • Twin gas-assisted tailgate struts	●	●	●	●	●	●	●	●	●		
MECHANICAL											
Standard features • Front-wheel drive • Gas-pressure dampers • Front anti-roll bar • Speed-sensitive electric power-assisted steering	●	●	●	●	●	●	●	●	●		
Sports suspension (fitted to SE models in conjunction with optional 17-inch wheels. Not available separately. Elite models with optional 16-inch alloy wheels are fitted with standard suspension in place of sports suspension)			●	●			●	○	●		
Transmissions Five-speed manual gearbox (excluding 1.0i Turbo (90PS)/(115PS) and 1.4i Turbo (100PS) models)	●	●	●		●	●	●	●	●		
Six-speed manual gearbox (1.0i Turbo (90PS)/(115PS), 1.4i Turbo (100PS) and 1.4i Turbo (150PS) models)		●	●	●	●	●	●	●	●		
Easytronic five-speed transmission with sequential manual gearshift or automatic mode (1.4i (90PS)/1.3CDTi (95PS) models only)		▲			▲						
Six-speed automatic transmission (1.4i (90PS) models only)		▲			▲	▲	▲	▲	▲		

● = Standard equipment. ○ = Optional at extra cost. ▲ = See price pages for details. □ = Available as part of an extra-cost option pack.

CORSA FEATURES/OPTIONS

	Sting	Energy	Limited Edition	Red/Black/White Ed	Design	SRi	SRi VX-Line	SE	Elite	Price (£) exc. VAT	Total (£) inc. VAT
EXTERIOR LIGHTING											
Standard lighting features • Welcome lighting • Lights-on audible warning • Electric headlight beam levelling • High-level LED centre rear brake light • Rear fog light	●	●	●	●	●	●	●	●	●		
Halogen headlights	●	●	●	●	●	●	●	●			
Bi-xenon headlights with cornering light  Brighter headlights for better visibility			○	○			○	○	●	354.17	425.00
Daytime running lights	●										
LED daytime running lights		●	●	●	●	●	●	●	●		
Front fog lights with black surround		●	●	●	●						
Front fog lights with chrome-effect surround						●	●	●	●		
Sight and Light Pack • Rain-sensitive windscreen wipers • Automatic lighting control • Automatically dimming anti-dazzle rear-view mirror		●	○	○	○	●	●	●	●	200.00	240.00
EXTERIOR CONVENIENCE											
Windscreen wipers • Two-speed windscreen wipers with variable intermittent wipe • Intermittent rear window wash/wipe • Rain-sensitive windscreen wipers	●	●	●	●	●	●	●	●	●		
		●	□	□	□	●	●	●	●		
Door mirrors • Manually foldable door mirrors • Electrically adjustable door mirrors (wide-angle on driver's side), manually foldable • Electrically adjustable/heated door mirrors (wide-angle on driver's side, except in conjunction with advanced park assist), manually foldable	●	●	●	●	●	●	●	●	●		
		●	□	□	□	●	●	●	●		
		●	□	□	□	●	●	●	●		
Windows • Heated windscreen • Electrically operated front windows with safety autoreverse and one-touch facility • Heated rear window	●	●	●	●	●	●	●	●	●		
Electrically operated slide/tilt panoramic glass sunroof • Manually operated interior blind • Non-metallic roof panel covering is coloured black • Front passenger's seat height adjuster Please note: Front passenger's underseat storage tray is deleted on SRi and SRi VX-Line models  Enjoy fresh air at the touch of a button		○	○	○		○	○	○	○	741.67	890.00







● = Standard equipment. ○ = Optional at extra cost. □ = Available as part of an extra-cost option pack.

CORSA FEATURES/OPTIONS

EXTERIOR STYLING	Sting	Energy	Limited Edition	Red/Black/White Ed	Design	SRI	SRI VX-Line	SE	Elite	Price (£) exc. VAT	Total (£) inc. VAT
Sting styling • Twin white stripes on bonnet, roof and tailgate • White door mirror housings • White front grille bar • Body-colour door handles	●										
Energy styling • Chrome-effect front grille bar • Body-colour door handles • Chrome-effect exhaust tailpipe extension (1.0i Turbo (115PS) models only)		●									
Limited Edition/Red/Black/White Edition styling • Mineral Black door mirror housings • Black front grille bar • Body-colour door handles • VX-Line body-colour front lower spoiler/side sills/rear lower skirt • VXR body-colour rear roof spoiler (3-door models only) • Mineral Black roof • Chrome-effect exhaust tailpipe extension			●	●							
Design/SRI styling • Chrome-effect front grille bar • Body-colour door handles					●	●					
SRI VX-Line styling • Chrome-effect front grille bar • Body-colour door mirrors with black mirror frame • Body-colour door handles • VX-Line body-colour front lower spoiler/side sills/rear lower skirt • VX-Line body-colour rear roof spoiler (3-door models only) • Chrome-effect exhaust tailpipe extension							●				
SE/ Elite styling • Chrome-effect front grille bar • Body-colour door mirrors with black mirror frame • Body-colour door handles • Chrome-effect lower side window mouldings (5-door models only) • Alloy-effect front door sill covers with 'Vauxhall' lettering								●	●		
Black foil on B-pillars (not with Aegean Blue or optional Mineral Black or Darkmoon Blue exterior colours)	●	●	●	●	●	●	●	●	●		
Windows • Tinted windows	●	●	●	●	●	●	●	●	●		
• Dark-tinted rear windows		○	●	●	○	○	○	○	●	237.50	285.00

● = Standard equipment. ○ = Optional at extra cost.

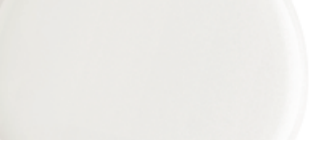

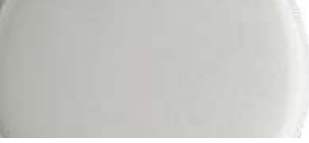



CORSA FEATURES/OPTIONS

EXTERIOR COLOURS		Sting	Energy	Limited Edition	Red/Black/White Ed	Design	SRi	SRi VX-Line	SE	Elite	Price (£) exc. VAT	Total (£) inc. VAT
	Aegean Blue • Solid paint • Not available with Network Moonray cloth trim		●	●		●	●	●	●	●		
	Flaming Yellow • Brilliant paint • 3-door models only	●	○	○		○			○		237.50	285.00
	Mandarina • Brilliant paint • Only available with Network Moonray cloth trim			○							237.50	285.00
	Lava Red • Brilliant paint • Standard on Red Edition models, not available on Black or White Edition models	○	○	○	●	○	○	○	○	○	237.50	285.00
	Summit White • Brilliant paint • Standard on White Edition models, not available on Red or Black Edition models		○	○	●	○	○	○	○	○	237.50	285.00
	Mineral Black • Two-coat metallic paint • Standard on Black Edition models, not available on Red Edition or White Edition models	○	○	○	●	○	○	○	○	○	470.83	565.00
	Sovereign Silver • Two-coat metallic paint		○	○		○	○	○	○	○	470.83	565.00

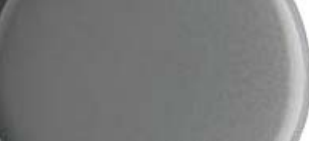
● = Standard equipment. ○ = Optional at extra cost.

The colours reproduced may vary slightly from the actual paint colour. As a result they should be used as a guide only. Your Vauxhall Retailer has a comprehensive display of our paint samples.





CORSA FEATURES/OPTIONS

EXTERIOR COLOURS		<i>Sting</i>	<i>Energy</i>	<i>Limited Edition</i>	<i>Red/Black/White Ed</i>	<i>Design</i>	<i>SRi</i>	<i>SRi VX-Line</i>	<i>SE</i>	<i>Elite</i>	Price (£) exc. VAT	Total (£) inc. VAT
	Satin Steel Grey • Two-coat metallic paint		○	○		○	○	○	○	○	470.83	565.00
	Persian Blue • Two-coat metallic paint		○	○		○			○	○	470.83	565.00
	Quantum Grey • Two-coat metallic paint	○	○	○		○	○	○	○	○	470.83	565.00
	Darkmoon Blue • Two-coat premium paint	○	○			○	○	○	○	○	545.83	655.00
	Lime Green • Two-coat premium paint	○	○	○		○					545.83	655.00
	Abalone White • Tri-coat premium paint • 5-door models only		○			○	○	○	○	○	604.17	725.00

○ = Optional at extra cost.





The colours reproduced may vary slightly from the actual paint colour. As a result they should be used as a guide only. Your Vauxhall Retailer has a comprehensive display of our paint samples.

CORSA FEATURES/OPTIONS

WHEELS AND TYRES		Sting	Energy	Limited Edition	Red/Black/White Ed	Design	SRi	SRi VX-Line	SE	Elite	Price (£) exc. VAT	Total (£) inc. VAT
Steel emergency spare wheel (in lieu of emergency tyre inflation kit) – on Design models, only available with optional 16-inch steel wheels		○	○			○	○		○	○	91.67	110.00
Full-size steel spare wheel (in lieu of emergency tyre inflation kit) – not available with optional 16-inch steel wheels						○					91.67	110.00
	15-inch structure steel wheels with styled covers <ul style="list-style-type: none"> • 185/65 R 15 tyres • Emergency tyre inflation kit (in lieu of spare wheel) 					●						
	15-inch alloy wheels <ul style="list-style-type: none"> • 185/65 R 15 tyres • Emergency tyre inflation kit (in lieu of spare wheel) 					○					166.67	200.00
	16-inch steel wheels with flush covers <ul style="list-style-type: none"> • 195/55 R 16 tyres • Emergency tyre inflation kit (in lieu of spare wheel) • Only available in conjunction with 1.3CDTi (95PS) Easytronic models 					○					133.33	160.00
	16-inch 8-spoke alloy wheels <ul style="list-style-type: none"> • 195/55 R 16 tyres • Emergency tyre inflation kit (in lieu of spare wheel) 		●									
	16-inch white 4-twinspoke alloy wheels <ul style="list-style-type: none"> • 195/55 R 16 tyres • Emergency tyre inflation kit (in lieu of spare wheel) 	●										



● = Standard equipment. ○ = Optional at extra cost.

CORSA FEATURES/OPTIONS

WHEELS AND TYRES		Sting	Energy	Limited Edition	Red/Black/White Ed	Design	SRi	SRi VX-Line	SE	Elite	Price (£) exc. VAT	Total (£) inc. VAT
	16-inch silver 4-twinspoke alloy wheels • 195/55 R 16 tyres • Emergency tyre inflation kit (in lieu of spare wheel) • Standard on SRi 5-door models, no-cost option on SRi 3-door models						●					
	16-inch black 4-twinspoke alloy wheels • 195/55 R 16 tyres • Emergency tyre inflation kit (in lieu of spare wheel) • Standard on SRi 3-door models, no-cost option on SRi 5-door models						●					
	16-inch alloy wheels • 195/55 R 16 tyres • Emergency tyre inflation kit (in lieu of spare wheel) • Deletes sports suspension on Elite models								●	N/C		
	17-inch silver alloy wheels • 215/45 R 17 tyres • Emergency tyre inflation kit (in lieu of spare wheel)		○					●			341.67	410.00
	17-inch black alloy wheels • 215/45 R 17 tyres • Emergency tyre inflation kit (in lieu of spare wheel)			●								



● = Standard equipment. ○ = Optional at extra cost. N/C = No-cost option.

CORSA FEATURES/OPTIONS

WHEELS AND TYRES		Sting	Energy	Limited Edition	Red/Black/White Ed	Design	SRi	SRi VX-Line	SE	Elite	Price (£) exc. VAT	Total (£) inc. VAT
	17-inch diamond-cut black alloy wheels • 215/45 R 17 tyres • Emergency tyre inflation kit (in lieu of spare wheel)				●							
	17-inch diamond-cut titan alloy wheels • 215/45 R 17 tyres • Emergency tyre inflation kit (in lieu of spare wheel)							○			208.33	250.00
	17-inch diamond-cut titan alloy wheels • 215/45 R 17 tyres • Emergency tyre inflation kit (in lieu of spare wheel) • Includes sports suspension on SE models							○	●		400.00	480.00

● = Standard equipment. ○ = Optional at extra cost.

TYRE RATING

Tyre size	Fuel efficiency group	Wet grip performance	External noise	
			Measured (dB)	Group
185/65 R 15	B-C	B	69-70	
195/55 R 16	B-C	B	68-71	
215/45 R 17	C	B	71	

Tyre rating according to EU Regulation 1222/2009

CORSA SPECIFICATIONS

PETROL ENGINES

	1.4i (75PS)	1.4i (90PS)	1.4i Turbo (100PS) Start/Stop
Capacity	1398cc	1398cc	1364cc
Maximum power	75PS (55kW) @ 4200-6000rpm	90PS (66kW) @ 6000rpm	100PS (74kW) @ 3500-6000rpm
Maximum torque	130Nm (96 lb.ft.) @ 4000rpm	130Nm (96 lb.ft.) @ 4000rpm	200Nm (147 lb.ft.) @ 1850-3500rpm
Configuration	4 cylinders, 4 valves per cylinder, double overhead camshafts	4 cylinders, 4 valves per cylinder, double overhead camshafts	4 cylinders, 4 valves per cylinder, double overhead camshafts
Fuel/induction system	Naturally aspirated with Variable Valve Timing. Multi-point sequential fuel injection	Naturally aspirated with Variable Valve Timing. Multi-point sequential fuel injection	Turbocharger with intercooler. Variable Valve Timing. Multi-point sequential fuel injection
Emission compliance	Euro 6	Euro 6	Euro 6
Service interval	20,000 miles or 1 year (whichever occurs sooner)	20,000 miles or 1 year (whichever occurs sooner)	20,000 miles or 1 year (whichever occurs sooner)

	1.0i Turbo (90PS) Start/Stop ecoTEC	1.0i Turbo (115PS) Start/Stop	1.4i Turbo (150PS) Start/Stop
Capacity	999cc	999cc	1364cc
Maximum power	90PS (67kW) @ 3700-6000rpm	115PS (85kW) @ 5000-6000rpm	150PS (110kW) @ 5000rpm
Maximum torque	170Nm (125 lb.ft.) @ 1800-3700rpm	170Nm (125 lb.ft.) @ 1800-4500rpm	220Nm (162 lb.ft.) @ 2750-4500rpm
Configuration	3 cylinders, 4 valves per cylinder, double overhead camshafts	3 cylinders, 4 valves per cylinder, double overhead camshafts	4 cylinders, 4 valves per cylinder, double overhead camshafts
Fuel/induction system	Turbocharger with intercooler. Direct fuel injection	Turbocharger with intercooler. Direct fuel injection	Turbocharger with intercooler. Multi-point fuel injection
Emission compliance	Euro 6	Euro 6	Euro 6
Service interval	20,000 miles or 1 year (whichever occurs sooner)	20,000 miles or 1 year (whichever occurs sooner)	20,000 miles or 1 year (whichever occurs sooner)

DIESEL ENGINES

	1.3CDTi (75PS) Start/Stop	1.3CDTi (95PS) Start/Stop ecoTEC
Capacity	1248cc	1248cc
Maximum power	75PS (55kW) @ 3750rpm	95PS (70kW) @ 3750rpm
Maximum torque	190Nm (140 lb.ft.) @ 1500-2500rpm	190Nm (140 lb.ft.) @ 1500-3500rpm
Configuration	4 cylinders, 4 valves per cylinder, double overhead camshafts	4 cylinders, 4 valves per cylinder, double overhead camshafts
Fuel/induction system	Turbocharger with intercooler. Common rail fuel injection	Variable geometry turbocharger with intercooler. Common rail fuel injection
Emission compliance	Euro 6 with Diesel Particulate Filter	Euro 6 with Diesel Particulate Filter
Service interval	20,000 miles or 1 year (whichever occurs sooner)	20,000 miles or 1 year (whichever occurs sooner)

CORSA SPECIFICATIONS

PERFORMANCE, FUEL ECONOMY AND EMISSIONS

	Wheel size (inches)	Performance (manufacturer's figures)		Fuel economy mpg (litres/100km) [#]			CO ₂ emissions g/km [#]	Vehicle Excise Duty*		Benefit in kind company car taxation rates – 2018/19 tax year
		Maximum speed (mph)	Acceleration 0-62mph (sec)	Urban driving	Extra-urban driving	Combined figure		First year rate	Standard rate	
Manual										
1.4i (75PS)	15/17	101	15.5	41.5 (6.8)	65.7 (4.3)	54.3 (5.2)	120	£165	£140	25%
1.4i (75PS)	16	101	15.5	42.2 (6.7)	67.3 (4.2)	55.4 (5.1)	118	£165	£140	24%
1.4i (90PS)	15/17	109	13.2	41.5 (6.8)	65.7 (4.3)	54.3 (5.2)	120	£165	£140	25%
1.4i (90PS) (excluding Elite)	16	109	13.2	42.2 (6.7)	67.3 (4.2)	55.4 (5.1)	118	£165	£140	24%
1.4i (90PS) Elite (with optional wheels)	16	109	13.2	41.5 (6.8)	65.7 (4.3)	54.3 (5.2)	120	£165	£140	25%
1.0i Turbo (90PS) S/S ecoTEC 3-door	15/17	112	11.9	51.4 (5.5)	72.4 (3.9)	62.8 (4.5)	104	£145	£140	21%
1.0i Turbo (90PS) S/S ecoTEC 3-door	16	112	11.9	51.4 (5.5)	74.3 (3.8)	64.2 (4.4)	102	£145	£140	21%
1.0i Turbo (90PS) S/S ecoTEC 5-door	15/17	112	11.9	50.4 (5.6)	68.9 (4.1)	61.4 (4.6)	107	£145	£140	22%
1.0i Turbo (90PS) S/S ecoTEC 5-door (excluding Elite)	16	112	11.9	51.4 (5.5)	70.6 (4.0)	61.4 (4.6)	105	£145	£140	22%
1.0i Turbo (90PS) S/S ecoTEC 5-door Elite (with optional wheels)	16	112	11.9	50.4 (5.6)	68.9 (4.1)	61.4 (4.6)	107	£145	£140	22%
1.4i Turbo (100PS) S/S (excluding Elite)	16	115	11.0	44.1 (6.4)	65.7 (4.3)	55.4 (5.1)	119	£165	£140	24%
1.4i Turbo (100PS) S/S Elite (with optional wheels)	16	115	11.0	42.8 (6.6)	64.2 (4.4)	54.3 (5.2)	122	£165	£140	25%
1.4i Turbo (100PS) S/S	17	115	11.0	42.8 (6.6)	64.2 (4.4)	54.3 (5.2)	122	£165	£140	25%
1.0i Turbo (115PS) S/S 3-door	16	121	10.3	47.9 (5.9)	67.3 (4.2)	58.9 (4.8)	111	£165	£140	23%
1.0i Turbo (115PS) S/S 3-door	17	121	10.3	47.1 (6.0)	67.3 (4.2)	57.6 (4.9)	113	£165	£140	23%
1.0i Turbo (115PS) S/S 5-door	16	121	10.3	47.1 (6.0)	67.3 (4.2)	57.6 (4.9)	113	£165	£140	23%
1.0i Turbo (115PS) S/S 5-door	17	121	10.3	46.3 (6.1)	65.7 (4.3)	56.5 (5.0)	115	£165	£140	24%
1.4i Turbo (150PS) S/S 3-door	17	129	8.9	38.2 (7.4)	58.9 (4.8)	49.6 (5.7)	132	£205	£140	27%
1.4i Turbo (150PS) S/S 5-door	17	129	8.9	38.2 (7.4)	58.9 (4.8)	48.7 (5.8)	133	£205	£140	27%
1.3CDTi (75PS) S/S	15/17	102	14.8	58.9 (4.8)	83.1 (3.4)	72.4 (3.9)	104	£165	£140	25%
1.3CDTi (75PS) S/S	16	102	14.8	60.1 (4.7)	83.1 (3.4)	72.4 (3.9)	102	£165	£140	25%
1.3CDTi (95PS) S/S ecoTEC	15/17	113	11.9	68.9 (4.1)	88.3 (3.2)	78.5 (3.6)	94	£145	£140	23%
1.3CDTi (95PS) S/S ecoTEC (excluding Elite)	16	113	11.9	68.9 (4.1)	88.3 (3.2)	80.7 (3.5)	93	£145	£140	23%
1.3CDTi (95PS) S/S ecoTEC Elite (with optional wheels)	16	113	11.9	68.9 (4.1)	88.3 (3.2)	78.5 (3.6)	94	£145	£140	23%

* = Correct at time of publication. S/S = Start/Stop.

= Fuel consumption information is official government environmental data, tested in accordance with the relevant EU directive. Official EU-regulated test data is provided for comparison purposes and actual performance will depend on driving style, road conditions and other non-technical factors.

CORSA SPECIFICATIONS

PERFORMANCE, FUEL ECONOMY AND EMISSIONS

	Wheel size (inches)	Performance (manufacturer's figures)		Fuel economy mpg (litres/100km) [#]			CO ₂ emissions g/km [#]	Vehicle Excise Duty*		Benefit in kind company car taxation rates – 2018/19 tax year
		Maximum speed (mph)	Acceleration 0-62mph (sec)	Urban driving	Extra-urban driving	Combined figure		First year rate	Standard rate	
Easytronic										
1.4i (90PS) S/S Design 3-door	15	109	13.9	47.9 (5.9)	68.9 (4.1)	58.9 (4.8)	112	£165	£140	23%
1.4i (90PS) S/S Design 5-door	15	109	13.9	48.7 (5.8)	68.9 (4.1)	58.9 (4.8)	112	£165	£140	23%
1.4i (90PS) S/S Energy	16	109	13.9	48.7 (5.8)	70.6 (4.0)	60.1 (4.7)	110	£145	£140	23%
1.3CDTi (95PS) S/S ecoTEC	15	113	13.5	70.6 (4.0)	91.1 (3.1)	83.1 (3.4)	91	£145	£140	23%
1.3CDTi (95PS) S/S ecoTEC	16	113	13.5	72.4 (3.9)	91.1 (3.1)	83.1 (3.4)	90	£125	£140	23%
Automatic										
1.4i (90PS) 3-door	15/17	106	13.9	35.8 (7.9)	58.9 (4.8)	47.9 (5.9)	137	£205	£140	28%
1.4i (90PS) 3-door	16	106	13.9	36.2 (7.8)	60.1 (4.7)	47.9 (5.9)	135	£205	£140	28%
1.4i (90PS) 5-door	15/17	106	13.9	35.3 (8.0)	57.6 (4.9)	47.1 (6.0)	139	£205	£140	28%
1.4i (90PS) 5-door (excluding Elite)	16	106	13.9	35.8 (7.9)	58.9 (4.8)	47.9 (5.9)	137	£205	£140	28%
1.4i (90PS) 5-door Elite (with optional wheels)	16	106	13.9	35.3 (8.0)	57.6 (4.9)	47.1 (6.0)	139	£205	£140	28%

* = Correct at time of publication. S/S = Start/Stop.

= Fuel consumption information is official government environmental data, tested in accordance with the relevant EU directive. Official EU-regulated test data is provided for comparison purposes and actual performance will depend on driving style, road conditions and other non-technical factors.

CORSA SPECIFICATIONS

TRANSMISSION

Five-speed manual gearbox

Petrol engines: 1.4i (75PS), 1.4i (90PS) models

Diesel engines: All

Six-speed manual gearbox

Petrol engines: 1.0i Turbo (90PS),

1.4i Turbo (100PS), 1.0i Turbo (115PS),

1.4i Turbo (150PS) models

Five-speed Easytronic transmission

Optional on 1.4i (90PS) and 1.3CDTi (95PS)

models. Easytronic transmission is a five-speed manual gearbox with a fully automatic mode. In manual mode you simply push the lever forward or back to shift gears up or down sequentially. The fascia display tells you what gear you're in – 1 to 5, N for Neutral or A for Auto. Switch to fully automatic mode and it has many of the features of a regular automatic including a kickdown function. There's no clutch pedal so you can drive it on an automatic-only driving licence.

Six-speed automatic transmission

Optional on 1.4i (90PS) models. Electronically controlled with adaptive driving function that adjusts to the driving style and prevailing road conditions.

Fluid drive with torque converter, lock-up clutch, neutral control fuel-saving feature and Active Select.

SUSPENSION

Front: Independent. Lightweight MacPherson struts with gas-pressure dampers and coil springs. Anti-roll bar.

Rear: Compound crank with coil springs and gas-pressure dampers.

- Sports suspension on Limited Edition/SRi VX-Line/Elite models, and on SE models fitted with optional 17-inch alloy wheels

BRAKES

- Anti-lock Braking System (ABS)
- Electronic brakeforce distribution
- Emergency brake assist
- Cornering brake control
- Straight line stability control
- Dual circuit, diagonally split, dual rate servo-assisted system
- Low brake fluid level warning light

1.4i (75PS)

Front ventilated discs: 257mm diameter

Rear drums: 228mm diameter

1.4i (90PS)

Front ventilated discs: 257mm diameter

Rear drums: 228mm diameter

1.0i Turbo (90PS)

Front ventilated discs: 284mm diameter

Rear drums: 228mm diameter

1.4i Turbo (100PS)

Front ventilated discs: 284mm diameter

Rear discs: 264mm diameter

1.0i Turbo (115PS)

Front ventilated discs: 284mm diameter

Rear drums: 228mm diameter

1.4i Turbo (150PS)

Front ventilated discs: 308mm diameter

Rear discs: 264mm diameter

1.3CDTi (75PS)

Front ventilated discs: 284mm diameter

Rear drums: 228mm diameter

1.3CDTi (95PS)

Front ventilated discs: 284mm diameter

Rear drums: 228mm diameter

BODY

- Aerodynamic drag co-efficient: Cd 0.33

FUEL TANK CAPACITY

- 45 litres (9.9 gallons)

WEIGHTS AND TOWING DATA ^{kg}

	Gross vehicle weight		Maximum towing weights Trailer with brakes (without brakes)	
	3-door	5-door	3-door	5-door
1.4i (75PS) Energy	1585	1605	800 (550)	800 (550)
1.4i (75PS) Sting	1585	–	800 (550)	–
1.4i (75PS) Limited Edition/Design/SRi/SRi VX-Line/SE	1600	1620	800 (550)	800 (550)
1.4i (90PS) Sting/Energy	1585	1615	800 (550)	800 (550)
1.4i (90PS) Limited Edition/Design/SRi/SRi VX-Line/SE/Elite	1600	1630	800 (550)	800 (550)
1.4i (90PS) Easytronic	1620	1640	800 (550)	800 (550)
1.4i (90PS) auto	1630	1660	800 (550)	800 (550)
1.0i Turbo (90PS)	1650	1680	1200 (560)	1200 (560)
1.4i Turbo (100PS)	1680	1710	1150 (580)	1150 (580)
1.0i Turbo (115PS) Energy/Limited Edition/SRi VX-Line	1650	1680	1200 (560)	1200 (560)
1.4i Turbo (150PS)	1690	1720	1200 (580)	1200 (580)
1.3CDTi (75PS) Energy/Design/SRi/SRi VX-Line/SE	1680	1710	900 (580)	900 (580)
1.3CDTi (95PS)	1680	1710	1150 (580)	1150 (580)
1.3CDTi (95PS) Easytronic	1690	1710	1150 (580)	1150 (580)

Please note: For Sting and Energy models fitted with optional air conditioning 15kg must be added to gross vehicle weight. Gross vehicle weight is the total permissible weight of the vehicle including passengers and their luggage. The maximum roof rack loading should not exceed 75kg. The maximum towing weights are based on the ability of the car, with two occupants of 75kg each, to restart on a 12% gradient, which is approximately 1 in 8.3, at sea level. The permitted trailer load applies up to the specified incline and up to an altitude of 1000 metres above sea level. The permissible gross train weight decreases by 10% for every 1000 metres of additional altitude. At altitudes above 1500 metres, the engine output may drop with a corresponding reduction in towing capability. Any extra weight, such as luggage or additional passengers, should be deducted from the maximum towing weight. With a trailer fully loaded, maximum noseweight should not exceed 55kg. Always fit Vauxhall towing attachments and accessories available from your Vauxhall Retailer. They are designed specifically for Vauxhall models and carry a 12-month guarantee.

CORSA SPECIFICATIONS

EXTERIOR DIMENSIONS millimetres (inches)

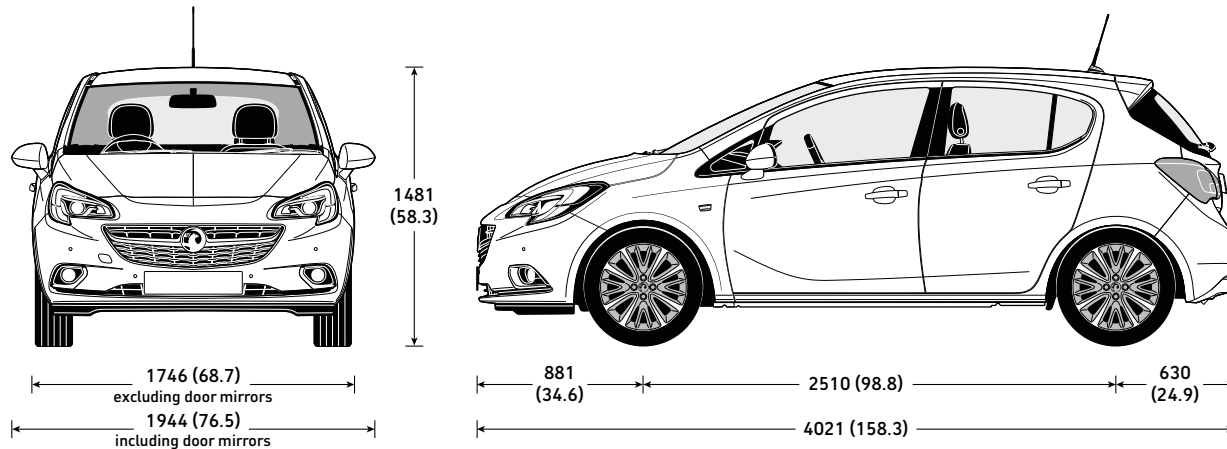
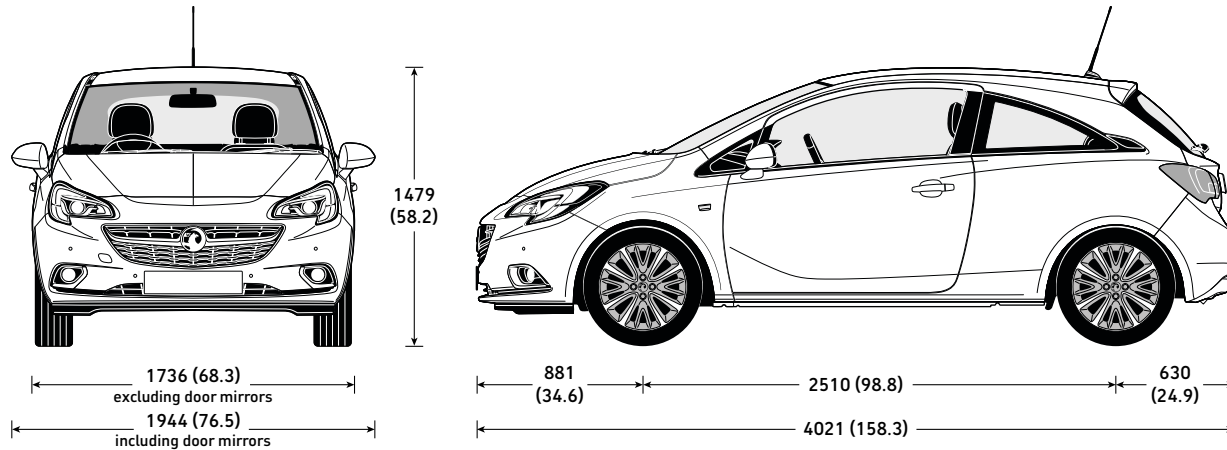

LOADSPACE DIMENSIONS mm (inches)

3-door	
Maximum length (seats up)	705 (27.8)
Maximum length*	1372 (54.0)
Maximum width	944 (37.2)
Maximum height	843 (33.2)
5-door	
Maximum length (seats up)	705 (27.8)
Maximum length*	1372 (54.0)
Maximum width	944 (37.2)
Maximum height	876 (34.5)

* = Behind front seats.

LOADSPACE CAPACITIES** litres (cu.ft.)

3-door	
Rear seat up	280 (9.9)
Rear seat down (to glassline)	750 (26.5)
Rear seat down (to roof)	1090 (38.5)
5-door	
Rear seat up	285 (10.0)
Rear seat down (to glassline)	710 (25.1)
Rear seat down (to roof)	1120 (39.5)

** = ECIE method.

FLEX-FIX® KEY DIMENSIONS mm (inches)

Maximum circumference around rim and tyre of bicycle	225 (8.9)
Maximum crank arm width	52 (2.0)
Maximum crank arm depth	25 (1.0)
Maximum crank arm length	no limit

CORSA ACCESSORIES

	Total (inc. VAT)
CHILD SEATS¹	
BABY-SAFE ² – 0-13kg/birth to 15 months	£132.00
– ISOFIX base	£227.00
DUO ISOFIX ² – 9-18kg/9 months to 4 years with top tether kit	£347.00
KID ³ – 15-36kg or 4 to 12 years	£157.00
1 = Restrictions apply to the use of child seats, please consult your Vauxhall Retailer or request a copy of the Child seats brochure.	
2 = Without transponder.	
SAFETY	
Privacy shades – rear side windows (3-dr)	£73.00
Privacy shades – tailgate window (3-dr)	£89.00
Privacy shades – rear side windows (5-dr)	£91.00
Privacy shades – tailgate window (5-dr)	£91.00
Parking sensors	
– four fully flush front bumper mounted sensors	
– painted	£350.00
– four fully flush rear bumper mounted sensors	
– painted	£330.00
Safety Pack – first aid kit, warning triangle, hi-visibility vest, Vauxhall bag	£35.00
First aid kit	£15.00
Warning triangle	£17.00
Hi-visibility vest	£9.00
Fire extinguisher – 2kg	£37.00
Temporary tyre inflation kit	£150.00
Tyre sealant	£68.00

FLEXCONNECT RANGE

FlexConnect bracket	£20.00
FlexConnect hook	£28.00
FlexConnect coat hanger	£58.00
FlexConnect folding table	£68.00
FlexConnect iPad Mini cradle	£98.00
FlexConnect iPad (1-4) cradle	£106.00
FlexConnect iPad Air cradle	£106.00
FlexConnect Samsung Galaxy cradle	£96.00

	Total (inc. VAT)
SECURITY	
Locking wheel bolts – set of four	£43.00
PRACTICAL	
Spare bulb kit	£28.00
Spare bulb kit – ultra white	£37.00
Jump leads	
– petrol engines (16mm standard)	£47.00
– petrol/diesel engines (25mm heavy duty)	£86.00
Stretch tow rope – 3000kg	£34.00
Towing bar – 2500kg	£85.00
PROTECTION	
Carpet floor mats – set of four	£43.00
Rubber floor mats – front pair	£49.00
Rubber floor mats – rear pair	£31.00
Velour floor mats – set of four	£62.00
Cargo liner	£75.00
Luggage storage box – with dividers	£100.00
Universal luggage net	£26.00
Load-restraining floor net	£44.00
Rear bumper protection foil	£70.00
Mudflaps – front and rear set ³	£120.00

3 = Not available with certain exterior styling accessories.

	Total (inc. VAT)
TRANSPORT SYSTEMS	
Roof base carrier	£146.00
Roof carriers (requires base carrier)	
Bike roof carrier – Thule Freeride 532	£76.00
Surf board roof carrier – Thule 833	£101.00
Kayak roof carrier – Thule 837	£168.00
Ski roof carrier (400mm wide)	
– Thule Deluxe 726	£138.00
Ski roof carrier (600mm wide)	
– Thule 739	£235.00
Hard shell roof boxes (requires base carrier)	
Thule Ocean 80 (320 litre / 1330 x 860 x 370mm)	£235.00
Thule Ocean 200 (390 litre / 1750 x 820 x 450mm)	£316.00
Thule Dynamic M (320 litre / 2060 x 840 x 340mm)	from £625.00
Thule Dynamic L (430 litre / 2350 x 940 x 350mm)	£846.00
Thule Excellence (520 litre / 2180 x 940 x 400mm)	£898.00
Thule Motion 800 (460 litre / 2050 x 840 x 450mm)	from £515.00
Thule Touring 200 (400 litre / 1750 x 820 x 450mm)	£372.00
Thule Touring 780 (430 litre / 2320 x 700 x 420mm)	£460.00
Soft roof boxes (requires base carrier)	
Thule Ranger 90 (280 litre / 1100 x 800 x 400mm)	£285.00
Thule Ranger 500 (300 litre / 1900 x 500 x 300mm)	£378.00
Tailgate carrier	
Bike tailgate carrier – Thule BacPac 973	£282.00
Fitting kit	£48.00

	Total (inc. VAT)
ALLOY WHEELS (set of four with centre caps)⁴	
15-inch 8-spoke – silver	£727.00
16-inch 4-double-spoke – white	£852.00
16-inch 4-double-spoke – black	£873.00
16-inch 6-double-spoke – silver	£876.00
17-inch 5-twin-spoke – silver	£1008.00
17-inch 8-spoke – Titan gloss	£980.00

4 = Fitting time is based on four wheels fitted and includes static wheel balancing. Different tyres and locking wheel nuts may be required. Price excludes new tyres and locking wheel nuts.

Please note:

Prices shown are a fully fitted and painted, where applicable and include VAT. Please check with your local Vauxhall Retailer for details. It is advisable to ensure your insurance policy is adequate to cover additional fitted accessories. Prices correct at time of publication.

CORSA OFFERS IN DETAIL – TERMS AND CONDITIONS

Unless otherwise stated, all offers described are available on orders or registrations between 3 April 2018 – 2 July 2018. Offer prices quoted are correct at the time of publication (April 2018). Prices are subject to change. In line with Vauxhall's policy of price transparency, the offer price shown is an on-the-road price including VAT, number plates and delivery to Retailer of £700.00 (including £116.67 VAT), 12 months' Government Vehicle Excise Duty (variable depending upon model) and the DVLA's new vehicle first registration fee of £55.00. Excludes fuel and insurance. Offers may not apply to Retailer stocks and are subject to availability. Restrictions may apply. Contact your Retailer for details. Vauxhall Motors Limited reserves the right to change, amend or withdraw these offers at any point in time.

2 YEAR 0% APR PCP

Offer subject to availability, on selected models at participating Retailers only. Personal Contract Purchase. Finance subject to status, Ts&Cs apply. Applicants must be 18+. Finance by Vauxhall Finance, CF15 7YT. 25 month term. Monthly payment has been calculated using a price which includes Vauxhall and/or Retailer contribution where applicable. At the end of the agreement there are three options: i) Retain: Pay the optional final payment to own the vehicle, ii) Return the vehicle, or iii) Replace: Part Exchange the vehicle where equity is available. Offer applies to private individuals, Vauxhall Partners and small businesses 1-24 units. Orders or registrations from 3 April 2018 to 2 July 2018.

FLEXIBLE PCP

Offer subject to availability at participating Retailers only. Personal Contract Purchase. Finance subject to status. Terms and Conditions apply. Applicants must be 18+. Finance by Vauxhall Finance, CF15 7YT. 24-48 month term available. Vauxhall deposit contribution only available when vehicle financed through Vauxhall Finance. At the end of the agreement there are three options: i) Pay the optional final payment to own the vehicle, ii) Return the vehicle, or iii) Replace: Part Exchange the vehicle, where equity is available. UK-supplied vehicles only. Offer applies to private individuals, Vauxhall Partners and small businesses 1-24 units (purchase only excluding B2B supported units). Offer not available in conjunction with Personal Contract Hire, 0% Flexible Finance or a deposit contribution.

PERSONAL CONTRACT HIRE

Personal contract hire offer on vehicles ordered by 2 July 2018 subject to availability and status. Age 18+ only. Figures based on a non-maintenance contract hire package. Excess miles over contracted mileage of 24,000 over 36 months charged at a maximum of 14 pence per mile. Excess charges also apply if you breach manufacturer servicing or maintenance guidelines or if the car exceeds BVRLA Fair Wear & Tear guidelines for its age/mileage when it is returned to Vauxhall Leasing. Package includes Road Fund Licence and Vauxhall Assistance. Guarantee/indemnity may be required. Prices and details are subject to change without notice. For full specification and Ts&Cs contact your local Retailer. You will not own the car. ALD Automotive Ltd., trading as Vauxhall Leasing, BS16 7LB. Authorised and regulated by the Financial Conduct Authority. Offer not available in conjunction with 0% Flexible Finance, Flexible PCP or a deposit contribution.

Please note not all offers apply to all models.

CORSA COMPANY CAR DRIVER/FLEET INFORMATION

DESIGN AND TECH LINE NAV HIGH SPEC, LOW P11D

Specifically developed for businesses and company car drivers alike, our Design and Tech Line Nav models are seriously fit for Fleet.

Design models all feature very low P11D values, generous standard specification with a choice of high tech ecoTEC engines for great fuel economy and low emissions including the 'whisper diesel' 1.6CDTi (from 88g/km and 85.6mpg combined).

For even more standard specification, step up to our Tech Line Nav range again you are guaranteed low P11D values, plus great standard kit including Sat Nav, Bluetooth®, USB connection and digital radio.

With Design and Tech Line Nav you can take for granted low Whole Life Costs and low company car driver taxation.



COMPANY CAR DRIVER FREE 3 DAY TEST DRIVE

Our free* 3 Day Test Drive programme is open to all Company Car Drivers. It allows you to choose most models in the current Vauxhall line-up (exclusions apply). With full insurance cover provided, it gives you a meaningful length of time to make an informed decision about your next company car.

Click below to book your free* test drive
www.vauxhall3dtd.co.uk
 or call 0330 587 8221**

*The free 3 Day Test Drive programme is open to Company Car Drivers and Fleet Decision Makers. Available for UK Mainland only. Terms and conditions apply. Full terms and conditions can be found at vauxhallfleet.co.uk/testdrive/index/terms. **Telephone lines open Monday-Friday 9.00am to 5.00pm excluding Bank Holidays. Calls may be recorded or monitored for quality and/or training purposes.

BENEFIT IN KIND COMPANY CAR TAXATION†

The car benefit charge will be the car's list price (including VAT, options and accessories fitted, delivery to Retailer and number plates, but excluding Vehicle Excise Duty and new vehicle first registration fee) multiplied by the percentage charge for the CO₂ emissions band in which the car falls (see table opposite). Multiply this figure by your personal income tax rate (20% for Basic Rate, 40% for Higher Rate) to calculate your annual benefit in kind tax liability.

Example:

Corsa Design 1.3CDTi (95PS) Start/Stop ecoTEC 5-door hatchback (CO ₂ emissions 94g/km)	
On-the-road RRP	£16005.00
Deduct: Vehicle Excise Duty	(£145.00)
New vehicle first registration fee	(£55.00)
Effective list price	£15805.00
Add: Optional two-coat metallic paint	£565.00
List price for tax purposes (P11D value)	£16370.00
Car benefit charge	
2018-19 tax year (23%)	£3765.00
Benefit in kind tax liability (2018-19 tax year)	
Basic Rate (20%) tax payer	£753.00
Higher Rate (40%) tax payer	£1506.00

† = Please note this Price Guide provides taxation information as a guide only. Vauxhall does not provide taxation guidance. Drivers should always take professional advice on their own tax position.

CO ₂ emissions in grams per kilometre	Percentage of car's price to be taxed	
	Non-Diesel†† 2018-19 tax year	Diesel‡ 2018-19 tax year
Up to 50	13	17
51-75	16	20
76-94	19	23
95-99	20	24
100-104	21	25
105-109	22	26
110-114	23	27
115-119	24	28
120-124	25	29
125-129	26	30
130-134	27	31
135-139	28	32
140-144	29	33
145-149	30	34
150-154	31	35
155-159	32	36
160-164	33	37
165-169	34	37
170-174	35	37
175-179	36	37
180 and above	37	37

†† = Also applies to diesel vehicles that meet the Real Driving Emissions Step 2 (RDE2). ‡ = Applies to vehicles that do not meet the Real Driving Emissions Step 2 (RDE2).

To calculate your own personal liability a car tax calculator is available at: <https://www.vauxhallfleet.co.uk/toolbox>

FLEET TOOLBOX

Discover the facts in our online Toolbox for both Company Car Drivers and Fleet Decision Makers. The Fleet Toolbox has a host of useful calculators, comparators, interactive listings and information. Visit the Fleet Toolbox by going to www.vauxhall-toolbox.co.uk



ROADTRIP APP

The Vauxhall RoadTrip App is a free app that calculates and logs your mileage expenses for any UK business trips and generates reports to help you complete your mileage claims. Available for both iPhone and Android, visit www.vauxhall-toolbox.co.uk or visit the iPhone or Android stores and search for Vauxhall RoadTrip to download it to your smartphone or tablet.



CONTACT VAUXHALL FLEET

Please contact one of our dedicated sales teams who will be happy to help with your particular enquiry.

Company Car Drivers

Call: 0345 111 2020
 Email: company-car@vauxhallinfo.co.uk

Telephone lines are open

- Monday to Friday 8.00am-9.00pm
- Saturday and Sunday 9.00am-6.00pm

Fleet Decision Makers

Depending on the size of your fleet of vehicles, we have a dedicated team to handle your enquiries. The lines are open Monday to Friday excluding Bank Holidays.

1-24 vehicles

Call: 0845 076 2254 (8.30am-5.00pm)
 Email: b2bsales@vauxhall.co.uk

25+ vehicles

Call: 0330 587 8222 (8.30am-5.00pm)
 Email: vauxhallfleet@vauxhall.co.uk

Special Vehicles (Police, Fire and Ambulance)

Call: 01582 409999 (8.30am-5.00pm)
 Email: vauxhallspecialvehicles@vauxhall.co.uk

CORSA ADDITIONAL INFORMATION

ON-THE-ROAD PRICES

To eliminate uncertainty about hidden costs when buying a new car, Vauxhall publishes on-the-road recommended retail prices (RRP) and these are shown in the pricing tables within this price guide. These prices include VAT, number plates and delivery to Retailer of £700.00 (including £116.67 VAT), 12 months' Government Vehicle Excise Duty (see opposite for details) and the DVLA new vehicle first registration fee of £55.00*.

Please note: The on-the-road recommended retail price (RRP) does not include fuel supplied by the Retailer, motor insurance or any other goods or services supplied by agreement between the Retailer and the customer.

PRICE PROTECTION

Order a new Vauxhall for build in the current model year (as confirmed by your Retailer) for delivery no more than three months in advance and the price you are quoted is the price you pay. This is irrespective of any subsequent price rises between placing your order and delivery of your new car, but you must take delivery as soon as the car is available. Vauxhall Motors Limited is not liable for price adjustments caused by Government changes in the rate of VAT (currently 20%), Vehicle Excise Duty, DVLA new vehicle first registration fee or by any other applicable legislation or regulations.

VAUXHALL LEASING

As Vauxhall's own contract hire and fleet management operation, Vauxhall Leasing provides a one-stop-shop for competitive car and van leasing solutions – for business users and private individuals. Working with the Vauxhall Retailer network, we combine the support of a national contract with the convenience of a local contact.

For further information, please see your local Vauxhall Retailer or call us on **0117 908 6433**. Alternatively, you can visit our website at www.vauxhall-leasing.co.uk

IN THE EVENT OF AN ACCIDENT...

Vauxhall Accident Management helps keep you mobile following an accident. Benefits include vehicle recovery, Vauxhall-approved repairs and contacting your insurer. For more details, visit vauxhall.co.uk/AccidentManagement

VEHICLE EXCISE DUTY

The amount of Vehicle Excise Duty (road fund licence) payable on new cars varies depending on the level of carbon dioxide (CO₂) emissions produced by the vehicle. CO₂ emissions are measured in grammes (g) per kilometre (km) travelled and divided into 13 charging bands shown in the table below.

A 'first year rate' of Vehicle Excise Duty is payable on all new cars and in subsequent years the amount payable reverts to the 'standard rate'. From 1 April 2017 the breakpoints for each of these bands have been revised. Also, for vehicles with a list price over £40,000, including factory-fitted options, an additional £310 is payable for the first five years of standard rate payments.

VEHICLE EXCISE DUTY*

	CO ₂ emissions	First year rate		Standard rate
		Non-diesel**	Diesel†	
Band A	0g/km	£0.00	£0.00	£0.00
Band B	1 – 50g/km	£10.00	£25.00	£140.00
Band C	51 – 75g/km	£25.00	£105.00	£140.00
Band D	76 – 90g/km	£105.00	£125.00	£140.00
Band E	91 – 100g/km	£125.00	£145.00	£140.00
Band F	101 – 110g/km	£145.00	£165.00	£140.00
Band G	111 – 130g/km	£165.00	£205.00	£140.00
Band H	131 – 150g/km	£205.00	£515.00	£140.00
Band I	151 – 170g/km	£515.00	£830.00	£140.00
Band J	171 – 190g/km	£830.00	£1,240.00	£140.00
Band K	191 – 225g/km	£1,240.00	£1,760.00	£140.00
Band L	226 – 255g/km	£1,760.00	£2,070.00	£140.00
Band M	over 255g/km	£2,070.00	£2,070.00	£140.00

* = Correct at time of issue. ** = Also applies to diesel vehicles that meet the Real Driving Emissions Step 2 (RDE2).

† = Applies to vehicles that do not meet the Real Driving Emissions Step 2 (RDE2).

TRUST VAUXHALL

CUSTOMER CARE COMMITMENT

For added peace of mind, Vauxhall has an innovative Customer Care Commitment that offers the following:

- Three-year vehicle warranty consisting of a one-year/unlimited mileage manufacturer's warranty and a second and third year manufacturer's warranty with a 60,000 miles limitation
- Vauxhall Assistance for 12 months from first registration
- Six years' body panel anti-perforation warranty

Please note: Warranty is only available on vehicles sourced from Vauxhall Motors Limited. Terms and conditions apply – please see your Vauxhall Retailer for details.

VAUXHALL ASSISTANCE

Vauxhall Assistance is provided automatically with every new Vauxhall for 12 months from first registration and covers everything from accident assistance, roadside recovery and 'at home' service to flat tyres. With Vauxhall Assistance help is literally just a free* phone call away, 24 hours a day, 365 days a year!

* = Mobile phone users will be charged at their standard tariff.

PROTECTING THE ENVIRONMENT

Vauxhall's commitment to the environment is demonstrated by our products' many environmental awards. For even more information on Vauxhall's efforts to achieve an environmentally sustainable future, and how to dispose of your end-of-life vehicle, see www.vauxhall.co.uk/recycling

VAUXHALL SERVICE PLAN

- Fixed monthly payments for the plan duration
- Easy to budget and interest-free
- Genuine parts fitted by Vauxhall-trained technicians

Plus on Gold plans:

- Valet and courtesy car
- Full AA cover
- Engine flush and fuel treatments
- Litre of oil for top ups between services

Full details can be obtained from your local participating Vauxhall Retailer.

VAUXHALL INSURANCE WITH ADDED REASSURANCE

Comprehensive cover – Summary of benefits**

- Competitive premiums
- Repairs by a Vauxhall-trained technician
- Genuine Vauxhall parts, guaranteed for three years when we repair your car within our Approved Repairer Network
- Free courtesy car as standard when using an Approved Repairer†
- 24 hour claims helpline
- Personal Accident benefit
- Cover for audio equipment
- Windscreen cover

Call for a quote on 0844 463 2670††

** = The benefits listed above are for comprehensive cover only. For details of Third Party, Fire and Theft cover, please call our sales team.
† = Should your car need repairing following an accident we provide a courtesy car (subject to availability) for the duration of the repair. Only genuine Vauxhall parts are used. Terms and conditions apply.
†† = Calls may be recorded. Vauxhall Insurance is underwritten by Ageas Insurance Limited.

FOR MORE PRODUCT INFORMATION

For a brochure on any Vauxhall model (up to a maximum of three per caller) or location of your nearest Vauxhall Retailer please call **0345 600 1500**. Alternatively, details can be found on our website at www.vauxhall.co.uk

JOIN US ONLINE:



PROUD SPONSOR OF OUR NATIONAL FOOTBALL TEAMS



Privacy Policy – For full details please visit: vauxhall.co.uk/privacy

OnStar privacy details are available at vauxhall.co.uk/onstar

The invoice price, including delivery to Retailer, factory-fitted options, accessories fitted by the Retailer and number plates, is subject to VAT. Some feature descriptions in this guide may refer to, and some illustrations may show, optional equipment not included in the standard delivery. The information contained in this guide was accurate at the time of publication. We reserve the right to make changes in design and equipment. Please note that Vauxhall Retailers are not the agents of Vauxhall Motors Limited and are not authorised to bind Vauxhall Motors Limited by any specific or implied undertaking or representation. It is advisable to ensure that your motor insurance policy provides adequate cover for additional fitted options and accessories. The colours in this guide are only approximate actual colours. Illustrated optional equipment is available at extra charge. Availability, technical features and equipment provided on our vehicles can vary by model. For precise information on the equipment provided on our vehicles, please contact your local Vauxhall Retailer.

VAUXHALL

vauxhall.co.uk

©2018 Vauxhall Motors Limited

Published 1 April 2018 Vauxhall Motors Limited

CORSA

PRICE/SPECIFICATION GUIDE

19 December 2017

Pre-current Model Year



VAUXHALL

CORSA PRICES

Model 3-door hatchback	Price (£)	VAT (£)	Total (£)	On-the-road RRP (£)	CO ₂ (g/km)
STING					
1.4i (75PS)	8441.67	1688.33	10130.00	11045.00	118
ENERGY (SPECIAL EDITION MODEL)					
1.4i (75PS) (a/c)	11016.67	2203.33	13220.00	14135.00	118
1.4i (90PS) (a/c)	11220.83	2244.17	13465.00	14380.00	118
1.4i (90PS) auto (a/c)	12358.33	2471.67	14830.00	15785.00	135
LIMITED EDITION (SPECIAL EDITION MODEL) VAUXHALL OnStar					
1.4i (75PS)	12737.50	2547.50	15285.00	16200.00	120
1.4i (90PS)	12941.67	2588.33	15530.00	16445.00	120
1.0i Turbo (115PS) Start/Stop	14179.17	2835.83	17015.00	17930.00	113
RED EDITION (SPECIAL EDITION MODEL) VAUXHALL OnStar					
1.4i Turbo (150PS) Start/Stop	14804.17	2960.83	17765.00	18720.00	132
BLACK EDITION (SPECIAL EDITION MODEL) VAUXHALL OnStar					
1.4i Turbo (150PS) Start/Stop	14804.17	2960.83	17765.00	18720.00	132
WHITE EDITION (SPECIAL EDITION MODEL) VAUXHALL OnStar					
1.4i Turbo (150PS) Start/Stop	14804.17	2960.83	17765.00	18720.00	132
SE VAUXHALL OnStar					
1.4i (90PS)	11387.50	2277.50	13665.00	14580.00	118
1.4i (90PS) auto	12525.00	2505.00	15030.00	15985.00	135

Model 5-door hatchback	Price (£)	VAT (£)	Total (£)	On-the-road RRP (£)	CO ₂ (g/km)
ENERGY (SPECIAL EDITION MODEL)					
1.4i (75PS) (a/c)	11516.67	2303.33	13820.00	14735.00	118
1.4i (90PS) (a/c)	11720.83	2344.17	14065.00	14980.00	118
1.4i (90PS) Start/Stop Easytronic (a/c)	12350.00	2470.00	14820.00	15715.00	110
1.4i (90PS) auto (a/c)	12858.33	2571.67	15430.00	16385.00	137
<i>Diesel</i>					
1.3CDTi (75PS) Start/Stop (a/c)	13308.33	2661.67	15970.00	16865.00	102
LIMITED EDITION (SPECIAL EDITION MODEL) VAUXHALL OnStar					
1.4i (90PS)	13441.67	2688.33	16130.00	17045.00	120
DESIGN					
1.4i (75PS)	10379.17	2075.83	12455.00	13370.00	120
1.4i (90PS)	10583.33	2116.67	12700.00	13615.00	120
1.4i (90PS) auto	11720.83	2344.17	14065.00	15020.00	139
<i>Diesel</i>					
1.3CDTi (95PS) Start/Stop ecoTEC Easytronic	13212.50	2642.50	15855.00	16730.00	91
SRI					
1.4i (75PS)	10937.50	2187.50	13125.00	14040.00	118
1.4i (90PS)	11141.67	2228.33	13370.00	14285.00	118
1.0i Turbo (90PS) Start/Stop ecoTEC	12379.17	2475.83	14855.00	15750.00	105
1.4i Turbo (100PS) Start/Stop	11687.50	2337.50	14025.00	14940.00	119
SE VAUXHALL OnStar					
1.4i (90PS)	11887.50	2377.50	14265.00	15180.00	118
1.4i (90PS) auto	13025.00	2605.00	15630.00	16585.00	137
ELITE VAUXHALL OnStar					
1.4i (90PS)	14220.83	2844.17	17065.00	17980.00	120

Please note: On-the-road recommended retail prices (RRP) include number plates and delivery to Retailer of £700.00 (inc. £116.67 VAT), 12 months' Vehicle Excise Duty and new vehicle first registration fee of £55.00. Excludes fuel and insurance.
a/c = Air conditioning.

Easytronic transmission is a five-speed manual gearbox with a fully automatic mode.
Our ecoTEC models combine superb performance, reduced CO₂ emissions and highly competitive economy figures.

CORSA FEATURES/OPTIONS

SAFETY

Driver/passenger airbags

- Driver's dual-stage airbag
- Front passenger's dual-stage airbag
- Front seat side-impact airbags
- Full-size curtain airbags

Seating

- Height-adjustable front seat head restraints
- Adjustable outer rear seat head restraints
- Anti-submarining ramps in all seats – Helps prevent occupants sliding underneath the lap belt during a collision

Seatbelts

- Height-adjustable front seatbelts
- Three inertia-reel lap and diagonal rear seatbelts
- Front seatbelt pretensioner system – Pretensioners tighten the seatbelt in the event of an accident limiting forward movement
- Front seatbelt force limiters – Reduces potential upper body injuries during a frontal impact
- Front and rear 'seatbelt unfastened' audible warning and warning light

Child safety

- Deactivation switch for front passenger's airbag – Permits the safe use of a child seat in the front passenger seat
- ISOFIX child seat mountings incorporating top tether anchor points located on outer rear seats (does not include child seat) – Allows ISOFIX child safety seats to be securely fixed into the car. The ISOFIX mounting system reduces forward movement in an accident and makes the child seat easier to install
- Child-proof locks on rear doors

Driver/passenger safety

- Energy-absorbing steering column
- Pedal release system – Reduces potential injury to the driver's legs and feet during a severe frontal impact
- Laminated windscreen
- Side-impact protection beams
- Reinforced passenger safety cell

Pedestrian safety

- Bonnet/headlight/wiper structure – Designed to reduce pedestrian head and upper body injuries
- Upper and lower bumper design – Reduces upper and lower leg injuries

Stability

Electronic Stability Programme (ESP):

– Works in conjunction with the vehicle's electronic braking and engine systems to keep the car stable in many different situations. ESP monitors many different inputs to determine when the car starts to lose traction, it can then immediately respond by varying the brake pressure between up to three wheels and adjust the engine output to help correct the loss of traction and improve stability.

Additional ESP features:

- Traction control
- Cornering brake control
- Straight line stability control
- Drag torque control – Maintain stability on slippery roads when lifting off the accelerator or changing gear

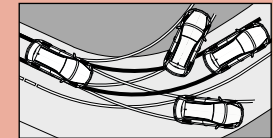

Braking

Anti-lock Braking System (ABS):

– Prevents the vehicle's wheels from locking up under heavy braking by momentarily reducing brake pressure at the appropriate wheel, ensuring that you can maintain control of the steering

Additional braking features:

– The same electronic systems used in the ABS and ESP also deliver exceptional braking performance.

- Emergency brake assist – When emergency braking is detected the vehicle automatically applies the maximum possible braking assistance
- Electronic brakeforce distribution – Automatically apportions the optimum braking force to each wheel
- Adaptive brake lights – Automatically warns other road users of heavy braking
- Hill start assist – Briefly maintains rear brake pressure to stop the vehicle rolling back on an incline
- Hazard warning lights

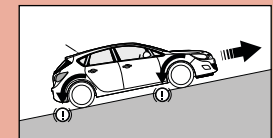

Tyre pressure





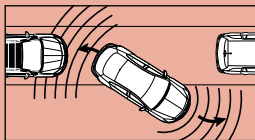
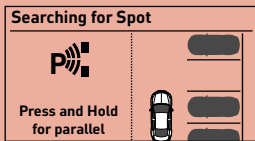
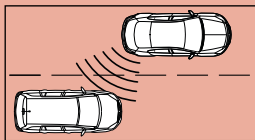
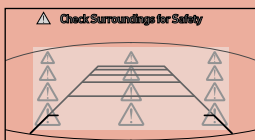

- Tyre pressure monitoring system

CORSA FEATURES/OPTIONS

	Sting	Sting R	Energy	Limited Edition	Red/Black/White Ed	Design	SRI	SRI VX-Line	SE	Elite	Price (£) exc. VAT	Total (£) inc. VAT
<p>DRIVER ASSISTANCE</p> <p>Cruise control with speed limiter <i>Cruise control feature – enables you to maintain a constant speed – making it ideal for economical motorway driving.</i> • The speed limiter function – can be set to ensure that you do not exceed the speed limit and can be easily overridden if required. • Steering wheel mounted controls</p>	●	●	●	●	●	●	●	●	●	●		
<p>Parking sensors</p> <p>• Rear parking distance sensors</p>	○	○	○	○	○	○	○	○	●	●	250.00	300.00
<p>• Front and rear parking distance sensors</p> <p>• Audible warning</p> <p>• Distance warning graphic shown in driver information display</p> 	○	○	○	○	○	○	○	○	●	●	387.50	465.00
<p>✓ Easier parking</p>												
<p>Advanced park assist with side blind spot alert <i>Park assist helps you find suitable parking spaces. The system automatically steers into the parking space, you just drive forwards or backwards as directed.</i> • Ultrasonic side sensors with 3 metre range • Ultrasonic front and rear parking sensors with a 1.5 metre range • Fully automated steering • Detailed forward/reverse instructions are shown in the instrument cluster <i>Please note: Body-colour door mirrors with black mirror frames are added to Energy and SRI models.</i></p> 			○	○	○	○	○				458.33	550.00
<p>✓ Finds suitable parking spaces ✓ Auto steers into the parking space for you</p>												
<p>Side blind spot alert: <i>Side blind spot alert helps prevent potential collisions with other vehicles 'hidden' in the vehicle's side blind spots. If a vehicle enters one of the blind spots a warning light illuminates in the relevant door mirror.</i> • LED warning light in door mirrors • Audible warning is sounded if the indicators are used and the system has detected another vehicle</p> 								○	○		208.33	250.00
<p>✓ Warns of vehicles in your blind spot</p>												
<p>Rear-view camera <i>The rear-view camera gives a clear view of the area behind your car and helps place the car perfectly, without needing to strain your neck.</i> • Activated when reverse gear selected • Camera view appears in infotainment screen • Rear bumper and one-metre grid lines shown as reference points <i>Please note: Only available in conjunction with parking sensors or advanced park assist. Not available with CD 30 BT audio unit or Flex-Fix® bicycle-carrier options.</i></p> 			○	○	○	○	○	○	○	●	208.33	250.00
<p>✓ See what's behind you on the central screen</p>												

● = Standard equipment. ○ = Optional at extra cost.

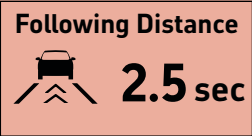
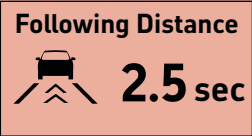
CORSA FEATURES/OPTIONS

	Sting	Sting R	Energy	Limited Edition	Red/Black/White Ed	Design	SRI	SRI VX-Line	SE	Elite	Price (£) exc. VAT	Total (£) inc. VAT
<p>DRIVER ASSISTANCE</p> <p>Driving Assistance Pack (deletes City mode steering) A wide range of class-leading driver assistance and safety features are controlled by the front camera system.</p> <p>Forward collision alert: The system warns you when approaching another vehicle too quickly – operates at speeds above 25mph.</p> <ul style="list-style-type: none"> • Visual warnings – projected onto windscreen and shown in the instrument cluster • Audible warning • Sensitivity can be adjusted via a steering wheel mounted control <p> Collision Alert</p> <p> Warns you of potential accidents</p> <p>Traffic sign recognition: Detects and then displays speed limits, reducing uncertainty and the risk of speeding.</p> <ul style="list-style-type: none"> • Recognises different road signs, including temporary speed restrictions • Displays reminder in the instrument cluster <p> Traffic Sign Memory</p> <p> Always know the speed limit</p> <p>Following distance indicator: At speeds above 25mph indicates how many seconds you are behind the vehicle in front – helping you maintain a safe distance.</p> <ul style="list-style-type: none"> • Timings are shown in the instrument cluster <p> Following Distance</p> <p> Keeps a safe distance</p> <p>Lane departure warning: If the driver has not actively steered or signalled, the lane departure warning system warns when the car moves outside of lane markings at speeds above 37mph.</p> <ul style="list-style-type: none"> • Warning light in instrument cluster • Audible warning • Facia on/off switch <p> Lane departure warning</p> <p> Keeps you in lane</p> <p>Additional features:</p> <ul style="list-style-type: none"> • Automatically dimming anti-dazzle rear-view mirror • Models with rain-sensitive windscreen wipers, automatic lighting control and bi-xenon headlights additionally feature headlight high beam assist 												
											550.00	660.00
<p>Steering</p> <ul style="list-style-type: none"> • Speed-sensitive electric power-assisted steering • City mode button – Provides lighter steering at parking speeds (deleted if Driving Assistance Pack is specified) 	●	●	●	●	●	●	●	●	●	●		

● = Standard equipment. ○ = Optional at extra cost.

CORSA FEATURES/OPTIONS

	Sting	Sting R	Energy	Limited Edition	Red/Black/White Ed	Design	SRI	SRI VX-Line	SE	Elite	Price (£) exc. VAT	Total (£) inc. VAT
SECURITY												
Standard security features <ul style="list-style-type: none"> • 'Key left in ignition' audible warning • Electronically protected audio equipment • Engine deadlock immobiliser • Visible Vehicle Identification Number (VIN) • Locking wheel bolts for alloy wheels (where fitted) • Door-to-door illumination 	●	●	●	●	●	●	●	●	●	●		
Central locking <ul style="list-style-type: none"> • Remote control • Operates on doors, tailgate and fuel filler flap • Deadlocking • Central locking activation switch on facia • One folding key/one static key each with integral remote control function 	●	●	●	●	●	●	●	●	●	●		
Security alarm system <ul style="list-style-type: none"> • Remote control (operates in conjunction with central locking) • Tilt sensor • Thatcham approved 	○	○	○	○	○	○	○	○	○	●	216.67	260.00

DRIVER INFORMATION

Instrumentation <ul style="list-style-type: none"> • Speedometer • Rev counter • Digital fuel gauge with low fuel level warning light • Digital water temperature gauge • Instrument panel light dimmer • Shift-up indication light – Indicates when to change gear for optimum fuel economy 	●	●	●	●	●	●	●	●	●	●		
Driver information display (centrally located in instrument cluster) <ul style="list-style-type: none"> • Displays trip computer data • Total mileage • Service-due indicator • Oil life • Tyre pressure monitoring system • Headlight/brake light bulb failure warning 	●	●	●	●	●	●	●	●	●	●		
Red graphics on black background	●	●										
Red graphics on black background (fitted in lieu of white graphics on 1.4i (75PS) and 1.4i (90PS) models if CD 30 BT audio unit is fitted in lieu of IntelliLink. Where digital speedometer and digital over-speed warning are standard, these features will be deleted. Not available separately. <i>Please note: If optional Driving Assistance Pack or advanced park assist is fitted, then the standard driver information display is retained</i>)			●	●		●	●	●				
White graphics on black background			●	●	●	●	●	●	●	●		
Central facia display (format dependent on infotainment unit) <ul style="list-style-type: none"> • Audio information • Digital clock with automatic RDS time adjustment • Outside air temperature with ice warning function • Additional features dependent on infotainment unit (see infotainment for details) 	●	●	●	●	●	●	●	●	●	●		
Multi-function trip computer (displayed on driver information display) <ul style="list-style-type: none"> • Trip mileage • Vehicle range based on remaining fuel • Average speed • Average fuel economy • Instantaneous fuel economy • Digital speedometer • Digital over-speed warning 				●	●		●	●	●	●		

● = Standard equipment. ○ = Optional at extra cost.

CORSA FEATURES/OPTIONS

INTERIOR STYLING	Sting	Sting R	Energy	Limited Edition	Red/Black/White Ed	Design	SRI	SRI VX-Line	SE	Elite	Price (£) exc. VAT	Total (£) inc. VAT
Sting interior décor Steering wheel: • Three-spoke design • Leather-covered • Satin chrome-effect bezel Facia and door trim: • Piano black facia • Black door panels with black Atlantis cloth inserts • Chrome-effect interior door handles Seat trim: • Spot Shimmer black fabric seat trim inserts • Plain black fabric side bolsters and surrounds	●											
Sting R interior décor Steering wheel: • VX-Line three-spoke design • Leather-covered flat bottom • Satin chrome-effect bezel Gear knob: • VX-Line leather-covered Facia and door trim: • Piano black facia • Black door panels with black Atlantis cloth inserts • Chrome-effect interior door handles Seat trim: • Spot Shimmer black fabric seat trim inserts • Plain black fabric side bolsters and surrounds		●										
Energy interior décor Steering wheel: • Three-spoke design • Leather-covered • Satin chrome-effect bezel Facia and door trim: • Rhutenium facia with chrome-effect trim inserts • Black door panels with black Atlantis cloth inserts • Chrome-effect interior door handles Seat trim: • Select black fabric seat trim inserts • Plain black fabric side bolsters and surrounds			●									
Limited Edition interior décor with Lace cloth seat trim Steering wheel: • VX-Line three-spoke design • Leather-covered flat bottom • Satin chrome-effect bezel Gear knob: • VX-Line leather-covered Facia and door trim: • Piano black facia with white inserts (fitted to Royal Blue, Flaming Yellow, Lime Green and Persian Blue models. All other exterior colours feature red inserts) • Black door panels with black Atlantis cloth inserts • Chrome-effect interior door handles Seat trim: • Black Lace fabric seat trim inserts • Plain black fabric side bolsters and surrounds with accent stitching				●								
Red Edition/Black Edition/White Edition interior décor with Lace cloth seat trim Steering wheel: • VX-Line three-spoke design • Leather-covered flat bottom • Satin chrome-effect bezel Gear knob: • VX-Line leather-covered Facia and door trim: • Piano black facia with white inserts (Black Edition models) • Piano black facia with red inserts (Red Edition/White Edition models) • Black door panels with black Atlantis cloth inserts • Chrome-effect interior door handles Seat trim: • Black Lace fabric seat trim inserts • Plain black fabric side bolsters and surrounds with accent stitching					●							
Limited Edition/Red Edition/Black Edition/White Edition interior décor with Network Moonray cloth seat trim (not available on Royal Blue models) Steering wheel: • VX-Line three-spoke design • Leather-covered flat bottom • Satin chrome-effect bezel Facia and door trim: • Piano black facia with white trim inserts (red trim inserts on Red Edition) • Black door panels with black Atlantis cloth inserts • Chrome-effect interior door handles Seat trim: • Network Moonray cloth seat trim inserts • Piano black facia side bolsters and surrounds				○	○						133.33	160.00

● = Standard equipment. ○ = Optional at extra cost.

CORSA FEATURES/OPTIONS

	Sting	Sting R	Energy	Limited Edition	Red/Black/White Ed	Design	SRI	SRI VX-Line	SE	Elite	Price (£) exc. VAT	Total (£) inc. VAT
<p>INTERIOR STYLING</p> <p>Limited Edition interior décor with Cityscape cloth seat trim (not available on Royal Blue, Lava Red, Flaming Yellow, Mandarinina or Lime Green models) Steering wheel: • VX-Line three-spoke design • Leather-covered flat bottom • Satin chrome-effect bezel Facia and door trim: • Piano black facia with Persian Blue trim inserts • Black door panels with black Atlantis cloth inserts • Chrome-effect interior door handles Seat trim: • Cityscape cloth seat trim inserts • Piano black facia side bolsters and surrounds</p>				○							133.33	160.00
<p>Design interior décor Steering wheel: • Three-spoke design • Leather-covered • Satin chrome-effect bezel Facia and door trim: • Rhutenium facia with chrome-effect trim inserts • Black door panels with black Atlantis cloth inserts • Chrome-effect interior door handles Seat trim: • Spot Shimmer black fabric seat trim inserts • Plain black fabric side bolsters and surrounds</p>						●						
<p>SRI/SRI VX-Line interior décor Steering wheel: • Three-spoke design • Leather-covered with accent stitching • Satin chrome-effect bezel Facia and door trim: • Piano black facia with red trim inserts (except Royal Blue models, which feature a white trim insert) • Black door panels with black Atlantis cloth inserts • Chrome-effect interior door handles Seat trim: • Lace black fabric seat trim inserts • Plain black fabric side bolsters and surrounds with accent stitching</p>							●	●				
<p>SE/Elite interior décor with Graphic Embossed black cloth/Morrocana seat trim Steering wheel: • Three-spoke design • Leather-covered with accent stitching • Satin chrome-effect bezel Facia and door trim: • Rhutenium facia with chrome-effect trim inserts • Black door panels with black Morrocana inserts • Chrome-effect interior door handles Seat trim: • Graphic Embossed black cloth seat trim inserts • Black Morrocana side bolsters and surrounds Front door sill covers: • Alloy-effect</p>									●	●		
<p>SE/Elite interior décor with Hysle Embossed Atmosphere cloth/Morrocana seat trim Steering wheel: • Three-spoke design • Leather-covered with accent stitching • Satin chrome-effect bezel Facia and door trim: • Matt Bronze-effect facia with chrome-effect trim inserts • Atmosphere glovebox lid • Black door panels with Atmosphere Morrocana inserts • Chrome-effect interior door handles Seat trim: • Hysle Embossed Atmosphere cloth seat trim inserts • Atmosphere Morrocana side bolsters and surrounds Front door sill covers: • Alloy-effect</p>									N/C	N/C	No-cost option	

● = Standard equipment. ○ = Optional at extra cost. N/C = No-cost option.

CORSA FEATURES/OPTIONS

INFOTAINMENT	Sting	Sting R	Energy	Limited Edition	Red/Black/White Ed	Design	SRI	SRI VX-Line	SE	Elite	Price (£) exc. VAT	Total (£) inc. VAT
CD 30 BT Onboard features: • CD/MP3 CD player • AM/FM stereo radio with 36 station presets • RDS with Traffic Programme <hr/> Media connections: • USB connection with iPod control • Aux-in socket <hr/> Mobile phone portal: • Bluetooth® connectivity • Handsfree calls via steering wheel controls • Vehicle microphone • Phone book access <i>Please note: On 1.4i (75PS) and 1.4i (90PS) models the trip computer including digital speedometer and digital over-speed warning are deleted.</i>	●	●	N/C	N/C	N/C	N/C	N/C	N/C	N/C			
R4.0 IntelliLink touchscreen infotainment system <i>For use with media players, USB memory sticks, mobile phones and smartphone apps.</i> Onboard features: • 7-inch colour touchscreen • DAB digital radio/AM/FM stereo radio with 36 station presets • RDS with Traffic Programme <hr/> Media connections: • USB connection with iPod control • Bluetooth® A2DP audio streaming (Advanced Audio Distribution Profile) <hr/> Mobile phone portal: • Bluetooth® connectivity • Handsfree calls via steering wheel controls • Vehicle microphone • Phone book access – <i>The majority of the phone's functions – contacts/last calls/missed calls etc. – are mirrored on IntelliLink's display and are easily navigated using the touchscreen (features dependent on mobile phone).</i> <hr/> Smartphone interface: • Apple CarPlay™ • Android Auto™ – <i>Smartphone projection that allows operations via voice command, touchscreen and buttons to control apps and music playback.</i>			●	●	●	●	●	●	●			







● = Standard equipment. N/C = No-cost option.

CORSA FEATURES/OPTIONS

	Sting	Sting R	Energy	Limited Edition	Red/Black/White Ed	Design	SRI	SRI VX-Line	SE	Elite	Price (£) exc. VAT	Total (£) inc. VAT
<p>INFOTAINMENT</p> <p>Navi 4.0 IntelliLink touchscreen navigation and infotainment system <i>For use with media players, USB memory sticks, mobile phones and smartphone apps.</i></p> <p>Onboard features:</p> <ul style="list-style-type: none"> • 7-inch colour touchscreen • DAB digital radio/AM/FM stereo radio with 36 station presets • RDS with Traffic Programme <p>Navigation features:</p> <ul style="list-style-type: none"> • Satellite navigation system • 2D street level mapping • European coverage • Structured or one-box destination entry • Points-of-interest search • Eco routing • Map updates via USB <p>Media connections:</p> <ul style="list-style-type: none"> • USB connection with iPod control • Bluetooth® A2DP audio streaming (Advanced Audio Distribution Profile) <p>Mobile phone portal:</p> <ul style="list-style-type: none"> • Bluetooth® connectivity • Handsfree calls via steering wheel controls • Vehicle microphone • Phone book access – <i>The majority of the phone's functions – contacts/last calls/missed calls etc. – are mirrored on IntelliLink's display and are easily navigated using the touchscreen (features dependent on mobile phone).</i> <p>Smartphone interface:</p> <ul style="list-style-type: none"> • Apple CarPlay™ • Android Auto™ – <i>Smartphone projection that allows operations via voice command, touchscreen and buttons to control apps and music playback.</i> <p>Gallery – only available when vehicle is stationary:</p> <ul style="list-style-type: none"> • Photo gallery with slide show feature • Video playback with soundtrack played through car speakers 			○	○	○	○	○	○	○	○	541.67	650.00
Six speakers	●	●	●	●	●	●	●	●	●	●		
<p>Wireless charger for mobile devices (only available with R4.0 IntelliLink. Maximum device dimensions 150mm x 79.88mm)</p> <p> Wireless mobile charging</p>			○	○	○	○	○	○	○	○	133.33	160.00
Steering wheel mounted audio controls	●	●	●	●	●	●	●	●	●	●		

● = Standard equipment. ○ = Optional at extra cost. N/C = No-cost option.





CORSA FEATURES/OPTIONS

INFOTAINMENT						Sting	Sting R	Energy	Limited Edition	Red/Black/White Ed	Design	SRI	SRI VX-Line	SE	Elite	Price (£) exc. VAT	Total (£) inc. VAT
																	
Automatic Crash Response	Wi-Fi Hotspot	Smartphone App	Stolen Vehicle Assistance	Vehicle Diagnostics	Destination Download												
<p>Vauxhall OnStar – your personal on board assistant*</p> <p><i>Many car brands talk about innovation as soon as they improve their cup holders but this innovative system, now available on selected models**, is revolutionary: 24/7, 365 days a year, Vauxhall OnStar puts you in touch with a trained advisor, not a machine. With OnStar you have access to a host of innovations, from Vehicle Diagnostics and Smartphone Function to a fully integrated 4G Wi-Fi Hotspot†. In the event of an accident, Vauxhall OnStar even automatically calls for help, for an incomparable feeling of safety.</i></p> <p>* = Includes 12 months of OnStar services from date of first registration and a 3 month/3 GB Wi-Fi free trial period (whichever comes first) effective from the date the customer accepts the nominated network operator Wi-Fi T's&C's. Theft alert feature only operates on models fitted with security alarm system. Destination download feature only operates on models fitted with Navi 4.0 IntelliLink satellite navigation system.</p> <p>** = The OnStar Services require activation and are subject to mobile network coverage and availability. Wi-Fi Hotspot service requires account with nominated network operator.</p> <p>† = 4G is subject to mobile network coverage and availability. Charges apply after the free trial period. The OnStar subscription packages could be different from the services included in the free trial package. Check www.vauxhall.co.uk/onstar for terms and conditions, details of availability, coverage and charges.</p>																	
								○	●	●	○	○	○	●	●	345.83	415.00



● = Standard equipment. ○ = Optional at extra cost.

CORSA FEATURES/OPTIONS

	Sting	Sting R	Energy	Limited Edition	Red/Black/White Ed	Design	SRI	SRI VX-Line	SE	Elite	Price (£) exc. VAT	Total (£) inc. VAT
HEATING AND VENTILATION Air blend heater • Cabin particulate filter – Removes dust, airborne particles and pollen • Four-speed fan • Illuminated controls	●	●										
Air conditioning • Air recirculation facility • Cabin particulate filter – Removes dust, airborne particles and pollen • Four-speed fan • Illuminated controls <i>Please note: Non air-conditioned Energy 1.4i (75PS) and 1.4i (90PS) manual models are also available.</i>	○	○	●	●	●	●	●	●	●		445.83	535.00
Electronic climate control incorporating air conditioning • Single-zone control • Advanced predictive logic control system using sun sensor • Cabin charcoal filter – Removes dust, airborne particles, pollen and unpleasant odours • Automatic air direction and fan speed with manual override • LCD temperature display • Six-speed fan • Illuminated controls <i>Please note: Not available on non air-conditioned Energy models.</i>											345.83	415.00
 Set and forget temperature control												
Winter Pack • Heated leather-covered steering wheel • Heated front seats  			●	○	○	○	○	○	●	●	304.17	365.00
 Warm welcome												
Additional features • Four adjustable facia vents • Windscreen demist vents • Side window demist vents • Heated rear screen with timed cut-off	●	●	●	●	●	●	●	●	●	●		

● = Standard equipment. ○ = Optional at extra cost.

CORSA FEATURES/OPTIONS

SEATING AND COMFORT	Sting	Sting R	Energy	Limited Edition	Red/Black/White Ed	Design	SRI	SRI VX-Line	SE	Elite	Price (£) exc. VAT	Total (£) inc. VAT
Reach and rake adjustable steering	●	●	●	●	●	●	●	●	●	●		
Comfort front seats												
Driver's seat (eight-way adjustable): • Height (up/down) • Reach (fore/aft)												
• Backrest (upright/recline) • Head restraint (up/down)	●	●	●			●			●	●		
Front passenger's seat (six-way adjustable): • Reach (fore/aft) • Backrest (upright/recline)												
• Head restraint (up/down)												
Sports-style front seats												
Driver's seat (eight-way adjustable): • Height (up/down) • Reach (fore/aft)												
• Backrest (upright/recline) • Head restraint (up/down)				●	●		●	●				
Front passenger's seat (six-way adjustable): • Reach (fore/aft) • Backrest (upright/recline)												
• Head restraint (up/down)												
Easy-entry front seats with memory function (three-door models only)	●	●	●	●	●	●	●	●	●			
Front passenger's seat height adjuster (fitted at no extra cost in conjunction with optional glass sunroof)	○	○	○	○	○	○	○	○	○	○	62.50	75.00
Rear seats												
• Three-person layout • Adjustable backrest • Height-adjustable and removable outer head restraints												
• ISOFIX child seat mountings incorporating top tether anchor points located on outer rear seats (does not include child seat) – Allows ISOFIX child safety seats to be securely fixed into the car. The ISOFIX mounting system reduces forward movement in an accident and makes the child seat easier to install.	●	●	●	●	●	●	●	●	●	●		
• Child-proof locks on rear doors												
• One-piece folding rear seat	●	●	●	●	●	●	●	●				
• 60/40 split-folding rear seat back	○	○	○	○	○	○	○	○	●	●	116.67	140.00

● = Standard equipment. ○ = Optional at extra cost.

CORSA FEATURES/OPTIONS

INTERIOR CONVENIENCE	Sting	Sting R	Energy	Limited Edition	Red/Black/White Ed	Design	SRI	SRI VX-Line	SE	Elite	Price (£) exc. VAT	Total (£) inc. VAT
Convenience features • Front 12-volt electrical accessory socket • Driver's and front passengers sunvisors • Driver's vanity mirror • Dipping rear-view mirror • Driver's and front passenger's tilttable assist handles • Two rear tilttable passenger assist handles (five-door models only)	●	●	●	●	●	●	●	●	●	●		
Driver's and front passenger's vanity mirrors with flip-up cover			●	●	●	●	●	●	●	●		
Automatically dimming anti-dazzle rear-view mirror			●	□	□	□	●	●	●	●		
Velour floor mats										●		
Interior lighting • Central front courtesy light • Central rear courtesy light • Fade up/fade down • Front map reading lights • Rear reading light (five-door models only)	●	●	●	●	●	●	●	●	●	●		
Interior storage • Storage box on driver's side lower fascia • Glovebox with lid • Front door pockets • Drinks holder in centre console • Rear door pockets (five-door models only) • Rear bottle holders (three-door models only)	●	●	●	●	●	●	●	●	●	●		
• Front passenger's underseat storage tray (deleted if optional sunroof is fitted)							●	●				
• Storage pockets on front seat backs									●	●		
Luggage area • Luggage compartment cover • Stowage facility for luggage compartment cover behind rear seats • Illuminated luggage area • Interior tailgate handles • Load restraint lashing eyes • Twin gas-assisted tailgate struts	●	●	●	●	●	●	●	●	●	●		

MECHANICAL

Standard features • Front-wheel drive • Gas-pressure dampers • Front anti-roll bar • Speed-sensitive electric power-assisted steering	●	●	●	●	●	●	●	●	●	●		
Sports suspension (fitted to SE models in conjunction with optional 17-inch wheels. Not available separately. Elite models with optional 16-inch alloy wheels are fitted with standard suspension in place of sports suspension)		●		●	●			●	○	●		
Transmissions Five-speed manual gearbox (excluding 1.0i Turbo (90PS)/(115PS) and 1.4i Turbo (100PS) models)	●		●	●		●	●	●	●	●		
Six-speed manual gearbox (1.0i Turbo (90PS)/(115PS), 1.4i Turbo (100PS) and 1.4i Turbo (150PS) models)		●	●	●	●	●	●	●	●	●		
Easytronic five-speed transmission with sequential manual gearshift or automatic mode (1.4i (90PS)/1.3CDTi (95PS) models only)			▲			▲						
Six-speed automatic transmission (1.4i (90PS) models only)			▲			▲	▲	▲	▲	▲		

● = Standard equipment. ○ = Optional at extra cost. ▲ = See price pages for details. □ = Available as part of an extra-cost option pack.

CORSA FEATURES/OPTIONS

	Sting	Sting R	Energy	Limited Edition	Red/Black/White Ed	Design	SRI	SRI VX-Line	SE	Elite	Price (£) exc. VAT	Total (£) inc. VAT
EXTERIOR LIGHTING												
Standard lighting features • Welcome lighting • Lights-on audible warning • Electric headlight beam levelling • High-level LED centre rear brake light • Rear fog light	●	●	●	●	●	●	●	●	●	●		
Halogen headlights	●	●	●	●	●	●	●	●	●			
Bi-xenon headlights with cornering light  Brighter headlights for better visibility				○	○			○	○	●	354.17	425.00
Daytime running lights	●	●										
LED daytime running lights			●	●	●	●	●	●	●	●		
Front fog lights with black surround			●	●	●	●						
Front fog lights with chrome-effect surround							●	●	●	●		
Sight and Light Pack One (not available with Driving Assistance Pack) • Rain-sensitive windscreen wipers • Automatic lighting control • Automatically dimming anti-dazzle rear-view mirror			●	○	○	○	●	●	●	●	200.00	240.00
Sight and Light Pack Two (only available with Driving Assistance Pack) • Rain-sensitive windscreen wipers • Automatic lighting control			●	○	○	○	●	●	●	●	175.00	210.00

● = Standard equipment. ○ = Optional at extra cost.

CORSA FEATURES/OPTIONS

EXTERIOR CONVENIENCE	Sting	Sting R	Energy	Limited Edition	Red/Black/White Ed	Design	SRi	SRi VX-Line	SE	Elite	Price (£) exc. VAT	Total (£) inc. VAT
Windscreen wipers • Two-speed windscreen wipers with variable intermittent wipe • Intermittent rear window wash/wipe	●	●	●	●	●	●	●	●	●	●		
• Rain-sensitive windscreen wipers			●	□	□	□	●	●	●	●		
Door mirrors • Manually foldable door mirrors	●	●	●	●	●	●	●	●	●	●		
• Electrically adjustable door mirrors (wide-angle on driver's side), manually foldable	●	●				●						
• Electrically adjustable/heated door mirrors (wide-angle on driver's side, except in conjunction with advanced park assist), manually foldable			●	●	●		●	●	●	●		
Windows • Heated windscreen • Electrically operated front windows with safety autoreverse and one-touch facility • Heated rear window	●	●	●	●	●	●	●	●	●	●		
Electrically operated slide/tilt panoramic glass sunroof • Manually operated interior blind • Non-metallic roof panel covering is coloured black • Front passenger's seat height adjuster Please note: Front passenger's underseat storage tray is deleted on SRi and SRi VX-Line models											741.67	890.00
 Enjoy fresh air at the touch of a button												
Flex-Fix® integrated two-bicycle carrier system (not available with rear-view camera or spare wheel) Please note: Bicycle size restrictions apply, please contact your local Retailer for further information.			○				○		○		558.33	670.00

● = Standard equipment. ○ = Optional at extra cost. □ = Available as part of an extra-cost option pack.

CORSA FEATURES/OPTIONS

EXTERIOR STYLING	Sting	Sting R	Energy	Limited Edition	Red/Black/White Ed	Design	SRi	SRi VX-Line	SE	Elite	Price (£) exc. VAT	Total (£) inc. VAT
Sting styling • Twin white stripes on bonnet, roof and tailgate • White door mirror housings • White front grille bar • Body-colour door handles	●											
Sting R styling • Twin black stripes on bonnet, roof and tailgate • Mineral Black door mirror housings • Black front grille bar • Body-colour door handles • Chrome-effect exhaust tailpipe extension		●										
Energy styling • Chrome-effect front grille bar • Body-colour door handles • Chrome-effect exhaust tailpipe extension (1.0i Turbo (115PS) models only)			●									
Limited Edition/Red/Black/White Edition styling • Mineral Black door mirror housings • Black front grille bar • Body-colour door handles • VX-Line body-colour front lower spoiler/side sills/rear lower skirt • VXR body-colour rear roof spoiler (3-door models only) • Mineral Black roof • Chrome-effect exhaust tailpipe extension				●	●							
Design/SRi styling • Chrome-effect front grille bar • Body-colour door handles						●	●					
SRi VX-Line styling • Chrome-effect front grille bar • Body-colour door mirrors with black mirror frame • Body-colour door handles • VX-Line body-colour front lower spoiler/side sills/rear lower skirt • VX-Line body-colour rear roof spoiler (3-door models only) • Chrome-effect exhaust tailpipe extension								●				
SE/ Elite styling • Chrome-effect front grille bar • Body-colour door mirrors with black mirror frame • Body-colour door handles • Chrome-effect lower side window mouldings (5-door models only) • Alloy-effect front door sill covers with 'Vauxhall' lettering									●	●		
Black foil on B-pillars (not with Royal Blue or optional Mineral Black or Darkmoon Blue exterior colours)	●	●	●	●	●	●	●	●	●	●		
Windows • Tinted windows	●	●	●	●	●	●	●	●	●	●		
• Dark-tinted rear windows			○	●	●	○	○	○	○	●	237.50	285.00

● = Standard equipment. ○ = Optional at extra cost.



CORSA FEATURES/OPTIONS

EXTERIOR COLOURS		Sting	Sting R	Energy	Limited Edition	Red/Black/White Ed	Design	SRi	SRi VX-Line	SE	Elite	Price (£) exc. VAT	Total (£) inc. VAT
	Royal Blue • Solid paint • Not available with Network Moonray or Cityscape cloth trims			●	●		●	●	●	●	●		
	Flaming Yellow • Brilliant paint • 3-door models only • Not available with Cityscape cloth trim	●	●	○	○		○			○		237.50	285.00
	Mandarina • Brilliant paint • Only available with Network Moonray cloth trim				○							237.50	285.00
	Lava Red • Brilliant paint • Not available with Cityscape cloth trim • Standard on Red Edition models, not available on Black or White Edition models	○	○	○	○	●	○	○	○	○	○	237.50	285.00
	Summit White • Brilliant paint • Standard on White Edition models, not available on Red or Black Edition models		○	○	○	●	○	○	○	○	○	237.50	285.00
	Mineral Black • Two-coat metallic paint • Standard on Black Edition models, not available on Red Edition or White Edition models	○		○	○	●	○	○	○	○	○	470.83	565.00
	Sovereign Silver • Two-coat metallic paint		○	○	○		○	○	○	○	○	470.83	565.00

● = Standard equipment. ○ = Optional at extra cost.

The colours reproduced may vary slightly from the actual paint colour. As a result they should be used as a guide only. Your Vauxhall Retailer has a comprehensive display of our paint samples.



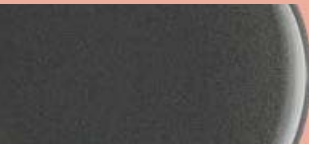
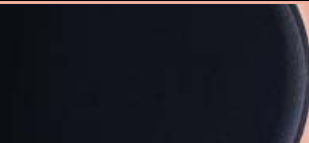
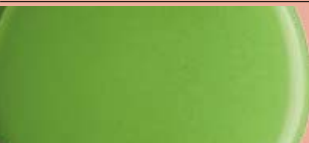
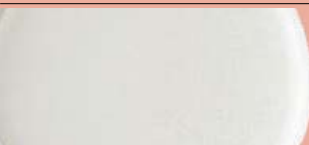

CORSA FEATURES/OPTIONS

EXTERIOR COLOURS		Sting	Sting R	Energy	Limited Edition	Red/Black/White Ed	Design	SRI	SRI VX-Line	SE	Elite	Price (£) exc. VAT	Total (£) inc. VAT
	Satin Steel Grey • Two-coat metallic paint		○	○	○		○	○	○	○	○	470.83	565.00
	Persian Blue • Two-coat metallic paint			○	○		○			○	○	470.83	565.00
	Quantum Grey • Two-coat metallic paint	○		○	○		○	○	○	○	○	470.83	565.00
	Darkmoon Blue • Two-coat premium paint	○		○			○	○	○	○	○	545.83	655.00
	Lime Green • Two-coat premium paint • Not available with Cityscape cloth trim	○	○	○	○		○					545.83	655.00
	Abalone White • Tri-coat premium paint • 5-door models only			○			○	○	○	○	○	604.17	725.00

○ = Optional at extra cost.





The colours reproduced may vary slightly from the actual paint colour. As a result they should be used as a guide only. Your Vauxhall Retailer has a comprehensive display of our paint samples.

CORSA FEATURES/OPTIONS

WHEELS AND TYRES		Sting	Sting R	Energy	Limited Edition	Red/Black/White Ed	Design	SRI	SRI VX-Line	SE	Elite	Price (£) exc. VAT	Total (£) inc. VAT
Steel emergency spare wheel (in lieu of emergency tyre inflation kit) – on Design models, only available with optional 16-inch steel wheels		○	○	○			○	○		○	○	91.67	110.00
Full-size steel spare wheel (in lieu of emergency tyre inflation kit) – not available with optional 16-inch steel wheels							○					91.67	110.00
	15-inch structure steel wheels with styled covers <ul style="list-style-type: none"> • 185/65 R 15 tyres • Emergency tyre inflation kit (in lieu of spare wheel) 						●						
	15-inch alloy wheels <ul style="list-style-type: none"> • 185/65 R 15 tyres • Emergency tyre inflation kit (in lieu of spare wheel) 						○					166.67	200.00
	16-inch steel wheels with flush covers <ul style="list-style-type: none"> • 195/55 R 16 tyres • Emergency tyre inflation kit (in lieu of spare wheel) • Only available in conjunction with 1.3CDTi (95PS) Easytronic models 						○					133.33	160.00
	16-inch 8-spoke alloy wheels <ul style="list-style-type: none"> • 195/55 R 16 tyres • Emergency tyre inflation kit (in lieu of spare wheel) 			●									
	16-inch white 4-twinspoke alloy wheels <ul style="list-style-type: none"> • 195/55 R 16 tyres • Emergency tyre inflation kit (in lieu of spare wheel) 	●											



● = Standard equipment. ○ = Optional at extra cost.

CORSA FEATURES/OPTIONS

WHEELS AND TYRES		Sting	Sting R	Energy	Limited Edition	Red/Black/White Ed	Design	SRi	SRi VX-Line	SE	Elite	Price (£) exc. VAT	Total (£) inc. VAT
	16-inch silver 4-twinspoke alloy wheels • 195/55 R 16 tyres • Emergency tyre inflation kit (in lieu of spare wheel) • Standard on SRi 5-door models, no-cost option on SRi 3-door models							●					
	16-inch black 4-twinspoke alloy wheels • 195/55 R 16 tyres • Emergency tyre inflation kit (in lieu of spare wheel) • Standard on SRi 3-door models, no-cost option on SRi 5-door models		●					●					
	16-inch alloy wheels • 195/55 R 16 tyres • Emergency tyre inflation kit (in lieu of spare wheel) • Deletes sports suspension on Elite models									●	N/C		
	17-inch silver alloy wheels • 215/45 R 17 tyres • Emergency tyre inflation kit (in lieu of spare wheel)			○					●			341.67	410.00
	17-inch black alloy wheels • 215/45 R 17 tyres • Emergency tyre inflation kit (in lieu of spare wheel)				●								



● = Standard equipment. ○ = Optional at extra cost. N/C = No-cost option.

CORSA FEATURES/OPTIONS

WHEELS AND TYRES		Sting	Sting R	Energy	Limited Edition	Red/Black/White Ed	Design	SRi	SRi VX-Line	SE	Elite	Price (£) exc. VAT	Total (£) inc. VAT
	17-inch diamond-cut black alloy wheels • 215/45 R 17 tyres • Emergency tyre inflation kit (in lieu of spare wheel)					●							
	17-inch diamond-cut titan alloy wheels • 215/45 R 17 tyres • Emergency tyre inflation kit (in lieu of spare wheel)								○			208.33	250.00
	17-inch diamond-cut titan alloy wheels • 215/45 R 17 tyres • Emergency tyre inflation kit (in lieu of spare wheel) • Includes sports suspension on SE models									○	●	400.00	480.00

● = Standard equipment. ○ = Optional at extra cost.

TYRE RATING

Tyre size	Fuel efficiency group	Wet grip performance	External noise	
			Measured (dB)	Group
185/65 R 15	B-C	B	69-70	
195/55 R 16	B-C	B	68-71	
215/45 R 17	C	B	71	

Tyre rating according to EU Regulation 1222/2009

CORSA SPECIFICATIONS

PETROL ENGINES

	1.4i (75PS)	1.4i (90PS)	1.4i Turbo (100PS) Start/Stop
Capacity	1398cc	1398cc	1364cc
Maximum power	75PS (55kW) @ 4200-6000rpm	90PS (66kW) @ 6000rpm	100PS (74kW) @ 3500-6000rpm
Maximum torque	130Nm (96 lb.ft.) @ 4000rpm	130Nm (96 lb.ft.) @ 4000rpm	200Nm (147 lb.ft.) @ 1850-3500rpm
Configuration	4 cylinders, 4 valves per cylinder, double overhead camshafts	4 cylinders, 4 valves per cylinder, double overhead camshafts	4 cylinders, 4 valves per cylinder, double overhead camshafts
Fuel/induction system	Naturally aspirated with Variable Valve Timing. Multi-point sequential fuel injection	Naturally aspirated with Variable Valve Timing. Multi-point sequential fuel injection	Turbocharger with intercooler. Variable Valve Timing. Multi-point sequential fuel injection
Emission compliance	Euro 6	Euro 6	Euro 6
Service interval	20,000 miles or 1 year (whichever occurs sooner)	20,000 miles or 1 year (whichever occurs sooner)	20,000 miles or 1 year (whichever occurs sooner)

	1.0i Turbo (90PS) Start/Stop ecoTEC	1.0i Turbo (115PS) Start/Stop	1.4i Turbo (150PS) Start/Stop
Capacity	999cc	999cc	1364cc
Maximum power	90PS (67kW) @ 3700-6000rpm	115PS (85kW) @ 5000-6000rpm	150PS (110kW) @ 5000rpm
Maximum torque	170Nm (125 lb.ft.) @ 1800-3700rpm	170Nm (125 lb.ft.) @ 1800-4500rpm	220Nm (162 lb.ft.) @ 2750-4500rpm
Configuration	3 cylinders, 4 valves per cylinder, double overhead camshafts	3 cylinders, 4 valves per cylinder, double overhead camshafts	4 cylinders, 4 valves per cylinder, double overhead camshafts
Fuel/induction system	Turbocharger with intercooler. Direct fuel injection	Turbocharger with intercooler. Direct fuel injection	Turbocharger with intercooler. Multi-point fuel injection
Emission compliance	Euro 6	Euro 6	Euro 6
Service interval	20,000 miles or 1 year (whichever occurs sooner)	20,000 miles or 1 year (whichever occurs sooner)	20,000 miles or 1 year (whichever occurs sooner)

DIESEL ENGINES

	1.3CDTi (75PS) Start/Stop	1.3CDTi (95PS) Start/Stop ecoTEC
Capacity	1248cc	1248cc
Maximum power	75PS (55kW) @ 3750rpm	95PS (70kW) @ 3750rpm
Maximum torque	190Nm (140 lb.ft.) @ 1500-2500rpm	190Nm (140 lb.ft.) @ 1500-3500rpm
Configuration	4 cylinders, 4 valves per cylinder, double overhead camshafts	4 cylinders, 4 valves per cylinder, double overhead camshafts
Fuel/induction system	Turbocharger with intercooler. Common rail fuel injection	Variable geometry turbocharger with intercooler. Common rail fuel injection
Emission compliance	Euro 6 with Diesel Particulate Filter	Euro 6 with Diesel Particulate Filter
Service interval	20,000 miles or 1 year (whichever occurs sooner)	20,000 miles or 1 year (whichever occurs sooner)

CORSA SPECIFICATIONS

PERFORMANCE, FUEL ECONOMY AND EMISSIONS

	Wheel size (inches)	Performance (manufacturer's figures)		Fuel economy mpg (litres/100km) [#]			CO ₂ emissions g/km [#]	Vehicle Excise Duty*		Benefit in kind company car taxation rates – 2017/18 tax year
		Maximum speed (mph)	Acceleration 0-62mph (sec)	Urban driving	Extra-urban driving	Combined figure		First year rate	Standard rate	
Manual										
1.4i (75PS)	15/17	101	15.5	41.5 (6.8)	65.7 (4.3)	54.3 (5.2)	120	£160	£140	23%
1.4i (75PS)	16	101	15.5	42.2 (6.7)	67.3 (4.2)	55.4 (5.1)	118	£160	£140	22%
1.4i (90PS)	15/17	109	13.2	41.5 (6.8)	65.7 (4.3)	54.3 (5.2)	120	£160	£140	23%
1.4i (90PS) (excluding Elite)	16	109	13.2	42.2 (6.7)	67.3 (4.2)	55.4 (5.1)	118	£160	£140	22%
1.4i (90PS) Elite (with optional wheels)	16	109	13.2	41.5 (6.8)	65.7 (4.3)	54.3 (5.2)	120	£160	£140	23%
1.0i Turbo (90PS) S/S ecoTEC 3-door	15/17	112	11.9	51.4 (5.5)	72.4 (3.9)	62.8 (4.5)	104	£140	£140	19%
1.0i Turbo (90PS) S/S ecoTEC 3-door	16	112	11.9	51.4 (5.5)	74.3 (3.8)	64.2 (4.4)	102	£140	£140	19%
1.0i Turbo (90PS) S/S ecoTEC 5-door	15/17	112	11.9	50.4 (5.6)	68.9 (4.1)	61.4 (4.6)	107	£140	£140	20%
1.0i Turbo (90PS) S/S ecoTEC 5-door (excluding Elite)	16	112	11.9	51.4 (5.5)	70.6 (4.0)	61.4 (4.6)	105	£140	£140	20%
1.0i Turbo (90PS) S/S ecoTEC 5-door Elite (with optional wheels)	16	112	11.9	50.4 (5.6)	68.9 (4.1)	61.4 (4.6)	107	£140	£140	20%
1.4i Turbo (100PS) S/S (excluding Elite)	16	115	11.0	44.1 (6.4)	65.7 (4.3)	55.4 (5.1)	119	£160	£140	22%
1.4i Turbo (100PS) S/S Elite (with optional wheels)	16	115	11.0	42.8 (6.6)	64.2 (4.4)	54.3 (5.2)	122	£160	£140	23%
1.4i Turbo (100PS) S/S	17	115	11.0	42.8 (6.6)	64.2 (4.4)	54.3 (5.2)	122	£160	£140	23%
1.0i Turbo (115PS) S/S 3-door	16	121	10.3	47.9 (5.9)	67.3 (4.2)	58.9 (4.8)	111	£160	£140	21%
1.0i Turbo (115PS) S/S 3-door	17	121	10.3	47.1 (6.0)	67.3 (4.2)	57.6 (4.9)	113	£160	£140	21%
1.0i Turbo (115PS) S/S 5-door	16	121	10.3	47.1 (6.0)	67.3 (4.2)	57.6 (4.9)	113	£160	£140	21%
1.0i Turbo (115PS) S/S 5-door	17	121	10.3	46.3 (6.1)	65.7 (4.3)	56.5 (5.0)	115	£160	£140	22%
1.4i Turbo (150PS) S/S 3-door	17	129	8.9	38.2 (7.4)	58.9 (4.8)	49.6 (5.7)	132	£200	£140	25%
1.4i Turbo (150PS) S/S 5-door	17	129	8.9	38.2 (7.4)	58.9 (4.8)	48.7 (5.8)	133	£200	£140	25%
1.3CDTi (75PS) S/S	15/17	102	14.8	58.9 (4.8)	83.1 (3.4)	72.4 (3.9)	104	£140	£140	22%
1.3CDTi (75PS) S/S	16	102	14.8	60.1 (4.7)	83.1 (3.4)	72.4 (3.9)	102	£140	£140	22%
1.3CDTi (95PS) S/S ecoTEC	15/17	113	11.9	68.9 (4.1)	88.3 (3.2)	78.5 (3.6)	94	£120	£140	20%
1.3CDTi (95PS) S/S ecoTEC (excluding Elite)	16	113	11.9	68.9 (4.1)	88.3 (3.2)	80.7 (3.5)	93	£120	£140	20%
1.3CDTi (95PS) S/S ecoTEC Elite (with optional wheels)	16	113	11.9	68.9 (4.1)	88.3 (3.2)	78.5 (3.6)	94	£120	£140	20%

* = Correct at time of publication. S/S = Start/Stop.

= Fuel consumption information is official government environmental data, tested in accordance with the relevant EU directive. Official EU-regulated test data is provided for comparison purposes and actual performance will depend on driving style, road conditions and other non-technical factors.

CORSA SPECIFICATIONS

PERFORMANCE, FUEL ECONOMY AND EMISSIONS

	Wheel size (inches)	Performance (manufacturer's figures)		Fuel economy mpg (litres/100km) [#]			CO ₂ emissions g/km [#]	Vehicle Excise Duty*		Benefit in kind company car taxation rates – 2017/18 tax year
		Maximum speed (mph)	Acceleration 0-62mph (sec)	Urban driving	Extra-urban driving	Combined figure		First year rate	Standard rate	
Easytronic										
1.4i (90PS) S/S Design 3-door	15	109	13.9	47.9 (5.9)	68.9 (4.1)	58.9 (4.8)	112	£160	£140	21%
1.4i (90PS) S/S Design 5-door	15	109	13.9	48.7 (5.8)	68.9 (4.1)	58.9 (4.8)	112	£160	£140	21%
1.4i (90PS) S/S Energy	16	109	13.9	48.7 (5.8)	70.6 (4.0)	60.1 (4.7)	110	£140	£140	21%
1.3CDTi (95PS) S/S ecoTEC	15	113	13.5	70.6 (4.0)	91.1 (3.1)	83.1 (3.4)	91	£120	£140	20%
1.3CDTi (95PS) S/S ecoTEC	16	113	13.5	72.4 (3.9)	91.1 (3.1)	83.1 (3.4)	90	£100	£140	20%
Automatic										
1.4i (90PS) 3-door	15/17	106	13.9	35.8 (7.9)	58.9 (4.8)	47.9 (5.9)	137	£200	£140	26%
1.4i (90PS) 3-door	16	106	13.9	36.2 (7.8)	60.1 (4.7)	47.9 (5.9)	135	£200	£140	26%
1.4i (90PS) 5-door	15/17	106	13.9	35.3 (8.0)	57.6 (4.9)	47.1 (6.0)	139	£200	£140	26%
1.4i (90PS) 5-door (excluding Elite)	16	106	13.9	35.8 (7.9)	58.9 (4.8)	47.9 (5.9)	137	£200	£140	26%
1.4i (90PS) 5-door Elite (with optional wheels)	16	106	13.9	35.3 (8.0)	57.6 (4.9)	47.1 (6.0)	139	£200	£140	26%

* = Correct at time of publication. S/S = Start/Stop.

= Fuel consumption information is official government environmental data, tested in accordance with the relevant EU directive. Official EU-regulated test data is provided for comparison purposes and actual performance will depend on driving style, road conditions and other non-technical factors.

CORSA SPECIFICATIONS

TRANSMISSION

Five-speed manual gearbox

Petrol engines: 1.4i (75PS), 1.4i (90PS) models

Diesel engines: All

Six-speed manual gearbox

Petrol engines: 1.0i Turbo (90PS),

1.4i Turbo (100PS), 1.0i Turbo (115PS),

1.4i Turbo (150PS) models

Five-speed Easytronic transmission

Optional on 1.4i (90PS) and 1.3CDTi (95PS)

models. Easytronic transmission is a five-speed manual gearbox with a fully automatic mode. In manual mode you simply push the lever forward or back to shift gears up or down sequentially. The fascia display tells you what gear you're in – 1 to 5, N for Neutral or A for Auto. Switch to fully automatic mode and it has many of the features of a regular automatic including a kickdown function. There's no clutch pedal so you can drive it on an automatic-only driving licence.

Six-speed automatic transmission

Optional on 1.4i (90PS) models. Electronically controlled with adaptive driving function that adjusts to the driving style and prevailing road conditions. Fluid drive with torque converter, lock-up clutch, neutral control fuel-saving feature and Active Select.

SUSPENSION

Front: Independent. Lightweight MacPherson struts with gas-pressure dampers and coil springs. Anti-roll bar.

Rear: Compound crank with coil springs and gas-pressure dampers.

- Sports suspension on Sting R/Limited Edition/SRi VX-Line/Elite models, and on SE models fitted with optional 17-inch alloy wheels

BRAKES

- Anti-lock Braking System (ABS)
- Electronic brakeforce distribution
- Emergency brake assist
- Cornering brake control
- Straight line stability control
- Dual circuit, diagonally split, dual rate servo-assisted system
- Low brake fluid level warning light

1.4i (75PS)

Front ventilated discs: 257mm diameter

Rear drums: 228mm diameter

1.4i (90PS)

Front ventilated discs: 257mm diameter

Rear drums: 228mm diameter

1.0i Turbo (90PS)

Front ventilated discs: 284mm diameter

Rear drums: 228mm diameter

1.4i Turbo (100PS)

Front ventilated discs: 284mm diameter

Rear discs: 264mm diameter

1.0i Turbo (115PS)

Front ventilated discs: 284mm diameter

Rear drums: 228mm diameter

1.4i Turbo (150PS)

Front ventilated discs: 308mm diameter

Rear discs: 264mm diameter

1.3CDTi (75PS)

Front ventilated discs: 284mm diameter

Rear drums: 228mm diameter

1.3CDTi (95PS)

Front ventilated discs: 284mm diameter

Rear drums: 228mm diameter

BODY

- Aerodynamic drag co-efficient: Cd 0.33

FUEL TANK CAPACITY

- 45 litres (9.9 gallons)

WEIGHTS AND TOWING DATA kg

	Gross vehicle weight		Maximum towing weights Trailer with brakes (without brakes)	
	3-door	5-door	3-door	5-door
1.4i (75PS) Energy	1585	1605	800 (550)	800 (550)
1.4i (75PS) Sting	1585	–	800 (550)	–
1.4i (75PS) Limited Edition/Design/SRi/SRi VX-Line/SE	1600	1620	800 (550)	800 (550)
1.4i (90PS) Sting/Energy	1585	1615	800 (550)	800 (550)
1.4i (90PS) Limited Edition/Design/SRi/SRi VX-Line/SE/Elite	1600	1630	800 (550)	800 (550)
1.4i (90PS) Easytronic	1620	1640	800 (550)	800 (550)
1.4i (90PS) auto	1630	1660	800 (550)	800 (550)
1.0i Turbo (90PS)	1650	1680	1200 (560)	1200 (560)
1.4i Turbo (100PS)	1680	1710	1150 (580)	1150 (580)
1.0i Turbo (115PS) Sting R	1635	–	1200 (560)	–
1.0i Turbo (115PS) Energy/Limited Edition/SRi VX-Line	1650	1680	1200 (560)	1200 (560)
1.4i Turbo (150PS)	1690	1720	1200 (580)	1200 (580)
1.3CDTi (75PS) Energy/Design/SRi/SRi VX-Line/SE	1680	1710	900 (580)	900 (580)
1.3CDTi (95PS)	1680	1710	1150 (580)	1150 (580)
1.3CDTi (95PS) Easytronic	1690	1710	1150 (580)	1150 (580)

Please note: For Sting, Sting R and Energy models fitted with optional air conditioning 15kg must be added to gross vehicle weight. Gross vehicle weight is the total permissible weight of the vehicle including passengers and their luggage. The maximum roof rack loading should not exceed 75kg. The maximum towing weights are based on the ability of the car, with two occupants of 75kg each, to restart on a 12% gradient, which is approximately 1 in 8.3, at sea level. The permitted trailer load applies up to the specified incline and up to an altitude of 1000 metres above sea level. The permissible gross train weight decreases by 10% for every 1000 metres of additional altitude. At altitudes above 1500 metres, the engine output may drop with a corresponding reduction in towing capability. Any extra weight, such as luggage or additional passengers, should be deducted from the maximum towing weight. With a trailer fully loaded, maximum noseweight should not exceed 55kg. Always fit Vauxhall towing attachments and accessories available from your Vauxhall Retailer. They are designed specifically for Vauxhall models and carry a 12-month guarantee.

CORSA SPECIFICATIONS

EXTERIOR DIMENSIONS millimetres (inches)

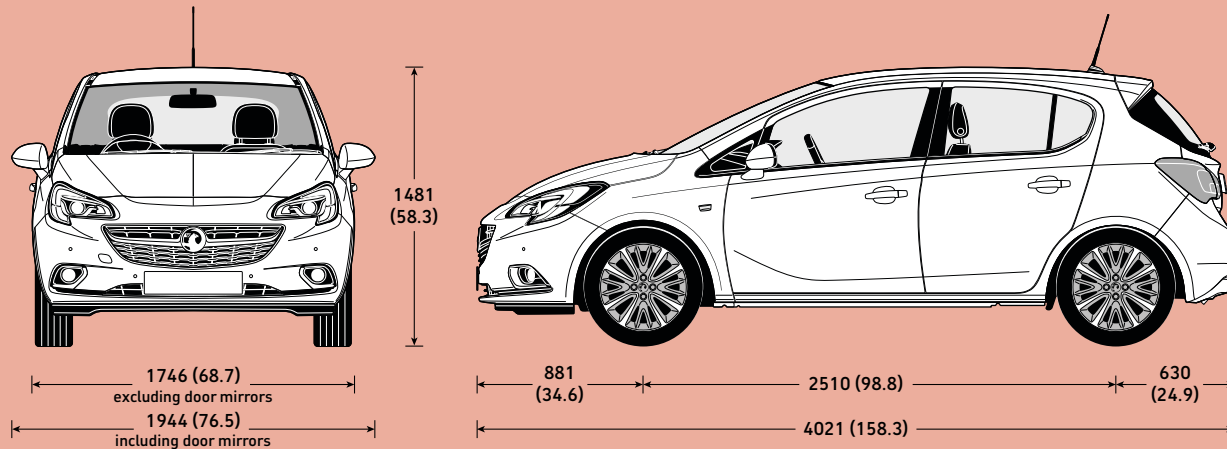
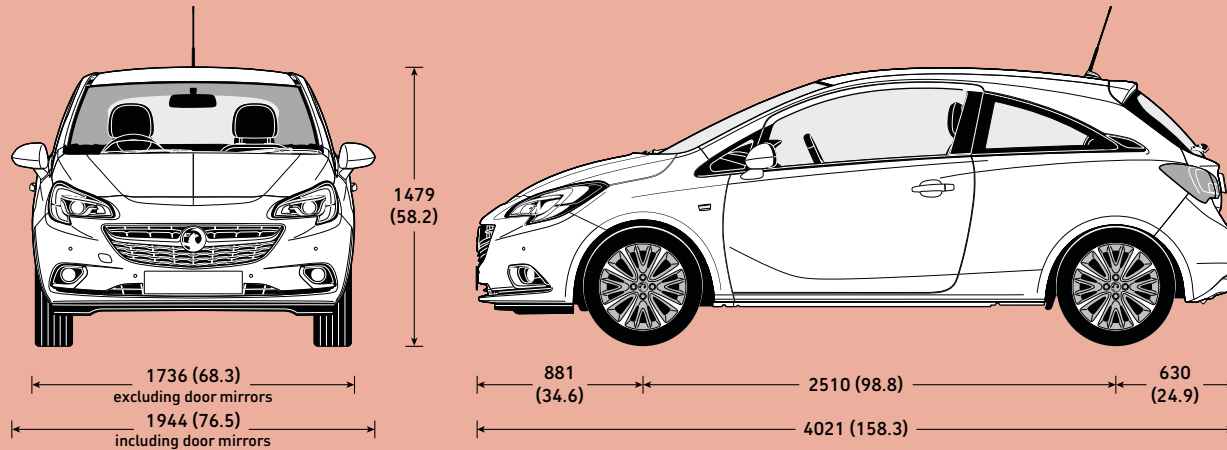

LOADSPACE DIMENSIONS mm (inches)

3-door

Maximum length (seats up)	705 (27.8)
Maximum length*	1372 (54.0)
Maximum width	944 (37.2)
Maximum height	843 (33.2)

5-door

Maximum length (seats up)	705 (27.8)
Maximum length*	1372 (54.0)
Maximum width	944 (37.2)
Maximum height	876 (34.5)

* = Behind front seats.

LOADSPACE CAPACITIES** litres (cu.ft.)

3-door

Rear seat up	280 (9.9)
Rear seat down (to glassline)	750 (26.5)
Rear seat down (to roof)	1090 (38.5)

5-door

Rear seat up	285 (10.0)
Rear seat down (to glassline)	710 (25.1)
Rear seat down (to roof)	1120 (39.5)

** = ECIE method.

FLEX-FIX® KEY DIMENSIONS mm (inches)

Maximum circumference around rim and tyre of bicycle	225 (8.9)
Maximum crank arm width	52 (2.0)
Maximum crank arm depth	25 (1.0)
Maximum crank arm length	no limit

CORSA ACCESSORIES

	Total (inc. VAT)
CHILD SEATS¹	
BABY-SAFE ² – 0-13kg/birth to 15 months	£132.00
– ISOFIX base	£227.00
DUO ISOFIX ² – 9-18kg/9 months to 4 years with top tether kit	£347.00
KID ³ – 15-36kg or 4 to 12 years	£157.00
<p><small>1 = Restrictions apply to the use of child seats, please consult your Vauxhall Retailer or request a copy of the Child seats brochure. 2 = Without transponder.</small></p>	
SAFETY	
Privacy shades – rear side windows (3-dr)	£73.00
Privacy shades – tailgate window (3-dr)	£89.00
Privacy shades – rear side windows (5-dr)	£91.00
Privacy shades – tailgate window (5-dr)	£91.00
Parking sensors	
– four fully flush front bumper mounted sensors – painted	£350.00
– four fully flush rear bumper mounted sensors – painted	£330.00
Safety Pack – first aid kit, warning triangle, hi-visibility vest, Vauxhall bag	£35.00
First aid kit	£15.00
Warning triangle	£17.00
Hi-visibility vest	£9.00
Fire extinguisher – 2kg	£37.00
Temporary tyre inflation kit	£150.00
Tyre sealant	£68.00

FLEXCONNECT RANGE

FlexConnect bracket	£20.00
FlexConnect hook	£28.00
FlexConnect coat hanger	£58.00
FlexConnect folding table	£68.00
FlexConnect iPad Mini cradle	£98.00
FlexConnect iPad (1-4) cradle	£106.00
FlexConnect iPad Air cradle	£106.00
FlexConnect Samsung Galaxy cradle	£96.00

	Total (inc. VAT)
SECURITY	
Locking wheel bolts – set of four	£43.00
PRACTICAL	
Spare bulb kit	£28.00
Spare bulb kit – ultra white	£37.00
Jump leads	
– petrol engines (16mm standard)	£47.00
– petrol/diesel engines (25mm heavy duty)	£86.00
Stretch tow rope – 3000kg	£34.00
Towing bar – 2500kg	£85.00
PROTECTION	
Carpet floor mats – set of four	£43.00
Rubber floor mats – front pair	£49.00
Rubber floor mats – rear pair	£31.00
Velour floor mats – set of four	£62.00
Cargo liner	£75.00
Luggage storage box – with dividers	£100.00
Universal luggage net	£26.00
Load-restraining floor net	£44.00
Rear bumper protection foil	£70.00
Mudflaps – front and rear set ³	£120.00

3 = Not available with certain exterior styling accessories.

	Total (inc. VAT)
TRANSPORT SYSTEMS	
Roof base carrier	£146.00
Roof carriers (requires base carrier)	
Bike roof carrier – Thule Freeride 532	£76.00
Surf board roof carrier – Thule 833	£101.00
Kayak roof carrier – Thule 837	£168.00
Ski roof carrier (400mm wide) – Thule Deluxe 726	£138.00
Ski roof carrier (600mm wide) – Thule 739	£235.00
Hard shell roof boxes (requires base carrier)	
Thule Ocean 80 (320 litre / 1330 x 860 x 370mm)	£235.00
Thule Ocean 200 (390 litre / 1750 x 820 x 450mm)	£316.00
Thule Dynamic M (320 litre / 2060 x 840 x 340mm)	from £625.00
Thule Dynamic L (430 litre / 2350 x 940 x 350mm)	£846.00
Thule Excellence (520 litre / 2180 x 940 x 400mm)	£898.00
Thule Motion 800 (460 litre / 2050 x 840 x 450mm)	from £515.00
Thule Touring 200 (400 litre / 1750 x 820 x 450mm)	£372.00
Thule Touring 780 (430 litre / 2320 x 700 x 420mm)	£460.00
Soft roof boxes (requires base carrier)	
Thule Ranger 90 (280 litre / 1100 x 800 x 400mm)	£285.00
Thule Ranger 500 (300 litre / 1900 x 500 x 300mm)	£378.00
Tailgate carrier	
Bike tailgate carrier – Thule BacPac 973	£282.00
Fitting kit	£48.00

	Total (inc. VAT)
ALLOY WHEELS (set of four with centre caps)⁴	
15-inch 8-spoke – silver	£727.00
16-inch 4-double-spoke – white	£852.00
16-inch 4-double-spoke – black	£873.00
16-inch 6-double-spoke – silver	£876.00
17-inch 5-twin-spoke – silver	£1008.00
17-inch 8-spoke – Titan gloss	£980.00

4 = Fitting time is based on four wheels fitted and includes static wheel balancing. Different tyres and locking wheel nuts may be required. Price excludes new tyres and locking wheel nuts.

Please note:

Prices shown are a fully fitted and painted, where applicable and include VAT. Please check with your local Vauxhall Retailer for details. It is advisable to ensure your insurance policy is adequate to cover additional fitted accessories. Prices correct at time of publication.

CORSA OFFERS IN DETAIL – TERMS AND CONDITIONS

Unless otherwise stated, all offers described are available on orders or registrations between 19 December 2017 – 18 December 2017. Offer prices quoted are correct at the time of publication (October 2017). Prices are subject to change. In line with Vauxhall's policy of price transparency, the offer price shown is an on-the-road price including VAT, number plates and delivery to Retailer of £700.00 (including £116.67 VAT), 12 months' Government Vehicle Excise Duty (variable depending upon model) and the DVLA's new vehicle first registration fee of £55.00. Excludes fuel and insurance. Offers may not apply to Retailer stocks and are subject to availability. Restrictions may apply. Contact your Retailer for details. Vauxhall Motors Limited reserves the right to change, amend or withdraw these offers at any point in time.

FLEXIBLE FINANCE

Available on selected models only, at participating Retailers. Conditional sale. Finance subject to status. Terms and Conditions apply. Applicants must be 18+. Finance supplied by Vauxhall Finance, CF15 7YT. Vauxhall Deposit Contributions vary and exclude certain models and are only available when vehicle is financed through Vauxhall Finance. 24-48 month term. Offer will apply to private individuals, Vauxhall Partners and small businesses 1- 24 units (purchase only, excluding B2B supported units). All other customers are excluded. Refer to www.vauxhall.co.uk/offers or contact your local Vauxhall Retailer for details.

FLEXIBLE PCP

Offer subject to availability at participating Retailers only. Personal Contract Purchase. Finance subject to status. Terms and Conditions apply. Applicants must be 18+. Finance by Vauxhall Finance, CF15 7YT. 24-48 month term available. Vauxhall deposit contribution only available when vehicle financed through Vauxhall Finance. At the end of the agreement there are three options: i) Pay the optional final payment to own the vehicle, ii) Return the vehicle, or iii) Replace: Part Exchange the vehicle, where equity is available. UK-supplied vehicles only. Offer applies to private individuals, Vauxhall Partners and small businesses 1-24 units (purchase only excluding B2B supported units). All other customers are excluded.

PERSONAL CONTRACT HIRE

Personal contract hire offer on vehicles ordered by 18 December 2017, subject to availability and status. Age 18+ only. Figures based on a non-maintenance contract hire package. Excess miles over contracted mileage of 24,000 over 36 months charged at a maximum of 14 pence per mile. Excess charges also apply if you breach manufacturer servicing or maintenance guidelines or if the car exceeds BVRLA Fair Wear & Tear guidelines for its age/mileage when it is returned to Vauxhall Leasing. Package includes Road Fund Licence and Vauxhall Assistance. Guarantee/indemnity may be required. Prices and details are subject to change without notice. For full specification and Ts&Cs contact your local Retailer. **You will not own the car.** ALD Automotive Ltd., trading as Vauxhall Leasing, BS16 7LB. Authorised and regulated by the Financial Conduct Authority.

Please note not all offers apply to all models.

CORSA ADDITIONAL INFORMATION

ON-THE-ROAD PRICES

To eliminate uncertainty about hidden costs when buying a new car, Vauxhall publishes on-the-road recommended retail prices (RRP) and these are shown in the pricing tables within this price guide. These prices include VAT, number plates and delivery to Retailer of £700.00 (including £116.67 VAT), 12 months' Government Vehicle Excise Duty (see opposite for details) and the DVLA new vehicle first registration fee of £55.00*.

Please note: The on-the-road recommended retail price (RRP) does not include fuel supplied by the Retailer, motor insurance or any other goods or services supplied by agreement between the Retailer and the customer.

PRICE PROTECTION

Order a new Vauxhall for build in the current model year (as confirmed by your Retailer) for delivery no more than three months in advance and the price you are quoted is the price you pay. This is irrespective of any subsequent price rises between placing your order and delivery of your new car, but you must take delivery as soon as the car is available. Vauxhall Motors Limited is not liable for price adjustments caused by Government changes in the rate of VAT (currently 20%), Vehicle Excise Duty, DVLA new vehicle first registration fee or by any other applicable legislation or regulations.

VEHICLE EXCISE DUTY

The amount of Vehicle Excise Duty (road fund licence) payable on new cars varies depending on the level of carbon dioxide (CO₂) emissions produced by the vehicle. CO₂ emissions are measured in grammes (g) per kilometre (km) travelled and divided into 13 charging bands shown in the table below.

A 'first year rate' of Vehicle Excise Duty is payable on all new cars and in subsequent years the amount payable reverts to the 'standard rate'. From 1 April 2017 the breakpoints for each of these bands have been revised. Also, for vehicles with a list price over £40,000, including factory-fitted options, an additional £310 is payable for the first five years of standard rate payments.

Vehicle Excise Duty*

	CO ₂ emissions (g/km)	First year rate	Standard rate
Band A	0	£0.00	£0.00
Band B	1-50	£10.00	£140.00
Band C	51-75	£25.00	£140.00
Band D	76-90	£100.00	£140.00
Band E	91-100	£120.00	£140.00
Band F	101-110	£140.00	£140.00
Band G	111-130	£160.00	£140.00
Band H	131-150	£200.00	£140.00
Band I	151-170	£500.00	£140.00
Band J	171-190	£800.00	£140.00
Band K	191-225	£1200.00	£140.00
Band L	226-255	£1700.00	£140.00
Band M	over 255	£2000.00	£140.00

* = Correct at time of issue.

VAUXHALL LEASING

As Vauxhall's own contract hire and fleet management operation, Vauxhall Leasing provides a one-stop-shop for competitive car and van leasing solutions – for business users and private individuals. Working with the Vauxhall Retailer network, we combine the support of a national contract with the convenience of a local contact.

For further information, please see your local Vauxhall Retailer or call us on **0117 908 6433**.

Alternatively, you can visit our website at

www.vauxhall-leasing.co.uk

IN THE EVENT OF AN ACCIDENT...

Vauxhall Accident Management helps keep you mobile following an accident. Benefits include vehicle recovery, Vauxhall-approved repairs and contacting your insurer. For more details, visit vauxhall.co.uk/AccidentManagement

TRUST VAUXHALL

CUSTOMER CARE COMMITMENT

For added peace of mind, Vauxhall has an innovative Customer Care Commitment that offers the following:

- Three-year vehicle warranty consisting of a one-year/unlimited mileage manufacturer's warranty and a second and third year manufacturer's warranty with a 60,000 miles limitation
- Vauxhall Assistance for 12 months from first registration
- Six years' body panel anti-perforation warranty

Please note: Warranty is only available on vehicles sourced from Vauxhall Motors Limited. Terms and conditions apply – please see your Vauxhall Retailer for details.

VAUXHALL ASSISTANCE

Vauxhall Assistance is provided automatically with every new Vauxhall for 12 months from first registration and covers everything from accident assistance, roadside recovery and 'at home' service to flat tyres. With Vauxhall Assistance help is literally just a free* phone call away, 24 hours a day, 365 days a year!

* = Mobile phone users will be charged at their standard tariff.

PROTECTING THE ENVIRONMENT

Vauxhall's commitment to the environment is demonstrated by our products' many environmental awards. For even more information on Vauxhall's efforts to achieve an environmentally sustainable future, and how to dispose of your end-of-life vehicle, see www.vauxhall.co.uk/recycling

VAUXHALL SERVICE PLAN

- Fixed monthly payments for the plan duration
- Easy to budget and interest-free
- Genuine parts fitted by Vauxhall-trained technicians

Plus on Gold plans:

- Valet and courtesy car
- Full AA cover
- Engine flush and fuel treatments
- Litre of oil for top ups between services

Full details can be obtained from your local participating Vauxhall Retailer.

VAUXHALL INSURANCE WITH ADDED REASSURANCE

Comprehensive cover – Summary of benefits**

- Competitive premiums
- Repairs by a Vauxhall-trained technician
- Genuine Vauxhall parts, guaranteed for three years when we repair your car within our Approved Repairer Network
- Free courtesy car as standard when using an Approved Repairer†
- 24 hour claims helpline
- Personal Accident benefit
- Cover for audio equipment
- Windscreen cover

Call for a quote on 0844 463 2670††

** = The benefits listed above are for comprehensive cover only. For details of Third Party, Fire and Theft cover, please call our sales team.
† = Should your car need repairing following an accident we provide a courtesy car (subject to availability) for the duration of the repair. Only genuine Vauxhall parts are used. Terms and conditions apply.
†† = Calls may be recorded. Vauxhall Insurance is underwritten by Ageas Insurance Limited.

FOR MORE PRODUCT INFORMATION

For a brochure on any Vauxhall model (up to a maximum of three per caller) or location of your nearest Vauxhall Retailer please call **0345 600 1500**. Alternatively, details can be found on our website at www.vauxhall.co.uk

JOIN US ONLINE:



PROUD SPONSOR OF OUR NATIONAL FOOTBALL TEAMS



Privacy Policy – For full details please visit: vauxhall.co.uk/privacy

Vauxhall OnStar privacy details are available at vauxhall.co.uk/onstar

The invoice price, including delivery to Retailer, factory-fitted options, accessories fitted by the Retailer and number plates, is subject to VAT. Some feature descriptions in this guide may refer to, and some illustrations may show, optional equipment not included in the standard delivery. The information contained in this guide was accurate at the time of publication. We reserve the right to make changes in design and equipment. Please note that Vauxhall Retailers are not the agents of Vauxhall Motors Limited and are not authorised to bind Vauxhall Motors Limited by any specific or implied undertaking or representation. It is advisable to ensure that your motor insurance policy provides adequate cover for additional fitted options and accessories. The colours in this guide are only approximate actual colours. Illustrated optional equipment is available at extra charge. Availability, technical features and equipment provided on our vehicles can vary by model. For precise information on the equipment provided on our vehicles, please contact your local Vauxhall Retailer.

VAUXHALL

vauxhall.co.uk

©2017 Vauxhall Motors Limited

Published 19 December 2017 Vauxhall Motors Limited