

# ANTARA PRICE/SPECIFICATION GUIDE

16 December 2014



Proud Sponsor of Home Nations Football



# ANTARA CUSTOMER OFFERS

At Vauxhall we know that customers appreciate flexibility. Not only do we have an extensive range of Antara models to choose from, on most of them you can also take advantage of our Flexible Finance offer. Here's how it works:

---

**0% APR**  
REPRESENTATIVE  
**FLEXIBLE FINANCE**

---



- 1 CHOOSE YOUR CAR**  
Select a new vehicle.
- 2 CHOOSE YOUR DEPOSIT**  
Any deposit. We'll give you £250 to get you started.

- 3 CHOOSE YOUR TERM**  
From 24 to 60 months.

---

For even more great deals contact your local retailer or call 0845 600 1500 or visit [www.vauxhall.co.uk/offers](http://www.vauxhall.co.uk/offers)

**TERMS AND CONDITIONS:** Available on selected models only, at participating retailers. Conditional Sale. Finance subject to status. Terms and Conditions apply. Applicants must be 18 or over. Finance supplied by Vauxhall Finance, PO Box 6666, Cardiff, CF15 7YT. 24-60 month term. Offer will apply to private individuals, Vauxhall Partners and small businesses 1- 24 (purchase only, excluding B2B supported units). All other customers are excluded. Refer to [www.vauxhall.co.uk/offers](http://www.vauxhall.co.uk/offers) or contact your local Vauxhall retailer for details.

# ANTARA COMPANY CAR DRIVER/FLEET INFORMATION

## COMPANY CAR DRIVER FREE\* 3 DAY TEST DRIVE



Our free\* 3 Day Test Drive programme is open to all Company Car Drivers which allows you to choose any model in the current Vauxhall line-up (excluding Ampera, all VXR models and Commercial Vehicles), with full insurance cover provided, to give you a meaningful length of time to make an informed decision about your next company car.

Click below to book your free\* test drive  
[www.vauxhall3dtd.co.uk](http://www.vauxhall3dtd.co.uk)  
or call **0870 240 4848\*\***

\*The free 3 Day Test Drive programme is open to Company Car Drivers and excludes fuel and lubricants; congestion charges; parking and speeding fines and the £250 insurance excess (if applicable). It features a wide selection of models from the Vauxhall range (excluding Ampera, all VXR models and Commercial Vehicles and subject to availability). Drivers must be aged 25 years or over, have held a full driving licence for at least a year and hold a major credit card. You will need to have your driving licence (and proof of identity (i.e. passport) where the driving licence is not a photocard licence) when your car is delivered. While every effort will be made to ensure that at least 3 days are provided for the test drive, this cannot always be guaranteed due to delivery and collection dates and timings. Available for UK Mainland only. Terms and conditions apply. \*\*Telephone lines open Monday-Friday 9.00am to 5.00pm excluding Bank Holidays. Calls may be recorded or monitored for quality and/or training purposes.

## FLEET TOOLBOX



Discover the facts in our online Toolbox for both Company Car Drivers and Fleet Decision Makers. The Fleet Toolbox has a host of useful calculators, comparators, interactive listings and information. Visit the Fleet Toolbox by going to [www.vauxhall-toolbox.co.uk](http://www.vauxhall-toolbox.co.uk)

## ROADTRIP APP



The Vauxhall RoadTrip App is a free app that calculates and logs your mileage expenses for any UK business trips and generates reports to help you complete your mileage claims. Available for both iPhone and Android, visit [www.vauxhall-toolbox.co.uk](http://www.vauxhall-toolbox.co.uk) or visit the iPhone or Android stores and search for Vauxhall RoadTrip to download it to your smartphone or tablet.

## BENEFIT IN KIND COMPANY CAR TAXATION†

The car benefit charge will be the car's list price (including VAT, options and accessories fitted, delivery to retailer and number plates, but excluding Vehicle Excise Duty and new vehicle first registration fee) multiplied by the percentage charge for the CO<sub>2</sub> emissions band in which the car falls (see table opposite). Multiply this figure by your personal income tax rate (20% for Basic Rate, 40% for Higher Rate) to calculate your annual benefit in kind tax liability.

### Example:

**Antara Exclusiv FWD 2.2CDTi Start/Stop manual**  
(CO<sub>2</sub> emissions 167g/km)

On-the-road RRP	£21065.00
Deduct: Vehicle Excise Duty	(£290.00)
New vehicle first registration fee	(£55.00)
<b>Effective list price</b>	<b>£20720.00</b>
Add: Optional two-coat metallic paint	£545.00
<b>List price for tax purposes (P11D value)</b>	<b>£21265.00</b>

<b>Car benefit charge</b>	
2014-15 tax year (29%)	£6166.00
<b>Benefit in kind tax liability (2014-15 tax year)</b>	
Basic Rate (20%) tax payer	£1233.00
Higher Rate (40%) tax payer	£2466.00

† = Please note this Price Guide provides taxation information as a guide only. Vauxhall does not provide taxation guidance. Drivers should always take professional advice on their own tax position.

CO <sub>2</sub> emissions in grams per kilometre	Percentage of car's price to be taxed	
	Petrol 2014-15 tax year	Diesel 2014-15 tax year
up to 75	5	8
76-94	11	14
95-99	12	15
100-104	13	16
105-109	14	17
110-114	15	18
115-119	16	19
120-124	17	20
125-129	18	21
130-134	19	22
135-139	20	23
140-144	21	24
145-149	22	25
150-154	23	26
155-159	24	27
160-164	25	28
165-169	26	29
170-174	27	30
175-179	28	31
180-184	29	32
185-189	30	33
190-194	31	34
195-199	32	35
200-204	33	35
205-209	34	35
210 and above	35	35

To calculate your own personal liability a car tax calculator is available at:  
<https://www.vauxhallfleet.co.uk/toolbox>

## CONTACT VAUXHALL FLEET

Please contact one of our dedicated sales teams who will be happy to help with your particular enquiry.

### Company Car Drivers

Call: **0845 111 2020**

Email: [company-car@vauxhallinfo.co.uk](mailto:company-car@vauxhallinfo.co.uk)

Telephone lines are open

– Monday to Friday 8.00am-9.00pm

– Saturday and Sunday 9.00am-6.00pm

### Fleet Decision Makers

Depending on the size of your fleet of vehicles, we have a dedicated team to handle your enquiries. The lines are open Monday to Friday excluding Bank Holidays.

### 1-24 vehicles

Call: **0845 076 2254** (8.30am-5.00pm)

Email: [b2bsales@vauxhall.co.uk](mailto:b2bsales@vauxhall.co.uk)

### 25+ vehicles

Call: **0870 010 0651** (8.30am-5.00pm)

Email: [vauxhallfleet@vauxhall.co.uk](mailto:vauxhallfleet@vauxhall.co.uk)

### Special Vehicles (Police, Fire and Ambulance)

Call: **01525 408 320** (8.30am-5.00pm)

Email: [vauxhallspecialvehicles@vauxhall.co.uk](mailto:vauxhallspecialvehicles@vauxhall.co.uk)

# ANTARA RANGE HIGHLIGHTS

---

## EXCLUSIV

£19,835-£24,665

- Electronic Stability Programme (ESP)
- Anti-lock Braking System (ABS)
- Descent control system
- Tyre pressure monitoring system
- Driver's and front passenger's airbags
- Front seat side-impact airbags
- Front and outer rear seat full-size curtain airbags
- Air conditioning
- Heated front seats
- Driver's seat with manual reach, height and lumbar adjustment
- Morrocana-trimmed side bolsters on seats
- Electric parking brake
- Engine deadlock immobiliser
- Remote control ultrasonic security alarm system
- Remote control two-stage central deadlocking
- Door-to-door illumination
- Steering column adjustable for reach and rake
- Three-spoke leather-covered steering wheel
- Leather-covered gear knob (manual models only)
- Rear seat centre armrest
- Front fog lights
- Automatic self-levelling rear suspension
- Silver-effect roof rails
- Electrically adjustable/heated door mirrors
- CD/MP3 CD player/stereo radio
- Bluetooth® connectivity
- USB connection
- Aux-in socket
- Steering wheel mounted audio controls
- 17-inch alloy wheels with 235/65 R 17 low profile tyres
- Emergency tyre inflation kit in lieu of spare wheel
- Dark-tinted rear windows

### Exclusiv 4X4 models also feature:

- Intelligent four-wheel drive
- Multi-function trip computer
- Cruise control
- Traction control
- Parking distance sensors front and rear
- 18-inch alloy wheels with 235/55 R 18 ultra-low profile tyres

## DIAMOND

£21,865-£25,465

### Features over Exclusiv/Exclusiv 4X4

- Leather seat facings
- Driver's seat with electrical reach, rake, height and tilt adjustment, manual lumbar adjustment

## SE NAV

£26,325-£28,565

### Features over Diamond 4X4

- Touch and Connect multi-media unit with satellite navigation, colour touch-screen, Bluetooth® connectivity and USB connection with iPod control
- 19-inch alloy wheels with 235/50 R 19 ultra-low profile tyres
- Dual-zone Electronic Climate Control (ECC)
- Xenon headlights with dynamic beam levelling and high-pressure headlight washers
- Electro-chromatic anti-dazzle rear-view mirror
- Electrically foldable door mirrors
- Front passenger's seat with fold-flat facility
- Automatic lighting control
- Rain-sensitive windscreen wipers
- Heat-reflective windscreen
- Twin illuminated vanity mirrors
- Front and rear alloy-effect protective skid plates

# ANTARA PRICES

Model 5-door SUV	Price (£)	VAT (£)	Total (£)	On-the-road RRP (£)	CO <sub>2</sub> (g/km)
<b>EXCLUSIV</b>					
2.4i 167PS	15370.83	3074.17	18445.00	<b>19835.00</b>	206
<i>Diesel</i>					
2.2CDTi 163PS Start/Stop	16683.33	3336.67	20020.00	<b>21065.00</b>	167
2.2CDTi 163PS Start/Stop 4X4	18654.17	3730.83	22385.00	<b>23485.00</b>	177
2.2CDTi 163PS 4X4 auto	19395.83	3879.17	23275.00	<b>24665.00</b>	225
<b>DIAMOND</b>					
<i>Diesel</i>					
2.2CDTi 163PS Start/Stop	17350.00	3470.00	20820.00	<b>21865.00</b>	167
2.2CDTi 163PS Start/Stop 4X4	19320.83	3864.17	23185.00	<b>24285.00</b>	177
2.2CDTi 163PS 4X4 auto	20062.50	4012.50	24075.00	<b>25465.00</b>	225
<b>SE NAV</b>					
<i>Diesel</i>					
2.2CDTi 163PS Start/Stop 4X4	21020.83	4204.17	25225.00	<b>26325.00</b>	177
2.2CDTi 163PS 4X4 auto	21770.83	4354.17	26125.00	<b>27515.00</b>	225
2.2CDTi 184PS Start/Stop 4X4	21904.17	4380.83	26285.00	<b>27385.00</b>	177
2.2CDTi 184PS 4X4 auto	22645.83	4529.17	27175.00	<b>28565.00</b>	225

**Please note:** On-the-road recommended retail prices (RRP) include number plates and delivery to retailer of £700.00 (inc. £116.67 VAT), 12 months' Vehicle Excise Duty and new vehicle first registration fee of £55.00. Excludes fuel and insurance.

# ANTARA FEATURES/OPTIONS

## SAFETY

### Standard features

**Airbags:** • Driver's airbag • Front passenger's airbag • Front seat side-impact airbags • Full-size curtain airbags • Deactivation switch for front passenger's airbag

**Seating:** • ISOFIX child seat restraint system for outer rear seats (does not include child seat) – Secures ISOFIX child safety seats to the vehicle itself, virtually eliminating the dangers that can result from improper installation • Height-adjustable front and outer rear seat head restraints • Front body-lock lap and diagonal seatbelt pretensioner system – Tightens the lap and diagonal belts during the early stages of a frontal impact • Outer rear body-lock diagonal seatbelt pretensioner system • Front and outer rear seatbelt force limiters – Reduce potential upper body injuries during a frontal impact • Anti-submarining ramps in all seats – Help prevent occupants sliding underneath the lap belt during a collision

**Electronic:** • Electronic Stability Programme (ESP) • Anti-lock Braking System (ABS) • Electronic brakeforce distribution – Distributes the braking force between the wheels most able to use it, allowing stable and efficient braking • Cornering brake control • Emergency brake assist – Increases applied brake force in emergency braking situations • Descent control system • Trailer stability programme • Adaptive brake lights – If the driver brakes hard enough to activate the ABS the brake lights flash on and off at the rate of four times per second, thus warning following vehicles that heavy braking is in progress • Electric parking brake • Tyre pressure monitoring system

**Body:** • Energy-absorbing steering column • Pedal release system – Reduces potential injury to the driver's legs and feet during a severe frontal impact • Laminated windscreen • Side-impact protection beams • Integral protective side door padding • Reinforced passenger safety cell • Deformation zones front and rear • Burst-proof door locks and anti-jam door design • Child-proof locks on rear doors

### Additional feature

Safety interlock on models with automatic transmission – Requires the foot brake to be applied before shifting out of Park

Exclusiv FWD	Exclusiv 4X4	Diamond FWD	Diamond 4X4	SE Nav	Price (£) exc. VAT	Total (£) inc. VAT
	●		●	●		

## SECURITY

**Standard features** • Remote control ultrasonic security alarm system • Remote control two-stage central deadlocking (doors, tailgate, fuel filler flap) • Visible Vehicle Identification Number (VIN) plate • Electronic engine deadlock immobiliser • Electronic theft protection for audio equipment • Driver's internal central locking switch • Freewheeling driver's door lock • Door-to-door illumination – Keeps the headlights and rear lights on for 30 seconds after the car doors are locked • Retractable luggage area cover • Folding key • Locking wheel nuts

## HEATING AND VENTILATION

**Standard features** • Interior pollen filter • Air recirculation with activation light • Air blend heater with four-speed fan • Rear passenger compartment heating outlets

### Additional features

Air conditioning  
Dual-zone Electronic Climate Control (ECC)

Exclusiv FWD	Exclusiv 4X4	Diamond FWD	Diamond 4X4	SE Nav	Price (£) exc. VAT	Total (£) inc. VAT
●	●	●	●	●		

● = Standard equipment.

# ANTARA FEATURES/OPTIONS

## FACIA, INSTRUMENTS AND CONTROLS

**Standard features** • Multi-function display showing time, date, audio information and outside air temperature (with ice warning function) • Rev counter • Digital clock with automatic RDS time adjustment • Black instruments with chrome edging • Leather-covered three-spoke steering wheel • Leather-covered gear knob (manual models only) • Steering column adjustable for reach and rake • Electronic odometer and trip odometer • Instrument panel light dimmer • Handbrake-on/low brake fluid level and low fuel level warning lights • Service interval monitor • Seatbelt unfastened warning light for front seats

<b>Additional features</b>	<b>Exclusiv FWD</b>	<b>Exclusiv 4X4</b>	<b>Diamond FWD</b>	<b>Diamond 4X4</b>	<b>SE Nav</b>	<b>Price (£) exc. VAT</b>	<b>Total (£) inc. VAT</b>
Cruise control		●		●	●		
Multi-function trip computer with graphic information display <sup>1</sup>		●		●	●		

## INTERIOR FEATURES

**Standard features** • Driver's seat with manual lumbar adjustment • Electrically heated front seats with variable temperature settings • Lidded glovebox • Charcoal metallic-effect centre console • 12-volt auxiliary power socket within centre console • Drinks holders in front centre console • Front centre armrest with storage facility • Chrome-effect interior door handles • Colour-keyed fleece velour carpet • Front door pockets • Front passenger's underseat storage tray • Map pockets on front seat backs • Drinks holders in rear passengers' armrest • FlexOrganiser® rails in sides of luggage area • Fully carpeted and illuminated luggage area • Front map reading lights integral with courtesy light • Rear reading lights • Fade up/fade down courtesy lighting operated by door switches • 60/40 split-folding rear seat back • Adjustable rear seat backrest

<b>Additional features</b>	<b>Exclusiv FWD</b>	<b>Exclusiv 4X4</b>	<b>Diamond FWD</b>	<b>Diamond 4X4</b>	<b>SE Nav</b>	<b>Price (£) exc. VAT</b>	<b>Total (£) inc. VAT</b>
Twin sunvisors incorporating front passenger's vanity mirror with cover	●	●	●	●			
Twin sunvisors incorporating illuminated driver's and front passenger's vanity mirrors with covers					●		
Driver's sunglasses holder					●		
Electro-chromatic anti-dazzle rear-view mirror					●		
Morrocana-trimmed side bolsters on front and rear seats	●	●					
Leather seat facings			●	●	●		
Driver's seat with manual reach and height adjustment	●	●					
Driver's seat with electrical reach, rake, height and tilt adjustment			●	●	●		
Front passenger's seat with fold-flat facility					●		
Midnight Black inserts on facia and doors	●	●					
Atari metallic-effect inserts on facia and doors (with Charcoal or Light Titanium leather interior trim)			●	●	●		
Macchiatto Burl wood-effect inserts on facia and doors (with Saddle Brown leather interior trim)					●		
Rubber-backed velour carpet mats (retailer-fit)	○	○	○	○	○	80.00	96.00

● = Standard equipment. ○ = Optional at extra cost.

<sup>1</sup> = Information shown in the following order: instantaneous fuel consumption, average fuel consumption, amount of fuel used, average speed, distance travelled, range remaining, stop watch.

# ANTARA FEATURES/OPTIONS

## MECHANICAL FEATURES

Features	Exclusiv FWD	Exclusiv 4X4	Diamond FWD	Diamond 4X4	SE Nav	Price (£) exc. VAT	Total (£) inc. VAT
Front-wheel drive	●		●				
Intelligent four-wheel drive		●		●	●		
Sports-tuned suspension	●	●	●	●	●		
Automatic self-levelling rear suspension	●	●	●	●	●		
Diesel particulate filter	●	●	●	●	●		
Six-speed manual gearbox	●	●	●	●	●		
Six-speed automatic transmission		▲		▲	▲		

## EXTERIOR FEATURES

**Standard features** • Dark-tinted rear windows • Tinted glass (windscreen and front door windows) • Heated rear window with automatic timed cut-off • Rear window wash/wipe • Electrically operated front and rear windows with driver's safety autoreverse and one-touch facility • Body-colour door mirrors • Electrically adjustable/heated door mirrors (wide-angle on driver's side) with automatic timed cut-off • Chrome-effect window trim • Silver-effect roof rails • Two-tone horn • Front fog lights • Lights-on audible warning • Twin gas-assisted tailgate struts

Additional features	Exclusiv FWD	Exclusiv 4X4	Diamond FWD	Diamond 4X4	SE Nav	Price (£) exc. VAT	Total (£) inc. VAT
Body-colour door handles	●	●	●	●			
Chrome-effect door handles					●		
Front and rear protective skid plates	●	●	●	●			
Front and rear alloy-effect protective skid plates					●		
Electrically foldable door mirrors					●		
Heat-reflective windscreen					●		
Rain-sensitive windscreen wipers					●		
Automatic lighting control					●		
Stainless steel exhaust tailpipe					●		
Dual Ellipsoidal headlights	●	●	●	●			
Xenon headlights with dynamic beam levelling and high-pressure headlight washers					●		
Front and rear parking distance sensors		●		●	●		
Detachable tow bar with 12N electrics (retailer-fit) <sup>2</sup>	○	○	○	○	○	666.67	<b>800.00</b>
Detachable tow bar with 12N/12S electrics (retailer-fit) <sup>2</sup>	○	○	○	○	○	729.17	<b>875.00</b>
Detachable tow bar with 13-pin electrics (retailer-fit) <sup>2</sup>	○	○	○	○	○	583.34	<b>700.00</b>
Two-coat metallic paint	○	○	○	○	○	454.17	<b>545.00</b>
Tri-coat premium paint			○	○	○	845.83	<b>1015.00</b>

● = Standard equipment. ○ = Optional at extra cost. ▲ = See price pages for details.

<sup>2</sup> = Please note: All Antara models feature tow bar provision with trailer stability programme and Electronic Stability Programme (ESP) as standard.



# ANTARA FEATURES/OPTIONS

## AUDIO, COMMUNICATIONS AND NAVIGATION

Features	Exclusiv FWD	Exclusiv 4X4	Diamond FWD	Diamond 4X4	SE Nav	Price (£) exc. VAT	Total (£) inc. VAT
<b>CD/MP3 CD player/stereo radio (CD 40)</b> • Mobile phone system with Bluetooth® • CD/MP3 CD player • USB connection with iPod control • Aux-in socket • AM/FM stereo radio with 24 station presets • RDS with Traffic Programme • Remote display • 20 watts per channel output • 7 speakers	●	●	●	●			
<b>Touch and Connect multi-media unit</b> • 3D navigation system with 5-inch colour touch-screen • 28 country European mapping • Mobile phone system with Bluetooth® • CD/MP3 CD player • USB connection with iPod control • Aux-in socket • AM/FM stereo radio • RDS • 20 watts per channel output • 7 speakers	○	○	○	○	●	625.00	<b>750.00</b>
Steering wheel mounted audio controls	●	●	●	●	●		

● = Standard equipment. ○ = Optional at extra cost.

### SATELLITE NAVIGATION

The satellite navigation system uses the international network of GPS (Global Positioning System) satellites, linked to a comprehensive 3D mapping system on the 5-inch colour LCD touch-screen, to determine your precise location and guide you to your chosen destination virtually anywhere in mainland Britain. In areas where radio stations operate the Traffic Messaging Channel (TMC) service you can take advantage of dynamic route guidance. This monitors incidents and delays along your chosen route and suggests an alternative route to avoid them, taking into account any previous conditions you have set such as avoiding motorways, toll roads etc. The system also offers major route navigation across a further 28 European countries via the supplied SD card. The bright display makes it easy to follow your progress on screen, and the directional arrows are backed up by spoken instructions that guide you to your destination turn-by-turn. A travel guide is a particularly useful feature that has details of restaurants, hotels, parking and other points of interest. Simply select the location you're interested in and let the navigation system guide you there.

### MOBILE PHONE SYSTEM WITH BLUETOOTH®

The Touch and Connect unit includes built-in Bluetooth® v2.0, allowing transfer of phonebook contents, call history and caller ID. Simply tap the touch-screen to accept an incoming call and hear your caller through the stereo speakers. To make an outgoing call, choose a name from the phonebook via the touch-screen display, then carry on your conversation hands-free. The unit features an in-built microphone to pick up your voice. You can even stream music directly from your compatible mobile phone.

### USB CONNECTION



USB connection provides iPod/iPhone control and read-out of iPod/iPhone functions through the audio system display. Traditional aux-in sockets only allow control of volume through the car's audio system. The USB connection also means that the mobile device will charge whilst it is connected. On the Touch and Connect unit the functionality can be accessed through the touch-screen display.

### AUX-IN SOCKET

The aux-in socket allows you to connect your portable MP3 music player directly into the car's audio system. All you need is your music player and a suitable connecting lead and you can listen to all your favourite tunes through your car's speaker system. Using your MP3 music player in the car couldn't be easier – use it to select the music, as you would normally do, while controlling the volume via the car's regular volume controls.



# ANTARA FEATURES/OPTIONS

## WHEELS AND TYRES

	Exclusiv FWD	Exclusiv 4x4	Diamond FWD	Diamond 4x4	SE Nav	Price (£) exc. VAT	Total (£) inc. VAT
<b>Emergency tyre inflation kit (in lieu of spare wheel)</b>	●	●	●	●	●		
 <b>17-inch alloy wheels:</b> 235/65 R 17 tyres	●		●				
 <b>18-inch alloy wheels:</b> 235/55 R 18 tyres		●		●			
 <b>19-inch alloy wheels:</b> 235/50 R 19 tyres					●		

● = Standard equipment.

## TYRE RATING

Tyre size	Fuel efficiency group	Wet grip performance	External noise	
			Measured (dB)	Group
235/65 R 17	C	C	71	
235/55 R 18	E	C	71	
235/50 R 19	C	C	71	

Tyre rating according to EU Regulation 1222/2009

# ANTARA SPECIFICATIONS

## ENGINES

	<b>2.4i 167PS</b>	<b>2.2CDTi 163PS ECOTEC-4 Turbo diesel</b>	<b>2.2CDTi 184PS ECOTEC-4 Turbo diesel</b>
Fuel type	Petrol	Diesel	Diesel
Capacity	2384cc	2231cc	2231cc
Maximum power	167PS (123kW) @ 5600rpm	163PS (120kW) @ 3800rpm	184PS (135kW) @ 3800rpm
Maximum torque	230Nm (170 lb.ft.) @ 4500rpm	350Nm (258 lb.ft.) @ 2000rpm	400Nm (295 lb.ft.) @ 2000rpm
Configuration	4 cylinders, 4 valves per cylinder, double overhead camshafts	4 cylinders, 4 valves per cylinder, single overhead camshaft	4 cylinders, 4 valves per cylinder, single overhead camshaft
Fuel/induction system	Naturally aspirated. Electronic fuel injection	Variable geometry turbocharger with intercooler. Common rail fuel injection	Variable geometry turbocharger with intercooler. Common rail fuel injection
Emission compliance	Euro 5	Euro 5 with Diesel Particulate Filter	Euro 5 with Diesel Particulate Filter
Service interval	20,000 miles or 1 year (whichever occurs sooner)	20,000 miles or 1 year (whichever occurs sooner)	20,000 miles or 1 year (whichever occurs sooner)

# ANTARA SPECIFICATIONS

## PERFORMANCE, FUEL ECONOMY AND EMISSIONS

	Wheel size (inches)	Performance (manufacturer's figures)		Fuel economy mpg (litres/100km)#			CO <sub>2</sub> emissions g/km#	Vehicle Excise Duty*		Benefit in kind company car taxation rates - 2014/15 tax year
		Maximum speed (mph)	Acceleration 0-62mph (sec)	Urban driving	Extra-urban driving	Combined figure		First year rate	Standard rate	
<b>FWD models</b>										
2.4i	17	118	10.5	23.5 (12.0)	40.4 (7.0)	32.1 (8.8)	206	£635	£285	34%
2.2CDTi 163PS Start/Stop	17/18/19	117	9.9	36.2 (7.8)	52.3 (5.4)	44.1 (6.4)	167	£290	£205	29%
<b>4X4 models</b>										
2.2CDTi 163PS Start/Stop	17/18/19	117	9.9	34.4 (8.2)	48.7 (5.8)	42.2 (6.7)	177	£345	£225	31%
2.2CDTi 163PS automatic	17/18/19	113	12.0	25.2 (11.2)	39.8 (7.1)	33.2 (8.5)	225	£635	£285	35%
2.2CDTi 184PS Start/Stop	19	124	9.6	34.4 (8.2)	48.7 (5.8)	42.2 (6.7)	177	£345	£225	31%
2.2CDTi 184PS automatic	19	119	10.1	25.2 (11.2)	39.8 (7.1)	33.2 (8.5)	225	£635	£285	35%

\* = Correct at time of publication.

# = Official Government Test Environmental Data. Official EU-regulated test data is provided for comparison purposes and actual performance will depend on driving style, road conditions and other non-technical factors.

### START/STOP TECHNOLOGY

Start/Stop system offers real benefits by improving fuel economy and reducing CO<sub>2</sub> emissions, particularly in town. It does this by automatically stopping the engine when you come to a standstill, and then restarting as you prepare to move off.

Before automatically stopping the engine a number of system checks are carried out to ensure that it is both safe and practical to do so. To ensure safety, the driver must depress the clutch pedal, shift in to neutral, and then release the clutch pedal.

System checks carried out before Auto Stop activates include:

- Start/Stop system is not manually deactivated via the facia button
- Sufficient brake vacuum is available to prevent the car rolling down an incline
- Battery is in good condition and charged
- Outside air temperature and engine temperature are above specified minima

- Electronic climate control (where fitted) is not in maximum heating or maximum cooling mode
- Self-cleaning function of the diesel particulate filter is not active

If all of these conditions are satisfied then the vehicle will Auto Stop.

When you are ready to pull away from standstill, Auto Restart is activated by depressing the clutch pedal.

Whilst at a standstill the vehicle is continually monitored. If necessary, the engine will automatically be restarted. Conditions that would initiate an Auto Restart include:

- Low battery level
- Brake vacuum below specified minimum
- Start/Stop system is manually deactivated
- Stationary for 5.5 minutes

# ANTARA SPECIFICATIONS

## TRANSMISSIONS

### Six-speed manual gearbox:

Standard on all models

### Six-speed automatic transmission with Active Select function:

Available at extra cost on diesel models. Electronically controlled with adaptive driving function and fuel-saving eco mode. Fluid drive with torque converter, lock-up clutch and Active Select.

## STEERING

- Speed-sensitive power-assisted steering
- Turning circle (kerb-to-kerb): 11.87m (38.9ft.)

## SUSPENSION

**Front:** Independent. Lightweight MacPherson struts with gas-pressure dampers and coil springs. Anti-roll bar.

**Rear:** Independent. Multi-link with coil springs and gas-pressure dampers.

An automatic self-levelling rear suspension system is integrated within the dampers, requiring no external power source.

## BRAKES

- Anti-lock Braking System (ABS)
- Dual circuit, diagonally split braking system

### All models

Front ventilated discs: 296mm diameter

Rear ventilated discs: 303mm diameter

## BODY

- Aerodynamic drag co-efficient: Cd 0.38

## FUEL TANK CAPACITY

- 65 litres (14.3 gallons).

## WEIGHTS AND TOWING DATA kg

	Gross vehicle weight	Max. towing weights Trailer with brakes (without brakes)
FWD petrol models	2183	1500 (750)
FWD diesel models	2270	2000 (750)
Manual 4X4 models	2345	2000 (750)
Automatic 4X4 models	2370	1700 (750)

**Gross vehicle weight** is the total permissible weight of the vehicle including passengers and their luggage. The **maximum roof rack loading** should not exceed 100kg. The **maximum towing weights** are based on the ability of the car, with two occupants of 75kg each, to restart on a 12% gradient, which is approximately 1 in 8.3, at sea level. At altitudes above 1500 metres, the engine output may drop with a corresponding reduction in towing capability. Any extra weight, such as luggage or additional passengers, should be deducted from the maximum towing weight. With a trailer fully loaded, **maximum noseweight** should not exceed 80kg. Always fit Vauxhall towing attachments and accessories available from your Vauxhall retailer. They are designed specifically for Vauxhall models and carry a 12-month guarantee.

# ANTARA SPECIFICATIONS

## EXTERIOR DIMENSIONS millimetres (inches)

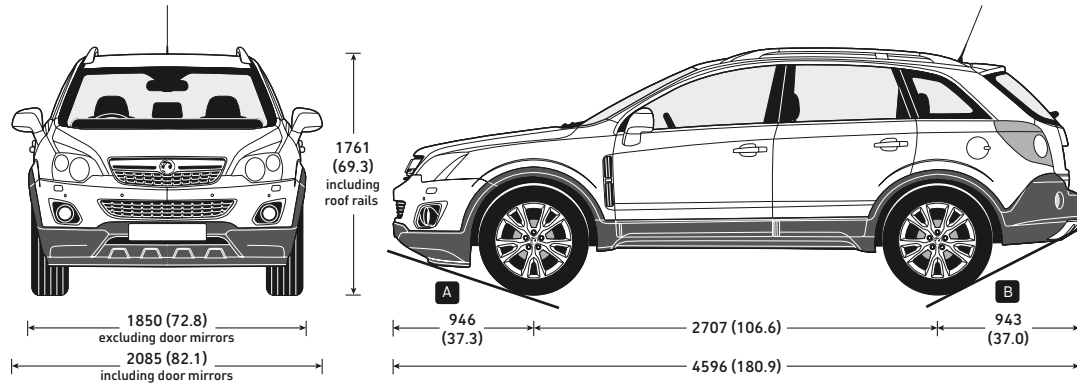

## OFF-ROAD CAPABILITIES

Max. ground clearance  
176mm (6.9 inches)

Max. wading depth  
450mm (17.7 inches)

Max. approach angle **A**  
20°

Max. departure angle **B**  
24°

Max. ramp angle  
18°

## LOADSPACE DIMENSIONS millimetres (inches)

Dimension	Value (mm)	Value (in)
Maximum length (behind rear seats)	928	36.5
Maximum length (rear seats folded)	1740	68.5
Maximum width	1320	52.0
Width between wheel arches	968	38.1
Loading height	796	31.3

## LUGGAGE CAPACITIES\*

Configuration	Value (litres)	Value (cu.ft.)
Rear seats up (under luggage compartment cover)	420	14.8
Rear seats folded (to upper edge of front seat back)	865	30.5
Rear seats folded (to roof)	1420	50.1

\* = Measured using the ECIE method.

# ANTARA ACCESSORIES

	Total (inc. VAT)
<b>INFOTAINMENT</b>	
<b>iPod connection kit</b>	
Connects2 i-Connect FM – FM modular	£129.00
<b>Bury Bluetooth® phone kits</b>	
Classic – Fully integrated, phone charging function, illuminated controls	£129.00
CC9060 – Fully integrated, detachable colour screen, voice recognition	£149.00
<b>Garmin Portable Sat Navs (includes case)</b>	
Nüvi 42 (UK/Ireland) – 4.3-inch screen	£79.00
Nüvi 55 (UK/Ireland) – 5-inch screen, Bluetooth, eco route, lifetime traffic alerts	£89.00
Nüvi 55 (Western Europe) – 5-inch screen, Bluetooth, eco route	£99.00
<b>Digital radio</b>	
Fully integrated digital radio	£195.00
<b>Multimedia</b>	
Parrot Asteroid Mini	£399.00
Parrot Asteroid Tablet	£499.00
<b>TomTom semi-integrated sat nav</b>	
TomTom Start 25	£249.00
TomTom Via Business	£279.00
TomTom GO Business	£349.00
TomTom GO 5000	£379.00
<b>Sat Nav updates<sup>1</sup></b>	
Please consult your retailer for latest map updates or visit <a href="http://www.vauxhall.co.uk/accessories">www.vauxhall.co.uk/accessories</a> .	

1 = For use with optional factory-fit satellite navigation systems.

	Total (inc. VAT)
<b>CHILD SEATS<sup>2</sup></b>	
BABY-SAFE <sup>3</sup> – 0-13kg/birth to 15 months	£119.00
– ISOFIX base	£208.00
DUO ISOFIX <sup>3</sup> – 9-18kg/9 months to 4 years	
with top tether kit	£317.00
KID <sup>3</sup> – 15-36kg or 4 to 12 years	£144.00
2 = Restrictions apply to the use of child seats, please consult your Vauxhall retailer.	
3 = Without transponder.	
<b>SAFETY</b>	
Privacy shades – rear window	£100.00
Privacy shades – rear side windows	£86.00
<b>Parking sensors</b>	
– four fully flush front bumper mounted sensors	
– unpainted	£320.00
– painted	£350.00
– four fully flush rear bumper mounted sensors	
– unpainted	£300.00
– painted	£330.00
Safety Pack – first aid kit, warning triangle, hi-visibility vest, Vauxhall bag	
First aid kit	£13.00
Warning triangle	£16.00
Fire extinguisher – 2kg	£34.00
Hi-visibility vest	£8.00
Temporary tyre inflation kit	£126.00
Tyre sealant	£48.00

	Total (inc. VAT)
<b>PRACTICAL</b>	
Spare bulb kit <sup>4</sup>	£17.00
Jump leads	
– petrol engines (16mm standard)	£42.00
Fuel can – 10 litre	£24.00
Stretch tow rope – 2 tonne	£31.00
4 = Excludes xenon headlight bulb for models with Adaptive Forward Lighting (AFL).	
<b>PROTECTION</b>	
All weather rubber mats – set of four	£87.00
Premium carpet mats – set of four	£108.00
Anti-slip cargo liner mat	£98.00
Cargo liner	£65.00
Vertical security net	£239.00
Mudflaps – set of four	£100.00

	Total (inc. VAT)
<b>TOURING</b>	
T-track base carrier	£125.00
Thule bicycle carrier <sup>5</sup>	from £70.00
Thule ski carrier <sup>5</sup>	from £105.00
Thule surfboard carrier <sup>5</sup>	from £79.00
Thule roof boxes	
– Ocean 80 hard roof box (340 litres) <sup>5</sup>	£215.00
– Pacific 200 hard roof box (460 litres) <sup>5</sup>	from £320.00
– Ranger 90 soft roof box (340 litres) <sup>5</sup>	£260.00
More available, please consult your retailer for details.	
<b>Tow bar carrier system</b>	
Thule tow bar Euroride 940	
two-bicycle carrier	£226.00
Thule tow bar Euroway	
two-bicycle carrier	£345.00
Thule tow bar Euroway	
three-bicycle carrier	£430.00
Thule tow bar extension for fourth bicycle	£109.00
Detachable tow bar	
– 12N electrics	£840.00

5 = Must be used in conjunction with a base carrier.

	Total (inc. VAT)
<b>ALLOY WHEELS (set of four with centre caps)<sup>6</sup></b>	
17-inch 5-twin-spoke	£783.00

6 = Different tyres and locking wheel bolts/nuts may be required at extra cost. Price excludes new tyres and locking wheel bolts/nuts, includes static wheel balancing.

**Please note:**

Prices shown are a fully fitted and painted, where applicable and include VAT. Please check with your local Vauxhall retailer for details. It is advisable to ensure your insurance policy is adequate to cover additional fitted accessories. Prices correct at time of publication.

# ANTARA ADDITIONAL INFORMATION

## ON-THE-ROAD PRICES

To eliminate uncertainty about hidden costs when buying a new car, Vauxhall publishes on-the-road recommended retail prices (RRP) and these are shown in the pricing tables within this price guide. These prices include the recommended cost of number plates and delivery to a Vauxhall retailer of £700.00 (including £116.67 VAT), 12 months' Government Vehicle Excise Duty (see opposite for details) and the DVLA new vehicle first registration fee of £55.00\*.

Please note: The on-the-road recommended retail price (RRP) does not include fuel supplied by the retailer, motor insurance or any other goods or services supplied by agreement between the retailer and the customer.

## PRICE PROTECTION

Order a new Vauxhall for build in the current model year (as confirmed by your retailer) for delivery no more than three months in advance and the price you are quoted is the price you pay. This is irrespective of any subsequent price rises between placing your order and delivery of your new car, but you must take delivery as soon as the car is available. General Motors UK Limited is not liable for price adjustments caused by Government changes in the rate of VAT (currently 20%), Vehicle Excise Duty, DVLA new vehicle first registration fee or by any other applicable legislation or regulations.

## VEHICLE EXCISE DUTY

The amount of Vehicle Excise Duty (road fund licence) payable on new cars varies depending on the level of carbon dioxide (CO<sub>2</sub>) emissions produced by the vehicle. CO<sub>2</sub> emissions are measured in grammes (g) per kilometre (km) travelled and divided into 13 charging bands shown in the table below.

From 1 April 2010 the Government introduced a new 'first year rate' of Vehicle Excise Duty payable on all new cars. In subsequent years the amount of Vehicle Excise Duty payable will revert to the standard rate.

### Vehicle Excise Duty\*

	CO <sub>2</sub> emissions (g/km)	First year rate	Standard rate
<b>Band A</b>	up to 100	£0.00	£0.00
<b>Band B</b>	101-110	£0.00	£20.00
<b>Band C</b>	111-120	£0.00	£30.00
<b>Band D</b>	121-130	£0.00	£110.00
<b>Band E</b>	131-140	£130.00	£130.00
<b>Band F</b>	141-150	£145.00	£145.00
<b>Band G</b>	151-165	£180.00	£180.00
<b>Band H</b>	166-175	£290.00	£205.00
<b>Band I</b>	176-185	£345.00	£225.00
<b>Band J</b>	186-200	£485.00	£265.00
<b>Band K</b>	201-225	£635.00	£285.00
<b>Band L</b>	226-255	£860.00	£485.00
<b>Band M</b>	over 255	£1090.00	£500.00

\* = Correct at time of issue.

## E10 FUEL

E10 fuel is cleared for use in all petrol-engined Vauxhall vehicles excluding models with the 2.2 litre direct injection petrol engine (code Z22YH) used in Vectra, Signum and Zafira models. Owners of these vehicles should continue to use regular unleaded or premium unleaded petrol.

## PROTECTING THE ENVIRONMENT

Vauxhall's commitment to the environment is demonstrated by our products' many environmental awards. For even more information on Vauxhall's efforts to achieve an environmentally sustainable future, see [www.vauxhall.co.uk/recycling](http://www.vauxhall.co.uk/recycling)

## VAUXHALL ASSISTANCE

Vauxhall Assistance is provided automatically with every new Vauxhall for 12 months from first registration and covers everything from accident assistance, roadside recovery and 'at home' service to flat tyres. With Vauxhall Assistance help is literally just a free\*\* phone call away, 24 hours a day, 365 days a year!

\*\* = Mobile phone users will be charged at their standard tariff.

## VAUXHALL LEASING

As Vauxhall's own contract hire and fleet management operation, Vauxhall Leasing provides a one-stop-shop for competitive car and van leasing solutions – for business users and private individuals. Working with the Vauxhall retailer network, we combine the support of a national contract with the convenience of a local contact.

For further information, please see your local Vauxhall retailer or call us on **0870 737 2557**. Alternatively, you can visit our website at [www.vauxhall-leasing.co.uk](http://www.vauxhall-leasing.co.uk)

## IN THE EVENT OF AN ACCIDENT...

Vauxhall Accident Support helps keep you mobile following an accident. Benefits include scene-of-accident advice, message service, assistance with claims and vehicle recovery. For further details call **0800 010 304**.

Alternatively, details can be found on our website at [www.vauxhall.co.uk](http://www.vauxhall.co.uk)

## VAUXHALL SERVICE PLAN

Vauxhall retailers offer a great service for owners of all Vauxhall cars. Value for money, regular offers and free check-ups, combined with the peace of mind that comes from using Vauxhall-trained technicians and genuine parts, help keep your car in peak condition at all times.

## FOR MORE PRODUCT INFORMATION

For a brochure on any Vauxhall model (up to a maximum of three per caller) or location of your nearest Vauxhall retailer please call **0845 600 1500**. Alternatively, details can be found on our website at [www.vauxhall.co.uk](http://www.vauxhall.co.uk)

## VAUXHALL INSURANCE WITH ADDED REASSURANCE

### Comprehensive cover – Summary of benefits\*

- Competitive premiums
- Repairs by a Vauxhall-trained technician
- Genuine Vauxhall parts, guaranteed for three years when we repair your car within our Approved Repairer Network
- Free courtesy car as standard when using an Approved Repairer\*\*
- 24 hour claims helpline
- Personal Accident benefit
- Cover for audio equipment
- Windscreen cover

Call for a quote on **0844 463 2670†**

\*The benefits listed above are for comprehensive cover only. For details of Third Party, Fire and Theft cover, please call our sales team.  
\*\*Should your car need repairing following an accident we provide a courtesy car (subject to availability) for the duration of the repair. Only genuine Vauxhall parts are used. Terms and conditions apply.  
† Calls may be recorded. Vauxhall Motor Insurance is underwritten by Ageas Insurance Limited.

Every effort has been made to ensure that the contents of this document were accurate and up-to-date at the time of publication – 16 December 2014 (Amended 11 February 2015). The invoice price, including delivery to retailer, factory-fitted options, accessories fitted by the retailer and number plates, is subject to VAT. The right is reserved to alter specifications and prices, and withdraw products from sale, without notice. Please note that Vauxhall retailers are not the agents of General Motors UK Limited t/a Vauxhall and are not authorised to bind General Motors UK Limited by any specific or implied undertaking or representation. It is advisable to ensure that your motor insurance policy provides adequate cover for additional fitted options and accessories. All rights reserved. No part of this publication may be reproduced in any form or by any means, without the prior written permission of General Motors UK Limited.

Base information prepared by Graymatter. General Motors UK Limited, Luton LU1 3YT [www.vauxhall.co.uk](http://www.vauxhall.co.uk)

©2014 General Motors UK Limited



**VAUXHALL**