

ANTARA PRICE/SPECIFICATION GUIDE

9 November 2012



Flexible Finance
0% APR
Representative*

Proud Sponsor of Home Nations Football



Customer offers effective
2 October 2012 to 17 December 2012
(subject to exclusions and conditions)

* = Finance subject to status. Terms and conditions apply.
Applicants must be 18 or over. Guarantee/indemnity may be
required. Finance supplied by either Vauxhall Motor Finance
RH1 1SR or Vauxhall Finance, PO Box 6666, Cardiff CF15 7YT.

ANTARA CUSTOMER OFFERS

At Vauxhall we know that customers demand choice. Not only do we have an extensive range of models to choose from, you can also take advantage of our unique Flexible Finance programme. It offers an unbeatable finance rate with no minimum deposit, and a payment term to suit you of anywhere between 24 months and 60 months. For even more great deals contact your local retailer or call 0845 600 1500 or visit www.offers.vauxhall.co.uk



TERMS AND CONDITIONS

All offers described are available on vehicles ordered or registered between 2 October 2012 and 17 December 2012 inclusive. Offer prices quoted are correct at the time of publication (November 2012). Prices are subject to change. In line with Vauxhall's policy of price transparency, the offer price shown is an on-the-road price including 20% VAT, number plates and delivery to retailer of £700.00 (inc. £116.67 VAT), 12 months' Government Vehicle Excise Duty (variable depending upon model) and the DVLA's new vehicle first registration fee of £55.00. Excludes fuel and insurance. Offers may not apply to retailer stocks and are subject to availability. Restrictions may apply. Contact your retailer for details.

FINANCE OFFER

Not available in conjunction with any other Finance offers. Offer available for orders and registrations between 2 October 2012 and 17 December 2012. **Eligibility:** Offer only applies to private individuals, Vauxhall Partners and small businesses 1-24 vehicles (purchase only excluding B2B). All other customers are excluded. **Availability:** Available on selected retailer stocks at participating retailers only and may not be available on all retailer stocks. **Finance Provider:** Finance subject to status. Terms and conditions apply. Applicants must be 18 or over. Guarantee/indemnity may be required. Finance supplied by either Vauxhall Motor Finance RH1 1SR or Vauxhall Finance, PO Box 6666, Cardiff CF15 7YT.

Flexible Finance

Representative example

Exclusiv 2.2CDTi 16v FWD
on conditional sale

| | |
|---------------------------|------------|
| 54 monthly payments of | £259.00 |
| On-the-road cash price | £20,660.00 |
| Customer deposit | £5924.00 |
| Finance Deposit Allowance | £750.00 |
| Amount of credit | £13,986.00 |
| Fixed rate of interest | 0% p.a. |
| Duration of agreement | 54 months |
| Total amount payable | £20,660.00 |
| APR Representative | 0% APR |

Want to own your car but need help spreading the payments? Then our Flexible Finance offer is the option for you.

ANTARA COMPANY CAR DRIVER/FLEET INFORMATION

COMPANY CAR DRIVER FREE* 3 DAY TEST DRIVE



Our free* 3 Day Test Drive programme is open to all Company Car Drivers which allows you to choose any model in the current Vauxhall line-up (excluding all VXR models and Commercial Vehicles), with full insurance cover provided, to give you a meaningful length of time to make an informed decision about your next company car.

Click below to book your free* test drive
www.vauxhall3dtd.co.uk
or call 0870 240 4848**

*The free 3 Day Test Drive programme is open to Company Car Drivers and excludes fuel and lubricants; congestion charges; parking and speeding fines and the £250 insurance excess (if applicable). It features a wide selection of models from the Vauxhall range (excluding all VXR models and Commercial Vehicles and subject to availability). Drivers must be aged 25 years or over, have held a full driving licence for at least a year and hold a major credit card. You will need to have your driving licence (and proof of identity (i.e. passport) where the driving licence is not a photocard licence) when your car is delivered. While every effort will be made to ensure that at least 3 days are provided for the test drive, this cannot always be guaranteed due to delivery and collection dates and timings. Available for UK Mainland only. Terms and conditions apply. **Telephone lines open Monday-Friday 9.00am to 5.00pm excluding Bank Holidays. Calls may be recorded or monitored for quality and/or training purposes.

FLEET TOOLBOX



Discover the facts in our online Toolbox for both Company Car Drivers and Fleet Decision Makers. The Fleet Toolbox has a host of useful calculators, comparators, interactive listings and information. Visit the Fleet Toolbox by going to www.vauxhall-toolbox.co.uk

ROADTRIP APP



The Vauxhall RoadTrip App is a free app that calculates and logs your mileage expenses for any UK business trips and generates reports to help you complete your mileage claims. Available for both iPhone and Android, visit www.vauxhall-toolbox.co.uk or visit the iPhone or Android stores and search for Vauxhall RoadTrip to download it to your smartphone or tablet.

BENEFIT IN KIND COMPANY CAR TAXATION†

The car benefit charge will be the car's list price (including VAT, options and accessories fitted, delivery to retailer and number plates, but excluding Vehicle Excise Duty and new vehicle first registration fee) multiplied by the percentage charge for the CO₂ emissions band in which the car falls (see table opposite). Multiply this figure by your personal income tax rate (20% for Basic Rate, 40% for Higher Rate for 2012-13 tax year) to calculate your annual benefit in kind tax liability.

Example:

Antara Exclusiv FWD 2.2CDTi 16v manual (CO₂ emissions 160g/km)

On-the-road RRP £20660.00

Deduct: Vehicle Excise Duty (£170.00)

New vehicle first registration fee (£55.00)

Effective list price £20435.00

Add: Optional two-coat metallic paint £525.00

List price for tax purposes (P11D value) £20960.00

Car benefit charge
2012-13 tax year (26%) £5449.00

Benefit in kind tax liability
(2012-13 tax year)

Basic Rate (20%) tax payer £1089.00

Higher Rate (40%) tax payer £2179.00

† = Please note this Price Guide provides taxation information as a guide only. Vauxhall does not provide taxation guidance. Drivers should always take professional advice on their own tax position.

| CO ₂ emissions in grams per kilometre | Percentage of car's price to be taxed | |
|--|---------------------------------------|-------------------------|
| | Petrol 2012-13 tax year | Diesel 2012-13 tax year |
| up to 75 | 5 | 8 |
| 76-99 | 10 | 13 |
| 100-104 | 11 | 14 |
| 105-109 | 12 | 15 |
| 110-114 | 13 | 16 |
| 115-119 | 14 | 17 |
| 120-124 | 15 | 18 |
| 125-129 | 16 | 19 |
| 130-134 | 17 | 20 |
| 135-139 | 18 | 21 |
| 140-144 | 19 | 22 |
| 145-149 | 20 | 23 |
| 150-154 | 21 | 24 |
| 155-159 | 22 | 25 |
| 160-164 | 23 | 26 |
| 165-169 | 24 | 27 |
| 170-174 | 25 | 28 |
| 175-179 | 26 | 29 |
| 180-184 | 27 | 30 |
| 185-189 | 28 | 31 |
| 190-194 | 29 | 32 |
| 195-199 | 30 | 33 |
| 200-204 | 31 | 34 |
| 205-209 | 32 | 35 |
| 210-214 | 33 | 35 |
| 215-219 | 34 | 35 |
| 220 and above | 35 | 35 |

To calculate your own personal liability a car tax calculator is available at www.vauxhall.co.uk/bik

CONTACT VAUXHALL FLEET

Please contact one of our dedicated sales teams who will be happy to help with your particular enquiry.

Company Car Drivers

Call: 0845 111 2020

Email: company-car@vauxhallinfo.co.uk

Telephone lines are open – Monday to Friday 08.00am-midnight/Saturday 09.00am-midnight/Sunday 10.00am-midnight

Fleet Decision Makers

Depending on the size of your fleet of vehicles, we have a dedicated team to handle your enquiries. The lines are open Monday to Friday excluding Bank Holidays.

1-24 vehicles

Call: 0845 076 2254 (08.30am-5.00pm)

Email: b2bsales@vauxhall.co.uk

25+ vehicles

Call: 0870 010 0651 (08.00am-5.30pm)

Email: vauxhallfleet@vauxhall.co.uk

Special Vehicles (Police, Fire and Ambulance)

Call: 01525 408 320 (08.30am-5.00pm)

Email: vauxhallspecialvehicles@vauxhall.co.uk

ANTARA RANGE HIGHLIGHTS

EXCLUSIV **£19,515-£24,345**

- Switchable Electronic Stability Programme (ESP)
- Anti-lock Braking System (ABS)
- Descent control system
- Driver's and front passenger's airbags
- Front seat side-impact airbags
- Front and outer rear seat full-size curtain airbags
- Air conditioning
- Heated front seats
- Driver's seat with manual reach, rake, height and lumbar adjustment
- Morrocana-trimmed side bolsters on seats
- Electric parking brake
- Engine deadlock immobiliser
- Remote control ultrasonic security alarm system
- Remote control two-stage central deadlocking
- Door-to-door illumination
- Steering column adjustable for reach and rake
- Three-spoke leather-covered steering wheel
- Leather-covered gear knob (manual models only)
- Rear seat centre armrest
- Front fog lights
- Automatic self-levelling rear suspension
- Silver-effect roof rails
- Electrically adjustable/heated door mirrors
- CD/MP3 CD player/stereo radio
- Aux-in socket
- Steering wheel mounted audio controls
- 17-inch alloy wheels with 235/65 R 17 low profile tyres
- Emergency tyre inflation kit in lieu of spare wheel
- Dark-tinted glass (excludes windscreen and front door windows)

Exclusiv 4X4 models also feature:

- Intelligent four-wheel drive
- Multi-function trip computer
- Cruise control
- Traction control
- Parking distance sensors front and rear
- 18-inch alloy wheels with 235/55 R 18 ultra-low profile tyres

DIAMOND **£21,610-£25,295**

Features over Exclusiv/Exclusiv 4X4

- Leather seat facings
- Driver's seat with electrical reach, rake, height and tilt adjustment, manual lumbar adjustment

SE NAV **£26,255-£28,530**

Features over Diamond 4X4

- Touch and Connect multi-media unit with satellite navigation, colour touch-screen, Bluetooth® connectivity and USB connection with iPod control
- 19-inch alloy wheels with 235/50 R 19 ultra-low profile tyres
- Electronic Climate Control (ECC)
- Xenon headlights with dynamic beam levelling and high-pressure headlight washers
- Daytime running lights (uses standard headlight dipped beam)
- Electro-chromatic anti-dazzle rear-view mirror
- Electrically foldable door mirrors
- Front passenger's seat with fold-flat facility
- Tyre pressure monitoring system
- Automatic lighting control
- Rain-sensitive windscreen wipers
- Heat-reflective windscreen
- Twin illuminated vanity mirrors
- Front and rear alloy-effect protective skid plates
- Alloy-effect door sill covers

ANTARA PRICES

| Model 5-door SUV | Price (£) | VAT (£) | Total (£) | On-the-road RRP (£) | CO ₂ (g/km) |
|------------------------------------|--------------|------------|--------------|------------------------|---------------------------|
| EXCLUSIV | | | | | |
| 2.4i 16v (167PS) | 15133.33 | 3026.67 | 18160.00 | 19515.00 | 206 |
| <i>Diesel</i> | | | | | |
| 2.2CDTi 16v (163PS) Start/Stop | 16445.83 | 3289.17 | 19735.00 | 20660.00 | 160 |
| 2.2CDTi 16v (163PS) 4X4 Start/Stop | 18416.67 | 3683.33 | 22100.00 | 23130.00 | 170 |
| 2.2CDTi 16v (163PS) 4X4 auto | 19158.33 | 3831.67 | 22990.00 | 24345.00 | 208 |
| DIAMOND | | | | | |
| <i>Diesel</i> | | | | | |
| 2.2CDTi 16v (163PS) Start/Stop | 17237.50 | 3447.50 | 20685.00 | 21610.00 | 160 |
| 2.2CDTi 16v (163PS) 4X4 Start/Stop | 19208.33 | 3841.67 | 23050.00 | 24080.00 | 170 |
| 2.2CDTi 16v (163PS) 4X4 auto | 19950.00 | 3990.00 | 23940.00 | 25295.00 | 208 |
| SE NAV | | | | | |
| <i>Diesel</i> | | | | | |
| 2.2CDTi 16v (163PS) 4X4 Start/Stop | 21020.83 | 4204.17 | 25225.00 | 26255.00 | 170 |
| 2.2CDTi 16v (163PS) 4X4 auto | 21770.83 | 4354.17 | 26125.00 | 27480.00 | 208 |
| 2.2CDTi 16v (184PS) 4X4 Start/Stop | 21904.17 | 4380.83 | 26285.00 | 27315.00 | 170 |
| 2.2CDTi 16v (184PS) 4X4 auto | 22645.83 | 4529.17 | 27175.00 | 28530.00 | 208 |

Please note: On-the-road recommended retail prices (RRP) include number plates and delivery to retailer of £700.00 (inc. £116.67 VAT), 12 months' Vehicle Excise Duty and new vehicle first registration fee of £55.00. Excludes fuel and insurance.

ANTARA FEATURES/OPTIONS

SAFETY

Standard features

- Driver's airbag • Front passenger's airbag • Front seat side-impact airbags • Full-size curtain airbags • Energy-absorbing steering column • Pedal release system – Reduces potential injury to the driver's legs and feet during a severe frontal impact • Laminated windscreen • Side-impact protection beams • Integral protective side door padding • Reinforced passenger safety cell • Deformation zones front and rear
- Burst-proof door locks and anti-jam door design • Child-proof locks on rear doors
- ISOFIX child seat restraint system for outer rear seats (does not include child seat) – Secures ISOFIX child safety seats to the vehicle itself, virtually eliminating the dangers that can result from improper installation
- Deactivation switch for front passenger's airbag
- Switchable Electronic Stability Programme (ESP) • Anti-lock Braking System (ABS) • Electronic Brakeforce Distribution – Distributes the braking force between the wheels most able to use it, allowing stable and efficient braking • Cornering Brake Control • Emergency Brake Assist – Increases applied brake force in emergency braking situations • Descent Control System • Trailer stability programme • Adaptive Brake Lights – If the driver brakes hard enough to activate the ABS the brake lights flash on and off at the rate of four times per second, thus warning following vehicles that heavy braking is in progress • Electric parking brake
- Height-adjustable front and outer rear seat head restraints • Front body-lock lap and diagonal seatbelt pretensioner system – Tightens the lap and diagonal belts during the early stages of a frontal impact • Outer rear body-lock diagonal seatbelt pretensioner system • Front and outer rear seatbelt force limiters – Reduce potential upper body injuries during a frontal impact • Anti-submarining ramps in all seats – Help prevent occupants sliding underneath the lap belt during a collision

Additional features

| | Exclusiv FWD | Exclusiv 4X4 | Diamond FWD | Diamond 4X4 | SE Nav | Price (£) exc. VAT | Total (£) inc. VAT |
|--|-----------------|-----------------|----------------|----------------|-----------|-----------------------|-----------------------|
| Tyre Pressure Monitoring System | | | | | ● | | |
| Safety interlock on models with automatic transmission – Requires the foot brake to be applied before shifting out of Park | | ● | | ● | ● | | |

SECURITY

- Remote control ultrasonic security alarm system • Remote control two-stage central deadlocking (doors, tailgate, fuel filler flap) • Visible Vehicle Identification Number (VIN) plate • Electronic engine deadlock immobiliser • Electronic theft protection for audio equipment • Driver's internal central locking switch • Freewheeling driver's door lock • Door-to-door illumination – Keeps the headlights and rear lights on for 30 seconds after the car doors are locked • Retractable luggage area cover • Folding key • Locking wheel nuts

HEATING AND VENTILATION

- Interior pollen filter • Air recirculation with activation light • Air blend heater with four-speed fan • Rear passenger compartment heating outlets

Additional features

| | Exclusiv FWD | Exclusiv 4X4 | Diamond FWD | Diamond 4X4 | SE Nav | Price (£) exc. VAT | Total (£) inc. VAT |
|----------------------------------|-----------------|-----------------|----------------|----------------|-----------|-----------------------|-----------------------|
| Air conditioning | ● | ● | ● | ● | | | |
| Electronic Climate Control (ECC) | | | | | ● | | |

FACIA, INSTRUMENTS AND CONTROLS

- Multi-function display showing time, date, audio information and outside air temperature (with ice warning function) • Rev counter • Digital clock with automatic RDS time adjustment • Black instruments with chrome edging • Leather-covered three-spoke steering wheel • Leather-covered gear knob (manual models only) • Steering column adjustable for reach and rake • Electronic odometer and trip odometer • Instrument panel light dimmer • Handbrake-on/low brake fluid level and low fuel level warning lights • Service interval monitor • Cigar lighter and front ashtray • Seatbelt unfastened warning light for front seats

Additional features

| | Exclusiv FWD | Exclusiv 4X4 | Diamond FWD | Diamond 4X4 | SE Nav | Price (£) exc. VAT | Total (£) inc. VAT |
|--|-----------------|-----------------|----------------|----------------|-----------|-----------------------|-----------------------|
| Cruise control | | ● | | ● | ● | | |
| Multi-function trip computer with graphic information display ¹ | | ● | | ● | ● | | |

● = Standard equipment.

¹ = Information shown in the following order: instantaneous fuel consumption, average fuel consumption, amount of fuel used, average speed, distance travelled, range remaining, stop watch.

ANTARA FEATURES/OPTIONS

INTERIOR FEATURES

Standard features • Driver's seat with manual lumbar adjustment • Electrically heated front seats with variable temperature settings • Lidded glovebox • Charcoal metallic-effect centre console • 12-volt auxiliary power socket within centre console • Drinks holders in front centre console • Front centre armrest with storage facility • Chrome-effect interior door handles • Colour-keyed fleece velour carpet • Front door pockets • Front passenger's underseat storage tray • Map pockets on front seat backs • Drinks holders in rear passengers' armrest • FlexOrganiser® rails in sides of luggage area • Fully carpeted and illuminated luggage area • Front map reading lights integral with courtesy light • Rear reading lights • Fade up/fade down courtesy lighting operated by door switches • 60/40 split-folding rear seat back • Adjustable rear seat backrest

| Additional features | Exclusiv FWD | Exclusiv 4X4 | Diamond FWD | Diamond 4X4 | SE Nav | Price (£) exc. VAT | Total (£) inc. VAT |
|--|-------------------------|-------------------------|------------------------|------------------------|-------------------|-------------------------------|-------------------------------|
| Twin sunvisors incorporating front passenger's vanity mirror with cover | ● | ● | ● | ● | | | |
| Twin sunvisors incorporating illuminated driver's and front passenger's vanity mirrors with covers | | | | | ● | | |
| Driver's sunglasses holder | | | | | ● | | |
| Electro-chromatic anti-dazzle rear-view mirror | | | | | ● | | |
| Morrocana-trimmed side bolsters on front and rear seats | ● | ● | | | | | |
| Leather seat facings | | | ● | ● | ● | | |
| Driver's seat with manual reach, rake and height adjustment | ● | ● | | | | | |
| Driver's seat with electrical reach, rake, height and tilt adjustment | | | ● | ● | ● | | |
| Front passenger's seat with fold-flat facility | | | | | ● | | |
| Midnight Black inserts on facia and doors | ● | ● | | | | | |
| Atari metallic-effect inserts on facia and doors (with Charcoal or Light Titanium leather interior trim) | | | ● | ● | ● | | |
| Macchiato Burl wood-effect inserts on facia and doors (with Saddle Brown leather interior trim) | | | | | ● | | |
| Rubber-backed velour carpet mats (retailer-fit) | ○ | ○ | ○ | ○ | ○ | 80.00 | 96.00 |

MECHANICAL FEATURES

| Features | Exclusiv FWD | Exclusiv 4X4 | Diamond FWD | Diamond 4X4 | SE Nav | Price (£) exc. VAT | Total (£) inc. VAT |
|--|-------------------------|-------------------------|------------------------|------------------------|-------------------|-------------------------------|-------------------------------|
| Front-wheel drive | ● | | ● | | | | |
| Intelligent four-wheel drive | | ● | | ● | ● | | |
| Sports-tuned suspension | ● | ● | ● | ● | ● | | |
| Automatic self-levelling rear suspension | ● | ● | ● | ● | ● | | |
| Diesel particulate filter | ● | ● | ● | ● | ● | | |
| Six-speed manual gearbox | ● | ● | ● | ● | ● | | |
| Six-speed automatic transmission | | ▲ | | ▲ | ▲ | | |

● = Standard equipment. ○ = Optional at extra cost. ▲ = See price pages for details.

ANTARA FEATURES/OPTIONS

EXTERIOR FEATURES

Standard features • Dark-tinted glass (excludes windscreen and front door windows) • Tinted glass (windscreen and front door windows) • Heated rear window with automatic timed cut-off • Rear window wash/wipe • Electrically operated front and rear windows with driver's safety autoreverse and one-touch facility • Body-colour door mirrors • Electrically adjustable/heated door mirrors (wide-angle on driver's side) with automatic timed cut-off • Chrome-effect window trim • Silver-effect roof rails • Two-tone horn • Front fog lights • Lights-on audible warning • Twin gas-assisted tailgate struts

| Additional features | Exclusiv FWD | Exclusiv 4X4 | Diamond FWD | Diamond 4X4 | SE Nav | Price (£) exc. VAT | Total (£) inc. VAT |
|--|-------------------------|-------------------------|------------------------|------------------------|-------------------|-------------------------------|-------------------------------|
| Body-colour door handles | ● | ● | ● | ● | ● | | |
| Chrome-effect door handles | | | | | ● | | |
| Front and rear protective skid plates | ● | ● | ● | ● | | | |
| Front and rear alloy-effect protective skid plates | | | | | ● | | |
| Alloy-effect door sill covers | | | | | ● | | |
| Electrically foldable door mirrors | | | | | ● | | |
| Heat-reflective windscreen | | | | | ● | | |
| Rain-sensitive windscreen wipers | | | | | ● | | |
| Automatic Lighting Control | | | | | ● | | |
| Daytime running lights (uses standard headlight dipped beam) | | | | | ● | | |
| Stainless steel exhaust tailpipe | | | | | ● | | |
| Dual Ellipsoidal headlights | ● | ● | ● | ● | | | |
| Xenon headlights with dynamic beam levelling and high-pressure headlight washers | | | | | ● | | |
| Front and rear parking distance sensors | | ● | | ● | ● | | |
| Detachable tow bar with 12N electrics (retailer-fit) ² | ○ | ○ | ○ | ○ | ○ | 666.67 | 800.00 |
| Detachable tow bar with 12N/12S electrics (retailer-fit) ² | ○ | ○ | ○ | ○ | ○ | 729.17 | 875.00 |
| Detachable tow bar with 13 pin electrics (retailer-fit) ² | ○ | ○ | ○ | ○ | ○ | 583.34 | 700.00 |
| Two-coat metallic paint | ○ | ○ | ○ | ○ | ○ | 437.50 | 525.00 |

● = Standard equipment. ○ = Optional at extra cost.

² = Please note: All Antara models feature tow bar provision with Trailer Stability Programme and Electronic Stability Programme (ESP) as standard.

ANTARA FEATURES/OPTIONS

AUDIO, COMMUNICATIONS AND NAVIGATION

| Features | Exclusiv FWD | Exclusiv 4X4 | Diamond FWD | Diamond 4X4 | SE Nav | Price (£) exc. VAT | Total (£) inc. VAT |
|--|-----------------|-----------------|----------------|----------------|-----------|-----------------------|-----------------------|
| CD/MP3 CD player/stereo radio (CD 30 MP3) • CD/MP3 CD player • USB connection with iPod control • Aux-in socket • AM/FM stereo radio with 24 station presets • RDS with Traffic Programme • Remote display • 20 watts per channel output • 7 speakers | ● | ● | ● | ● | | | |
| Touch and Connect multi-media unit • 3D navigation system with 5-inch colour touch-screen • 28 country European mapping • Mobile phone system with Bluetooth® • CD/MP3 CD player • USB connection with iPod control • Aux-in socket • AM/FM stereo radio • RDS • 20 watts per channel output • 7 speakers | ○ ³ | ○ ³ | ○ | ○ | ● | 625.00 | 750.00 |
| Steering wheel mounted audio controls | ● | ● | ● | ● | ● | | |

● = Standard equipment. ○ = Optional at extra cost.

³ = Only available on 2.2CDTi 16v diesel models.

SATELLITE NAVIGATION

The satellite navigation system uses the international network of GPS (Global Positioning System) satellites, linked to a comprehensive 3D mapping system on the 5-inch colour LCD touch-screen, to determine your precise location and guide you to your chosen destination virtually anywhere in mainland Britain. In areas where radio stations operate the Traffic Messaging Channel (TMC) service you can take advantage of dynamic route guidance. This monitors incidents and delays along your chosen route and suggests an alternative route to avoid them, taking into account any previous conditions you have set such as avoiding motorways, toll roads etc. The system also offers major route navigation across a further 28 European countries via the supplied SD card. The bright display makes it easy to follow your progress on screen, and the directional arrows are backed up by spoken instructions that guide you to your destination turn-by-turn. A travel guide is a particularly useful feature that has details of restaurants, hotels, parking and other points of interest. Simply select the location you're interested in and let the navigation system guide you there.

MOBILE PHONE SYSTEM WITH BLUETOOTH®

The Touch and Connect unit includes built-in Bluetooth® v2.0, allowing transfer of phonebook contents, call history and caller ID. Simply tap the touch-screen to accept an incoming call and hear your caller through the stereo speakers. To make an outgoing call, choose a name from the phonebook via the touch-screen display, then carry on your conversation hands-free. The unit features an in-built microphone to pick up your voice. You can even stream music directly from your compatible mobile phone.

USB CONNECTION



USB connection provides iPod/iPhone control and read-out of iPod/iPhone functions through the audio system display. Traditional aux-in sockets only allow control of volume through the car's audio system. The USB connection also means that the mobile device will charge whilst it is connected. On the Touch and Connect unit the functionality can be accessed through the touch-screen display.

AUX-IN SOCKET

The aux-in socket allows you to connect your portable MP3 music player directly into the car's audio system. All you need is your music player and a suitable connecting lead and you can listen to all your favourite tunes through your car's speaker system. Using your MP3 music player in the car couldn't be easier – use it to select the music, as you would normally do, while controlling the volume via the car's regular volume controls.



ANTARA FEATURES/OPTIONS

WHEELS AND TYRES

| | Exclusiv FWD | Exclusiv 4X4 | Diamond FWD | Diamond 4X4 | SE Nav | Price (£) exc. VAT | Total (£) inc. VAT |
|---|-----------------|-----------------|----------------|----------------|-----------|-----------------------|-----------------------|
| Emergency tyre inflation kit (in lieu of spare wheel) | ● | ● | ● | ● | ● | | |
|  17-inch alloy wheels: 235/65 R 17 tyres | ● | | ● | | | | |
|  18-inch alloy wheels: 235/55 R 18 tyres | | ● | | ● | | | |
|  19-inch alloy wheels: 235/50 R 19 tyres | | | | | ● | | |

● = Standard equipment.

TYRE RATING

| Tyre size | Fuel efficiency group | Wet grip performance | External noise | |
|-------------|--------------------------|-------------------------|----------------|--|
| | | | Measured (dB) | Group |
| 235/65 R 17 | C | C | 71 |  |
| 235/55 R 18 | E | C | 71 |  |
| 235/50 R 19 | C | C | 71 |  |

Tyre rating according to EU Regulation 1222/2009

ANTARA SPECIFICATIONS

ENGINES

| | 2.4i 16v petrol | 2.2CDTi 16v (163PS) ECOTEC-4 Turbo diesel | 2.2CDTi 16v (184PS) ECOTEC-4 Turbo diesel |
|---|--|--|--|
| Fuel type | Petrol | Diesel | Diesel |
| Capacity | 2384cc | 2231cc | 2231cc |
| Maximum power | 167PS (123kW) @ 5600rpm | 163PS (120kW) @ 3800rpm | 184PS (135kW) @ 3800rpm |
| Maximum torque | 230Nm (170 lb.ft.) @ 4500rpm | 350Nm (258 lb.ft.) @ 2000rpm | 400Nm (295 lb.ft.) @ 2000rpm |
| Configuration | 4 cylinders, 4 valves per cylinder, double overhead camshafts | 4 cylinders, 4 valves per cylinder, single overhead camshaft | 4 cylinders, 4 valves per cylinder, single overhead camshaft |
| Fuel/induction system | Naturally aspirated. Electronic fuel injection | Variable geometry turbocharger with intercooler. Common rail fuel injection | Variable geometry turbocharger with intercooler. Common rail fuel injection |
| Emission compliance | Euro 5 | Euro 5 with Diesel Particulate Filter | Euro 5 with Diesel Particulate Filter |
| Service interval | 20,000 miles or 1 year (whichever occurs sooner) | 20,000 miles or 1 year (whichever occurs sooner) | 20,000 miles or 1 year (whichever occurs sooner) |
| <i>Benefit in kind company car taxation rates – 2012/13 tax year</i> | | | |
| FWD | 32% | 26% | - |
| 4X4 manual | - | 28% | 28% |
| 4X4 automatic | - | 35% | 35% |

FWD = Front-wheel drive.

ANTARA SPECIFICATIONS

PERFORMANCE, FUEL ECONOMY AND EMISSIONS

| | Performance (manufacturer's figures) | | Fuel economy mpg (litres/100km) | | | CO ₂ emissions g/km | VED* | Standard rate |
|--------------------------------|---|----------------------------------|------------------------------------|----------------------------|--------------------|--------------------------------------|------|------------------|
| | Maximum speed (mph) | Acceleration 0-62mph (sec) | Urban driving | Extra- urban driving | Combined figure | | | |
| FWD models | | | | | | | | |
| 2.4i 16v | 118 | 10.5 | 23.5 (12.0) | 40.4 (7.0) | 32.1 (8.8) | 206 | £600 | £270 |
| 2.2CDTi 16v (163PS) Start/Stop | 117 | 9.9 | 37.7 (7.5) | 54.3 (5.2) | 46.3 (6.1) | 160 | £170 | £170 |
| 4X4 models | | | | | | | | |
| 2.2CDTi 16v (163PS) Start/Stop | 117 | 9.9 | 35.8 (7.9) | 50.4 (5.6) | 44.1 (6.4) | 170 | £275 | £195 |
| 2.2CDTi 16v (163PS) automatic | 113 | 12.0 | 26.9 (10.5) | 44.1 (6.4) | 35.8 (7.9) | 208 | £600 | £270 |
| 2.2CDTi 16v (184PS) Start/Stop | 124 | 9.6 | 35.8 (7.9) | 50.4 (5.6) | 44.1 (6.4) | 170 | £275 | £195 |
| 2.2CDTi 16v (184PS) automatic | 119 | 10.1 | 26.9 (10.5) | 44.1 (6.4) | 35.8 (7.9) | 208 | £600 | £270 |

*VED = Vehicle Excise Duty. Correct at time of publication (November 2012).

Fuel consumption and CO₂ emission data complies with the relevant EU testing regulations used by vehicle manufacturers to enable comparisons between different models. **Important:** Please note fuel consumption can be affected by many factors including driving style, road and traffic conditions, vehicle mileage and standard of maintenance. In addition these results relate to the particular vehicle tested, inevitably there will be differences between individual vehicles of the same model.

START/STOP TECHNOLOGY

Start/Stop system offers real benefits by improving fuel economy and reducing CO₂ emissions, particularly in town. It does this by automatically stopping the engine when you come to a standstill, and then restarting as you prepare to move off.

Before automatically stopping the engine a number of system checks are carried out to ensure that it is both safe and practical to do so. To ensure safety, the driver must depress the clutch pedal, shift in to neutral, and then release the clutch pedal.

System checks carried out before Auto Stop activates include:

- Start/Stop system is not manually deactivated via the facia button
- Sufficient brake vacuum is available to prevent the car rolling down an incline
- Battery is in good condition and charged
- Outside air temperature and engine temperature are above specified minima

- Electronic climate control (where fitted) is not in maximum heating or maximum cooling mode
- Self-cleaning function of the diesel particulate filter is not active

If all of these conditions are satisfied then the vehicle will Auto Stop.

When you are ready to pull away from standstill, Auto Restart is activated by depressing the clutch pedal.

Whilst at a standstill the vehicle is continually monitored. If necessary, the engine will automatically be restarted. Conditions that would initiate an Auto Restart include:

- Low battery level
- Brake vacuum below specified minimum
- Start/Stop system is manually deactivated
- Stationary for 5.5 minutes

Vauxhall supporting



SMARTER DRIVING TIPS

- **Drive at an appropriate speed:** – Staying within the speed limit increases driver safety, reduces CO₂ emissions and saves fuel. At 70mph you could be using up to 9% more fuel than at 60mph and up to 15% more fuel than at 50mph
- **Drive smoothly at all times:** – Anticipate the ebb and flow of the traffic to avoid harsh acceleration and braking
- **Reduce your revs:** – Change gear earlier to help reduce fuel consumption – try 2500rpm with petrol engines and 2000rpm with diesel
- **Idling is wasting fuel:** – If you're likely to be at a standstill for more than three minutes, switch off the engine to save fuel
- **Regularly check your tyre pressures:** – Under inflated tyres increase CO₂ emissions whilst incorrectly inflated tyres can be unsafe. Always check your handbook for the correct tyre pressure. This will also help to increase the life of your tyres
- **Remove unnecessary items from the car:** – Extra weight increases the engine's workload, whilst roof racks and bike carriers increase wind resistance. All burn more fuel and increase CO₂ emissions

ANTARA SPECIFICATIONS

TRANSMISSIONS

Six-speed manual gearbox:

Standard on all models

Six-speed automatic transmission with Active Select function:

Available at extra cost on diesel models. Electronically controlled with adaptive driving function and fuel-saving eco mode. Fluid drive with torque converter, lock-up clutch and Active Select.

STEERING

- Speed-sensitive power-assisted steering
- Turning circle (kerb-to-kerb): 11.87m (38.9ft.)

SUSPENSION

Front: Independent. Lightweight MacPherson struts with gas-pressure dampers and coil springs. Anti-roll bar.

Rear: Independent. Multi-link with coil springs and gas-pressure dampers. An automatic self-levelling rear suspension system is integrated within the dampers, requiring no external power source.

BRAKES

- Anti-lock Braking System (ABS)
- Dual circuit, diagonally split braking system

All models

Front ventilated discs: 296mm diameter
Rear ventilated discs: 303mm diameter

BODY

- Aerodynamic drag co-efficient: Cd 0.38

FUEL TANK CAPACITY

- 65 litres (14.3 gallons).

WEIGHTS AND TOWING DATA kg

| | Gross vehicle weight | Max. towing weights Trailer with brakes (without brakes) |
|-----------------------------|----------------------|---|
| FWD petrol models | 2183 | 1500 (750) |
| FWD diesel models | 2270 | 2000 (750) |
| Manual 4X4 models | 2345 | 2000 (750) |
| Automatic 4X4 models | 2370 | 1700 (750) |

Gross vehicle weight is the total permissible weight of the vehicle including passengers and their luggage. The maximum roof rack loading should not exceed 100kg. The maximum towing weights are based on the ability of the car, with two occupants of 75kg each, to restart on a 12% gradient, which is approximately 1 in 8.3, at sea level. At altitudes above 1500 metres, the engine output may drop with a corresponding reduction in towing capability. Any extra weight, such as luggage or additional passengers, should be deducted from the maximum towing weight. With a trailer fully loaded, maximum noseweight should not exceed 80kg. Always fit Vauxhall towing attachments and accessories available from your Vauxhall retailer. They are designed specifically for Vauxhall models and carry a 12-month guarantee.

VAUXHALL LIFETIME WARRANTY

We're so confident in Vauxhall quality and reliability that we are now able to offer a lifetime warranty. Available to the first owner of all new Vauxhall passenger cars, it's valid for the lifetime of the vehicle up to a maximum of 100,000 miles*.

In addition our warranty also includes Vauxhall Assistance for 12 months from first registration and six years body panel anti-perforation warranty. Full details of Vauxhall's warranties including terms, conditions and exclusions can be obtained through any authorised Vauxhall Retailer or go to www.vauxhall.co.uk/warranty

**LIFETIME
WARRANTY 100,000 MILE**

*Vauxhall Lifetime Warranty covers lifetime ownership of first car owner. 100,000 mile limit, annual check required. The warranty excludes wear and tear and serviceable items and the vehicle must be serviced in accordance with the manufacturer's servicing schedule to continue the lifetime warranty. Terms and conditions apply. Offer available to all Vauxhall passenger cars. (this offer does not apply to car-derived vans) from 1st August 2010.

ANTARA SPECIFICATIONS

EXTERIOR DIMENSIONS millimetres (inches)

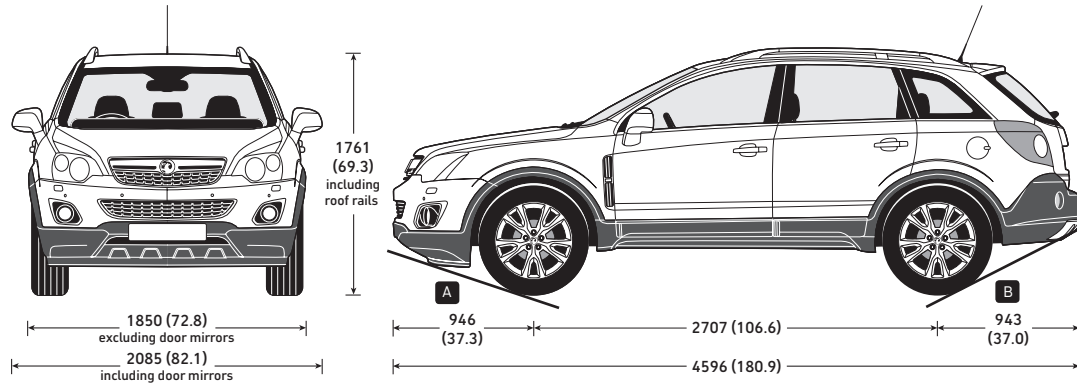

OFF-ROAD CAPABILITIES

Max. ground clearance
176mm (6.9 inches)

Max. wading depth
450mm (17.7 inches)

Max. approach angle **A**
20°

Max. departure angle **B**
24°

Max. ramp angle
18°

LOADSPACE DIMENSIONS

millimetres (inches)

| | |
|------------------------------------|-------------|
| Maximum length (behind rear seats) | 928 (36.5) |
| Maximum length (rear seats folded) | 1740 (68.5) |
| Maximum width | 1320 (52.0) |
| Width between wheel arches | 968 (38.1) |
| Loading height | 796 (31.3) |

LUGGAGE CAPACITIES*

litres (cu.ft.)

| | |
|--|-------------|
| Rear seats up (under luggage compartment cover) | 420 (14.8) |
| Rear seats folded (to upper edge of front seat back) | 865 (30.5) |
| Rear seats folded (to roof) | 1420 (50.1) |

* = Measured using the ECIE method.

ANTARA ACCESSORIES

| | Total (inc. VAT) |
|---|------------------|
| INFOTAINMENT* | |
| iPod connection kit | |
| Connects2 i-Connect FM – FM modular | £130.00 |
| Bury Bluetooth® phone kits | |
| CV9040 – Portable, colour screen, voice recognition | £160.00 |
| Classic – Fully integrated, phone charging function, illuminated controls | £200.00 |
| CC9060 – Fully integrated, detachable colour screen, voice recognition | £290.00 |
| CV9060 Music – Fully integrated, detachable colour screen, iPod control, voice recognition | £330.00 |
| Garmin Portable Sat Navs (includes case) | |
| Nüvi 40 (UK/Ireland) – 4.3-inch screen | £110.00 |
| Nüvi 2415 (UK/Ireland) – 4.3-inch screen, Bluetooth, eco route | £140.00 |
| Nüvi 2415LT (UK/Ireland) – 4.3-inch screen, Bluetooth, eco route, lifetime traffic alerts | £160.00 |
| Nüvi 2515 (UK/Ireland) – 5-inch screen, Bluetooth, eco route | £150.00 |
| Nüvi 2515LT (UK/Ireland) – 5-inch screen, Bluetooth, eco route, lifetime traffic alerts | £170.00 |
| Nüvi 2495LMT (Europe) – 4.3-inch screen, Bluetooth, lifetime map updates/traffic alerts | £220.00 |
| Nüvi 2595LMT (Europe) – 5-inch screen, Bluetooth, lifetime map updates/traffic alerts | £230.00 |
| Multimedia units | |
| Zenec ZE-NC524 – 6.1-inch touchscreen, sat nav (Europe), Bluetooth, iPod control, DVD/CD player, MW/FW radio | £850.00 |
| Clarion CX501E – Bluetooth, iPod control, CD player, LW/MW/FM radio | £450.00 |
| Clarion NX302E** – 6.2-inch touchscreen, sat nav (Europe), Bluetooth, iPod control, MW/FM radio | £850.00 |
| Clarion NX501ERV – 6.2-inch touchscreen, sat nav (Europe), Bluetooth, iPod control, DVD/CD/MP3 CD player, MW/LW radio | £1100.00 |

| | Total (inc. VAT) |
|---|------------------|
| DAB digital radio* | |
| Fully integrated DAB digital radio | £195.00 |
| Sat Nav updates¹ | |
| Please consult your retailer for latest map updates or visit www.vauxhall.co.uk/accessories . | |
| 1 = For use with optional factory-fit satellite navigation systems. | |
| CHILD SEATS² | |
| BABY-SAFE ³ – 0-13kg/birth to 15 months | £120.00 |
| – ISOFIX base | £185.00 |
| – ISOFIX bracket | £215.00 |
| DUO ISOFIX ³ – 9-18kg/9 months to 4 years with top tether kit | £280.00 |
| KID ³ – 15-36kg or 4 to 12 years | £125.00 |
| 2 = Restrictions apply to the use of child seats, please consult your Vauxhall retailer. | |
| 3 = Without transponder. | |
| SAFETY | |
| Privacy shades – rear door windows | £53.00 |
| Privacy shades – tailgate/rear side windows | £63.00 |
| Parking sensors* | |
| – two sensor rear number plate mounted | £230.00 |
| – four sensor front number plate mounted | £250.00 |
| – four sensor rear bumper mounted | |
| – unpainted | £300.00 |
| – painted | £330.00 |
| Safety Pack in branded – first aid kit, warning triangle, hi-visibility vest, Vauxhall bag | |
| First aid kit | £12.00 |
| Warning triangle | £14.00 |
| Fire extinguisher – 2kg | £30.00 |
| Hi-visibility vest | £7.00 |
| Temporary tyre inflation kit | £114.00 |
| Tyre sealant – 700ml | £44.00 |

| | Total (inc. VAT) |
|--|------------------|
| PRACTICAL | |
| Spare bulb kit ⁴ | £15.00 |
| Jump leads | |
| – petrol engines (16mm standard) | £39.00 |
| Fuel can – 5 litre | £17.00 |
| Fuel can – 10 litre | £27.00 |
| Stretch tow rope – 2 tonne | £27.00 |
| 4 = Excludes xenon headlight bulb for models with Adaptive Forward Lighting (AFL). | |
| PROTECTION | |
| All weather rubber mats – set of four | £80.00 |
| Premium carpet mats – set of four | £100.00 |
| Anti-slip cargo liner mat | £90.00 |
| Cargo liner | £60.00 |
| Vertical security net | £211.00 |
| Mudflaps – set of four* | £90.00 |
| Aluminium sill plates – front pair | £62.00 |

| | Total (inc. VAT) |
|--|------------------|
| TOURING | |
| T-track base carrier | £115.00 |
| Thule aluminium bicycle carrier ⁵ | £95.00 |
| Thule ski carrier ⁵ | from £105.00 |
| Thule extendable ski carrier ⁵ | £185.00 |
| Thule aluminium surfboard carrier ⁵ | £81.00 |
| Thule roof boxes | |
| – Ocean 80 hard roof box (340 litres) ⁵ | £190.00 |
| – Pacific 200 hard roof box (460 litres) ⁵ | from £320.00 |
| – Ranger 90 soft roof box (340 litres) ⁵ | £230.00 |
| Bicycle carrier – tow bar mounted | |
| two-bicycle carrier with rear lights (excludes number plate) | £358.00 |
| Additional bicycle carrier – for use with two-bicycle carrier | |
| Detachable tow bar* | £80.00 |
| – 12N electrics | £800.00 |
| – 12N/12S electrics | £875.00 |
| – 13 pin electrics | £700.00 |

5 = Must be used in conjunction with a base carrier.

| ALLOY WHEELS (set of four with centre caps)*6 | |
|--|---------|
| 17-inch 5-twin-spoke | £950.00 |
| 18-inch 5-spoke | £950.00 |
| 19-inch double 'Y'-spoke | £950.00 |

6 = Fitting time is based on four wheels fitted and includes static wheel balancing. Different tyres and locking wheel nuts may be required. Price excludes new tyres and locking nuts.

* = Fully fitted price – available at participating retailers.

** = CD player not included.

ANTARA ADDITIONAL INFORMATION

ON-THE-ROAD PRICES

To eliminate uncertainty about hidden costs when buying a new car, Vauxhall publishes on-the-road recommended retail prices (RRP) and these are shown in the pricing tables within this price guide. These prices include the recommended cost of number plates and delivery to a Vauxhall retailer of £700.00 (including £116.67 VAT), 12 months' Government Vehicle Excise Duty (see opposite for details) and the DVLA new vehicle first registration fee of £55.00*.

Please note: The on-the-road recommended retail price (RRP) does not include fuel supplied by the retailer, motor insurance or any other goods or services supplied by agreement between the retailer and the customer.

PRICE PROTECTION

Order a new Vauxhall for build in the current model year (as confirmed by your retailer) for delivery no more than three months in advance and the price you are quoted is the price you pay. This is irrespective of any subsequent price rises between placing your order and delivery of your new car, but you must take delivery as soon as the car is available. General Motors UK Limited is not liable for price adjustments caused by Government changes in the rate of VAT (currently 20%), Vehicle Excise Duty, DVLA new vehicle first registration fee or by any other applicable legislation or regulations.

VEHICLE EXCISE DUTY

The amount of Vehicle Excise Duty (road fund licence) payable on new cars varies depending on the level of carbon dioxide (CO₂) emissions produced by the vehicle. CO₂ emissions are measured in grammes (g) per kilometre (km) travelled and divided into 13 charging bands shown in the table below.

From 1 April 2010 the Government introduced a new 'first year rate' of Vehicle Excise Duty payable on all new cars. In subsequent years the amount of Vehicle Excise Duty payable will revert to the standard rate.

Vehicle Excise Duty*

| | CO ₂ emissions | First year rate | Standard rate |
|--------|---------------------------|-----------------|---------------|
| Band A | up to 100g/km | £0.00 | £0.00 |
| Band B | 101-110g/km | £0.00 | £20.00 |
| Band C | 111-120g/km | £0.00 | £30.00 |
| Band D | 121-130g/km | £0.00 | £100.00 |
| Band E | 131-140g/km | £120.00 | £120.00 |
| Band F | 141-150g/km | £135.00 | £135.00 |
| Band G | 151-165g/km | £170.00 | £170.00 |
| Band H | 166-175g/km | £275.00 | £195.00 |
| Band I | 176-185g/km | £325.00 | £215.00 |
| Band J | 186-200g/km | £460.00 | £250.00 |
| Band K | 201-225g/km | £600.00 | £270.00 |
| Band L | 226-255g/km | £815.00 | £460.00 |
| Band M | over 255g/km | £1030.00 | £475.00 |

* = Correct at time of issue - 9 November 2012.

E10 FUEL

E10 fuel is cleared for use in all petrol-engined Vauxhall vehicles excluding models with the 2.2 litre direct injection petrol engine (code Z22YH) used in Vectra, Signum and Zafira models. Owners of these vehicles should continue to use regular unleaded or premium unleaded petrol.

PROTECTING THE ENVIRONMENT

Vauxhall's commitment to the environment is demonstrated by our products' many environmental awards. For even more information on Vauxhall's efforts to achieve an environmentally sustainable future, see www.vauxhall.co.uk/recycling

VAUXHALL ASSISTANCE

Vauxhall Assistance is provided automatically with every new Vauxhall for 12 months from first registration and covers everything from accident assistance, roadside recovery and 'at home' service to flat tyres. With Vauxhall Assistance help is literally just a free** phone call away, 24 hours a day, 365 days a year!

** = Mobile phone users will be charged at their standard tariff.

VAUXHALL LEASING

As Vauxhall's own contract hire and fleet management operation, Vauxhall Leasing provides a one-stop-shop for competitive car and van leasing solutions - for business users and private individuals. Working with the Vauxhall retailer network, we combine the support of a national contract with the convenience of a local contact.

For further information, please see your local Vauxhall retailer or call us on **0870 737 2557**. Alternatively, you can visit our website at www.vauxhall-leasing.co.uk

IN THE EVENT OF AN ACCIDENT...

Vauxhall Accident Support helps keep you mobile following an accident. Benefits include scene-of-accident advice, message service, assistance with claims and vehicle recovery. For further details call **0800 010 304**.

Alternatively, details can be found on our website at www.vauxhall.co.uk

MASTERFIT

Vauxhall's MasterFit retailers offer a great service for owners of all Vauxhall cars. Value for money, regular offers and free check-ups, combined with the peace of mind that comes from using trained technicians and genuine parts, help keep your car in peak condition at all times.

FOR MORE PRODUCT INFORMATION

For a brochure on any Vauxhall model (up to a maximum of three per caller) or location of your nearest Vauxhall retailer please call **0845 600 1500**. Alternatively, details can be found on our website at www.vauxhall.co.uk

VAUXHALL INSURANCE WITH ADDED REASSURANCE

Comprehensive cover - Summary of benefits*

- Competitive premiums
- Repairs by a Vauxhall technician
- Genuine Vauxhall parts, guaranteed for three years when we repair your car within our Approved Repairer Network
- Free courtesy car as standard when using an Approved Repairer**
- 24 hour claims helpline
- Personal Accident benefit
- Cover for audio equipment
- Windscreen cover

Call for a quote on **0844 463 2670†**

*The benefits listed above are for comprehensive cover only. For details of Third Party, Fire and Theft cover, please call our sales team.
**Should your car need repairing following an accident we provide a courtesy car (subject to availability) for the duration of the repair. Only genuine Vauxhall parts are used. Terms and conditions apply.
† Calls may be recorded. Vauxhall Motor Insurance is underwritten by Ageas Insurance Limited.

Every effort has been made to ensure that the contents of this document were accurate and up-to-date at the time of publication - 9 November 2012. The invoice price, including delivery to retailer, factory-fitted options, accessories fitted by the retailer and number plates, is subject to VAT. The right is reserved to alter specifications and prices, and withdraw products from sale, without notice. Please note that Vauxhall retailers are not the agents of General Motors UK Limited and are not authorised to bind the Company by any specific or implied undertaking or representation. It is advisable to ensure that your motor insurance policy provides adequate cover for additional fitted options and accessories. All rights reserved. No part of this publication may be reproduced in any form or by any means, without the prior written permission of General Motors UK Limited.

Base information prepared by Graymatter. General Motors UK Limited, Luton LU1 3YT www.vauxhall.co.uk

©2012 General Motors UK Limited



VAUXHALL