

Corsavan

2008 Edition 2

The small van that gives you more





 **VAUXHALL**
Commercial Vehicles

Sponsors of talkSPORT's coverage of the Barclays Premier League

MATCHDAY
LIVE! 

SATURDAYS 12.5PM

THE WHEELS OF BUSINESS

Whatever your load, Vauxhall Commercial Vehicles are designed to help you deliver a top quality job. Corsavan sets the standard by which other small car-derived vans are judged, with smart styling, a dynamic chassis, high levels of comfort and outstanding load-carrying ability. Along with the hugely popular Astravan and Combo, it completes our most impressive Light Commercial Vehicle range yet. Together, they offer gross vehicle weights from 1615kg to 1995kg, backed by superb reliability and low running costs.

If you need even greater capacity, Vivaro and Movano panel vans offer GVWs from 2735kg to 3500kg. Both are available in a range of wheelbase, roof height and payload formats so you can tailor a vehicle to meet your specific requirements. Movano is also available in chassis cab and crew cab variants – the ideal platform for our range of specialist conversions.

The success of the line-up is reflected in the large number of industry plaudits attracted by the range. Corsavan, for example, was voted 'Car-derived Van of Year 2007' by the magazine *Professional Van & Light Truck* – and 'Best Small Van' in the 2007 *What Van? Awards*. More recently it drove away with *Commercial Motor's* 'Testers' Choice' Light Van Award for 2008.

Combining low operating costs with genuine concern for the environment, the green credentials of the Vauxhall line-up as a whole are now firmly established. Indeed, the company was voted *Greenfleet* magazine's LCV Manufacturer of the Year in both 2006 and 2007.

With a range of over 200 variants to choose from and with sales over 53,000 units in 2007 (30,000 of which were manufactured here in the UK), you can rely on the fact that we also have a nationwide network of over 300 retailers to meet all your servicing and maintenance needs. To minimise downtime, there is a growing network of Premier Service Centres, providing a fast, efficient repair service at times to suit you. Clearly it's a formula that works – Vauxhall Commercial Vehicles really are The Wheels of Business.

Some of the vehicles shown in this brochure include options and accessories available at extra cost. And not all of the features described are available on every model. So please check the equipment and technical data section for further details. From time to time, we also offer alternative models such as Special Editions which are featured in separate literature or can be found on the Vauxhall website: www.vauxhall.co.uk



Corsavan

4

Loadspace

6

Dynamics and efficiency

8

Models

10

Options and accessories

12

Equipment and technical data

14

Colour availability

18



Sportive model illustrated.

THE SMALL VAN THAT GIVES YOU MORE

With its sporty good looks, Corsavan makes a clear style statement for any image-conscious business. Small enough for congested city streets, yet big enough to eat up the miles on the open road, it matches a dynamic new chassis with a light, spacious cabin and high levels of safety and security. And the load area is easy to access with purpose-built load protection and a class-leading 550kg payload capacity.

Corsavan's stylish shape is noticeably longer, taller and wider than many competitors, meaning more space for the driver and passenger. The full-length flat floor makes it practical and easier to load. And, at 550kg, Corsavan payload capacity surpasses each of its would-be rivals.

Few vans can match Corsavan's low running costs. Both the 1.3CDTi 16v diesel engines and the 1.2i 16v petrol engine are economical and insurance group ratings are low (1E T2). Service intervals are a long 20,000 miles/one year on all models and the warranty stretches to three years/60,000 miles.

The Corsavan cabin is built for long-term driver comfort. The seats provide outstanding levels of support. The fascia is both stylish and ergonomically efficient, with a stereo radio/CD player fitted as standard. There is also plenty of useful in-cab storage for your paperwork, drinks and all those other essentials for a busy working day.

Introduce our stylish new Sportive model – complete with body-colour detailing, 15-inch alloy wheels, a 1.3CDTi 16v (90PS) common rail turbo diesel engine and six-speed gearbox – and Corsavan is simply more appealing all round.

COMMERCIAL MOTOR SAID...

'Bringing new levels of refinement and build quality to the sector was never going to be an easy task but Vauxhall has succeeded with its highly impressive Corsavan.'

JANUARY 2008



Max. payload
550kg



3-year/60,000 mile
warranty



Insurance Group
1E T2



Sportive model illustrated.

Corsavan takes its load carrying duties very seriously indeed, with strong attention to detail in the areas that really matter. A tall, wide tailgate aperture makes it easy to load. The long, high load area has superb load and occupant protection features. Most of all, it carries an impressive 550kg maximum payload – a figure that puts all its major competitors in the shade.

EASY LOADABILITY

The Corsavan has never been easier to load. The taller tailgate aperture allows larger items to be loaded. The tailgate itself lifts high (for good headroom) and extends down into the bumper making for a low loading height.

LOAD PROTECTION

A sturdy steel floor and half-height steel bulkhead, tough sidewall half-height panelling and load restraint lashing eyes are all standard. An upper load restraint mesh, fitted rubber floor mat and four-piece load compartment cover are optional for even more load protection.



◀ Four-piece load compartment cover optional at extra cost.



LOADSPACE DIMENSIONS*	mm	inches
Maximum load floor length	1257	49.5
Maximum load area height	924	36.4
Maximum load area width	1264	49.8
Width between wheel arches	969	38.1
Load sill height (unladen)	691	27.2
Maximum tailgate aperture height	650	25.6
Maximum tailgate aperture width	980	38.6

LOADSPACE VOLUME	cu.m	cu.ft
Maximum loadspace volume (VDA method)	0.92	32.5

*Please refer to pages 17–19 of the technical data section for more detailed loadspace, weight and towing data.

◀ Corsavan's high-lift tailgate opens to reveal a practical 0.92 cu.m (32.5 cu.ft) loadspace. For additional load and occupant protection, a steel upper load restraint mesh and rubber floor mat (both illustrated) are optional at extra cost.



Max. load floor length



Max. payload 550kg



LOADSPACE

- | 550kg maximum payload
- | Steel load area floor
- | Half-height steel bulkhead
- | Sidewall half-height panelling
- | Load restraint lashing eyes
- | Upper load restraint mesh (optional)
- | Fitted rubber floor mat (optional)
- | Four-piece load compartment cover (optional)



DYNAMICS AND EFFICIENCY

- | Choice of engines: 1.2i 16v (80PS/110Nm) petrol, 1.3CDTi 16v (75PS/170Nm) EcoFlex and 1.3CDTi 16v (90PS/200Nm)* diesels
- | Five-speed manual gearbox** | Six-speed manual gearbox* | Anti-lock Braking System (ABS) with Electronic Brakeforce Distribution (EBD)
- | Electric speed-sensitive power-assisted steering | Dynamic Safety Suspension (DSA) | One-year unlimited mileage manufacturer's warranty
- | Second and third year no-fee customer option warranty up to 60,000 miles *Sportive models only. **Excluding Sportive models.

Corsavan's car-like ride and handling make for a comfortable and relaxing day at the wheel – a major consideration for any busy working van driver. Both engine choices – common rail diesel and multi-valve petrol, are designed to save you money. Anti-lock Braking System (ABS) with Electronic Brakeforce Distribution (EBD) is standard, as is speed-sensitive power-assisted steering, making Corsavan especially easy to manoeuvre and park.

WHAT VAN? SAID...

'The 1.3 diesel is a little cracker. It's refined and offers a good spread of torque.'

DECEMBER 2007 1.3CDTi 16v 75PS

Dynamic Safety Suspension (DSA).

When any vehicle brakes on surfaces with differing levels of grip (eg. gravel or mud versus dry tarmac), there is always the potential for loss of control. Corsavan's DSA suspension helps correct this tendency, making the van safer under 'break away' conditions.

▶ Anti-lock Braking System (ABS).

The latest ABS system with Electronic Brakeforce Distribution (EBD) and Emergency Brake Assist (EBA) can reduce emergency stopping distances even further, particularly on slippery roads and help drivers retain steering control.

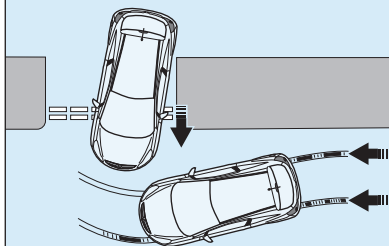

Corsavan EcoFlex models.

The Corsavan EcoFlex models have among the lowest vehicle CO₂ emissions in the UK. Not only is the 1.3CDTi (75PS) turbo diesel engine fuel efficient, its advanced common rail technology also makes it one of the smoothest and most flexible units in its class.

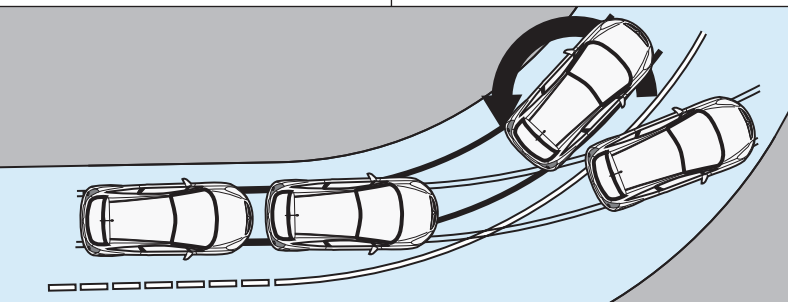

▶ 1.3CDTi 16v common rail diesel.

Base models feature our award-winning 1.3CDTi 16v (75PS) EcoFlex engine matched to a five-speed gearbox. Sportive models take the 90PS version matched to a six-speed gearbox. Both versions deliver outstanding performance combined with excellent fuel economy.



▶ **ESP-plus and TC.** The optional Electronic Stability Programme-plus (ESP-plus) with Enhanced Understeering Control (EUC) works in conjunction with the vehicle's Traction Control (TC) system to help you maintain control during adverse or emergency conditions. Sensing when the vehicle is about to slide on a bend, ESP-plus gently applies corrective braking to the appropriate wheel or wheels, correcting the slide and helping you regain control more rapidly. Traction control also stops wheelspin during acceleration.



▶ **1.2i 16v Twinport.** The 80PS (110Nm) multi-valve petrol engine uses advanced Twinport technology for increased performance and fuel economy, allied to rigorous emissions control. This unit is backed by a five-speed manual gearbox.

CORSAVAN

Known simply as Corsavan, the base model provides a well-equipped and cost-efficient introduction to the model line-up. Drivers can choose between two highly responsive yet economical engines: 80PS 1.2i 16v Twinport petrol and 75PS 1.3CDTi 16v EcoFlex common rail turbo diesel.

Standard features include:

- | Punch Charcoal cloth seat trim
- | Driver's airbag
- | Pyrotechnic body-lock seatbelt pretensioners
- | Anti-lock braking system
- | Emergency brake assist
- | Electronic brakeforce distribution
- | Electronic engine deadlock immobiliser
- | Remote control central locking with security deadlocks
- | Speed-sensitive electric power-assisted steering
- | Five-speed manual gearbox
- | Satin stone-effect centre console
- | CD 30 stereo radio/CD player
- | Electrically adjustable door mirrors
- | Passenger's underseat storage tray
- | Half-height steel bulkhead
- | Steel load area floor
- | Load restraint lashing eyes

Model and engine availability and insurance groups (ABI)

1.2i 16v	1E
1.3CDTi 16v (75PS) EcoFlex	1E

Model illustrated (right) features optional electric windows.



In-cab stowage features include a passenger's underseat storage tray (above) and a document pocket in the driver's sunvisor (not illustrated). Both door pockets include a drinks holder and space for bottles up to 1.5 litres; the centre console features two more drinks holders (when ashtray/storage container removed) and coin holders.

SPORTIVE

With a host of exterior enhancements that include two-coat metallic paint, body-colour detailing, dark-style headlights and 15-inch alloy wheels – and power provided by a more potent 90PS 1.3CDTi 16v turbo diesel engine – Sportive is an exciting addition to the Corsavan line-up.

Additional features over and above base model include:

- | Sports-style seats with fuse garnet red cloth trim
- | Driver's seat height adjuster
- | Reach and rake adjustable steering
- | Air conditioning
- | Interior light pack
- | Electrically operated windows
- | Matt chrome-effect centre console
- | Sports instruments
- | Six-speed manual gearbox
- | Electrically adjustable/heated door mirrors
- | Body-colour door mirrors and door handles
- | Dark-style headlights
- | Front fog lights
- | 15-inch alloy wheels
- | Sportive badge
- | Sports chrome exhaust tailpipe
- | Two-coat metallic paint

Model and engine availability and insurance groups (ABI)

1.3CDTi 16v (90PS)

1E



Inside, too, Corsavan Sportive adds fresh appeal and driving flair that's bound to excite any small van user. With additional design cues and extra features that include electrically operated windows (above), it's perfect for the business that's going places in style.

OPTIONS AND ACCESSORIES

Vauxhall options and accessories are all about choice – selecting your Corsavan then personalising it to suit the way you work. There's a choice of factory-fitted options and a huge range of retailer-fit accessories. You can also choose styling products from the VXR range as well as auto design specialist Irmischer International. For further information please ask your Vauxhall Commercial Vehicle retailer for more details.

INDIVIDUAL OPTIONS INCLUDE:

- > CD 60 satellite navigation system with MP3 format CD player
- > ESP-plus
- > Passenger's airbag
- > Air conditioning*
- > Electric windows*
- > Heated door mirrors*
- > Front fog lights*
- > Rear parking distance sensors
- > Load area rubber floor mat
- > Four-piece load compartment cover
- > Upper load restraint mesh



OPTION PACK

Corsavan Plus Pack*

- > Driver's seat height adjuster **1**
- > Steering column adjustable for reach and rake

**Standard on Sportive models*



  **Load area options.** Load area safety and security can be further enhanced with a range of extra-cost options. The steel upper load restraint mesh and fitted rubber floor mat provide added protection from shifting loads, while the four-piece load compartment cover hides the load from prying eyes.



 **Rear parking distance sensors.** This factory-fitted option provides an audible warning when an object is detected within a set range behind the vehicle.



ACCESSORIES

Vauxhall accessories are the right choice for your Corsavan. Listed below is just a small sample of the range available. For a full list, please refer to the Vauxhall Commercial Vehicle Accessories brochure, Commercial Vehicle and Accessory Price Guide or visit our website www.vauxhall-accessories.com

- > Base carrier
- > Ladder rack
- > Tow bars and electrics
- > Mudflaps
- > Steering wheel security bar

irmscher

Developed in conjunction with auto design specialists Irmischer International, a range of styling accessories are available to enhance and help personalise your Corsavan:

- > Interior styling
- > Exterior body styling
- > Styling pack
- > Sports silencer
- > Alloy wheels

▼ **Irmischer rear hood spoiler.**

▲ **Corsavan VXR Styling Pack.** Boost your style with a front lower spoiler, side sills, rear roof spoiler and rear lower skirt.



◀ **Rubber floor mats (pair).** Rubber floor mats protect your interior from everyday wear and tear. All come with secure fixings and an anti-slip underside.



◀ **Headlight protectors**.** They clip on in moments, yet provide real protection for your headlights against chips and cracks. Available in the standard format or carbon fibre-effect (illustrated).

**Astravan version illustrated.



◀ **Rear parking distance sensors.** The accessory early warning system helps safeguard your vehicle and pedestrians. When reverse gear is selected, the system beeps as you reverse close to an obstruction (like posts, fences or people), changing to a continuous tone when the object is approximately 300mm away.



Front door pockets.



Rev counter.

Safety

Standard features • Driver's dual-stage airbag • Pedal release system – Reduces potential injury to the driver's legs and feet during a severe frontal impact • Laminated windscreen • Side-impact protection beams • Fuel tank located ahead of rear axle • Anti-lock Braking System (ABS) with Electronic Brakeforce Distribution (EBD) – see page 9 • Straight Line Stability control (SLS) – Optimises directional stability when braking • Cornering Brake Control (CBC) – Makes the vehicle easier to control in extreme situations such as braking sharply on a bend • Drag Torque Control (DTC) – Helps maintain stability when suddenly lifting off the accelerator • Emergency Brake Assist (EBA) – Increases brake force applied in emergency braking situations • Adaptive Brake Lights (ABL) – Brake lights flash when ABS is activated, thus warning following vehicles that heavy braking is in progress • Height-adjustable head restraints • Height-adjustable inertia-reel seatbelts • Pyrotechnic body-lock seatbelt pretensioner system – Tightens the diagonal belt during the early stages of a frontal impact • Driver's and passenger's seatbelt force limiters – Reduces potential upper body injuries during a frontal impact • Seatbelt unfastened audible warning • Anti-submarining ramps in seats – Help prevent occupants sliding underneath the lap belt during a collision

Additional features	Corsavan	Sportive
Passenger's dual-stage airbag	<input type="radio"/>	<input type="radio"/>
Electronic Stability Programme-plus (ESP-plus) with traction control – see page 9	<input type="radio"/>	<input type="radio"/>

Security

Standard features • Electronic theft protection for audio equipment • Electronic engine deadlock immobiliser • 'Key left in ignition' audible warning • Visible Vehicle Identification Number (VIN) • Freewheeling door locks • Door-to-door illumination – Keeps the headlights and rear lights on for 30 seconds after the front doors are locked • Remote control central locking (doors, tailgate, fuel flap) with security deadlocks

Facia, instruments and controls

Standard features • Multi-function display panel showing time, date, audio information and outside air temperature (with ice warning function) • Digital clock with automatic RDS time adjustment • Adjustable speed limit audible warning – Allows the driver to set the speed above which an alarm sounds • Trip odometer • Rev counter • Electronically controlled fuel gauge • Low fuel level warning light • Headlight/brake light bulb failure warning light • Service-due indicator • Handbrake-on warning light • Instrument panel light dimmer • Lights-on audible warning • Electric headlight beam levelling • Glovebox with lid • Cigar lighter • Ashtray

Additional features	Corsavan	Sportive
Steering column adjustable for reach and rake	<input type="checkbox"/>	<input checked="" type="checkbox"/>
Sports instruments		<input checked="" type="checkbox"/>

Audio, communication and navigation

	Corsavan	Sportive
CD 30 stereo radio/CD player • AM/FM stereo radio with 36 station presets • RDS with Traffic Programme • CD player • Remote display • 17 watts per channel output	●	●
CD 60 stereo radio/CD player with MP3 format/satellite navigation • AM/FM stereo radio with 40 station presets • RDS with Traffic Programme • CD player with MP3 format • Auxiliary-in socket • Satellite navigation system • Colour monitor • 20 watts per channel output	○	○
Mobile phone system with Bluetooth® (does not include phone or phone-specific cradle) and graphic information display	○	○

Heating and ventilation

Standard features • Side window demist vents and four adjustable heating and ventilation outlets • Air blend heater with four-speed fan and illuminated controls • Interior pollen filter • Interior odour-reducing activated charcoal filter¹

Additional feature

Air conditioning (includes air recirculation facility)

Corsavan Sportive

○ ●

Seating

Standard features • Reclining front seats • Front passenger's underseat storage tray

Additional features

Punch charcoal cloth trim

Fuse garnet red cloth trim

Sports-style seats

Driver's seat height adjuster

Corsavan Sportive

● ● ● ●
□ ●

Additional interior features

Standard features • Front door pockets • Chrome-effect door handles • Drinks holder and coin holders in centre console • Front tiltable driver's and passenger's assist handles • Dipping rear-view mirror • Interior courtesy light operated by door switches
• Chrome-effect handbrake button • Translucent lighting for radio control

Mechanical

Standard features • Front-wheel drive • Five-speed manual gearbox (1.2i 16v, 1.3CDTi 16v (75PS)) • Six-speed manual gearbox (Sportive) • Speed-sensitive electric power-assisted steering – Provides light steering for parking with enhanced feedback at normal road speeds, without harming fuel economy • Gas-pressure dampers • Front anti-roll bar



CD 30 stereo radio/CD player.



Driver's seat height adjuster – standard on Sportive.

- = Standard equipment.
- = Optional at extra cost.
- = Only available as part of an extra-cost option pack (see page 16 for details).

¹ = Activated charcoal filter is unavailable on Sportive models and deleted if optional air conditioning is specified.



Front fog lights.



Flush wheel covers.

Load area

Standard features • Glazed tailgate • Half-height steel bulkhead • Loadspace sidewall half-height protection panelling
• Load restraint lashing eyes • Illuminated load area

Additional features	Corsavan	Sportive
Upper load restraint mesh	○	○
Rubber floor mat	○	○
Load compartment cover (four-piece)	○	○

Exterior features

Standard features • Heated rear window • Intermittent rear window wash/wipe • Two-speed windscreen wipers with adjustable intermittent wipe • Tinted glass • Manually foldable door mirrors • High-level LED centre brake light • Rear fog light • Dual Ellipsoidal (DE) halogen headlights • Twin electrically adjustable door mirrors (wide-angle on driver's side) • Body-colour bumpers
• Part body-colour door mirrors (fully body coloured on Sportive models) • Body-colour tailgate handle

Additional features	Corsavan	Sportive
Electrically operated windows with safety autoreverse and one-touch facility	○	●
Twin electrically heated door mirrors (wide-angle on driver's side)	○	●
Rear parking distance sensors	○	○
Two-coat metallic or pearlescent paint	○	●
Special paint (restrictions apply – please consult your retailer for availability)	○	
Front fog lights	○	●
Dark-style headlights		●
Body-colour door handles		●
Sports exhaust		●

Wheels and tyres

Features	Corsavan	Sportive
Flush wheel covers	●	
14-inch steel wheels with 185/70 R 14 low profile tyres	●	
15-inch alloy wheels with 185/65 R 15 low profile tyres		●
Full-size spare wheel	●	●
Tyre repair kit in lieu of spare wheel	N/C	N/C

Option pack

	Corsavan	Sportive
Plus Pack		
• Driver's seat height adjuster • Steering column adjustable for reach and rake	○	●

● = Standard equipment.
○ = Optional at extra cost.
N/C = No-cost option.

Engines

	1.2i 16v Twinport ECOTEC-4	1.3CDTi 16v (75PS) ECOTEC-4	1.3CDTi 16v (90PS) ECOTEC-4
Capacity	1229cc	1248cc	1248cc
Maximum power	80PS (59kW) @ 5600rpm	75PS (55kW) @ 4000rpm	90PS (66kW) @ 4000rpm
Maximum torque	110Nm (81 lb.ft.) @ 4000rpm	170Nm (126 lb.ft.) @ 1750-2500rpm	200Nm (147 lb.ft.) @ 1750-2500rpm
Configuration	4 cylinders, 4 valves per cylinder, double overhead camshafts		
Emission compliance	Euro 4		
Fuel/induction system	Naturally aspirated with vacuum-controlled Twinport inlet ports. Multi-point sequential electronic fuel injection	Turbocharger with intercooler. Common rail fuel injection	Variable geometry turbocharger with intercooler. Common rail fuel injection
Service interval	20,000 miles or one year (whichever occurs sooner)		

Weights and towing data

Model	UK plated weights and kerbweights kg						Payload kg	Towing weights Trailer with brakes (without brakes) kg	Plated Gross Combination Weights (GCW) kg
	Front axle		Rear axle		Total				
	Plated	Kerb	Plated	Kerb	GVW	Kerb			
1.2i 16v	815	656	820	409	1615	1065	550	840 (450)	2455
1.2i 16v (a/c)	835	677	820	408	1635	1085	550	820 (450)	2455
1.3CDTi 16v 75PS	900	729	820	411	1690	1140	550	1005 (500)	2695
1.3CDTi 16v 75PS (a/c)	920	750	820	410	1710	1160	550	985 (500)	2695
1.3CDTi 16v 90PS Sportive	920	783	820	407	1740	1190	550	1185 (500)	2925

a/c = Air conditioning.

Note: Kerbweights for standard vehicles include coolant, oil, 90% full fuel tank and spare wheel. They will vary according to the vehicle specification (including options and accessories) with a corresponding variation in payload. **Payload figures** do not allow for the weight of the driver, or any passengers, which should therefore be deducted from the figures shown and are subject to correct weight distribution. **Gross plated weights** (including axle weights) quoted on the vehicle plate must never be exceeded. **Roof load** should not exceed 100kg including the weight of the roof rack/carrier.

Vauxhall Assistance and warranties*

- A one-year unlimited mileage manufacturer's warranty
- Second and third year no-fee customer option warranty up to 60,000 miles (from first registration)
- Vauxhall Assistance for 12 months from first registration
- Six years' body panel anti-perforation warranty

Fuel economy**

61.9mpg (4.6 litres/100km) unladen.
57.3mpg (4.9 litres/100km) laden.

Important: Figures quoted relate to the particular vehicle tested by an independent organisation. Variations in equipment, payload, driving style, road and traffic conditions, vehicle mileage and standard of maintenance may also affect fuel consumption; therefore the test results do not express or imply any guarantee of fuel consumption attainable.

* = Warranty is only available on vehicles sourced from Vauxhall Motors Ltd. Terms and conditions apply - please see your Vauxhall retailer for details.
** = 1.3CDTi 16v (75PS) - obtained during roadtesting by *Commercial Motor* magazine - May 2007.



Twinport petrol engine.



Common rail turbo diesel engine.



MacPherson strut front suspension.



Compound crank rear suspension.

Steering

- Rack and pinion
- Electric power-assisted steering standard – variable rate on diesel models
- Maximum turning circle (kerb-to-kerb): – 10.10m (33.1ft)

Suspension

Front: Independent. MacPherson struts with gas-pressure damper cartridge and coil springs. Anti-roll bar.

Rear: Compound crank with progressive-rate mini-block coil springs and gas-pressure dampers.

Brakes

- Anti-lock Braking System (ABS)
- Electronic Brakeforce Distribution (EBD)
- Emergency Brake Assist (EBA)
- Cornering Brake Control (CBC)
- Straight Line Stability control (SLS)
- Dual circuit, diagonally split, dual rate servo-assisted system
- Low brake fluid level warning light

1.2i 16v

Front discs: 257mm diameter

Rear drums: 203mm diameter

1.3CDTi 16v (75PS)

Front ventilated discs: 257mm diameter

Rear drums: 228mm diameter

1.3CDTi 16v (90PS)

Front ventilated discs: 284mm diameter

Rear drums: 228mm diameter

Electrics

Alternator:

70A (100A with air conditioning)

Maintenance-free battery:

1.2i 16v – 40Ah (50Ah with air conditioning)

1.3CDTi 16v – 65Ah

Fuel tank capacity

- 45 litres (9.9 gallons)

Body

- Aerodynamic drag co-efficient: Cd 0.33
- Extensive anti-corrosion protection

Insurance group

All models – Group 1E.

As recommended by the Association of British Insurers.

Colour availability

Solid



Glacier White



Flame Red



Cargo Yellow** (special order only)

Two-coat metallic*



Star Silver

Two-coat pearlescent*



Black Sapphire



Ultra Blue**

* = Two-coat metallic and pearlescent colours are available at no extra cost on Sportive models and at extra cost on base models. ** = Not available on Sportive. Special paint options are available on base models. Restrictions apply, please consult your Vauxhall Commercial Vehicle retailer for availability.

Dimensions millimetres (inches)

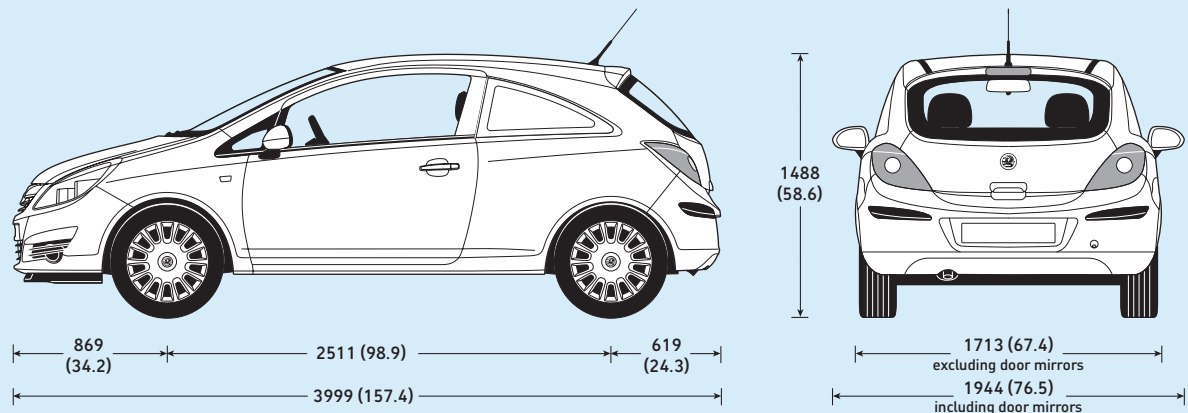

All heights are shown unladen.

Loadspace dimensions

Maximum load length	mm (inches)
Standard vehicle (A)	1257 (49.5)
Maximum load width	
- At widest point (B)	1264 (49.8)
- Between wheel arches (C)	969 (38.1)
Maximum load height	
Standard vehicle (D)*	924 (36.4)
Rear tailgate	
- Maximum aperture height	650 (25.6)
- Maximum aperture width	980 (38.6)
- Load sill height (unladen)	691 (27.2)

* = Without optional load floor mat

Loadspace volume

VDA method	cu.m (cu.ft)
All models	0.92 (32.5)

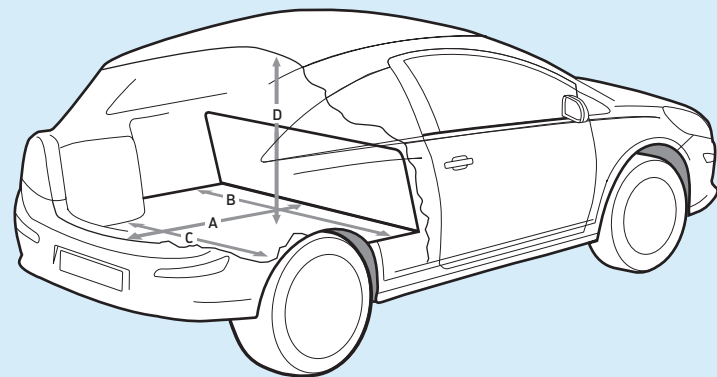

Trust Vauxhall

Protecting the environment

Vauxhall's commitment to the environment is demonstrated by our products' many environmental awards, won both through the use of more recycled materials and by becoming cleaner and more efficient. For information on Vauxhall's efforts to achieve an environmentally sustainable future, see www.vauxhall.co.uk/recycling

Fleet Customer Services

Our dedicated support services for fleet managers includes factory demonstrators and information on whole life costs, company car and van taxation and finance. For further information please call **0870 010 0651**.

Sureguard protection

Sureguard Assistance offers the benefits of Vauxhall Assistance for three years from first registration, while Sureguard Warranty also provides a parts and labour warranty for high-mileage or long-term owners. For details contact your local Vauxhall retailer or call **0870 752 7020**.



When you have finished with this brochure please recycle it

Business Lease

Business Lease, from GMAC, offers the versatility of a purchase-based finance plan, while making the most efficient use of tax and cash-flow benefits for VAT-registered business users. It's available for all Vauxhall Commercial Vehicles up to 12 months old and offers highly flexible term lengths, variable deposits and a choice of payment profiles. Ask your retailer for full details.

Business First

Available to business users only, Business First enables you to drive a new vehicle without a large, initial financial outlay. You pay to use the vehicle, not to own it. The vehicle is provided over a predetermined period, and when that period comes to an end the vehicle is returned. Ask your retailer for full details.

Servicing and maintenance

The best way to maximise the performance and reliability of your Vauxhall is to have all routine servicing and maintenance carried out at a Vauxhall Commercial Vehicle retailer. There are over 200 light commercial vehicle and 120 heavy commercial vehicle retailers nationwide.

In the event of an accident...

Vauxhall Accident Support helps keep you mobile following an accident. Benefits include scene-of-accident advice, message service, assistance with claims and vehicle recovery. For further details call **0800 010 304**.

Premier Service Centres

Our Premier Service Centres feature a guaranteed same day repair service (provided the parts are in stock) and an appointment-free service for diagnosis and repairs taking less than 90 minutes. All repairs are carried out within 24 hours of diagnosis, while suitable alternative transport can be arranged to keep you mobile.*

*= Terms and conditions apply.

For more information...

For a brochure on any Vauxhall model (up to a maximum of three per caller) or location of your nearest retailer, call **0845 600 1500**.

Alternatively, details can be found on our website at: www.vauxhall.co.uk



- Save up to **£1000*** on a new Vauxhall with The GM Card
- 100 Rebate Points worth **£100** when you use The GM Card for the first time
- Rebate Point saving is on top of any discount or offer negotiated with the Retailer
- Earn 3 Rebate Points (**£3**) for every **£100** you spend

Typical 14.9% APR variable

To apply call **0845 746 2777** or visit www.gmcard.co.uk.

The GM Platinum Card is issued by HFC Bank Limited and is available to persons aged 18 years or over and resident in the UK (or 21 and over in the Channel Islands) and is subject to status and conditions. Written quotations are available upon request from The GM Platinum Card, PO Box 3615, Birmingham B3 2RJ. The typical APR quoted is the rate for new customers. *Rebate Points are earned on purchases using The GM Platinum Card. Rebate Points are not earned on Balance Transfers or Cash Advances. You earn money off a new Vauxhall/Saab by accumulating Rebate Points under the Rebate Points Programme. Vauxhall Motors Ltd is solely responsible for the operation of the Rebate Points Programme, which is subject to the Rebate Points Programme Rules. You can redeem up to 2500 Rebate Points subject to the Model Line Maximum which will vary in amount in relation to different Vauxhall/Saab vehicle model lines and unlimited Partner Points. Rebate Points and unlimited Partner Points are redeemable as discounts on a new Vauxhall/Saab vehicle and must be redeemed four years from the issue date. Rebate Points may not be redeemed by Motability Contract Hire customers. The GM Card is a trading name and style of both HFC Bank Limited and Vauxhall Motors Ltd. HFC Bank registered in England No. 1117305. Registered Office: North Street, Winkfield, Windsor, Berkshire SL4 4TD is authorised and regulated by the Financial Services Authority. **Member HSBC Group**. HFC Bank Limited is not a member of the same group of companies as Vauxhall Motors Ltd, Saab GB Limited or GMAC UK plc. Vauxhall Motors Ltd, Registered Office: Griffin House, Osborne Road, Luton, Bedfordshire LU1 3YT. Registered in England number 135767. - CN6/0987.

Every effort has been made to ensure that the contents of this publication were accurate and up-to-date at the time of going to press (March 2008). Vauxhall vehicles are equipped with components manufactured by various General Motors operating units and outside suppliers. The Company reserves the right to alter specifications and withdraw products from sale without notice. Any such alterations will be notified to Vauxhall retailers at the earliest opportunity, please consult your local retailer for the latest information. The specifications detailed within this brochure are not necessarily applicable to alternative models such as Special Editions. Details of any such models will be contained in specific literature or found on the Vauxhall website. Please note that Vauxhall retailers are not the agents of Vauxhall Motors Limited and are not authorised to bind the Company by any specific or implied undertaking or representation. It is advisable to ensure that your motor insurance policy provides adequate cover for additional fitted options and accessories. As part of Vauxhall's policy of environmental care, this brochure is printed on paper manufactured using Elemental Chlorine Free pulps from specially farmed, sustainable timber resources. All rights reserved. No part of this publication may be reproduced in any form or by any means, without the prior written permission of Vauxhall Motors Limited.



The Wheels of Business