

# MOKKA X

## PRICE/SPECIFICATION GUIDE

9 May 2018 | Model Year 2018.5



### Contents:

Model Year 2018.5 (pages 2-27)

Pre-current Model Year (pages 29-48)



**VAUXHALL**

# MOKKA X RANGE HIGHLIGHTS



## ACTIVE OTR from £22,035

*Standard features include:*

**OnStar:**

- Automatic crash response / Wi-Fi hotspot / smartphone app / stolen vehicle assistance / vehicle diagnostics

**Infotainment:**

- R4.0 IntelliLink system
  - Smartphone projection, Apple CarPlay™ and Android Auto™
  - 7-inch colour touchscreen
  - AM/FM/digital radio
  - Bluetooth® audio streaming
  - Bluetooth® mobile phone portal
  - USB connection with iPod control
  - Aux-in socket

**Interior convenience / styling:**

- Dual-zone electronic climate control
- Cruise control with speed limiter
- Leather-covered steering wheel
- Steering column adjustable for reach and rake
- Steering wheel mounted audio controls

**Exterior convenience / styling:**

- Silver-effect 17-inch alloy wheels (engine dependent)
- Silver-effect 18-inch alloy wheels (engine dependent)
- Silver-effect roof rails
- Alloy-effect protective front skid plate
- Auto lighting / windscreen wipers

**Safety / security:**

- Switchable electronic stability programme
- Anti-lock braking system
- Traction control
- Hill start assist
- Front / rear parking distance sensors
- LED daytime running lights

17-inch



18-inch



## DESIGN NAV OTR from £20,035

*Features over Active:*

**Infotainment:**

- Navi 900 IntelliLink system
  - Fully integrated European satellite navigation system
  - 8-inch colour touchscreen

17-inch





18-inch



# MOKKA X RANGE HIGHLIGHTS



<b>ELITE</b>	<b>OTR from £24,535</b>
<i>Features over Active:</i>	
<b>Interior convenience / styling:</b>	
<ul style="list-style-type: none"> <li>• Leather seat facings</li> <li>• Ergonomic sports front seats</li> <li>• Electrically heated front seats</li> <li>• Electrically heated steering wheel</li> <li>• Rear seat centre armrest with drinks holders</li> </ul>	
<b>Exterior convenience / styling:</b>	
<ul style="list-style-type: none"> <li>• Multi-spoke 18-inch alloy wheels (engine dependent)</li> <li>• Dark-tinted rear windows</li> <li>• Alloy-effect door sill covers</li> <li>• Chrome-effect side window trim</li> </ul>	
<b>4X4 models additionally feature:</b>	
<ul style="list-style-type: none"> <li>• Intelligent four-wheel drive</li> <li>• Descent control system</li> </ul>	
<b>ELITE NAV</b>	<b>OTR from £25,235</b>
<b>Elite Nav models additional feature:</b>	
<ul style="list-style-type: none"> <li>• Navi 900 IntelliLink system                             <ul style="list-style-type: none"> <li>– Fully integrated European satellite navigation system</li> <li>– 8-inch colour touchscreen</li> </ul> </li> </ul>	<p>17-inch</p> 
	<p>18-inch</p> 
	

<b>ULTIMATE</b>	<b>OTR from £27,485</b>
<i>Features over Active:</i>	
<b>Interior convenience / styling:</b>	
<ul style="list-style-type: none"> <li>• Leather seat facings</li> <li>• Ergonomic sports front seats</li> <li>• Electrically heated front seats</li> <li>• Electrically heated steering wheel</li> <li>• Rear seat centre armrest with drinks holders</li> </ul>	
<b>Exterior convenience / styling:</b>	
<ul style="list-style-type: none"> <li>• 19-inch 5 twin-spoke alloy wheels</li> <li>• Premium Sport Line Pack                             <ul style="list-style-type: none"> <li>– Dark-effect front and rear lower bumper inserts</li> <li>– Silver-effect side sills</li> </ul> </li> <li>• Dark-tinted rear windows</li> <li>• Alloy-effect door sill covers</li> <li>• Chrome-effect side window trim</li> </ul>	
<b>Infotainment:</b>	
<ul style="list-style-type: none"> <li>• Navi 900 IntelliLink system                             <ul style="list-style-type: none"> <li>– Fully integrated European satellite navigation system</li> <li>– 8-inch colour touchscreen</li> </ul> </li> </ul>	
<b>4X4 models additionally feature:</b>	
<ul style="list-style-type: none"> <li>• Intelligent four-wheel drive</li> <li>• Descent control system</li> </ul>	
	<p>19-inch</p> 
	







# MOKKA X ACTIVE

5-door SUV  
OTR RRP CO<sub>2</sub> (g/km)

## ACTIVE – ON-THE-ROAD PRICES

Petrol	1.4i Turbo (140PS) Start/Stop ECOTEC FWD	£22,035	150
	1.4i Turbo (140PS) auto FWD	£23,260	162
Diesel	1.6CDTi (136PS) Start/Stop ECOTEC BlueInjection FWD	£23,720	127
	1.6CDTi (136PS) auto BlueInjection FWD	£24,905	149

Please note: On-the-road recommended retail prices (RRP) include VAT at 20%, number plates and delivery to Retailer of £700.00 (inc. £116.67 VAT), 12 months' Vehicle Excise Duty and new vehicle first registration fee of £55.00. Excludes fuel and insurance.

KEY OPTIONS		Total inc. VAT
	<b>Looking good:</b> Brilliant paint	£285
	Metallic paint	£565
	Two-coat premium paint	£655
	Tri-coat premium paint	£725
	19-inch 5-twinspoke alloy wheels	£610
	<b>Easier parking:</b> Rear-view camera	£285
	<b>Sitting comfortably:</b> Winter Pack	£280
	<b>Fresh air:</b> Power tilt and slide glass sunroof with manually operated sunblind	£505
	<b>Driving assistance:</b> <b>Premium LED Adaptive Forward Lighting (AFL)</b> <i>Six LED elements light the road 30% brighter than halogen, allowing you to see hazards sooner and giving you more time to react. The AFL system uses data such as vehicle speed, steering angle and when the indicators are used to determine the most suitable lighting.</i>	£1160
	<b>Practicality:</b> Steel emergency spare wheel (in lieu of emergency tyre inflation kit)	£110
	Navi 900 IntelliLink touchscreen navigation and infotainment system	£710

For details of these and other options please see Features/Options pages.



## FEATURES

### OnStar:

- Automatic crash response / Wi-Fi hotspot / smartphone app / stolen vehicle assistance / vehicle diagnostics

### Infotainment:

- R4.0 IntelliLink system
  - Smartphone projection, Apple CarPlay™ and Android Auto™
  - 7-inch colour touchscreen
  - AM/FM/digital radio
  - Bluetooth® audio streaming
  - Bluetooth® mobile phone portal
  - USB connection with iPod control
  - Aux-in socket

### Interior convenience / styling:

- Dual-zone electronic climate control
- Cruise control with speed limiter
- Multi-function trip computer
- Leather-covered steering wheel
- Steering column adjustable for reach and rake
- Steering wheel mounted audio controls
- Auto anti-dazzle rear-view mirror
- Front driver's armrest
- 60/40 split flip and fold rear seat
- 12-volt rear power outlet behind front seats

### Exterior convenience / styling:



- Silver-effect 17-inch alloy wheels (engine dependent)
- Silver-effect 18-inch alloy wheels (engine dependent)

- Alloy-effect protective front skid plate
- Side-protection mouldings
- Silver-effect roof rails
- Front fog lights
- High beam assist
- Auto lighting / windscreen wipers
- Electrically foldable door mirrors
- Electrically adjustable/heated door mirrors
- Electrically operated front and rear windows
- Remote control central locking
- Stainless steel exhaust tailpipe

### Safety / security:

- Switchable electronic stability programme
- Anti-lock braking system
- Traction control
- Hill start assist
- Tyre pressure monitoring system
- Six airbags
- Remote control alarm system
- Front / rear parking distance sensors
- Emergency tyre inflation kit in lieu of spare wheel
- LED daytime running lights





## CUSTOMER OFFERS\*

-  2 Year 0% APR PCP
-  Flexible PCP (5.9% APR) with £3000 Vauxhall Deposit Contribution
-  Flexible Personal Lease

Please consult your Retailer for details.

\* = Terms and conditions apply.

## COMPANY CAR INFORMATION

-  P11D price starting at £21,775
-  From 30% tax band\*\*
-  From £113 monthly BiK tax\*\*
-  CO<sub>2</sub> emissions from 127g/km

Please see [www.vauxhall.co.uk/fleet](http://www.vauxhall.co.uk/fleet) for details.

\*\* = 2018/19 tax year.









# MOKKA X DESIGN NAV

5-door SUV  
OTR RRP CO<sub>2</sub> (g/km)

## DESIGN NAV – ON-THE-ROAD PRICES

Engine	Configuration	OTR RRP	CO <sub>2</sub> (g/km)
Petrol	1.4i Turbo (140PS) Start/Stop ECOTEC FWD	£20,035	150
	1.4i Turbo (140PS) auto FWD	£21,260	162
Diesel	1.6CDTi (136PS) Start/Stop ECOTEC BlueInjection FWD	£21,720	127
	1.6CDTi (136PS) auto BlueInjection FWD	£22,915	149

Please note: On-the-road recommended retail prices (RRP) include VAT at 20%, number plates and delivery to Retailer of £700.00 (inc. £116.67 VAT), 12 months' Vehicle Excise Duty and new vehicle first registration fee of £55.00. Excludes fuel and insurance.

KEY OPTIONS		Total inc. VAT
 <b>Looking good:</b>	Brilliant paint	£285
	Metallic paint	£565
	Two-coat premium paint	£655
	Tri-coat premium paint	£725
	19-inch 5-twinspoke alloy wheels	£610
 <b>Easier parking:</b>	Rear-view camera	£285
 <b>Sitting comfortably:</b>	Winter Pack	£280
 <b>Fresh air:</b>	Power tilt and slide glass sunroof with manually operated sunblind	£505
 <b>Driving assistance:</b>	<b>Premium LED Adaptive Forward Lighting (AFL)</b> <i>Six LED elements light the road 30% brighter than halogen, allowing you to see hazards sooner and giving you more time to react. The AFL system uses data such as vehicle speed, steering angle and when the indicators are used to determine the most suitable lighting.</i>	£1160
 <b>Practicality:</b>	Steel emergency spare wheel (in lieu of emergency tyre inflation kit)	£110

For details of these and other options please see Features/Options pages.



## FEATURES

### OnStar:

- Automatic crash response / Wi-Fi hotspot / smartphone app / stolen vehicle assistance / vehicle diagnostics

### Infotainment:

- Navi 900 IntelliLink system
  - Fully integrated European satellite navigation system
  - Smartphone projection, Apple CarPlay™ and Android Auto™
  - 8-inch colour touchscreen
  - AM/FM/digital radio
  - Bluetooth® audio streaming
  - Bluetooth® mobile phone portal
  - USB connection with iPod control
  - Aux-in socket

### Interior convenience / styling:

- Dual-zone electronic climate control
- Cruise control with speed limiter
- Multi-function trip computer
- Leather-covered steering wheel
- Steering column adjustable for reach and rake
- Steering wheel mounted audio controls
- Auto anti-dazzle rear-view mirror
- Front driver's armrest
- 60/40 split flip and fold rear seat
- 12-volt rear power outlet behind front seats

### Exterior convenience / styling:



- Silver-effect 17-inch alloy wheels (engine dependent)

- Silver-effect 18-inch alloy wheels (engine dependent)
- Alloy-effect protective front skid plate
- Side-protection mouldings
- Silver-effect roof rails
- Front fog lights
- High beam assist
- Auto lighting / windscreen wipers
- Electrically foldable door mirrors
- Electrically adjustable/heated door mirrors
- Electrically operated front and rear windows
- Remote control central locking
- Stainless steel exhaust tailpipe

### Safety / security:

- Switchable electronic stability programme
- Anti-lock braking system
- Traction control
- Hill start assist
- Tyre pressure monitoring system
- Six airbags
- Remote control alarm system
- Front / rear parking distance sensors
- Emergency tyre inflation kit in lieu of spare wheel
- LED daytime running lights





## CUSTOMER OFFERS\*

-  Flexible PCP (5.9% APR) with £500 Vauxhall Deposit Contribution
-  Flexible Personal Lease

Please consult your Retailer for details.

\* = Terms and conditions apply.

## COMPANY CAR INFORMATION

-  P11D price starting at £19,755
-  From 30% tax band\*\*
-  From £103 monthly BiK tax\*\*
-  CO<sub>2</sub> emissions from 127g/km





Please see [www.vauxhall.co.uk/fleet](http://www.vauxhall.co.uk/fleet) for details.

\*\* = 2018/19 tax year.

# MOKKA X ELITE

		5-door SUV	
		OTR RRP	CO <sub>2</sub> (g/km)
<b>ELITE – ON-THE-ROAD PRICES</b>			
Petrol	1.4i Turbo (140PS) Start/Stop ECOTEC FWD	£24,535	150
	1.4i Turbo (140PS) auto FWD	£25,760	162
	1.4i Turbo (140PS) Start/Stop 4X4	£26,530	167
Diesel	1.6CDTi (136PS) Start/Stop ECOTEC BlueInjection FWD	£26,220	127
	1.6CDTi (136PS) auto BlueInjection FWD	£27,405	149
	1.6CDTi (136PS) Start/Stop 4X4 BlueInjection	£28,230	146
<b>ELITE NAV – ON-THE-ROAD PRICES</b>			
Petrol	1.4i Turbo (140PS) Start/Stop ECOTEC FWD	£25,235	150
	1.4i Turbo (140PS) auto FWD	£26,460	162
	1.4i Turbo (140PS) Start/Stop 4X4	£27,230	167
Diesel	1.6CDTi (136PS) Start/Stop ECOTEC BlueInjection FWD	£26,920	127
	1.6CDTi (136PS) auto BlueInjection FWD	£28,105	149
	1.6CDTi (136PS) Start/Stop 4X4 BlueInjection	£28,930	146

Please note: On-the-road recommended retail prices (RRP) include VAT at 20%, number plates and delivery to Retailer of £700.00 (inc. £116.67 VAT), 12 months' Vehicle Excise Duty and new vehicle first registration fee of £55.00. Excludes fuel and insurance.

KEY OPTIONS		Total inc. VAT
 <b>Looking good:</b>	Brilliant paint	£285
	Metallic paint	£565
	Two-coat premium paint	£655
	Tri-coat premium paint	£725
	18-inch diamond-cut bi-colour 10-spoke alloy wheels	£220
	19-inch 5-twinspoke alloy wheels	£610
 <b>Easier parking:</b>	Rear-view camera	£285
 <b>Fresh air:</b>	Power tilt and slide glass sunroof with manually operated sunblind	£505
 <b>Driving assistance:</b>	<b>Premium LED Adaptive Forward Lighting (AFL)</b> <i>Six LED elements light the road 30% brighter than halogen, allowing you to see hazards sooner and giving you more time to react. The AFL system uses data such as vehicle speed, steering angle and when the indicators are used to determine the most suitable lighting.</i>	£1160
 <b>Practicality:</b>	Steel emergency spare wheel (in lieu of emergency tyre inflation kit)	£110

For details of these and other options please see Features/Options pages.



## FEATURES

### OnStar:

- Automatic crash response / Wi-Fi hotspot / smartphone app / stolen vehicle assistance / vehicle diagnostics

### Infotainment:

- R4.0 IntelliLink system
  - Smartphone projection, Apple CarPlay™ and Android Auto™
  - 7-inch colour touchscreen
  - AM/FM/digital radio
  - Bluetooth® audio streaming
  - Bluetooth® mobile phone portal
  - USB connection with iPod control
  - Aux-in socket

### Interior convenience / styling:

- Leather seat facings
- Ergonomic heated sports front seats
- Electrically heated steering wheel
- Dual-zone electronic climate control
- Cruise control / trip computer
- Leather-covered steering wheel
- Steering column adjustable for reach and rake
- Steering wheel mounted audio controls
- Auto anti-dazzle rear-view mirror
- Front driver's armrest
- 60/40 split flip and fold rear seat
- 12-volt rear power outlet behind front seats

### Exterior convenience / styling:

- Silver-effect 17-inch alloy wheels (engine dependent)
- Multi-spoke 18-inch alloy wheels (engine dependent)

- Alloy-effect protective front skid plate
- Side-protective mouldings
- Front fog lights
- High beam assist
- Auto lighting / windscreen wipers
- Electrically foldable door mirrors
- Electrically adjustable/heated door mirrors
- Electrically operated front / rear windows
- Remote control central locking
- Stainless steel exhaust tailpipe
- Dark-tinted rear windows
- Alloy-effect door sill covers
- Chrome-effect side window trim

### Safety / security:

- Switchable electronic stability programme
- Anti-lock braking system
- Hill start assist
- Tyre pressure monitoring system
- Six airbags
- Remote control alarm system
- Front / rear parking distance sensors
- Emergency tyre inflation kit in lieu of spare wheel
- LED daytime running lights



### 4X4 models additionally feature:

- Intelligent four-wheel drive
- Descent control system

### Elite Nav models additionally feature:

- Navi 900 IntelliLink system
  - Fully integrated European satellite navigation system
  - 8-inch colour touchscreen





## CUSTOMER OFFERS\*

-  2 Year 0% APR PCP
-  Flexible PCP (5.9% APR) with £3000 Vauxhall Deposit Contribution
-  Flexible Personal Lease

Please consult your Retailer for details.

\* = Terms and conditions apply.

## COMPANY CAR INFORMATION

-  P11D price starting at £24,275
-  From 30% tax band\*\*
-  From £126 monthly BiK tax\*\*
-  CO<sub>2</sub> emissions from 127g/km





Please see [www.vauxhall.co.uk/fleet](http://www.vauxhall.co.uk/fleet) for details.

\*\* = 2018/19 tax year.

# MOKKA X ULTIMATE

		5-door SUV	
		OTR RRP	CO <sub>2</sub> (g/km)
<b>ULTIMATE – ON-THE-ROAD PRICES</b>			
Petrol	1.4i Turbo (140PS) Start/Stop ECOTEC FWD	£27,485	150
	1.4i Turbo (140PS) auto FWD	£28,710	162
	1.4i Turbo (140PS) Start/Stop 4X4	£29,480	167
Diesel	1.6CDTi (136PS) Start/Stop ECOTEC BlueInjection FWD	£29,480	131
	1.6CDTi (136PS) auto BlueInjection FWD	£30,355	149
	1.6CDTi (136PS) Start/Stop 4X4 BlueInjection	£31,180	146

Please note: On-the-road recommended retail prices (RRP) include VAT at 20%, number plates and delivery to Retailer of £700.00 (inc. £116.67 VAT), 12 months' Vehicle Excise Duty and new vehicle first registration fee of £55.00. Excludes fuel and insurance.

KEY OPTIONS		Total inc. VAT
 <b>Looking good:</b>	Brilliant paint	N/C
	Metallic paint	N/C
	Two-coat premium paint	N/C
	Tri-coat premium paint	N/C
 <b>Easier parking:</b>	Rear-view camera	£285
 <b>Fresh air:</b>	Power tilt and slide glass sunroof with manually operated sunblind	£505
 <b>Driving assistance:</b>	<b>Premium LED Adaptive Forward Lighting (AFL)</b> <i>Six LED elements light the road 30% brighter than halogen, allowing you to see hazards sooner and giving you more time to react. The AFL system uses data such as vehicle speed, steering angle and when the indicators are used to determine the most suitable lighting.</i>	£1160
 <b>Practicality:</b>	Steel emergency spare wheel (in lieu of emergency tyre inflation kit)	£110

For details of these and other options please see Features/Options pages.

N/C = No-cost option.



## FEATURES

### OnStar:

- Automatic crash response / Wi-Fi hotspot / smartphone app / stolen vehicle assistance / vehicle diagnostics

### Infotainment:

- Navi 900 IntelliLink system
  - Fully integrated European satellite navigation system
  - Smartphone projection, Apple CarPlay™ and Android Auto™
  - 8-inch colour touchscreen
  - AM/FM/digital radio
  - Bluetooth® audio streaming
  - Bluetooth® mobile phone portal
  - USB connection with iPod control
  - Aux-in socket

### Interior convenience / styling:

- Leather seat facings
- Ergonomic heated sports front seats
- Electrically heated steering wheel
- Dual-zone electronic climate control
- Cruise control / trip computer
- Leather-covered steering wheel
- Steering column adjustable for reach and rake
- Steering wheel mounted audio controls
- Auto anti-dazzle rear-view mirror
- Front driver's armrest
- 60/40 split flip and fold rear seat
- 12-volt rear power outlet behind front seats

### Exterior convenience / styling:

- 19-inch 5 twinspoke alloy wheels
- Premium Sport Line Pack
  - Dark-effect front and rear lower bumper inserts
  - Silver-effect side sills
- Side-protective mouldings
- Front fog lights
- High beam assist
- Auto lighting / windscreen wipers
- Electrically foldable door mirrors
- Electrically adjustable/heated door mirrors
- Electrically operated front / rear windows
- Remote control central locking
- Dark-tinted rear windows
- Alloy-effect door sill covers
- Chrome-effect side window trim



### Safety / security:

- Switchable electronic stability programme
- Anti-lock braking system
- Hill start assist
- Tyre pressure monitoring system
- Six airbags
- Remote control alarm system
- Front / rear parking distance sensors
- Emergency tyre inflation kit in lieu of spare wheel
- LED daytime running lights

### 4X4 models additionally feature:

- Intelligent four-wheel drive
- Descent control system



## CUSTOMER OFFERS\*

-  **2 Year 0% APR PCP**
-  **Flexible PCP (5.9% APR) with £3000 Vauxhall Deposit Contribution**
-  **Flexible Personal Lease**

Please consult your Retailer for details.

\* = Terms and conditions apply.





## COMPANY CAR INFORMATION

-  **P11D price starting at £27,225**
-  **From 31% tax band\*\***
-  **From £141 monthly BiK tax\*\***
-  **CO<sub>2</sub> emissions from 131g/km**

Please see [www.vauxhall.co.uk/fleet](http://www.vauxhall.co.uk/fleet) for details.

\*\* = 2018/19 tax year.

# MOKKA X PRICES

Model 5-door SUV	Price (£)	VAT (£)	Total (£)	On-the-road RRP (£)	CO <sub>2</sub> (g/km)	Model 5-door SUV	Price (£)	VAT (£)	Total (£)	On-the-road RRP (£)	CO <sub>2</sub> (g/km)
<b>ACTIVE</b> 						<b>ELITE NAV</b> 					
1.4i Turbo (140PS) S/S ECOTEC FWD	17562.50	3512.50	21075.00	<b>22035.00</b>	150	1.4i Turbo (140PS) S/S ECOTEC FWD	20229.17	4045.83	24275.00	<b>25235.00</b>	150
1.4i Turbo (140PS) auto FWD	18325.00	3665.00	21990.00	<b>23260.00</b>	162	1.4i Turbo (140PS) auto FWD	20991.67	4198.33	25190.00	<b>26460.00</b>	162
<i>Diesel</i>						<i>Diesel</i>					
1.6CDTi (136PS) S/S ECOTEC						1.4i Turbo (140PS) S/S 4X4	21633.33	4326.67	25960.00	<b>27230.00</b>	167
BlueInjection* FWD**	18966.67	3793.33	22760.00	<b>23720.00</b>	127	<i>Diesel</i>					
1.6CDTi (136PS) auto BlueInjection** FWD	19695.83	3939.17	23635.00	<b>24905.00</b>	149	1.6CDTi (136PS) S/S ECOTEC					
<b>DESIGN NAV</b> 						<b>ULTIMATE</b> 					
1.4i Turbo (140PS) S/S ECOTEC FWD	15895.83	3179.17	19075.00	<b>20035.00</b>	150	1.4i Turbo (140PS) S/S ECOTEC FWD	22104.17	4420.83	26525.00	<b>27485.00</b>	150
1.4i Turbo (140PS) auto FWD	16658.33	3331.67	19990.00	<b>21260.00</b>	162	1.4i Turbo (140PS) auto FWD	22866.67	4573.33	27440.00	<b>28710.00</b>	162
<i>Diesel</i>						<i>Diesel</i>					
1.6CDTi (136PS) S/S ECOTEC						1.4i Turbo (140PS) S/S 4X4	23508.33	4701.67	28210.00	<b>29480.00</b>	167
BlueInjection* FWD**	17300.00	3460.00	20760.00	<b>21720.00</b>	127	<i>Diesel</i>					
1.6CDTi (136PS) auto BlueInjection* FWD	18037.50	3607.50	21645.00	<b>22915.00</b>	149	1.6CDTi (136PS) S/S ECOTEC					
<b>ELITE</b> 						<b>BlueInjection* FWD</b>					
1.4i Turbo (140PS) S/S ECOTEC FWD	19645.83	3929.17	23575.00	<b>24535.00</b>	150	1.6CDTi (136PS) auto BlueInjection* FWD	24237.50	4847.50	29085.00	<b>30355.00</b>	149
1.4i Turbo (140PS) auto FWD	20408.33	4081.67	24490.00	<b>25760.00</b>	162	1.6CDTi (136PS) S/S 4X4 BlueInjection*	24925.00	4985.00	29910.00	<b>31180.00</b>	146
1.4i Turbo (140PS) S/S 4X4	21050.00	4210.00	25260.00	<b>26530.00</b>	167	<i>Diesel</i>					
<i>Diesel</i>						<b>BlueInjection* FWD</b>					
1.6CDTi (136PS) S/S ECOTEC						1.6CDTi (136PS) auto BlueInjection* FWD	24237.50	4847.50	29085.00	<b>30355.00</b>	149
BlueInjection* FWD**	21050.00	4210.00	25260.00	<b>26220.00</b>	127	1.6CDTi (136PS) S/S 4X4 BlueInjection*	24925.00	4985.00	29910.00	<b>31180.00</b>	146
1.6CDTi (136PS) auto BlueInjection* FWD	21779.17	4355.83	26135.00	<b>27405.00</b>	149	<b>BlueInjection* FWD</b>					
1.6CDTi (136PS) S/S 4X4 BlueInjection*	22466.67	4493.33	26960.00	<b>28230.00</b>	146	1.6CDTi (136PS) auto BlueInjection* FWD	24237.50	4847.50	29085.00	<b>30355.00</b>	149
						<b>1.6CDTi (136PS) S/S 4X4 BlueInjection*</b>					
						24925.00 4985.00 29910.00 <b>31180.00</b> 146					

**Please note:** On-the-road recommended retail prices (RRP) include number plates and delivery to retailer of £700.00 (inc. £116.67 VAT), 12 months\* Vehicle Excise Duty and new vehicle first registration fee of £55.00. Excludes fuel and insurance.

S/S = Start/Stop.

\* = Please note: Vehicles with BlueInjection technology will need regular AdBlue® top-ups also between servicing requirements. An indicator integrated into the on-board computer will warn you when you need to top up. More information under [www.vauxhall.co.uk/discover-vauxhall/technology/adblue.html](http://www.vauxhall.co.uk/discover-vauxhall/technology/adblue.html)

\*\* = 17-inch alloy wheels as standard.



# MOKKA X FEATURES/OPTIONS

## SAFETY

### Driver / passenger airbags

- Driver's airbag • Front passenger's airbag • Front seat side-impact airbags
- Full-size curtain airbags for driver, front seat passenger and outer rear seat passengers

### Seating

- Height-adjustable front seat head restraints • Height-adjustable outer rear seat head restraints

### Seatbelts

- Height adjustable front inertia-reel lap and diagonal seatbelts • Three inertia-reel lap and diagonal rear seatbelts • Front body-lock diagonal seatbelt pretensioner system – *Tightens the seatbelt during the early stages of a frontal impact, limiting forward movement.* • Driver's and front passenger's lap belt pretensioner system • Front seatbelt force limiters – *Reduces potential upper body injuries during a frontal impact.* • Front and rear 'seatbelt unfastened' warning light

### Child safety

- Deactivation switch for front passenger's front and side-impact airbags – *Permits the safe use of a child seat in the front passenger seat.* • ISOFIX child seat mountings incorporating top tether anchor points located on outer rear seats (does not include child seat) – *Allows ISOFIX child safety seats to be securely fixed into the car. The ISOFIX mounting system reduces forward movement in an accident and makes the child seat easier to install.*

### Driver / passenger safety

- Energy-absorbing steering column • Pedal release system – *Reduces potential injury to the driver's legs and feet during a severe frontal impact.* • Laminated windscreen • Side-impact protection beams • Reinforced passenger safety cell • Deformation zones front and rear
- Burst-proof door locks and anti-jam door design

### Pedestrian safety

- Collapsible windscreen wiper system – *Designed to reduce pedestrian head injuries.*
- Upper and lower bumper design – *Reduces upper and lower leg injuries.*

### Stability

#### Switchable Electronic Stability Programme (ESP):

– Works in conjunction with the vehicle's electronic braking and engine systems to keep the car stable in many different situations. ESP monitors many different inputs to determine when the car starts to lose traction, it can then immediately respond by varying the brake pressure between up to three wheels and adjust the engine output to help correct the loss of traction and improve stability.

#### Additional ESP features:

- Cornering brake control • Straight line stability control
- Descent control system (4X4 models only) • Rollover mitigation
- Traction control

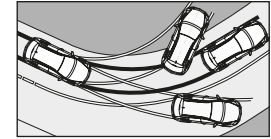

### Braking

#### Anti-lock Braking System (ABS):

– Prevents the vehicle's wheels from locking up under heavy braking by momentarily reducing brake pressure at the appropriate wheel, ensuring that you can maintain control of the steering.

#### Additional braking features:

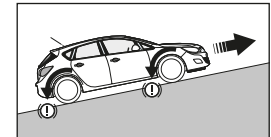

- The same electronic systems used in the ABS and ESP also deliver exceptional braking performance.
- Emergency brake assist – *When emergency braking is detected the vehicle automatically applies the maximum possible braking assistance.* • Electronic brakeforce distribution – *Automatically apportions the optimum braking force to each wheel.* • Adaptive brake lights – *Automatically warns other road users of heavy braking.* • Hill start assist – *Briefly maintains rear brake pressure to stop the vehicle rolling back on an incline.* • Hazard warning lights



### Tyre pressure

- Tyre pressure monitoring system

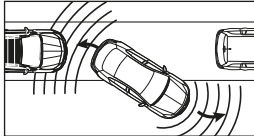
# MOKKA X FEATURES/OPTIONS

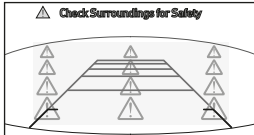
<b>DRIVER ASSISTANCE</b>		Active	Design Nav	Elite	Ultimate	Price (£) exc. VAT	Total (£) inc. VAT
<b>Steering</b>	<ul style="list-style-type: none"> <li>Speed-sensitive power-assisted steering</li> </ul>	●	●	●	●		
<b>Cruise control with speed limiter</b>	<p>The cruise control feature enables you to maintain a constant speed – making it ideal for economical motorway driving.</p> <p>The speed limiter function can be set to ensure that you do not exceed the speed limit and can be easily overridden if required.</p> <ul style="list-style-type: none"> <li>Steering wheel mounted controls</li> </ul>	●	●	●	●		
<b>Parking sensors</b>	<ul style="list-style-type: none"> <li>Front and rear parking distance sensors</li> <li>Audible warning</li> </ul> <p> <b>Easier parking</b></p>		●	●	●	●	
<b>Rear-view camera</b>	<p>The rear-view camera gives a clear view of the area behind your car and helps place the car perfectly, without needing to strain your neck.</p> <ul style="list-style-type: none"> <li>Activated when reverse gear selected</li> <li>Camera view appears in infotainment screen</li> <li>Rear bumper and one-metre grid lines shown as reference points.</li> </ul> <p> <b>See what's behind you on the central screen</b></p>		○	○	○	○	237.50 <b>285.00</b>

● = Standard equipment. ○ = Optional at extra cost.

# MOKKA X FEATURES/OPTIONS

	Active	Design Nav	Elite	Ultimate	Price (£) exc. VAT	Total (£) inc. VAT
<b>SECURITY</b>						
<b>Standard security features</b> • Electronically protected audio equipment • Engine deadlock immobiliser • Visible Vehicle Identification Number (VIN) • Locking wheel nuts • Foldable luggage area cover	●	●	●	●		
<b>Remote control central locking</b> • Operates on doors, tailgate and fuel filler flap • Deadlocking • Driver's internal central locking activation switch • One folding key/one static key each with integral remote control function	●	●	●	●		
<b>Remote control security alarm system</b> • Remote control (operates in conjunction with central locking)	●	●	●	●		
<b>DRIVER INFORMATION</b>						
<b>Instrumentation</b> • Speedometer • Rev counter • Fuel gauge with low fuel level warning light • Water temperature gauge with warning light • Shift-up indication light (manual models only) – <i>Indicates when to change gear for optimum fuel economy.</i>	●	●	●	●		
<b>Driver information display (centrally located in instrument cluster)</b> • Monochrome display • Displays trip computer data • Total mileage • Service-due indicator • Oil life • Tyre pressure monitoring system	●	●	●	●		
<b>Driver information display with ECOTEC Drive Assist (Start/Stop models only):</b> <i>Includes information on which electrical items are using the most energy, fuel consumption statistics for the last 30 miles and when to change gear to help maximise economy.</i>	●	●	●	●		
Enhanced colour driver information display	○	○	○	○	66.67	80.00
<b>Multi-function trip computer (displayed on driver information display)</b> • Trip mileage • Vehicle range based on remaining fuel • Average speed • Average fuel economy • Instantaneous fuel economy	●	●	●	●		
<b>Central fascia display (format dependent on infotainment unit)</b> • Audio information • Digital clock with automatic RDS time adjustment • Outside air temperature with ice warning function • Additional features dependent on infotainment unit (see infotainment for details)	●	●	●	●		

● = Standard equipment. ○ = Optional at extra cost.

# MOKKA X FEATURES/OPTIONS

<b>INTERIOR STYLING</b>	Active	Design Nav	Elite	Ultimate	Price (£) exc. VAT	Total (£) inc. VAT
<b>Active interior décor</b> Steering wheel: • Three-spoke design • Leather-covered • Satin chrome-effect bezel Facia and door trim: • Black facia • Black door panels with black Atlantis cloth inserts • Chrome-effect interior door handles Seat trim: • Milano fabric seat trim inserts • Plain black fabric side bolsters and surrounds	●					
<b>Design Nav interior décor</b> Steering wheel: • Three-spoke design • Leather-covered • Satin chrome-effect bezel Facia and door trim: • Black facia • Black door panels with black Atlantis cloth inserts • Chrome-effect interior door handles Seat trim: • Milano fabric seat trim inserts • Plain black fabric side bolsters and surrounds		●				
<b>Elite/Ultimate interior décor with Black Jasmin leather seat trim</b> Steering wheel: • Three-spoke design • Leather-covered • Satin chrome-effect bezel Facia and door trim: • Black facia • Black door panels with black leather-effect inserts • Chrome-effect interior door handles Seat trim: • Black Jasmin leather seat trim inserts • Black leather-effect side bolsters and surrounds Front door sill covers: • Alloy-effect			●	●		
<b>Elite/Ultimate interior décor with Morello Red Jasmin leather seat trim (not available with Aegean Blue, Lava Red, Boracay Blue and Amber Orange exterior colours)</b> Steering wheel: • Three-spoke design • Leather-covered • Satin chrome-effect bezel Facia and door trim: • Black facia • Black door panels with black leather-effect inserts • Chrome-effect interior door handles Seat trim: • Morello Red Jasmin leather seat trim inserts • Morello Red leather-effect side bolsters and surrounds Front door sill covers: • Alloy-effect			N/C	N/C	<b>No-cost option</b>	

● = Standard equipment. N/C = No-cost option.









# MOKKA X FEATURES/OPTIONS

<b>INFOTAINMENT</b>	Active	Design Nav	Elite	Ultimate	Price (£) exc. VAT	Total (£) inc. VAT
<b>R4.0 IntelliLink touchscreen infotainment system</b> <i>For use with MP3 players, USB memory sticks, mobile phones and smartphone apps</i> <b>Onboard features:</b> <ul style="list-style-type: none"> <li>• 7-inch colour touchscreen • Digital radio/AM/FM stereo radio with 36 station presets</li> <li>• RDS with Traffic Programme</li> </ul> <b>Media connections:</b> <ul style="list-style-type: none"> <li>• USB connection with iPod control • Aux-in socket • Bluetooth® A2DP audio streaming (Advanced Audio Distribution Profile)</li> </ul> <b>Mobile phone portal:</b> <ul style="list-style-type: none"> <li>• Bluetooth® connectivity • Handsfree calls via steering wheel controls • Vehicle microphone</li> <li>• Phone book access – <i>Contacts/last calls/missed calls etc. are mirrored on IntelliLink's display and are easily navigated using the touchscreen (features dependent on mobile phone).</i></li> </ul> <b>Smartphone interface:</b> <ul style="list-style-type: none"> <li>• Apple CarPlay™ • Android Auto™</li> </ul>	●		●			
<b>Navi 900 IntelliLink touchscreen navigation and infotainment system</b> <i>For use with MP3 players, USB memory sticks, mobile phones and smartphone apps</i> <b>Onboard features:</b> <ul style="list-style-type: none"> <li>• 8-inch colour touchscreen • Digital radio/AM/FM stereo radio with 36 station presets • RDS with Traffic Programme</li> <li>• 60 configurable favourites including contacts, addresses, playlists, radio stations and voice recognition</li> </ul> <b>Navigation features:</b> <ul style="list-style-type: none"> <li>• Satellite navigation system • 3D street level mapping • European coverage</li> </ul> <b>Media connections:</b> <ul style="list-style-type: none"> <li>• USB connection with iPod control • Aux-in socket • Bluetooth® A2DP audio streaming (Advanced Audio Distribution Profile)</li> </ul> <b>Mobile phone portal:</b> <ul style="list-style-type: none"> <li>• Bluetooth® connectivity • Handsfree calls via steering wheel controls • Vehicle microphone</li> <li>• Phone book access – <i>Contacts/last calls/missed calls etc. are mirrored on IntelliLink's display and are easily navigated using the touchscreen (features dependent on mobile phone).</i></li> </ul> <b>Smartphone interface:</b> <ul style="list-style-type: none"> <li>• Apple CarPlay™ • Android Auto™</li> </ul>	○	●	▲	●	591.67	<b>710.00</b>
<b>Bose® Premium Sound System (only available with Navi 900 IntelliLink and optional spare wheel)</b> <ul style="list-style-type: none"> <li>• Six channel amplifier with digital signal processing • Two A-pillar mounted 2.5cm tweeters • Two front door mounted 16.5cm woofers</li> <li>• Two rear door mounted 13cm wide-range speakers • One 13cm Richbass woofer in custom 8-litre bass box in luggage compartment</li> </ul>	○	○	○	○	495.83	<b>595.00</b>
Six speakers (four front, two rear)	●	●	●	●		
Steering wheel mounted audio controls	●	●	●	●		

● = Standard equipment. ○ = Optional at extra cost. ▲ = Standard on Nav models, see pricing page for details.

# MOKKA X FEATURES/OPTIONS

<b>AUDIO, COMMUNICATION AND NAVIGATION</b>						Active	Design Nav	Elite	Ultimate	Price (£) exc. VAT	Total (£) inc. VAT
											
Automatic Crash Response	Wi-Fi Hotspot	Smartphone App	Stolen Vehicle Assistance	Vehicle Diagnostics	Destination Download						
<b>OnStar – your personal on board assistant*</b> Many car brands talk about innovation as soon as they improve their cup holders but this innovative system, now available on selected models**, is revolutionary: 24/7, 365 days a year, OnStar puts you in touch with a trained advisor, not a machine. With OnStar you have access to a host of innovations, from Vehicle Diagnostics and Smartphone Function to a fully integrated 4G Wi-Fi Hotspot†. In the event of an accident, OnStar even automatically calls for help, for an incomparable feeling of safety.						●	●	●	●		
* = Includes 12 months of OnStar services from date of first registration and a 3 month/3 GB Wi-Fi free trial period (whichever comes first) effective from the date the customer accepts the nominated network operator Wi-Fi Ts&Cs. Destination download feature only operates on models fitted with Navi 900 IntelliLink satellite navigation system. ** = The OnStar Services require activation and are subject to mobile network coverage and availability. Wi-Fi Hotspot service requires account with nominated network operator. † = 4G is subject to mobile network coverage and availability. Charges apply after the free trial period. The OnStar subscription packages could be different from the services included in the free trial package. Check www.vauxhall.co.uk/onstar for terms and conditions, details of availability, coverage and charges.											
											
<b>OnStar – delete standard-fit</b> – Please note, cannot be deleted retrospectively and must be selected at time of ordering.						N/C	N/C	N/C	N/C	No-cost option	

## SEATING AND COMFORT

Reach and rake adjustable steering	●	●	●	●		
<b>Comfort front seats</b>						
Driver's seat (eight-way adjustable): • Height (up/down) • Reach (fore/aft) • Backrest recline (upright/incline) • Head restraint (up/down)	●	●				
Front passenger's seat (six-way adjustable): • Reach (fore/aft) • Backrest (upright/recline) • Head restraint (up/down)						
<b>Ergonomic sports-style front seats (AGR-approved†) featuring Jasmin Leather</b>						
Driver's and front passenger's seat (18-way adjustable): • Height (up/down) • Reach (fore/aft) • Tilt (electrical fore/aft)			●	●		
• Backrest (upright/recline) • Seat cushion extension (fore/aft) • Lumbar adjustment (four-way electrical) • Head restraint (up/down/fore/aft)						
• Heated front seats			●	●		
<b>Ergonomic sports-style front driver's seat (AGR-approved†)</b>	○	○				275.00 330.00
<b>Rear seating</b>						
• Three-person layout • 60/40 split flip and fold rear seat • Height-adjustable and removable outer seat head restraints						
• ISOFIX child seat mountings incorporating top tether anchor points located on outer rear seats (does not include child seat)	●	●	●	●		
– Allows ISOFIX child safety seats to be securely fixed into the car. The ISOFIX mounting system reduces forward movement in an accident and makes the child seat easier to install. • Child-proof locks on rear doors						
Centre rear seat head restraint			●	●		

● = Standard equipment. ○ = Optional at extra cost. N/C = No-cost option.

All OnStar services and Wi-Fi services will cease to be available on 31 December 2020. No trial or paid subscriptions or services, including emergency response services, will be available after that date.

† = AGR (The Campaign for Healthier Backs) is an independent centre of excellence for ergonomics, based in Germany.

# MOKKA X FEATURES/OPTIONS

	Active	Design Nav	Elite	Ultimate	Price (£) exc. VAT	Total (£) inc. VAT
<b>HEATING AND VENTILATION</b>						
<b>Electronic climate control including air conditioning</b> <ul style="list-style-type: none"> <li>• Dual-zone control – <i>Allowing different temperature settings for driver and front passenger.</i></li> <li>• Advanced predictive logic control system using humidity sensors</li> <li>• Partial air recirculation – <i>Faster warm up/cool down</i> • Cabin particulate filter – <i>Removes dust, airborne particles and pollen.</i></li> <li>• Automatic air direction and fan speed with manual override • Illuminated controls</li> </ul>	●	●	●	●		
<b>Additional features</b> <ul style="list-style-type: none"> <li>• Four adjustable facia vents • Windscreen demist vents • Side window demist vents</li> <li>• Heated rear screen with timed cut-off</li> </ul>	●	●	●	●		
<b>Winter Pack</b> <ul style="list-style-type: none"> <li>• Heated leather-covered steering wheel • Heated front seats</li> </ul> <div style="display: flex; align-items: center;"> <span>Warm welcome</span> </div> <div style="display: flex; align-items: center; margin-top: 10px;"> </div>	○	○	●	●	233.33	280.00

## INTERIOR CONVENIENCE

<b>Convenience features</b> <ul style="list-style-type: none"> <li>• Front 12-volt electrical accessory socket • Front and rear passenger assist handles</li> </ul>	●	●	●	●
12-volt power outlet behind front seats	●	●	●	●
Driver's and front passenger's illuminated vanity mirrors with flip-up cover	●	●	●	●
Automatically dimming anti-dazzle rear-view mirror	●	●	●	●
Front driver's armrest	●	●	●	●
Rear seat centre armrest with drinks holders			●	●

## INTERIOR LIGHTING

<b>Standard lighting</b> <ul style="list-style-type: none"> <li>• Courtesy lighting operated by door switches</li> </ul>	●	●	●	●
---	---	---	---	---

## INTERIOR STORAGE

<b>Interior storage</b> <ul style="list-style-type: none"> <li>• Illuminated glovebox with lid • Front door pockets • Storage pocket on front passenger's seat back • Two drinks holders in centre console</li> </ul>	●	●	●	●
• Storage pocket on driver's seat back			●	●
• Front passenger's underseat storage tray	●	●		
<b>Luggage area</b> <ul style="list-style-type: none"> <li>• Luggage compartment foldable cover • Illuminated luggage area • Fully carpeted luggage area</li> </ul>	●	●	●	●

● = Standard equipment. ○ = Optional at extra cost.

# MOKKA X FEATURES/OPTIONS

	Active	Design Nav	Elite	Ultimate	Price (£) exc. VAT	Total (£) inc. VAT
<b>MECHANICAL</b>						
Front-wheel drive	●	●	●	●		
Intelligent four-wheel drive (4X4 models only)			▲	▲		
Six-speed manual gearbox	●	●	●	●		
Six-speed automatic transmission	▲	▲	▲	▲		
<b>EXTERIOR LIGHTING</b>						
<b>Standard lighting features</b> <ul style="list-style-type: none"> <li>• LED daytime running lights • Automatic lighting control • Halogen headlights • Lights-on audible warning</li> <li>• Manual headlight beam levelling • High beam assist • High-level LED centre rear brake light • Rear fog light</li> <li>• Reversing light • Hazard warning lights • Door-to-door illumination</li> </ul>	●	●	●	●		
Front fog lights	●	●	●	●		
<b>Premium LED Adaptive Forward Lighting (AFL)</b> Six LED elements light the road 30% brighter than halogen, allowing you to see hazards sooner and giving you more time to react. The AFL system uses data such as vehicle speed, steering angle and when the indicators are used to determine the most suitable lighting. <ul style="list-style-type: none"> <li>• Enhanced colour driver information display • Intelligent main beam control • Automatic headlight levelling • LED tail lights</li> </ul> <b>Every type of driving environment has been considered:</b> <b>Urban light:</b> <i>With street lighting and speeds below 35mph, the system automatically enhances the dipped beam function.</i> <b>Country light:</b> <i>As speeds increase, so does the lighting's performance.</i> <b>Dynamic curve light:</b> <i>At speeds between 25mph and 45mph, and above a set steering angle, extra light is projected onto the relevant side of the road to give you a better view.</i> <b>Static cornering light:</b> <i>At lower speeds, when you indicate and turn the steering above a certain angle, corners and bends are illuminated to match steering inputs.</i> <b>Parking light:</b> <i>When reversing, additional side-facing lights are activated in the headlights.</i> <b>Energy saving mode:</b> <i>On Start/Stop models, the system deactivates the static cornering light function when Start/Stop mode is active.</i> <b>Tourist mode:</b> <i>If you're driving on the continent, switch to Tourist mode and your lights will dip automatically for oncoming traffic.</i> <b>High beam:</b> <i>Powerful down-the-road illumination on top of the LED low beam. Full-on lighting for maximum visibility.</i>	○	○	○	○	966.67	1160.00

● = Standard equipment. ○ = Optional at extra cost. ▲ = See price page for details.













# MOKKA X FEATURES/OPTIONS

	Active	Design Nav	Elite	Ultimate	Price (£) exc. VAT	Total (£) inc. VAT
<b>EXTERIOR CONVENIENCE</b>						
<b>Windscreen wipers</b> • Two-speed windscreen wipers with variable intermittent wipe • Intermittent rear window wash/wipe • Rain-sensitive windscreen wipers	●	●	●	●		
<b>Door mirrors</b> • Twin electrically adjustable/heated door mirrors (wide-angle on driver's side) with automatic timed cut-off • Electrically foldable door mirrors	●	●	●	●		
<b>Windows</b> • Electrically operated front windows with safety autoreverse and one-touch facility • Electrically operated rear windows • Heated rear window	●	●	●	●		
Power tilt and slide glass sunroof with manually operated sunblind	○	○	○	○	420.83	505.00
Roof rails, silver-effect	●	●	●	●		
<b>EXTERIOR STYLING</b>						
<b>Body styling</b> • Alloy-effect protective front skid plate • Side-protection mouldings • Chrome-effect front grille bar • Body-colour door handles • Body-colour door mirrors • Stainless steel exhaust tailpipe	●	●	●	●		
• Chrome-effect side window trim			●	●		
• Alloy-effect door sill covers			●	●		
• Black B-pillars	●	●	●	●		
<b>Premium Sport Line Pack</b> • Dark-effect front and rear lower bumper inserts • Silver-effect side sills				●		
<b>Windows</b> • Solar heat-absorbing windscreen • Tinted windows	●	●	●	●		
• Dark-tinted rear windows	○	○	●	●	237.50	285.00

● = Standard equipment. ○ = Optional at extra cost.





# MOKKA X FEATURES/OPTIONS

<b>EXTERIOR COLOURS</b>		Active	Design Nav	Elite	Ultimate	Price (£) exc. VAT	Total (£) inc. VAT
	<b>Aegean Blue</b> • Solid paint • Folding key with Grey insert • Not available with Morello Red trim	●	●	●	N/C		
	<b>Summit White</b> • Brilliant paint • Folding key with Summit White insert	○	○	○	N/C	237.50	285.00
	<b>Lava Red</b> • Brilliant paint • Not available with Morello Red trim • Folding key with Lava Red insert						
	<b>Sovereign Silver</b> • Two-coat metallic paint • Folding key with Grey insert	○	○	○	N/C	470.83	565.00
	<b>Mineral Black</b> • Two-coat metallic paint • Folding key with Gloss Black insert						
	<b>Boracay Blue</b> • Two-coat metallic paint • Folding key with Summit White insert • Not available with Morello Red trim						
	<b>Amber Orange</b> • Two-coat Premium paint • Not available with Morello Red trim • Folding key with Summit White insert	○	○	○	N/C	545.83	655.00
	<b>Velvet Red</b> • Two-coat Premium paint • Folding key with Grey insert						
	<b>Coppertino</b> • Two-coat Premium paint • Folding key with Black insert						
	<b>Abalone White</b> • Tri-coat premium paint • Folding key with Summit White insert	○	○	○	N/C	604.17	725.00

● = Standard equipment. ○ = Optional at extra cost. N/C = No-cost option.

The colours reproduced may vary slightly from the actual paint colour. As a result they should be used as a guide only. Your Vauxhall Retailer has a comprehensive display of our paint samples.



# MOKKA X FEATURES/OPTIONS

<b>WHEELS AND TYRES</b>		<b>Active</b>	<b>Design Nav</b>	<b>Elite</b>	<b>Ultimate</b>	<b>Price (£) exc. VAT</b>	<b>Total (£) inc. VAT</b>
Steel emergency spare wheel (in lieu of emergency tyre inflation kit)		○	○	○	○	91.67	<b>110.00</b>
	<b>17-inch silver-effect alloy wheels</b> <ul style="list-style-type: none"> <li>• 215/60 R 17 tyres</li> <li>• Emergency tyre inflation kit (in lieu of spare wheel)</li> <li>• Standard on 1.6CDTi (136PS) Start/Stop ECOTEC FWD models only. Not available on other models</li> </ul>	●	●	●			
	<b>18-inch silver-effect alloy wheels</b> <ul style="list-style-type: none"> <li>• 215/55 R 18 tyres</li> <li>• Emergency tyre inflation kit (in lieu of spare wheel)</li> <li>• Standard on all models except 1.6CDTi (136PS) Start/Stop ECOTEC FWD</li> <li>• No-cost option on 1.6CDTi (136PS) Start/Stop ECOTEC FWD models only</li> </ul>	●	●				
		N/C	N/C				<b>No-cost option</b>
	<b>18-inch multi-spoke alloy wheels</b> <ul style="list-style-type: none"> <li>• 215/55 R 18 tyres</li> <li>• Emergency tyre inflation kit (in lieu of spare wheel)</li> <li>• Standard on all models except 1.6CDTi (136PS) Start/Stop ECOTEC FWD</li> <li>• No-cost option on 1.6CDTi (136PS) Start/Stop ECOTEC FWD models only</li> </ul>			●			
				N/C			<b>No-cost option</b>
	<b>18-inch diamond-cut bi-colour 10-spoke alloy wheels</b> <ul style="list-style-type: none"> <li>• 215/55 R 18 tyres</li> <li>• Emergency tyre inflation kit (in lieu of spare wheel)</li> </ul>			○		183.33	<b>220.00</b>

● = Standard equipment. ○ = Optional at extra cost. N/C = No-cost option.



# MOKKA X FEATURES/OPTIONS

## WHEELS AND TYRES

		Active	Design Nav	Elite	Ultimate	Price (£) exc. VAT	Total (£) inc. VAT
	<b>18-inch black 10-spoke alloy wheels</b> • 215/55 R 18 tyres • Emergency tyre inflation kit (in lieu of spare wheel)	<input type="radio"/>	<input type="radio"/>	<input type="radio"/>		183.33	<b>220.00</b>
	<b>19-inch 5-twinspoke alloy wheels</b> • 225/45 R 19 tyres • Emergency tyre inflation kit (in lieu of spare wheel)	<input type="radio"/>	<input type="radio"/>	<input type="radio"/>	<input checked="" type="radio"/>	508.33	<b>610.00</b>

● = Standard equipment. ○ = Optional at extra cost. N/C = No-cost option.

## TYRES RATING

Tyre size	Fuel efficiency group	Wet grip performance	External noise	
			Measured (dB)	Group
215/60 R 17	B-C	B	71	
215/55 R 18	E	B	71	
225/45 R 19	E	A	71	

Tyre rating according to EU Regulation 1222/2009



# MOKKA X SPECIFICATIONS

## PETROL ENGINE

1.4i Turbo (140PS)	
Capacity	1364cc
Maximum power	140PS (103kW) @ 4900-6000rpm
Maximum torque	200Nm (147 lb.ft.) @ 1850-4900rpm
Configuration	4 cylinders, 4 valves per cylinder, double overhead camshafts
Fuel/induction system	Turbocharger with intercooler. Variable Valve Timing. Multi-point sequential fuel injection
Emission compliance	Euro 6.2
Service interval	20,000 miles or 1 year (whichever occurs sooner)

## DIESEL ENGINE

1.6CDTi (136PS)	
Capacity	1598cc
Maximum power	136PS (100kW) @ 3500-4000rpm
Maximum torque	320Nm (236 lb.ft.) @ 2000-2250rpm
Configuration	4 cylinders, 4 valves per cylinder, double overhead camshafts
Fuel/induction system	Variable geometry turbocharger with intercooler. Common rail fuel injection
Emission compliance	Euro 6.2 with Diesel Particulate Filter
Service interval	20,000 miles or 1 year (whichever occurs sooner)

## PERFORMANCE, FUEL ECONOMY AND EMISSIONS

	Wheel size (inches)	Performance (manufacturer's figures)		Urban driving	Fuel economy mpg (litres/100km) <sup>#</sup>		CO <sub>2</sub> emissions g/km <sup>#</sup>	Vehicle Excise Duty*		Benefit in kind company car taxation rates – 2018/19 tax year
		Maximum speed (mph)	Acceleration 0-60mph (sec)		Extra-urban driving	Combined figure		First year rate	Standard rate	
<b>Petrol models</b>										
1.4i Turbo (140PS) S/S ECOTEC FWD	18/19	122	9.3	34.0 (8.3)	50.4 (5.6)	42.8 (6.6)	150	£205	£140	31%
1.4i Turbo (140PS) auto FWD	18/19	119	10.1	31.7 (8.9)	46.3 (6.1)	39.8 (7.1)	162	£515	£140	33%
1.4i Turbo (140PS) S/S 4X4	18/19	116	9.3	30.4 (9.3)	46.3 (6.1)	38.7 (7.3)	167	£515	£140	34%
<b>Diesel models</b>										
1.6CDTi (136PS) S/S BlueInjection ECOTEC FWD	17	118	9.3	51.4 (5.5)	62.8 (4.5)	57.7 (4.9)	127	£205	£140	30%
1.6CDTi (136PS) S/S BlueInjection FWD	18/19	118	9.3	50.4 (5.6)	60.1 (4.7)	56.5 (5.0)	131	£515	£140	31%
1.6CDTi (136PS) auto BlueInjection FWD	18/19	117	10.3	39.8 (7.1)	57.7 (4.9)	49.6 (5.7)	149	£515	£140	34%
1.6CDTi (136PS) S/S 4X4 BlueInjection	18/19	116	9.7	44.8 (6.3)	54.3 (5.2)	50.4 (5.6)	146	£515	£140	34%

\* = Correct at time of publication. FWD = Front-wheel drive.

<sup>#</sup> = Fuel consumption information is official government environmental data, tested in accordance with the relevant EU directive. Official EU-regulated test data is provided for comparison purposes and actual performance will depend on driving style, road conditions and other non-technical factors.

# MOKKA X SPECIFICATIONS

## TRANSMISSIONS

### Six-speed manual gearbox:

All models

### Six-speed automatic transmission with Active Select function:

Available at extra cost on 1.4i (140PS) and 1.6CDTi (136PS) front-wheel drive models. Electronically controlled with adaptive driving function and fuel-saving eco mode. Fluid drive with torque converter, lock-up clutch and Active Select.

### Intelligent 4X4

Electronically controlled four-wheel drive with variable torque split between front and rear axles.

- Torque transfer device: When pulling away from standstill, or under acceleration, more power is diverted to the rear wheels for maximum grip
- Electronic limited-slip differential: Fitted to the rear axle, it can transfer up to 50% of the rear axle torque between the rear wheels

## STEERING

- Speed-sensitive power-assisted steering
- Turning circle (wall-to-wall): 11.50m (37.7ft)

## SUSPENSION

**Front:** Independent. Lightweight MacPherson struts with gas-pressure dampers and coil springs. Anti-roll bar.

**Rear:** Torsion beam with coil springs and gas-pressure dampers.

## BRAKING AND STABILITY

- Switchable Electronic Stability Programme (ESP)
- Cornering brake control
- Straight line stability control
- Rollover mitigation
- Traction control
- Hill start assist
- Anti-lock Braking System (ABS)
- Emergency brake assist
- Electronic brakeforce distribution
- Adaptive brake lights
- Hazard warning lights

### All models

Front ventilated discs: 300mm diameter

Rear discs: 268mm diameter

## BODY

- Aerodynamic drag co-efficient: Cd 0.35

## FUEL TANK CAPACITY

- 53 litres (11.7 gallons)

## ADBLUE TANK CAPACITY

- 9.6 litres (2.1 gallons)

## INSURANCE GROUPS

	Active	Design Nav	Elite	Elite Nav	Ultimate
1.4 Turbo (140PS) S/S ECOTEC FWD	14E	13E	14E	14E	15E
1.4 Turbo (140PS) auto FWD	14E	13E	14E	14E	15E
1.4 Turbo (140PS) S/S 4X4	–	–	14E	14E	15E
1.6CDTi (136PS) S/S ECOTEC BlueInjection FWD	15E	14E	15E	15E	16E
1.6CDTi (136PS) S/S auto BlueInjection FWD	15E	14E	15E	15E	16E
1.6CDTi (136PS) S/S 4X4 BlueInjection FWD	–	–	15E	15E	16E

# MOKKA X SPECIFICATIONS

## EXTERIOR DIMENSIONS millimetres (inches)

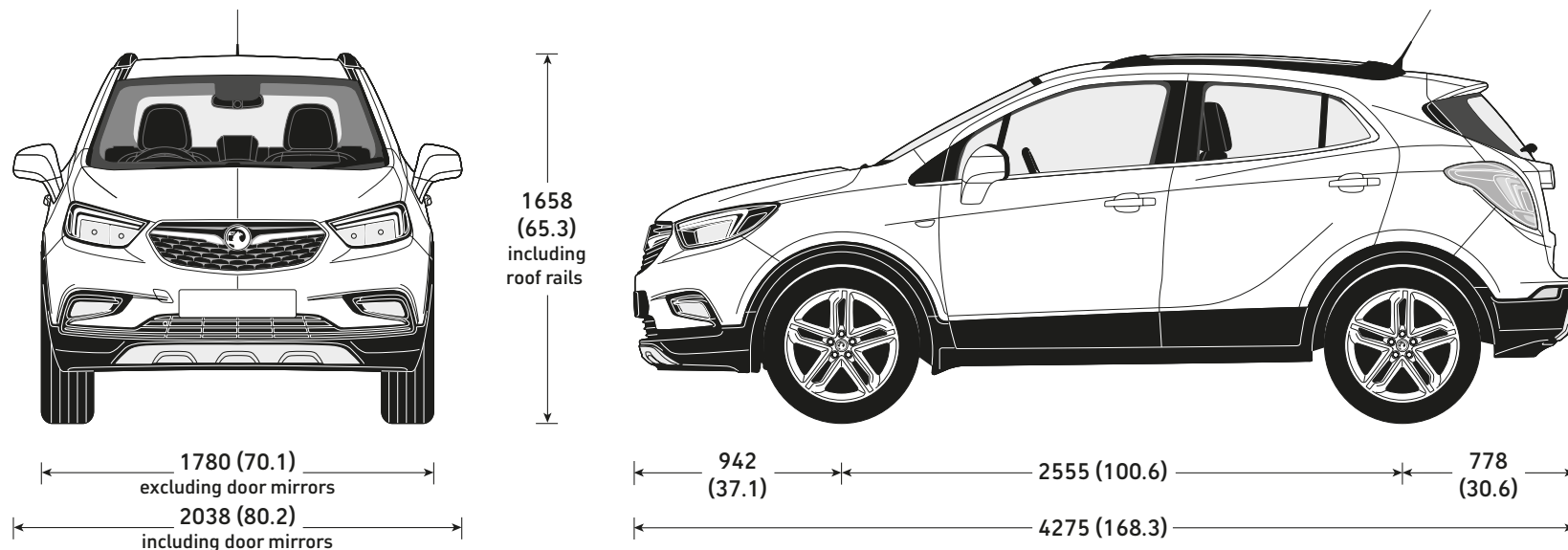

## WEIGHTS AND TOWING DATA kg

	Gross vehicle weight	Max. towing weights Trailer with brakes (without brakes)
1.4i Turbo (140PS) ECOTEC FWD	1828	1200 (500)
1.4i Turbo (140PS) FWD automatic	1843	1200 (500)
1.4i Turbo (140PS) 4X4	1879	1200 (500)
1.6CDTi (136PS) ECOTEC FWD manual	1883	1500 (500)
1.6CDTi (136PS) FWD automatic	1896	1500 (500)
1.6CDTi (136PS) 4X4	1938	1500 (500)

FWD = Front-wheel drive.

Gross vehicle weight is the total permissible weight of the vehicle including passengers and their luggage. The maximum roof rack loading should not exceed 75kg. The maximum towing weights are based on the ability of the car, with two occupants of 75kg each, to restart on a 12% gradient, which is approximately 1 in 8.3, at sea level. At altitudes above 1500 metres, the engine output may drop with a corresponding reduction in towing capability. Any extra weight, such as luggage or additional passengers, should be deducted from the maximum towing weight. With a trailer fully loaded maximum noseweight should not exceed 75kg. Always fit Vauxhall towing attachments and accessories available from your Vauxhall Retailer. They are designed specifically for Vauxhall models and carry a 12-month guarantee.

## LOADSPACE DIMENSIONS millimetres (inches)

Maximum length (behind rear seats)	731 (28.8)
Maximum length (rear seats folded)	1428 (56.2)
Maximum width	1006 (39.6)
Width between wheel arches	915 (36.0)
Maximum height	808 (31.8)

## LOADSPACE CAPACITIES\* litres (cu.ft.)

Rear seats up (under luggage compartment cover)	356 (12.6)
Rear seats folded (to upper edge of front seat back)	785 (27.7)
Rear seats folded (to roof)	1305 (46.1)

\* = Measured using the ECIE method.

# MOKKA X OFFERS IN DETAIL – TERMS AND CONDITIONS

Unless otherwise stated, all offers described are available on orders or registrations between 3 April 2018 – 2 July 2018. Offer prices quoted are correct at the time of publication (April 2018). Prices are subject to change. In line with Vauxhall's policy of price transparency, the offer price shown is an on-the-road price including VAT, number plates and delivery to Retailer of £700.00 (including £116.67 VAT), 12 months' Government Vehicle Excise Duty (variable depending upon model) and the DVLA's new vehicle first registration fee of £55.00. Excludes fuel and insurance. Offers may not apply to Retailer stocks and are subject to availability. Restrictions may apply. Contact your Retailer for details. Vauxhall Motors Limited reserves the right to change, amend or withdraw these offers at any point in time.

## 2 YEAR 0% APR PCP

Offer subject to availability, on selected models at participating Retailers only. Personal Contract Purchase. Finance subject to status, Ts&Cs apply. Applicants must be 18+. Finance by Vauxhall Finance, CF15 7YT. 25 month term. Monthly payment has been calculated using a price which includes Vauxhall and/or Retailer contribution where applicable. At the end of the agreement there are three options: i) Retain: Pay the optional final payment to own the vehicle, ii) Return the vehicle, or iii) Replace: Part Exchange the vehicle where equity is available. Offer applies to private individuals, Vauxhall Partners and small businesses 1-24 units. Orders or registrations from 3 April 2018 to 2 July 2018.

## FLEXIBLE PCP

Offer subject to availability at participating Retailers only. Personal Contract Purchase. Finance subject to status. Terms and Conditions apply. Applicants must be 18+. Finance by Vauxhall Finance, CF15 7YT. 24-48 month term available. Vauxhall deposit contribution only available when vehicle financed through Vauxhall Finance. At the end of the agreement there are three options: i) Pay the optional final payment to own the vehicle, ii) Return the vehicle, or iii) Replace: Part Exchange the vehicle, where equity is available. UK-supplied vehicles only. Offer applies to private individuals, Vauxhall Partners and small businesses 1-24 units (purchase only excluding B2B supported units). Offer not available in conjunction with Personal Contract Hire, 0% Flexible Finance or a deposit contribution.

## PERSONAL CONTRACT HIRE

Personal contract hire offer on vehicles ordered by 2 July 2018 subject to availability and status. Age 18+ only. Figures based on a non-maintenance contract hire package. Excess miles over contracted mileage of 24,000 over 36 months charged at a maximum of 14 pence per mile. Excess charges also apply if you breach manufacturer servicing or maintenance guidelines or if the car exceeds BVRLA Fair Wear & Tear guidelines for its age/mileage when it is returned to Vauxhall Leasing. Package includes Road Fund Licence and Vauxhall Assistance. Guarantee/indemnity may be required. Prices and details are subject to change without notice. For full specification and Ts&Cs contact your local Retailer. You will not own the car. ALD Automotive Ltd., trading as Vauxhall Leasing, BS16 7LB. Authorised and regulated by the Financial Conduct Authority. Offer not available in conjunction with 0% Flexible Finance, Flexible PCP or a deposit contribution.

**Please note not all offers apply to all models.**



# MOKKA X COMPANY CAR DRIVER/FLEET INFORMATION

## DESIGN AND TECH LINE NAV HIGH SPEC, LOW P11D

Specifically developed for businesses and company car drivers alike, our Design and Tech Line Nav models are seriously fit for Fleet.

Design models all feature very low P11D values, generous standard specification with a choice of high tech ECOTEC engines for great fuel economy and low emissions including the 'whisper diesel' 1.6CDTi (from 88g/km and 85.6mpg combined).

For even more standard specification, step up to our Tech Line Nav range again you are guaranteed low P11D values, plus great standard kit including Sat Nav, Bluetooth®, USB connection and digital radio.

With Design and Tech Line Nav you can take for granted low Whole Life Costs and low company car driver taxation.



## COMPANY CAR DRIVER FREE 3 DAY TEST DRIVE

Our free\* 3 Day Test Drive programme is open to all Company Car Drivers. It allows you to choose most models in the current Vauxhall line-up (exclusions apply). With full insurance cover provided, it gives you a meaningful length of time to make an informed decision about your next company car.

Click below to book your free\* test drive  
[www.vauxhall3dtd.co.uk](http://www.vauxhall3dtd.co.uk)  
 or call 0330 587 8221\*\*

\*The free 3 Day Test Drive programme is open to Company Car Drivers and Fleet Decision Makers. Available for UK Mainland only. Terms and conditions apply. Full terms and conditions can be found at [vauxhallfleet.co.uk/testdrive/index/terms](http://vauxhallfleet.co.uk/testdrive/index/terms). \*\*Telephone lines open Monday-Friday 9.00am to 5.00pm excluding Bank Holidays. Calls may be recorded or monitored for quality and/or training purposes.

## BENEFIT IN KIND COMPANY CAR TAXATION†

The car benefit charge will be the car's list price (including VAT, options and accessories fitted, delivery to Retailer and number plates, but excluding Vehicle Excise Duty and new vehicle first registration fee) multiplied by the percentage charge for the CO<sub>2</sub> emissions band in which the car falls (see table opposite). Multiply this figure by your personal income tax rate (20%†† for Basic Rate, 40%†† for Higher Rate) to calculate your annual benefit in kind tax liability.

### Example:

Mokka X Design Nav 1.6CDTi (136PS) Start/Stop ECOTEC BlueInjection FWD (CO <sub>2</sub> emissions 127g/km)	
On-the-road RRP	£21720.00
Deduct: Vehicle Excise Duty	(£205.00)
New vehicle first registration fee	(£55.00)
Effective list price	£21460.00
Add: Optional two-coat metallic paint	£565.00

List price for tax purposes (P11D value)	£22025.00
--	-----------

<b>Car benefit charge</b>	
2018-19 tax year (30%)	£6607.00
<b>Benefit in kind tax liability (2018-19 tax year)</b>	
Basic Rate (20%) tax payer	£1321.40
Higher Rate (40%) tax payer	£2642.80

† = Please note this Price Guide provides taxation information as a guide only. Vauxhall does not provide taxation guidance. Drivers should always take professional advice on their own tax position. †† = Excludes residents of Scotland.

### BIK FOR SCOTTISH RESIDENTS

Effective April 6th 2018 the Scottish Government have introduced their own BIK taxation structure. This only applies to Company Car Drivers that are Scottish taxpayers. HMRC will determine whether or not an individual is a Scottish taxpayer based on where their main place of residence is.

- The BIK rates for Scotland are:
- Over £11,850-£13,850 Starter Rate 19%
  - Over £13,850-£24,000 Basic Rate 20%
  - Over £24,000-£43,430 Intermediate Rate 21%
  - Over £43,430-£150,000 Higher Rate 41%
  - Above £150,000 Top Rate 46%

CO <sub>2</sub> emissions in grams per kilometre	Percentage of car's price to be taxed	
	Non-Diesel† 2018-19 tax year	Diesel†† 2018-19 tax year
Up to 50	13	17
51-75	16	20
76-94	19	23
95-99	20	24
100-104	21	25
105-109	22	26
110-114	23	27
115-119	24	28
120-124	25	29
125-129	26	30
130-134	27	31
135-139	28	32
140-144	29	33
145-149	30	34
150-154	31	35
155-159	32	36
160-164	33	37
165-169	34	37
170-174	35	37
175-179	36	37
180 and above	37	37

† = Also applies to diesel vehicles that meet the Real Driving Emissions Step 2 (RDE2). †† = Applies to vehicles that do not meet the Real Driving Emissions Step 2 (RDE2).

To calculate your own personal liability a car tax calculator is available at:  
<https://www.vauxhallfleet.co.uk/toolbox>

## FLEET TOOLBOX

Discover the facts in our online Toolbox for both Company Car Drivers and Fleet Decision Makers. The Fleet Toolbox has a host of useful calculators, comparators, interactive listings and information. Visit the Fleet Toolbox by going to [www.vauxhall-toolbox.co.uk](http://www.vauxhall-toolbox.co.uk)



## ROADTRIP APP

The Vauxhall RoadTrip App is a free app that calculates and logs your mileage expenses for any UK business trips and generates reports to help you complete your mileage claims. Available for both iPhone and Android, visit [www.vauxhall-toolbox.co.uk](http://www.vauxhall-toolbox.co.uk) or visit the iPhone or Android stores and search for Vauxhall RoadTrip to download it to your smartphone or tablet.



## CONTACT VAUXHALL FLEET

Please contact one of our dedicated sales teams who will be happy to help with your particular enquiry.

### Company Car Drivers

Call: 0345 111 2020  
 Email: [company-car@vauxhallinfo.co.uk](mailto:company-car@vauxhallinfo.co.uk)

Telephone lines are open  
 – Monday to Friday 8.00am-9.00pm  
 – Saturday and Sunday 9.00am-6.00pm

### Fleet Decision Makers

Depending on the size of your fleet of vehicles, we have a dedicated team to handle your enquiries. The lines are open Monday to Friday excluding Bank Holidays.

### 1-24 vehicles

Call: 0845 076 2254 (8.30am-5.00pm)  
 Email: [b2bsales@vauxhall.co.uk](mailto:b2bsales@vauxhall.co.uk)

### 25+ vehicles

Call: 0330 587 8222 (8.30am-5.00pm)  
 Email: [vauxhallfleet@vauxhall.co.uk](mailto:vauxhallfleet@vauxhall.co.uk)

### Special Vehicles (Police, Fire and Ambulance)

Call: 01582 409999 (8.30am-5.00pm)  
 Email: [vauxhallspecialvehicles@vauxhall.co.uk](mailto:vauxhallspecialvehicles@vauxhall.co.uk)

# MOKKA X ADDITIONAL INFORMATION

## ON-THE-ROAD PRICES

To eliminate uncertainty about hidden costs when buying a new car, Vauxhall publishes on-the-road recommended retail prices (RRP) and these are shown in the pricing tables within this price guide. These prices include VAT, number plates and delivery to Retailer of £700.00 (including £116.67 VAT), 12 months' Government Vehicle Excise Duty (see opposite for details) and the DVLA new vehicle first registration fee of £55.00\*.

Please note: The on-the-road recommended retail price (RRP) does not include fuel supplied by the Retailer, motor insurance or any other goods or services supplied by agreement between the Retailer and the customer.

## PRICE PROTECTION

Order a new Vauxhall for build in the current model year (as confirmed by your Retailer) for delivery no more than three months in advance and the price you are quoted is the price you pay. This is irrespective of any subsequent price rises between placing your order and delivery of your new car, but you must take delivery as soon as the car is available. Vauxhall Motors Limited is not liable for price adjustments caused by Government changes in the rate of VAT (currently 20%), Vehicle Excise Duty, DVLA new vehicle first registration fee or by any other applicable legislation or regulations.

## VAUXHALL LEASING

As Vauxhall's own contract hire and fleet management operation, Vauxhall Leasing provides a one-stop-shop for competitive car and van leasing solutions – for business users and private individuals. Working with the Vauxhall Retailer network, we combine the support of a national contract with the convenience of a local contact.

For further information, please see your local Vauxhall Retailer or call us on **0117 908 6433**. Alternatively, you can visit our website at [www.vauxhall-leasing.co.uk](http://www.vauxhall-leasing.co.uk)

## IN THE EVENT OF AN ACCIDENT...

Vauxhall Accident Management helps keep you mobile following an accident. Benefits include vehicle recovery, Vauxhall-approved repairs and contacting your insurer. For more details, visit [vauxhall.co.uk/AccidentManagement](http://vauxhall.co.uk/AccidentManagement)

## VEHICLE EXCISE DUTY

The amount of Vehicle Excise Duty (road fund licence) payable on new cars varies depending on the level of carbon dioxide (CO<sub>2</sub>) emissions produced by the vehicle. CO<sub>2</sub> emissions are measured in grammes (g) per kilometre (km) travelled and divided into 13 charging bands shown in the table below.

A 'first year rate' of Vehicle Excise Duty is payable on all new cars and in subsequent years the amount payable reverts to the 'standard rate'. From 1 April 2017 the breakpoints for each of these bands have been revised. Also, for vehicles with a list price over £40,000, including factory-fitted options, an additional £310 is payable for the first five years of standard rate payments.

## VEHICLE EXCISE DUTY\*

	CO <sub>2</sub> emissions	First year rate		Standard rate
		Non-diesel**	Diesel†	
<b>Band A</b>	0g/km	£0.00	£0.00	£0.00
<b>Band B</b>	1 – 50g/km	£10.00	£25.00	£140.00
<b>Band C</b>	51 – 75g/km	£25.00	£105.00	£140.00
<b>Band D</b>	76 – 90g/km	£105.00	£125.00	£140.00
<b>Band E</b>	91 – 100g/km	£125.00	£145.00	£140.00
<b>Band F</b>	101 – 110g/km	£145.00	£165.00	£140.00
<b>Band G</b>	111 – 130g/km	£165.00	£205.00	£140.00
<b>Band H</b>	131 – 150g/km	£205.00	£515.00	£140.00
<b>Band I</b>	151 – 170g/km	£515.00	£830.00	£140.00
<b>Band J</b>	171 – 190g/km	£830.00	£1,240.00	£140.00
<b>Band K</b>	191 – 225g/km	£1,240.00	£1,760.00	£140.00
<b>Band L</b>	226 – 255g/km	£1,760.00	£2,070.00	£140.00
<b>Band M</b>	over 255g/km	£2,070.00	£2,070.00	£140.00

\* = Correct at time of issue. \*\* = Also applies to diesel vehicles that meet the Real Driving Emissions Step 2 (RDE2).

† = Applies to vehicles that do not meet the Real Driving Emissions Step 2 (RDE2).

# TRUST VAUXHALL

## CUSTOMER CARE COMMITMENT

For added peace of mind, Vauxhall has an innovative Customer Care Commitment that offers the following:

- Three-year vehicle warranty consisting of a one-year/unlimited mileage manufacturer's warranty and a second and third year manufacturer's warranty with a 60,000 miles limitation
- Vauxhall Assistance for 12 months from first registration
- Six years' body panel anti-perforation warranty

Please note: Warranty is only available on vehicles sourced from Vauxhall Motors Limited. Terms and conditions apply – please see your Vauxhall Retailer for details.

## VAUXHALL ASSISTANCE

Vauxhall Assistance is provided automatically with every new Vauxhall for 12 months from first registration and covers everything from accident assistance, roadside recovery and 'at home' service to flat tyres. With Vauxhall Assistance help is literally just a free\* phone call away, 24 hours a day, 365 days a year!

\* = Mobile phone users will be charged at their standard tariff.

## PROTECTING THE ENVIRONMENT

Vauxhall's commitment to the environment is demonstrated by our products' many environmental awards. For even more information on Vauxhall's efforts to achieve an environmentally sustainable future, and how to dispose of your end-of-life vehicle, see [www.vauxhall.co.uk/recycling](http://www.vauxhall.co.uk/recycling)

## VAUXHALL SERVICE PLAN

- Fixed monthly payments for the plan duration
- Easy to budget and interest-free
- Genuine parts fitted by Vauxhall-trained technicians

### Plus on Gold plans:

- Valet and courtesy car
- Full AA cover
- Engine flush and fuel treatments
- Litre of oil for top ups between services

Full details can be obtained from your local participating Vauxhall Retailer.

## VAUXHALL INSURANCE WITH ADDED REASSURANCE

Comprehensive cover – Summary of benefits\*\*

- Competitive premiums
- Repairs by a Vauxhall-trained technician
- Genuine Vauxhall parts, guaranteed for three years when we repair your car within our Approved Repairer Network
- Free courtesy car as standard when using an Approved Repairer†
- 24 hour claims helpline
- Personal Accident benefit
- Cover for audio equipment
- Windscreen cover

Call for a quote on 0844 463 2670††

\*\* = The benefits listed above are for comprehensive cover only. For details of Third Party, Fire and Theft cover, please call our sales team.  
† = Should your car need repairing following an accident we provide a courtesy car (subject to availability) for the duration of the repair. Only genuine Vauxhall parts are used. Terms and conditions apply.  
†† = Calls may be recorded. Vauxhall Insurance is underwritten by Ageas Insurance Limited.

## FOR MORE PRODUCT INFORMATION

For a brochure on any Vauxhall model (up to a maximum of three per caller) or location of your nearest Vauxhall Retailer please call **0345 600 1500**. Alternatively, details can be found on our website at [www.vauxhall.co.uk](http://www.vauxhall.co.uk)

## JOIN US ONLINE:



## PROUD SPONSOR OF OUR NATIONAL FOOTBALL TEAMS



Privacy Policy – For full details please visit: [vauxhall.co.uk/privacy](http://vauxhall.co.uk/privacy)

OnStar privacy details are available at [vauxhall.co.uk/onstar](http://vauxhall.co.uk/onstar)

The invoice price, including delivery to Retailer, factory-fitted options, accessories fitted by the Retailer and number plates, is subject to VAT. Some feature descriptions in this guide may refer to, and some illustrations may show, optional equipment not included in the standard delivery. The information contained in this guide was accurate at the time of publication. We reserve the right to make changes in design and equipment. Please note that Vauxhall Retailers are not the agents of Vauxhall Motors Limited and are not authorised to bind Vauxhall Motors Limited by any specific or implied undertaking or representation. It is advisable to ensure that your motor insurance policy provides adequate cover for additional fitted options and accessories. The colours in this guide are only approximate actual colours. Illustrated optional equipment is available at extra charge. Availability, technical features and equipment provided on our vehicles can vary by model. For precise information on the equipment provided on our vehicles, please contact your local Vauxhall Retailer.

# VAUXHALL

[vauxhall.co.uk](http://vauxhall.co.uk)

©2018 Vauxhall Motors Limited

Published 9 May 2018 Vauxhall Motors Limited

# MOKKA X

## PRICE/SPECIFICATION GUIDE

19 December 2017

**Pre-current Model Year**



**VAUXHALL**

# MOKKA X PRICES

Model 5-door SUV	Price (£)	VAT (£)	Total (£)	On-the-road RRP (£)	CO <sub>2</sub> (g/km)	Model 5-door SUV	Price (£)	VAT (£)	Total (£)	On-the-road RRP (£)	CO <sub>2</sub> (g/km)
<b>ACTIVE VAUXHALL OnStar</b>						<b>ELITE NAV VAUXHALL OnStar</b>					
1.6i (115PS) Start/Stop FWD	16587.50	3317.50	19905.00	<b>21160.00</b>	155	1.4i Turbo (140PS) Start/Stop ecoTEC FWD	19845.83	3969.17	23815.00	<b>24770.00</b>	140
1.4i Turbo (140PS) Start/Stop ecoTEC FWD	17179.17	3435.83	20615.00	<b>21570.00</b>	140	1.4i Turbo (140PS) auto FWD	20608.33	4121.67	24730.00	<b>25685.00</b>	149
1.4i Turbo (140PS) auto FWD	17941.67	3588.33	21530.00	<b>22485.00</b>	149	1.4i Turbo (152PS) Start/Stop auto 4X4	22333.33	4466.67	26800.00	<b>27755.00</b>	150
<i>Diesel</i>						<i>Diesel</i>					
1.6CDTi (110PS) Start/Stop ecoTEC FWD**	18291.67	3658.33	21950.00	<b>22845.00</b>	103	1.6CDTi (136PS) Start/Stop FWD**	21250.00	4250.00	25500.00	<b>26395.00</b>	106
1.6CDTi (136PS) Start/Stop FWD**	18583.33	3716.67	22300.00	<b>23195.00</b>	106	1.6CDTi (136PS) auto FWD	21979.17	4395.83	26375.00	<b>27330.00</b>	132
1.6CDTi (136PS) auto FWD	19312.50	3862.50	23175.00	<b>24130.00</b>	132	<b>ULTIMATE VAUXHALL OnStar</b>					
<b>DESIGN NAV VAUXHALL OnStar</b>						1.4i Turbo (140PS) Start/Stop ecoTEC FWD	21720.83	4344.17	26065.00	<b>27020.00</b>	140
1.6i (115PS) Start/Stop FWD	14866.67	2973.33	17840.00	<b>19095.00</b>	155	1.4i Turbo (140PS) auto FWD	22483.33	4496.67	26980.00	<b>27935.00</b>	149
1.4i Turbo (140PS) Start/Stop ecoTEC FWD	15512.50	3102.50	18615.00	<b>19570.00</b>	140	<i>Diesel</i>					
1.4i Turbo (140PS) auto FWD	16275.00	3255.00	19530.00	<b>20485.00</b>	149	1.6CDTi (136PS) Start/Stop 4X4	24541.67	4908.33	29450.00	<b>30365.00</b>	124
<i>Diesel</i>						Please note: On-the-road recommended retail prices (RRP) include number plates and delivery to retailer of £700.00 (inc. £116.67 VAT), 12 months' Vehicle Excise Duty and new vehicle first registration fee of £55.00. Excludes fuel and insurance.					
1.6CDTi (110PS) Start/Stop ecoTEC FWD**	16625.00	3325.00	19950.00	<b>20845.00</b>	103	** = 17-inch alloy wheels as standard.					
1.6CDTi (136PS) Start/Stop FWD**	16916.67	3383.33	20300.00	<b>21195.00</b>	106						
<b>ELITE VAUXHALL OnStar</b>											
1.6i (115PS) Start/Stop FWD	18670.83	3734.17	22405.00	<b>23660.00</b>	155						
1.4i Turbo (140PS) Start/Stop ecoTEC FWD	19262.50	3852.50	23115.00	<b>24070.00</b>	140						
1.4i Turbo (140PS) auto FWD	20025.00	4005.00	24030.00	<b>24985.00</b>	149						
1.4i Turbo (140PS) Start/Stop 4X4	20666.67	4133.33	24800.00	<b>26055.00</b>	152						
1.4i Turbo (152PS) Start/Stop auto 4X4	21750.00	4350.00	26100.00	<b>27055.00</b>	150						
<i>Diesel</i>											
1.6CDTi (136PS) Start/Stop FWD**	20666.67	4133.33	24800.00	<b>25695.00</b>	106						



# MOKKA X FEATURES/OPTIONS

## SAFETY

### Driver / passenger airbags

- Driver's airbag • Front passenger's airbag • Front seat side-impact airbags
- Full-size curtain airbags for driver, front seat passenger and outer rear seat passengers

### Seating

- Height-adjustable front seat head restraints • Height-adjustable outer rear seat head restraints

### Seatbelts

- Height adjustable front inertia-reel lap and diagonal seatbelts • Three inertia-reel lap and diagonal rear seatbelts • Front body-lock diagonal seatbelt pretensioner system – *Tightens the seatbelt during the early stages of a frontal impact, limiting forward movement.* • Driver's and front passenger's lap belt pretensioner system • Front seatbelt force limiters – *Reduces potential upper body injuries during a frontal impact.* • Front and rear 'seatbelt unfastened' warning light

### Child safety

- Deactivation switch for front passenger's front and side-impact airbags – *Permits the safe use of a child seat in the front passenger seat.* • ISOFIX child seat mountings incorporating top tether anchor points located on outer rear seats (does not include child seat) – *Allows ISOFIX child safety seats to be securely fixed into the car. The ISOFIX mounting system reduces forward movement in an accident and makes the child seat easier to install.*

### Driver / passenger safety

- Energy-absorbing steering column • Pedal release system – *Reduces potential injury to the driver's legs and feet during a severe frontal impact.* • Laminated windscreen • Side-impact protection beams • Reinforced passenger safety cell • Deformation zones front and rear
- Burst-proof door locks and anti-jam door design

### Pedestrian safety

- Collapsible windscreen wiper system – *Designed to reduce pedestrian head injuries.*
- Upper and lower bumper design – *Reduces upper and lower leg injuries.*

### Stability

#### Switchable Electronic Stability Programme (ESP):

– Works in conjunction with the vehicle's electronic braking and engine systems to keep the car stable in many different situations. ESP monitors many different inputs to determine when the car starts to lose traction, it can then immediately respond by varying the brake pressure between up to three wheels and adjust the engine output to help correct the loss of traction and improve stability.

#### Additional ESP features:

- Cornering brake control • Straight line stability control
- Descent control system (4X4 models only) • Rollover mitigation
- Traction control

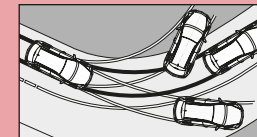

### Braking

#### Anti-lock Braking System (ABS):

– Prevents the vehicle's wheels from locking up under heavy braking by momentarily reducing brake pressure at the appropriate wheel, ensuring that you can maintain control of the steering.

#### Additional braking features:

- The same electronic systems used in the ABS and ESP also deliver exceptional braking performance.
- Emergency brake assist – *When emergency braking is detected the vehicle automatically applies the maximum possible braking assistance.* • Electronic brakeforce distribution – *Automatically apportions the optimum braking force to each wheel.* • Adaptive brake lights – *Automatically warns other road users of heavy braking.* • Hill start assist – *Briefly maintains rear brake pressure to stop the vehicle rolling back on an incline.* • Hazard warning lights

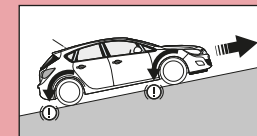

### Tyre pressure

- Tyre pressure monitoring system

# MOKKA X FEATURES/OPTIONS

		Active	Design Nav	Elite	Ultimate	Price (£) exc. VAT	Total (£) inc. VAT
<b>DRIVER ASSISTANCE</b>							
<b>Steering</b>	<ul style="list-style-type: none"> <li>Speed-sensitive power-assisted steering</li> </ul>	●	●	●	●		
<b>Cruise control with speed limiter</b>	<p>The cruise control feature enables you to maintain a constant speed – making it ideal for economical motorway driving.</p> <p>The speed limiter function can be set to ensure that you do not exceed the speed limit and can be easily overridden if required.</p> <ul style="list-style-type: none"> <li>Steering wheel mounted controls</li> </ul>	●	●	●	●		
<b>Parking sensors</b>	<ul style="list-style-type: none"> <li>Front and rear parking distance sensors</li> <li>Audible warning</li> </ul> <p><b>✓ Easier parking</b></p>	●	●	●	●		
<b>Rear-view camera</b>	<p>The rear-view camera gives a clear view of the area behind your car and helps place the car perfectly, without needing to strain your neck.</p> <ul style="list-style-type: none"> <li>Activated when reverse gear selected</li> <li>Camera view appears in infotainment screen</li> <li>Rear bumper and one-metre grid lines shown as reference points.</li> </ul> <p><b>✓ See what's behind you on the central screen</b></p>	○	○	○	○	237.50	285.00

● = Standard equipment. ○ = Optional at extra cost.

# MOKKA X FEATURES/OPTIONS

	Active	Design Nav	Elite	Ultimate	Price (£) exc. VAT	Total (£) inc. VAT
<b>SECURITY</b>						
<b>Standard security features</b> • Electronically protected audio equipment • Engine deadlock immobiliser • Visible Vehicle Identification Number (VIN) • Locking wheel nuts • Foldable luggage area cover	●	●	●	●		
<b>Remote control central locking</b> • Operates on doors, tailgate and fuel filler flap • Deadlocking • Driver's internal central locking activation switch • One folding key/one static key each with integral remote control function	●	●	●	●		
<b>Remote control security alarm system</b> • Remote control (operates in conjunction with central locking)	●	●	●	●		
<b>DRIVER INFORMATION</b>						
<b>Instrumentation</b> • Speedometer • Rev counter • Fuel gauge with low fuel level warning light • Water temperature gauge with warning light • Shift-up indication light (manual models only) – <i>Indicates when to change gear for optimum fuel economy.</i>	●	●	●	●		
<b>Driver information display (centrally located in instrument cluster)</b> • Monochrome display • Displays trip computer data • Total mileage • Service-due indicator • Oil life • Tyre pressure monitoring system  <b>Driver information display with ecoTEC Drive Assist (Start/Stop models only):</b> <i>Includes information on which electrical items are using the most energy, fuel consumption statistics for the last 30 miles and when to change gear to help maximise economy.</i>	●	●	●	●		
<b>Multi-function trip computer (displayed on driver information display)</b> • Trip mileage • Vehicle range based on remaining fuel • Average speed • Average fuel economy • Instantaneous fuel economy	●	●	●	●		
<b>Central fascia display (format dependent on infotainment unit)</b> • Audio information • Digital clock with automatic RDS time adjustment • Outside air temperature with ice warning function • Additional features dependent on infotainment unit (see infotainment for details)	●	●	●	●		

● = Standard equipment.

# MOKKA X FEATURES/OPTIONS

<b>INTERIOR STYLING</b>	<i>Active</i>	<i>Design Nav</i>	<i>Elite</i>	<i>Ultimate</i>	Price (£) exc. VAT	Total (£) inc. VAT
<b>Active interior décor</b> Steering wheel: • Three-spoke design • Leather-covered • Satin chrome-effect bezel Facia and door trim: • Black facia • Black door panels with black Atlantis cloth inserts • Chrome-effect interior door handles Seat trim: • Milano fabric seat trim inserts • Plain black fabric side bolsters and surrounds	●					
<b>Design Nav interior décor</b> Steering wheel: • Three-spoke design • Leather-covered • Satin chrome-effect bezel Facia and door trim: • Black facia • Black door panels with black Atlantis cloth inserts • Chrome-effect interior door handles Seat trim: • Milano fabric seat trim inserts • Plain black fabric side bolsters and surrounds		●				
<b>Elite/Ultimate interior décor with Black Jasmin leather seat trim</b> Steering wheel: • Three-spoke design • Leather-covered • Satin chrome-effect bezel Facia and door trim: • Black facia • Black door panels with black leather-effect inserts • Chrome-effect interior door handles Seat trim: • Black Jasmin leather seat trim inserts • Black leather-effect side bolsters and surrounds Front door sill covers: • Alloy-effect			●	●		
<b>Elite/Ultimate interior décor with Morello Red Jasmin leather seat trim (not available with Royal Blue, Lava Red, Boracay Blue and Amber Orange exterior colours)</b> Steering wheel: • Three-spoke design • Leather-covered • Satin chrome-effect bezel Facia and door trim: • Black facia • Black door panels with black leather-effect inserts • Chrome-effect interior door handles Seat trim: • Morello Red Jasmin leather seat trim inserts • Morello Red leather-effect side bolsters and surrounds Front door sill covers: • Alloy-effect			N/C	N/C	<b>No-cost option</b>	

● = Standard equipment. N/C = No-cost option.







# MOKKA X FEATURES/OPTIONS

## INFOTAINMENT

	Active	Design Nav	Elite	Ultimate	Price (£) exc. VAT	Total (£) inc. VAT
<b>R4.0 IntelliLink touchscreen infotainment system</b> <i>For use with MP3 players, USB memory sticks, mobile phones and smartphone apps</i> <b>Onboard features:</b> <ul style="list-style-type: none"> <li>• 7-inch colour touchscreen • Digital radio/AM/FM stereo radio with 36 station presets</li> <li>• RDS with Traffic Programme</li> </ul> <b>Media connections:</b> <ul style="list-style-type: none"> <li>• USB connection with iPod control • Aux-in socket • Bluetooth® A2DP audio streaming (Advanced Audio Distribution Profile)</li> </ul> <b>Mobile phone portal:</b> <ul style="list-style-type: none"> <li>• Bluetooth® connectivity • Handsfree calls via steering wheel controls • Vehicle microphone</li> <li>• Phone book access – <i>Contacts/last calls/missed calls etc. are mirrored on IntelliLink's display and are easily navigated using the touchscreen (features dependent on mobile phone).</i></li> </ul> <b>Smartphone interface:</b> <ul style="list-style-type: none"> <li>• Apple CarPlay™ • Android Auto™</li> </ul>	●		●			
<b>Navi 900 IntelliLink touchscreen navigation and infotainment system</b> <i>For use with MP3 players, USB memory sticks, mobile phones and smartphone apps</i> <b>Onboard features:</b> <ul style="list-style-type: none"> <li>• 8-inch colour touchscreen • Digital radio/AM/FM stereo radio with 36 station presets • RDS with Traffic Programme</li> <li>• 60 configurable favourites including contacts, addresses, playlists, radio stations and voice recognition</li> </ul> <b>Navigation features:</b> <ul style="list-style-type: none"> <li>• Satellite navigation system • 3D street level mapping • European coverage</li> </ul> <b>Media connections:</b> <ul style="list-style-type: none"> <li>• USB connection with iPod control • Aux-in socket • Bluetooth® A2DP audio streaming (Advanced Audio Distribution Profile)</li> </ul> <b>Mobile phone portal:</b> <ul style="list-style-type: none"> <li>• Bluetooth® connectivity • Handsfree calls via steering wheel controls • Vehicle microphone</li> <li>• Phone book access – <i>Contacts/last calls/missed calls etc. are mirrored on IntelliLink's display and are easily navigated using the touchscreen (features dependent on mobile phone).</i></li> </ul> <b>Smartphone interface:</b> <ul style="list-style-type: none"> <li>• Apple CarPlay™ • Android Auto™</li> </ul>	○	●	▲	●	591.67	710.00
<b>Bose® Premium Sound System (only available with Navi 900 IntelliLink and optional spare wheel)</b> <ul style="list-style-type: none"> <li>• Six channel amplifier with digital signal processing • Two A-pillar mounted 2.5cm tweeters • Two front door mounted 16.5cm woofers</li> <li>• Two rear door mounted 13cm wide-range speakers • One 13cm Richbass woofer in custom 8-litre bass box in luggage compartment</li> </ul>	○	○	○	○	495.83	595.00
Six speakers (four front, two rear)	●	●	●	●		
Steering wheel mounted audio controls	●	●	●	●		

● = Standard equipment. ○ = Optional at extra cost. ▲ = Standard on Nav models, see pricing page for details.

# MOKKA X FEATURES/OPTIONS

<b>AUDIO, COMMUNICATION AND NAVIGATION</b>						Active	Design Nav	Elite	Ultimate	Price (£) exc. VAT	Total (£) inc. VAT
											
Automatic Crash Response	Wi-Fi Hotspot	Smartphone App	Stolen Vehicle Assistance	Vehicle Diagnostics	Destination Download						
<p><b>Vauxhall OnStar – your personal on board assistant*</b></p> <p>Many car brands talk about innovation as soon as they improve their cup holders but this innovative system, now available on selected models**, is revolutionary: 24/7, 365 days a year, Vauxhall OnStar puts you in touch with a trained advisor, not a machine. With OnStar you have access to a host of innovations, from Vehicle Diagnostics and Smartphone Function to a fully integrated 4G Wi-Fi Hotspot†. In the event of an accident, Vauxhall OnStar even automatically calls for help, for an incomparable feeling of safety.</p> <p>* = Includes 12 months of OnStar services from date of first registration and a 3 month/3 GB Wi-Fi free trial period (whichever comes first) effective from the date the customer accepts the nominated network operator Wi-Fi Ts&amp;Cs. Destination download feature only operates on models fitted with Navi 900 IntelliLink satellite navigation system.</p> <p>** = The OnStar Services require activation and are subject to mobile network coverage and availability. Wi-Fi Hotspot service requires account with nominated network operator.</p> <p>† = 4G is subject to mobile network coverage and availability. Charges apply after the free trial period. The OnStar subscription packages could be different from the services included in the free trial package. Check <a href="http://www.vauxhall.co.uk/onstar">www.vauxhall.co.uk/onstar</a> for terms and conditions, details of availability, coverage and charges.</p>						●	●	●	●		
											

## SEATING AND COMFORT

Reach and rake adjustable steering	●	●	●	●						
<b>Comfort front seats</b>										
Driver's seat (eight-way adjustable): • Height (up/down) • Reach (fore/aft) • Backrest recline (upright/incline) • Head restraint (up/down)	●	●								
Front passenger's seat (six-way adjustable): • Reach (fore/aft) • Backrest (upright/recline) • Head restraint (up/down)										
<b>Ergonomic sports-style front seats (AGR-approved†) featuring Jasmin Leather</b>										
Driver's and front passenger's seat (18-way adjustable): • Height (up/down) • Reach (fore/aft) • Tilt (electrical fore/aft)							●	●		
• Backrest (upright/recline) • Seat cushion extension (fore/aft) • Lumbar adjustment (four-way electrical) • Head restraint (up/down/fore/aft)										
• Heated front seats							●	●		
<b>Ergonomic sports-style front driver's seat (AGR-approved†)</b>	○	○							275.00	330.00
<b>Rear seating</b>										
• Three-person layout • 60/40 split flip and fold rear seat • Height-adjustable and removable outer seat head restraints										
• ISOFIX child seat mountings incorporating top tether anchor points located on outer rear seats (does not include child seat) – Allows ISOFIX child safety seats to be securely fixed into the car. The ISOFIX mounting system reduces forward movement in an accident and makes the child seat easier to install. • Child-proof locks on rear doors	●	●	●	●						
<b>Centre rear seat head restraint</b>							●	●		

● = Standard equipment. ○ = Optional at extra cost. † = AGR (The Campaign for Healthier Backs) is an independent centre of excellence for ergonomics, based in Germany.



# MOKKA X FEATURES/OPTIONS

	Active	Design Nav	Elite	Ultimate	Price (£) exc. VAT	Total (£) inc. VAT
<b>HEATING AND VENTILATION</b>						
<b>Electronic climate control including air conditioning</b> <ul style="list-style-type: none"> <li>• Dual-zone control – <i>Allowing different temperature settings for driver and front passenger.</i></li> <li>• Advanced predictive logic control system using humidity sensors</li> <li>• Partial air recirculation – <i>Faster warm up/cool down</i> • Cabin particulate filter – <i>Removes dust, airborne particles and pollen.</i></li> <li>• Automatic air direction and fan speed with manual override • Illuminated controls</li> </ul>	●	●	●	●		
<b>Additional features</b> <ul style="list-style-type: none"> <li>• Four adjustable facia vents • Windscreen demist vents • Side window demist vents</li> <li>• Heated rear screen with timed cut-off</li> </ul>	●	●	●	●		
<b>Winter Pack</b> <ul style="list-style-type: none"> <li>• Heated leather-covered steering wheel • Heated front seats</li> </ul> <div style="display: flex; align-items: center;"> <span>Warm welcome</span> </div>	 	○	○	●	●	233.33      280.00

## INTERIOR CONVENIENCE

<b>Convenience features</b> <ul style="list-style-type: none"> <li>• Front 12-volt electrical accessory socket • Front and rear passenger assist handles</li> </ul>	●	●	●	●
12-volt power outlet behind front seats	●	●	●	●
Driver's and front passenger's illuminated vanity mirrors with flip-up cover	●	●	●	●
Automatically dimming anti-dazzle rear-view mirror	●	●	●	●
Front driver's armrest	●	●	●	●
Rear seat centre armrest with drinks holders			●	●

## INTERIOR LIGHTING

<b>Standard lighting</b> <ul style="list-style-type: none"> <li>• Courtesy lighting operated by door switches</li> </ul>	●	●	●	●
--	---	---	---	---

## INTERIOR STORAGE

<b>Interior storage</b> <ul style="list-style-type: none"> <li>• Illuminated glovebox with lid • Front door pockets • Storage pocket on front passenger's seat back • Two drinks holders in centre console</li> </ul>	●	●	●	●
• Storage pocket on driver's seat back			●	●
• Front passenger's underseat storage tray	●	●		
<b>Luggage area</b> <ul style="list-style-type: none"> <li>• Luggage compartment foldable cover • Illuminated luggage area • Fully carpeted luggage area</li> </ul>	●	●	●	●

● = Standard equipment. ○ = Optional at extra cost.

# MOKKA X FEATURES/OPTIONS

	Active	Design Nav	Elite	Ultimate	Price (£) exc. VAT	Total (£) inc. VAT
<b>MECHANICAL</b>						
Front-wheel drive	●	●	●	●		
Intelligent four-wheel drive (4X4 models only)	▲	▲	▲	▲		
Five-speed manual gearbox (1.6i (115PS) models only)	●	●	●			
Six-speed manual gearbox (excluding 1.6i (115PS) and 1.4i (152PS) models)	●	●	●	●		
Six-speed automatic transmission (1.4i (152PS) models only)			●	●		
Six-speed automatic transmission (1.4i (140PS) and 1.6CDTi (136PS) models only)	▲	▲	▲	▲		
<b>EXTERIOR LIGHTING</b>						
<b>Standard lighting features</b> <ul style="list-style-type: none"> <li>• LED daytime running lights • Automatic lighting control • Halogen headlights • Lights-on audible warning</li> <li>• Manual headlight beam levelling • High beam assist • High-level LED centre rear brake light • Rear fog light</li> <li>• Reversing light • Hazard warning lights • Door-to-door illumination</li> </ul>	●	●	●	●		
Front fog lights	●	●	●	●		
<b>Premium LED Adaptive Forward Lighting (AFL)</b> Six LED elements light the road 30% brighter than halogen, allowing you to see hazards sooner and giving you more time to react. The AFL system uses data such as vehicle speed, steering angle and when the indicators are used to determine the most suitable lighting. <ul style="list-style-type: none"> <li>• Enhanced driver information display • Intelligent main beam control • Automatic headlight levelling • LED tail lights</li> </ul> <b>Every type of driving environment has been considered:</b> <ul style="list-style-type: none"> <li><b>Urban light:</b> With street lighting and speeds below 35mph, the system automatically enhances the dipped beam function.</li> <li><b>Country light:</b> As speeds increase, so does the lighting's performance.</li> <li><b>Dynamic curve light:</b> At speeds between 25mph and 45mph, and above a set steering angle, extra light is projected onto the relevant side of the road to give you a better view.</li> <li><b>Static cornering light:</b> At lower speeds, when you indicate and turn the steering above a certain angle, corners and bends are illuminated to match steering inputs.</li> <li><b>Parking light:</b> When reversing, additional side-facing lights are activated in the headlights.</li> <li><b>Energy saving mode:</b> On Start/Stop models, the system deactivates the static cornering light function when Start/Stop mode is active.</li> <li><b>Tourist mode:</b> If you're driving on the continent, switch to Tourist mode and your lights will dip automatically for oncoming traffic.</li> <li><b>High beam:</b> Powerful down-the-road illumination on top of the LED low beam. Full-on lighting for maximum visibility.</li> </ul>	○	○	○	○	966.67	1160.00

● = Standard equipment. ○ = Optional at extra cost.. ▲ = See price page for details.

# MOKKA X FEATURES/OPTIONS











	Active	Design Nav	Elite	Ultimate	Price (£) exc. VAT	Total (£) inc. VAT
<b>EXTERIOR CONVENIENCE</b>						
<b>Windscreen wipers</b> • Two-speed windscreen wipers with variable intermittent wipe • Intermittent rear window wash/wipe • Rain-sensitive windscreen wipers	●	●	●	●		
<b>Door mirrors</b> • Twin electrically adjustable/heated door mirrors (wide-angle on driver's side) with automatic timed cut-off • Electrically foldable door mirrors	●	●	●	●		
<b>Windows</b> • Electrically operated front windows with safety autoreverse and one-touch facility • Electrically operated rear windows • Heated rear window	●	●	●	●		
Power tilt and slide glass sunroof with manually operated sunblind	○	○	○	○	420.83	505.00
Roof rails, silver-effect	●	●	●	●		

## EXTERIOR STYLING

<b>Body styling</b> • Alloy-effect protective front skid plate • Side-protection mouldings • Chrome-effect front grille bar • Body-colour door handles • Body-colour door mirrors • Stainless steel exhaust tailpipe (excluding 1.6i (115PS) models)	●	●	●	●		
• Chrome-effect side window trim			●	●		
• Alloy-effect door sill covers			●	●		
• Black B-pillars	●	●	●	●		
<b>Premium Sport Line Pack</b> • Dark-effect front and rear lower bumper inserts • Silver-effect side sills				●		
<b>Windows</b> • Solar heat-absorbing windscreen • Tinted windows	●	●	●	●		
• Dark-tinted rear windows	○	○	●	●	237.50	285.00

● = Standard equipment. ○ = Optional at extra cost.





# MOKKA X FEATURES/OPTIONS

<b>EXTERIOR COLOURS</b>		Active	Design Nav	Elite	Ultimate	Price (£) exc. VAT	Total (£) inc. VAT
	<b>Royal Blue</b> • Solid paint • Folding key with Grey insert • Not available with Morello Red trim	●	●	●	N/C		
	<b>Summit White</b> • Brilliant paint • Folding key with Summit White insert	○	○	○	N/C	237.50	285.00
	<b>Lava Red</b> • Brilliant paint • Not available with Morello Red trim • Folding key with Lava Red insert	○	○	○	N/C		
	<b>Sovereign Silver</b> • Two-coat metallic paint • Folding key with Grey insert	○	○	○	N/C	470.83	565.00
	<b>Quantum Grey</b> • Two-coat metallic paint • Folding key with Lava Red insert	○	○	○	N/C		
	<b>Boracay Blue</b> • Two-coat metallic paint • Folding key with Summit White insert • Not available with Morello Red trim	○	○	○	N/C		
	<b>Mineral Black</b> • Two-coat metallic paint • Folding key with Gloss Black insert	○	○	○	N/C		
	<b>Amber Orange</b> • Two-coat Premium paint • Not available with Morello Red trim • Folding key with Summit White insert	○	○	○	N/C	545.83	655.00
	<b>Velvet Red</b> • Two-coat Premium paint • Folding key with Grey insert	○	○	○	N/C		
	<b>Coppertino</b> • Two-coat Premium paint • Folding key with Black insert	○	○	○	N/C		
	<b>Abalone White</b> • Tri-coat premium paint • Folding key with Summit White insert	○	○	○	N/C	604.17	725.00

● = Standard equipment. ○ = Optional at extra cost. N/C = No-cost option.



The colours reproduced may vary slightly from the actual paint colour. As a result they should be used as a guide only. Your Vauxhall Retailer has a comprehensive display of our paint samples.

# MOKKA X FEATURES/OPTIONS

		Active	Design Nav	Elite	Ultimate	Price (£) exc. VAT	Total (£) inc. VAT
Steel emergency spare wheel (in lieu of emergency tyre inflation kit)		○	○	○	○	91.67	110.00
	<b>17-inch silver-effect alloy wheels</b> <ul style="list-style-type: none"> <li>• 215/60 R 17 tyres</li> <li>• Emergency tyre inflation kit (in lieu of spare wheel)</li> <li>• Standard on 1.6CDTi (110PS) Start/Stop ecoTEC FWD and 1.6CDTi (136PS) Start/Stop FWD models only. Not available on other models</li> </ul>	●	●	●			
	<b>18-inch silver-effect alloy wheels</b> <ul style="list-style-type: none"> <li>• 215/55 R 18 tyres</li> <li>• Emergency tyre inflation kit (in lieu of spare wheel)</li> <li>• Standard on all models except 1.6CDTi (110PS) Start/Stop ecoTEC FWD and 1.6CDTi (136PS) Start/Stop FWD</li> <li>• No-cost option on 1.6CDTi (110PS) Start/Stop ecoTEC FWD and 1.6CDTi (136PS) Start/Stop FWD models only</li> </ul>	●	●				
		N/C	N/C			<b>No-cost option</b>	
	<b>18-inch multi-spoke alloy wheels</b> <ul style="list-style-type: none"> <li>• 215/55 R 18 tyres</li> <li>• Emergency tyre inflation kit (in lieu of spare wheel)</li> <li>• Standard on all models except 1.6CDTi (110PS) Start/Stop ecoTEC FWD and 1.6CDTi (136PS) Start/Stop FWD</li> <li>• No-cost option on 1.6CDTi (110PS) Start/Stop ecoTEC FWD and 1.6CDTi (136PS) Start/Stop FWD models only</li> </ul>			●			
				N/C		<b>No-cost option</b>	
	<b>18-inch diamond-cut bi-colour 10-spoke alloy wheels</b> <ul style="list-style-type: none"> <li>• 215/55 R 18 tyres</li> <li>• Emergency tyre inflation kit (in lieu of spare wheel)</li> </ul>			○		183.33	220.00



● = Standard equipment. ○ = Optional at extra cost. N/C = No-cost option.

# MOKKA X FEATURES/OPTIONS

		Active	Design Nav	Elite	Ultimate	Price (£) exc. VAT	Total (£) inc. VAT
	<b>18-inch black 10-spoke alloy wheels</b> • 215/55 R 18 tyres • Emergency tyre inflation kit (in lieu of spare wheel)	○	○	○		183.33	<b>220.00</b>
		<b>19-inch 5-twin spoke alloy wheels</b> • 225/45 R 19 tyres • Emergency tyre inflation kit (in lieu of spare wheel)	○	○	○	●	508.33

● = Standard equipment. ○ = Optional at extra cost. N/C = No-cost option.

## TYRES RATING

Tyre size	Fuel efficiency group	Wet grip performance	External noise	
			Measured (dB)	Group
215/60 R 17	B-C	B	71	
215/55 R 18	E	B	71	
225/45 R 19	E	A	71	

Tyre rating according to EU Regulation 1222/2009



# MOKKA X SPECIFICATIONS

## PETROL ENGINES

	1.6i (115PS)	1.4i Turbo (140PS)	1.4i Turbo (152PS)
Capacity	1598cc	1364cc	1399cc
Maximum power	115PS (85kW) @ 6200rpm	140PS (103kW) @ 4900-6000rpm	152PS (112kW) @ 5600rpm
Maximum torque	155Nm (114 lb.ft.) @ 4000rpm	200Nm (147 lb.ft.) @ 1850-4900rpm	245Nm (180 lb.ft.) @ 2200-4400rpm
Configuration	4 cylinders, 4 valves per cylinder, double overhead camshafts	4 cylinders, 4 valves per cylinder, double overhead camshafts	4 cylinders, 4 valves per cylinder, double overhead camshafts
Fuel/induction system	Naturally aspirated. Variable Valve Timing. Multi-point sequential fuel injection	Turbocharger with intercooler. Variable Valve Timing. Multi-point sequential fuel injection	Turbocharger with intercooler. Variable Valve Timing. Multi-point sequential fuel injection
Emission compliance	Euro 6	Euro 6	Euro 6
Service interval	20,000 miles or 1 year (whichever occurs sooner)	20,000 miles or 1 year (whichever occurs sooner)	20,000 miles or 1 year (whichever occurs sooner)

## DIESEL ENGINES

	1.6CDTi (110PS)	1.6CDTi (136PS)
Capacity	1598cc	1598cc
Maximum power	110PS (81kW) @ 3500rpm	136PS (100kW) @ 3500-4000rpm
Maximum torque	300Nm (221 lb.ft.) @ 1750-2000rpm	320Nm (236 lb.ft.) @ 2000-2250rpm
Configuration	4 cylinders, 4 valves per cylinder, double overhead camshafts	4 cylinders, 4 valves per cylinder, double overhead camshafts
Fuel/induction system	Variable geometry turbocharger with intercooler. Common rail fuel injection	Variable geometry turbocharger with intercooler. Common rail fuel injection
Emission compliance	Euro 6 with Diesel Particulate Filter	Euro 6 with Diesel Particulate Filter
Service interval	20,000 miles or 1 year (whichever occurs sooner)	20,000 miles or 1 year (whichever occurs sooner)

# MOKKA X SPECIFICATIONS

## PERFORMANCE, FUEL ECONOMY AND EMISSIONS

	Wheel size (inches)	Performance (manufacturer's figures)		Fuel economy mpg (litres/100km)#			CO <sub>2</sub> emissions g/km#	Vehicle Excise Duty* First year rate	Standard rate	Benefit in kind company car taxation rates – 2017/18 tax year
		Maximum speed (mph)	Acceleration 0-60mph (sec)	Urban driving	Extra-urban driving	Combined figure				
<b>Petrol models</b>										
1.6i (115PS) S/S FWD	18/19	106	11.8	32.8 (8.6)	50.4 (5.6)	42.2 (6.7)	155	£500	£140	30%
1.4i Turbo (140PS) S/S ecoTEC FWD	18/19	122	9.3	37.2 (7.6)	55.4 (5.1)	47.1 (6.0)	140	£200	£140	27%
1.4i Turbo (140PS) auto FWD	18/19	119	10.1	33.6 (8.4)	52.3 (5.4)	43.5 (6.5)	149	£200	£140	28%
1.4i Turbo (140PS) S/S 4X4	18/19	116	9.3	34.0 (8.3)	50.4 (5.6)	43.5 (6.5)	152	£500	£140	29%
1.4i Turbo (152PS) S/S auto 4X4	18/19	120	9.4	35.8 (7.9)	49.6 (5.7)	43.5 (6.5)	150	£200	£140	29%
<b>Diesel models</b>										
1.6CDTi (110PS) S/S ecoTEC FWD	17	112	11.5	64.2 (4.4)	78.5 (3.6)	72.4 (3.9)	103	£140	£140	22%
1.6CDTi (110PS) S/S ecoTEC FWD	18/19	112	11.5	64.2 (4.4)	76.3 (3.7)	70.6 (4.0)	105	£140	£140	23%
1.6CDTi (136PS) S/S FWD	17	118	9.3	61.4 (4.6)	74.3 (3.8)	68.9 (4.1)	106	£140	£140	23%
1.6CDTi (136PS) S/S FWD	18/19	118	9.3	58.9 (4.8)	70.6 (4.0)	65.7 (4.3)	114	£160	£140	24%
1.6CDTi (136PS) auto FWD	18/19	117	10.3	47.1 (6.0)	64.2 (4.4)	56.5 (5.0)	132	£200	£140	28%
1.6CDTi (136PS) S/S 4X4	18/19	116	9.7	54.3 (5.2)	64.2 (4.4)	60.1 (4.7)	124	£160	£140	26%

\* = Correct at time of publication. FWD = Front-wheel drive.

# = Fuel consumption information is official government environmental data, tested in accordance with the relevant EU directive. Official EU-regulated test data is provided for comparison purposes and actual performance will depend on driving style, road conditions and other non-technical factors.

### START/STOP TECHNOLOGY

Mokka's Start/Stop system, fitted as standard to all models with a manual gearbox, offers real benefits by improving fuel economy and reducing CO<sub>2</sub> emissions, particularly in town. It does this by automatically stopping the engine when you come to a standstill, and then restarting as you prepare to move off.

Before automatically stopping the engine a number of system checks are carried out to ensure that it is both safe and practical to do so. To ensure safety, the driver must depress the clutch pedal, shift in to neutral, and then release the clutch pedal.

System checks carried out before Auto Stop activates include:

- Start/Stop system is not manually deactivated via the facia button
- Sufficient brake vacuum is available to prevent the car rolling down an incline
- Battery is in good condition and charged
- Outside air temperature and engine temperature are above specified minima

- Electronic climate control (where fitted) is not in maximum heating or maximum cooling mode
- Self-cleaning function of the diesel particulate filter is not active

If all of these conditions are satisfied then the vehicle will Auto Stop.

When you are ready to pull away from standstill, Auto Restart is activated by depressing the clutch pedal.

Whilst at a standstill the vehicle is continually monitored. If necessary, the engine will automatically be restarted. Conditions that would initiate an Auto Restart include:

- Low battery level
- Brake vacuum below specified minimum
- Start/Stop system is manually deactivated
- Stationary for 5.5 minutes

### TRANSMISSIONS

#### Five-speed manual gearbox:

Standard on 1.6i (115PS) models

#### Six-speed manual gearbox:

Petrol engines: All excluding 1.6i (115PS) and 1.4i Turbo (152PS) 4X4

Diesel engines: All models

#### Six-speed automatic transmission with Active Select function:

Standard on 1.4i Turbo (152PS) 4X4 models.

Available at extra cost on 1.4i (140PS) and 1.6CDTi (136PS) front-wheel drive models.

Electronically controlled with adaptive driving function and fuel-saving eco mode. Fluid drive with torque converter, lock-up clutch and Active Select.

#### Intelligent 4X4

Electronically controlled four-wheel drive with variable torque split between front and rear axles.

- Torque transfer device: When pulling away from standstill, or under acceleration, more power is diverted to the rear wheels for maximum grip
- Electronic limited-slip differential: Fitted to the rear axle, it can transfer up to 50% of the rear axle torque between the rear wheels

### STEERING

- Speed-sensitive power-assisted steering
- Turning circle (wall-to-wall): 11.50m (37.7ft)

### SUSPENSION

**Front:** Independent. Lightweight MacPherson struts with gas-pressure dampers and coil springs. Anti-roll bar.

**Rear:** Torsion beam with coil springs and gas-pressure dampers.

### BRAKING AND STABILITY

- Switchable Electronic Stability Programme (ESP)
- Cornering brake control
- Straight line stability control
- Rollover mitigation
- Traction control
- Hill start assist
- Anti-lock Braking System (ABS)
- Emergency brake assist
- Electronic brakeforce distribution
- Adaptive brake lights
- Hazard warning lights

### All models

Front ventilated discs: 300mm diameter

Rear discs: 268mm diameter

### BODY

- Aerodynamic drag co-efficient: Cd 0.35

### FUEL TANK CAPACITY

- 53 litres (11.7 gallons)

# MOKKA X SPECIFICATIONS

## EXTERIOR DIMENSIONS millimetres (inches)

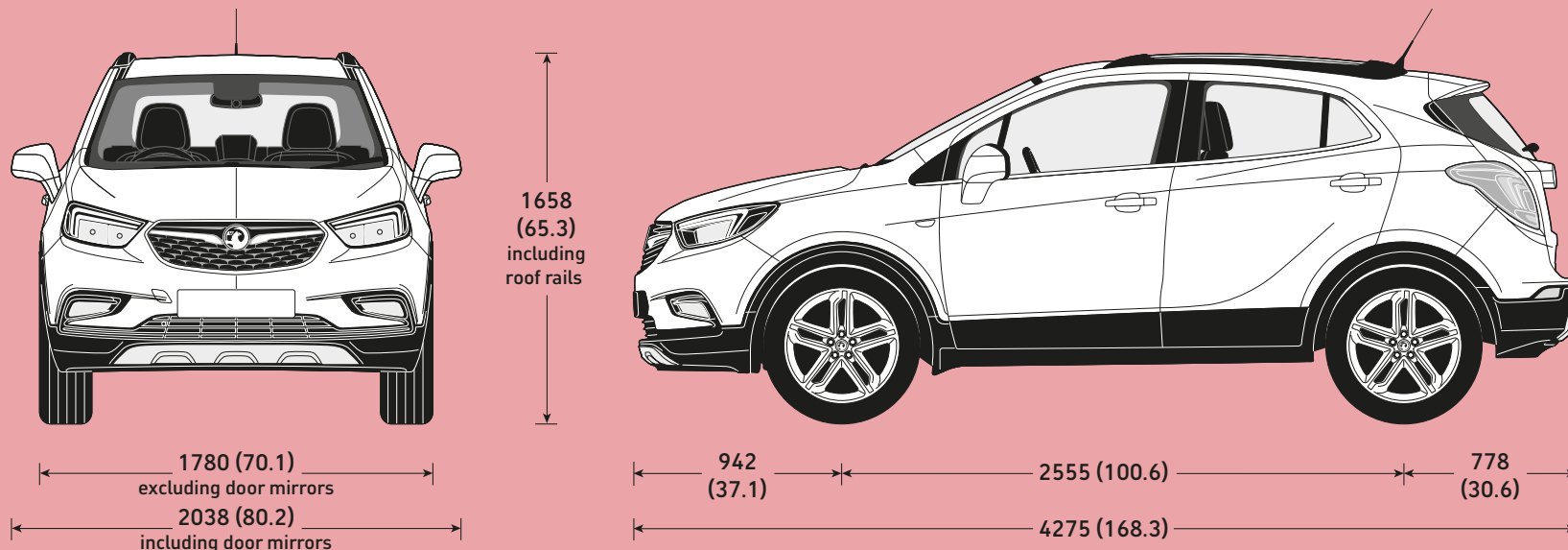

## WEIGHTS AND TOWING DATA kg

	Gross vehicle weight	Max. towing weights Trailer with brakes (without brakes)
1.6i (115PS) FWD	1789	1200 (500)
1.4i Turbo (140PS) ecoTEC FWD	1828	1200 (500)
1.4i Turbo (140PS) FWD automatic	1843	1200 (500)
1.4i Turbo (140PS) 4X4	1879	1200 (500)
1.4i Turbo (152PS) 4X4 automatic	1915	1500 (500)
1.6CDTi (110PS) ecoTEC FWD manual	1883	1500 (500)
1.6CDTi (136PS) FWD manual	1883	1500 (500)
1.6CDTi (136PS) FWD automatic	1896	1500 (500)
1.6CDTi (136PS) 4X4	1938	1500 (500)

FWD = Front-wheel drive.

Gross vehicle weight is the total permissible weight of the vehicle including passengers and their luggage. The maximum roof rack loading should not exceed 75kg. The maximum towing weights are based on the ability of the car, with two occupants of 75kg each, to restart on a 12% gradient, which is approximately 1 in 8.3, at sea level. At altitudes above 1500 metres, the engine output may drop with a corresponding reduction in towing capability. Any extra weight, such as luggage or additional passengers, should be deducted from the maximum towing weight. With a trailer fully loaded maximum noseweight should not exceed 75kg. Always fit Vauxhall towing attachments and accessories available from your Vauxhall Retailer. They are designed specifically for Vauxhall models and carry a 12-month guarantee.

## LOADSPACE DIMENSIONS millimetres (inches)

Maximum length (behind rear seats)	731 (28.8)
Maximum length (rear seats folded)	1428 (56.2)
Maximum width	1006 (39.6)
Width between wheel arches	915 (36.0)
Maximum height	808 (31.8)

## LOADSPACE CAPACITIES\* litres (cu.ft.)

Rear seats up (under luggage compartment cover)	356 (12.6)
Rear seats folded (to upper edge of front seat back)	785 (27.7)
Rear seats folded (to roof)	1305 (46.1)

\* = Measured using the ECIE method.

# MOKKA X ACCESSORIES

	Total (inc. VAT)
<b>INFOTAINMENT</b>	
<b>Sat Nav updates<sup>1</sup></b>	
Please consult your Retailer for latest map updates or visit <a href="http://www.vauxhall.co.uk/accessories">www.vauxhall.co.uk/accessories</a> .	
1 = For use with optional factory-fit satellite navigation systems.	
<b>CHILD SEATS<sup>2</sup></b>	
BABY-SAFE <sup>3</sup> – 0-13kg/birth to 15 months	£132.00
– ISOFIX base	£227.00
DUO ISOFIX <sup>3</sup> – 9-18kg/9 months to 4 years with top tether kit	£347.00
KID <sup>3</sup> – 15-36kg or 4 to 12 years	£157.00
2 = Restrictions apply to the use of child seats, please consult your Vauxhall Retailer or request a copy of the Child seats brochure.	
3 = Without transponder.	
<b>SAFETY</b>	
Privacy shades – rear side windows	£103.00
Privacy shades – tailgate window	£90.00
Safety Pack – first aid kit, warning triangle, hi-visibility vest, Vauxhall bag	£35.00
First aid kit	£15.00
Warning triangle	£17.00
Fire extinguisher – 2kg	£37.00
Hi-visibility vest	£9.00
Temporary tyre inflation kit	£120.00
Tyre sealant	£68.00

**Please note:**

Prices shown are a fully fitted and painted, where applicable and include VAT. Please check with your local Vauxhall Retailer for details. It is advisable to ensure your insurance policy is adequate to cover additional fitted accessories. Prices correct at time of publication.

	Total (inc. VAT)
<b>FLEXCONNECT RANGE</b>	
FlexConnect bracket	£20.00
FlexConnect hook	£28.00
FlexConnect coat hanger	£58.00
FlexConnect folding table	£68.00
FlexConnect iPad Mini cradle	£98.00
FlexConnect iPad (1-4) cradle	£106.00
FlexConnect iPad Air cradle	£106.00
FlexConnect Samsung Galaxy cradle	£96.00
<b>PRACTICAL</b>	
Premium spare bulb kit <sup>4</sup>	£34.00
Stretch tow rope – 3 tonne	£34.00
Smoker pack	£36.00
4 = Excludes xenon headlight bulb for models with Adaptive Forward Lighting (AFL).	
<b>PROTECTION</b>	
Rubber floor mats – set of four	£53.00
Velour floor mats – set of four	from £68.00
Cargo liner	£77.00
Cargo net – horizontal	£52.00
Cargo net – upper	£169.00
Mudflaps – front and rear <sup>5</sup>	£115.00
Load compartment mat	£99.00
Load compartment storage box	£119.00
5 = Not available with certain exterior styling products.	

	Total (inc. VAT)
<b>TRANSPORT SYSTEMS</b>	
Roof base carrier	£232.00
<b>Roof carriers (requires base carrier)</b>	
Bike roof carrier – Thule Freeride 532	£76.00
Surf board roof carrier – Thule 833	£101.00
Kayak roof carrier – Thule 837	£168.00
Ski roof carrier (400mm wide) – Thule Deluxe 726	£138.00
Ski roof carrier (600mm wide) – Thule 739	£235.00
<b>Hard shell roof boxes (requires base carrier)</b>	
Thule Ocean 80 (320 litre / 1330 x 860 x 370mm)	£235.00
Thule Ocean 200 (390 litre / 1750 x 820 x 450mm)	£316.00
Thule Dynamic M (320 litre / 2060 x 840 x 340mm)	from £625.00
Thule Dynamic L (430 litre / 2350 x 940 x 350mm)	£846.00
Thule Excellence (520 litre / 2180 x 940 x 400mm)	£898.00
Thule Motion 800 (460 litre / 2050 x 840 x 450mm)	from £515.00
Thule Touring 200 (400 litre / 1750 x 820 x 450mm)	£372.00
Thule Touring 780 (430 litre / 2320 x 700 x 420mm)	£460.00
<b>Soft roof boxes (requires base carrier)</b>	
Thule Ranger 90 (280 litre / 1100 x 800 x 400mm)	£285.00
Thule Ranger 500 (300 litre / 1900 x 500 x 300mm)	£378.00
<b>Tailgate carrier</b>	
Bike tailgate carrier – Thule BacPac 973	£282.00
Fitting kit	£48.00
<b>Tow bar carrier system</b>	
Fixed tow bar <sup>7</sup>	from £407.00
Detachable tow bar <sup>7</sup>	from £620.00

6 = Must be used in conjunction with a base carrier.

7 = Available with 12N, 12N/12S or 13-pin electrics. Please consult your retail or for details.

	Total (inc. VAT)
<b>STYLING</b>	
Decal styling kit	from £265.00
Rear spoiler kit	£385.00
Side steps	£491.00
Styling kit	£1099.00
Door sill plates	£40.00
<b>ALLOY WHEELS (set of four with centre caps)<sup>8</sup></b>	
17-inch 5-spoke	£628.00
18-inch 5-spoke	£926.00
18-inch 10-spoke	£912.00
19-inch 5-double spoke	£1578.00
Other designs available	

8 = Different tyres and locking wheel bolts/nuts may be required at extra cost. Price excludes new tyres and locking wheel bolts/nuts, includes static wheel balancing.

# MOKKA X OFFERS IN DETAIL – TERMS AND CONDITIONS

Unless otherwise stated, all offers described are available on orders or registrations between 19 December 2017 – 18 December 2017. Offer prices quoted are correct at the time of publication (October 2017). Prices are subject to change. In line with Vauxhall's policy of price transparency, the offer price shown is an on-the-road price including VAT, number plates and delivery to Retailer of £700.00 (including £116.67 VAT), 12 months' Government Vehicle Excise Duty (variable depending upon model) and the DVLA's new vehicle first registration fee of £55.00. Excludes fuel and insurance. Offers may not apply to Retailer stocks and are subject to availability. Restrictions may apply. Contact your Retailer for details. Vauxhall Motors Limited reserves the right to change, amend or withdraw these offers at any point in time.

## FLEXIBLE FINANCE

Available on selected models only, at participating Retailers. Conditional sale. Finance subject to status. Terms and Conditions apply. Applicants must be 18+. Finance supplied by Vauxhall Finance, CF15 7YT. Vauxhall Deposit Contributions vary and exclude certain models and are only available when vehicle is financed through Vauxhall Finance. 24-48 month term. Offer will apply to private individuals, Vauxhall Partners and small businesses 1- 24 units (purchase only, excluding B2B supported units). All other customers are excluded. Refer to [www.vauxhall.co.uk/offers](http://www.vauxhall.co.uk/offers) or contact your local Vauxhall Retailer for details.

## FLEXIBLE PCP

Offer subject to availability at participating Retailers only. Personal Contract Purchase. Finance subject to status. Terms and Conditions apply. Applicants must be 18+. Finance by Vauxhall Finance, CF15 7YT. 24-48 month term available. Vauxhall deposit contribution only available when vehicle financed through Vauxhall Finance. At the end of the agreement there are three options: i) Pay the optional final payment to own the vehicle, ii) Return the vehicle, or iii) Replace: Part Exchange the vehicle, where equity is available. UK-supplied vehicles only. Offer applies to private individuals, Vauxhall Partners and small businesses 1-24 units (purchase only excluding B2B supported units). All other customers are excluded.

## PERSONAL CONTRACT HIRE

Personal contract hire offer on vehicles ordered by 18 December 2017, subject to availability and status. Age 18+ only. Figures based on a non-maintenance contract hire package. Excess miles over contracted mileage of 24,000 over 36 months charged at a maximum of 14 pence per mile. Excess charges also apply if you breach manufacturer servicing or maintenance guidelines or if the car exceeds BVRLA Fair Wear & Tear guidelines for its age/mileage when it is returned to Vauxhall Leasing. Package includes Road Fund Licence and Vauxhall Assistance. Guarantee/indemnity may be required. Prices and details are subject to change without notice. For full specification and Ts&Cs contact your local Retailer. **You will not own the car.** ALD Automotive Ltd., trading as Vauxhall Leasing, BS16 7LB. Authorised and regulated by the Financial Conduct Authority.

**Please note not all offers apply to all models.**

# MOKKA X ADDITIONAL INFORMATION

## ON-THE-ROAD PRICES

To eliminate uncertainty about hidden costs when buying a new car, Vauxhall publishes on-the-road recommended retail prices (RRP) and these are shown in the pricing tables within this price guide. These prices include VAT, number plates and delivery to Retailer of £700.00 (including £116.67 VAT), 12 months' Government Vehicle Excise Duty (see opposite for details) and the DVLA new vehicle first registration fee of £55.00\*.

Please note: The on-the-road recommended retail price (RRP) does not include fuel supplied by the Retailer, motor insurance or any other goods or services supplied by agreement between the Retailer and the customer.

## PRICE PROTECTION

Order a new Vauxhall for build in the current model year (as confirmed by your Retailer) for delivery no more than three months in advance and the price you are quoted is the price you pay. This is irrespective of any subsequent price rises between placing your order and delivery of your new car, but you must take delivery as soon as the car is available. Vauxhall Motors Limited is not liable for price adjustments caused by Government changes in the rate of VAT (currently 20%), Vehicle Excise Duty, DVLA new vehicle first registration fee or by any other applicable legislation or regulations.

## VEHICLE EXCISE DUTY

The amount of Vehicle Excise Duty (road fund licence) payable on new cars varies depending on the level of carbon dioxide (CO<sub>2</sub>) emissions produced by the vehicle. CO<sub>2</sub> emissions are measured in grammes (g) per kilometre (km) travelled and divided into 13 charging bands shown in the table below.

A 'first year rate' of Vehicle Excise Duty is payable on all new cars and in subsequent years the amount payable reverts to the 'standard rate'. From 1 April 2017 the breakpoints for each of these bands have been revised. Also, for vehicles with a list price over £40,000, including factory-fitted options, an additional £310 is payable for the first five years of standard rate payments.

### Vehicle Excise Duty\*

	CO <sub>2</sub> emissions (g/km)	First year rate	Standard rate
Band A	0	£0.00	£0.00
Band B	1-50	£10.00	£140.00
Band C	51-75	£25.00	£140.00
Band D	76-90	£100.00	£140.00
Band E	91-100	£120.00	£140.00
Band F	101-110	£140.00	£140.00
Band G	111-130	£160.00	£140.00
Band H	131-150	£200.00	£140.00
Band I	151-170	£500.00	£140.00
Band J	171-190	£800.00	£140.00
Band K	191-225	£1200.00	£140.00
Band L	226-255	£1700.00	£140.00
Band M	over 255	£2000.00	£140.00

\* = Correct at time of issue.

## VAUXHALL LEASING

As Vauxhall's own contract hire and fleet management operation, Vauxhall Leasing provides a one-stop-shop for competitive car and van leasing solutions – for business users and private individuals. Working with the Vauxhall Retailer network, we combine the support of a national contract with the convenience of a local contact.

For further information, please see your local Vauxhall Retailer or call us on **0117 908 6433**. Alternatively, you can visit our website at [www.vauxhall-leasing.co.uk](http://www.vauxhall-leasing.co.uk)

## IN THE EVENT OF AN ACCIDENT...

Vauxhall Accident Management helps keep you mobile following an accident. Benefits include vehicle recovery, Vauxhall-approved repairs and contacting your insurer. For more details, visit [vauxhall.co.uk/AccidentManagement](http://vauxhall.co.uk/AccidentManagement)



# TRUST VAUXHALL

## CUSTOMER CARE COMMITMENT

For added peace of mind, Vauxhall has an innovative Customer Care Commitment that offers the following:

- Three-year vehicle warranty consisting of a one-year/unlimited mileage manufacturer's warranty and a second and third year manufacturer's warranty with a 60,000 miles limitation
- Vauxhall Assistance for 12 months from first registration
- Six years' body panel anti-perforation warranty

Please note: Warranty is only available on vehicles sourced from Vauxhall Motors Limited. Terms and conditions apply – please see your Vauxhall Retailer for details.

## VAUXHALL ASSISTANCE

Vauxhall Assistance is provided automatically with every new Vauxhall for 12 months from first registration and covers everything from accident assistance, roadside recovery and 'at home' service to flat tyres. With Vauxhall Assistance help is literally just a free\* phone call away, 24 hours a day, 365 days a year!

\* = Mobile phone users will be charged at their standard tariff.

## PROTECTING THE ENVIRONMENT

Vauxhall's commitment to the environment is demonstrated by our products' many environmental awards. For even more information on Vauxhall's efforts to achieve an environmentally sustainable future, and how to dispose of your end-of-life vehicle, see [www.vauxhall.co.uk/recycling](http://www.vauxhall.co.uk/recycling)

## VAUXHALL SERVICE PLAN

- Fixed monthly payments for the plan duration
- Easy to budget and interest-free
- Genuine parts fitted by Vauxhall-trained technicians

### Plus on Gold plans:

- Valet and courtesy car
- Full AA cover
- Engine flush and fuel treatments
- Litre of oil for top ups between services

Full details can be obtained from your local participating Vauxhall Retailer.

## VAUXHALL INSURANCE WITH ADDED REASSURANCE

Comprehensive cover – Summary of benefits\*\*

- Competitive premiums
- Repairs by a Vauxhall-trained technician
- Genuine Vauxhall parts, guaranteed for three years when we repair your car within our Approved Repairer Network
- Free courtesy car as standard when using an Approved Repairer†
- 24 hour claims helpline
- Personal Accident benefit
- Cover for audio equipment
- Windscreen cover

Call for a quote on 0844 463 2670††

\*\* = The benefits listed above are for comprehensive cover only. For details of Third Party, Fire and Theft cover, please call our sales team.  
† = Should your car need repairing following an accident we provide a courtesy car (subject to availability) for the duration of the repair. Only genuine Vauxhall parts are used. Terms and conditions apply.  
†† = Calls may be recorded. Vauxhall Insurance is underwritten by Ageas Insurance Limited.

## FOR MORE PRODUCT INFORMATION

For a brochure on any Vauxhall model (up to a maximum of three per caller) or location of your nearest Vauxhall Retailer please call **0345 600 1500**. Alternatively, details can be found on our website at [www.vauxhall.co.uk](http://www.vauxhall.co.uk)

## JOIN US ONLINE:



## PROUD SPONSOR OF OUR NATIONAL FOOTBALL TEAMS



Privacy Policy – For full details please visit: [vauxhall.co.uk/privacy](http://vauxhall.co.uk/privacy)

Vauxhall OnStar privacy details are available at [vauxhall.co.uk/onstar](http://vauxhall.co.uk/onstar)

The invoice price, including delivery to Retailer, factory-fitted options, accessories fitted by the Retailer and number plates, is subject to VAT. Some feature descriptions in this guide may refer to, and some illustrations may show, optional equipment not included in the standard delivery. The information contained in this guide was accurate at the time of publication. We reserve the right to make changes in design and equipment. Please note that Vauxhall Retailers are not the agents of Vauxhall Motors Limited and are not authorised to bind Vauxhall Motors Limited by any specific or implied undertaking or representation. It is advisable to ensure that your motor insurance policy provides adequate cover for additional fitted options and accessories. The colours in this guide are only approximate actual colours. Illustrated optional equipment is available at extra charge. Availability, technical features and equipment provided on our vehicles can vary by model. For precise information on the equipment provided on our vehicles, please contact your local Vauxhall Retailer.

# VAUXHALL

[vauxhall.co.uk](http://vauxhall.co.uk)

©2017 Vauxhall Motors Limited

Published 19 December 2017 Vauxhall Motors Limited