

# NEW ZAFIRA TOURER PRICE/SPECIFICATION GUIDE

4 October 2016 | Model Year 2017



**PROUD SPONSOR OF OUR  
NATIONAL FOOTBALL TEAMS**



# NEW ZAFIRA TOURER CUSTOMER OFFERS

At Vauxhall we know that customers appreciate flexibility. Not only do we have an extensive range of New Zafira Tourer models to choose from, on most of them you can also take advantage of our Flexible Finance offer\*, see below for details.

**0% APR**  
REPRESENTATIVE  
**FLEXIBLE FINANCE**



**1 CHOOSE YOUR CAR**  
Select a new vehicle.

**2 CHOOSE YOUR DEPOSIT**  
Any deposit.

**3 CHOOSE YOUR TERM**  
From 24 to 60 months.

For even more great deals contact your local Retailer or call 0345 600 1500 or visit [www.vauxhall.co.uk/offers](http://www.vauxhall.co.uk/offers)

**TERMS AND CONDITIONS:** \*Available on selected models only, at participating Retailers. Conditional Sale. Finance subject to status. Terms and Conditions apply. Applicants must be 18+. Finance supplied by Vauxhall Finance, PO Box 6666, CF15 7YT. 24-60 month term. Offer will apply to private individuals, Vauxhall Partners and small businesses 1- 24 units (purchase only, excluding B2B supported units). All other customers are excluded. Refer to [www.vauxhall.co.uk/offers](http://www.vauxhall.co.uk/offers) or contact your local Vauxhall Retailer for details.

# NEW ZAFIRA TOURER COMPANY CAR DRIVER/FLEET INFORMATION

## DESIGN AND TECH LINE HIGH SPEC, LOW P11D

Specifically developed for businesses and company car drivers alike, our Design and Tech Line models are seriously fit for Fleet.

Design models (Insignia, New Mokka X, New Zafira Tourer, Astra and Corsa) all feature very low P11D values, generous standard specification with a choice of high tech ecoFLEX engines for great fuel economy and low emissions including the 'whisper diesel' 1.6CDTi (from 88g/km and 85.6mpg combined).

For even more standard specification, step up to our Tech Line range (Insignia, Astra, Mokka, New Zafira Tourer and Meriva) again you are guaranteed low P11D values, plus great standard kit including Sat Nav (in lieu of parking sensors and Winter Pack on Meriva), Bluetooth®, USB connection and digital radio (excluding Meriva).

With Design and Tech Line you can take for granted low Whole Life Costs and low company car driver taxation.

## COMPANY CAR DRIVER FREE\* 3 DAY TEST DRIVE

Our free\* 3 Day Test Drive programme is open to all Company Car Drivers which allows you to choose any model in the current Vauxhall line-up (excluding all VXR models and Commercial Vehicles), with full insurance cover provided, to give you a meaningful length of time to make an informed decision about your next company car.

Click below to book your free\* test drive [www.vauxhall3dtd.co.uk](http://www.vauxhall3dtd.co.uk) or call 0870 240 4848\*\*



## BENEFIT IN KIND COMPANY CAR TAXATION†

The car benefit charge will be the car's list price (including VAT, options and accessories fitted, delivery to Retailer and number plates, but excluding Vehicle Excise Duty and new vehicle first registration fee) multiplied by the percentage charge for the CO<sub>2</sub> emissions band in which the car falls (see table opposite). Multiply this figure by your personal income tax rate (20% for Basic Rate, 40% for Higher Rate) to calculate your annual benefit in kind tax liability.

### Example:

**New Zafira Tourer Design 1.6CDTi (134PS)**  
Start/Stop ecoFLEX 5-dr MPV (CO<sub>2</sub> emissions 119g/km)

On-the-road RRP	£21475.00
Deduct: Vehicle Excise Duty	(£0.00)
New vehicle first registration fee	(£55.00)
<b>Effective list price</b>	<b>£21420.00</b>
Add: Optional two-coat metallic paint	£555.00

List price for tax purposes (P11D value)  
£21975.00

<b>Car benefit charge</b>	
2016-17 tax year (23%)	£5054.00
<b>Benefit in kind tax liability (2016-17 tax year)</b>	
Basic Rate (20%) tax payer	£1010.80
Higher Rate (40%) tax payer	£2021.60

† = Please note this Price Guide provides taxation information as a guide only. Vauxhall does not provide taxation guidance. Drivers should always take professional advice on their own tax position.

CO <sub>2</sub> emissions in grams per kilometre	Percentage of car's price to be taxed	
	Petrol 2016-17 tax year	Diesel 2016-17 tax year
up to 50	7	10
51-75	11	14
76-94	15	18
95-99	16	19
100-104	17	20
105-109	18	21
110-114	19	22
115-119	20	23
120-124	21	24
125-129	22	25
130-134	23	26
135-139	24	27
140-144	25	28
145-149	26	29
150-154	27	30
155-159	28	31
160-164	29	32
165-169	30	33
170-174	31	34
175-179	32	35
180-184	33	36
185-189	34	37
190-194	35	37
195-199	36	37
200 and above	37	37

To calculate your own personal liability a car tax calculator is available at: <https://www.vauxhallfleet.co.uk/toolbox>

\*The free 3 Day Test Drive programme is open to Company Car Drivers and excludes fuel and lubricants; congestion charges; parking and speeding fines and the £250 insurance excess (if applicable). It features a wide selection of models from the Vauxhall range (excluding all VXR models and Commercial Vehicles and subject to availability). Drivers must be aged 25 years or over, have held a full driving licence for at least a year and hold a major credit card. You will need to have your driving licence (and proof of identity (i.e. passport) where the driving licence is not a photocard licence) when your car is delivered. While every effort will be made to ensure that at least 3 days are provided for the test drive, this cannot always be guaranteed due to delivery and collection dates and timings. Available for UK Mainland only. Terms and conditions apply. \*\*Telephone lines open Monday-Friday 9.00am to 5.00pm excluding Bank Holidays. Calls may be recorded or monitored for quality and/or training purposes.

## FLEET TOOLBOX

Discover the facts in our online Toolbox for both Company Car Drivers and Fleet Decision Makers. The Fleet Toolbox has a host of useful calculators, comparators, interactive listings and information. Visit the Fleet Toolbox by going to [www.vauxhall-toolbox.co.uk](http://www.vauxhall-toolbox.co.uk)



## ROADTRIP APP

The Vauxhall RoadTrip App is a free app that calculates and logs your mileage expenses for any UK business trips and generates reports to help you complete your mileage claims. Available for both iPhone and Android, visit [www.vauxhall-toolbox.co.uk](http://www.vauxhall-toolbox.co.uk) or visit the iPhone or Android stores and search for Vauxhall RoadTrip to download it to your smartphone or tablet.



## CONTACT VAUXHALL FLEET

Please contact one of our dedicated sales teams who will be happy to help with your particular enquiry.

### Company Car Drivers

Call: 0345 111 2020

Email: [company-car@vauxhallinfo.co.uk](mailto:company-car@vauxhallinfo.co.uk)

Telephone lines are open

– Monday to Friday 8.00am-9.00pm

– Saturday and Sunday 9.00am-6.00pm

### Fleet Decision Makers

Depending on the size of your fleet of vehicles, we have a dedicated team to handle your enquiries. The lines are open Monday to Friday excluding Bank Holidays.

### 1-24 vehicles

Call: 0845 076 2254 (8.30am-5.00pm)

Email: [b2bsales@vauxhall.co.uk](mailto:b2bsales@vauxhall.co.uk)

### 25+ vehicles

Call: 0870 010 0651 (8.30am-5.00pm)

Email: [vauxhallfleet@vauxhall.co.uk](mailto:vauxhallfleet@vauxhall.co.uk)

### Special Vehicles (Police, Fire and Ambulance)

Call: 01525 408 320 (8.30am-5.00pm)

Email: [vauxhallspecialvehicles@vauxhall.co.uk](mailto:vauxhallspecialvehicles@vauxhall.co.uk)

# NEW ZAFIRA TOURER RANGE HIGHLIGHTS

## DESIGN

£18,665-£22,800

### Standard features include:

#### Exterior

- 17-inch alloy wheels
- Black roof rails

#### Interior

- Comfort front seats
- Front centre armrest
- Central storage facility with two cup holders
- Ambient lighting in roof
- Steering column adjustable for reach and rake
- Steering wheel mounted audio controls
- Luggage compartment cover

#### Infotainment

- Digital radio
- IntelliLink
- 7-inch colour touchscreen
- USB connectivity
- Six speakers
- Bluetooth® connectivity

#### Convenience

- Air conditioning
- Cruise control with speed limiter
- Multi-function trip computer
- Electrically operated front and rear windows
- Electrically adjustable/heated door mirrors
- Remote control central locking
- Front and rear parking distance sensors

#### Safety

- Vauxhall OnStar
- Electronic Stability Programme (ESP) and Anti-lock Braking System (ABS)
- Driver's and front passenger's airbags
- Front seat side-impact airbags
- Full-size curtain airbags
- Tyre pressure monitoring system
- ISOFIX child seat restraint system for outer rear seats
- Deactivation switch for front passenger's front and side-impact airbags
- Height-adjustable front and rear seat head restraints
- Electronic engine deadlock immobiliser
- Door-to-door illumination
- LED daytime running lights

## ENERGY

£21,785-£25,920

### Features over Design:

#### Exterior

- Front fog lights
- Chrome-effect lower window surround
- Dark-tinted rear windows
- Silver-effect roof rails

#### Infotainment

- Navi 950 satellite navigation system

## SRI

£23,330-£28,165

### Features over Design:

#### Exterior

- 18-inch alloy wheels (1.4i Turbo/2.0CDTi)
- Front fog lights
- Dark-tinted rear windows
- Silver-effect roof rails

#### Interior

- Three-spoke chrome-bezelled leather-covered steering wheel
- Driver's seat with tilt and four-way electric lumbar adjustment
- Sports style seats
- Sports pedals

#### Safety

- Remote control security alarm system

### SRI Nav models additionally feature

- Navi 950 Satellite navigation system

## SE

£23,315-£27,450

### Features over Design:

#### Exterior

- Front fog lights
- Chrome-effect lower window surround
- Silver-effect roof rails

#### Interior

- Lounge seating
- Three-spoke chrome-bezelled leather-covered steering wheel
- Dark-tinted rear windows
- Electric parking brake
- Electronic climate control

#### Convenience

- Automatic lighting control
- Rain-sensitive windscreen wipers
- FlexRail® centre console system
- Front passenger's underseat storage facility

#### Safety

- Remote control security alarm system

## TECH LINE

£20,360-£24,495

### Features over SE:

#### Infotainment

- Navi 950 satellite navigation system

## ELITE

£24,795-£29,630

### Features over SE:

#### Exterior

- 18-inch alloy wheels
- Panoramic windscreen
- Panoramic sunroof (excludes roof rails)

#### Interior

- Leather seat trim (front and second row seats)
- Ergonomic sports front seats, featuring:
  - Extendable seat cushions and seat tilt adjustment
  - Four-way electrical lumbar adjustment
- Heated front seats

### Elite Nav models additionally feature

- Navi 950 Satellite navigation system

# NEW ZAFIRA TOURER PRICES

Model 5-door MPV	Price (£)	VAT (£)	Total (£)	On-the-road RRP (£)	CO <sub>2</sub> (g/km)	Model 5-door MPV	Price (£)	VAT (£)	Total (£)	On-the-road RRP (£)	CO <sub>2</sub> (g/km)
<b>DESIGN VAUXHALL OnStar</b>						<b>SE VAUXHALL OnStar</b>					
1.4i Turbo (140PS)	14770.83	2954.17	17725.00	<b>18665.00</b>	158	1.4i Turbo (140PS)	18645.83	3729.17	22375.00	<b>23315.00</b>	158
1.4i Turbo (140PS) auto	16037.50	3207.50	19245.00	<b>20185.00</b>	160	1.4i Turbo (140PS) auto	19912.50	3982.50	23895.00	<b>24835.00</b>	160
<i>Diesel</i>						<i>Diesel</i>					
1.6CDTi (134PS) S/S ecoFLEX BlueInjection*	17266.67	3453.33	20720.00	<b>21475.00</b>	119**	1.6CDTi (134PS) S/S ecoFLEX BlueInjection*	21141.67	4228.33	25370.00	<b>26125.00</b>	119†
2.0CDTi (170PS) S/S BlueInjection*	17433.33	3486.67	20920.00	<b>21675.00</b>	129	2.0CDTi (170PS) S/S BlueInjection*	21308.33	4261.67	25570.00	<b>26325.00</b>	129
2.0CDTi (170PS) auto BlueInjection*	18216.67	3643.33	21860.00	<b>22800.00</b>	161	2.0CDTi (170PS) auto BlueInjection*	22091.67	4418.33	26510.00	<b>27450.00</b>	161
<b>ENERGY VAUXHALL OnStar</b>						<b>TECH LINE VAUXHALL OnStar</b>					
1.4i Turbo (140PS)	17370.83	3474.17	20845.00	<b>21785.00</b>	158	1.4i Turbo (140PS)	16183.33	3236.67	19420.00	<b>20360.00</b>	158
1.4i Turbo (140PS) auto	18637.50	3727.50	22365.00	<b>23305.00</b>	160	1.4i Turbo (140PS) auto	17450.00	3490.00	20940.00	<b>21880.00</b>	160
<i>Diesel</i>						<i>Diesel</i>					
1.6CDTi (134PS) S/S ecoFLEX BlueInjection*	19866.67	3973.33	23840.00	<b>24595.00</b>	119**	1.6CDTi (134PS) S/S ecoFLEX BlueInjection*	18679.17	3735.83	22415.00	<b>23170.00</b>	119†
2.0CDTi (170PS) S/S BlueInjection*	20033.33	4006.67	24040.00	<b>24795.00</b>	129	2.0CDTi (170PS) S/S BlueInjection*	18845.83	3769.17	22615.00	<b>23370.00</b>	129
2.0CDTi (170PS) auto BlueInjection*	20816.67	4163.33	24980.00	<b>25920.00</b>	161	2.0CDTi (170PS) auto BlueInjection*	19629.17	3925.83	23555.00	<b>24495.00</b>	161
<b>SRI VAUXHALL OnStar</b>						<b>ELITE VAUXHALL OnStar</b>					
1.4i Turbo (140PS)	18658.33	3731.67	22390.00	<b>23330.00</b>	158	1.4i Turbo (140PS)	19879.17	3975.83	23855.00	<b>24795.00</b>	158
1.4i Turbo (140PS) auto	19925.00	3985.00	23910.00	<b>24850.00</b>	160	1.4i Turbo (140PS) auto	21145.83	4229.17	25375.00	<b>26315.00</b>	160
<i>Diesel</i>						<i>Diesel</i>					
1.6CDTi (134PS) S/S ecoFLEX BlueInjection*	21154.17	4230.83	25385.00	<b>26140.00</b>	119†	2.0CDTi (170PS) S/S BlueInjection*	22487.50	4497.50	26985.00	<b>27870.00</b>	137
2.0CDTi (170PS) S/S BlueInjection*	21266.67	4253.33	25520.00	<b>26405.00</b>	137	2.0CDTi (170PS) auto BlueInjection*	23325.00	4665.00	27990.00	<b>28930.00</b>	161
2.0CDTi (170PS) auto BlueInjection*	22104.17	4420.83	26525.00	<b>27465.00</b>	161	<b>ELITE NAV VAUXHALL OnStar</b>					
<b>SRI NAV VAUXHALL OnStar</b>						1.4i Turbo (140PS)	20462.50	4092.50	24555.00	<b>25495.00</b>	158
1.4i Turbo (140PS)	19241.67	3848.33	23090.00	<b>24030.00</b>	158	1.4i Turbo (140PS) auto	21729.17	4345.83	26075.00	<b>27015.00</b>	160
1.4i Turbo (140PS) auto	20508.33	4101.67	24610.00	<b>25550.00</b>	160	<i>Diesel</i>					
<i>Diesel</i>						2.0CDTi (170PS) S/S BlueInjection*	23070.83	4614.17	27685.00	<b>28570.00</b>	137
1.6CDTi (134PS) S/S ecoFLEX BlueInjection*	21737.50	4347.50	26085.00	<b>26840.00</b>	119†	2.0CDTi (170PS) auto BlueInjection*	23908.33	4781.67	28690.00	<b>29630.00</b>	161
2.0CDTi (170PS) S/S BlueInjection*	21850.00	4370.00	26220.00	<b>27105.00</b>	137	<b>Please note:</b> On-the-road recommended retail prices (RRP) include number plates and delivery to retailer of £700.00 (inc. £116.67 VAT), 12 months' Vehicle Excise Duty and new vehicle first registration fee of £55.00. Excludes fuel and insurance.					
2.0CDTi (170PS) auto BlueInjection*	22687.50	4537.50	27225.00	<b>28165.00</b>	161	<b>S/S = Start/Stop</b>					

S/S = Start/Stop

\* = Please note: Vehicles with BlueInjection technology will need regular AdBlue® top-ups also between servicing requirements.

An indicator integrated into the on-board computer will warn you when you need to top up. More information under

[www.vauxhall.co.uk/blueinjection](http://www.vauxhall.co.uk/blueinjection). In accordance with regulations R (EC) No. 715/2007 and R (EC) No. 692/2008 (in the versions respectively applicable).

\*\* = Provisional data. † = Provisional data. CO<sub>2</sub> emissions are based on vehicles fitted with standard 17-inch alloy wheels. If optional alloy wheels are specified, at extra cost, CO<sub>2</sub> emissions will be affected.

# NEW ZAFIRA TOURER FEATURES/OPTIONS

## SAFETY

### Driver/passenger airbags

- Driver's airbag • Front passenger's airbag • Two front seat side-impact airbags
- Full-size curtain airbags for driver and front and outer rear seat passengers

### Seating

- Height-adjustable active-safety front seat head restraints • Height adjustable front and outer rear seat head restraints • Anti-submarining ramps in front seats – Prevents occupants sliding underneath the lap belt during a collision

### Seatbelts

- Five lap and diagonal inertia-reel seatbelts (height-adjustable front) • Third-row lap and diagonal inertia-reel seatbelts (height restrictions apply!) • Front body-lock diagonal seatbelt pretensioner system – Tightens the seatbelt during the early stages of a frontal impact • Drivers and front passenger's lap belt pretensioner system • Front seatbelt force limiters – Reduces potential upper body injuries during a frontal impact • Anti-submarining ramps in front seats – Help prevent occupants sliding underneath the lap belt during a collision

### Child safety

- Deactivation switch for front passenger seat front airbag – Permits the safe use of a child seat in the front passenger seat • ISOFIX child seat mountings incorporating top tether anchor points located on outer rear seats (does not include child seat) – Allows ISOFIX child safety seats to be securely fixed into the car. The ISOFIX mounting system reduces forward movement in an accident and makes the child seat easier to install • Child-proof locks on rear doors

### Driver/passenger safety

- Energy-absorbing steering column • Pedal release system – Reduces potential injury to the driver's legs and feet during a severe frontal impact • Laminated windscreen • Side-impact protection beams • Reinforced passenger safety cell • Deformation zones front and rear
- Burst-proof door locks and anti-jam door design

### Pedestrian safety

- Bonnet/headlight/wiper structure – Designed to reduce pedestrian head and upper body injuries
- Upper and lower bumper design – Reduces upper and lower leg injuries

### Stability

- Electronic Stability Programme (ESP) – Works in conjunction with the vehicle's electronic braking and engine systems to keep the car stable in many different situations. ESP monitors many different inputs to determine when the car starts to lose traction, it can then immediately respond by varying the brake pressure between up to three wheels and adjust the engine output to help correct the loss of traction and improve stability. ESP functions include: • Cornering brake control • Straight line stability control • Rollover mitigation • Drag torque control – Maintain stability on slippery roads when lifting off the accelerator or changing gear

### Braking

- Anti-lock Braking System (ABS) – Prevents the vehicle's wheels from locking up under heavy braking by momentarily reducing brake pressure at the appropriate wheel, ensuring that you can maintain control of the steering • Additional braking features – The same electronic systems used in the ABS and ESP also deliver exceptional braking performance • Emergency brake assist – When emergency braking is detected the vehicle automatically applies the maximum possible braking assistance • Fading brake support – Compensates for the effects of brake fade • Electronic brakeforce distribution – Automatically apportions the optimum braking force to each wheel
- Adaptive brake lights – Automatically warns other road users of heavy braking • Hazard warning lights

### Tyre pressure

- Tyre pressure monitoring system

## SECURITY

### Standard security features

- 'Key left in ignition' audible warning • Electronically protected audio equipment • Engine deadlock immobiliser
- Visible Vehicle Identification Number (VIN) • Locking wheel bolts for alloy wheels • Freewheeling door locks

### Remote control central locking

- Operates on doors, tailgate and fuel filler flap • Deadlocking • Central locking activation switch on facia
- One folding key/one static key each with integral remote control function

### Remote control ultrasonic security alarm system

- Remote control (operates in conjunction with central locking) • Ultrasonic interior sensors • Tilt sensor
- Thatcham approved

● = Standard equipment. ○ = Optional at extra cost.

1 = When all seats are occupied within the New Zafira Tourer the passenger side third-row seat is only usable by a passenger up to a maximum height of 150cm.

	Design	Energy	SRi	SE	Tech Line	Elite	Price (£) exc. VAT	Total (£) inc. VAT
Standard security features	●	●	●	●	●	●		
Remote control central locking	●	●	●	●	●	●		
Remote control ultrasonic security alarm system	○	○	●	●	●	●	216.67	260.00

# NEW ZAFIRA TOURER FEATURES/OPTIONS

<b>DRIVER ASSISTANCE</b>	<i>Design</i>	<i>Energy</i>	<i>SRI</i>	<i>SE</i>	<i>Tech Line</i>	<i>Elite</i>	Price (£) exc. VAT	Total (£) inc. VAT
<b>Steering</b> <ul style="list-style-type: none"> <li>Speed sensitive electrically assisted power steering</li> <li>Reach and rake adjustable steering</li> </ul>	●	●	●	●	●	●		
<b>Cruise control with speed limiter:</b> <i>The cruise control feature enables you to maintain a constant speed – making it ideal for economical motorway driving. The speed limiter function can be set to ensure that you do not exceed the speed limit and can be easily overridden if required.</i> <ul style="list-style-type: none"> <li>Steering wheel mounted controls</li> </ul>	●	●	●	●	●	●		
<b>Electric parking brake incorporating hill start assist</b> <ul style="list-style-type: none"> <li>Centre console switch in lieu of handbrake lever</li> <li>Premium centre console featuring adjustable armrest</li> </ul>				●	●	●		
<b>Front camera system</b> <i>A wide range of class-leading driver assistance and safety features are controlled by the front camera system</i> <b>Traffic sign recognition:</b> <i>Detects and then displays speed limits, reducing uncertainty and the risk of speeding.</i> <ul style="list-style-type: none"> <li>Recognises different road signs, including temporary speed restrictions</li> <li>Displays reminder in the driver information centre</li> </ul> <b>Following distance indicator:</b> <i>Indicates how many seconds you are behind the vehicle in front – helping you maintain a safe distance.</i> <ul style="list-style-type: none"> <li>Timings are shown in the driver information centre</li> </ul> <b>Lane departure warning with lane assist:</b> <i>If the driver has not actively steered or signalled, the lane departure warning system warns when the car moves outside of lane markings at speeds above 37mph. The lane keep assist function additionally provides gentle steering correction to help drivers keep in their lane if no active inputs are made.</i> <ul style="list-style-type: none"> <li>Warning light in instrument cluster</li> <li>Audible warning</li> <li>Steering wheel 'nudge' warning</li> <li>Facia on/off switch</li> <li>Both systems switch to standby when in road works or when road markings are confused</li> </ul>				○	○	○	670.83	<b>805.00</b>

● = Standard equipment. ○ = Optional at extra cost.

# NEW ZAFIRA TOURER FEATURES/OPTIONS

	Design	Energy	SRi	SE	Tech Line	Elite	Price (£) exc. VAT	Total (£) inc. VAT
<p><b>DRIVER ASSISTANCE</b></p> <p><b>Driver Assistance Pack Two</b>  <i>A wide range of class-leading driver assistance and safety features are controlled by the front camera system</i>  <b>Forward collision alert with automatic city emergency braking:</b>  <i>In certain circumstances and:</i>  <i>At speeds above 5mph warns when approaching another vehicle too quickly. At speeds above 5mph and up to 53mph the system provides additional braking support to help the driver brake more quickly and effectively in an emergency situation. At speeds above 5mph and up to 37mph if no avoiding action is taken by the driver, the system automatically slows the vehicle with emergency braking.</i>                      • Visual warnings – projected onto windscreen and shown in the instrument cluster • Audible warning                      • Additional braking support • Low speed collision mitigation braking</p> <p><b>Adaptive cruise control:</b>  <i>Adaptive cruise control automatically decelerates the vehicle when approaching a slower moving vehicle. It then adjusts the vehicles speed to follow the vehicle at the selected following distance. The vehicle speed increases or decreases to follow the vehicle in front, but will not exceed the set speed.</i></p> <p><b>Side blind spot alert:</b>  <i>Side blind spot alert helps prevent potential collisions with other vehicles 'hidden' in the vehicle's side blind spots. If a vehicle enters one of the blind spots a warning light illuminates in the relevant door mirror.</i>                      • Ultrasonic side sensors with three-metre range • LED warning light in door mirrors                      • Audible warning is sounded if the indicators are used and the system has detected another vehicle                      • Electrically folding door mirrors</p> <p><b>Following distance indicator:</b>  <i>Indicates how many seconds you are behind the vehicle in front – helping you maintain a safe distance.</i>                      • Timings are shown in the driver information centre</p>							837.50	<b>1005.00</b>
<p><b>Front and rear parking distance sensors</b>                      • Front and rear parking distance sensors                      • Audible warning</p>	●	●	●	●	●	●		
<p><b>Rear-view camera<sup>2</sup></b>  <i>The rear-view camera gives a clear view of the area behind your car and helps place the car perfectly, without needing to strain your neck.</i>                      • Activated when reverse gear selected • Camera view appears in infotainment screen                      • Rear bumper and one-metre grid lines shown as reference points</p>		○	○	○	○	○	175.00	<b>210.00</b>
<p>FlexRide adaptive chassis control system with continuous damping control</p>				○	○	○	666.67	<b>800.00</b>

● = Standard equipment. ○ = Optional at extra cost.

2 = Only available in conjunction with Navi 950 IntelliLink system.



# NEW ZAFIRA TOURER FEATURES/OPTIONS

	Design	Energy	SRI	SE	Tech Line	Elite	Price (£) exc. VAT	Total (£) inc. VAT
<b>DRIVER INFORMATION</b>								
<b>Instrumentation</b> • Speedometer • Rev counter • Fuel gauge with low fuel level warning light • Water temperature gauge with warning light • Shift-up/down indication light – <i>Indicates when to change gear for optimum fuel economy</i>	●	●	●	●	●	●		
<b>Driver information display (centrally located in instrument cluster)</b> • Monochrome display • Displays trip computer data • Total mileage • Service-due indicator • Oil life • Tyre pressure monitoring system	●	●	●	●	●	●		
<b>Multi-function trip computer (displayed on driver information display)</b> • Trip mileage • Vehicle range based on remaining fuel • Average speed • Average fuel economy • Instantaneous fuel economy • Driving time	●	●	●	●	●	●		
<b>Central fascia display (format dependent on infotainment unit)</b> • Audio information • Digital clock with automatic RDS time adjustment • Outside air temperature with ice warning function • Additional features dependent on infotainment unit (see infotainment for details)	●	●	●	●	●	●		
<b>INTERIOR STYLING</b>								
<b>Design/Energy interior décor</b> <i>Steering wheel:</i> • Three-spoke design • Satin chrome-effect bezel <i>Facia and door trim:</i> • Black facia with Silver trim inserts • Black door panels with black Atlantis cloth inserts • Blasted Silver trim inserts on front doors • Chrome-effect interior door handles <i>Seat trim:</i> • Mando fabric seat trim inserts • Plain black fabric side bolsters and surrounds	●	●						
<b>SE/Tech Line interior décor</b> <i>Steering wheel:</i> • Three-spoke design • Leather-covered with accent stitching • Satin chrome-effect bezel <i>Facia and door trim:</i> • Black facia with Ruthenium trim inserts • Plain black door panels with black Siena cloth inserts • Ruthenium trim inserts on front doors • Chrome-effect interior door handles <i>Seat trim:</i> • Lilop fabric seat trim inserts • Plain black Morrocana-trimmed side bolsters				●	●			
<b>SE/Tech Line interior décor</b> <i>Steering wheel:</i> • Three-spoke design • Leather-covered with accent stitching • Satin chrome-effect bezel <i>Facia and door trim:</i> • Black facia with Ruthenium trim inserts • Light neutral door panels with black Siena cloth inserts • Ruthenium trim inserts on front doors • Chrome-effect interior door handles <i>Seat trim:</i> • Lilop fabric seat trim inserts • Light neutral Morrocana-trimmed side bolsters				N/C	N/C		<b>No-cost option</b>	
<b>SRI interior décor</b> <i>Steering wheel:</i> • Three-spoke design • Leather-covered with accent stitching • Satin chrome-effect bezel <i>Facia and door trim:</i> • Black facia with Silver trim inserts • Silver air vent surrounds • Black door panels with black Atlantis cloth inserts • Blasted Silver trim inserts on front doors • Chrome-effect interior door handles <i>Seat trim:</i> • Lace fabric seat trim inserts • Plain black fabric side bolsters and surrounds			●					
<b>Elite interior décor</b> <i>Steering wheel:</i> • Three-spoke design • Leather-covered with accent stitching • Satin chrome-effect bezel <i>Facia and door trim:</i> • Black facia with Ruthenium trim inserts • Silver air vent surrounds • Black door panels with black Leather-effect inserts • Ruthenium trim inserts on front doors • Chrome-effect interior door handles <i>Seat trim:</i> • Black Siena leather seat trim inserts • Black leather-effect side bolsters and surrounds						●		

● = Standard equipment. ○ = Optional at extra cost. N/C = No-cost option.

# NEW ZAFIRA TOURER FEATURES/OPTIONS

<b>AUDIO, COMMUNICATION AND NAVIGATION</b>	Design	Energy	SRi	SE	Tech Line	Elite	Price (£) exc. VAT	Total (£) inc. VAT
<b>R4.0 IntelliLink touchscreen infotainment system</b> <i>For use with MP3 players, USB memory sticks, mobile phones and smartphone apps</i> <b>Onboard features:</b> <ul style="list-style-type: none"> <li>7-inch colour touchscreen</li> <li>DAB digital radio/AM/FM stereo radio with 36 station presets</li> <li>RDS with Traffic Programme</li> </ul> <b>Media connections:</b> <ul style="list-style-type: none"> <li>USB connection with iPod control</li> <li>Bluetooth® A2DP audio streaming (Advanced Audio Distribution Profile)</li> </ul> <b>Mobile phone portal:</b> <ul style="list-style-type: none"> <li>Bluetooth® connectivity</li> <li>Handsfree calls via steering wheel controls</li> <li>Vehicle microphone</li> <li>Phone book access – <i>Contacts/last calls/missed calls etc. are mirrored on IntelliLink's display and are easily navigated using the touchscreen (features dependent on mobile phone)</i></li> </ul> <b>Smartphone interface:</b> <ul style="list-style-type: none"> <li>Apple CarPlay</li> <li>Android Auto</li> </ul>	●		● <sup>3</sup>	●		● <sup>3</sup>		
<b>Navi 950 IntelliLink touchscreen navigation and infotainment system</b> <i>For use with MP3 players, USB memory sticks, mobile phones and smartphone apps</i> <b>Onboard features:</b> <ul style="list-style-type: none"> <li>7-inch colour touchscreen</li> <li>DAB digital radio/AM/FM stereo radio with 36 station presets</li> <li>RDS with Traffic Programme</li> <li>60 configurable favourites including contacts, addresses, playlists, radio stations and voice recognition</li> </ul> <b>Navigation features:</b> <ul style="list-style-type: none"> <li>Satellite navigation system</li> <li>3D street level mapping</li> <li>European coverage</li> </ul> <b>Media connections:</b> <ul style="list-style-type: none"> <li>USB connection with iPod control</li> <li>Bluetooth® A2DP audio streaming (Advanced Audio Distribution Profile)</li> </ul> <b>Mobile phone portal:</b> <ul style="list-style-type: none"> <li>Bluetooth® connectivity</li> <li>Handsfree calls via steering wheel controls</li> <li>Vehicle microphone</li> <li>Phone book access – <i>Contacts/last calls/missed calls etc. are mirrored on IntelliLink's display and are easily navigated using the touchscreen (features dependent on mobile phone)</i></li> </ul>	○	●	▲	○	●	▲	591.67	<b>710.00</b>
Six speakers (four front, two rear)	●	●	●	●	●	●		
Steering wheel mounted audio controls	●	●	●	●	●	●		
USB power socket for rear seat passengers	●	●	●	●	●	●		

● = Standard equipment. ○ = Optional at extra cost. ▲ = Standard on Nav models, see pricing pages for details.

3 = Standard on non Nav models.

# NEW ZAFIRA TOURER FEATURES/OPTIONS

<b>AUDIO, COMMUNICATION AND NAVIGATION</b>	Design	Energy	SRi	SE	Tech Line	Elite	Price (£) exc. VAT	Total (£) inc. VAT
<p><b>Vauxhall OnStar – Your personal on board assistant*</b></p> <p><i>Many car brands talk about innovation as soon as they improve their cup holders but this innovative system, now available on selected models**, is revolutionary: 24/7, 365 days a year, Vauxhall OnStar puts you in touch with a trained advisor, not a machine. With OnStar you have access to a host of innovations, from Vehicle Diagnostics and Smartphone Function to a fully integrated 4G Wi-Fi Hotspot†. In the event of an accident, Vauxhall OnStar even automatically calls for help, for an incomparable feeling of safety.</i></p> <p><small>* = Includes 12 months of OnStar services from date of first registration and a 3 month/3 GB Wi-Fi free trial period (whichever comes first) effective from the date the customer accepts the nominated network operator Wi-Fi Ts&amp;Cs. Destination download feature only operates on models fitted with Navi 950 IntelliLink satellite navigation system. Theft alert feature only operates on models fitted with security alarm system. ** = The OnStar Services require activation and are subject to mobile network coverage and availability. Wi-Fi Hotspot service requires account with nominated network operator. † = 4G is subject to mobile network coverage and availability. Charges apply after the free trial period. The OnStar subscription packages could be different from the services included in the free trial package. Check <a href="http://www.vauxhall.co.uk/onstar">www.vauxhall.co.uk/onstar</a> for terms and conditions, details of availability, coverage and charges.</small></p>	●	●	●	●	●	●		

## HEATING AND VENTILATION

<p><b>Air conditioning</b></p> <ul style="list-style-type: none"> <li>• Air recirculation facility • Cabin particulate filter – Removes dust, airborne particles and pollen</li> <li>• Multi-speed fan • Illuminated controls</li> </ul>	●	●	●					
<p><b>Electronic climate control including air conditioning</b></p> <ul style="list-style-type: none"> <li>• Dual zone control – allowing different, temperature settings for driver and front passenger</li> <li>• Advanced predictive logic control system using sun and humidity sensors</li> <li>• Partial air recirculation – Faster warm up/cool down • Cabin particulate filter – Removes dust, airborne particles and pollen</li> <li>• Automatic air direction and fan speed with manual override • LCD temperature display • Illuminated controls</li> <li>• Rear floor heating ducts</li> </ul>			○	●	●	●	337.50	<b>405.00</b>
<p><b>Additional features</b></p> <ul style="list-style-type: none"> <li>• Four adjustable facia vents • Windscreen demist vents • Side window demist vents • Heated rear screen with timed cut-off</li> </ul>	●	●	●	●	●	●		
Heated leather-covered steering wheel			○ <sup>4</sup>	□	□	○	91.67	<b>110.00</b>
<p><b>Winter Pack</b></p> <ul style="list-style-type: none"> <li>• Heated leather-covered steering wheel • Heated front seats (standard on Elite/Elite Nav models)</li> </ul>			○ <sup>5</sup>	○	○		304.17	<b>365.00</b>

● = Standard equipment. ○ = Optional at extra cost. □ = Available as part of an extra-cost option pack.

4 = Only available with optional Leather Pack. 5 = Only available with standard seat trim.

# NEW ZAFIRA TOURER FEATURES/OPTIONS

	Design	Energy	SRI	SE	Tech Line	Elite	Price (£) exc. VAT	Total (£) inc. VAT
<b>SEATING AND COMFORT</b>								
Flex7 <sup>®</sup> seating system	●	●	●	●	●	●		
<b>Comfort front seats</b> <i>Driver's seat (eight-way adjustable):</i> • Height (up/down) • Reach (fore/aft) • Backrest recline (upright/incline) • Head restraint (up/down) <i>Front passenger's seat (six-way adjustable):</i> • Reach (fore/aft) • Backrest (upright/recline) • Head restraint (up/down)	●	●		●	●			
<b>Sports-style front seats</b> <i>Driver's seat (eight-way adjustable):</i> • Height (up/down) • Reach (fore/aft) • Backrest recline (upright/incline) • Head restraint (up/down) <i>Front passenger's seat (six-way adjustable):</i> • Reach (fore/aft) • Backrest (upright/recline) • Head restraint (up/down)			●					
<b>Ergonomic driver's sport style seat (AGR-approved*) with sports-style front passenger seat</b> <i>Driver's seat (16-way adjustable):</i> • Height (up/down) • Reach (fore/aft) • Tilt (fore/aft) • Backrest (upright/recline) • Seat cushion extension (fore/aft) • Lumbar adjustment (four-way electrical) • Head restraint (up/down) <i>Front passenger's seat (eight-way adjustable):</i> • Reach (fore/aft) • Backrest (upright/recline) • Head restraint (up/down) • Seat cushion extension (fore/aft)			□	○ <sup>6</sup>	○ <sup>6</sup>	●	400.00	<b>480.00</b>
<b>Ergonomic driver's and front passenger's seat pack</b> <i>Drivers and front passenger's seats (18-way adjustable):</i> • Height (up/down) • Reach (fore/aft) • Tilt (fore/aft) • Backrest (upright/recline) • Seat cushion extension (fore/aft) • Lumbar adjustment (four-way electrical) • Active head restraint (fore/aft/up/down)				● <sup>7</sup>	● <sup>7</sup>			
<b>Leather Pack</b> • Leather seat facings (front and second row seats) with Morrocana trimmed side bolsters • Heated front seats <i>Driver's seat (16-way adjustable):</i> • Height (up/down) • Reach (fore/aft) • Tilt (fore/aft) • Backrest (upright/recline) • Seat cushion extension (fore/aft) • Lumbar adjustment (four-way electrical) • Head restraint (up/down) <i>Front passenger's seat (eight-way adjustable):</i> • Reach (fore/aft) • Backrest (upright/recline) • Head restraint (up/down) • Seat cushion extension (fore/aft)			○			●	883.33	<b>1060.00</b>
<b>Seat Comfort Pack One</b> • Driver's seat with four-way electrical lumbar adjustment and manual cushion extension	○	○	●	○	○	●	150.00	<b>180.00</b>
<b>Seat Comfort Pack Two</b> • Driver's and front passenger's seat with four-way electrical lumbar adjustment and manual cushion extension	○	○		○ <sup>8</sup>	○		275.00	<b>330.00</b>
<b>Rear seating</b> • Height-adjustable and removable head restraints (second and third row seats) • 35/30/35 split-folding second-row seats • Second-row seats with sliding function plus fold-flat facility • Two individual fold flat third-row seats (height restrictions apply <sup>1</sup> ) • Storage pockets on front seat backs • ISOFIX child seat mountings incorporating top tether anchor points located on outer rear seats (does not include child seat) – <i>Allows ISOFIX child safety seats to be securely fixed into the car. The ISOFIX mounting system reduces forward movement in an accident and makes the child seat easier to install</i> • Child-proof locks on rear doors	●	●	●	●	●	●		
• Front passenger's underseat storage facility				●	●	●		
• Lounge seating – <i>three individual second-row seats with the ability to convert into two 'captain' seats with individual centre armrest</i>				●	●	●		

● = Standard equipment. ○ = Optional at extra cost. □ = Available as part of an extra-cost option pack. \* AGR (The Campaign for Healthier Backs) is an independent centre of excellence for ergonomics, based in Germany.

<sup>1</sup> = When all seats are occupied within the New Zafira Tourer passenger side third-row seat is only usable by a passenger up to a maximum height of 150cm. <sup>6</sup> = Changes standard trim to Lace cloth. <sup>7</sup> = Standard with optional Light Neutral seat trim. <sup>8</sup> = Deletes front passenger's underseat storage facility.

# NEW ZAFIRA TOURER FEATURES/OPTIONS

	Design	Energy	SRI	SE	Tech Line	Elite	Price (£) exc. VAT	Total (£) inc. VAT
<b>INTERIOR CONVENIENCE</b>								
<b>Convenience features</b> • 12-volt electrical accessory socket within front and rear centre console • Driver's and front passenger's sunvisors incorporating illuminated vanity mirrors with covers • Dipping rear-view mirror	●	●	●	●	●	●		
12-volt electrical accessory socket within luggage compartment	□	□	□	□	□	□		
Automatically dimming anti-dazzle rear-view mirror			□	●	●	●		
Central storage facility with two cupholders and front centre armrest	●	●	●					
FlexRail® centre console system featuring aluminium rails, sliding tray/cup holder and front centre armrest				●	●	●		
Rear side window sunblinds	○	○	○	○	○	○	91.67	<b>110.00</b>

## INTERIOR LIGHTING

<b>Standard lighting</b> • Central front courtesy light • Central rear courtesy light • Fade up/fade down	●	●	●	●	●	●		
<b>Premium lighting</b> • First and second row reading lights with illuminated switches • Third row passenger compartment reading lights • Ambient LED fascia/centre console downlighter • Driver's and front passenger's vanity mirrors with covers • Illuminated glove box and luggage area • Ambient LED lighting in fascia and front doors	●	●	●	●	●	●		

## INTERIOR STORAGE

<b>Interior storage</b> • Storage box on driver's side lower fascia • Glovebox with lid • Front door pockets • Third row central storage facility with two cup holders • Rear door pockets • Storage pockets on front seat backs	●	●	●	●	●	●		
<b>Loading Pack</b> • Vertical load restraining net • FlexCover interior protection liner • 12-volt electrical accessory socket within luggage compartment	○	○	○	○	○	○	104.17	<b>125.00</b>
<b>Luggage area</b> • Luggage compartment cover • Illuminated load area • Fully carpeted load area • Interior tailgate handle • Four load restraint lashing eyes • Twin gas-assisted tailgate struts	●	●	●	●	●	●		
<b>FlexOrganiser® Pack</b> • FlexOrganiser® rails • Restraint net with two bars • Small luggage restraint net • Adaptors	○	○	○	○	○	○	133.33	<b>160.00</b>

● = Standard equipment. ○ = Optional at extra cost. □ = Available as part of an extra-cost option pack.

# NEW ZAFIRA TOURER FEATURES/OPTIONS

	Design	Energy	SRI	SE	Tech Line	Elite	Price (£) exc. VAT	Total (£) inc. VAT
<b>EXTERIOR LIGHTING</b>								
<b>Standard lighting features</b>								
<ul style="list-style-type: none"> <li>• LED daytime running lights • Ellipsoid headlights • Side repeat indicators</li> <li>• Lights-on audible warning • Electric headlight beam levelling • High-level LED centre rear brake light • Rear fog light</li> <li>• Reversing light • Hazard warning lights • Door-to-door illumination • Dark-style tail lights</li> </ul>	●	●	●	●	●	●		
<ul style="list-style-type: none"> <li>• Automatic lighting control with tunnel detection and digital high beam assist</li> </ul>			□	●	●	●		
Dark-style headlights			●					
Chrome-effect headlights	●	●		●	●	●		
<b>Premium Forward Lighting Pack</b>								
<ul style="list-style-type: none"> <li>• Intelligent Adaptive Forward Lighting (AFL) • LED headlights with dynamic beam levelling</li> <li>• LED daytime running lights • LED tail lights</li> </ul>			○ <sup>9</sup>	○	○	○	750.00	<b>900.00</b>
<b>Sight and Light Pack</b>								
<ul style="list-style-type: none"> <li>• Automatic lighting control with tunnel detection • Rain-sensitive windscreen wipers</li> <li>• Electro-chromatic anti-dazzle rear-view mirror • Digital high beam assist</li> </ul>			○	●	●	●	200.00	<b>240.00</b>
Front fog lights		●	●	●	●	●		
LED tail lights			□	□	□	□		

● = Standard equipment. ○ = Optional at extra cost. □ = Available as part of an extra-cost option pack.

<sup>9</sup> = Only available in conjunction with optional Sight and Light Pack.

# NEW ZAFIRA TOURER FEATURES/OPTIONS













	Design	Energy	SRI	SE	Tech Line	Elite	Price (£) exc. VAT	Total (£) inc. VAT
<b>EXTERIOR CONVENIENCE</b>								
<b>Windscreen wipers</b> • Two-speed windscreen wipers with variable intermittent wipe • Intermittent rear window wash/wipe • Rain-sensitive windscreen wipers	●	●	●	●	●	●		
<b>Door mirrors</b> • Twin electrically adjustable/heated door mirrors • Manually folding door mirrors • Electrically foldable door mirrors	●	●	□	●	●	●		
<b>Windows</b> • Electrically operated front and rear windows with safety autoreverse and one-touch facility • Heated rear window	●	●	●	●	●	●		
<b>Electro Pack</b> • Electrically foldable door mirrors • 12-volt electrical accessory socket within luggage compartment	○	○	○	○	○	○	141.67	<b>170.00</b>
<b>Panoramic windscreen and panoramic sunroof<sup>10</sup></b> • Electrically operated interior sunblind			○	○	○	●	508.33	<b>610.00</b>
<b>Roof rails</b> • Black • Silver-effect	●							
Flex-Fix <sup>®</sup> integrated carrier system (includes two-bicycle carrier attachments) <sup>11</sup>			○	○	○	○	758.33	<b>910.00</b>
<b>Towing Pack</b> • Detachable tow bar • Trailer stability programme integrated into ESP system	○	○	○	○	○	○	591.67	<b>710.00</b>
<b>EXTERIOR STYLING</b>								
<b>Body styling</b> • Chrome-effect front grille bar • Chrome-effect headlight detail • Body-colour door handles • Body-colour door mirrors • Black trim on door pillars • Body-colour rear roof spoiler • Chrome-effect side window mouldings	●	●	●	●	●	●		
<b>VXR Styling Pack<sup>12</sup></b> • Body-colour front lower spoiler, side sills, rear lower skirt and rear roof spoiler	○	○	○	○	○	○	791.67	<b>950.00</b>
<b>Windows</b> • Solar heat-absorbing windscreen • Tinted windows • Dark-tinted rear windows	●	●	●	●	●	●		

● = Standard equipment. ○ = Optional at extra cost. □ = Available as part of an extra-cost option pack.

<sup>10</sup> = Only available in conjunction with electronic climate control, deletes silver-effect roof rails. <sup>11</sup> = Not available in conjunction with emergency spare wheel, Towing Pack and VXR Styling Pack. Please note, bicycle size restrictions apply, please contact your local Retailer for further information.

<sup>12</sup> = Only available in conjunction with Navi 950 audio unit. Not available in conjunction with optional Flex-Fix<sup>®</sup> integrated carrier system or Royal Blue exterior colour.

# NEW ZAFIRA TOURER FEATURES/OPTIONS





<b>EXTERIOR COLOURS</b>		Design	Energy	SRI	SE	Tech Line	Elite	Price (£) exc. VAT	Total (£) inc. VAT
	<b>Royal Blue*</b> • Solid paint	●	●	●	●	●	●		
	<b>Summit White*</b> • Brilliant paint	○	○	○	○	○	○	237.50	<b>285.00</b>
	<b>Lava Red*</b> • Brilliant paint								
	<b>Sovereign Silver*</b> • Two-coat metallic paint								
	<b>Satin Steel Grey*</b> • Two-coat metallic paint								
	<b>Dark Caramel*</b> • Two-coat metallic paint								
	<b>Mineral Black</b> • Two-coat metallic paint								
	<b>Flip Chip Silver*</b> • Two-coat metallic paint	○	○	○	○	○	○	462.50	<b>555.00</b>
	<b>Cosmic Grey*</b> • Two-coat metallic paint								
	<b>Dark Sea Blue*</b> • Two-coat pearlescent paint								
	<b>Macadamia</b> • Two-coat pearlescent paint								
	<b>Emerald Green</b> • Two-coat pearlescent paint	○	○	○				462.50	<b>555.00</b>

● = Standard equipment. ○ = Optional at extra cost. \* = Not available on SE and Tech Line models with Lilop Light Neutral cloth seat trim.

The colours reproduced may vary slightly from the actual paint colour. As a result they should be used as a guide only. Your Vauxhall Retailer has a comprehensive display of our paint samples.



# NEW ZAFIRA TOURER FEATURES/OPTIONS

<b>WHEELS AND TYRES</b>		<i>Design</i>	<i>Energy</i>	<i>SRI</i>	<i>SE</i>	<i>Tech Line</i>	<i>Elite</i>	Price (£) exc. VAT	Total (£) inc. VAT
Emergency spare wheel (in lieu of emergency tyre inflation kit)		○	○	○	○	○	○	91.67	<b>110.00</b>
	17-inch 10-spoke alloy wheels • 225/50 R 17 tyres • Emergency tyre inflation kit (in lieu of spare wheel)	●	●		●	●			
	17-inch 10-spoke alloy wheels (1.6CDTi (134PS) S/S ecoFLEX only) • 225/50 R 17 tyres • Emergency tyre inflation kit (in lieu of spare wheel)			●					
	18-inch 5-twinspoke alloy wheels (1.4i Turbo/2.0CDTi) • 235/45 R 18 tyres • Emergency tyre inflation kit (in lieu of spare wheel)			●					
	18-inch 5-twinspoke alloy wheels (1.6CDTi (134PS) S/S only) • 235/45 R 18 tyres • Emergency tyre inflation kit (in lieu of spare wheel)			○				91.67	<b>110.00</b>
	18-inch 10-spoke alloy wheels • 235/45 R 18 tyres • Emergency tyre inflation kit (in lieu of spare wheel)				○	○	●	300.00	<b>360.00</b>



● = Standard equipment. ○ = Optional at extra cost.

# NEW ZAFIRA TOURER FEATURES/OPTIONS

		Design	Energy	SRI	SE	Tech Line	Elite	Price (£) exc. VAT	Total (£) inc. VAT
	19-inch 5-spoke bi-colour alloy wheels • 235/40 R 19 tyres • Emergency tyre inflation kit (in lieu of spare wheel)			○			○	375.00	450.00
	19-inch multispoke alloy wheels • 235/40 R 19 tyres • Emergency tyre inflation kit (in lieu of spare wheel)				○	○		591.67	710.00

○ = Optional at extra cost.

## TYRE RATING

Tyre size	Fuel efficiency group	Wet grip performance	External noise	
			Measured (dB)	Group
225/50 R 17	B-E	B-C	68-71	
235/45 R 18	E	B	71	
235/40 R 19	E	B	71	

Tyre rating according to EU Regulation 1222/2009

# NEW ZAFIRA TOURER SPECIFICATIONS

## PETROL ENGINE

	<b>1.4i Turbo (140PS) ECOTEC-4</b>
Capacity	1364cc
Maximum power	140PS (103kW) @ 4900-6000rpm
Maximum torque	200Nm (147 lb.ft.) @ 1850-4900rpm
Configuration	4 cylinders, 4 valves per cylinder, double overhead camshafts
Fuel/induction system	Water-cooled turbocharger with intercooler. Variable Valve Timing (VVT). Multi-point sequential fuel injection
Emission compliance	Euro 6
Service interval	20,000 miles or 1 year (whichever occurs sooner)

## DIESEL ENGINES

	<b>1.6CDTi (134PS) ECOTEC-4 Turbo diesel</b>	<b>2.0CDTi (170PS) ECOTEC-4 Turbo diesel</b>
Capacity	1598cc	1956cc
Maximum power	134PS (99kW) @ 3500-4000rpm	170PS (125kW) @ 3750rpm
Maximum torque	320Nm (236 lb.ft.) @ 2000rpm	400Nm (295 lb.ft.) @ 1750-2500rpm
Configuration	4 cylinders, 4 valves per cylinder, double overhead camshafts	4 cylinders, 4 valves per cylinder, double overhead camshafts
Fuel/induction system	Variable geometry turbocharger with intercooler. Common rail fuel injection	Turbocharger with intercooler. Common rail fuel injection
Emission compliance	Euro 6	Euro 6
Service interval	20,000 miles or 1 year (whichever occurs sooner)	20,000 miles or 1 year (whichever occurs sooner)

# NEW ZAFIRA TOURER SPECIFICATIONS

## PERFORMANCE, FUEL ECONOMY AND EMISSIONS

	Wheel size (inches)	Performance (manufacturer's figures)		Fuel economy mpg (litres/100km)#			CO <sub>2</sub> emissions g/km#	Vehicle Excise Duty*		Benefit in kind company car taxation rates – 2016/17 tax year
		Maximum speed (mph)	Acceleration 0-60mph (sec)	Urban driving	Extra-urban driving	Combined figure		First year rate	Standard rate	
<b>Manual</b>										
1.4i Turbo (140PS)	17/18/19	124	9.9	33.6 (8.4)	48.7 (5.8)	42.2 (6.7)	158	£185	£185	28%
1.6CDTi (134PS) Start/Stop ecoFLEX**	17	120	10.4	53.3 (5.3)	70.6 (4.0)	62.8 (4.5)	119	£0	£30	23%
1.6CDTi (134PS) Start/Stop**	18/19	120	10.4	50.4 (5.6)	67.3 (4.2)	60.1 (4.7)	125	£0	£110	25%
2.0CDTi (170PS) Start/Stop	17	129	9.1	46.3 (6.1)	67.3 (4.2)	57.7 (4.9)	129	£0	£110	25%
2.0CDTi (170PS) Start/Stop	18/19	129	9.1	44.1 (6.4)	62.8 (4.5)	54.3 (5.2)	137	£130	£130	27%
<b>Automatic</b>										
1.4i Turbo (140PS)	17/18/19	122	10.2	30.4 (9.3)	50.4 (5.6)	40.9 (6.9)	160	£185	£185	29%
2.0CDTi (170PS)	17/18/19	127	9.3	34.4 (8.2)	58.9 (4.8)	46.3 (6.1)	161	£185	£185	32%

\* = Correct at time of publication. \*\* = Provisional data.

# = Fuel consumption information is official government environmental data, tested in accordance with the relevant EU directive. Official EU-regulated test data is provided for comparison purposes and actual performance will depend on driving style, road conditions and other non-technical factors.

### OPTIONAL TRANSMISSION

#### Six-speed automatic transmission with ActiveSelect® function

A six-speed automatic transmission is optional on 1.4i Turbo (140PS) and 2.0CDTi (170PS) models. On the road, a wide selection of shift patterns is adapted to the style and habits of the driver, anticipating when maximum acceleration or maximum efficiency is required. The electronic control will also adapt to the prevailing road conditions, reducing gear shifting when climbing or descending and using engine braking assistance during down changes. The ActiveSelect® manual mode allows the gear lever to be used like a sequential manual gearbox – you simply push the lever forward or back to change up or down the gears. The driver also benefits from a 'neutral' gear disengagement at idle, which reduces vibration and contributes to improved fuel consumption.

### STEERING

- Power-assisted steering
- Turning circle (kerb-to-kerb): – 11.40m (37.4ft.)

### SUSPENSION

**Front:** Independent. Lightweight MacPherson struts with gas-pressure dampers and coil springs. Anti-roll bar.

**Rear:** Lightweight compound crank rear axle with one-piece, hollow cast trailing arms. Built-in anti-roll bar. Progressive-rate double conical mini-block springs with gas-pressure dampers.

### BRAKES

- Anti-lock Braking System (ABS)
- Electronic brakeforce distribution
- Hydraulic brake fade assist
- Cornering brake control
- Emergency brake assist
- Hill start assist (standard on automatic models only)
- Electric parking brake (standard on SE, Tech Line and Elite models only)

### BODY

Aerodynamic drag co-efficient: – Cd 0.32.

### FUEL TANK CAPACITY

58 litres (12.8 gallons)

# NEW ZAFIRA TOURER SPECIFICATIONS

## EXTERIOR DIMENSIONS millimetres (inches)

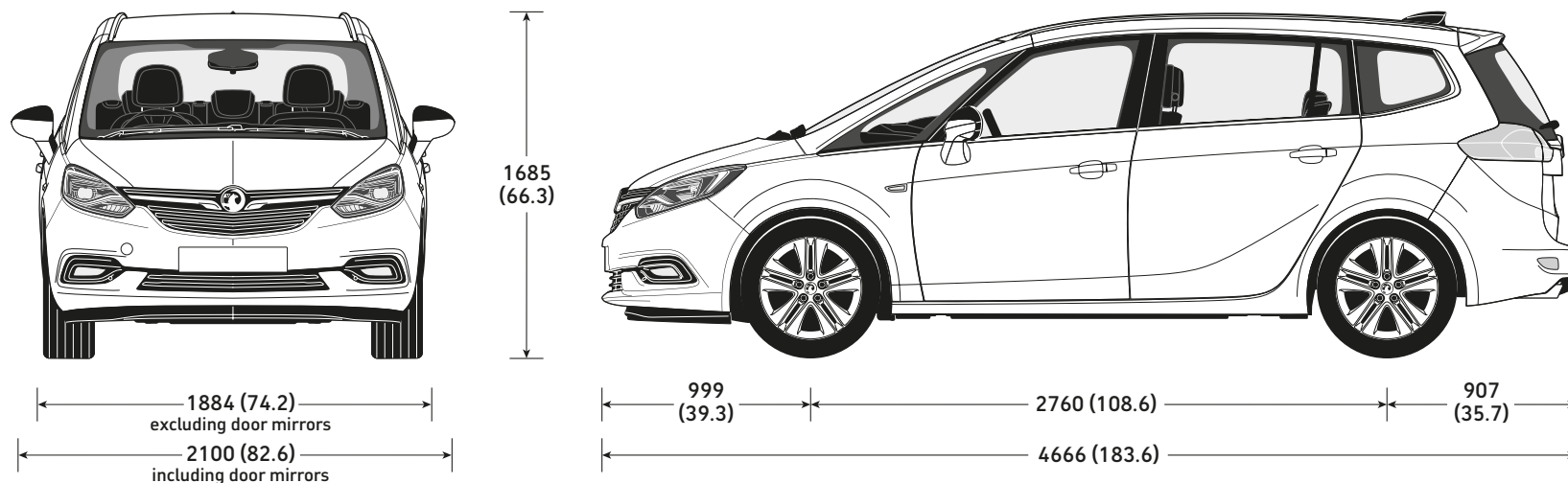

## WEIGHTS AND TOWING DATA kg

	Gross vehicle weight	Max. towing weights Trailer with brakes (without brakes)
1.4i Turbo (140PS)	2310	1300 (750)
1.4i Turbo (140PS) automatic	2340	1550 (750)
1.6CDTi (134PS) Start/Stop ecoFLEX	tba	tba
2.0CDTi (170PS) Start/Stop	2455	1650 (750)
2.0CDTi (170PS) automatic	2470	1650 (750)

Gross vehicle weight is the total permissible weight of the vehicle including passengers and their luggage. The maximum roof rack loading should not exceed 100kg. The maximum towing weights are based on the ability of the car, with two occupants of 75kg each, to restart on a 12% gradient, which is approximately 1 in 8.3, at sea level. The permitted trailer load applies up to the specified incline and up to an altitude of 1000 metres above sea level. The permissible gross train weight decreases by 10% for every 1000 metres of additional altitude. Any extra weight, such as luggage or additional passengers, should be deducted from the maximum towing weight. With a trailer fully loaded, maximum noseweight should not exceed 75kg. Always fit Vauxhall towing attachments and accessories available from your Vauxhall Retailer. They are designed specifically for Vauxhall models and carry a 12-month guarantee. During trailer towing do not exceed a maximum speed of 60mph. This speed limit is also applicable in countries with higher permitted speeds for trailer-vehicle combinations. Pay attention to the local speed limits. For trailers with low driving stability and caravans the use of an oscillation damper is strongly recommended.

## LOADSPACE DIMENSIONS millimetres (inches)

Maximum floor length – behind front seats, second-row and third-row seats folded	1842 (72.5)
Maximum floor length – behind second-row seats	1093 (43.0)
Width between wheel arches	1057 (41.6)
Tailgate aperture height	840 (33.0)
Tailgate aperture lower width	1045 (41.1)

## LOADSPACE CAPACITIES measured using the ECIE method

	litres (cu.ft.)
Behind third-row seats, to glass line	152 (5.4)
Behind second-row seats, to glass line	710 (25.1)
Behind front seats, to roof	1860 (65.6)

# NEW ZAFIRA TOURER ACCESSORIES

## INFOTAINMENT

### Sat Nav updates<sup>1</sup>

Please consult your Retailer for latest map updates or visit [www.vauxhall.co.uk/accessories](http://www.vauxhall.co.uk/accessories).

1 = For use with optional factory-fit satellite navigation systems.

### CHILD SEATS<sup>2</sup>

BABY-SAFE <sup>3</sup> – 0-13kg/birth to 15 months	£132.00
– ISOFIX base	£227.00
DUO ISOFIX <sup>3</sup> – 9-18kg/9 months to 4 years	
with top tether kit	£347.00
KID <sup>3</sup> – 15-36kg or 4 to 12 years	£157.00

2 = Restrictions apply to the use of child seats, please consult your Vauxhall Retailer or request a copy of the Child seats brochure.

3 = Without transponder.

### SAFETY

Safety Pack – first aid kit, warning triangle, hi-visibility vest, Vauxhall bag	£35.00
First aid kit	£14.00
Warning triangle	£17.00
Fire extinguisher – 2kg	£36.00
Hi-visibility vest	£9.00
Tyre sealant	£65.00
Tyre inflation compressor	£115.00
Tyre repair kit	£149.00

### SECURITY

Locking wheel nuts – set of four	£39.00
----------------------------------	--------

Total (inc. VAT)

### FLEXCONNECT RANGE

FlexConnect bracket	£20.00
FlexConnect hook	£25.00
FlexConnect coat hanger	£50.00
FlexConnect folding table	£65.00
FlexConnect iPad Mini cradle	£91.00
FlexConnect iPad (1-4) cradle	£99.00
FlexConnect iPad Air cradle	£99.00
FlexConnect Samsung Galaxy cradle	£89.00

### PRACTICAL

Spare bulb kit <sup>4</sup>	£25.00
Premium spare bulb kit <sup>4</sup>	£31.00
Privacy shades	
– side windows	£102.00
– rear window	£87.00
Stretch tow rope – up to 3000kg	£34.00
Towing bar – up to 2500kg	£83.00

4 = Excludes xenon headlight bulb for models with Adaptive Forward Lighting (AFL).

### PROTECTION

Economy floor mats – set of four	from £35.00
Rubber floor mats	
– front and second row	£57.00
Velour floor mats – set of four	£75.00
Mudflaps	
– front	£56.00
– rear	£55.00
Alloy-effect sports pedals	from £112.00
Front door sill plates (single)	£27.00
Cargo net – horizontal	£20.00
Cargo liner	£52.00
Load compartment mat	from £180.00
Storage box	£27.00
Dog guard	£227.00
Load compartment divider rail	£104.00

Total (inc. VAT)

### TRANSPORT SYSTEMS

Roof base carrier (without roof rails)	£163.00
Roof base carrier (with roof rails)	£159.00
<b>Roof carriers (requires base carrier)</b>	
Bike roof carrier – Thule Freeride 532	£76.00
Surf board roof carrier – Thule 833	£101.00
Kayak roof carrier – Thule 837	£168.00
Ski roof carrier (400mm wide)	
– Thule Deluxe 726	£138.00
Ski roof carrier (600mm wide)	
– Thule 739	£235.00
<b>Hard shell roof boxes (requires base carrier)</b>	
Thule Ocean 80 (320 litre / 1330 x 860 x 370mm)	£235.00
Thule Ocean 200 (390 litre / 1750 x 820 x 450mm)	£316.00
Thule Pacific 200 (460 litre)	£372.00
Thule Pacific 700 (460 litre)	£426.00
Thule Dynamic M (320 litre / 2060 x 840 x 340mm)	from £625.00
Thule Dynamic L (430 litre / 2350 x 940 x 350mm)	£846.00
Thule Excellence (520 litre / 2180 x 940 x 400mm)	£898.00
Thule Motion 800 (460 litre / 2050 x 840 x 450mm)	from £515.00
Thule Touring 200 (400 litre / 1750 x 820 x 450mm)	£372.00
Thule Touring 780 (430 litre / 2320 x 700 x 420mm)	£460.00
<b>Soft roof boxes (requires base carrier)</b>	
Thule Ranger 90 (280 litre / 1100 x 800 x 400mm)	£285.00
Thule Ranger 500 (300 litre / 1900 x 500 x 300mm)	£378.00
<b>Tailgate carrier</b>	
Bike tailgate carrier – Thule BacPac 973	£282.00
Fitting kit	£48.00

Total (inc. VAT)

### Tow bar carrier system

Flex-Fix <sup>®</sup> rear end carrier extension	£229.00
Fixed tow bar	
– 13-pin electrics	£628.00
Detachable tow bar	
– 13-pin electrics	£654.00

### STYLING

VX-Line styling pack	• Front lower spoiler
• Rear lower skirt	• Rear roof spoiler
• Side sills	from £1843.00
VX-Line rear roof spoiler <sup>5</sup>	£631.00

5 = Not suitable for SRi models. Requires additional aerial adaptor of extra cost. Please consult you Retailer for details.

### ALLOY WHEELS (set of four with centre caps)<sup>6</sup>

17-inch 7-spoke	£616.00
18-inch 5-double spoke	£666.00
18-inch 5-spoke	£958.00
18-inch 10-spoke	£1005.00
19-inch 10-spoke	£1383.00

Other designs available

6 = Different tyres and locking wheel bolts/nuts may be required at extra cost. Price excludes new tyres and locking wheel bolts/nuts, includes static wheel balancing.

#### Please note:

Prices shown are a fully fitted and painted, where applicable and include VAT. Please check with your local Vauxhall Retailer for details. It is advisable to ensure your insurance policy is adequate to cover additional fitted accessories. Prices correct at time of publication.

# NEW ZAFIRA TOURER ADDITIONAL INFORMATION

## ON-THE-ROAD PRICES

To eliminate uncertainty about hidden costs when buying a new car, Vauxhall publishes on-the-road recommended retail prices (RRP) and these are shown in the pricing tables within this price guide. These prices include the recommended cost of number plates and delivery to a Vauxhall Retailer of £700.00 (including £116.67 VAT), 12 months' Government Vehicle Excise Duty (see opposite for details) and the DVLA new vehicle first registration fee of £55.00\*.

Please note: The on-the-road recommended retail price (RRP) does not include fuel supplied by the Retailer, motor insurance or any other goods or services supplied by agreement between the Retailer and the customer.

## PRICE PROTECTION

Order a new Vauxhall for build in the current model year (as confirmed by your Retailer) for delivery no more than three months in advance and the price you are quoted is the price you pay. This is irrespective of any subsequent price rises between placing your order and delivery of your new car, but you must take delivery as soon as the car is available. General Motors UK Limited is not liable for price adjustments caused by Government changes in the rate of VAT (currently 20%), Vehicle Excise Duty, DVLA new vehicle first registration fee or by any other applicable legislation or regulations.

## VEHICLE EXCISE DUTY

The amount of Vehicle Excise Duty (road fund licence) payable on new cars varies depending on the level of carbon dioxide (CO<sub>2</sub>) emissions produced by the vehicle. CO<sub>2</sub> emissions are measured in grammes (g) per kilometre (km) travelled and divided into 13 charging bands shown in the table below.

From 1 April 2010 the Government introduced a new 'first year rate' of Vehicle Excise Duty payable on all new cars. In subsequent years the amount of Vehicle Excise Duty payable will revert to the standard rate.

### Vehicle Excise Duty\*

	CO <sub>2</sub> emissions (g/km)	First year rate	Standard rate
Band A	up to 100	£0.00	£0.00
Band B	101-110	£0.00	£20.00
Band C	111-120	£0.00	£30.00
Band D	121-130	£0.00	£110.00
Band E	131-140	£130.00	£130.00
Band F	141-150	£145.00	£145.00
Band G	151-165	£185.00	£185.00
Band H	166-175	£300.00	£210.00
Band I	176-185	£355.00	£230.00
Band J	186-200	£500.00	£270.00
Band K	201-225	£650.00	£295.00
Band L	226-255	£885.00	£500.00
Band M	over 255	£1120.00	£515.00

\* = Correct at time of issue.

## E10 FUEL

E10 fuel is cleared for use in all petrol-engined Vauxhall vehicles excluding models with the 2.2 litre direct injection petrol engine (code Z22YH) used in Vectra, Signum and Zafira models. Owners of these vehicles should continue to use regular unleaded or premium unleaded petrol.

## PROTECTING THE ENVIRONMENT

Vauxhall's commitment to the environment is demonstrated by our products' many environmental awards. For even more information on Vauxhall's efforts to achieve an environmentally sustainable future, and how to dispose of your end-of-life vehicle, see [www.vauxhall.co.uk/recycling](http://www.vauxhall.co.uk/recycling)

## VAUXHALL ASSISTANCE

Vauxhall Assistance is provided automatically with every new Vauxhall for 12 months from first registration and covers everything from accident assistance, roadside recovery and 'at home' service to flat tyres. With Vauxhall Assistance help is literally just a free\*\* phone call away, 24 hours a day, 365 days a year!

\*\* = Mobile phone users will be charged at their standard tariff.

## VAUXHALL LEASING

As Vauxhall's own contract hire and fleet management operation, Vauxhall Leasing provides a one-stop-shop for competitive car and van leasing solutions – for business users and private individuals. Working with the Vauxhall Retailer network, we combine the support of a national contract with the convenience of a local contact.

For further information, please see your local Vauxhall Retailer or call us on **0870 737 2557**. Alternatively, you can visit our website at [www.vauxhall-leasing.co.uk](http://www.vauxhall-leasing.co.uk)

## IN THE EVENT OF AN ACCIDENT...

Vauxhall Accident Management helps keep you mobile following an accident. Benefits include vehicle recovery, Vauxhall-approved repairs and contacting your insurer. For more details, visit [vauxhall.co.uk/AccidentManagement](http://vauxhall.co.uk/AccidentManagement)

## VAUXHALL SERVICE PLAN

Vauxhall Retailers offer a great service for owners of all Vauxhall cars. Value for money, regular offers and free check-ups, combined with the peace of mind that comes from using Vauxhall-trained technicians and genuine parts, help keep your car in peak condition at all times.

## FOR MORE PRODUCT INFORMATION

For a brochure on any Vauxhall model (up to a maximum of three per caller) or location of your nearest Vauxhall Retailer please call **0345 600 1500**. Alternatively, details can be found on our website at [www.vauxhall.co.uk](http://www.vauxhall.co.uk)

## JOIN US ONLINE:



## VAUXHALL INSURANCE WITH ADDED REASSURANCE

### Comprehensive cover – Summary of benefits\*

- Competitive premiums
- Repairs by a Vauxhall-trained technician
- Genuine Vauxhall parts, guaranteed for three years when we repair your car within our Approved Repairer Network
- Free courtesy car as standard when using an Approved Repairer\*\*
- 24 hour claims helpline
- Personal Accident benefit
- Cover for audio equipment
- Windscreen cover

### Call for a quote on 0844 463 2670†

\*The benefits listed above are for comprehensive cover only. For details of Third Party, Fire and Theft cover, please call our sales team.  
\*\*Should your car need repairing following an accident we provide a courtesy car (subject to availability) for the duration of the repair. Only genuine Vauxhall parts are used. Terms and conditions apply.  
†Calls may be recorded. Vauxhall Motor Insurance is underwritten by Ageas Insurance Limited.

Every effort has been made to ensure that the contents of this document were accurate and up-to-date at the time of publication – 4 October 2016 (Amended 28 November 2016). The invoice price, including delivery to Retailer, factory-fitted options, accessories fitted by the Retailer and number plates, is subject to VAT. The right is reserved to alter specifications and prices, and withdraw products from sale, without notice. Please note that Vauxhall Retailers are not the agents of General Motors UK Limited and are not authorised to bind General Motors UK Limited by any specific or implied undertaking or representation. It is advisable to ensure that your motor insurance policy provides adequate cover for additional fitted options and accessories. All rights reserved. No part of this publication may be reproduced in any form or by any means, without the prior written permission of General Motors UK Limited.

General Motors UK Limited t/a Vauxhall, Griffin House, UK1-101-135, Osborne Road, Luton, Bedfordshire, LU1 3YT. [www.vauxhall.co.uk](http://www.vauxhall.co.uk)

©2016 General Motors UK Limited



**VAUXHALL**