

ZAFIRA TOURER

PRICE/SPECIFICATION GUIDE



1 October 2018 | Model Year 2018.5







VAUXHALL
British Brand since 1903

ZAFIRA TOURER RANGE HIGHLIGHTS



DESIGN	OTR from £21,715
<i>Standard features include:</i>	
Exterior convenience / styling:	
<ul style="list-style-type: none"> • 17-inch alloy wheels • Remote control central locking • Electrically operated front and rear windows • Electrically adjustable/heated door mirrors • Front / rear parking distance sensors 	
Interior convenience / styling:	
<ul style="list-style-type: none"> • Air conditioning • Cruise control with speed limiter • Steering column adjustable for reach / rake • Steering wheel audio / phone / cruise controls • Central storage facility with two cup holders • Ambient lighting in roof • Luggage compartment cover 	
Infotainment:	
<ul style="list-style-type: none"> • R4.0 IntelliLink audio system <ul style="list-style-type: none"> – 7-inch colour touchscreen – AM/FM/DAB digital radio – Bluetooth® audio streaming / Bluetooth® mobile phone portal – USB audio connection – Apple CarPlay™ / Android Auto™ • Six speakers 	
Safety / security:	
<ul style="list-style-type: none"> • OnStar • Electronic Stability Programme (ESP) • Anti-lock Braking System (ABS) • Six airbags • ISOFIX child seat mounting points on outer rear seats • Height-adjustable front and rear seat head restraints • Door-to-door illumination • LED daytime running lights • Electronic engine deadlock immobiliser 	
 	

ENERGY	OTR from £24,835
<i>Features over Design:</i>	
Exterior convenience / styling:	
<ul style="list-style-type: none"> • Front fog lights • Chrome-effect lower window surround • Dark-tinted rear windows • Silver-effect roof rails 	
Infotainment:	
<ul style="list-style-type: none"> • Navi 4.0 IntelliLink satellite navigation system <ul style="list-style-type: none"> – Fully integrated European satellite navigation system 	
 	

SRI	OTR from £26,380
<i>Features over Design:</i>	
Exterior convenience / styling:	
<ul style="list-style-type: none"> • 17-inch multi-spoke alloy wheels (1.6CDTi) • 18-inch alloy wheels (1.4i Turbo/2.0CDTi) • Front fog lights • Silver-effect roof rails 	
Interior convenience / styling:	
<ul style="list-style-type: none"> • Three-spoke chrome-bezelled leather-covered steering wheel • Sports style seats • Driver's seat with tilt and four-way electric lumbar adjustment • Sports pedals 	
Safety / security:	
<ul style="list-style-type: none"> • Remote control security alarm system 	
SRI Nav models additionally feature	
<ul style="list-style-type: none"> • Navi 4.0 IntelliLink satellite navigation system <ul style="list-style-type: none"> – Fully integrated European satellite navigation system 	
  <p>17-inch</p>  <p>18-inch</p>	

ZAFIRA TOURER RANGE HIGHLIGHTS



TECH LINE NAV OTR from £23,410

Features over Design:

Exterior convenience / styling:

- Automatic lighting control
- Rain-sensitive windscreen wipers
- Dark-tinted rear windows
- Front fog lights
- Chrome-effect lower window surround
- Silver-effect roof rails

Interior convenience / styling:

- Electronic climate control
- Three-spoke chrome-bezelled leather-covered steering wheel
- Lounge seating
- FlexRail® centre console system
- Front passenger's underseat storage facility
- Electric parking brake

Infotainment:

- Navi 4.0 IntelliLink satellite navigation system
 - Fully integrated European satellite navigation system

Safety / security:

- Remote control security alarm system



ELITE NAV OTR from £28,545

Features over Tech Line Nav:

Exterior convenience / styling:

- 18-inch alloy wheels
- Panoramic windscreen
- Panoramic sunroof (excludes roof rails)

Interior convenience / styling:



- Leather seat trim (front and second row seats)
- Heated front seats
- Ergonomic driver's sports front seat, featuring:
 - Extendable seat cushion and seat tilt adjustment
 - Four-way electrical lumbar adjustment



ZAFIRA TOURER DESIGN

		5-door MPV	
		OTR RRP	CO ₂ (g/km)
DESIGN – ON-THE-ROAD PRICES			
<i>Petrol</i>	1.4i Turbo (140PS)	£21,715	156
	1.4i Turbo (140PS) auto	£23,235	160
<i>Diesel</i>	1.6CDTi (134PS) S/S ecoTEC BlueInjection	£24,400	119
	2.0CDTi (170PS) S/S BlueInjection	£24,600	129
	2.0CDTi (170PS) auto BlueInjection	£26,165	161

Please note: On-the-road recommended retail prices (RRP) include VAT at 20%, number plates and delivery to Retailer of £700.00 (inc. £116.67 VAT), 12 months' Vehicle Excise Duty and new vehicle first registration fee of £55.00. Excludes fuel and insurance. S/S = Start/Stop.

KEY OPTIONS		Total inc. VAT
 Looking good:	Brilliant paint	£285
	Two-coat metallic paint	£565
	Two-coat premium paint	£655
	Tri-coat premium paint	£725
 Practicality:	Emergency spare wheel (in lieu of emergency tyre inflation kit)	£110
	Remote control alarm	£290
	Navi 4.0 IntelliLink satellite navigation system	£710
	Seat Comfort Pack One	£180
	Seat Comfort Pack Two	£330
	Rear side window sunblinds	£110
	Loading Pack	£150
	FlexOrganiser® Pack	£160
	Electro Pack	£170
	Towing Pack	£750
	VXR Styling Pack	£1150

For details of these and other options please see Features/Options pages.



FEATURES

OnStar:

- Automatic crash response / Wi-Fi hotspot / smartphone app / stolen vehicle assistance / vehicle diagnostics

Infotainment:

- R4.0 IntelliLink audio system
 - 7-inch colour touchscreen
 - AM/FM/DAB digital radio
 - Bluetooth® audio streaming
 - Bluetooth® mobile phone portal
 - USB audio connection
 - Apple CarPlay™ / Android Auto™
- Six speakers

Interior convenience / styling:

- Air conditioning
- Multi-function trip computer
- Cruise control with speed limiter
- Steering column adjustable for reach / rake
- Steering wheel audio / phone / cruise controls
- Front centre armrest
- Central storage facility with two cup holders
- Ambient lighting in roof
- Luggage compartment cover





Exterior convenience / styling:

- 17-inch alloy wheels
- Remote control central locking
- Electrically operated front and rear windows
- Electrically adjustable/heated door mirrors
- Front and rear parking distance sensors
- Black roof rails

Safety / security:

- Electronic Stability Programme (ESP)
- Anti-lock Braking System (ABS)
- Six airbags
- ISOFIX child seat mounting points on outer rear seats
- Deactivation switch for front passenger's front and side-impact airbags
- Height-adjustable front and rear seat head restraints
- Tyre pressure monitoring system
- Door-to-door illumination
- LED daytime running lights
- Electronic engine deadlock immobiliser

COMPANY CAR INFORMATION

-  P11D price starting at £21,145
-  From 28% tax band*
-  From £105 monthly BiK tax*
-  CO₂ emissions from 119g/km

Please see www.vauxhall.co.uk/fleet for details.

* = 2018/19 tax year.



ZAFIRA TOURER ENERGY

5-door MPV
OTR RRP CO₂ (g/km)

ENERGY – ON-THE-ROAD PRICES

Engine	Power (PS)	OTR RRP	CO ₂ (g/km)
Petrol	1.4i Turbo (140PS)	£24,835	156
	1.4i Turbo (140PS) auto	£26,355	160
Diesel	1.6CDTi (134PS) S/S ecoTEC BlueInjection	£27,520	119
	2.0CDTi (170PS) S/S BlueInjection	£27,720	129
	2.0CDTi (170PS) auto BlueInjection	£29,285	161

Please note: On-the-road recommended retail prices (RRP) include VAT at 20%, number plates and delivery to Retailer of £700.00 (inc. £116.67 VAT), 12 months' Vehicle Excise Duty and new vehicle first registration fee of £55.00. Excludes fuel and insurance. S/S = Start/Stop.

KEY OPTIONS	Total inc. VAT	
 Looking good:	Brilliant paint	£285
	Two-coat metallic paint	£565
	Two-coat premium paint	£655
	Tri-coat premium paint	£725
 Easier parking:	Rear-view camera	£250
 Practicality:	Emergency spare wheel (in lieu of emergency tyre inflation kit)	£110
	Remote control alarm	£290
	Seat Comfort Pack One	£180
	Seat Comfort Pack Two	£330
	Rear side window sunblinds	£110
	Loading Pack	£150
	FlexOrganiser® Pack	£160
	Electro Pack	£170
	Towing Pack	£750
	VXR Styling Pack	£1150

For details of these and other options please see Features/Options pages.



FEATURES

OnStar:

- Automatic crash response / Wi-Fi hotspot / smartphone app / stolen vehicle assistance / vehicle diagnostics

Infotainment:

- Navi 4.0 IntelliLink satellite navigation system
- Fully integrated European satellite navigation system
- 7-inch colour touchscreen
- AM/FM/DAB digital radio
- Bluetooth® audio streaming
- Bluetooth® mobile phone portal
- USB audio connection
- Apple CarPlay™ / Android Auto™
- Six speakers

Interior convenience / styling:

- Air conditioning
- Multi-function trip computer
- Cruise control with speed limiter
- Steering column adjustable for reach / rake
- Steering wheel audio / phone / cruise controls
- Front centre armrest
- Central storage facility with two cup holders
- Ambient lighting in roof
- Luggage compartment cover





Exterior convenience / styling:

- 17-inch alloy wheels
- Remote control central locking
- Electrically operated front and rear windows
- Electrically adjustable/heated door mirrors
- Front and rear parking distance sensors
- Front fog lights
- Chrome-effect lower window surround
- Dark-tinted rear windows
- Silver-effect roof rails

Safety / security:

- Electronic Stability Programme (ESP)
- Anti-lock Braking System (ABS)
- Six airbags
- ISOFIX child seat mounting points on outer rear seats
- Deactivation switch for front passenger's front and side-impact airbags
- Height-adjustable front and rear seat head restraints
- Tyre pressure monitoring system
- Door-to-door illumination
- LED daytime running lights
- Electronic engine deadlock immobiliser

COMPANY CAR INFORMATION

-  P11D price starting at £24,265
-  From 28% tax band*
-  From £121 monthly BiK tax*
-  CO₂ emissions from 119g/km

Please see www.vauxhall.co.uk/fleet for details.







* = 2018/19 tax year.

ZAFIRA TOURER SRI

		5-door MPV	
		OTR RRP	CO ₂ (g/km)
SRI – ON-THE-ROAD PRICES			
Petrol	1.4i Turbo (140PS)	£26,380	156
	1.4i Turbo (140PS) auto	£27,900	160
Diesel	1.6CDTi (134PS) S/S ecoTEC BlueInjection	£29,065	119
	2.0CDTi (170PS) S/S BlueInjection	£29,510	137
	2.0CDTi (170PS) auto BlueInjection	£30,830	161

SRI NAV – ON-THE-ROAD PRICES			
Petrol	1.4i Turbo (140PS)	£27,080	156
	1.4i Turbo (140PS) auto	£28,600	160
Diesel	1.6CDTi (134PS) S/S ecoTEC BlueInjection	£29,765	119
	2.0CDTi (170PS) S/S BlueInjection	£30,210	137
	2.0CDTi (170PS) auto BlueInjection	£31,530	161

Please note: On-the-road recommended retail prices (RRP) include VAT at 20%, number plates and delivery to Retailer of £700.00 (inc. £116.67 VAT), 12 months' Vehicle Excise Duty and new vehicle first registration fee of £55.00. Excludes fuel and insurance. S/S = Start/Stop.

KEY OPTIONS		Total inc. VAT
 Looking good:	Brilliant paint	£285
	Two-coat metallic paint	£565
	Two-coat premium paint	£655
	Tri-coat premium paint	£725
	18-inch 5-twinspoke alloy wheels (1.6CDTi (134PS) ecoTEC only)	£110
	19-inch 5-spoke bi-colour alloy wheels	£550
 Easier parking:	Rear-view camera	£250
 Sitting comfortably:	Electronic climate control including air conditioning	£405
	Winter Pack	£365
	Leather Pack	£1155
 Fresh air:	Panoramic windscreen and panoramic sunroof	£760
 Driving assistance:	Sight and Light Pack	£240
 Practicality:	Emergency spare wheel (in lieu of emergency tyre inflation kit)	£110
	Rear side window sunblinds	£110
	Loading Pack	£150
	FlexOrganiser® Pack	£160
	Electro Pack	£170
	Towing Pack	£750
	Flex-Fix® integrated carrier system	£910
	VXR Styling Pack	£1150

For details of these and other options please see Features/Options pages.



FEATURES

OnStar:

- Automatic crash response / Wi-Fi hotspot / smartphone app / stolen vehicle assistance / vehicle diagnostics

Infotainment:

- R4.0 IntelliLink audio system
 - 7-inch colour touchscreen
 - AM/FM/DAB digital radio
 - Bluetooth® audio streaming
 - Bluetooth® mobile phone portal
 - USB audio connection
 - Apple CarPlay™ / Android Auto™
- Six speakers

Interior convenience / styling:

- Air conditioning
- Multi-function trip computer
- Cruise control with speed limiter
- Steering column adjustable for reach / rake
- Steering wheel audio / phone / cruise controls
- Three-spoke chrome-bezelled leather-covered steering wheel
- Sports style seats
- Driver's seat with tilt and four-way electric lumbar adjustment
- Front centre armrest
- Central storage facility with two cup holders
- Ambient lighting in roof
- Sports pedals
- Luggage compartment cover

Exterior convenience / styling:

- 17-inch alloy wheels (1.6CDTi)
- 18-inch alloy wheels (1.4i Turbo/2.0CDTi)
- Remote control central locking
- Electrically operated front and rear windows
- Electrically adjustable/heated door mirrors
- Front and rear parking distance sensors
- Front fog lights
- Silver-effect roof rails





Safety / security:

- Electronic Stability Programme (ESP)
- Anti-lock Braking System (ABS)
- Six airbags
- ISOFIX child seat mounting points on outer rear seats
- Deactivation switch for front passenger's front and side-impact airbags
- Height-adjustable front and rear seat head restraints
- Door-to-door illumination
- Tyre pressure monitoring system
- LED daytime running lights
- Remote control security alarm system
- Electronic engine deadlock immobiliser

SRI Nav models additionally feature

- Navi 4.0 IntelliLink satellite navigation system
 - Fully integrated European satellite navigation system

COMPANY CAR INFORMATION

-  P11D price starting at £25,810
-  From 28% tax band*
-  From £128 monthly BiK tax*
-  CO₂ emissions from 119g/km

Please see www.vauxhall.co.uk/fleet for details.

* = 2018/19 tax year.

ZAFIRA TOURER TECH LINE NAV

5-door MPV
OTR RRP CO₂ (g/km)

TECH LINE NAV – ON-THE-ROAD PRICES

Engine	Power	OTR RRP	CO ₂ (g/km)
Petrol	1.4i Turbo (140PS)	£23,410	156
	1.4i Turbo (140PS) auto	£24,930	160
Diesel	1.6CDTi (134PS) S/S ecoTEC BlueInjection	£26,095	119
	2.0CDTi (170PS) S/S BlueInjection	£26,295	129
	2.0CDTi (170PS) auto BlueInjection	£27,860	161

Please note: On-the-road recommended retail prices (RRP) include VAT at 20%, number plates and delivery to Retailer of £700.00 (inc. £116.67 VAT), 12 months' Vehicle Excise Duty and new vehicle first registration fee of £55.00. Excludes fuel and insurance. S/S = Start/Stop.

KEY OPTIONS	Total inc. VAT	
Looking good:	Brilliant paint	£285
	Two-coat metallic paint	£565
	Two-coat premium paint	£655
	Tri-coat premium paint	£725
	18-inch 10-spoke alloy wheels	£500
	19-inch multispoke alloy wheels	£800
Easier parking:	Rear-view camera	£250
	Front camera system	£805
Sitting comfortably:	Winter Pack	£365
	Ergonomic driver's sport style seat	£480
Fresh air:	Panoramic windscreen and panoramic sunroof	£760
Driving assistance:	Driver Assistance Pack <i>Forward collision alert with automatic city emergency braking / automatic cruise control / side blind spot alert / following distance indicator</i>	£1005
	FlexRide adaptive chassis system	£810
	Premium Forward Lighting Pack	£1100
	Practicality:	
	Emergency spare wheel (in lieu of emergency tyre inflation kit)	£110
	Seat Comfort Pack One	£180
	Seat Comfort Pack Two	£330
	Rear side window sunblinds	£110
	Loading Pack	£150
	FlexOrganiser® Pack	£160
	Electro Pack	£170
	Towing Pack	£750
	Flex-Fix® integrated carrier system	£910
	VXR Styling Pack	£1150

For details of these and other options please see Features/Options pages.



FEATURES

OnStar:

- Automatic crash response / Wi-Fi hotspot / smartphone app / stolen vehicle assistance / vehicle diagnostics

Infotainment:

- Navi 4.0 IntelliLink satellite navigation system
- Fully integrated European satellite navigation system
- 7-inch colour touchscreen
- AM/FM/DAB digital radio
- Bluetooth® audio streaming
- Bluetooth® mobile phone portal
- USB audio connection
- Apple CarPlay™ / Android Auto™
- Six speakers

Interior convenience / styling:

- Electronic climate control
- Multi-function trip computer
- Cruise control with speed limiter
- Steering column adjustable for reach / rake
- Steering wheel audio / phone / cruise controls
- Three-spoke chrome-bezelled leather-covered steering wheel
- Lounge seating
- FlexRail® centre console system
- Front passenger's underseat storage facility
- Electric parking brake
- Ambient lighting in roof

Exterior convenience / styling:

- 17-inch alloy wheels
- Remote control central locking
- Electrically operated front and rear windows
- Electrically adjustable/heated door mirrors
- Front and rear parking distance sensors
- Automatic lighting control
- Rain-sensitive windscreen wipers
- Dark-tinted rear windows
- Front fog lights
- Chrome-effect lower window surround
- Silver-effect roof rails

Safety / security:

- Electronic Stability Programme (ESP)
- Anti-lock Braking System (ABS)
- Six airbags
- ISOFIX child seat mounting points on outer rear seats
- Deactivation switch for front passenger's front and side-impact airbags
- Height-adjustable front and rear seat head restraints
- Tyre pressure monitoring system
- Door-to-door illumination
- LED daytime running lights
- Remote control security alarm system
- Electronic engine deadlock immobiliser

COMPANY CAR INFORMATION

- P11D price starting at £22,840
- From 28% tax band*
- From £114 monthly BiK tax*
- CO₂ emissions from 119g/km

Please see www.vauxhall.co.uk/fleet for details.

* = 2018/19 tax year.





ZAFIRA TOURER ELITE NAV

5-door MPV
OTR RRP CO₂ (g/km)

ELITE NAV – ON-THE-ROAD PRICES

Engine	Power	OTR RRP	CO ₂ (g/km)
Petrol	1.4i Turbo (140PS)	£28,545	156
	1.4i Turbo (140PS) auto	£30,065	160
Diesel	2.0CDTi (170PS) S/S BlueInjection	£31,675	137
	2.0CDTi (170PS) auto BlueInjection	£32,995	161

Please note: On-the-road recommended retail prices (RRP) include VAT at 20%, number plates and delivery to Retailer of £700.00 (inc. £116.67 VAT), 12 months' Vehicle Excise Duty and new vehicle first registration fee of £55.00. Excludes fuel and insurance. S/S = Start/Stop.

KEY OPTIONS	Total inc. VAT	
 Looking good:	Brilliant paint	£285
	Two-coat metallic paint	£565
	Two-coat premium paint	£655
	Tri-coat premium paint	£725
	19-inch 5-spoke bi-colour alloy wheels	£550
 Easier parking:	Rear-view camera	£250
	Front camera system	£805
 Driving assistance:	Driver Assistance Pack <i>Forward collision alert with automatic city emergency braking / automatic cruise control / side blind spot alert / following distance indicator</i>	£1005
	FlexRide adaptive chassis system	£810
	Premium Forward Lighting Pack	£1100
	Emergency spare wheel (in lieu of emergency tyre inflation kit)	£110
 Practicality:	Rear side window sunblinds	£110
	Loading Pack	£150
	FlexOrganiser® Pack	£160
	Electro Pack	£170
	Towing Pack	£750
	Flex-Fix® integrated carrier system	£910
	VXR Styling Pack	£1150

For details of these and other options please see Features/Options pages.



FEATURES

OnStar:

- Automatic crash response / Wi-Fi hotspot / smartphone app / stolen vehicle assistance / vehicle diagnostics

Infotainment:

- Navi 4.0 IntelliLink satellite navigation system
 - Fully integrated European satellite navigation system
 - 7-inch colour touchscreen
 - AM/FM/DAB digital radio
 - Bluetooth® audio streaming
 - Bluetooth® mobile phone portal
 - USB audio connection
- Apple CarPlay™ / Android Auto™
- Six speakers

Interior convenience / styling:

- Leather seat trim (front and second row seats)
- Electronic climate control
- Multi-function trip computer
- Cruise control with speed limiter
- Steering column adjustable for reach / rake
- Steering wheel audio / phone / cruise controls
- Three-spoke chrome-bezelled leather-covered steering wheel
- Lounge seating
- Heated front seats
- Ergonomic driver's sports front seat, featuring:
 - Extendable seat cushion and seat tilt adjustment
 - Four-way electrical lumbar adjustment

- FlexRail® centre console system
- Electric parking brake
- Luggage compartment cover

Exterior convenience / styling:

- 18-inch alloy wheels
- Remote control central locking
- Panoramic windscreen
- Panoramic sunroof
- Chrome-effect lower window surround
- Dark-tinted rear windows
- Automatic lighting control
- Front fog lights
- Rain-sensitive windscreen wipers
- Electrically operated front and rear windows
- Electrically adjustable/heated door mirrors
- Front and rear parking distance sensors

Safety / security

- Electronic Stability Programme (ESP)
- Anti-lock Braking System (ABS)
- Six airbags
- ISOFIX child seat mounting points on outer rear seats
- Deactivation switch for front passenger's front and side-impact airbags
- Height-adjustable front and rear seat head restraints
- Tyre pressure monitoring system
- Door-to-door illumination
- LED daytime running lights
- Remote control security alarm system
- Electronic engine deadlock immobiliser

COMPANY CAR INFORMATION

- ✓ P11D price starting at £27,975
- ✓ From 32% tax band*
- ✓ From £142 monthly BiK tax*
- ✓ CO₂ emissions from 137g/km

Please see www.vauxhall.co.uk/fleet for details.

* = 2018/19 tax year.

ZAFIRA TOURER PRICES

Model 5-door MPV	Price (£)	VAT (£)	Total (£)	On-the-road RRP (£)	CO ₂ (g/km)
DESIGN					
1.4i Turbo (140PS)	17037.50	3407.50	20445.00	21715.00	156
1.4i Turbo (140PS) auto	18304.17	3660.83	21965.00	23235.00	160
<i>Diesel</i>					
1.6CDTi (134PS) S/S ecoTEC BlueInjection*	19533.33	3906.67	23440.00	24400.00	119
2.0CDTi (170PS) S/S BlueInjection*	19700.00	3940.00	23640.00	24600.00	129
2.0CDTi (170PS) auto BlueInjection*	20483.33	4096.67	24580.00	26165.00	161
ENERGY					
1.4i Turbo (140PS)	19637.50	3927.50	23565.00	24835.00	156
1.4i Turbo (140PS) auto	20904.17	4180.83	25085.00	26355.00	160
<i>Diesel</i>					
1.6CDTi (134PS) S/S ecoTEC BlueInjection*	22133.33	4426.67	26560.00	27520.00	119
2.0CDTi (170PS) S/S BlueInjection*	22300.00	4460.00	26760.00	27720.00	129
2.0CDTi (170PS) auto BlueInjection*	23083.33	4616.67	27700.00	29285.00	161
SRI					
1.4i Turbo (140PS)	20925.00	4185.00	25110.00	26380.00	156
1.4i Turbo (140PS) auto	22191.67	4438.33	26630.00	27900.00	160
<i>Diesel</i>					
1.6CDTi (134PS) S/S ecoTEC BlueInjection*	23420.83	4684.17	28105.00	29065.00	119**
2.0CDTi (170PS) S/S BlueInjection*	23533.33	4706.67	28240.00	29510.00	137
2.0CDTi (170PS) auto BlueInjection*	24370.83	4874.17	29245.00	30830.00	161
SRI NAV					
1.4i Turbo (140PS)	21508.33	4301.67	25810.00	27080.00	156
1.4i Turbo (140PS) auto	22775.00	4555.00	27330.00	28600.00	160
<i>Diesel</i>					
1.6CDTi (134PS) S/S ecoTEC BlueInjection*	24004.17	4800.83	28805.00	29765.00	119**
2.0CDTi (170PS) S/S BlueInjection*	24116.67	4823.33	28940.00	30210.00	137
2.0CDTi (170PS) auto BlueInjection*	24954.17	4990.83	29945.00	31530.00	161

Model 5-door MPV	Price (£)	VAT (£)	Total (£)	On-the-road RRP (£)	CO ₂ (g/km)
TECH LINE NAV					
1.4i Turbo (140PS)	18450.00	3690.00	22140.00	23410.00	156
1.4i Turbo (140PS) auto	19716.67	3943.33	23660.00	24930.00	160
<i>Diesel</i>					
1.6CDTi (134PS) S/S ecoTEC BlueInjection*	20945.83	4189.17	25135.00	26095.00	119**
2.0CDTi (170PS) S/S BlueInjection*	21112.50	4222.50	25335.00	26295.00	129
2.0CDTi (170PS) auto BlueInjection*	21895.83	4379.17	26275.00	27860.00	161
ELITE NAV					
1.4i Turbo (140PS)	22729.17	4545.83	27275.00	28545.00	156
1.4i Turbo (140PS) auto	23995.83	4799.17	28795.00	30065.00	160
<i>Diesel</i>					
2.0CDTi (170PS) S/S BlueInjection*	25337.50	5067.50	30405.00	31675.00	137
2.0CDTi (170PS) auto BlueInjection*	26175.00	5235.00	31410.00	32995.00	161

Please note: On-the-road recommended retail prices (RRP) include number plates and delivery to retailer of £700.00 (inc. £116.67 VAT), 12 months' Vehicle Excise Duty and new vehicle first registration fee of £55.00. Excludes fuel and insurance.

S/S = Start/Stop.

* = **Please note:** Vehicles with BlueInjection technology will need regular AdBlue® top-ups also between servicing requirements.

An indicator integrated into the on-board computer will warn you when you need to top up. More information under www.vauxhall.co.uk/blueinjection. In accordance with regulations R (EC) No. 715/2007 and R (EC) No. 692/2008 (in the versions respectively applicable).

** = CO₂ emissions are based on vehicles fitted with standard 17-inch alloy wheels. If optional alloy wheels are specified, at extra cost, CO₂ emissions will be affected.

ZAFIRA TOURER FEATURES/OPTIONS

SAFETY

Driver / passenger airbags

- Driver's airbag • Front passenger's airbag • Two front seat side-impact airbags
- Full-size curtain airbags for driver and front and outer rear seat passengers

Seating

- Height adjustable front and outer rear seat head restraints • Anti-submarining ramps in front seats – Prevents occupants sliding underneath the lap belt during a collision.

Seatbelts

- Five lap and diagonal inertia-reel seatbelts (height-adjustable front) • Third-row lap and diagonal inertia-reel seatbelts (when all seats are occupied within the Zafira Tourer the passenger side third-row seat is only usable by a passenger up to a maximum height of 150cm (4ft 11 inches))
- Front body-lock diagonal seatbelt pretensioner system – Tightens the seatbelt during the early stages of a frontal impact. • Drivers and front passenger's lap belt pretensioner system • Front seatbelt force limiters – Reduces potential upper body injuries during a frontal impact. • Anti-submarining ramps in front seats – Help prevent occupants sliding underneath the lap belt during a collision.

Child safety

- Deactivation switch for front passenger's front and side-impact airbags – Permits the safe use of a child seat in the front passenger seat • ISOFIX child seat mountings incorporating top tether anchor points located on outer rear seats (does not include child seat) – Allows ISOFIX child safety seats to be securely fixed into the car. The ISOFIX mounting system reduces forward movement in an accident and makes the child seat easier to install. • Child-proof locks on rear doors

Driver / passenger safety

- Energy-absorbing steering column • Pedal release system – Reduces potential injury to the driver's legs and feet during a severe frontal impact. • Laminated windscreen • Side-impact protection beams • Reinforced passenger safety cell • Deformation zones front and rear
- Burst-proof door locks and anti-jam door design

Pedestrian safety

- Bonnet / headlight / wiper structure – Designed to reduce pedestrian head and upper body injuries.
- Upper and lower bumper design – Reduces upper and lower leg injuries.

Stability

Electronic Stability Programme (ESP):

– Works in conjunction with the vehicle's electronic braking and engine systems to keep the car stable in many different situations. ESP monitors many different inputs to determine when the car starts to lose traction, it can then immediately respond by varying the brake pressure between up to three wheels and adjust the engine output to help correct the loss of traction and improve stability.

Additional ESP features:

- Cornering brake control • Straight line stability control • Rollover mitigation • Drag torque control – Maintain stability on slippery roads when lifting off the accelerator or changing gear

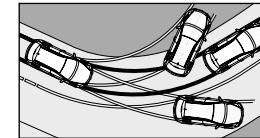

Braking

Anti-lock Braking System (ABS):

– Prevents the vehicle's wheels from locking up under heavy braking by momentarily reducing brake pressure at the appropriate wheel, ensuring that you can maintain control of the steering.

Additional braking features:



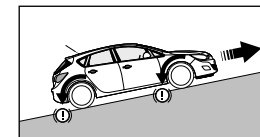



- The same electronic systems used in the ABS and ESP also deliver exceptional braking performance.
- Emergency brake assist – When emergency braking is detected the vehicle automatically applies the maximum possible braking assistance.
- Electronic brakeforce distribution – Automatically apportions the optimum braking force to each wheel. • Adaptive brake lights – Automatically warns other road users of heavy braking. • Hill start assist – Briefly maintains rear brake pressure to stop the vehicle rolling back on an incline. • Hazard warning lights



Tyre pressure

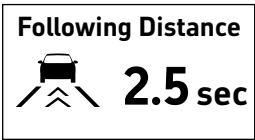







- Tyre pressure monitoring system

ZAFIRA TOURER FEATURES/OPTIONS

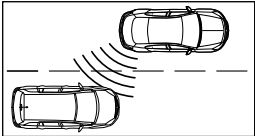
	Design	Energy	SRi	Tech Line Nav	Elite Nav	Price (£) exc. VAT	Total (£) inc. VAT
DRIVER ASSISTANCE Steering • Speed sensitive electrically assisted power steering • Reach and rake adjustable steering	●	●	●	●	●		
Cruise control with speed limiter: <i>The cruise control feature enables you to maintain a constant speed – making it ideal for economical motorway driving. The speed limiter function can be set to ensure that you do not exceed the speed limit and can be easily overridden if required.</i> • Steering wheel mounted controls	●	●	●	●	●		
Electric parking brake • Centre console switch in lieu of handbrake lever • Premium centre console featuring adjustable armrest				●	●		
Front camera system <i>A wide range of class-leading driver assistance and safety features are controlled by the front camera system.</i> Traffic sign recognition: <i>Detects and then displays speed limits, reducing uncertainty and the risk of speeding.</i> • Recognises different road signs, including temporary speed restrictions • Displays reminder in the driver information centre   Always know the speed limit							
Following distance indicator: <i>Indicates how many seconds you are behind the vehicle in front – helping you maintain a safe distance.</i> • Timings are shown in the driver information centre   Keeps a safe distance				○	○	670.83	805.00
Lane departure warning with lane assist: <i>If the driver has not actively steered or signalled, the lane departure warning system warns when the car moves outside of lane markings at speeds above 37mph. The lane keep assist function additionally provides gentle steering correction to help drivers keep in their lane if no active inputs are made.</i> • Warning light in instrument cluster • Audible warning • Steering wheel 'nudge' warning • Facia on/off switch • Both systems switch to standby when in road works or when road markings are confused   Keeps you in lane							

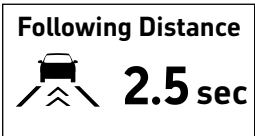
● = Standard equipment. ○ = Optional at extra cost.

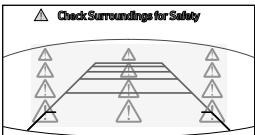
ZAFIRA TOURER FEATURES/OPTIONS

DRIVER ASSISTANCE		Design	Energy	SRI	Tech Line Nav	Elite Nav	Price (£) exc. VAT	Total (£) inc. VAT
Driver Assistance Pack A wide range of class-leading driver assistance and safety features are controlled by the front camera system. Forward collision alert with automatic city emergency braking: In certain circumstances and at speeds above 5mph warns when approaching another vehicle too quickly. At speeds above 5mph and up to 53mph the system provides additional braking support to help the driver brake more quickly and effectively in an emergency situation. At speeds above 5mph and up to 37mph if no avoiding action is taken by the driver, the system automatically slows the vehicle with emergency braking. • Visual warnings – projected onto windscreen and shown in the instrument cluster • Audible warning • Additional braking support • Low speed collision mitigation braking Automatic cruise control: Automatic cruise control decelerates the vehicle when approaching a slower moving vehicle. It then adjusts the vehicles speed to follow the vehicle at the selected following distance. The vehicle speed increases or decreases to follow the vehicle in front, but will not exceed the set speed. 								
 Helps maintain constant speed								
Side blind spot alert: Side blind spot alert helps prevent potential collisions with other vehicles 'hidden' in the vehicle's side blind spots. If a vehicle enters one of the blind spots a warning light illuminates in the relevant door mirror. • Ultrasonic side sensors with three-metre range • LED warning light in door mirrors • Audible warning is sounded if the indicators are used and the system has detected another vehicle • Electrically folding door mirrors 								
 Warns of vehicles in your blind spot								
Following distance indicator: Indicates how many seconds you are behind the vehicle in front – helping you maintain a safe distance. • Timings are shown in the driver information centre 								
 Keeps a safe distance								
Front and rear parking distance sensors • Front and rear parking distance sensors • Audible warning		●	●	●	●	●		
Rear-view camera The rear-view camera gives a clear view of the area behind your car and helps place the car perfectly, without needing to strain your neck. • Activated when reverse gear selected • Camera view appears in infotainment screen • Rear bumper and one-metre grid lines shown as reference points 								
 See what's behind you on the central screen								
FlexRide adaptive chassis control system with continuous damping control					○	○	675.00	810.00

● = Standard equipment. ○ = Optional at extra cost.

ZAFIRA TOURER FEATURES/OPTIONS

	Design	Energy	SRI	Tech Line Nav	Elite Nav	Price (£) exc. VAT	Total (£) inc. VAT
SECURITY							
Standard security features • 'Key left in ignition' audible warning • Electronically protected audio equipment • Engine deadlock immobiliser • Visible Vehicle Identification Number (VIN) • Locking wheel bolts for alloy wheels • Freewheeling door locks	●	●	●	●	●		
Remote control central locking • Operates on doors, tailgate and fuel filler flap • Deadlocking • Central locking activation switch on facia • One folding key/one static key each with integral remote control function	●	●	●	●	●		
Remote control ultrasonic security alarm system • Remote control (operates in conjunction with central locking) • Ultrasonic interior sensors • Tilt sensor • Thatcham approved	○	○	●	●	●	241.67	290.00

DRIVER INFORMATION

Instrumentation • Speedometer • Rev counter • Fuel gauge with low fuel level warning light • Water temperature gauge with warning light • Shift-up/down indication light – <i>Indicates when to change gear for optimum fuel economy.</i>	●	●	●	●	●		
Driver information display (centrally located in instrument cluster) • Monochrome display • Displays trip computer data • Total mileage • Service-due indicator • Oil life • Tyre pressure monitoring system	●	●	●	●	●		
Multi-function trip computer (displayed on driver information display) • Trip mileage • Vehicle range based on remaining fuel • Average speed • Average fuel economy • Instantaneous fuel economy • Driving time	●	●	●	●	●		
Central facia display (format dependent on infotainment unit) • Audio information • Digital clock with automatic RDS time adjustment • Outside air temperature with ice warning function • Additional features dependent on infotainment unit (see infotainment for details)	●	●	●	●	●		

● = Standard equipment. ○ = Optional at extra cost.

ZAFIRA TOURER FEATURES/OPTIONS

INTERIOR STYLING	Design	Energy	SRi	Tech Line Nav	Elite Nav	Price (£) exc. VAT	Total (£) inc. VAT
Design / Energy interior décor Steering wheel: • Three-spoke design • Satin chrome-effect bezel Facia and door trim: • Black facia with Silver trim inserts • Black door panels with black Atlantis cloth inserts • Blasted Silver trim inserts on front doors • Chrome-effect interior door handles Seat trim: • Jet Black Mando fabric seat trim inserts • Dark Pewter stitching • Plain black fabric side bolsters and surrounds	●	●					
SRi interior décor Steering wheel: • Three-spoke design • Leather-covered with accent stitching • Satin chrome-effect bezel Facia and door trim: • Black facia with Silver trim inserts • Silver air vent surrounds • Black door panels with black Atlantis cloth inserts • Blasted Silver trim inserts on front doors • Chrome-effect interior door handles Seat trim: • Jet Black Lace fabric seat trim inserts • Star Silver stitching • Plain black fabric side bolsters and surrounds			●				
Tech Line Nav interior décor (Not available with Lava Red and Darkmoon Blue exterior colours) Steering wheel: • Three-spoke design • Leather-covered with accent stitching • Satin chrome-effect bezel Facia and door trim: • Black facia with Ruthenium trim inserts • Plain black door panels with black Siena cloth inserts • Ruthenium trim inserts on front doors • Chrome-effect interior door handles Seat trim: • Jet Black Lilop fabric seat trim inserts • Two-tone stitching in Shadow Grey and Rust • Plain black leather-effect side bolsters				●			
Tech Line Nav interior décor (Standard with Darkmoon Blue exterior colour and only optional in conjunction with Mineral Black or Emerald Green exterior colours) Steering wheel: • Three-spoke design • Leather-covered with accent stitching • Satin chrome-effect bezel Facia and door trim: • Black facia with Ruthenium trim inserts • Light neutral door panels with black Siena cloth inserts • Ruthenium trim inserts on front doors • Chrome-effect interior door handles Seat trim: • Light Neutral Lilop fabric seat trim inserts • Two-tone stitching in Shadow Grey and Ceramic White • Light neutral leather-effect side bolsters				N/C		No-cost option	
Elite Nav interior décor Steering wheel: • Three-spoke design • Leather-covered with accent stitching • Satin chrome-effect bezel Facia and door trim: • Black facia with Ruthenium trim inserts • Silver air vent surrounds • Black door panels with black Leather-effect inserts • Ruthenium trim inserts on front doors • Chrome-effect interior door handles Seat trim: • Black Siena leather seat trim inserts • Star Silver stitching • Black leather-effect side bolsters and surrounds					●		

● = Standard equipment. N/C = No-cost option.

ZAFIRA TOURER FEATURES/OPTIONS

	Design	Energy	SRI	Tech Line Nav	Elite Nav	Price (£) exc. VAT	Total (£) inc. VAT
SEATING AND COMFORT							
Flex7® seating system	●	●	●	●	●		
Comfort front seats							
Driver's seat (eight-way adjustable): • Height (up/down) • Reach (fore/aft) • Backrest recline (upright/incline) • Head restraint (up/down)	●	●		●			
Front passenger's seat (six-way adjustable): • Reach (fore/aft) • Backrest (upright/recline) • Head restraint (up/down)							
Sports-style front seats							
Driver's seat (10-way adjustable): • Height (up/down) • Reach (fore/aft) • Backrest recline (upright/incline) • Head restraint (up/down) • Seat cushion extension (fore/aft)			●				
Front passenger's seat (eight-way adjustable): • Reach (fore/aft) • Backrest (upright/recline) • Head restraint (up/down) • Seat cushion extension (fore/aft)							
Ergonomic driver's sport style seat (AGR-approved*) with sports-style front passenger seat (on Tech Line Nav models standard trim changes to Lace Cloth. Not available with Darkmoon Blue exterior colour)							
Driver's seat (18-way adjustable): • Height (up/down) • Reach (fore/aft) • Tilt (fore/aft) • Backrest (upright/recline) • Seat cushion extension (fore/aft) • Lumbar adjustment (four-way electrical) • Head restraint (fore/aft/up/down)			□	○		400.00	480.00
Front passenger's seat (six-way adjustable): • Reach (fore/aft) • Backrest (upright/recline) • Head restraint (up/down)							
Ergonomic driver's and front passenger's seat pack (standard with optional Light Neutral seat trim)							
Drivers and front passenger's seats (18-way adjustable): • Height (up/down) • Reach (fore/aft) • Tilt (fore/aft) • Backrest (upright/recline) • Seat cushion extension (fore/aft) • Lumbar adjustment (four-way electrical) • Active head restraint (fore/aft/up/down)				●			
Leather Pack (Ergonomic driver's sport style seat (AGR-approved*) with sports-style front passenger seat)							
• Leather seat facings (front and second row seats) with leather-effect side bolsters • Heated front seats							
Driver's seat (16-way adjustable): • Height (up/down) • Reach (fore/aft) • Tilt (fore/aft) • Backrest (upright/recline) • Seat cushion extension (fore/aft) • Lumbar adjustment (four-way electrical) • Head restraint (up/down)			○		●	962.50	1155.00
Front passenger's seat (eight-way adjustable): • Reach (fore/aft) • Backrest (upright/recline) • Head restraint (up/down) • Seat cushion extension (fore/aft)							
Seat Comfort Pack One							
• Driver's seat with four-way electrical lumbar adjustment and manual cushion extension	○	○	●	○	●	150.00	180.00
Seat Comfort Pack Two (deletes underseat storage tray on Tech Line Nav models)							
• Driver's and front passenger's seat with four-way electrical lumbar adjustment and manual cushion extension	○	○		○		275.00	330.00
Rear seating							
• Height-adjustable and removable head restraints (second and third row seats) • 35/30/35 split-folding second-row seats • Second-row seats with sliding function plus fold-flat facility • Two individual fold flat third-row seats (height restrictions apply – When all seats are occupied within the Zafira Tourer passenger side third-row seat is only usable by a passenger up to a maximum height of 150cm.) • Storage pockets on front seat backs • Child-proof locks on rear doors • ISOFIX child seat mountings incorporating top tether anchor points located on outer rear seats (does not include child seat) – Allows ISOFIX child safety seats to be securely fixed into the car. The ISOFIX mounting system reduces forward movement in an accident and makes the child seat easier to install.	●	●	●	●	●		
• Front passenger's underseat storage facility					●		
• Lounge seating – Three individual second-row seats with the ability to convert into two 'captain' seats with individual centre armrest.				●	●		







● = Standard equipment. ○ = Optional at extra cost. □ = Available as part of an extra-cost option pack. * AGR (The Campaign for Healthier Backs) is an independent centre of excellence for ergonomics, based in Germany.

ZAFIRA TOURER FEATURES/OPTIONS

INFOTAINMENT	Design	Energy	SRi	Tech Line Nav	Elite Nav	Price (£) exc. VAT	Total (£) inc. VAT
R4.0 IntelliLink touchscreen infotainment system <i>For use with media players, USB memory sticks, mobile phones and smartphone apps.</i> Onboard features: <ul style="list-style-type: none"> • 7-inch colour touchscreen • DAB digital radio/AM/FM stereo radio with 36 station presets • RDS with Traffic Programme Media connections: <ul style="list-style-type: none"> • USB connection with iPod control • Bluetooth® A2DP audio streaming (Advanced Audio Distribution Profile) Mobile phone portal: <ul style="list-style-type: none"> • Bluetooth® connectivity • Handsfree calls via steering wheel controls • Vehicle microphone • Phone book access – Contacts/last calls/missed calls etc. are mirrored on IntelliLink's display and are easily navigated using the touchscreen (features dependent on mobile phone). Smartphone interface: <ul style="list-style-type: none"> • Apple CarPlay™ • Android Auto™ – Smartphone projection that allows operations via voice command, touchscreen and buttons to control apps and music playback. 	●		●				
Navi 4.0 IntelliLink touchscreen navigation and infotainment system <i>For use with media players, USB memory sticks, mobile phones and smartphone apps.</i> Onboard features: <ul style="list-style-type: none"> • 7-inch colour touchscreen • DAB digital radio/AM/FM stereo radio with 36 station presets • RDS with Traffic Programme Navigation features: <ul style="list-style-type: none"> • Satellite navigation system • 2D street level mapping • European coverage • Structured or one-box destination entry • Points-of-interest search • Eco routing • Map updates via USB Media connections: <ul style="list-style-type: none"> • USB connection with iPod control • Bluetooth® A2DP audio streaming (Advanced Audio Distribution Profile) Mobile phone portal: <ul style="list-style-type: none"> • Bluetooth® connectivity • Handsfree calls via steering wheel controls • Vehicle microphone • Phone book access – The majority of the phone's functions – contacts/last calls/missed calls etc. – are mirrored on IntelliLink's display and are easily navigated using the touchscreen (features dependent on mobile phone). Smartphone interface: <ul style="list-style-type: none"> • Apple CarPlay™ • Android Auto™ – Smartphone projection that allows operations via voice command, touchscreen and buttons to control apps and music playback. Gallery – only available when vehicle is stationary: <ul style="list-style-type: none"> • Photo gallery with slide show feature • Video playback with soundtrack played through car speakers 	○	●	▲	●	●	591.67	710.00
Six speakers (four front, two rear)	●	●	●	●	●		
Steering wheel mounted audio controls	●	●	●	●	●		

● = Standard equipment. ○ = Optional at extra cost. ▲ = Standard on Nav models, see pricing pages for details.

ZAFIRA TOURER FEATURES/OPTIONS

ONSTAR						Design	Energy	SRI	Tech Line Nav	Elite Nav	Price (£) exc. VAT	Total (£) inc. VAT
 <p>Automatic Crash Response</p>	 <p>Wi-Fi Hotspot</p>	 <p>Smartphone App</p>	 <p>Stolen Vehicle Assistance</p>	 <p>Vehicle Diagnostics</p>	 <p>Destination Download</p>							
<p>OnStar – your personal on board assistant</p> <p><i>Many car brands talk about innovation as soon as they improve their cup holders but this innovative system, now available on selected models**, is revolutionary: 24/7, 365 days a year, OnStar puts you in touch with a trained advisor, not a machine. With OnStar you have access to a host of innovations, from Vehicle Diagnostics and Smartphone Function to a fully integrated 4G Wi-Fi Hotspot†. In the event of an accident, OnStar even automatically calls for help, for an incomparable feeling of safety.</i></p> <p>* = Includes 12 months of OnStar services from date of first registration and a 3 month/3 GB Wi-Fi free trial period (whichever comes first) effective from the date the customer accepts the nominated network operator Wi-Fi Ts&Cs. Destination download feature only operates on models fitted with Navi 4.0 IntelliLink satellite navigation system. Theft alert feature only operates on models fitted with security alarm system.</p> <p>** = The OnStar Services require activation and are subject to mobile network coverage and availability. Wi-Fi Hotspot service requires account with nominated network operator.</p> <p>† = 4G is subject to mobile network coverage and availability. Charges apply after the free trial period. The OnStar subscription packages could be different from the services included in the free trial package. Check www.vauxhall.co.uk/onstar for terms and conditions, details of availability, coverage and charges.</p>						●	●	●	●	●		
<p>OnStar – delete standard-fit</p> <p><i>– Please note, cannot be deleted retrospectively and must be selected at time of ordering.</i></p>						N/C	N/C	N/C	N/C	N/C	No-cost option	



● = Standard equipment. N/C = No-cost option.

All OnStar services and Wi-Fi services will cease to be available on 31 December 2020. No trial or paid subscriptions or services, including emergency response services, will be available after that date.

ZAFIRA TOURER FEATURES/OPTIONS

	Design	Energy	SRi	Tech Line Nav	Elite Nav	Price (£) exc. VAT	Total (£) inc. VAT
HEATING AND VENTILATION							
Air conditioning • Air recirculation facility • Cabin particulate filter – Removes dust, airborne particles and pollen. • Multi-speed fan • Illuminated controls	●	●	●				
Electronic climate control including air conditioning • Dual-zone control – Allowing different, temperature settings for driver and front passenger. • Advanced predictive logic control system using sun and humidity sensors • Partial air recirculation – Faster warm up/cool down. • Cabin particulate filter – Removes dust, airborne particles and pollen. • Automatic air direction and fan speed with manual override • LCD temperature display • Illuminated controls • Rear floor heating ducts ✓ Set and forget temperature control ✓ Set different temperatures for driver and front passenger			○	●	●	337.50	405.00
Additional features • Four adjustable facia vents • Windscreen demist vents • Side window demist vents • Heated rear screen with timed cut-off	●	●	●	●	●		
Heated leather-covered steering wheel			□	□	○	95.83	115.00
Winter Pack – only available with standard seat trim on SRi models • Heated leather-covered steering wheel • Heated front seats (standard on Elite Nav models) ✓ Warm welcome			○	○		304.17	365.00

● = Standard equipment. ○ = Optional at extra cost. □ = Available as part of an extra-cost option pack.

ZAFIRA TOURER FEATURES/OPTIONS

INTERIOR CONVENIENCE / LIGHTING	Design	Energy	SRi	Tech Line Nav	Elite Nav	Price (£) exc. VAT	Total (£) inc. VAT
Convenience features	●	●	●	●	●		
• 12-volt electrical accessory socket within front and rear centre console • Dipping rear-view mirror							
• Driver's and front passenger's sunvisors incorporating illuminated vanity mirrors with covers	●	●	●	●			
12-volt electrical accessory socket within luggage compartment	□	□	□	□	□		
Automatically dimming anti-dazzle rear-view mirror			□	●	●		
Central storage facility with two cupholders and front centre armrest	●	●	●				
FlexRail® centre console system featuring aluminium rails, sliding tray/cup holder and front centre armrest				●	●		
Rear side window sunblinds	○	○	○	○	○	91.67	110.00
Standard lighting	●	●	●	●	●		
• Central front courtesy light • Central rear courtesy light • Fade up/fade down							
Premium lighting	●	●	●	●	●		
• First and second row reading lights with illuminated switches • Third row passenger compartment reading lights							
• Ambient LED facia/centre console downlighter • Driver's and front passenger's vanity mirrors with covers							
• Illuminated glove box and luggage area				●	●		
• Ambient LED lighting in facia and front doors							
Interior storage	●	●	●	●	●		
• Storage box on driver's side lower facia • Glovebox with lid • Front door pockets							
• Third row central storage facility with two cup holders • Rear door pockets							
• Storage pockets on front seat backs	●	●	●	●	●		
Loading Pack	○	○	○	○	○	125.00	150.00
• Vertical load restraining net • FlexCover interior protection liner							
• 12-volt electrical accessory socket within luggage compartment							
Luggage area	●	●	●	●	●		
• Luggage compartment cover • Illuminated load area • Fully carpeted load area • Interior tailgate handle							
• Four load restraint lashing eyes • Twin gas-assisted tailgate struts							
FlexOrganiser® Pack	○	○	○	○	○	133.33	160.00
• FlexOrganiser® rails • Restraint net with two bars • Small luggage restraint net • Adaptors							

● = Standard equipment. ○ = Optional at extra cost. □ = Available as part of an extra-cost option pack.

ZAFIRA TOURER FEATURES/OPTIONS

EXTERIOR LIGHTING	Design	Energy	SRI	Tech Line Nav	Elite Nav	Price (£) exc. VAT	Total (£) inc. VAT
Standard lighting features							
• LED daytime running lights • Ellipsoid headlights • Side repeat indicators	●	●	●	●	●		
• Lights-on audible warning • Electric headlight beam levelling • High-level LED centre rear brake light • Rear fog light							
• Reversing light • Hazard warning lights • Door-to-door illumination • Dark-style tail lights							
• Automatic lighting control with tunnel detection and digital high beam assist			□	●	●		
Dark-style headlights			●				
Chrome-effect headlights	●	●		●	●		
Premium Forward Lighting Pack				○	○	916.67	1100.00
• Intelligent Adaptive Forward Lighting (AFL) • LED headlights with dynamic beam levelling • LED tail lights							
Sight and Light Pack							
• Automatic lighting control with tunnel detection • Rain-sensitive windscreen wipers			○	●	●	200.00	240.00
• Electro-chromatic anti-dazzle rear-view mirror • Digital high beam assist							
Front fog lights		●	●	●	●		
LED tail lights				□	□		









● = Standard equipment. ○ = Optional at extra cost. □ = Available as part of an extra-cost option pack.

ZAFIRA TOURER FEATURES/OPTIONS

EXTERIOR CONVENIENCE / STYLING	Design	Energy	SRI	Tech Line Nav	Elite Nav	Price (£) exc. VAT	Total (£) inc. VAT
Windscreen wipers • Two-speed windscreen wipers with variable intermittent wipe • Intermittent rear window wash/wipe	●	●	●	●	●		
• Rain-sensitive windscreen wipers			□	●	●		
Door mirrors • Twin electrically adjustable/heated door mirrors • Manually folding door mirrors	●	●	●	●	●		
• Electrically foldable door mirrors	□	□	□	□	□		
Windows • Electrically operated front and rear windows with safety autoreverse and one-touch facility • Heated rear window	●	●	●	●	●		
• Solar heat-absorbing windscreen • Tinted windows	●	●	●	●	●		
• Dark-tinted rear windows		●	●	●	●		
Electro Pack • Electrically foldable door mirrors • 12-volt electrical accessory socket within luggage compartment	○	○	○	○	○	141.67	170.00
Panoramic windscreen and panoramic sunroof (requires optional electronic climate control, deletes silver-effect roof rails and driver's and front passenger's sunvisors incorporating illuminated vanity mirrors with covers) • Electrically operated interior sunblind			○	○	●	633.33	760.00
Roof rails • Black	●						
• Silver-effect		●	●	●			
Flex-Fix® integrated carrier system (includes two-bicycle carrier attachments) <i>Not available in conjunction with emergency spare wheel, Towing Pack and VXR Styling Pack. Please note, bicycle size restrictions apply, please contact your local Retailer for further information.</i>			○	○	○	758.33	910.00
Towing Pack • Detachable tow bar • Trailer stability programme integrated into ESP system	○	○	○	○	○	625.00	750.00
Body styling • Chrome-effect front grille bar • Chrome-effect headlight detail • Body-colour door handles • Body-colour door mirrors	●	●	●	●	●		
• Black trim on door pillars							
• Body-colour rear roof spoiler			●				
• Chrome-effect lower window surround		●		●	●		
• Visible stainless steel exhaust tailpipe (2.0CDTi (170PS) engines only) – Deleted if optional Flex-Fix® integrated carrier system is specified.	●	●	●	●	●		
VXR Styling Pack (Not available in conjunction with optional Flex-Fix® integrated carrier system or Aegean Blue exterior colour) • Body-colour front lower spoiler, side sills, rear lower skirt and rear roof spoiler	○	○	○	○	○	958.33	1150.00

● = Standard equipment. ○ = Optional at extra cost. □ = Available as part of an extra-cost option pack.





ZAFIRA TOURER FEATURES/OPTIONS

EXTERIOR COLOURS		<i>Design</i>	<i>Energy</i>	<i>SRi</i>	<i>Tech Line Nav</i>	<i>Elite Nav</i>	Price (£) exc. VAT	Total (£) inc. VAT
	Aegean Blue • Solid paint • Folding key with Grey insert	●	●	●	●	●		
	Summit White • Brilliant paint • Folding key with White insert • Not available with Lilop Light Neutral cloth seat trim	○	○	○	○	○	237.50	285.00
	Lava Red • Brilliant paint • Folding key with Red insert	○	○	○		○	237.50	285.00
	Sovereign Silver • Two-coat metallic paint • Folding key with Grey insert • Not available with Lilop Light Neutral cloth seat trim							
	Satin Steel Grey • Two-coat metallic paint • Folding key with Red insert • Not available with Lilop Light Neutral cloth seat trim							
	Mineral Black • Two-coat metallic paint • Folding key with Black insert							
	Flip Chip Silver • Two-coat metallic paint • Folding key with White insert • Not available with Lilop Light Neutral cloth seat trim	○	○	○	○	○	470.83	565.00
	Cosmic Grey • Two-coat metallic paint • Folding key with Grey insert • Not available with Lilop Light Neutral cloth seat trim							

● = Standard equipment. ○ = Optional at extra cost.

The colours reproduced may vary slightly from the actual paint colour. As a result they should be used as a guide only. Your Vauxhall Retailer has a comprehensive display of our paint samples.





ZAFIRA TOURER FEATURES/OPTIONS

EXTERIOR COLOURS			<i>Design</i>	<i>Energy</i>	<i>SRI</i>	<i>Tech Line Nav</i>	<i>Elite Nav</i>	Price (£) exc. VAT	Total (£) inc. VAT
	<p>Dark Caramel</p> <ul style="list-style-type: none"> • Two-coat premium paint • Folding key with Black insert • Not available with Lilop Light Neutral cloth seat trim 							545.83	655.00
	<p>Emerald Green</p> <ul style="list-style-type: none"> • Two-coat premium paint • Folding key with Black insert 		○	○	○	○	○		
	<p>Abalone White</p> <ul style="list-style-type: none"> • Tri-coat premium paint • Folding key with white insert • Not available with Lilop Light Neutral cloth seat trim 		○	○	○	○	○	604.17	725.00

● = Standard equipment. ○ = Optional at extra cost.

The colours reproduced may vary slightly from the actual paint colour. As a result they should be used as a guide only. Your Vauxhall Retailer has a comprehensive display of our paint samples.

ZAFIRA TOURER FEATURES/OPTIONS

WHEELS AND TYRES		<i>Design</i>	<i>Energy</i>	<i>SRi</i>	<i>Tech Line Nav</i>	<i>Elite Nav</i>	Price (£) exc. VAT	Total (£) inc. VAT
Emergency spare wheel (in lieu of emergency tyre inflation kit)		○	○	○	○	○	91.67	110.00
	17-inch multi-spoke alloy wheels • 225/50 R 17 tyres • Emergency tyre inflation kit (in lieu of spare wheel)	●	●		●			
	17-inch multi-spoke alloy wheels (1.6CDTi (134PS) S/S ecoTEC only) • 225/50 R 17 tyres • Emergency tyre inflation kit (in lieu of spare wheel)			●				
	18-inch 5-twin-spoke alloy wheels (1.4i Turbo/2.0CDTi) • 235/45 R 18 tyres • Emergency tyre inflation kit (in lieu of spare wheel)			●				
	18-inch 5-twin-spoke alloy wheels (1.6CDTi (134PS) S/S ecoTEC only) • 235/45 R 18 tyres • Emergency tyre inflation kit (in lieu of spare wheel)			○			91.67	110.00
	18-inch 10-spoke alloy wheels • 235/45 R 18 tyres • Emergency tyre inflation kit (in lieu of spare wheel)				○	●	416.67	500.00

● = Standard equipment. ○ = Optional at extra cost.



ZAFIRA TOURER FEATURES/OPTIONS

WHEELS AND TYRES

	Design	Energy	SRi	Tech Line Nav	Elite Nav	Price (£) exc. VAT	Total (£) inc. VAT
 <p>19-inch 5-spoke bi-colour alloy wheels</p> <ul style="list-style-type: none"> • 235/40 R 19 tyres • Emergency tyre inflation kit (in lieu of spare wheel) 			○		○	458.33	550.00
 <p>19-inch multi-spoke alloy wheels</p> <ul style="list-style-type: none"> • 235/40 R 19 tyres • Emergency tyre inflation kit (in lieu of spare wheel) 				○		666.67	800.00

○ = Optional at extra cost.

TYRE RATING

Tyre size	Fuel efficiency group	Wet grip performance	External noise	
			Measured (dB)	Group
225/50 R 17	B-E	B-C	68-71	
235/45 R 18	E	B	71	
235/40 R 19	E	B	71	

Tyre rating according to EU Regulation 1222/2009

ZAFIRA TOURER SPECIFICATIONS

PETROL ENGINE

1.4i Turbo (140PS)	
Capacity	1364cc
Maximum power	140PS (103kW) @ 4900-6000rpm
Maximum torque	200Nm (147 lb.ft.) @ 1850-4900rpm
Configuration	4 cylinders, 4 valves per cylinder, double overhead camshafts
Fuel/induction system	Water-cooled turbocharger with intercooler. Variable Valve Timing (VVT). Multi-point sequential fuel injection
Emission compliance	Euro 6
Service interval	20,000 miles or 1 year (whichever occurs sooner)

DIESEL ENGINES

	1.6CDTi (134PS) ecoTEC with Start/Stop	2.0CDTi (170PS) with Start/Stop*
Capacity	1598cc	1956cc
Maximum power	134PS (99kW) @ 3500-4000rpm	170PS (125kW) @ 3750rpm
Maximum torque	320Nm (236 lb.ft.) @ 2000rpm	400Nm (295 lb.ft.) @ 1750-2500rpm
Configuration	4 cylinders, 4 valves per cylinder, double overhead camshafts	4 cylinders, 4 valves per cylinder, double overhead camshafts
Fuel/induction system	Variable geometry turbocharger with intercooler. Common rail fuel injection	Turbocharger with intercooler. Common rail fuel injection
Emission compliance	Euro 6	Euro 6
Service interval	20,000 miles or 1 year (whichever occurs sooner)	20,000 miles or 1 year (whichever occurs sooner)

* = Start/Stop on manual models only.

ZAFIRA TOURER SPECIFICATIONS

PERFORMANCE, FUEL ECONOMY AND EMISSIONS

	Wheel size (inches)	Performance (manufacturer's figures)		Fuel economy mpg (litres/100km) [#]			CO ₂ emissions g/km [#]	Vehicle Excise Duty* First year rate	Standard rate	Benefit in kind company car taxation rates – 2018/19 tax year
		Maximum speed (mph)	Acceleration 0-60mph (sec)	Urban driving	Extra-urban driving	Combined figure				
Manual										
1.4i Turbo (140PS)	17/18/19	124	9.9	33.2 (8.5)	49.6 (5.7)	41.5 (6.8)	156	£515	£140	32%
1.6CDTi (134PS) Start/Stop ecoTEC	17	120	10.4	53.3 (5.3)	70.6 (4.0)	62.8 (4.5)	119	£205	£140	28%
1.6CDTi (134PS) Start/Stop	18/19	120	10.4	50.4 (5.6)	67.3 (4.2)	60.1 (4.7)	125	£205	£140	30%
2.0CDTi (170PS) Start/Stop	17	129	9.1	47.1 (6.0)	67.3 (4.2)	57.7 (4.9)	129	£205	£140	30%
2.0CDTi (170PS) Start/Stop	18/19	129	9.1	44.1 (6.4)	62.8 (4.5)	54.3 (5.2)	137	£515	£140	32%
Automatic										
1.4i Turbo (140PS)	17/18/19	122	10.2	30.4 (9.3)	50.4 (5.6)	40.9 (6.9)	160	£515	£140	33%
2.0CDTi (170PS)	17/18/19	127	9.3	34.4 (8.2)	58.9 (4.8)	46.3 (6.1)	161	£830	£140	37%

* = Correct at time of publication.

= Fuel consumption information is official government environmental data, tested in accordance with the relevant EU directive. Official EU-regulated test data is provided for comparison purposes and actual performance will depend on driving style, road conditions and other non-technical factors.

OPTIONAL TRANSMISSION

Six-speed automatic transmission with ActiveSelect[®] function

A six-speed automatic transmission is optional on 1.4i Turbo (140PS) and 2.0CDTi (170PS) models. On the road, a wide selection of shift patterns is adapted to the style and habits of the driver, anticipating when maximum acceleration or maximum efficiency is required. The electronic control will also adapt to the prevailing road conditions, reducing gear shifting when climbing or descending and using engine braking assistance during down changes.

The ActiveSelect[®] manual mode allows the gear lever to be used like a sequential manual gearbox – you simply push the lever forward or back to change up or down the gears. The driver also benefits from a 'neutral' gear disengagement at idle, which reduces vibration and contributes to improved fuel consumption.

STEERING

- Power-assisted steering
- Turning circle (kerb-to-kerb):
– 11.40m (37.4ft.)

SUSPENSION

Front: Independent. Lightweight MacPherson struts with gas-pressure dampers and coil springs. Anti-roll bar.

Rear: Lightweight compound crank rear axle with one-piece, hollow cast trailing arms. Built-in anti-roll bar. Progressive-rate double conical mini-block springs with gas-pressure dampers.

BRAKES

- Anti-lock Braking System (ABS)
- Electronic brakeforce distribution
- Hydraulic brake fade assist
- Cornering brake control
- Emergency brake assist
- Hill start assist
- Electric parking brake (standard on Tech Line Nav and Elite Nav models only)

BODY

Aerodynamic drag co-efficient:
– Cd 0.32.

FUEL TANK CAPACITY

58 litres (12.8 gallons)

ADBLUE TANK CAPACITY

7.8 litres (1.7 gallons)

ZAFIRA TOURER SPECIFICATIONS

EXTERIOR DIMENSIONS millimetres (inches)

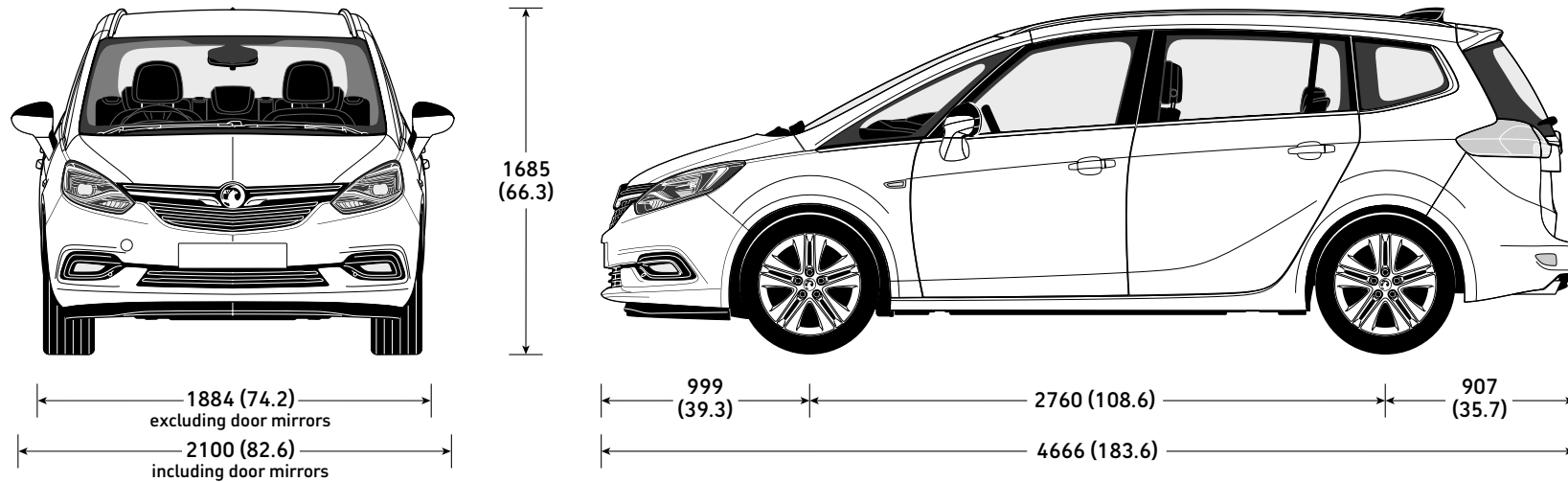

WEIGHTS AND TOWING DATA kg

	Gross vehicle weight	Max. towing weights Trailer with brakes (without brakes)
1.4i Turbo (140PS)	2310	1300 (750)
1.4i Turbo (140PS) automatic	2340	1550 (750)
1.6CDTi (134PS) Start/Stop ecoTEC	2380	1450 (750)
2.0CDTi (170PS) Start/Stop	2455	1650 (750)
2.0CDTi (170PS) automatic	2470	1650 (750)

Gross vehicle weight is the total permissible weight of the vehicle including passengers and their luggage. The maximum roof rack loading should not exceed 100kg. The maximum towing weights are based on the ability of the car, with two occupants of 75kg each, to restart on a 12% gradient, which is approximately 1 in 8.3, at sea level. The permitted trailer load applies up to the specified incline and up to an altitude of 1000 metres above sea level. The permissible gross train weight decreases by 10% for every 1000 metres of additional altitude. Any extra weight, such as luggage or additional passengers, should be deducted from the maximum towing weight. With a trailer fully loaded, maximum noseweight should not exceed 75kg. Always fit Vauxhall towing attachments and accessories available from your Vauxhall Retailer. They are designed specifically for Vauxhall models and carry a 12-month guarantee. During trailer towing do not exceed a maximum speed of 60mph. This speed limit is also applicable in countries with higher permitted speeds for trailer-vehicle combinations. Pay attention to the local speed limits. For trailers with low driving stability and caravans the use of an oscillation damper is strongly recommended.

LOADSPACE DIMENSIONS millimetres (inches)

Maximum floor length – behind front seats, second-row and third-row seats folded	1842 (72.5)
Maximum floor length – behind second-row seats	1093 (43.0)
Width between wheel arches	1057 (41.6)
Tailgate aperture height	840 (33.0)
Tailgate aperture lower width	1045 (41.1)

LOADSPACE CAPACITIES measured using the ECIE method

	litres (cu.ft.)
Behind third-row seats, to glass line	152 (5.4)
Behind second-row seats, to glass line	710 (25.1)
Behind front seats, to roof	1860 (65.6)

ZAFIRA TOURER ACCESSORIES

INFOTAINMENT Total (inc. VAT)

Sat Nav updates¹

Please consult your Retailer for latest map updates or visit www.vauxhall.co.uk/accessories.

1 = For use with optional factory-fit satellite navigation systems.

CHILD SEATS²

BABY-SAFE ³ – 0-13kg/birth to 15 months	£132.00
– ISOFIX base	£227.00
DUO ISOFIX ³ – 9-18kg/9 months to 4 years	
with top tether kit	£347.00
KID ³ –15-36kg or 4 to 12 years	£157.00

2 = Restrictions apply to the use of child seats, please consult your Vauxhall Retailer or request a copy of the Child seats brochure.

3 = Without transponder.

SAFETY

Safety Pack – first aid kit, warning triangle, hi-visibility vest, Vauxhall bag	£35.00
First aid kit	£15.00
Warning triangle	£17.00
Fire extinguisher – 2kg	£37.00
Hi-visibility vest	£9.00
Tyre sealant	£68.00
Tyre inflation compressor	£120.00
Tyre repair kit	£150.00

SECURITY

Locking wheel nuts – set of four	£39.00
----------------------------------	--------

FLEXCONNECT RANGE Total (inc. VAT)

FlexConnect bracket	£20.00
FlexConnect hook	£28.00
FlexConnect coat hanger	£58.00
FlexConnect folding table	£68.00
FlexConnect iPad Mini cradle	£98.00
FlexConnect iPad (1-4) cradle	£106.00
FlexConnect iPad Air cradle	£106.00
FlexConnect Samsung Galaxy cradle	£96.00

PRACTICAL

Spare bulb kit ⁴	£26.00
Premium spare bulb kit ⁴	£32.00
Privacy shades	
– side windows	£91.00
– rear window	£83.00
Stretch tow rope – up to 3000kg	£34.00
Towing bar – up to 2500kg	£85.00

4 = Excludes xenon headlight bulb for models with Adaptive Forward Lighting (AFL).

PROTECTION

Rubber floor mats	
– front and second row	£59.00
Velour floor mats – set of four	£69.00
Mudflaps	
– front	£56.00
– rear	£56.00
Alloy-effect sports pedals	from £113.00
Front door sill plates (single)	£28.00
Cargo net – horizontal	£21.00
Cargo liner	£47.00
Load compartment mat	from £163.00
Storage box	£27.00
Dog guard	£206.00
Load compartment divider rail	£95.00

TRANSPORT SYSTEMS Total (inc. VAT)

Roof base carrier (without roof rails)	£170.00
Roof base carrier (with roof rails)	£166.00
Roof carriers (requires base carrier)	
Bike roof carrier – Thule Freeride 532	£76.00
Surf board roof carrier – Thule 833	£101.00
Kayak roof carrier – Thule 837	£168.00
Ski roof carrier (400mm wide)	
– Thule Deluxe 726	£138.00
Ski roof carrier (600mm wide)	
– Thule 739	£235.00
Hard shell roof boxes (requires base carrier)	
Thule Ocean 80	
(320 litre / 1330 x 860 x 370mm)	£235.00
Thule Ocean 200	
(390 litre / 1750 x 820 x 450mm)	£316.00
Thule Dynamic M	
(320 litre / 2060 x 840 x 340mm)	from £625.00
Thule Dynamic L	
(430 litre / 2350 x 940 x 350mm)	£846.00
Thule Excellence	
(520 litre / 2180 x 940 x 400mm)	£898.00
Thule Motion 800	
(460 litre / 2050 x 840 x 450mm)	from £515.00
Thule Touring 200	
(400 litre / 1750 x 820 x 450mm)	£372.00
Thule Touring 780	
(430 litre / 2320 x 700 x 420mm)	£460.00
Soft roof boxes (requires base carrier)	
Thule Ranger 90	
(280 litre / 1100 x 800 x 400mm)	£285.00
Thule Ranger 500	
(300 litre / 1900 x 500 x 300mm)	£378.00
Tailgate carrier	
Bike tailgate carrier – Thule BacPac 973	£282.00
Fitting kit	£48.00

Tow bar carrier system Total (inc. VAT)

Fixed tow bar	
– 13-pin electrics	£638.00
Detachable tow bar	
– 13-pin electrics	£659.00

STYLING

VX-Line styling pack	• Front lower spoiler	
• Rear lower skirt	• Rear roof spoiler	
• Side sills		from £1908.00
VX-Line rear roof spoiler ⁵		£642.00

5 = Not suitable for SRi models. Requires additional aerial adaptor of extra cost. Please consult your Retailer for details.

ALLOY WHEELS (set of four with centre caps)⁶

17-inch 7-spoke	£617.00
18-inch 5-double spoke	£674.00
18-inch 5-spoke	£970.00
18-inch 10-spoke	£1016.00
19-inch 10-spoke	£1373.00
Other designs available	

6 = Different tyres and locking wheel bolts/nuts may be required at extra cost. Price excludes new tyres and locking wheel bolts/nuts, includes static wheel balancing.

Please note:

Prices shown are a fully fitted and painted, where applicable and include VAT. Please check with your local Vauxhall Retailer for details. It is advisable to ensure your insurance policy is adequate to cover additional fitted accessories. Prices correct at time of publication.

ZAFIRA TOURER COMPANY CAR DRIVER/FLEET INFORMATION

DESIGN AND TECH LINE NAV HIGH SPEC, LOW P11D

Specifically developed for businesses and company car drivers alike, our Design and Tech Line Nav models are seriously fit for Fleet.

Design models all feature very low P11D values, generous standard specification with a choice of high tech ecoTEC engines for great fuel economy and low emissions.

For even more standard specification, step up to our Tech Line Nav range again you are guaranteed low P11D values, plus great standard kit including Sat Nav, Bluetooth®, USB connection and digital radio.

With Design and Tech Line Nav you can take for granted low Whole Life Costs and low company car driver taxation.

FLEET TOOLBOX

Discover the facts in our online Toolbox for both Company Car Drivers and Fleet Decision Makers. The Fleet Toolbox has a host of useful calculators, comparators, interactive listings and information. Visit the Fleet Toolbox by going to www.vauxhall-toolbox.co.uk



ROADTRIP APP

The Vauxhall RoadTrip App is a free app that calculates and logs your mileage expenses for any UK business trips and generates reports to help you complete your mileage claims. Available for both iPhone and Android, visit www.vauxhall-toolbox.co.uk or visit the iPhone or Android stores and search for Vauxhall RoadTrip to download it to your smartphone or tablet.



BENEFIT IN KIND COMPANY CAR TAXATION*

The car benefit charge will be the car's list price (including VAT, options and accessories fitted, delivery to Retailer and number plates, but excluding Vehicle Excise Duty and new vehicle first registration fee) multiplied by the percentage charge for the CO₂ emissions band in which the car falls (see table opposite). Multiply this figure by your personal income tax rate (20%** for Basic Rate, 40%** for Higher Rate) to calculate your annual benefit in kind tax liability.

Example:

Zafira Tourer Design 1.6CDTi (134PS)	
Start/Stop ecoTEC 5-dr MPV	
(CO ₂ emissions 119g/km)	
On-the-road RRP	£24400.00
Deduct: Vehicle Excise Duty	(£205.00)
New vehicle first registration fee	(£55.00)
Effective list price	£24140.00
Add: Optional two-coat metallic paint	£565.00
List price for tax purposes (P11D value)	£24705.00

Car benefit charge	
2018-19 tax year (28%)	£6917.00
Benefit in kind tax liability (2018-19 tax year)	
Basic Rate (20%) tax payer	£1383.40
Higher Rate (40%) tax payer	£2766.80

* = Please note this Price Guide provides taxation information as a guide only. Vauxhall does not provide taxation guidance. Drivers should always take professional advice on their own tax position. ** = Excludes residents of Scotland.

BIK FOR SCOTTISH RESIDENTS

Effective 6 April 2018 the Scottish Government have introduced their own BIK taxation structure. This only applies to Company Car Drivers that are Scottish taxpayers. HMRC will determine whether or not an individual is a Scottish taxpayer based on where their main place of residence is.

The BIK rates for Scotland are:

- Over £11,850-£13,850 Starter Rate 19%
- Over £13,850-£24,000 Basic Rate 20%
- Over £24,000-£43,430 Intermediate Rate 21%
- Over £43,430-£150,000 Higher Rate 41%
- Above £150,000 Top Rate 46%

CO ₂ emissions in grams per kilometre	Percentage of car's price to be taxed	
	Non-Diesel† 2018-19 tax year	Diesel†† 2018-19 tax year
Up to 50	13	17
51-75	16	20
76-94	19	23
95-99	20	24
100-104	21	25
105-109	22	26
110-114	23	27
115-119	24	28
120-124	25	29
125-129	26	30
130-134	27	31
135-139	28	32
140-144	29	33
145-149	30	34
150-154	31	35
155-159	32	36
160-164	33	37
165-169	34	37
170-174	35	37
175-179	36	37
180 and above	37	37

† = Also applies to diesel vehicles that meet the Real Driving Emissions Step 2 (RDE2). †† = Applies to vehicles that do not meet the Real Driving Emissions Step 2 (RDE2).

To calculate your own personal liability a car tax calculator is available at: <https://www.vauxhallfleet.co.uk/toolbox>

CONTACT VAUXHALL FLEET

Please contact one of our dedicated sales teams who will be happy to help with your particular enquiry.

Company Car Drivers

Call: 0345 111 2020

Email: company-car@vauxhallinfo.co.uk

Telephone lines are open

– Monday to Friday 8.00am-9.00pm

– Saturday and Sunday 9.00am-6.00pm

Fleet Decision Makers

Depending on the size of your fleet of vehicles, we have a dedicated team to handle your enquiries. The lines are open Monday to Friday excluding Bank Holidays.

1-24 vehicles

Call: 0845 076 2254 (8.30am-5.00pm)

Email: b2bsales@vauxhall.co.uk

25+ vehicles

Call: 0330 587 8222 (8.30am-5.00pm)

Email: vauxhallfleet@vauxhall.co.uk

Special Vehicles (Police, Fire and Ambulance)

Call: 01582 409999 (8.30am-5.00pm)

Email: vauxhallspecialvehicles@vauxhall.co.uk

ZAFIRA TOURER ADDITIONAL INFORMATION

ON-THE-ROAD PRICES

To eliminate uncertainty about hidden costs when buying a new car, Vauxhall publishes on-the-road recommended retail prices (RRP) and these are shown in the pricing tables within this price guide. These prices include VAT, number plates and delivery to Retailer of £700.00 (including £116.67 VAT), 12 months' Government Vehicle Excise Duty (see opposite for details) and the DVLA new vehicle first registration fee of £55.00*.

Please note: The on-the-road recommended retail price (RRP) does not include fuel supplied by the Retailer, motor insurance or any other goods or services supplied by agreement between the Retailer and the customer.

PRICE PROTECTION

Order a new Vauxhall for build in the current model year (as confirmed by your Retailer) for delivery no more than three months in advance and the price you are quoted is the price you pay. This is irrespective of any subsequent price rises between placing your order and delivery of your new car, but you must take delivery as soon as the car is available. Vauxhall Motors Limited is not liable for price adjustments caused by Government changes in the rate of VAT (currently 20%), Vehicle Excise Duty, DVLA new vehicle first registration fee or by any other applicable legislation or regulations.

VAUXHALL FINANCE LEASING

Vauxhall Finance Leasing is a trading style of Vauxhall Finance plc. Working with the Vauxhall Retailer network we provide competitive car and van leasing solutions for business users and private individuals. We combine the support of a national contract with the convenience of a local contact. For further information, please contact your local Vauxhall Retailer or visit www.vauxhall.co.uk/leasing

IN THE EVENT OF AN ACCIDENT...

Vauxhall Accident Management helps keep you mobile following an accident. Benefits include vehicle recovery, Vauxhall-approved repairs and contacting your insurer. For more details, visit vauxhall.co.uk/AccidentManagement

VEHICLE EXCISE DUTY

The amount of Vehicle Excise Duty (road fund licence) payable on new cars varies depending on the level of carbon dioxide (CO₂) emissions produced by the vehicle. CO₂ emissions are measured in grammes (g) per kilometre (km) travelled and divided into 13 charging bands shown in the table below.

A 'first year rate' of Vehicle Excise Duty is payable on all new cars and in subsequent years the amount payable reverts to the 'standard rate'. From 1 April 2017 the breakpoints for each of these bands have been revised. Also, for vehicles with a list price over £40,000, including factory-fitted options, an additional £310 is payable for the first five years of standard rate payments.

VEHICLE EXCISE DUTY*

	CO ₂ emissions	First year rate		Standard rate
		Non-diesel**	Diesel†	
Band A	0g/km	£0.00	£0.00	£0.00
Band B	1 – 50g/km	£10.00	£25.00	£140.00
Band C	51 – 75g/km	£25.00	£105.00	£140.00
Band D	76 – 90g/km	£105.00	£125.00	£140.00
Band E	91 – 100g/km	£125.00	£145.00	£140.00
Band F	101 – 110g/km	£145.00	£165.00	£140.00
Band G	111 – 130g/km	£165.00	£205.00	£140.00
Band H	131 – 150g/km	£205.00	£515.00	£140.00
Band I	151 – 170g/km	£515.00	£830.00	£140.00
Band J	171 – 190g/km	£830.00	£1,240.00	£140.00
Band K	191 – 225g/km	£1,240.00	£1,760.00	£140.00
Band L	226 – 255g/km	£1,760.00	£2,070.00	£140.00
Band M	over 255g/km	£2,070.00	£2,070.00	£140.00

* = Correct at time of issue. ** = Also applies to diesel vehicles that meet the Real Driving Emissions Step 2 (RDE2).
 † = Applies to vehicles that do not meet the Real Driving Emissions Step 2 (RDE2).

TRUST VAUXHALL

CUSTOMER CARE COMMITMENT

For added peace of mind, Vauxhall has an innovative Customer Care Commitment that offers the following:

- Three-year vehicle warranty consisting of a one-year/unlimited mileage manufacturer's warranty and a second and third year manufacturer's warranty with a 60,000 miles limitation
- Vauxhall Assistance for 12 months from first registration
- Six years' body panel anti-perforation warranty

Please note: Warranty is only available on vehicles sourced from Vauxhall Motors Limited. Terms and conditions apply – please see your Vauxhall Retailer for details.

VAUXHALL ASSISTANCE

Vauxhall Assistance is provided automatically with every new Vauxhall for 12 months from first registration and covers everything from accident assistance, roadside recovery and 'at home' service to flat tyres. With Vauxhall Assistance help is literally just a free* phone call away, 24 hours a day, 365 days a year!

* = Mobile phone users will be charged at their standard tariff.

PROTECTING THE ENVIRONMENT

Vauxhall's commitment to the environment is demonstrated by our products' many environmental awards. For even more information on Vauxhall's efforts to achieve an environmentally sustainable future, and how to dispose of your end-of-life vehicle, see www.vauxhall.co.uk/recycling

VAUXHALL SERVICE PLAN

- Fixed monthly payments for the plan duration
- Easy to budget and interest-free
- Genuine parts fitted by Vauxhall-trained technicians

Plus on Gold plans:

- Valet and courtesy car
- Full AA cover
- Engine flush and fuel treatments
- Litre of oil for top ups between services

Full details can be obtained from your local participating Vauxhall Retailer.

VAUXHALL INSURANCE WITH ADDED REASSURANCE

Comprehensive cover – Summary of benefits**

- Competitive premiums
- Repairs by a Vauxhall-trained technician
- Genuine Vauxhall parts, guaranteed for three years when we repair your car within our Approved Repairer Network
- Free courtesy car as standard when using an Approved Repairer†
- 24 hour claims helpline
- Personal Accident benefit
- Cover for audio equipment
- Windscreen cover

Call for a quote on 0844 463 2670††

** = The benefits listed above are for comprehensive cover only. For details of Third Party, Fire and Theft cover, please call our sales team.
† = Should your car need repairing following an accident we provide a courtesy car (subject to availability) for the duration of the repair. Only genuine Vauxhall parts are used. Terms and conditions apply.
†† = Calls may be recorded. Vauxhall Insurance is underwritten by Ageas Insurance Limited.

FOR MORE PRODUCT INFORMATION

For a brochure on any Vauxhall model (up to a maximum of three per caller) or location of your nearest Vauxhall Retailer please call **0345 600 1500**. Alternatively, details can be found on our website at www.vauxhall.co.uk

JOIN US ONLINE:



Privacy Policy – For full details please visit: vauxhall.co.uk/privacy

OnStar privacy details are available at vauxhall.co.uk/onstar

The invoice price, including delivery to Retailer, factory-fitted options, accessories fitted by the Retailer and number plates, is subject to VAT. Some feature descriptions in this guide may refer to, and some illustrations may show, optional equipment not included in the standard delivery. The information contained in this guide was accurate at the time of publication. We reserve the right to make changes in design and equipment. Please note that Vauxhall Retailers are not the agents of Vauxhall Motors Limited and are not authorised to bind Vauxhall Motors Limited by any specific or implied undertaking or representation. It is advisable to ensure that your motor insurance policy provides adequate cover for additional fitted options and accessories. The colours in this guide are only approximate actual colours. Illustrated optional equipment is available at extra charge. Availability, technical features and equipment provided on our vehicles can vary by model. For precise information on the equipment provided on our vehicles, please contact your local Vauxhall Retailer.

VAUXHALL

vauxhall.co.uk

©2018 Vauxhall Motors Limited

Published 1 October 2018 Vauxhall Motors Limited