

ZAFIRA TOURER

PRICE/SPECIFICATION GUIDE

3 October 2017 | Model Year 2018



Contents:

Model Year 2018 (pages 2-34)

Model Year 2017.5 (pages 36-67)



VAUXHALL

ZAFIRA TOURER CUSTOMER OFFERS

At Vauxhall we know that customers appreciate flexibility. Not only do we have an extensive range of Zafira Tourer models to choose from, but we have a range of ways to purchase too. Here's an example of our personal contract hire offer:



For ONLY **£345**
per month over
35 months with £4,140
advance rental

For even more great deals contact your local Retailer or call 0345 600 1500 or visit www.vauxhall.co.uk/offers

TERMS AND CONDITIONS: Personal contract hire offer on Zafira Tourer Energy 1.4i Turbo (140PS), including free of charge metallic paint, on vehicles ordered by 18 December 2017, subject to availability and status. Age 18+ only. Figures based on a non-maintenance contract hire package with advance rental of £4,140, then 35 monthly rentals of £345 Excess miles over contracted mileage of 24,000 over 36 months charged at 8 pence per mile. Excess charges also apply if you breach manufacturer servicing or maintenance guidelines or if the car exceeds BVRLA Fair Wear & Tear guidelines for its age/mileage when it is returned to Vauxhall Leasing. Package includes Road Fund Licence and Vauxhall Assistance. Guarantee/indemnity may be required. Prices and details are subject to change without notice. For full specification and Ts&Cs contact your local Retailer. You will not own the car. ALD Automotive Ltd., trading as Vauxhall Leasing, BS16 7LBs. Authorised and regulated by the Financial Conduct Authority.

ZAFIRA TOURER RANGE HIGHLIGHTS



DESIGN OTR from £19,530

Standard features include:

Exterior convenience / styling:

- 17-inch alloy wheels
- Remote control central locking
- Electrically operated front and rear windows
- Electrically adjustable/heated door mirrors
- Front / rear parking distance sensors

Interior convenience / styling:

- Air conditioning
- Cruise control with speed limiter
- Steering column adjustable for reach / rake
- Steering wheel audio / phone / cruise controls
- Central storage facility with two cup holders
- Ambient lighting in roof
- Luggage compartment cover

Infotainment:

- R4.0 IntelliLink audio system
 - 7-inch colour touchscreen
 - AM/FM/DAB digital radio
 - Bluetooth® audio streaming / Bluetooth® mobile phone portal
 - USB audio connection
 - Apple CarPlay™ / Android Auto™
- Six speakers

Safety / security:

- Vauxhall OnStar
- Electronic Stability Programme (ESP)
- Anti-lock Braking System (ABS)
- Six airbags
- ISOFIX child seat mounting points on outer rear seats
- Height-adjustable front and rear seat head restraints
- Door-to-door illumination
- LED daytime running lights
- Electronic engine deadlock immobiliser



ENERGY OTR from £22,650

Features over Design:

Exterior convenience / styling:

- Front fog lights
- Chrome-effect lower window surround
- Dark-tinted rear windows
- Silver-effect roof rails

Infotainment:

- Navi 4.0 IntelliLink satellite navigation system
 - Fully integrated European satellite navigation system



SRI OTR from £24,195

Features over Design:

Exterior convenience / styling:

- 17-inch multi-spoke alloy wheels (1.6CDTi)
- 18-inch alloy wheels (1.4i Turbo/2.0CDTi)
- Front fog lights
- Silver-effect roof rails

Interior convenience / styling:

- Three-spoke chrome-bezelled leather-covered steering wheel
- Sports style seats
- Driver's seat with tilt and four-way electric lumbar adjustment
- Sports pedals

Safety / security:

- Remote control security alarm system

SRI Nav models additionally feature

- Navi 4.0 IntelliLink satellite navigation system
 - Fully integrated European satellite navigation system



17-inch







18-inch





ZAFIRA TOURER RANGE HIGHLIGHTS



SE	OTR from £24,180
<i>Features over Design:</i>	
Exterior convenience / styling:	
<ul style="list-style-type: none"> • Automatic lighting control • Rain-sensitive windscreen wipers • Dark-tinted rear windows • Front fog lights • Chrome-effect lower window surround • Silver-effect roof rails 	
Interior convenience / styling:	
<ul style="list-style-type: none"> • Electronic climate control • Three-spoke chrome-bezelled leather-covered steering wheel • Lounge seating • FlexRail® centre console system • Front passenger's underseat storage facility • Electric parking brake 	
Safety / security:	
<ul style="list-style-type: none"> • Remote control security alarm system 	
	
	



TECH LINE NAV	OTR from £21,225
<i>Features over Design:</i>	
Exterior convenience / styling:	
<ul style="list-style-type: none"> • Automatic lighting control • Rain-sensitive windscreen wipers • Dark-tinted rear windows • Front fog lights • Chrome-effect lower window surround • Silver-effect roof rails 	
Interior convenience / styling:	
<ul style="list-style-type: none"> • Electronic climate control • Three-spoke chrome-bezelled leather-covered steering wheel • Lounge seating • FlexRail® centre console system • Front passenger's underseat storage facility • Electric parking brake 	
Infotainment:	
<ul style="list-style-type: none"> • Navi 4.0 IntelliLink satellite navigation system <ul style="list-style-type: none"> – Fully integrated European satellite navigation system 	
Safety / security:	
<ul style="list-style-type: none"> • Remote control security alarm system 	
	
	

ELITE	OTR from £25,660
<i>Features over SE:</i>	
Exterior convenience / styling:	
<ul style="list-style-type: none"> • 18-inch alloy wheels • Panoramic windscreen • Panoramic sunroof (excludes roof rails) 	
Interior convenience / styling:	
<ul style="list-style-type: none"> • Leather seat trim (front and second row seats) • Heated front seats • Ergonomic driver's sports front seat, featuring: <ul style="list-style-type: none"> – Extendable seat cushion and seat tilt adjustment – Four-way electrical lumbar adjustment 	
Elite Nav models additional feature	
<ul style="list-style-type: none"> • Navi 4.0 IntelliLink satellite navigation system <ul style="list-style-type: none"> – Fully integrated European satellite navigation system 	
	
	

ZAFIRA TOURER DESIGN

		5-door MPV	
		OTR RRP	CO ₂ (g/km)
DESIGN – ON-THE-ROAD PRICES			
<i>Petrol</i>	1.4i Turbo (140PS)	£19,530	156
	1.4i Turbo (140PS) auto	£21,050	160
<i>Diesel</i>	1.6CDTi (134PS) S/S ecoTEC BlueInjection	£22,185	119
	2.0CDTi (170PS) S/S BlueInjection	£22,385	129
	2.0CDTi (170PS) auto BlueInjection	£23,665	161

Please note: On-the-road recommended retail prices (RRP) include VAT at 20%, number plates and delivery to Retailer of £700.00 (inc. £116.67 VAT), 12 months' Vehicle Excise Duty and new vehicle first registration fee of £55.00. Excludes fuel and insurance. S/S = Start/Stop.

KEY OPTIONS		Total inc. VAT
 Looking good:	Brilliant paint	£285
	Two-coat metallic paint	£565
	Two-coat premium paint	£655
	Tri-coat premium paint	£725
 Practicality:	Emergency spare wheel (in lieu of emergency tyre inflation kit)	£110
	Remote control alarm	£290
	Navi 4.0 IntelliLink satellite navigation system	£710
	Seat Comfort Pack One	£180
	Seat Comfort Pack Two	£330
	Rear side window sunblinds	£110
	Loading Pack	£150
	FlexOrganiser® Pack	£160
	Electro Pack	£170
	Towing Pack	£750
	VXR Styling Pack	£1150

For details of these and other options please see Features/Options pages.



FEATURES

Vauxhall OnStar:

- Automatic crash response / Wi-Fi hotspot / smartphone app / stolen vehicle assistance / vehicle diagnostics

Infotainment:

- R4.0 IntelliLink audio system
 - 7-inch colour touchscreen
 - AM/FM/DAB digital radio
 - Bluetooth® audio streaming
 - Bluetooth® mobile phone portal
 - USB audio connection
 - Apple CarPlay™ / Android Auto™
- Six speakers

Interior convenience / styling:

- Air conditioning
- Multi-function trip computer
- Cruise control with speed limiter
- Steering column adjustable for reach / rake
- Steering wheel audio / phone / cruise controls
- Front centre armrest
- Central storage facility with two cup holders
- Ambient lighting in roof
- Luggage compartment cover

Exterior convenience / styling:



- 17-inch alloy wheels
- Remote control central locking
- Electrically operated front and rear windows
- Electrically adjustable/heated door mirrors
- Front and rear parking distance sensors
- Black roof rails

Safety / security:

- Electronic Stability Programme (ESP)
- Anti-lock Braking System (ABS)
- Six airbags
- ISOFIX child seat mounting points on outer rear seats
- Deactivation switch for front passenger's front and side-impact airbags
- Height-adjustable front and rear seat head restraints
- Tyre pressure monitoring system
- Door-to-door illumination
- LED daytime running lights
- Electronic engine deadlock immobiliser



CUSTOMER OFFERS*

Please consult your Retailer for details.

-  Flexible Personal Lease
-  Flexible PCP (4.2% APR)

COMPANY CAR INFORMATION

Please see www.vauxhall.co.uk/fleet for details.

-  P11D price starting at £18,975
-  From 25% tax band** / £92 monthly car tax**
-  CO₂ emissions from 119g/km

* = Terms and conditions apply.

** = 2017/18 tax year.



ZAFIRA TOURER ENERGY

5-door MPV
OTR RRP CO₂ (g/km)

ENERGY – ON-THE-ROAD PRICES

Engine	Power (PS)	OTR RRP	CO ₂ (g/km)
Petrol	1.4i Turbo (140PS)	£22,650	156
	1.4i Turbo (140PS) auto	£24,170	160
Diesel	1.6CDTi (134PS) S/S ecoTEC BlueInjection	£25,305	119
	2.0CDTi (170PS) S/S BlueInjection	£25,505	129
	2.0CDTi (170PS) auto BlueInjection	£26,785	161

Please note: On-the-road recommended retail prices (RRP) include VAT at 20%, number plates and delivery to Retailer of £700.00 (inc. £116.67 VAT), 12 months' Vehicle Excise Duty and new vehicle first registration fee of £55.00. Excludes fuel and insurance. S/S = Start/Stop.

KEY OPTIONS	Total inc. VAT	
 Looking good:	Brilliant paint	£285
	Two-coat metallic paint	£565
	Two-coat premium paint	£655
	Tri-coat premium paint	£725
 Easier parking:	Rear-view camera	£250
 Practicality:	Emergency spare wheel (in lieu of emergency tyre inflation kit)	£110
	Remote control alarm	£290
	Seat Comfort Pack One	£180
	Seat Comfort Pack Two	£330
	Rear side window sunblinds	£110
	Loading Pack	£150
	FlexOrganiser® Pack	£160
	Electro Pack	£170
	Towing Pack	£750
	VXR Styling Pack	£1150

For details of these and other options please see Features/Options pages.



FEATURES

Vauxhall OnStar:

- Automatic crash response / Wi-Fi hotspot / smartphone app / stolen vehicle assistance / vehicle diagnostics

Infotainment:

- Navi 4.0 IntelliLink satellite navigation system
- Fully integrated European satellite navigation system
- 7-inch colour touchscreen
- AM/FM/DAB digital radio
- Bluetooth® audio streaming
- Bluetooth® mobile phone portal
- USB audio connection
- Apple CarPlay™ / Android Auto™
- Six speakers

Interior convenience / styling:

- Air conditioning
- Multi-function trip computer
- Cruise control with speed limiter
- Steering column adjustable for reach / rake
- Steering wheel audio / phone / cruise controls
- Front centre armrest
- Central storage facility with two cup holders
- Ambient lighting in roof
- Luggage compartment cover

Exterior convenience / styling:



- 17-inch alloy wheels
- Remote control central locking
- Electrically operated front and rear windows
- Electrically adjustable/heated door mirrors
- Front and rear parking distance sensors
- Front fog lights
- Chrome-effect lower window surround
- Dark-tinted rear windows
- Silver-effect roof rails

Safety / security:

- Electronic Stability Programme (ESP)
- Anti-lock Braking System (ABS)
- Six airbags
- ISOFIX child seat mounting points on outer rear seats
- Deactivation switch for front passenger's front and side-impact airbags
- Height-adjustable front and rear seat head restraints
- Tyre pressure monitoring system
- Door-to-door illumination
- LED daytime running lights
- Electronic engine deadlock immobiliser

CUSTOMER OFFERS*



Please consult your Retailer for details.

-  0% Flexible Finance
-  Flexible PCP (4.2% APR) with £1200 Vauxhall Deposit Contribution
-  Flexible Personal Lease

* = Terms and conditions apply.

COMPANY CAR INFORMATION

Please see www.vauxhall.co.uk/fleet for details.

-  P11D price starting at £22,095
-  From 25% tax band** / £105 monthly car tax**
-  CO₂ emissions from 119g/km







** = 2017/18 tax year.

ZAFIRA TOURER SRI

		5-door MPV	
		OTR RRP	CO ₂ (g/km)
SRI – ON-THE-ROAD PRICES	<i>Petrol</i> 1.4i Turbo (140PS)	£24,195	156
	1.4i Turbo (140PS) auto	£25,715	160
<i>Diesel</i>	1.6CDTi (134PS) S/S ecoTEC BlueInjection	£26,850	119
	2.0CDTi (170PS) S/S BlueInjection	£27,025	137
	2.0CDTi (170PS) auto BlueInjection	£28,330	161

		5-door MPV	
		OTR RRP	CO ₂ (g/km)
SRI NAV – ON-THE-ROAD PRICES	<i>Petrol</i> 1.4i Turbo (140PS)	£24,895	156
	1.4i Turbo (140PS) auto	£26,415	160
<i>Diesel</i>	1.6CDTi (134PS) S/S ecoTEC BlueInjection	£27,550	119
	2.0CDTi (170PS) S/S BlueInjection	£27,725	137
	2.0CDTi (170PS) auto BlueInjection	£29,030	161

Please note: On-the-road recommended retail prices (RRP) include VAT at 20%, number plates and delivery to Retailer of £700.00 (inc. £116.67 VAT), 12 months' Vehicle Excise Duty and new vehicle first registration fee of £55.00. Excludes fuel and insurance. S/S = Start/Stop.

KEY OPTIONS		Total inc. VAT
 Looking good:	Brilliant paint	£285
	Two-coat metallic paint	£565
	Two-coat premium paint	£655
	Tri-coat premium paint	£725
	18-inch 5-twinspoke alloy wheels (1.6CDTi (134PS) ecoTEC only)	£110
	19-inch 5-spoke bi-colour alloy wheels	£550
 Easier parking:	Rear-view camera	£250
 Sitting comfortably:	Electronic climate control including air conditioning	£405
	Heated leather-covered steering wheel	£115
	Winter Pack	£365
	Leather Pack	£1155
 Fresh air:	Panoramic windscreen and panoramic sunroof	£760
 Driving assistance:	Sight and Light Pack	£240
 Practicality:	Emergency spare wheel (in lieu of emergency tyre inflation kit)	£110
	Rear side window sunblinds	£110
	Loading Pack	£150
	FlexOrganiser® Pack	£160
	Electro Pack	£170
	Towing Pack	£750
	Flex-Fix® integrated carrier system	£910
	VXR Styling Pack	£1150

For details of these and other options please see Features/Options pages.



FEATURES

Vauxhall OnStar:

- Automatic crash response / Wi-Fi hotspot / smartphone app / stolen vehicle assistance / vehicle diagnostics

Infotainment:

- R4.0 IntelliLink audio system
 - 7-inch colour touchscreen
 - AM/FM/DAB digital radio
 - Bluetooth® audio streaming
 - Bluetooth® mobile phone portal
 - USB audio connection
 - Apple CarPlay™ / Android Auto™
- Six speakers

Interior convenience / styling:

- Air conditioning
- Multi-function trip computer
- Cruise control with speed limiter
- Steering column adjustable for reach / rake
- Steering wheel audio / phone / cruise controls
- Three-spoke chrome-bezelled leather-covered steering wheel
- Sports style seats
- Driver's seat with tilt and four-way electric lumbar adjustment
- Front centre armrest
- Central storage facility with two cup holders
- Ambient lighting in roof
- Sports pedals
- Luggage compartment cover

Exterior convenience / styling:

- 17-inch alloy wheels (1.6CDTi)
- 18-inch alloy wheels (1.4i Turbo/2.0CDTi)
- Remote control central locking
- Electrically operated front and rear windows
- Electrically adjustable/heated door mirrors
- Front and rear parking distance sensors
- Front fog lights
- Silver-effect roof rails

Safety / security:



- Electronic Stability Programme (ESP)
- Anti-lock Braking System (ABS)
- Six airbags
- ISOFIX child seat mounting points on outer rear seats
- Deactivation switch for front passenger's front and side-impact airbags
- Height-adjustable front and rear seat head restraints
- Door-to-door illumination
- Tyre pressure monitoring system
- LED daytime running lights
- Remote control security alarm system
- Electronic engine deadlock immobiliser

SRI Nav models additionally feature

- Navi 4.0 IntelliLink satellite navigation system
 - Fully integrated European satellite navigation system

CUSTOMER OFFERS*



Please consult your Retailer for details.

-  **0% Flexible Finance**
-  **Flexible PCP (4.2% APR) with £1200 Vauxhall Deposit Contribution**
-  **Flexible Personal Lease**

* = Terms and conditions apply.

COMPANY CAR INFORMATION

Please see www.vauxhall.co.uk/fleet for details.

-  **P11D price starting at £23,640**
-  **From 25% tax band** / £111 monthly car tax****
-  **CO₂ emissions from 119g/km**

** = 2017/18 tax year.

ZAFIRA TOURER SE

5-door MPV
OTR RRP CO₂ (g/km)

SE – ON-THE-ROAD PRICES

Engine	Power (PS)	OTR RRP	CO ₂ (g/km)
Petrol	1.4i Turbo (140PS)	£24,180	156
	1.4i Turbo (140PS) auto	£25,700	160
Diesel	1.6CDTi (134PS) S/S ecoTEC BlueInjection	£26,835	119
	2.0CDTi (170PS) S/S BlueInjection	£27,035	129
	2.0CDTi (170PS) auto BlueInjection	£28,315	161

Please note: On-the-road recommended retail prices (RRP) include VAT at 20%, number plates and delivery to Retailer of £700.00 (inc. £116.67 VAT), 12 months' Vehicle Excise Duty and new vehicle first registration fee of £55.00. Excludes fuel and insurance. S/S = Start/Stop.

KEY OPTIONS	Total inc. VAT	
Looking good:	Brilliant paint	£285
	Two-coat metallic paint	£565
	Two-coat premium paint	£655
	Tri-coat premium paint	£725
	18-inch 10-spoke alloy wheels	£500
	19-inch multispoke alloy wheels	£800
Easier parking:	Rear-view camera	£250
	Front camera system	£805
Sitting comfortably:	Winter Pack	£365
	Ergonomic driver's sport style seat	£480
Fresh air:	Panoramic windscreen and panoramic sunroof	£760
Driving assistance:	Driver Assistance Pack <i>Forward collision alert with automatic city emergency braking / automatic cruise control / side blind spot alert / following distance indicator</i>	£1005
	FlexRide adaptive chassis system	£810
	Premium Forward Lighting Pack	£1100
	Navi 4.0 IntelliLink satellite navigation system	£710
	Emergency spare wheel (in lieu of emergency tyre inflation kit)	£110
Practicality:	Seat Comfort Pack One	£180
	Seat Comfort Pack Two	£330
	Rear side window sunblinds	£110
	Loading Pack	£150
	FlexOrganiser® Pack	£160
	Electro Pack	£170
	Towing Pack	£750
	Flex-Fix® integrated carrier system	£910
	VXR Styling Pack	£1150

For details of these and other options please see Features/Options pages.



FEATURES

Vauxhall OnStar:

- Automatic crash response / Wi-Fi hotspot / smartphone app / stolen vehicle assistance / vehicle diagnostics

Infotainment:

- R4.0 IntelliLink audio system
 - 7-inch colour touchscreen
 - AM/FM/DAB digital radio
 - Bluetooth® audio streaming
 - Bluetooth® mobile phone portal
 - USB audio connection
 - Apple CarPlay™ / Android Auto™
- Six speakers

Interior convenience / styling:

- Electronic climate control
- Multi-function trip computer
- Cruise control with speed limiter
- Steering column adjustable for reach / rake
- Steering wheel audio / phone / cruise controls
- Three-spoke chrome-bezelled leather-covered steering wheel
- Lounge seating
- FlexRail® centre console system
- Front passenger's underseat storage facility
- Electric parking brake
- Ambient lighting in roof
- Luggage compartment cover

Exterior convenience / styling:

- 17-inch alloy wheels
- Remote control central locking
- Electrically operated front and rear windows
- Electrically adjustable/heated door mirrors
- Front and rear parking distance sensors
- Automatic lighting control
- Rain-sensitive windscreen wipers
- Dark-tinted rear windows
- Front fog lights
- Chrome-effect lower window surround
- Silver-effect roof rails

Safety / security:

- Electronic Stability Programme (ESP)
- Anti-lock Braking System (ABS)
- Six airbags
- ISOFIX child seat mounting points on outer rear seats
- Deactivation switch for front passenger's front and side-impact airbags
- Height-adjustable front and rear seat head restraints
- Tyre pressure monitoring system
- Door-to-door illumination
- LED daytime running lights
- Remote control security alarm system
- Electronic engine deadlock immobiliser

CUSTOMER OFFERS*

Please consult your Retailer for details.

- 0% Flexible Finance**
- Flexible PCP (4.2% APR) with £1200 Vauxhall Deposit Contribution**
- Flexible Personal Lease**

* = Terms and conditions apply.

COMPANY CAR INFORMATION

Please see www.vauxhall.co.uk/fleet for details.

- P11D price starting at £23,625**
- From 25% tax band** / £111 monthly car tax****
- CO₂ emissions from 119g/km**

** = 2017/18 tax year.

ZAFIRA TOURER TECH LINE NAV



5-door MPV
OTR RRP CO₂ (g/km)

TECH LINE NAV – ON-THE-ROAD PRICES

Engine	Power	OTR RRP	CO ₂ (g/km)
Petrol	1.4i Turbo (140PS)	£21,225	156
	1.4i Turbo (140PS) auto	£22,745	160
Diesel	1.6CDTi (134PS) S/S ecoTEC BlueInjection	£23,880	119
	2.0CDTi (170PS) S/S BlueInjection	£24,080	129
	2.0CDTi (170PS) auto BlueInjection	£25,360	161

Please note: On-the-road recommended retail prices (RRP) include VAT at 20%, number plates and delivery to Retailer of £700.00 (inc. £116.67 VAT), 12 months' Vehicle Excise Duty and new vehicle first registration fee of £55.00. Excludes fuel and insurance. S/S = Start/Stop.

KEY OPTIONS	Total inc. VAT	
Looking good:	Brilliant paint	£285
	Two-coat metallic paint	£565
	Two-coat premium paint	£655
	Tri-coat premium paint	£725
	18-inch 10-spoke alloy wheels	£500
	19-inch multispoke alloy wheels	£800
Easier parking:	Rear-view camera	£250
	Front camera system	£805
Sitting comfortably:	Winter Pack	£365
	Ergonomic driver's sport style seat	£480
Fresh air:	Panoramic windscreen and panoramic sunroof	£760
Driving assistance:	Driver Assistance Pack <i>Forward collision alert with automatic city emergency braking / automatic cruise control / side blind spot alert / following distance indicator</i>	£1005
	FlexRide adaptive chassis system	£810
	Premium Forward Lighting Pack	£1100
	Practicality:	
	Emergency spare wheel (in lieu of emergency tyre inflation kit)	£110
	Seat Comfort Pack One	£180
	Seat Comfort Pack Two	£330
	Rear side window sunblinds	£110
	Loading Pack	£150
	FlexOrganiser® Pack	£160
	Electro Pack	£170
	Towing Pack	£750
	Flex-Fix® integrated carrier system	£910
	VXR Styling Pack	£1150

For details of these and other options please see Features/Options pages.

FEATURES

Vauxhall OnStar:

- Automatic crash response / Wi-Fi hotspot / smartphone app / stolen vehicle assistance / vehicle diagnostics

Infotainment:

- Navi 4.0 IntelliLink satellite navigation system
- Fully integrated European satellite navigation system
- 7-inch colour touchscreen
- AM/FM/DAB digital radio
- Bluetooth® audio streaming
- Bluetooth® mobile phone portal
- USB audio connection
- Apple CarPlay™ / Android Auto™
- Six speakers

Interior convenience / styling:

- Electronic climate control
- Multi-function trip computer
- Cruise control with speed limiter
- Steering column adjustable for reach / rake
- Steering wheel audio / phone / cruise controls
- Three-spoke chrome-bezelled leather-covered steering wheel
- Lounge seating
- FlexRail® centre console system
- Front passenger's underseat storage facility
- Electric parking brake
- Ambient lighting in roof

Exterior convenience / styling:

- 17-inch alloy wheels
- Remote control central locking
- Electrically operated front and rear windows
- Electrically adjustable/heated door mirrors
- Front and rear parking distance sensors
- Automatic lighting control
- Rain-sensitive windscreen wipers
- Dark-tinted rear windows
- Front fog lights
- Chrome-effect lower window surround
- Silver-effect roof rails

Safety / security:

- Electronic Stability Programme (ESP)
- Anti-lock Braking System (ABS)
- Six airbags
- ISOFIX child seat mounting points on outer rear seats
- Deactivation switch for front passenger's front and side-impact airbags
- Height-adjustable front and rear seat head restraints
- Tyre pressure monitoring system
- Door-to-door illumination
- LED daytime running lights
- Remote control security alarm system
- Electronic engine deadlock immobiliser

CUSTOMER OFFERS*

Please consult your Retailer for details.

- Flexible Personal Lease
- Flexible PCP (4.2% APR)

COMPANY CAR INFORMATION

Please see www.vauxhall.co.uk/fleet for details.

- P11D price starting at £20,670
- From 25% tax band** / £99 monthly car tax**
- CO₂ emissions from 119g/km

* = Terms and conditions apply.





** = 2017/18 tax year.

ZAFIRA TOURER ELITE

		5-door MPV	
		OTR RRP	CO ₂ (g/km)
ELITE – ON-THE-ROAD PRICES			
Petrol	1.4i Turbo (140PS)	£25,660	156
	1.4i Turbo (140PS) auto	£27,180	160
Diesel	2.0CDTi (170PS) S/S BlueInjection	£28,490	137
	2.0CDTi (170PS) auto BlueInjection	£29,795	161

		5-door MPV	
		OTR RRP	CO ₂ (g/km)
ELITE NAV – ON-THE-ROAD PRICES			
Petrol	1.4i Turbo (140PS)	£26,360	156
	1.4i Turbo (140PS) auto	£27,880	160
Diesel	2.0CDTi (170PS) S/S BlueInjection	£29,190	137
	2.0CDTi (170PS) auto BlueInjection	£30,495	161

Please note: On-the-road recommended retail prices (RRP) include VAT at 20%, number plates and delivery to Retailer of £700.00 (inc. £116.67 VAT), 12 months' Vehicle Excise Duty and new vehicle first registration fee of £55.00. Excludes fuel and insurance. S/S = Start/Stop.

KEY OPTIONS		Total inc. VAT
 Looking good:	Brilliant paint	£285
	Two-coat metallic paint	£565
	Two-coat premium paint	£655
	Tri-coat premium paint	£725
	19-inch 5-spoke bi-colour alloy wheels	£550
 Easier parking:	Rear-view camera	£250
	Front camera system	£805
 Driving assistance:	Driver Assistance Pack <i>Forward collision alert with automatic city emergency braking / automatic cruise control / side blind spot alert / following distance indicator</i>	£1005
	FlexRide adaptive chassis system	£810
	Premium Forward Lighting Pack	£1100
	 Practicality:	Emergency spare wheel (in lieu of emergency tyre inflation kit)
Rear side window sunblinds		£110
Loading Pack		£150
FlexOrganiser® Pack		£160
Electro Pack		£170
Towing Pack		£750
Flex-Fix® integrated carrier system		£910
VXR Styling Pack	£1150	

For details of these and other options please see Features/Options pages.



FEATURES

Vauxhall OnStar:

- Automatic crash response / Wi-Fi hotspot / smartphone app / stolen vehicle assistance / vehicle diagnostics

Infotainment:

- R4.0 IntelliLink audio system
 - 7-inch colour touchscreen
 - AM/FM/DAB digital radio
 - Bluetooth® audio streaming
 - Bluetooth® mobile phone portal
 - USB audio connection
 - Apple CarPlay™ / Android Auto™
- Six speakers

Interior convenience / styling:

- Leather seat trim (front and second row seats)
- Electronic climate control
- Multi-function trip computer
- Cruise control with speed limiter
- Steering column adjustable for reach / rake
- Steering wheel audio / phone / cruise controls
- Three-spoke chrome-bezelled leather-covered steering wheel
- Lounge seating
- Heated front seats
- Ergonomic driver's sports front seat, featuring:
 - Extendable seat cushion and seat tilt adjustment
 - Four-way electrical lumbar adjustment
- FlexRail® centre console system
- Electric parking brake
- Luggage compartment cover

Exterior convenience / styling:

- 18-inch alloy wheels
- Remote control central locking
- Panoramic windscreen
- Panoramic sunroof
- Chrome-effect lower window surround
- Dark-tinted rear windows
- Automatic lighting control
- Front fog lights
- Rain-sensitive windscreen wipers
- Electrically operated front and rear windows
- Electrically adjustable/heated door mirrors
- Front and rear parking distance sensors

Safety / security



- Electronic Stability Programme (ESP)
- Anti-lock Braking System (ABS)
- Six airbags
- ISOFIX child seat mounting points on outer rear seats
- Deactivation switch for front passenger's front and side-impact airbags
- Height-adjustable front and rear seat head restraints
- Tyre pressure monitoring system
- Door-to-door illumination
- LED daytime running lights
- Remote control security alarm system
- Electronic engine deadlock immobiliser

Elite Nav models additional feature

- Navi 4.0 IntelliLink satellite navigation system
- Fully integrated European satellite navigation system

CUSTOMER OFFERS*



Please consult your Retailer for details.

-  **0% Flexible Finance**
-  **Flexible PCP (4.2% APR) with £1200 Vauxhall Deposit Contribution**
-  **Flexible Personal Lease**

* = Terms and conditions apply.

COMPANY CAR INFORMATION

Please see www.vauxhall.co.uk/fleet for details.

-  **P11D price starting at £25,105**
-  **From 29% tax band** / £126 monthly car tax****
-  **CO₂ emissions from 137g/km**

** = 2017/18 tax year.

ZAFIRA TOURER PRICES

Model 5-door MPV	Price (£)	VAT (£)	Total (£)	On-the-road RRP (£)	CO ₂ (g/km)	Model 5-door MPV	Price (£)	VAT (£)	Total (£)	On-the-road RRP (£)	CO ₂ (g/km)
DESIGN VAUXHALL						SE VAUXHALL					
1.4i Turbo (140PS)	15229.17	3045.83	18275.00	19530.00	156	1.4i Turbo (140PS)	19104.17	3820.83	22925.00	24180.00	156
1.4i Turbo (140PS) auto	16495.83	3299.17	19795.00	21050.00	160	1.4i Turbo (140PS) auto	20370.83	4074.17	24445.00	25700.00	160
<i>Diesel</i>						<i>Diesel</i>					
1.6CDTi (134PS) S/S ecoTEC BlueInjection*	17725.00	3545.00	21270.00	22185.00	119	1.6CDTi (134PS) S/S ecoTEC BlueInjection*	21600.00	4320.00	25920.00	26835.00	119**
2.0CDTi (170PS) S/S BlueInjection*	17891.67	3578.33	21470.00	22385.00	129	2.0CDTi (170PS) S/S BlueInjection*	21766.67	4353.33	26120.00	27035.00	129
2.0CDTi (170PS) auto BlueInjection*	18675.00	3735.00	22410.00	23665.00	161	2.0CDTi (170PS) auto BlueInjection*	22550.00	4510.00	27060.00	28315.00	161
ENERGY VAUXHALL						TECH LINE NAV VAUXHALL					
1.4i Turbo (140PS)	17829.17	3565.83	21395.00	22650.00	156	1.4i Turbo (140PS)	16641.67	3328.33	19970.00	21225.00	156
1.4i Turbo (140PS) auto	19095.83	3819.17	22915.00	24170.00	160	1.4i Turbo (140PS) auto	17908.33	3581.67	21490.00	22745.00	160
<i>Diesel</i>						<i>Diesel</i>					
1.6CDTi (134PS) S/S ecoTEC BlueInjection*	20325.00	4065.00	24390.00	25305.00	119	1.6CDTi (134PS) S/S ecoTEC BlueInjection*	19137.50	3827.50	22965.00	23880.00	119**
2.0CDTi (170PS) S/S BlueInjection*	20491.67	4098.33	24590.00	25505.00	129	2.0CDTi (170PS) S/S BlueInjection*	19304.17	3860.83	23165.00	24080.00	129
2.0CDTi (170PS) auto BlueInjection*	21275.00	4255.00	25530.00	26785.00	161	2.0CDTi (170PS) auto BlueInjection*	20087.50	4017.50	24105.00	25360.00	161
SRI VAUXHALL						ELITE VAUXHALL					
1.4i Turbo (140PS)	19116.67	3823.33	22940.00	24195.00	156	1.4i Turbo (140PS)	20337.50	4067.50	24405.00	25660.00	156
1.4i Turbo (140PS) auto	20383.33	4076.67	24460.00	25715.00	160	1.4i Turbo (140PS) auto	21604.17	4320.83	25925.00	27180.00	160
<i>Diesel</i>						<i>Diesel</i>					
1.6CDTi (134PS) S/S ecoTEC BlueInjection*	21612.50	4322.50	25935.00	26850.00	119**	2.0CDTi (170PS) S/S BlueInjection*	22945.83	4589.17	27535.00	28490.00	137
2.0CDTi (170PS) S/S BlueInjection*	21725.00	4345.00	26070.00	27025.00	137	2.0CDTi (170PS) auto BlueInjection*	23783.33	4756.67	28540.00	29795.00	161
2.0CDTi (170PS) auto BlueInjection*	22562.50	4512.50	27075.00	28330.00	161	ELITE NAV VAUXHALL					
SRI NAV VAUXHALL						1.4i Turbo (140PS)	20920.83	4184.17	25105.00	26360.00	156
1.4i Turbo (140PS)	19700.00	3940.00	23640.00	24895.00	156	1.4i Turbo (140PS) auto	22187.50	4437.50	26625.00	27880.00	160
1.4i Turbo (140PS) auto	20966.67	4193.33	25160.00	26415.00	160	<i>Diesel</i>					
<i>Diesel</i>						2.0CDTi (170PS) S/S BlueInjection*	23529.17	4705.83	28235.00	29190.00	137
1.6CDTi (134PS) S/S ecoTEC BlueInjection*	22195.83	4439.17	26635.00	27550.00	119**	2.0CDTi (170PS) auto BlueInjection*	24366.67	4873.33	29240.00	30495.00	161
2.0CDTi (170PS) S/S BlueInjection*	22308.33	4461.67	26770.00	27725.00	137	Please note: On-the-road recommended retail prices (RRP) include number plates and delivery to retailer of £700.00 (inc. £116.67 VAT), 12 months' Vehicle Excise Duty and new vehicle first registration fee of £55.00. Excludes fuel and insurance.					
2.0CDTi (170PS) auto BlueInjection*	23145.83	4629.17	27775.00	29030.00	161	S/S = Start/Stop.					
						* = Please note: Vehicles with BlueInjection technology will need regular AdBlue® top-ups also between servicing requirements. An indicator integrated into the on-board computer will warn you when you need to top up. More information under www.vauxhall.co.uk/blueinjection . In accordance with regulations R (EC) No. 715/2007 and R (EC) No. 692/2008 (in the versions respectively applicable).					
						** = CO ₂ emissions are based on vehicles fitted with standard 17-inch alloy wheels. If optional alloy wheels are specified, at extra cost, CO ₂ emissions will be affected.					

ZAFIRA TOURER FEATURES/OPTIONS

SAFETY

Driver / passenger airbags

- Driver's airbag • Front passenger's airbag • Two front seat side-impact airbags
- Full-size curtain airbags for driver and front and outer rear seat passengers

Seating

- Height adjustable front and outer rear seat head restraints • Anti-submarining ramps in front seats – Prevents occupants sliding underneath the lap belt during a collision.

Seatbelts

- Five lap and diagonal inertia-reel seatbelts (height-adjustable front) • Third-row lap and diagonal inertia-reel seatbelts (when all seats are occupied within the Zafira Tourer the passenger side third-row seat is only usable by a passenger up to a maximum height of 150cm (4ft 11 inches))
- Front body-lock diagonal seatbelt pretensioner system – Tightens the seatbelt during the early stages of a frontal impact. • Drivers and front passenger's lap belt pretensioner system • Front seatbelt force limiters – Reduces potential upper body injuries during a frontal impact. • Anti-submarining ramps in front seats – Help prevent occupants sliding underneath the lap belt during a collision.

Child safety

- Deactivation switch for front passenger's front and side-impact airbags – Permits the safe use of a child seat in the front passenger seat • ISOFIX child seat mountings incorporating top tether anchor points located on outer rear seats (does not include child seat) – Allows ISOFIX child safety seats to be securely fixed into the car. The ISOFIX mounting system reduces forward movement in an accident and makes the child seat easier to install. • Child-proof locks on rear doors

Driver / passenger safety

- Energy-absorbing steering column • Pedal release system – Reduces potential injury to the driver's legs and feet during a severe frontal impact. • Laminated windscreen • Side-impact protection beams • Reinforced passenger safety cell • Deformation zones front and rear
- Burst-proof door locks and anti-jam door design

Pedestrian safety

- Bonnet / headlight / wiper structure – Designed to reduce pedestrian head and upper body injuries.
- Upper and lower bumper design – Reduces upper and lower leg injuries.

Stability

Electronic Stability Programme (ESP):

– Works in conjunction with the vehicle's electronic braking and engine systems to keep the car stable in many different situations. ESP monitors many different inputs to determine when the car starts to lose traction, it can then immediately respond by varying the brake pressure between up to three wheels and adjust the engine output to help correct the loss of traction and improve stability.

Additional ESP features:

- Cornering brake control • Straight line stability control • Rollover mitigation • Drag torque control – Maintain stability on slippery roads when lifting off the accelerator or changing gear

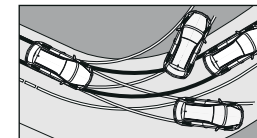

Braking

Anti-lock Braking System (ABS):

– Prevents the vehicle's wheels from locking up under heavy braking by momentarily reducing brake pressure at the appropriate wheel, ensuring that you can maintain control of the steering.

Additional braking features:



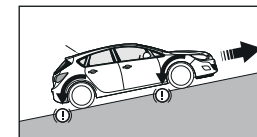



- The same electronic systems used in the ABS and ESP also deliver exceptional braking performance.
- Emergency brake assist – When emergency braking is detected the vehicle automatically applies the maximum possible braking assistance.
- Electronic brakeforce distribution – Automatically apportions the optimum braking force to each wheel. • Adaptive brake lights – Automatically warns other road users of heavy braking. • Hill start assist – Briefly maintains rear brake pressure to stop the vehicle rolling back on an incline. • Hazard warning lights



Tyre pressure









- Tyre pressure monitoring system

ZAFIRA TOURER FEATURES/OPTIONS

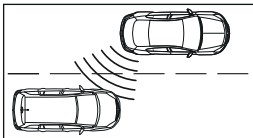
	Design	Energy	SRI	SE	Tech Line Nav	Elite	Price (£) exc. VAT	Total (£) inc. VAT
DRIVER ASSISTANCE Steering • Speed sensitive electrically assisted power steering • Reach and rake adjustable steering	●	●	●	●	●	●		
Cruise control with speed limiter: <i>The cruise control feature enables you to maintain a constant speed – making it ideal for economical motorway driving. The speed limiter function can be set to ensure that you do not exceed the speed limit and can be easily overridden if required.</i> • Steering wheel mounted controls	●	●	●	●	●	●		
Electric parking brake • Centre console switch in lieu of handbrake lever • Premium centre console featuring adjustable armrest				●	●	●		
Front camera system <i>A wide range of class-leading driver assistance and safety features are controlled by the front camera system.</i> Traffic sign recognition: <i>Detects and then displays speed limits, reducing uncertainty and the risk of speeding.</i> • Recognises different road signs, including temporary speed restrictions • Displays reminder in the driver information centre   Always know the speed limit								
Following distance indicator: <i>Indicates how many seconds you are behind the vehicle in front – helping you maintain a safe distance.</i> • Timings are shown in the driver information centre   Keeps a safe distance				○	○	○	670.83	805.00
Lane departure warning with lane assist: <i>If the driver has not actively steered or signalled, the lane departure warning system warns when the car moves outside of lane markings at speeds above 37mph. The lane keep assist function additionally provides gentle steering correction to help drivers keep in their lane if no active inputs are made.</i> • Warning light in instrument cluster • Audible warning • Steering wheel 'nudge' warning • Facia on/off switch • Both systems switch to standby when in road works or when road markings are confused   Keeps you in lane								

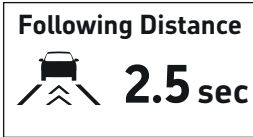
● = Standard equipment. ○ = Optional at extra cost.

ZAFIRA TOURER FEATURES/OPTIONS

DRIVER ASSISTANCE		Design	Energy	SRI	SE	Tech Line Nav	Elite	Price (£) exc. VAT	Total (£) inc. VAT
Driver Assistance Pack A wide range of class-leading driver assistance and safety features are controlled by the front camera system.									
Forward collision alert with automatic city emergency braking: In certain circumstances and at speeds above 5mph warns when approaching another vehicle too quickly. At speeds above 5mph and up to 53mph the system provides additional braking support to help the driver brake more quickly and effectively in an emergency situation. At speeds above 5mph and up to 37mph if no avoiding action is taken by the driver, the system automatically slows the vehicle with emergency braking.									
<ul style="list-style-type: none"> • Visual warnings – projected onto windscreen and shown in the instrument cluster • Audible warning • Additional braking support • Low speed collision mitigation braking 									
Automatic cruise control: Automatic cruise control decelerates the vehicle when approaching a slower moving vehicle. It then adjusts the vehicles speed to follow the vehicle at the selected following distance. The vehicle speed increases or decreases to follow the vehicle in front, but will not exceed the set speed.									
 Helps maintain constant speed									
Side blind spot alert: Side blind spot alert helps prevent potential collisions with other vehicles 'hidden' in the vehicle's side blind spots. If a vehicle enters one of the blind spots a warning light illuminates in the relevant door mirror.									
<ul style="list-style-type: none"> • Ultrasonic side sensors with three-metre range • LED warning light in door mirrors • Audible warning is sounded if the indicators are used and the system has detected another vehicle • Electrically folding door mirrors 									
 Warns of vehicles in your blind spot									
Following distance indicator: Indicates how many seconds you are behind the vehicle in front – helping you maintain a safe distance.									
<ul style="list-style-type: none"> • Timings are shown in the driver information centre 									
 Keeps a safe distance									
Front and rear parking distance sensors <ul style="list-style-type: none"> • Front and rear parking distance sensors • Audible warning 		●	●	●	●	●	●		
Rear-view camera The rear-view camera gives a clear view of the area behind your car and helps place the car perfectly, without needing to strain your neck.									
<ul style="list-style-type: none"> • Activated when reverse gear selected • Camera view appears in infotainment screen • Rear bumper and one-metre grid lines shown as reference points 									
 See what's behind you on the central screen									
FlexRide adaptive chassis control system with continuous damping control									
								675.00	810.00

● = Standard equipment. ○ = Optional at extra cost.

ZAFIRA TOURER FEATURES/OPTIONS

	Design	Energy	SRI	SE	Tech Line Nav	Elite	Price (£) exc. VAT	Total (£) inc. VAT
SECURITY								
Standard security features • 'Key left in ignition' audible warning • Electronically protected audio equipment • Engine deadlock immobiliser • Visible Vehicle Identification Number (VIN) • Locking wheel bolts for alloy wheels • Freewheeling door locks	●	●	●	●	●	●		
Remote control central locking • Operates on doors, tailgate and fuel filler flap • Deadlocking • Central locking activation switch on facia • One folding key/one static key each with integral remote control function	●	●	●	●	●	●		
Remote control ultrasonic security alarm system • Remote control (operates in conjunction with central locking) • Ultrasonic interior sensors • Tilt sensor • Thatcham approved	○	○	●	●	●	●	241.67	290.00

DRIVER INFORMATION

Instrumentation • Speedometer • Rev counter • Fuel gauge with low fuel level warning light • Water temperature gauge with warning light • Shift-up/down indication light – <i>Indicates when to change gear for optimum fuel economy.</i>	●	●	●	●	●	●		
Driver information display (centrally located in instrument cluster) • Monochrome display • Displays trip computer data • Total mileage • Service-due indicator • Oil life • Tyre pressure monitoring system	●	●	●	●	●	●		
Multi-function trip computer (displayed on driver information display) • Trip mileage • Vehicle range based on remaining fuel • Average speed • Average fuel economy • Instantaneous fuel economy • Driving time	●	●	●	●	●	●		
Central facia display (format dependent on infotainment unit) • Audio information • Digital clock with automatic RDS time adjustment • Outside air temperature with ice warning function • Additional features dependent on infotainment unit (see infotainment for details)	●	●	●	●	●	●		

● = Standard equipment. ○ = Optional at extra cost.

ZAFIRA TOURER FEATURES/OPTIONS

INTERIOR STYLING	Design	Energy	SRi	SE	Tech Line Nav	Elite	Price (£) exc. VAT	Total (£) inc. VAT
Design / Energy interior décor Steering wheel: • Three-spoke design • Satin chrome-effect bezel Facia and door trim: • Black facia with Silver trim inserts • Black door panels with black Atlantis cloth inserts • Blasted Silver trim inserts on front doors • Chrome-effect interior door handles Seat trim: • Jet Black Mando fabric seat trim inserts • Dark Pewter stitching • Plain black fabric side bolsters and surrounds	●	●						
SE / Tech Line Nav interior décor (Not available with Lava Red, Royal Blue and Darkmoon Blue exterior colours) Steering wheel: • Three-spoke design • Leather-covered with accent stitching • Satin chrome-effect bezel Facia and door trim: • Black facia with Ruthenium trim inserts • Plain black door panels with black Siena cloth inserts • Ruthenium trim inserts on front doors • Chrome-effect interior door handles Seat trim: • Jet Black Lilop fabric seat trim inserts • Two-tone stitching in Shadow Grey and Rust • Plain black Morrocana-trimmed side bolsters				●	●			
SE / Tech Line Nav interior décor (Standard with Darkmoon Blue exterior colour and only optional in conjunction with Mineral Black or Emerald Green exterior colours) Steering wheel: • Three-spoke design • Leather-covered with accent stitching • Satin chrome-effect bezel Facia and door trim: • Black facia with Ruthenium trim inserts • Light neutral door panels with black Siena cloth inserts • Ruthenium trim inserts on front doors • Chrome-effect interior door handles Seat trim: • Light Neutral Lilop fabric seat trim inserts • Two-tone stitching in Shadow Grey and Ceramic White • Light neutral Morrocana-trimmed side bolsters				N/C	N/C		No-cost option	
SRi interior décor Steering wheel: • Three-spoke design • Leather-covered with accent stitching • Satin chrome-effect bezel Facia and door trim: • Black facia with Silver trim inserts • Silver air vent surrounds • Black door panels with black Atlantis cloth inserts • Blasted Silver trim inserts on front doors • Chrome-effect interior door handles Seat trim: • Jet Black Lace fabric seat trim inserts • Star Silver stitching • Plain black fabric side bolsters and surrounds			●					
Elite interior décor Steering wheel: • Three-spoke design • Leather-covered with accent stitching • Satin chrome-effect bezel Facia and door trim: • Black facia with Ruthenium trim inserts • Silver air vent surrounds • Black door panels with black Leather-effect inserts • Ruthenium trim inserts on front doors • Chrome-effect interior door handles Seat trim: • Black Siena leather seat trim inserts • Star Silver stitching • Black leather-effect side bolsters and surrounds						●		

● = Standard equipment. N/C = No-cost option.

ZAFIRA TOURER FEATURES/OPTIONS

	Design	Energy	SRI	SE	Tech Line Nav	Elite	Price (£) exc. VAT	Total (£) inc. VAT
SEATING AND COMFORT								
Flex7 [®] seating system	●	●	●	●	●	●		
Comfort front seats								
Driver's seat (eight-way adjustable): • Height (up/down) • Reach (fore/aft) • Backrest recline (upright/incline) • Head restraint (up/down)	●	●		●	●			
Front passenger's seat (six-way adjustable): • Reach (fore/aft) • Backrest (upright/recline) • Head restraint (up/down)								
Sports-style front seats								
Driver's seat (10-way adjustable): • Height (up/down) • Reach (fore/aft) • Backrest recline (upright/incline) • Head restraint (up/down) • Seat cushion extension (fore/aft)			●					
Front passenger's seat (eight-way adjustable): • Reach (fore/aft) • Backrest (upright/recline) • Head restraint (up/down) • Seat cushion extension (fore/aft)								
Ergonomic driver's sport style seat (AGR-approved*) with sports-style front passenger seat (on SE and Tech Line Nav models standard trim changes to Lace Cloth. Not available with Darkmoon Blue exterior colour)								
Driver's seat (18-way adjustable): • Height (up/down) • Reach (fore/aft) • Tilt (fore/aft) • Backrest (upright/recline) • Seat cushion extension (fore/aft) • Lumbar adjustment (four-way electrical) • Head restraint (fore/aft/up/down)			□	○	○		400.00	480.00
Front passenger's seat (six-way adjustable): • Reach (fore/aft) • Backrest (upright/recline) • Head restraint (up/down)								
Ergonomic driver's and front passenger's seat pack (standard with optional Light Neutral seat trim)								
Drivers and front passenger's seats (18-way adjustable): • Height (up/down) • Reach (fore/aft) • Tilt (fore/aft) • Backrest (upright/recline) • Seat cushion extension (fore/aft) • Lumbar adjustment (four-way electrical) • Active head restraint (fore/aft/up/down)				●	●			
Leather Pack (Ergonomic driver's sport style seat (AGR-approved*) with sports-style front passenger seat)								
Leather seat facings (front and second row seats) with Morrocana trimmed side bolsters • Heated front seats								
Driver's seat (16-way adjustable): • Height (up/down) • Reach (fore/aft) • Tilt (fore/aft) • Backrest (upright/recline) • Seat cushion extension (fore/aft) • Lumbar adjustment (four-way electrical) • Head restraint (up/down)			○			●	962.50	1155.00
Front passenger's seat (eight-way adjustable): • Reach (fore/aft) • Backrest (upright/recline) • Head restraint (up/down) • Seat cushion extension (fore/aft)								
Seat Comfort Pack One								
Driver's seat with four-way electrical lumbar adjustment and manual cushion extension	○	○	●	○	○	●	150.00	180.00
Seat Comfort Pack Two (on SE models the front passenger's underseat storage facility is deleted)								
Driver's and front passenger's seat with four-way electrical lumbar adjustment and manual cushion extension	○	○		○	○		275.00	330.00
Rear seating								
Height-adjustable and removable head restraints (second and third row seats) • 35/30/35 split-folding second-row seats • Second-row seats with sliding function plus fold-flat facility • Two individual fold flat third-row seats (height restrictions apply – When all seats are occupied within the Zafira Tourer passenger side third-row seat is only usable by a passenger up to a maximum height of 150cm.) • Storage pockets on front seat backs • Child-proof locks on rear doors • ISOFIX child seat mountings incorporating top tether anchor points located on outer rear seats (does not include child seat) – Allows ISOFIX child safety seats to be securely fixed into the car. The ISOFIX mounting system reduces forward movement in an accident and makes the child seat easier to install.	●	●	●	●	●	●		
Front passenger's underseat storage facility				●	●	●		
Lounge seating – Three individual second-row seats with the ability to convert into two 'captain' seats with individual centre armrest.				●	●	●		

● = Standard equipment. ○ = Optional at extra cost. □ = Available as part of an extra-cost option pack. * AGR (The Campaign for Healthier Backs) is an independent centre of excellence for ergonomics, based in Germany.







ZAFIRA TOURER FEATURES/OPTIONS

INFOTAINMENT	Design	Energy	SRi	SE	Tech Line Nav	Elite	Price (£) exc. VAT	Total (£) inc. VAT
R4.0 IntelliLink touchscreen infotainment system <i>For use with media players, USB memory sticks, mobile phones and smartphone apps.</i> Onboard features: <ul style="list-style-type: none"> • 7-inch colour touchscreen • DAB digital radio/AM/FM stereo radio with 36 station presets • RDS with Traffic Programme Media connections: <ul style="list-style-type: none"> • USB connection with iPod control • Bluetooth® A2DP audio streaming (Advanced Audio Distribution Profile) Mobile phone portal: <ul style="list-style-type: none"> • Bluetooth® connectivity • Handsfree calls via steering wheel controls • Vehicle microphone • Phone book access – Contacts/last calls/missed calls etc. are mirrored on IntelliLink's display and are easily navigated using the touchscreen (features dependent on mobile phone). Smartphone interface: <ul style="list-style-type: none"> • Apple CarPlay™ • Android Auto™ – Smartphone projection that allows operations via voice command, touchscreen and buttons to control apps and music playback. 	●		●	●		●		
Navi 4.0 IntelliLink touchscreen navigation and infotainment system <i>For use with media players, USB memory sticks, mobile phones and smartphone apps.</i> Onboard features: <ul style="list-style-type: none"> • 7-inch colour touchscreen • DAB digital radio/AM/FM stereo radio with 36 station presets • RDS with Traffic Programme Navigation features: <ul style="list-style-type: none"> • Satellite navigation system • 2D street level mapping • European coverage • Structured or one-box destination entry • Points-of-interest search • Eco routing • Map updates via USB Media connections: <ul style="list-style-type: none"> • USB connection with iPod control • Bluetooth® A2DP audio streaming (Advanced Audio Distribution Profile) Mobile phone portal: <ul style="list-style-type: none"> • Bluetooth® connectivity • Handsfree calls via steering wheel controls • Vehicle microphone • Phone book access – The majority of the phone's functions – contacts/last calls/missed calls etc. – are mirrored on IntelliLink's display and are easily navigated using the touchscreen (features dependent on mobile phone). Smartphone interface: <ul style="list-style-type: none"> • Apple CarPlay™ • Android Auto™ – Smartphone projection that allows operations via voice command, touchscreen and buttons to control apps and music playback. Gallery – only available when vehicle is stationary: <ul style="list-style-type: none"> • Photo gallery with slide show feature • Video playback with soundtrack played through car speakers 	○	●	▲	○	●	▲	591.67	710.00
Six speakers (four front, two rear)	●	●	●	●	●	●		
Steering wheel mounted audio controls	●	●	●	●	●	●		

● = Standard equipment. ○ = Optional at extra cost. ▲ = Standard on Nav models, see pricing pages for details.

ZAFIRA TOURER FEATURES/OPTIONS

INFOTAINMENT

						Design	Energy	SRI	SE	Tech Line Nav	Elite	Price (£) exc. VAT	Total (£) inc. VAT
													
Automatic Crash Response	Wi-Fi Hotspot	Smartphone App	Stolen Vehicle Assistance	Vehicle Diagnostics	Destination Download								
<p>Vauxhall OnStar – your personal on board assistant</p> <p><i>Many car brands talk about innovation as soon as they improve their cup holders but this innovative system, now available on selected models**, is revolutionary: 24/7, 365 days a year, Vauxhall OnStar puts you in touch with a trained advisor, not a machine. With OnStar you have access to a host of innovations, from Vehicle Diagnostics and Smartphone Function to a fully integrated 4G Wi-Fi Hotspot†. In the event of an accident, Vauxhall OnStar even automatically calls for help, for an incomparable feeling of safety.</i></p> <p>* = Includes 12 months of OnStar services from date of first registration and a 3 month/3 GB Wi-Fi free trial period (whichever comes first) effective from the date the customer accepts the nominated network operator Wi-Fi Ts&Cs. Destination download feature only operates on models fitted with Navi 4.0 IntelliLink satellite navigation system. Theft alert feature only operates on models fitted with security alarm system.</p> <p>** = The OnStar Services require activation and are subject to mobile network coverage and availability. Wi-Fi Hotspot service requires account with nominated network operator.</p> <p>† = 4G is subject to mobile network coverage and availability. Charges apply after the free trial period. The OnStar subscription packages could be different from the services included in the free trial package. Check www.vauxhall.co.uk/onstar for terms and conditions, details of availability, coverage and charges.</p>													
						●	●	●	●	●	●		
													

● = Standard equipment.

ZAFIRA TOURER FEATURES/OPTIONS

	Design	Energy	SRI	SE	Tech Line Nav	Elite	Price (£) exc. VAT	Total (£) inc. VAT
HEATING AND VENTILATION								
Air conditioning • Air recirculation facility • Cabin particulate filter – Removes dust, airborne particles and pollen. • Multi-speed fan • Illuminated controls	●	●	●					
Electronic climate control including air conditioning • Dual-zone control – Allowing different, temperature settings for driver and front passenger. • Advanced predictive logic control system using sun and humidity sensors • Partial air recirculation – Faster warm up/cool down. • Cabin particulate filter – Removes dust, airborne particles and pollen. • Automatic air direction and fan speed with manual override • LCD temperature display • Illuminated controls • Rear floor heating ducts ✓ Set and forget temperature control ✓ Set different temperatures for driver and front passenger			○	●	●	●	337.50	405.00
Additional features • Four adjustable facia vents • Windscreen demist vents • Side window demist vents • Heated rear screen with timed cut-off	●	●	●	●	●	●		
Heated leather-covered steering wheel			□	□	□	○	95.83	115.00
Winter Pack – only available with standard seat trim on SRI models • Heated leather-covered steering wheel • Heated front seats (standard on Elite/Elite Nav models) ✓ Warm welcome			○	○	○		304.17	365.00

● = Standard equipment. ○ = Optional at extra cost. □ = Available as part of an extra-cost option pack.

ZAFIRA TOURER FEATURES/OPTIONS

	Design	Energy	SRI	SE	Tech Line Nav	Elite	Price (£) exc. VAT	Total (£) inc. VAT
INTERIOR CONVENIENCE / LIGHTING								
Convenience features • 12-volt electrical accessory socket within front and rear centre console • Driver's and front passenger's sunvisors incorporating illuminated vanity mirrors with covers • Dipping rear-view mirror	●	●	●	●	●	●		
12-volt electrical accessory socket within luggage compartment	□	□	□	□	□	□		
Automatically dimming anti-dazzle rear-view mirror			□	●	●	●		
Central storage facility with two cupholders and front centre armrest	●	●	●					
FlexRail® centre console system featuring aluminium rails, sliding tray/cup holder and front centre armrest				●	●	●		
Rear side window sunblinds	○	○	○	○	○	○	91.67	110.00
Standard lighting • Central front courtesy light • Central rear courtesy light • Fade up/fade down	●	●	●	●	●	●		
Premium lighting • First and second row reading lights with illuminated switches • Third row passenger compartment reading lights • Ambient LED fascia/centre console downlighter • Driver's and front passenger's vanity mirrors with covers • Illuminated glove box and luggage area • Ambient LED lighting in fascia and front doors	●	●	●	●	●	●		
Interior storage • Storage box on driver's side lower fascia • Glovebox with lid • Front door pockets • Third row central storage facility with two cup holders • Rear door pockets • Storage pockets on front seat backs	●	●	●	●	●	●		
Loading Pack • Vertical load restraining net • FlexCover interior protection liner • 12-volt electrical accessory socket within luggage compartment	○	○	○	○	○	○	125.00	150.00
Luggage area • Luggage compartment cover • Illuminated load area • Fully carpeted load area • Interior tailgate handle • Four load restraint lashing eyes • Twin gas-assisted tailgate struts	●	●	●	●	●	●		
FlexOrganiser® Pack • FlexOrganiser® rails • Restraint net with two bars • Small luggage restraint net • Adaptors	○	○	○	○	○	○	133.33	160.00

● = Standard equipment. ○ = Optional at extra cost. □ = Available as part of an extra-cost option pack.

ZAFIRA TOURER FEATURES/OPTIONS

	Design	Energy	SRI	SE	Tech Line Nav	Elite	Price (£) exc. VAT	Total (£) inc. VAT
EXTERIOR LIGHTING								
Standard lighting features								
• LED daytime running lights • Ellipsoid headlights • Side repeat indicators	●	●	●	●	●	●		
• Lights-on audible warning • Electric headlight beam levelling • High-level LED centre rear brake light • Rear fog light								
• Reversing light • Hazard warning lights • Door-to-door illumination • Dark-style tail lights								
• Automatic lighting control with tunnel detection and digital high beam assist			□	●	●	●		
Dark-style headlights			●					
Chrome-effect headlights	●	●		●	●	●		
Premium Forward Lighting Pack				○	○	○	916.67	1100.00
• Intelligent Adaptive Forward Lighting (AFL) • LED headlights with dynamic beam levelling • LED tail lights								
Sight and Light Pack								
• Automatic lighting control with tunnel detection • Rain-sensitive windscreen wipers			○	●	●	●	200.00	240.00
• Electro-chromatic anti-dazzle rear-view mirror • Digital high beam assist								
Front fog lights		●	●	●	●	●		
LED tail lights				□	□	□		









● = Standard equipment. ○ = Optional at extra cost. □ = Available as part of an extra-cost option pack.

ZAFIRA TOURER FEATURES/OPTIONS

	Design	Energy	SRI	SE	Tech Line Nav	Elite	Price (£) exc. VAT	Total (£) inc. VAT
EXTERIOR CONVENIENCE / STYLING								
Windscreen wipers • Two-speed windscreen wipers with variable intermittent wipe • Intermittent rear window wash/wipe	●	●	●	●	●	●		
• Rain-sensitive windscreen wipers			□	●	●	●		
Door mirrors • Twin electrically adjustable/heated door mirrors • Manually folding door mirrors	●	●	●	●	●	●		
• Electrically foldable door mirrors	□	□	□	□	□	□		
Windows • Electrically operated front and rear windows with safety autoreverse and one-touch facility • Heated rear window	●	●	●	●	●	●		
• Solar heat-absorbing windscreen • Tinted windows	●	●	●	●	●	●		
• Dark-tinted rear windows		●	●	●	●	●		
Electro Pack • Electrically foldable door mirrors • 12-volt electrical accessory socket within luggage compartment	○	○	○	○	○	○	141.67	170.00
Panoramic windscreen and panoramic sunroof (requires optional electronic climate control, deletes silver-effect roof rails) • Electrically operated interior sunblind			○	○	○	●	633.33	760.00
Roof rails • Black	●							
• Silver-effect		●	●	●	●			
Flex-Fix® integrated carrier system (includes two-bicycle carrier attachments) <i>Not available in conjunction with emergency spare wheel, Towing Pack and VXR Styling Pack. Please note, bicycle size restrictions apply, please contact your local Retailer for further information.</i>			○	○	○	○	758.33	910.00
Towing Pack • Detachable tow bar • Trailer stability programme integrated into ESP system	○	○	○	○	○	○	625.00	750.00
Body styling • Chrome-effect front grille bar • Chrome-effect headlight detail • Body-colour door handles • Body-colour door mirrors	●	●	●	●	●	●		
• Black trim on door pillars								
• Body-colour rear roof spoiler			●					
• Chrome-effect lower window surround		●		●	●	●		
• Visible stainless steel exhaust tailpipe (2.0CDTi (170PS) engines only) – Deleted if optional Flex-Fix® integrated carrier system is specified.	●	●	●	●	●	●		
VXR Styling Pack (Not available in conjunction with optional Flex-Fix® integrated carrier system or Royal Blue exterior colour) • Body-colour front lower spoiler, side sills, rear lower skirt and rear roof spoiler	○	○	○	○	○	○	958.33	1150.00

● = Standard equipment. ○ = Optional at extra cost. □ = Available as part of an extra-cost option pack.





ZAFIRA TOURER FEATURES/OPTIONS

EXTERIOR COLOURS		Design	Energy	SRI	SE	Tech Line Nav	Elite	Price (£) exc. VAT	Total (£) inc. VAT
	Royal Blue • Solid paint • Folding key with Grey insert	●	●	●			●		
	Summit White • Brilliant paint • Folding key with White insert • Not available with Lilop Light Neutral cloth seat trim	○	○	○	○	○	○	237.50	285.00
	Lava Red • Brilliant paint • Folding key with Red insert	○	○	○			○	237.50	285.00
	Sovereign Silver • Two-coat metallic paint • Folding key with Grey insert • Not available with Lilop Light Neutral cloth seat trim								
	Mineral Black • Two-coat metallic paint • Folding key with Black insert								
	Cosmic Grey • Two-coat metallic paint • Folding key with Grey insert • Not available with Lilop Light Neutral cloth seat trim								
	Satin Steel Grey • Two-coat metallic paint • Folding key with Red insert • Not available with Lilop Light Neutral cloth seat trim								
	Flip Chip Silver • Two-coat metallic paint • Folding key with White insert • Not available with Lilop Light Neutral cloth seat trim	○	○	○	○	○	○	470.83	565.00

● = Standard equipment. ○ = Optional at extra cost.

The colours reproduced may vary slightly from the actual paint colour. As a result they should be used as a guide only. Your Vauxhall Retailer has a comprehensive display of our paint samples.





ZAFIRA TOURER FEATURES/OPTIONS

EXTERIOR COLOURS		Design	Energy	SRI	SE	Tech Line Nav	Elite	Price (£) exc. VAT	Total (£) inc. VAT			
	<p>Dark Caramel</p> <ul style="list-style-type: none"> • Two-coat premium paint • Folding key with Black insert • Not available with Lilop Light <p>Neutral cloth seat trim</p>	<input type="radio"/>	<input type="radio"/>	<input type="radio"/>	<input checked="" type="radio"/>	<input checked="" type="radio"/>	<input type="radio"/>	545.83	655.00			
	<p>Rioja Red</p> <ul style="list-style-type: none"> • Two-coat premium paint • Folding key with Black insert • Not available with Lilop Light <p>Neutral cloth seat trim</p>		Emerald Green	<ul style="list-style-type: none"> • Two-coat premium paint • Folding key with Black insert 	<input type="radio"/>	<input type="radio"/>	<input type="radio"/>	<input type="radio"/>	<input type="radio"/>	<input type="radio"/>	545.83	655.00
	<p>Darkmoon Blue</p> <ul style="list-style-type: none"> • Two-coat premium paint • Folding key with Black insert • Only available with Lilop Light <p>Neutral cloth seat trim on SE and Tech Line Nav models</p>											
	<p>Abalone White</p> <ul style="list-style-type: none"> • Tri-coat premium paint • Folding key with white insert • Not available with Lilop Light <p>Neutral cloth seat trim</p>	<input type="radio"/>	<input type="radio"/>	<input type="radio"/>	<input type="radio"/>	<input type="radio"/>	<input type="radio"/>	604.17	725.00			

● = Standard equipment. ○ = Optional at extra cost.

The colours reproduced may vary slightly from the actual paint colour. As a result they should be used as a guide only. Your Vauxhall Retailer has a comprehensive display of our paint samples.



ZAFIRA TOURER FEATURES/OPTIONS

WHEELS AND TYRES		<i>Design</i>	<i>Energy</i>	<i>SRI</i>	<i>SE</i>	<i>Tech Line Nav</i>	<i>Elite</i>	Price (£) exc. VAT	Total (£) inc. VAT
Emergency spare wheel (in lieu of emergency tyre inflation kit)		○	○	○	○	○	○	91.67	110.00
	17-inch multi-spoke alloy wheels • 225/50 R 17 tyres • Emergency tyre inflation kit (in lieu of spare wheel)	●	●		●	●			
	17-inch multi-spoke alloy wheels (1.6CDTi (134PS) S/S ecoTEC only) • 225/50 R 17 tyres • Emergency tyre inflation kit (in lieu of spare wheel)			●					
	18-inch 5-twin-spoke alloy wheels (1.4i Turbo/2.0CDTi) • 235/45 R 18 tyres • Emergency tyre inflation kit (in lieu of spare wheel)			●					
	18-inch 5-twin-spoke alloy wheels (1.6CDTi (134PS) S/S ecoTEC only) • 235/45 R 18 tyres • Emergency tyre inflation kit (in lieu of spare wheel)			○				91.67	110.00
	18-inch 10-spoke alloy wheels • 235/45 R 18 tyres • Emergency tyre inflation kit (in lieu of spare wheel)				○	○	●	416.67	500.00

● = Standard equipment. ○ = Optional at extra cost.



ZAFIRA TOURER FEATURES/OPTIONS

WHEELS AND TYRES

		Design	Energy	SRi	SE	Tech Line Nav	Elite	Price (£) exc. VAT	Total (£) inc. VAT
	19-inch 5-spoke bi-colour alloy wheels • 235/40 R 19 tyres • Emergency tyre inflation kit (in lieu of spare wheel)			○			○	458.33	550.00
	19-inch multi-spoke alloy wheels • 235/40 R 19 tyres • Emergency tyre inflation kit (in lieu of spare wheel)				○	○		666.67	800.00

○ = Optional at extra cost.

TYRE RATING

Tyre size	Fuel efficiency group	Wet grip performance	External noise	
			Measured (dB)	Group
225/50 R 17	B-E	B-C	68-71	
235/45 R 18	E	B	71	
235/40 R 19	E	B	71	

Tyre rating according to EU Regulation 1222/2009

ZAFIRA TOURER SPECIFICATIONS

PETROL ENGINE

1.4i Turbo (140PS)	
Capacity	1364cc
Maximum power	140PS (103kW) @ 4900-6000rpm
Maximum torque	200Nm (147 lb.ft.) @ 1850-4900rpm
Configuration	4 cylinders, 4 valves per cylinder, double overhead camshafts
Fuel/induction system	Water-cooled turbocharger with intercooler. Variable Valve Timing (VVT). Multi-point sequential fuel injection
Emission compliance	Euro 6
Service interval	20,000 miles or 1 year (whichever occurs sooner)

DIESEL ENGINES

	1.6CDTi (134PS) ecoTEC with Start/Stop	2.0CDTi (170PS) with Start/Stop*
Capacity	1598cc	1956cc
Maximum power	134PS (99kW) @ 3500-4000rpm	170PS (125kW) @ 3750rpm
Maximum torque	320Nm (236 lb.ft.) @ 2000rpm	400Nm (295 lb.ft.) @ 1750-2500rpm
Configuration	4 cylinders, 4 valves per cylinder, double overhead camshafts	4 cylinders, 4 valves per cylinder, double overhead camshafts
Fuel/induction system	Variable geometry turbocharger with intercooler. Common rail fuel injection	Turbocharger with intercooler. Common rail fuel injection
Emission compliance	Euro 6	Euro 6
Service interval	20,000 miles or 1 year (whichever occurs sooner)	20,000 miles or 1 year (whichever occurs sooner)

* = Start/Stop on manual models only.

ZAFIRA TOURER SPECIFICATIONS

PERFORMANCE, FUEL ECONOMY AND EMISSIONS

	Wheel size (inches)	Performance (manufacturer's figures)		Fuel economy mpg (litres/100km) [#]			CO ₂ emissions g/km [#]	Vehicle Excise Duty* First year rate	Standard rate	Benefit in kind company car taxation rates – 2017/18 tax year
		Maximum speed (mph)	Acceleration 0-60mph (sec)	Urban driving	Extra-urban driving	Combined figure				
Manual										
1.4i Turbo (140PS)	17/18/19	124	9.9	33.2 (8.5)	49.6 (5.7)	44.1 (6.8)	156	£500	£140	30%
1.6CDTi (134PS) Start/Stop ecoTEC	17	120	10.4	53.3 (5.3)	70.6 (4.0)	62.8 (4.5)	119	£160	£140	25%
1.6CDTi (134PS) Start/Stop	18/19	120	10.4	50.4 (5.6)	67.3 (4.2)	60.1 (4.7)	125	£160	£140	27%
2.0CDTi (170PS) Start/Stop	17	129	9.1	47.1 (6.0)	67.3 (4.2)	57.7 (4.9)	129	£160	£140	27%
2.0CDTi (170PS) Start/Stop	18/19	129	9.1	44.1 (6.4)	62.8 (4.5)	54.3 (5.2)	137	£200	£140	29%
Automatic										
1.4i Turbo (140PS)	17/18/19	122	10.2	30.4 (9.3)	50.4 (5.6)	40.9 (6.9)	160	£500	£140	31%
2.0CDTi (170PS)	17/18/19	127	9.3	34.4 (8.2)	58.9 (4.8)	46.3 (6.1)	161	£500	£140	34%

* = Correct at time of publication.

= Fuel consumption information is official government environmental data, tested in accordance with the relevant EU directive. Official EU-regulated test data is provided for comparison purposes and actual performance will depend on driving style, road conditions and other non-technical factors.

OPTIONAL TRANSMISSION

Six-speed automatic transmission with ActiveSelect® function

A six-speed automatic transmission is optional on 1.4i Turbo (140PS) and 2.0CDTi (170PS) models. On the road, a wide selection of shift patterns is adapted to the style and habits of the driver, anticipating when maximum acceleration or maximum efficiency is required. The electronic control will also adapt to the prevailing road conditions, reducing gear shifting when climbing or descending and using engine braking assistance during down changes.

The ActiveSelect® manual mode allows the gear lever to be used like a sequential manual gearbox – you simply push the lever forward or back to change up or down the gears. The driver also benefits from a 'neutral' gear disengagement at idle, which reduces vibration and contributes to improved fuel consumption.

STEERING

- Power-assisted steering
- Turning circle (kerb-to-kerb):
– 11.40m (37.4ft.)

SUSPENSION

Front: Independent. Lightweight MacPherson struts with gas-pressure dampers and coil springs. Anti-roll bar.

Rear: Lightweight compound crank rear axle with one-piece, hollow cast trailing arms. Built-in anti-roll bar. Progressive-rate double conical mini-block springs with gas-pressure dampers.

BRAKES

- Anti-lock Braking System (ABS)
- Electronic brakeforce distribution
- Hydraulic brake fade assist
- Cornering brake control
- Emergency brake assist
- Hill start assist
- Electric parking brake (standard on SE, Tech Line Nav and Elite models only)

BODY

Aerodynamic drag co-efficient:
– Cd 0.32.

FUEL TANK CAPACITY

58 litres (12.8 gallons)

ADBLUE TANK CAPACITY

7.8 litres (1.7 gallons)

ZAFIRA TOURER SPECIFICATIONS

EXTERIOR DIMENSIONS millimetres (inches)

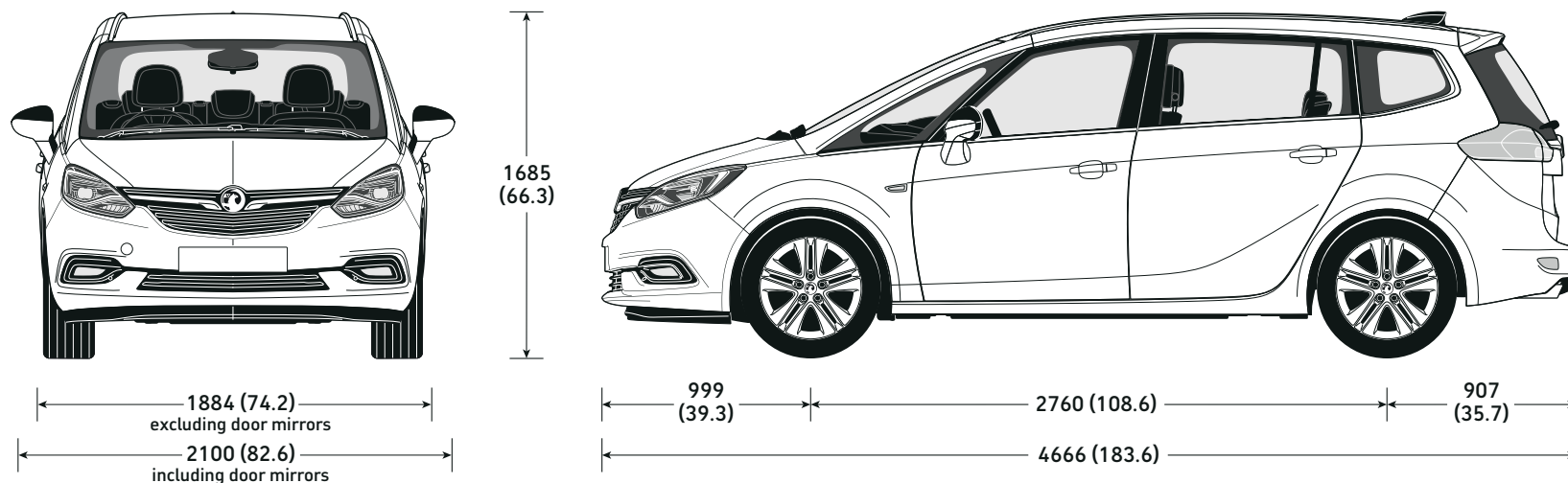

WEIGHTS AND TOWING DATA kg

	Gross vehicle weight	Max. towing weights Trailer with brakes (without brakes)
1.4i Turbo (140PS)	2310	1300 (750)
1.4i Turbo (140PS) automatic	2340	1550 (750)
1.6CDTi (134PS) Start/Stop ecoTEC	2380	1450 (750)
2.0CDTi (170PS) Start/Stop	2455	1650 (750)
2.0CDTi (170PS) automatic	2470	1650 (750)

Gross vehicle weight is the total permissible weight of the vehicle including passengers and their luggage. The maximum roof rack loading should not exceed 100kg. The maximum towing weights are based on the ability of the car, with two occupants of 75kg each, to restart on a 12% gradient, which is approximately 1 in 8.3, at sea level. The permitted trailer load applies up to the specified incline and up to an altitude of 1000 metres above sea level. The permissible gross train weight decreases by 10% for every 1000 metres of additional altitude. Any extra weight, such as luggage or additional passengers, should be deducted from the maximum towing weight. With a trailer fully loaded, maximum noseweight should not exceed 75kg. Always fit Vauxhall towing attachments and accessories available from your Vauxhall Retailer. They are designed specifically for Vauxhall models and carry a 12-month guarantee. During trailer towing do not exceed a maximum speed of 60mph. This speed limit is also applicable in countries with higher permitted speeds for trailer-vehicle combinations. Pay attention to the local speed limits. For trailers with low driving stability and caravans the use of an oscillation damper is strongly recommended.

LOADSPACE DIMENSIONS millimetres (inches)

Maximum floor length – behind front seats, second-row and third-row seats folded	1842 (72.5)
Maximum floor length – behind second-row seats	1093 (43.0)
Width between wheel arches	1057 (41.6)
Tailgate aperture height	840 (33.0)
Tailgate aperture lower width	1045 (41.1)

LOADSPACE CAPACITIES measured using the ECIE method

	litres (cu.ft.)
Behind third-row seats, to glass line	152 (5.4)
Behind second-row seats, to glass line	710 (25.1)
Behind front seats, to roof	1860 (65.6)

ZAFIRA TOURER ACCESSORIES

INFOTAINMENT Total (inc. VAT)

Sat Nav updates¹

Please consult your Retailer for latest map updates or visit www.vauxhall.co.uk/accessories.

1 = For use with optional factory-fit satellite navigation systems.

CHILD SEATS²

BABY-SAFE ³ – 0-13kg/birth to 15 months	£132.00
– ISOFIX base	£227.00
DUO ISOFIX ³ – 9-18kg/9 months to 4 years	
with top tether kit	£347.00
KID ³ –15-36kg or 4 to 12 years	£157.00

2 = Restrictions apply to the use of child seats, please consult your Vauxhall Retailer or request a copy of the Child seats brochure.

3 = Without transponder.

SAFETY

Safety Pack – first aid kit, warning triangle, hi-visibility vest, Vauxhall bag	£35.00
First aid kit	£15.00
Warning triangle	£17.00
Fire extinguisher – 2kg	£37.00
Hi-visibility vest	£9.00
Tyre sealant	£68.00
Tyre inflation compressor	£120.00
Tyre repair kit	£150.00

SECURITY

Locking wheel nuts – set of four	£39.00
----------------------------------	--------

FLEXCONNECT RANGE Total (inc. VAT)

FlexConnect bracket	£20.00
FlexConnect hook	£28.00
FlexConnect coat hanger	£58.00
FlexConnect folding table	£68.00
FlexConnect iPad Mini cradle	£98.00
FlexConnect iPad (1-4) cradle	£106.00
FlexConnect iPad Air cradle	£106.00
FlexConnect Samsung Galaxy cradle	£96.00

PRACTICAL

Spare bulb kit ⁴	£26.00
Premium spare bulb kit ⁴	£32.00
Privacy shades	
– side windows	£91.00
– rear window	£83.00
Stretch tow rope – up to 3000kg	£34.00
Towing bar – up to 2500kg	£85.00

4 = Excludes xenon headlight bulb for models with Adaptive Forward Lighting (AFL).

PROTECTION

Rubber floor mats	
– front and second row	£59.00
Velour floor mats – set of four	£69.00
Mudflaps	
– front	£56.00
– rear	£56.00
Alloy-effect sports pedals	from £113.00
Front door sill plates (single)	£28.00
Cargo net – horizontal	£21.00
Cargo liner	£47.00
Load compartment mat	from £163.00
Storage box	£27.00
Dog guard	£206.00
Load compartment divider rail	£95.00

TRANSPORT SYSTEMS Total (inc. VAT)

Roof base carrier (without roof rails)	£170.00
Roof base carrier (with roof rails)	£166.00
Roof carriers (requires base carrier)	
Bike roof carrier – Thule Freeride 532	£76.00
Surf board roof carrier – Thule 833	£101.00
Kayak roof carrier – Thule 837	£168.00
Ski roof carrier (400mm wide)	
– Thule Deluxe 726	£138.00
Ski roof carrier (600mm wide)	
– Thule 739	£235.00
Hard shell roof boxes (requires base carrier)	
Thule Ocean 80	
(320 litre / 1330 x 860 x 370mm)	£235.00
Thule Ocean 200	
(390 litre / 1750 x 820 x 450mm)	£316.00
Thule Dynamic M	
(320 litre / 2060 x 840 x 340mm)	from £625.00
Thule Dynamic L	
(430 litre / 2350 x 940 x 350mm)	£846.00
Thule Excellence	
(520 litre / 2180 x 940 x 400mm)	£898.00
Thule Motion 800	
(460 litre / 2050 x 840 x 450mm)	from £515.00
Thule Touring 200	
(400 litre / 1750 x 820 x 450mm)	£372.00
Thule Touring 780	
(430 litre / 2320 x 700 x 420mm)	£460.00
Soft roof boxes (requires base carrier)	
Thule Ranger 90	
(280 litre / 1100 x 800 x 400mm)	£285.00
Thule Ranger 500	
(300 litre / 1900 x 500 x 300mm)	£378.00
Tailgate carrier	
Bike tailgate carrier – Thule BacPac 973	£282.00
Fitting kit	£48.00

Tow bar carrier system Total (inc. VAT)

Fixed tow bar	
– 13-pin electrics	£638.00
Detachable tow bar	
– 13-pin electrics	£659.00

STYLING

VX-Line styling pack	• Front lower spoiler
• Rear lower skirt	• Rear roof spoiler
• Side sills	from £1908.00
VX-Line rear roof spoiler ⁵	£642.00

5 = Not suitable for SRi models. Requires additional aerial adaptor of extra cost. Please consult your Retailer for details.

ALLOY WHEELS (set of four with centre caps)⁶

17-inch 7-spoke	£617.00
18-inch 5-double spoke	£674.00
18-inch 5-spoke	£970.00
18-inch 10-spoke	£1016.00
19-inch 10-spoke	£1373.00

Other designs available

6 = Different tyres and locking wheel bolts/nuts may be required at extra cost. Price excludes new tyres and locking wheel bolts/nuts, includes static wheel balancing.

Please note:

Prices shown are a fully fitted and painted, where applicable and include VAT. Please check with your local Vauxhall Retailer for details. It is advisable to ensure your insurance policy is adequate to cover additional fitted accessories. Prices correct at time of publication.

ZAFIRA TOURER OFFERS IN DETAIL – TERMS AND CONDITIONS

Unless otherwise stated, all offers described are available on orders or registrations between 3 October 2017 – 18 December 2017. Offer prices quoted are correct at the time of publication (October 2017). Prices are subject to change. In line with Vauxhall's policy of price transparency, the offer price shown is an on-the-road price including VAT, number plates and delivery to Retailer of £700.00 (including £116.67 VAT), 12 months' Government Vehicle Excise Duty (variable depending upon model) and the DVLA's new vehicle first registration fee of £55.00. Excludes fuel and insurance. Offers may not apply to Retailer stocks and are subject to availability. Restrictions may apply. Contact your Retailer for details. Vauxhall Motors Limited reserves the right to change, amend or withdraw these offers at any point in time.

FLEXIBLE FINANCE

Available on selected models only, at participating Retailers. Conditional sale. Finance subject to status. Terms and Conditions apply. Applicants must be 18+. Finance supplied by Vauxhall Finance, CF15 7YT. Vauxhall Deposit Contributions vary and exclude certain models and are only available when vehicle is financed through Vauxhall Finance. 24-48 month term. Offer will apply to private individuals, Vauxhall Partners and small businesses 1- 24 units (purchase only, excluding B2B supported units). All other customers are excluded. Refer to www.vauxhall.co.uk/offers or contact your local Vauxhall Retailer for details.

FLEXIBLE PCP

Offer subject to availability at participating Retailers only. Personal Contract Purchase. Finance subject to status. Terms and Conditions apply. Applicants must be 18+. Finance by Vauxhall Finance, CF15 7YT. 24-48 month term available. Vauxhall deposit contribution only available when vehicle financed through Vauxhall Finance. At the end of the agreement there are three options: i) Pay the optional final payment to own the vehicle, ii) Return the vehicle, or iii) Replace: Part Exchange the vehicle, where equity is available. UK-supplied vehicles only. Offer applies to private individuals, Vauxhall Partners and small businesses 1-24 units (purchase only excluding B2B supported units). All other customers are excluded.

PERSONAL CONTRACT HIRE

Personal contract hire offer on vehicles ordered by 18 December 2017, subject to availability and status. Age 18+ only. Figures based on a non-maintenance contract hire package. Excess miles over contracted mileage of 24,000 over 36 months charged at a maximum of 14 pence per mile. Excess charges also apply if you breach manufacturer servicing or maintenance guidelines or if the car exceeds BVRLA Fair Wear & Tear guidelines for its age/mileage when it is returned to Vauxhall Leasing. Package includes Road Fund Licence and Vauxhall Assistance. Guarantee/indemnity may be required. Prices and details are subject to change without notice. For full specification and Ts&Cs contact your local Retailer. **You will not own the car.** ALD Automotive Ltd., trading as Vauxhall Leasing, BS16 7LB. Authorised and regulated by the Financial Conduct Authority.

Please note not all offers apply to all models.

ZAFIRA TOURER COMPANY CAR DRIVER/FLEET INFORMATION

DESIGN AND TECH LINE NAV HIGH SPEC, LOW P11D

Specifically developed for businesses and company car drivers alike, our Design and Tech Line Nav models are seriously fit for Fleet.

Design models all feature very low P11D values, generous standard specification with a choice of high tech ecoTEC engines for great fuel economy and low emissions including the 'whisper diesel' 1.6CDTi (from 88g/km and 85.6mpg combined).

For even more standard specification, step up to our Tech Line Nav range again you are guaranteed low P11D values, plus great standard kit including Sat Nav, Bluetooth®, USB connection and digital radio.

With Design and Tech Line Nav you can take for granted low Whole Life Costs and low company car driver taxation.



COMPANY CAR DRIVER FREE 3 DAY TEST DRIVE

Our free* 3 Day Test Drive programme is open to all Company Car Drivers which allows you to choose any model in the current Vauxhall line-up (excluding Cascada, all VXR models and Commercial Vehicles), with full insurance cover provided, to give you a meaningful length of time to make an informed decision about your next company car.

Click below to book your free* test drive
www.vauxhall3dtd.co.uk
 or call 0330 587 8221**

*The free 3 Day Test Drive programme is open to Company Car Drivers and Fleet Decision Makers. Available for UK Mainland only. Terms and conditions apply. Full terms and conditions can be found at vauxhallfleet.co.uk/testdrive/index/terms. **Telephone lines open Monday-Friday 9.00am to 5.00pm excluding Bank Holidays. Calls may be recorded or monitored for quality and/or training purposes.

BENEFIT IN KIND COMPANY CAR TAXATION†

The car benefit charge will be the car's list price (including VAT, options and accessories fitted, delivery to Retailer and number plates, but excluding Vehicle Excise Duty and new vehicle first registration fee) multiplied by the percentage charge for the CO₂ emissions band in which the car falls (see table opposite). Multiply this figure by your personal income tax rate (20% for Basic Rate, 40% for Higher Rate) to calculate your annual benefit in kind tax liability.

Example:

Zafira Tourer Design 1.6CDTi (134PS)	
Start/Stop ecoTEC 5-dr MPV (CO ₂ emissions 119g/km)	
On-the-road RRP	£22185.00
Deduct: Vehicle Excise Duty	(£160.00)
New vehicle first registration fee	(£55.00)
Effective list price	£21970.00
Add: Optional two-coat metallic paint	£565.00
List price for tax purposes (P11D value)	£22535.00
Car benefit charge	
2017-18 tax year (25%)	£5633.00
Benefit in kind tax liability (2017-18 tax year)	
Basic Rate (20%) tax payer	£1126.60
Higher Rate (40%) tax payer	£2253.20

† = Please note this Price Guide provides taxation information as a guide only. Vauxhall does not provide taxation guidance. Drivers should always take professional advice on their own tax position.

CO ₂ emissions in grams per kilometre	Percentage of car's price to be taxed	
	Petrol 2017-18 tax year	Diesel 2017-18 tax year
up to 50	9	12
51-75	13	16
76-94	17	20
95-99	18	21
100-104	19	22
105-109	20	23
110-114	21	24
115-119	22	25
120-124	23	26
125-129	24	27
130-134	25	28
135-139	26	29
140-144	27	30
145-149	28	31
150-154	29	32
155-159	30	33
160-164	31	34
165-169	32	35
170-174	33	36
175-179	34	37
180-184	35	37
185-189	36	37
190 and above	37	37

To calculate your own personal liability a car tax calculator is available at:
<https://www.vauxhallfleet.co.uk/toolbox>

FLEET TOOLBOX

Discover the facts in our online Toolbox for both Company Car Drivers and Fleet Decision Makers. The Fleet Toolbox has a host of useful calculators, comparators, interactive listings and information. Visit the Fleet Toolbox by going to www.vauxhall-toolbox.co.uk



ROADTRIP APP

The Vauxhall RoadTrip App is a free app that calculates and logs your mileage expenses for any UK business trips and generates reports to help you complete your mileage claims. Available for both iPhone and Android, visit www.vauxhall-toolbox.co.uk or visit the iPhone or Android stores and search for Vauxhall RoadTrip to download it to your smartphone or tablet.



CONTACT VAUXHALL FLEET

Please contact one of our dedicated sales teams who will be happy to help with your particular enquiry.

Company Car Drivers

Call: 0345 111 2020
 Email: company-car@vauxhallinfo.co.uk

Telephone lines are open
 – Monday to Friday 8.00am-9.00pm
 – Saturday and Sunday 9.00am-6.00pm

Fleet Decision Makers

Depending on the size of your fleet of vehicles, we have a dedicated team to handle your enquiries. The lines are open Monday to Friday excluding Bank Holidays.

1-24 vehicles

Call: 0845 076 2254 (8.30am-5.00pm)
 Email: b2bsales@vauxhall.co.uk

25+ vehicles

Call: 0330 587 8222 (8.30am-5.00pm)
 Email: vauxhallfleet@vauxhall.co.uk

Special Vehicles (Police, Fire and Ambulance)

Call: 01582 409999 (8.30am-5.00pm)
 Email: vauxhallspecialvehicles@vauxhall.co.uk

ZAFIRA TOURER ADDITIONAL INFORMATION

ON-THE-ROAD PRICES

To eliminate uncertainty about hidden costs when buying a new car, Vauxhall publishes on-the-road recommended retail prices (RRP) and these are shown in the pricing tables within this price guide. These prices include VAT, number plates and delivery to Retailer of £700.00 (including £116.67 VAT), 12 months' Government Vehicle Excise Duty (see opposite for details) and the DVLA new vehicle first registration fee of £55.00*.

Please note: The on-the-road recommended retail price (RRP) does not include fuel supplied by the Retailer, motor insurance or any other goods or services supplied by agreement between the Retailer and the customer.

PRICE PROTECTION

Order a new Vauxhall for build in the current model year (as confirmed by your Retailer) for delivery no more than three months in advance and the price you are quoted is the price you pay. This is irrespective of any subsequent price rises between placing your order and delivery of your new car, but you must take delivery as soon as the car is available. Vauxhall Motors Limited is not liable for price adjustments caused by Government changes in the rate of VAT (currently 20%), Vehicle Excise Duty, DVLA new vehicle first registration fee or by any other applicable legislation or regulations.

VEHICLE EXCISE DUTY

The amount of Vehicle Excise Duty (road fund licence) payable on new cars varies depending on the level of carbon dioxide (CO₂) emissions produced by the vehicle. CO₂ emissions are measured in grammes (g) per kilometre (km) travelled and divided into 13 charging bands shown in the table below.

A 'first year rate' of Vehicle Excise Duty is payable on all new cars and in subsequent years the amount payable reverts to the 'standard rate'. From 1 April 2017 the breakpoints for each of these bands have been revised. Also, for vehicles with a list price over £40,000, including factory-fitted options, an additional £310 is payable for the first five years of standard rate payments.

Vehicle Excise Duty*

	CO ₂ emissions (g/km)	First year rate	Standard rate
Band A	0	£0.00	£0.00
Band B	1-50	£10.00	£140.00
Band C	51-75	£25.00	£140.00
Band D	76-90	£100.00	£140.00
Band E	91-100	£120.00	£140.00
Band F	101-110	£140.00	£140.00
Band G	111-130	£160.00	£140.00
Band H	131-150	£200.00	£140.00
Band I	151-170	£500.00	£140.00
Band J	171-190	£800.00	£140.00
Band K	191-225	£1200.00	£140.00
Band L	226-255	£1700.00	£140.00
Band M	over 255	£2000.00	£140.00

* = Correct at time of issue.

VAUXHALL LEASING

As Vauxhall's own contract hire and fleet management operation, Vauxhall Leasing provides a one-stop-shop for competitive car and van leasing solutions – for business users and private individuals. Working with the Vauxhall Retailer network, we combine the support of a national contract with the convenience of a local contact.

For further information, please see your local Vauxhall Retailer or call us on **0117 908 6433**. Alternatively, you can visit our website at www.vauxhall-leasing.co.uk

IN THE EVENT OF AN ACCIDENT...

Vauxhall Accident Management helps keep you mobile following an accident. Benefits include vehicle recovery, Vauxhall-approved repairs and contacting your insurer. For more details, visit vauxhall.co.uk/AccidentManagement

TRUST VAUXHALL

CUSTOMER CARE COMMITMENT

For added peace of mind, Vauxhall has an innovative Customer Care Commitment that offers the following:

- Three-year vehicle warranty consisting of a one-year/unlimited mileage manufacturer's warranty and a second and third year manufacturer's warranty with a 60,000 miles limitation
- Vauxhall Assistance for 12 months from first registration
- Six years' body panel anti-perforation warranty

Please note: Warranty is only available on vehicles sourced from Vauxhall Motors Limited. Terms and conditions apply – please see your Vauxhall Retailer for details.

VAUXHALL ASSISTANCE

Vauxhall Assistance is provided automatically with every new Vauxhall for 12 months from first registration and covers everything from accident assistance, roadside recovery and 'at home' service to flat tyres. With Vauxhall Assistance help is literally just a free* phone call away, 24 hours a day, 365 days a year!

* = Mobile phone users will be charged at their standard tariff.

PROTECTING THE ENVIRONMENT

Vauxhall's commitment to the environment is demonstrated by our products' many environmental awards. For even more information on Vauxhall's efforts to achieve an environmentally sustainable future, and how to dispose of your end-of-life vehicle, see www.vauxhall.co.uk/recycling

VAUXHALL SERVICE PLAN

- Fixed monthly payments for the plan duration
- Easy to budget and interest-free
- Genuine parts fitted by Vauxhall-trained technicians

Plus on Gold plans:

- Valet and courtesy car
- Full AA cover
- Engine flush and fuel treatments
- Litre of oil for top ups between services

Full details can be obtained from your local participating Vauxhall Retailer.

VAUXHALL INSURANCE WITH ADDED REASSURANCE

Comprehensive cover – Summary of benefits**

- Competitive premiums
- Repairs by a Vauxhall-trained technician
- Genuine Vauxhall parts, guaranteed for three years when we repair your car within our Approved Repairer Network
- Free courtesy car as standard when using an Approved Repairer†
- 24 hour claims helpline
- Personal Accident benefit
- Cover for audio equipment
- Windscreen cover

Call for a quote on 0844 463 2670††

** = The benefits listed above are for comprehensive cover only. For details of Third Party, Fire and Theft cover, please call our sales team.
† = Should your car need repairing following an accident we provide a courtesy car (subject to availability) for the duration of the repair. Only genuine Vauxhall parts are used. Terms and conditions apply.
†† = Calls may be recorded. Vauxhall Insurance is underwritten by Ageas Insurance Limited.

FOR MORE PRODUCT INFORMATION

For a brochure on any Vauxhall model (up to a maximum of three per caller) or location of your nearest Vauxhall Retailer please call **0345 600 1500**. Alternatively, details can be found on our website at www.vauxhall.co.uk

JOIN US ONLINE:



PROUD SPONSOR OF OUR NATIONAL FOOTBALL TEAMS



Privacy Policy – For full details please visit: vauxhall.co.uk/privacy

Vauxhall OnStar privacy details are available at vauxhall.co.uk/onstar

The invoice price, including delivery to Retailer, factory-fitted options, accessories fitted by the Retailer and number plates, is subject to VAT. Some feature descriptions in this guide may refer to, and some illustrations may show, optional equipment not included in the standard delivery. The information contained in this guide was accurate at the time of publication. We reserve the right to make changes in design and equipment. Please note that Vauxhall Retailers are not the agents of Vauxhall Motors Limited and are not authorised to bind Vauxhall Motors Limited by any specific or implied undertaking or representation. It is advisable to ensure that your motor insurance policy provides adequate cover for additional fitted options and accessories. The colours in this guide are only approximate actual colours. Illustrated optional equipment is available at extra charge. Availability, technical features and equipment provided on our vehicles can vary by model. For precise information on the equipment provided on our vehicles, please contact your local Vauxhall Retailer.

VAUXHALL

vauxhall.co.uk

©2017 Vauxhall Motors Limited

Published 3 October 2017 Vauxhall Motors Limited

NEW ZAFIRA TOURER PRICE/SPECIFICATION GUIDE

1 April 2017



Model Year 2017.5

NEW ZAFIRA TOURER CUSTOMER OFFERS

At Vauxhall we know that customers appreciate flexibility. Not only do we have an extensive range of New Zafira Tourer models to choose from, but we have a range of ways to purchase too. Here's an example of our personal contract hire:



For ONLY **£318**
per month over
35 months with £5,088
advance rental

For even more great deals contact your local Retailer or call 0345 600 1500

TERMS AND CONDITIONS: Personal contract hire offer on New Zafira Tourer 1.4i Turbo (140PS), including free of charge brilliant/metallic paint, on vehicles ordered by 3 July 2017, subject to availability and status. Age 18+ only. Figures based on a non-maintenance contract hire package with advance rental of £5,088, then 35 monthly rentals of £318. Excess miles over contracted mileage of 24,000 over 36 months charged at 9.91 pence per mile. Excess charges also apply if you breach manufacturer servicing or maintenance guidelines or if the car exceeds BVRLA Fair Wear & Tear guidelines for its age/mileage when it is returned to Vauxhall Leasing. Package includes Road Fund Licence and Vauxhall Assistance. Guarantee/indemnity may be required. Prices and details are subject to change without notice. For full specification and Ts&Cs contact your local Retailer. **You will not own the car.** ALD Automotive Ltd., trading as Vauxhall Leasing, BS16 7LBs. Authorised and regulated by the Financial Conduct Authority.

NEW ZAFIRA TOURER RANGE HIGHLIGHTS



DESIGN OTR from £19,530

Standard features include:

Exterior convenience / styling:

- 17-inch alloy wheels
- Remote control central locking
- Electrically operated front and rear windows
- Electrically adjustable/heated door mirrors
- Front / rear parking distance sensors

Interior convenience / styling:

- Air conditioning
- Cruise control with speed limiter
- Steering column adjustable for reach / rake
- Steering wheel audio / phone / cruise controls
- Central storage facility with two cup holders
- Ambient lighting in roof
- Luggage compartment cover

Infotainment:

- R4.0 IntelliLink audio system
 - 7-inch colour touchscreen
 - AM/FM/DAB digital radio
 - Bluetooth® audio streaming / Bluetooth® mobile phone portal
 - USB audio connection
 - Apple CarPlay™ / Android Auto™
- Six speakers

Safety / security:

- Vauxhall OnStar
- Electronic Stability Programme (ESP)
- Anti-lock Braking System (ABS)
- Six airbags
- ISOFIX child seat mounting points on outer rear seats
- Height-adjustable front and rear seat head restraints
- Door-to-door illumination
- LED daytime running lights
- Electronic engine deadlock immobiliser



ENERGY OTR from £22,650

Features over Design:

Exterior convenience / styling:

- Front fog lights
- Chrome-effect lower window surround
- Dark-tinted rear windows
- Silver-effect roof rails

Infotainment:

- Navi 950 IntelliLink system
 - Satellite navigation

Please note, Apple CarPlay™ / Android Auto™ are not supported on the Navi 950 IntelliLink system



SRI OTR from £24,195

Features over Design:

Exterior convenience / styling:

- 17-inch 10-spoke alloy wheels (1.6CDTi)
- 18-inch alloy wheels (1.4i Turbo/2.0CDTi)
- Front fog lights
- Silver-effect roof rails

Interior convenience / styling:

- Three-spoke chrome-bezelled leather-covered steering wheel
- Sports style seats
- Driver's seat with tilt and four-way electric lumbar adjustment
- Sports pedals

Safety / security:

- Remote control security alarm system

SRI Nav models additionally feature

- Navi 950 IntelliLink system
 - Satellite navigation

Please note, Apple CarPlay™ / Android Auto™ are not supported on the Navi 950 IntelliLink system



17-inch







18-inch





NEW ZAFIRA TOURER RANGE HIGHLIGHTS



SE	OTR from £24,180
<i>Features over Design:</i>	
Exterior convenience / styling:	
<ul style="list-style-type: none"> • Automatic lighting control • Rain-sensitive windscreen wipers • Dark-tinted rear windows • Front fog lights • Chrome-effect lower window surround • Silver-effect roof rails 	
Interior convenience / styling:	
<ul style="list-style-type: none"> • Electronic climate control • Three-spoke chrome-bezelled leather-covered steering wheel • Lounge seating • FlexRail® centre console system • Front passenger's underseat storage facility • Electric parking brake 	
Safety / security:	
<ul style="list-style-type: none"> • Remote control security alarm system 	
	
	

TECH LINE	OTR from £21,225
<i>Features over Design:</i>	
Exterior convenience / styling:	
<ul style="list-style-type: none"> • Automatic lighting control • Rain-sensitive windscreen wipers • Dark-tinted rear windows • Front fog lights • Chrome-effect lower window surround • Silver-effect roof rails 	
Interior convenience / styling:	
<ul style="list-style-type: none"> • Electronic climate control • Three-spoke chrome-bezelled leather-covered steering wheel • Lounge seating • FlexRail® centre console system • Front passenger's underseat storage facility • Electric parking brake 	
Infotainment:	
<ul style="list-style-type: none"> • Navi 950 IntelliLink system <ul style="list-style-type: none"> – Satellite navigation Please note, Apple CarPlay™ / Android Auto™ are not supported on the Navi 950 IntelliLink system	
Safety / security:	
<ul style="list-style-type: none"> • Remote control security alarm system 	
	
	

ELITE	OTR from £25,660
<i>Features over SE:</i>	
Exterior convenience / styling:	
<ul style="list-style-type: none"> • 18-inch alloy wheels • Panoramic windscreen • Panoramic sunroof (excludes roof rails) 	
Interior convenience / styling:	
<ul style="list-style-type: none"> • Leather seat trim (front and second row seats) • Heated front seats • Ergonomic driver's sports front seat, featuring: <ul style="list-style-type: none"> – Extendable seat cushion and seat tilt adjustment – Four-way electrical lumbar adjustment 	
Elite Nav models additional feature	
<ul style="list-style-type: none"> • Navi 950 IntelliLink system <ul style="list-style-type: none"> – Satellite navigation Please note, Apple CarPlay™ / Android Auto™ are not supported on the Navi 950 IntelliLink system	
	
	

NEW ZAFIRA TOURER DESIGN



5-door MPV
OTR RRP CO₂ (g/km)

NEW ZAFIRA TOURER DESIGN – ON-THE-ROAD PRICES

Engine	Power (PS)	OTR RRP	CO ₂ (g/km)
Petrol	1.4i Turbo (140PS)	£19,530	156
	1.4i Turbo (140PS) auto	£21,050	160
Diesel	1.6CDTi (134PS) S/S ecoFLEX BlueInjection	£22,185	119
	2.0CDTi (170PS) S/S BlueInjection	£22,385	129
	2.0CDTi (170PS) auto BlueInjection	£23,665	161

Please note: On-the-road recommended retail prices (RRP) include VAT at 20%, number plates and delivery to Retailer of £700.00 (inc. £116.67 VAT), 12 months' Vehicle Excise Duty and new vehicle first registration fee of £55.00. Excludes fuel and insurance. S/S = Start/Stop.

NEW ZAFIRA TOURER DESIGN – KEY OPTIONS

Option	Total inc. VAT	
 Looking good:	Brilliant paint	£285
	Metallic / pearlescent paint	£555
 Practicality:	Emergency spare wheel (in lieu of emergency tyre inflation kit)	£110
	Remote control alarm	£260
	Navi 950 IntelliLink touchscreen navigation and infotainment system	£710
	Seat Comfort Pack One	£180
	Seat Comfort Pack Two	£330
	Rear side window sunblinds	£110
	Loading Pack	£125
	FlexOrganiser® Pack	£160
	Electro Pack	£170
	Towing Pack	£710
VXR Styling Pack	£950	

For details of these and other options please see Features/Options pages.



NEW ZAFIRA TOURER DESIGN – FEATURES

Vauxhall OnStar:

- Automatic crash response / Wi-Fi hotspot / smartphone app / stolen vehicle assistance / vehicle diagnostics

Infotainment:

- R4.0 IntelliLink audio system
 - 7-inch colour touchscreen
 - AM/FM/DAB digital radio
 - Bluetooth® audio streaming
 - Bluetooth® mobile phone portal
 - USB audio connection
 - Apple CarPlay™ / Android Auto™
- Six speakers

Interior convenience / styling:

- Air conditioning
- Multi-function trip computer
- Cruise control with speed limiter
- Steering column adjustable for reach / rake
- Steering wheel audio / phone / cruise controls
- Front centre armrest
- Central storage facility with two cup holders
- Ambient lighting in roof
- Luggage compartment cover

Exterior convenience / styling:

- 17-inch alloy wheels
- Remote control central locking
- Electrically operated front and rear windows
- Electrically adjustable/heated door mirrors
- Front and rear parking distance sensors
- Black roof rails

Safety / security:

- Electronic Stability Programme (ESP)
- Anti-lock Braking System (ABS)
- Six airbags
- ISOFIX child seat mounting points on outer rear seats
- Deactivation switch for front passenger's front and side-impact airbags
- Height-adjustable front and rear seat head restraints
- Tyre pressure monitoring system
- Door-to-door illumination
- LED daytime running lights
- Electronic engine deadlock immobiliser

CUSTOMER OFFERS*

Please consult your Retailer for details.

 Flexible Personal Lease

 Flexible PCP (3.7% APR)

COMPANY CAR INFORMATION

Please see www.vauxhall.co.uk/fleet for details.

 P11D price starting at £18,975

 From 25% tax band** / £92 monthly car tax**

 CO₂ emissions from 119g/km

* = Terms and conditions apply.

** = 2017/18 tax year.

NEW ZAFIRA TOURER ENERGY



5-door MPV
OTR RRP CO₂ (g/km)

NEW ZAFIRA TOURER ENERGY – ON-THE-ROAD PRICES

Engine	OTR RRP	CO ₂ (g/km)
Petrol 1.4i Turbo (140PS)	£22,650	156
1.4i Turbo (140PS) auto	£24,170	160
Diesel 1.6CDTi (134PS) S/S ecoFLEX BlueInjection	£25,305	119
2.0CDTi (170PS) S/S BlueInjection	£25,505	129
2.0CDTi (170PS) auto BlueInjection	£26,785	161

Please note: On-the-road recommended retail prices (RRP) include VAT at 20%, number plates and delivery to Retailer of £700.00 (inc. £116.67 VAT), 12 months' Vehicle Excise Duty and new vehicle first registration fee of £55.00. Excludes fuel and insurance. S/S = Start/Stop.

NEW ZAFIRA TOURER ENERGY – KEY OPTIONS

Option	Total inc. VAT
 Looking good: Brilliant paint	£285
Metallic / pearlescent paint	£555
 Easier parking: Rear-view camera	£210
 Practicality: Emergency spare wheel (in lieu of emergency tyre inflation kit)	£110
Remote control alarm	£260
Seat Comfort Pack One	£180
Seat Comfort Pack Two	£330
Rear side window sunblinds	£110
Loading Pack	£125
FlexOrganiser® Pack	£160
Electro Pack	£170
Towing Pack	£710
VXR Styling Pack	£950

For details of these and other options please see Features/Options pages.



NEW ZAFIRA TOURER ENERGY – FEATURES

Vauxhall OnStar:

- Automatic crash response / Wi-Fi hotspot / smartphone app / stolen vehicle assistance / vehicle diagnostics

Infotainment:

- Navi 950 IntelliLink system
 - Satellite navigation
 - 7-inch colour touchscreen
 - AM/FM/DAB digital radio
 - Bluetooth® audio streaming
 - Bluetooth® mobile phone portal
 - USB audio connection
- Six speakers

Interior convenience / styling:

- Air conditioning
- Multi-function trip computer
- Cruise control with speed limiter
- Steering column adjustable for reach / rake
- Steering wheel audio / phone / cruise controls
- Front centre armrest
- Central storage facility with two cup holders
- Ambient lighting in roof
- Luggage compartment cover

Exterior convenience / styling:



- 17-inch alloy wheels
- Remote control central locking
- Electrically operated front and rear windows
- Electrically adjustable/heated door mirrors
- Front and rear parking distance sensors
- Front fog lights
- Chrome-effect lower window surround
- Dark-tinted rear windows
- Silver-effect roof rails

Safety / security:

- Electronic Stability Programme (ESP)
- Anti-lock Braking System (ABS)
- Six airbags
- ISOFIX child seat mounting points on outer rear seats
- Deactivation switch for front passenger's front and side-impact airbags
- Height-adjustable front and rear seat head restraints
- Tyre pressure monitoring system
- Door-to-door illumination
- LED daytime running lights
- Electronic engine deadlock immobiliser

CUSTOMER OFFERS*



Please consult your Retailer for details.

-  **0% Flexible Finance**
-  **Flexible PCP (3.7% APR) with £1200 Vauxhall Deposit Contribution**
-  **Flexible Personal Lease**

* = Terms and conditions apply.

COMPANY CAR INFORMATION

Please see www.vauxhall.co.uk/fleet for details.

-  **P11D price starting at £22,095**
-  **From 25% tax band** / £105 monthly car tax****
-  **CO₂ emissions from 119g/km**

** = 2017/18 tax year.

NEW ZAFIRA TOURER SRi

5-door MPV
OTR RRP CO₂ (g/km)

NEW ZAFIRA TOURER SRi – ON-THE-ROAD PRICES







Petrol	1.4i Turbo (140PS)	£24,195	156
	1.4i Turbo (140PS) auto	£25,715	160
Diesel	1.6CDTi (134PS) S/S ecoFLEX BlueInjection	£26,850	119
	2.0CDTi (170PS) S/S BlueInjection	£27,025	137
	2.0CDTi (170PS) auto BlueInjection	£28,330	161

NEW ZAFIRA TOURER SRi NAV – ON-THE-ROAD PRICES

Petrol	1.4i Turbo (140PS)	£24,895	156
	1.4i Turbo (140PS) auto	£26,415	160
Diesel	1.6CDTi (134PS) S/S ecoFLEX BlueInjection	£27,550	119
	2.0CDTi (170PS) S/S BlueInjection	£27,725	137
	2.0CDTi (170PS) auto BlueInjection	£29,030	161

Please note: On-the-road recommended retail prices (RRP) include VAT at 20%, number plates and delivery to Retailer of £700.00 (inc. £116.67 VAT), 12 months' Vehicle Excise Duty and new vehicle first registration fee of £55.00. Excludes fuel and insurance. S/S = Start/Stop.

NEW ZAFIRA TOURER SRi – KEY OPTIONS

		Total inc. VAT
 Looking good:	Brilliant paint	£285
	Metallic / pearlescent paint	£555
	18-inch 5-twinspoke alloy wheels (1.6CDTi (134PS) S/S only)	£110
	19-inch 5-spoke bi-colour alloy wheels	£450
 Easier parking:	Rear-view camera	£210
 Sitting comfortably:	Electronic climate control including air conditioning	£405
	Heated leather-covered steering wheel	£110
	Winter Pack	£365
	Leather Pack	£1060
 Fresh air:	Panoramic windscreen and panoramic sunroof	£610
 Driving assistance:	Sight and Light Pack	£240
 Practicality:	Emergency spare wheel (in lieu of emergency tyre inflation kit)	£110
	Rear side window sunblinds	£110
	Loading Pack	£125
	FlexOrganiser® Pack	£160
	Electro Pack	£170
	Towing Pack	£710
	Flex-Fix® integrated carrier system	£910
	VXR Styling Pack	£950

For details of these and other options please see Features/Options pages.



NEW ZAFIRA TOURER SRi – FEATURES

Vauxhall OnStar:

- Automatic crash response / Wi-Fi hotspot / smartphone app / stolen vehicle assistance / vehicle diagnostics

Infotainment:

- R4.0 IntelliLink audio system
 - 7-inch colour touchscreen
 - AM/FM/DAB digital radio
 - Bluetooth® audio streaming
 - Bluetooth® mobile phone portal
 - USB audio connection
 - Apple CarPlay™ / Android Auto™
- Six speakers

Interior convenience / styling:

- Air conditioning
- Multi-function trip computer
- Cruise control with speed limiter
- Steering column adjustable for reach / rake
- Steering wheel audio / phone / cruise controls
- Three-spoke chrome-bezelled leather-covered steering wheel
- Sports style seats
- Driver's seat with tilt and four-way electric lumbar adjustment
- Front centre armrest
- Central storage facility with two cup holders
- Ambient lighting in roof
- Sports pedals
- Luggage compartment cover

Exterior convenience / styling:

- 17-inch alloy wheels (1.6CDTi)
- 18-inch alloy wheels (1.4i Turbo/2.0CDTi)
- Remote control central locking
- Electrically operated front and rear windows
- Electrically adjustable/heated door mirrors
- Front and rear parking distance sensors
- Front fog lights
- Silver-effect roof rails

Safety / security:



- Electronic Stability Programme (ESP)
- Anti-lock Braking System (ABS)
- Six airbags
- ISOFIX child seat mounting points on outer rear seats
- Deactivation switch for front passenger's front and side-impact airbags
- Height-adjustable front and rear seat head restraints
- Door-to-door illumination
- Tyre pressure monitoring system
- LED daytime running lights
- Remote control security alarm system
- Electronic engine deadlock immobiliser

SRi Nav models additionally feature

- Navi 950 Satellite navigation system
- Please note, Apple CarPlay™ / Android Auto™ are not supported on the Navi 950 IntelliLink system

CUSTOMER OFFERS*



Please consult your Retailer for details.

-  **0% Flexible Finance**
-  **Flexible PCP (3.7% APR) with £1200 Vauxhall Deposit Contribution**
-  **Flexible Personal Lease**

* = Terms and conditions apply.

COMPANY CAR INFORMATION

Please see www.vauxhall.co.uk/fleet for details.

-  **P11D price starting at £23,640**
-  **From 25% tax band** / £111 monthly car tax****
-  **CO₂ emissions from 119g/km**

** = 2017/18 tax year.

NEW ZAFIRA TOURER SE

5-door MPV
OTR RRP CO₂ (g/km)

NEW ZAFIRA TOURER SE – ON-THE-ROAD PRICES

Engine	OTR RRP	CO ₂ (g/km)
Petrol 1.4i Turbo (140PS)	£24,180	156
1.4i Turbo (140PS) auto	£25,700	160
Diesel 1.6CDTi (134PS) S/S ecoFLEX BlueInjection	£26,835	119
2.0CDTi (170PS) S/S BlueInjection	£27,035	129
2.0CDTi (170PS) auto BlueInjection	£28,315	161

Please note: On-the-road recommended retail prices (RRP) include VAT at 20%, number plates and delivery to Retailer of £700.00 (inc. £116.67 VAT), 12 months' Vehicle Excise Duty and new vehicle first registration fee of £55.00. Excludes fuel and insurance. S/S = Start/Stop.

NEW ZAFIRA TOURER SE – KEY OPTIONS

Option	Total inc. VAT
Looking good: Brilliant paint	£285
Metallic / pearlescent paint	£555
18-inch 10-spoke alloy wheels	£360
19-inch multispoke alloy wheels	£710
Easier parking: Rear-view camera	£210
Front camera system	£805
Sitting comfortably: Winter Pack	£365
Ergonomic driver's sport style seat	£480
Fresh air: Panoramic windscreen and panoramic sunroof	£610
Driving assistance: Driver Assistance Pack	
Forward collision alert with automatic city emergency braking / adaptive cruise control / side blind spot alert / following distance indicator	£1005
FlexRide adaptive chassis system	£800
Premium Forward Lighting Pack	£900
Practicality: Navi 950 IntelliLink touchscreen navigation and infotainment system	£710
Emergency spare wheel (in lieu of emergency tyre inflation kit)	£110
Seat Comfort Pack One	£180
Seat Comfort Pack Two	£330
Rear side window sunblinds	£110
Loading Pack	£125
FlexOrganiser® Pack	£160
Electro Pack	£170
Towing Pack	£710
Flex-Fix® integrated carrier system	£910
VXR Styling Pack	£950

For details of these and other options please see Features/Options pages.



NEW ZAFIRA TOURER SE – FEATURES

Vauxhall OnStar:

- Automatic crash response / Wi-Fi hotspot / smartphone app / stolen vehicle assistance / vehicle diagnostics

Infotainment:

- R4.0 IntelliLink audio system
 - 7-inch colour touchscreen
 - AM/FM/DAB digital radio
 - Bluetooth® audio streaming
 - Bluetooth® mobile phone portal
 - USB audio connection
 - Apple CarPlay™ / Android Auto™
- Six speakers

Interior convenience / styling:

- Electronic climate control
- Multi-function trip computer
- Cruise control with speed limiter
- Steering column adjustable for reach / rake
- Steering wheel audio / phone / cruise controls
- Three-spoke chrome-bezelled leather-covered steering wheel
- Lounge seating
- FlexRail® centre console system
- Front passenger's underseat storage facility
- Electric parking brake
- Ambient lighting in roof
- Luggage compartment cover

Exterior convenience / styling:

- 17-inch alloy wheels
- Remote control central locking
- Electrically operated front and rear windows
- Electrically adjustable/heated door mirrors
- Front and rear parking distance sensors
- Automatic lighting control
- Rain-sensitive windscreen wipers
- Dark-tinted rear windows
- Front fog lights
- Chrome-effect lower window surround
- Silver-effect roof rails

Safety / security:

- Electronic Stability Programme (ESP)
- Anti-lock Braking System (ABS)
- Six airbags
- ISOFIX child seat mounting points on outer rear seats
- Deactivation switch for front passenger's front and side-impact airbags
- Height-adjustable front and rear seat head restraints
- Tyre pressure monitoring system
- Door-to-door illumination
- LED daytime running lights
- Remote control security alarm system
- Electronic engine deadlock immobiliser

CUSTOMER OFFERS*

Please consult your Retailer for details.

- ✓ **0% Flexible Finance**
- ✓ **Flexible PCP (3.7% APR) with £1200 Vauxhall Deposit Contribution**
- ✓ **Flexible Personal Lease**

* = Terms and conditions apply.

COMPANY CAR INFORMATION

Please see www.vauxhall.co.uk/fleet for details.

- ✓ **P11D price starting at £23,625**
- ✓ **From 25% tax band** / £111 monthly car tax****
- ✓ **CO₂ emissions from 119g/km**

** = 2017/18 tax year.

NEW ZAFIRA TOURER TECH LINE







5-door MPV
OTR RRP CO₂ (g/km)

NEW ZAFIRA TOURER TECH LINE – ON-THE-ROAD PRICES

Engine	Power (PS)	OTR RRP	CO ₂ (g/km)
Petrol	1.4i Turbo (140PS)	£21,225	156
	1.4i Turbo (140PS) auto	£22,745	160
Diesel	1.6CDTi (134PS) S/S ecoFLEX BlueInjection	£23,880	119
	2.0CDTi (170PS) S/S BlueInjection	£24,080	129
	2.0CDTi (170PS) auto BlueInjection	£25,360	161

Please note: On-the-road recommended retail prices (RRP) include VAT at 20%, number plates and delivery to Retailer of £700.00 (inc. £116.67 VAT), 12 months' Vehicle Excise Duty and new vehicle first registration fee of £55.00. Excludes fuel and insurance. S/S = Start/Stop.

NEW ZAFIRA TOURER TECH LINE – KEY OPTIONS

Option	Total inc. VAT	
 Looking good:	Brilliant paint	£285
	Metallic / pearlescent paint	£555
	18-inch 10-spoke alloy wheels	£360
	19-inch multispoke alloy wheels	£710
 Easier parking:	Rear-view camera	£210
	Front camera system	£805
 Sitting comfortably:	Winter Pack	£365
	Ergonomic driver's sport style seat	£480
 Fresh air:	Panoramic windscreen and panoramic sunroof	£610
 Driving assistance:	Driver Assistance Pack	
	Forward collision alert with automatic city emergency braking / adaptive cruise control / side blind spot alert / following distance indicator	£1005
	FlexRide adaptive chassis system	£800
	Premium Forward Lighting Pack	£900
	Emergency spare wheel (in lieu of emergency tyre inflation kit)	£110
 Practicality:	Seat Comfort Pack One	£180
	Seat Comfort Pack Two	£330
	Rear side window sunblinds	£110
	Loading Pack	£125
	FlexOrganiser® Pack	£160
	Electro Pack	£170
	Towing Pack	£710
	Flex-Fix® integrated carrier system	£910
	VXR Styling Pack	£950

For details of these and other options please see Features/Options pages.



NEW ZAFIRA TOURER TECH LINE – FEATURES

Vauxhall OnStar:

- Automatic crash response / Wi-Fi hotspot / smartphone app / stolen vehicle assistance / vehicle diagnostics

Infotainment:

- Navi 950 IntelliLink system
 - Satellite navigation
 - 7-inch colour touchscreen
 - AM/FM/DAB digital radio
 - Bluetooth® audio streaming
 - Bluetooth® mobile phone portal
 - USB audio connection
- Six speakers

Interior convenience / styling:

- Electronic climate control
- Multi-function trip computer
- Cruise control with speed limiter
- Steering column adjustable for reach / rake
- Steering wheel audio / phone / cruise controls
- Three-spoke chrome-bezelled leather-covered steering wheel
- Lounge seating
- FlexRail® centre console system
- Front passenger's underseat storage facility
- Electric parking brake
- Ambient lighting in roof

Exterior convenience / styling:

- 17-inch alloy wheels
- Remote control central locking
- Electrically operated front and rear windows
- Electrically adjustable/heated door mirrors
- Front and rear parking distance sensors
- Automatic lighting control
- Rain-sensitive windscreen wipers
- Dark-tinted rear windows
- Front fog lights
- Chrome-effect lower window surround
- Silver-effect roof rails

Safety / security:

- Electronic Stability Programme (ESP)
- Anti-lock Braking System (ABS)
- Six airbags
- ISOFIX child seat mounting points on outer rear seats
- Deactivation switch for front passenger's front and side-impact airbags
- Height-adjustable front and rear seat head restraints
- Tyre pressure monitoring system
- Door-to-door illumination
- LED daytime running lights
- Remote control security alarm system
- Electronic engine deadlock immobiliser

CUSTOMER OFFERS*

Please consult your Retailer for details.

 **Flexible Personal Lease**

 **Flexible PCP (3.7% APR)**

COMPANY CAR INFORMATION

Please see www.vauxhall.co.uk/fleet for details.

 **P11D price starting at £20,670**

 **From 25% tax band** / £99 monthly car tax****

 **CO₂ emissions from 119g/km**

* = Terms and conditions apply.

** = 2017/18 tax year.

NEW ZAFIRA TOURER ELITE

5-door MPV
OTR RRP CO₂ (g/km)

NEW ZAFIRA TOURER ELITE – ON-THE-ROAD PRICES





Petrol	1.4i Turbo (140PS)	£25,660	156
	1.4i Turbo (140PS) auto	£27,180	160
Diesel	2.0CDTi (170PS) S/S BlueInjection	£28,490	137
	2.0CDTi (170PS) auto BlueInjection	£29,795	161

NEW ZAFIRA TOURER ELITE NAV – ON-THE-ROAD PRICES

Petrol	1.4i Turbo (140PS)	£26,360	156
	1.4i Turbo (140PS) auto	£27,880	160
Diesel	2.0CDTi (170PS) S/S BlueInjection	£29,190	137
	2.0CDTi (170PS) auto BlueInjection	£30,495	161

Please note: On-the-road recommended retail prices (RRP) include VAT at 20%, number plates and delivery to Retailer of £700.00 (inc. £116.67 VAT), 12 months' Vehicle Excise Duty and new vehicle first registration fee of £55.00. Excludes fuel and insurance. S/S = Start/Stop.

NEW ZAFIRA TOURER ELITE – KEY OPTIONS

	Total inc. VAT	
 Looking good:	Brilliant paint	£285
	Metallic / pearlescent paint	£555
	19-inch 5-spoke bi-colour alloy wheels	£450
 Easier parking:	Rear-view camera	£210
	Front camera system	£805
 Driving assistance:	Driver Assistance Pack	£1005
	<i>Forward collision alert with automatic city emergency braking / adaptive cruise control / side blind spot alert / following distance indicator</i>	
	FlexRide adaptive chassis system	£800
	Premium Forward Lighting Pack	£900
 Practicality:	Emergency spare wheel (in lieu of emergency tyre inflation kit)	£110
	Rear side window sunblinds	£110
	Loading Pack	£125
	FlexOrganiser® Pack	£160
	Electro Pack	£170
	Towing Pack	£710
	Flex-Fix® integrated carrier system	£910
VXR Styling Pack	£950	

For details of these and other options please see Features/Options pages.



NEW ZAFIRA TOURER ELITE – FEATURES

Vauxhall OnStar:

- Automatic crash response / Wi-Fi hotspot / smartphone app / stolen vehicle assistance / vehicle diagnostics

Infotainment:

- R4.0 IntelliLink audio system
 - 7-inch colour touchscreen
 - AM/FM/DAB digital radio
 - Bluetooth® audio streaming
 - Bluetooth® mobile phone portal
 - USB audio connection
 - Apple CarPlay™ / Android Auto™
- Six speakers

Interior convenience / styling:

- Leather seat trim (front and second row seats)
- Electronic climate control
- Multi-function trip computer
- Cruise control with speed limiter
- Steering column adjustable for reach / rake
- Steering wheel audio / phone / cruise controls
- Three-spoke chrome-bezelled leather-covered steering wheel
- Lounge seating
- Heated front seats
- Ergonomic driver's sports front seat, featuring:
 - Extendable seat cushion and seat tilt adjustment
 - Four-way electrical lumbar adjustment
- FlexRail® centre console system
- Electric parking brake
- Luggage compartment cover

Exterior convenience / styling:

- 18-inch alloy wheels
- Remote control central locking
- Panoramic windscreen
- Panoramic sunroof
- Chrome-effect lower window surround
- Dark-tinted rear windows
- Automatic lighting control
- Front fog lights
- Rain-sensitive windscreen wipers
- Electrically operated front and rear windows
- Electrically adjustable/heated door mirrors
- Front and rear parking distance sensors

Safety / security



- Electronic Stability Programme (ESP)
- Anti-lock Braking System (ABS)
- Six airbags
- ISOFIX child seat mounting points on outer rear seats
- Deactivation switch for front passenger's front and side-impact airbags
- Height-adjustable front and rear seat head restraints
- Tyre pressure monitoring system
- Door-to-door illumination
- LED daytime running lights
- Remote control security alarm system
- Electronic engine deadlock immobiliser

Elite Nav models additional feature

- Navi 950 Satellite navigation system
- Please note, Apple CarPlay™ / Android Auto™ are not supported on the Navi 950 IntelliLink system

CUSTOMER OFFERS*



Please consult your Retailer for details.

-  **0% Flexible Finance**
-  **Flexible PCP (3.7% APR) with £1200 Vauxhall Deposit Contribution**
-  **Flexible Personal Lease**

* = Terms and conditions apply.

COMPANY CAR INFORMATION

Please see www.vauxhall.co.uk/fleet for details.

-  **P11D price starting at £25,105**
-  **From 29% tax band** / £126 monthly car tax****
-  **CO₂ emissions from 137g/km**

** = 2017/18 tax year.

NEW ZAFIRA TOURER PRICES

Model 5-door MPV	Price (£)	VAT (£)	Total (£)	On-the-road RRP (£)	CO ₂ (g/km)	Model 5-door MPV	Price (£)	VAT (£)	Total (£)	On-the-road RRP (£)	CO ₂ (g/km)
DESIGN VAUXHALL OnStar						SE VAUXHALL OnStar					
1.4i Turbo (140PS)	15229.17	3045.83	18275.00	19530.00	156	1.4i Turbo (140PS)	19104.17	3820.83	22925.00	24180.00	156
1.4i Turbo (140PS) auto	16495.83	3299.17	19795.00	21050.00	160	1.4i Turbo (140PS) auto	20370.83	4074.17	24445.00	25700.00	160
<i>Diesel</i>						<i>Diesel</i>					
1.6CDTi (134PS) S/S ecoFLEX BlueInjection*	17725.00	3545.00	21270.00	22185.00	119	1.6CDTi (134PS) S/S ecoFLEX BlueInjection*	21600.00	4320.00	25920.00	26835.00	119**
2.0CDTi (170PS) S/S BlueInjection*	17891.67	3578.33	21470.00	22385.00	129	2.0CDTi (170PS) S/S BlueInjection*	21766.67	4353.33	26120.00	27035.00	129
2.0CDTi (170PS) auto BlueInjection*	18675.00	3735.00	22410.00	23665.00	161	2.0CDTi (170PS) auto BlueInjection*	22550.00	4510.00	27060.00	28315.00	161
ENERGY VAUXHALL OnStar						TECH LINE VAUXHALL OnStar					
1.4i Turbo (140PS)	17829.17	3565.83	21395.00	22650.00	156	1.4i Turbo (140PS)	16641.67	3328.33	19970.00	21225.00	156
1.4i Turbo (140PS) auto	19095.83	3819.17	22915.00	24170.00	160	1.4i Turbo (140PS) auto	17908.33	3581.67	21490.00	22745.00	160
<i>Diesel</i>						<i>Diesel</i>					
1.6CDTi (134PS) S/S ecoFLEX BlueInjection*	20325.00	4065.00	24390.00	25305.00	119	1.6CDTi (134PS) S/S ecoFLEX BlueInjection*	19137.50	3827.50	22965.00	23880.00	119**
2.0CDTi (170PS) S/S BlueInjection*	20491.67	4098.33	24590.00	25505.00	129	2.0CDTi (170PS) S/S BlueInjection*	19304.17	3860.83	23165.00	24080.00	129
2.0CDTi (170PS) auto BlueInjection*	21275.00	4255.00	25530.00	26785.00	161	2.0CDTi (170PS) auto BlueInjection*	20087.50	4017.50	24105.00	25360.00	161
SRI VAUXHALL OnStar						ELITE VAUXHALL OnStar					
1.4i Turbo (140PS)	19116.67	3823.33	22940.00	24195.00	156	1.4i Turbo (140PS)	20337.50	4067.50	24405.00	25660.00	156
1.4i Turbo (140PS) auto	20383.33	4076.67	24460.00	25715.00	160	1.4i Turbo (140PS) auto	21604.17	4320.83	25925.00	27180.00	160
<i>Diesel</i>						<i>Diesel</i>					
1.6CDTi (134PS) S/S ecoFLEX BlueInjection*	21612.50	4322.50	25935.00	26850.00	119**	2.0CDTi (170PS) S/S BlueInjection*	22945.83	4589.17	27535.00	28490.00	137
2.0CDTi (170PS) S/S BlueInjection*	21725.00	4345.00	26070.00	27025.00	137	2.0CDTi (170PS) auto BlueInjection*	23783.33	4756.67	28540.00	29795.00	161
2.0CDTi (170PS) auto BlueInjection*	22562.50	4512.50	27075.00	28330.00	161	ELITE NAV VAUXHALL OnStar					
SRI NAV VAUXHALL OnStar						1.4i Turbo (140PS)	20920.83	4184.17	25105.00	26360.00	156
1.4i Turbo (140PS)	19700.00	3940.00	23640.00	24895.00	156	1.4i Turbo (140PS) auto	22187.50	4437.50	26625.00	27880.00	160
1.4i Turbo (140PS) auto	20966.67	4193.33	25160.00	26415.00	160	<i>Diesel</i>					
<i>Diesel</i>						2.0CDTi (170PS) S/S BlueInjection*	23529.17	4705.83	28235.00	29190.00	137
1.6CDTi (134PS) S/S ecoFLEX BlueInjection*	22195.83	4439.17	26635.00	27550.00	119**	2.0CDTi (170PS) auto BlueInjection*	24366.67	4873.33	29240.00	30495.00	161
2.0CDTi (170PS) S/S BlueInjection*	22308.33	4461.67	26770.00	27725.00	137	Please note: On-the-road recommended retail prices (RRP) include number plates and delivery to retailer of £700.00 (inc. £116.67 VAT), 12 months' Vehicle Excise Duty and new vehicle first registration fee of £55.00. Excludes fuel and insurance.					
2.0CDTi (170PS) auto BlueInjection*	23145.83	4629.17	27775.00	29030.00	161	S/S = Start/Stop.					

S/S = Start/Stop.

* = Please note: Vehicles with BlueInjection technology will need regular AdBlue® top-ups also between servicing requirements.

An indicator integrated into the on-board computer will warn you when you need to top up. More information under www.vauxhall.co.uk/blueinjection. In accordance with regulations R (EC) No. 715/2007 and R (EC) No. 692/2008 (in the versions respectively applicable).

** = CO₂ emissions are based on vehicles fitted with standard 17-inch alloy wheels. If optional alloy wheels are specified, at extra cost, CO₂ emissions will be affected.

NEW ZAFIRA TOURER FEATURES/OPTIONS

SAFETY

Driver / passenger airbags

- Driver's airbag • Front passenger's airbag • Two front seat side-impact airbags
- Full-size curtain airbags for driver and front and outer rear seat passengers

Seating

- Height adjustable front and outer rear seat head restraints • Anti-submarining ramps in front seats
- Prevents occupants sliding underneath the lap belt during a collision

Seatbelts

- Five lap and diagonal inertia-reel seatbelts (height-adjustable front) • Third-row lap and diagonal inertia-reel seatbelts (when all seats are occupied within the New Zafira Tourer the passenger side third-row seat is only usable by a passenger up to a maximum height of 150cm (4ft 11 inches))
- Front body-lock diagonal seatbelt pretensioner system – Tightens the seatbelt during the early stages of a frontal impact • Drivers and front passenger's lap belt pretensioner system • Front seatbelt force limiters – Reduces potential upper body injuries during a frontal impact • Anti-submarining ramps in front seats – Help prevent occupants sliding underneath the lap belt during a collision

Child safety

- Deactivation switch for front passenger's front and side-impact airbags – Permits the safe use of a child seat in the front passenger seat • ISOFIX child seat mountings incorporating top tether anchor points located on outer rear seats (does not include child seat) – Allows ISOFIX child safety seats to be securely fixed into the car. The ISOFIX mounting system reduces forward movement in an accident and makes the child seat easier to install • Child-proof locks on rear doors

Driver / passenger safety

- Energy-absorbing steering column • Pedal release system – Reduces potential injury to the driver's legs and feet during a severe frontal impact • Laminated windscreen • Side-impact protection beams • Reinforced passenger safety cell • Deformation zones front and rear
- Burst-proof door locks and anti-jam door design

Pedestrian safety

- Bonnet / headlight / wiper structure – Designed to reduce pedestrian head and upper body injuries
- Upper and lower bumper design – Reduces upper and lower leg injuries

Stability

Electronic Stability Programme (ESP):

– Works in conjunction with the vehicle's electronic braking and engine systems to keep the car stable in many different situations. ESP monitors many different inputs to determine when the car starts to lose traction, it can then immediately respond by varying the brake pressure between up to three wheels and adjust the engine output to help correct the loss of traction and improve stability.

Additional ESP features:

- Cornering brake control • Straight line stability control • Rollover mitigation • Drag torque control – Maintain stability on slippery roads when lifting off the accelerator or changing gear

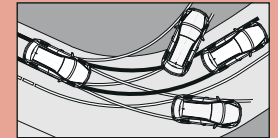

Braking

Anti-lock Braking System (ABS):

– Prevents the vehicle's wheels from locking up under heavy braking by momentarily reducing brake pressure at the appropriate wheel, ensuring that you can maintain control of the steering.

Additional braking features:



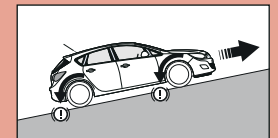



- The same electronic systems used in the ABS and ESP also deliver exceptional braking performance.
- Emergency brake assist – When emergency braking is detected the vehicle automatically applies the maximum possible braking assistance • Electronic brakeforce distribution – Automatically apportions the optimum braking force to each wheel • Adaptive brake lights – Automatically warns other road users of heavy braking
- Hill start assist – Briefly maintains rear brake pressure to stop the vehicle rolling back on an incline • Hazard warning lights



Tyre pressure

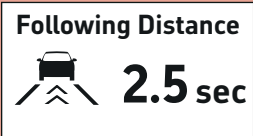







- Tyre pressure monitoring system

NEW ZAFIRA TOURER FEATURES/OPTIONS

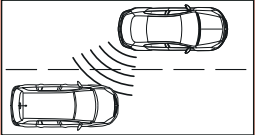
	Design	Energy	SRi	SE	Tech Line	Elite	Price (£) exc. VAT	Total (£) inc. VAT
DRIVER ASSISTANCE Steering • Speed sensitive electrically assisted power steering • Reach and rake adjustable steering	●	●	●	●	●	●		
Cruise control with speed limiter: <i>The cruise control feature enables you to maintain a constant speed – making it ideal for economical motorway driving. The speed limiter function can be set to ensure that you do not exceed the speed limit and can be easily overridden if required.</i> • Steering wheel mounted controls	●	●	●	●	●	●		
Electric parking brake • Centre console switch in lieu of handbrake lever • Premium centre console featuring adjustable armrest				●	●	●		
Front camera system <i>A wide range of class-leading driver assistance and safety features are controlled by the front camera system</i>								
Traffic sign recognition: <i>Detects and then displays speed limits, reducing uncertainty and the risk of speeding.</i> • Recognises different road signs, including temporary speed restrictions • Displays reminder in the driver information centre 								
 Always know the speed limit								
Following distance indicator: <i>Indicates how many seconds you are behind the vehicle in front – helping you maintain a safe distance.</i> • Timings are shown in the driver information centre 				○	○	○	670.83	805.00
 Keeps a safe distance								
Lane departure warning with lane assist: <i>If the driver has not actively steered or signalled, the lane departure warning system warns when the car moves outside of lane markings at speeds above 37mph. The lane keep assist function additionally provides gentle steering correction to help drivers keep in their lane if no active inputs are made.</i> • Warning light in instrument cluster • Audible warning • Steering wheel 'nudge' warning • Facia on/off switch • Both systems switch to standby when in road works or when road markings are confused 								
 Keeps you in lane								

● = Standard equipment. ○ = Optional at extra cost.

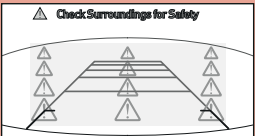
NEW ZAFIRA TOURER FEATURES/OPTIONS

DRIVER ASSISTANCE		Design	Energy	SRi	SE	Tech Line	Elite	Price (£) exc. VAT	Total (£) inc. VAT
Driver Assistance Pack A wide range of class-leading driver assistance and safety features are controlled by the front camera system Forward collision alert with automatic city emergency braking: In certain circumstances and: At speeds above 5mph warns when approaching another vehicle too quickly. At speeds above 5mph and up to 53mph the system provides additional braking support to help the driver brake more quickly and effectively in an emergency situation. At speeds above 5mph and up to 37mph if no avoiding action is taken by the driver, the system automatically slows the vehicle with emergency braking.									
									
• Visual warnings – projected onto windscreen and shown in the instrument cluster • Audible warning • Additional braking support • Low speed collision mitigation braking									
Adaptive cruise control: Adaptive cruise control automatically decelerates the vehicle when approaching a slower moving vehicle. It then adjusts the vehicles speed to follow the vehicle at the selected following distance. The vehicle speed increases or decreases to follow the vehicle in front, but will not exceed the set speed.									
 Helps maintain constant speed					○	○	○	837.50	1005.00
Side blind spot alert: Side blind spot alert helps prevent potential collisions with other vehicles 'hidden' in the vehicle's side blind spots. If a vehicle enters one of the blind spots a warning light illuminates in the relevant door mirror.									
									
• Ultrasonic side sensors with three-metre range • LED warning light in door mirrors • Audible warning is sounded if the indicators are used and the system has detected another vehicle • Electrically folding door mirrors									
 Warns of vehicles in your blind spot									
Following distance indicator: Indicates how many seconds you are behind the vehicle in front – helping you maintain a safe distance.									
• Timings are shown in the driver information centre									
									
 Keeps a safe distance									
Front and rear parking distance sensors • Front and rear parking distance sensors • Audible warning		●	●	●	●	●	●		
Rear-view camera (only available with Navi 950 IntelliLink system) The rear-view camera gives a clear view of the area behind your car and helps place the car perfectly, without needing to strain your neck.									
									
• Activated when reverse gear selected • Camera view appears in infotainment screen • Rear bumper and one-metre grid lines shown as reference points									
 See what's behind you on the central screen					○	○	○	175.00	210.00
FlexRide adaptive chassis control system with continuous damping control					○	○	○	666.67	800.00

● = Standard equipment. ○ = Optional at extra cost.

NEW ZAFIRA TOURER FEATURES/OPTIONS

	Design	Energy	SRi	SE	Tech Line	Elite	Price (£) exc. VAT	Total (£) inc. VAT
SECURITY								
Standard security features <ul style="list-style-type: none"> • 'Key left in ignition' audible warning • Electronically protected audio equipment • Engine deadlock immobiliser • Visible Vehicle Identification Number (VIN) • Locking wheel bolts for alloy wheels • Freewheeling door locks 	●	●	●	●	●	●		
Remote control central locking <ul style="list-style-type: none"> • Operates on doors, tailgate and fuel filler flap • Deadlocking • Central locking activation switch on facia • One folding key/one static key each with integral remote control function 	●	●	●	●	●	●		
Remote control ultrasonic security alarm system <ul style="list-style-type: none"> • Remote control (operates in conjunction with central locking) • Ultrasonic interior sensors • Tilt sensor • Thatcham approved 	○	○	●	●	●	●	216.67	260.00

DRIVER INFORMATION

Instrumentation <ul style="list-style-type: none"> • Speedometer • Rev counter • Fuel gauge with low fuel level warning light • Water temperature gauge with warning light • Shift-up/down indication light – <i>Indicates when to change gear for optimum fuel economy</i> 	●	●	●	●	●	●		
Driver information display (centrally located in instrument cluster) <ul style="list-style-type: none"> • Monochrome display • Displays trip computer data • Total mileage • Service-due indicator • Oil life • Tyre pressure monitoring system 	●	●	●	●	●	●		
Multi-function trip computer (displayed on driver information display) <ul style="list-style-type: none"> • Trip mileage • Vehicle range based on remaining fuel • Average speed • Average fuel economy • Instantaneous fuel economy • Driving time 	●	●	●	●	●	●		
Central facia display (format dependent on infotainment unit) <ul style="list-style-type: none"> • Audio information • Digital clock with automatic RDS time adjustment • Outside air temperature with ice warning function • Additional features dependent on infotainment unit (see infotainment for details) 	●	●	●	●	●	●		

● = Standard equipment. ○ = Optional at extra cost.

NEW ZAFIRA TOURER FEATURES/OPTIONS

	Design	Energy	SRI	SE	Tech Line	Elite	Price (£) exc. VAT	Total (£) inc. VAT
INTERIOR STYLING Design / Energy interior décor <i>Steering wheel:</i> • Three-spoke design • Satin chrome-effect bezel <i>Facia and door trim:</i> • Black facia with Silver trim inserts • Black door panels with black Atlantis cloth inserts • Blasted Silver trim inserts on front doors • Chrome-effect interior door handles <i>Seat trim:</i> • Mando fabric seat trim inserts • Dark Pewter stitching • Plain black fabric side bolsters and surrounds	●	●						
SE / Tech Line interior décor <i>Steering wheel:</i> • Three-spoke design • Leather-covered with accent stitching • Satin chrome-effect bezel <i>Facia and door trim:</i> • Black facia with Ruthenium trim inserts • Plain black door panels with black Siena cloth inserts • Ruthenium trim inserts on front doors • Chrome-effect interior door handles <i>Seat trim:</i> • Lilop fabric seat trim inserts • Two-tone stitching in Shadow Grey and Rust • Plain black Morrocana-trimmed side bolsters				●	●			
SE / Tech Line interior décor <i>Steering wheel:</i> • Three-spoke design • Leather-covered with accent stitching • Satin chrome-effect bezel <i>Facia and door trim:</i> • Black facia with Ruthenium trim inserts • Light neutral door panels with black Siena cloth inserts • Ruthenium trim inserts on front doors • Chrome-effect interior door handles <i>Seat trim:</i> • Lilop fabric seat trim inserts • Two-tone stitching in Shadow Grey and Ceramic White • Light neutral Morrocana-trimmed side bolsters				N/C	N/C			No-cost option
SRI interior décor <i>Steering wheel:</i> • Three-spoke design • Leather-covered with accent stitching • Satin chrome-effect bezel <i>Facia and door trim:</i> • Black facia with Silver trim inserts • Silver air vent surrounds • Black door panels with black Atlantis cloth inserts • Blasted Silver trim inserts on front doors • Chrome-effect interior door handles <i>Seat trim:</i> • Lace fabric seat trim inserts • Star Silver stitching • Plain black fabric side bolsters and surrounds			●					
Elite interior décor <i>Steering wheel:</i> • Three-spoke design • Leather-covered with accent stitching • Satin chrome-effect bezel <i>Facia and door trim:</i> • Black facia with Ruthenium trim inserts • Silver air vent surrounds • Black door panels with black Leather-effect inserts • Ruthenium trim inserts on front doors • Chrome-effect interior door handles <i>Seat trim:</i> • Black Siena leather seat trim inserts • Star Silver stitching • Black leather-effect side bolsters and surrounds						●		

● = Standard equipment. N/C = No-cost option.

NEW ZAFIRA TOURER FEATURES/OPTIONS

	Design	Energy	SRI	SE	Tech Line	Elite	Price (£) exc. VAT	Total (£) inc. VAT
SEATING AND COMFORT								
Flex7 [®] seating system	●	●	●	●	●	●		
Comfort front seats <i>Driver's seat (eight-way adjustable):</i> • Height (up/down) • Reach (fore/aft) • Backrest recline (upright/incline) • Head restraint (up/down) <i>Front passenger's seat (six-way adjustable):</i> • Reach (fore/aft) • Backrest (upright/recline) • Head restraint (up/down)	●	●		●	●			
Sports-style front seats <i>Driver's seat (eight-way adjustable):</i> • Height (up/down) • Reach (fore/aft) • Backrest recline (upright/incline) • Head restraint (up/down) <i>Front passenger's seat (six-way adjustable):</i> • Reach (fore/aft) • Backrest (upright/recline) • Head restraint (up/down)			●					
Ergonomic driver's sport style seat (AGR-approved*) with sports-style front passenger seat (on SE and Tech Line models standard trim changes to Lace Cloth) <i>Driver's seat (16-way adjustable):</i> • Height (up/down) • Reach (fore/aft) • Tilt (fore/aft) • Backrest (upright/recline) • Seat cushion extension (fore/aft) • Lumbar adjustment (four-way electrical) • Head restraint (up/down) <i>Front passenger's seat (eight-way adjustable):</i> • Reach (fore/aft) • Backrest (upright/recline) • Head restraint (up/down) • Seat cushion extension (fore/aft)			◻	○	○	●	400.00	480.00
Ergonomic driver's and front passenger's seat pack (standard with optional Light Neutral seat trim) <i>Drivers and front passenger's seats (18-way adjustable):</i> • Height (up/down) • Reach (fore/aft) • Tilt (fore/aft) • Backrest (upright/recline) • Seat cushion extension (fore/aft) • Lumbar adjustment (four-way electrical) • Active head restraint (fore/aft/up/down)				●	●			
Leather Pack • Leather seat facings (front and second row seats) with Morrocana trimmed side bolsters • Heated front seats <i>Driver's seat (16-way adjustable):</i> • Height (up/down) • Reach (fore/aft) • Tilt (fore/aft) • Backrest (upright/recline) • Seat cushion extension (fore/aft) • Lumbar adjustment (four-way electrical) • Head restraint (up/down) <i>Front passenger's seat (eight-way adjustable):</i> • Reach (fore/aft) • Backrest (upright/recline) • Head restraint (up/down) • Seat cushion extension (fore/aft)			○			●	883.33	1060.00
Seat Comfort Pack One • Driver's seat with four-way electrical lumbar adjustment and manual cushion extension	○	○	●	○	○	●	150.00	180.00
Seat Comfort Pack Two (on SE models the front passenger's underseat storage facility is deleted) • Driver's and front passenger's seat with four-way electrical lumbar adjustment and manual cushion extension	○	○		○	○		275.00	330.00
Rear seating • Height-adjustable and removable head restraints (second and third row seats) • 35/30/35 split-folding second-row seats • Second-row seats with sliding function plus fold-flat facility • Two individual fold flat third-row seats (height restrictions apply – When all seats are occupied within the New Zafira Tourer passenger side third-row seat is only usable by a passenger up to a maximum height of 150cm.) • Storage pockets on front seat backs • ISOFIX child seat mountings incorporating top tether anchor points located on outer rear seats (does not include child seat) – <i>Allows ISOFIX child safety seats to be securely fixed into the car. The ISOFIX mounting system reduces forward movement in an accident and makes the child seat easier to install.</i> • <i>Child-proof locks on rear doors.</i>	●	●	●	●	●	●		
• Front passenger's underseat storage facility				●	●	●		
• Lounge seating – <i>three individual second-row seats with the ability to convert into two 'captain' seats with individual centre armrest.</i>				●	●	●		

● = Standard equipment. ○ = Optional at extra cost. ◻ = Available as part of an extra-cost option pack. * AGR (The Campaign for Healthier Backs) is an independent centre of excellence for ergonomics, based in Germany.







NEW ZAFIRA TOURER FEATURES/OPTIONS

INFOTAINMENT	<i>Design</i>	<i>Energy</i>	<i>SRI</i>	<i>SE</i>	<i>Tech Line</i>	<i>Elite</i>	Price (£) exc. VAT	Total (£) inc. VAT
<p>R4.0 IntelliLink touchscreen infotainment system <i>For use with MP3 players, USB memory sticks, mobile phones and smartphone apps</i></p> <p>Onboard features:</p> <ul style="list-style-type: none"> • 7-inch colour touchscreen • DAB digital radio/AM/FM stereo radio with 36 station presets • RDS with Traffic Programme <p>Media connections:</p> <ul style="list-style-type: none"> • USB connection with iPod control • Bluetooth® A2DP audio streaming (Advanced Audio Distribution Profile) <p>Mobile phone portal:</p> <ul style="list-style-type: none"> • Bluetooth® connectivity • Handsfree calls via steering wheel controls • Vehicle microphone • Phone book access – <i>Contacts/last calls/missed calls etc. are mirrored on IntelliLink's display and are easily navigated using the touchscreen (features dependent on mobile phone).</i> <p>Smartphone interface:</p> <ul style="list-style-type: none"> • Apple CarPlay™ • Android Auto™ – <i>Smartphone projection that allows operations via voice command, touchscreen and buttons to control apps and music playback.</i> 	●		● ¹	●		● ¹		
<p>Navi 950 IntelliLink touchscreen navigation and infotainment system <i>For use with MP3 players, USB memory sticks, mobile phones and smartphone apps</i></p> <p>Onboard features:</p> <ul style="list-style-type: none"> • 7-inch colour touchscreen • DAB digital radio/AM/FM stereo radio with 36 station presets • RDS with Traffic Programme • 60 configurable favourites including contacts, addresses, playlists, radio stations and voice recognition <p>Navigation features:</p> <ul style="list-style-type: none"> • Satellite navigation system • 3D street level mapping • European coverage <p>Media connections:</p> <ul style="list-style-type: none"> • USB connection with iPod control • Bluetooth® A2DP audio streaming (Advanced Audio Distribution Profile) <p>Mobile phone portal:</p> <ul style="list-style-type: none"> • Bluetooth® connectivity • Handsfree calls via steering wheel controls • Vehicle microphone • Phone book access – <i>Contacts/last calls/missed calls etc. are mirrored on IntelliLink's display and are easily navigated using the touchscreen (features dependent on mobile phone).</i> 	○	●	▲	○	●	▲	591.67	710.00
Six speakers (four front, two rear)	●	●	●	●	●	●		
Steering wheel mounted audio controls	●	●	●	●	●	●		

● = Standard equipment. ○ = Optional at extra cost. ▲ = Standard on Nav models, see pricing pages for details.

¹ = Standard on non Nav models.

NEW ZAFIRA TOURER FEATURES/OPTIONS

INFOTAINMENT						Design	Energy	SRi	SE	Tech Line	Elite	Price (£) exc. VAT	Total (£) inc. VAT
													
Automatic Crash Response	Wi-Fi Hotspot	Smartphone App	Stolen Vehicle Assistance	Vehicle Diagnostics	Destination Download								
<p>Vauxhall OnStar – your personal on board assistant</p> <p><i>Many car brands talk about innovation as soon as they improve their cup holders but this innovative system, now available on selected models**, is revolutionary: 24/7, 365 days a year, Vauxhall OnStar puts you in touch with a trained advisor, not a machine. With OnStar you have access to a host of innovations, from Vehicle Diagnostics and Smartphone Function to a fully integrated 4G Wi-Fi Hotspot†. In the event of an accident, Vauxhall OnStar even automatically calls for help, for an incomparable feeling of safety.</i></p> <p>* = Includes 12 months of OnStar services from date of first registration and a 3 month/3 GB Wi-Fi free trial period (whichever comes first) effective from the date the customer accepts the nominated network operator Wi-Fi Ts&Cs. Destination download feature only operates on models fitted with Navi 950 IntelliLink satellite navigation system. Theft alert feature only operates on models fitted with security alarm system.</p> <p>** = The OnStar Services require activation and are subject to mobile network coverage and availability. Wi-Fi Hotspot service requires account with nominated network operator.</p> <p>† = 4G is subject to mobile network coverage and availability. Charges apply after the free trial period. The OnStar subscription packages could be different from the services included in the free trial package. Check www.vauxhall.co.uk/onstar for terms and conditions, details of availability, coverage and charges.</p>						●	●	●	●	●	●		
<p></p>													

● = Standard equipment.

NEW ZAFIRA TOURER FEATURES/OPTIONS

	Design	Energy	SRI	SE	Tech Line	Elite	Price (£) exc. VAT	Total (£) inc. VAT
HEATING AND VENTILATION								
Air conditioning <ul style="list-style-type: none"> • Air recirculation facility • Cabin particulate filter – <i>Removes dust, airborne particles and pollen</i> • Multi-speed fan • Illuminated controls 	●	●	●					
Electronic climate control including air conditioning <ul style="list-style-type: none"> • Dual-zone control – <i>Allowing different, temperature settings for driver and front passenger.</i> • Advanced predictive logic control system using sun and humidity sensors • Partial air recirculation – <i>Faster warm up/cool down.</i> • Cabin particulate filter – <i>Removes dust, airborne particles and pollen.</i> • Automatic air direction and fan speed with manual override • LCD temperature display • Illuminated controls • Rear floor heating ducts <div style="display: flex; justify-content: space-between;"> <div style="background-color: #e0e0e0; padding: 2px;">✔ Set and forget temperature control</div> <div style="background-color: #e0e0e0; padding: 2px;">✔ Set different temperatures for driver and front passenger</div> </div>			○	●	●	●	337.50	405.00
Additional features <ul style="list-style-type: none"> • Four adjustable facia vents • Windscreen demist vents • Side window demist vents • Heated rear screen with timed cut-off 	●	●	●	●	●	●		
Heated leather-covered steering wheel – only available with optional Leather Pack			○	□	□	○	91.67	110.00
Winter Pack – only available with standard seat trim on SRI models <ul style="list-style-type: none"> • Heated leather-covered steering wheel • Heated front seats (standard on Elite/Elite Nav models) <div style="display: flex; align-items: center;"> <div style="background-color: #e0e0e0; padding: 2px; margin-right: 10px;">✔ Warm welcome</div> <div style="margin-left: 20px;">  </div> </div>			○	○	○		304.17	365.00

● = Standard equipment. ○ = Optional at extra cost. □ = Available as part of an extra-cost option pack.

NEW ZAFIRA TOURER FEATURES/OPTIONS

	Design	Energy	SRI	SE	Tech Line	Elite	Price (£) exc. VAT	Total (£) inc. VAT
INTERIOR CONVENIENCE / LIGHTING								
Convenience features • 12-volt electrical accessory socket within front and rear centre console • Driver's and front passenger's sunvisors incorporating illuminated vanity mirrors with covers • Dipping rear-view mirror	●	●	●	●	●	●		
12-volt electrical accessory socket within luggage compartment	□	□	□	□	□	□		
Automatically dimming anti-dazzle rear-view mirror			□	●	●	●		
Central storage facility with two cupholders and front centre armrest	●	●	●					
FlexRail® centre console system featuring aluminium rails, sliding tray/cup holder and front centre armrest				●	●	●		
Rear side window sunblinds	○	○	○	○	○	○	91.67	110.00
Standard lighting • Central front courtesy light • Central rear courtesy light • Fade up/fade down	●	●	●	●	●	●		
Premium lighting • First and second row reading lights with illuminated switches • Third row passenger compartment reading lights • Ambient LED fascia/centre console downlighter • Driver's and front passenger's vanity mirrors with covers • Illuminated glove box and luggage area • Ambient LED lighting in fascia and front doors	●	●	●	●	●	●		
Interior storage • Storage box on driver's side lower fascia • Glovebox with lid • Front door pockets • Third row central storage facility with two cup holders • Rear door pockets • Storage pockets on front seat backs	●	●	●	●	●	●		
Loading Pack • Vertical load restraining net • FlexCover interior protection liner • 12-volt electrical accessory socket within luggage compartment	○	○	○	○	○	○	104.17	125.00
Luggage area • Luggage compartment cover • Illuminated load area • Fully carpeted load area • Interior tailgate handle • Four load restraint lashing eyes • Twin gas-assisted tailgate struts	●	●	●	●	●	●		
FlexOrganiser® Pack • FlexOrganiser® rails • Restraint net with two bars • Small luggage restraint net • Adaptors	○	○	○	○	○	○	133.33	160.00

● = Standard equipment. ○ = Optional at extra cost. □ = Available as part of an extra-cost option pack.

NEW ZAFIRA TOURER FEATURES/OPTIONS

	Design	Energy	SRI	SE	Tech Line	Elite	Price (£) exc. VAT	Total (£) inc. VAT
EXTERIOR LIGHTING								
Standard lighting features								
<ul style="list-style-type: none"> LED daytime running lights Ellipsoid headlights Side repeat indicators Lights-on audible warning Electric headlight beam levelling High-level LED centre rear brake light Rear fog light Reversing light Hazard warning lights Door-to-door illumination Dark-style tail lights 	●	●	●	●	●	●		
<ul style="list-style-type: none"> Automatic lighting control with tunnel detection and digital high beam assist 			□	●	●	●		
Dark-style headlights			●					
Chrome-effect headlights	●	●		●	●	●		
Premium Forward Lighting Pack								
<ul style="list-style-type: none"> Intelligent Adaptive Forward Lighting (AFL) LED headlights with dynamic beam levelling LED daytime running lights LED tail lights 				○	○	○	750.00	900.00
Sight and Light Pack								
<ul style="list-style-type: none"> Automatic lighting control with tunnel detection Rain-sensitive windscreen wipers Electro-chromatic anti-dazzle rear-view mirror Digital high beam assist 			○	●	●	●	200.00	240.00
Front fog lights		●	●	●	●	●		
LED tail lights			□	□	□	□		













● = Standard equipment. ○ = Optional at extra cost. □ = Available as part of an extra-cost option pack.

NEW ZAFIRA TOURER FEATURES/OPTIONS

	Design	Energy	SRI	SE	Tech Line	Elite	Price (£) exc. VAT	Total (£) inc. VAT
EXTERIOR CONVENIENCE / STYLING								
Windscreen wipers • Two-speed windscreen wipers with variable intermittent wipe • Intermittent rear window wash/wipe	●	●	●	●	●	●		
• Rain-sensitive windscreen wipers			□	●	●	●		
Door mirrors • Twin electrically adjustable/heated door mirrors • Manually folding door mirrors	●	●	●	●	●	●		
• Electrically foldable door mirrors	□	□	□	□	□	□		
Windows • Electrically operated front and rear windows with safety autoreverse and one-touch facility • Heated rear window	●	●	●	●	●	●		
Electro Pack • Electrically foldable door mirrors • 12-volt electrical accessory socket within luggage compartment	○	○	○	○	○	○	141.67	170.00
Panoramic windscreen and panoramic sunroof (requires optional electronic climate control, deletes silver-effect roof rails) • Electrically operated interior sunblind			○	○	○	●	508.33	610.00
Roof rails • Black	●							
• Silver-effect		●	●	●	●			
Flex-Fix® integrated carrier system (includes two-bicycle carrier attachments) – Not available in conjunction with emergency spare wheel, Towing Pack and VXR Styling Pack. Please note, bicycle size restrictions apply, please contact your local Retailer for further information.			○	○	○	○	758.33	910.00
Towing Pack • Detachable tow bar • Trailer stability programme integrated into ESP system	○	○	○	○	○	○	591.67	710.00
Body styling • Chrome-effect front grille bar • Chrome-effect headlight detail • Body-colour door handles • Body-colour door mirrors	●	●	●	●	●	●		
• Black trim on door pillars								
• Body-colour rear roof spoiler			●					
• Chrome-effect lower window surround		●		●	●	●		
• Visible stainless steel exhaust tailpipe (2.0CDTi (170PS) engines only) – Deleted if optional Flex-Fix® integrated carrier system is specified.	●	●	●	●	●	●		
VXR Styling Pack (Only available in conjunction with Navi 950 audio unit. Not available in conjunction with optional Flex-Fix® integrated carrier system or Royal Blue exterior colour) • Body-colour front lower spoiler, side sills, rear lower skirt and rear roof spoiler	○	○	○	○	○	○	791.67	950.00
Windows • Solar heat-absorbing windscreen • Tinted windows	●	●	●	●	●	●		
• Dark-tinted rear windows		●	●	●	●	●		

● = Standard equipment. ○ = Optional at extra cost. □ = Available as part of an extra-cost option pack.

NEW ZAFIRA TOURER FEATURES/OPTIONS

EXTERIOR COLOURS		Design	Energy	SRi	SE	Tech Line	Elite	Price (£) exc. VAT	Total (£) inc. VAT
	Royal Blue* <ul style="list-style-type: none"> • Solid paint • Folding key with Grey insert 	●	●	●	●	●	●		
	Summit White* <ul style="list-style-type: none"> • Brilliant paint • Folding key with White insert 	○	○	○	○	○	○	237.50	285.00
	Lava Red* <ul style="list-style-type: none"> • Brilliant paint • Folding key with Red insert 								
	Sovereign Silver* <ul style="list-style-type: none"> • Two-coat metallic paint • Folding key with Grey insert 								
	Satin Steel Grey* <ul style="list-style-type: none"> • Two-coat metallic paint • Folding key with Red insert 								
	Dark Caramel* <ul style="list-style-type: none"> • Two-coat metallic paint • Folding key with Black insert 								
	Mineral Black <ul style="list-style-type: none"> • Two-coat metallic paint • Folding key with Black insert 								
	Flip Chip Silver* <ul style="list-style-type: none"> • Two-coat metallic paint • Folding key with White insert 	○	○	○	○	○	○	462.50	555.00
	Cosmic Grey* <ul style="list-style-type: none"> • Two-coat metallic paint • Folding key with Grey insert 								
	Dark Sea Blue* <ul style="list-style-type: none"> • Two-coat pearlescent paint • Folding key with Grey insert 								
	Macadamia <ul style="list-style-type: none"> • Two-coat pearlescent paint • Folding key with Black insert 								
	Emerald Green <ul style="list-style-type: none"> • Two-coat pearlescent paint • Folding key with Black insert 								

● = Standard equipment. ○ = Optional at extra cost. * = Not available on SE and Tech Line models with Lilop Light Neutral cloth seat trim.

The colours reproduced may vary slightly from the actual paint colour. As a result they should be used as a guide only. Your Vauxhall Retailer has a comprehensive display of our paint samples.



NEW ZAFIRA TOURER FEATURES/OPTIONS

WHEELS AND TYRES		<i>Design</i>	<i>Energy</i>	<i>SRI</i>	<i>SE</i>	<i>Tech Line</i>	<i>Elite</i>	Price (£) exc. VAT	Total (£) inc. VAT
Emergency spare wheel (in lieu of emergency tyre inflation kit)		○	○	○	○	○	○	91.67	110.00
	17-inch 10-spoke alloy wheels • 225/50 R 17 tyres • Emergency tyre inflation kit (in lieu of spare wheel)	●	●		●	●			
	17-inch 10-spoke alloy wheels (1.6CDTi (134PS) S/S ecoFLEX only) • 225/50 R 17 tyres • Emergency tyre inflation kit (in lieu of spare wheel)			●					
	18-inch 5-twin spoke alloy wheels (1.4i Turbo/2.0CDTi) • 235/45 R 18 tyres • Emergency tyre inflation kit (in lieu of spare wheel)			●					
	18-inch 5-twin spoke alloy wheels (1.6CDTi (134PS) S/S only) • 235/45 R 18 tyres • Emergency tyre inflation kit (in lieu of spare wheel)			○				91.67	110.00
	18-inch 10-spoke alloy wheels • 235/45 R 18 tyres • Emergency tyre inflation kit (in lieu of spare wheel)				○	○	●	300.00	360.00

● = Standard equipment. ○ = Optional at extra cost.



NEW ZAFIRA TOURER FEATURES/OPTIONS

WHEELS AND TYRES

		Design	Energy	SRI	SE	Tech Line	Elite	Price (£) exc. VAT	Total (£) inc. VAT
	19-inch 5-spoke bi-colour alloy wheels <ul style="list-style-type: none"> • 235/40 R 19 tyres • Emergency tyre inflation kit (in lieu of spare wheel) 			○			○	375.00	450.00
	19-inch multispoke alloy wheels <ul style="list-style-type: none"> • 235/40 R 19 tyres • Emergency tyre inflation kit (in lieu of spare wheel) 				○	○		591.67	710.00

○ = Optional at extra cost.

TYRE RATING

Tyre size	Fuel efficiency group	Wet grip performance	External noise	
			Measured (dB)	Group
225/50 R 17	B-E	B-C	68-71	
235/45 R 18	E	B	71	
235/40 R 19	E	B	71	

Tyre rating according to EU Regulation 1222/2009

NEW ZAFIRA TOURER SPECIFICATIONS

PETROL ENGINE

	1.4i Turbo (140PS) ECOTEC-4
Capacity	1364cc
Maximum power	140PS (103kW) @ 4900-6000rpm
Maximum torque	200Nm (147 lb.ft.) @ 1850-4900rpm
Configuration	4 cylinders, 4 valves per cylinder, double overhead camshafts
Fuel/induction system	Water-cooled turbocharger with intercooler. Variable Valve Timing (VVT). Multi-point sequential fuel injection
Emission compliance	Euro 6
Service interval	20,000 miles or 1 year (whichever occurs sooner)

DIESEL ENGINES

	1.6CDTi (134PS) ECOTEC-4 Turbo diesel	2.0CDTi (170PS) ECOTEC-4 Turbo diesel
Capacity	1598cc	1956cc
Maximum power	134PS (99kW) @ 3500-4000rpm	170PS (125kW) @ 3750rpm
Maximum torque	320Nm (236 lb.ft.) @ 2000rpm	400Nm (295 lb.ft.) @ 1750-2500rpm
Configuration	4 cylinders, 4 valves per cylinder, double overhead camshafts	4 cylinders, 4 valves per cylinder, double overhead camshafts
Fuel/induction system	Variable geometry turbocharger with intercooler. Common rail fuel injection	Turbocharger with intercooler. Common rail fuel injection
Emission compliance	Euro 6	Euro 6
Service interval	20,000 miles or 1 year (whichever occurs sooner)	20,000 miles or 1 year (whichever occurs sooner)

NEW ZAFIRA TOURER SPECIFICATIONS

PERFORMANCE, FUEL ECONOMY AND EMISSIONS

	Wheel size (inches)	Performance (manufacturer's figures)		Urban driving	Fuel economy mpg (litres/100km)#		CO ₂ emissions g/km#	Vehicle Excise Duty*		Benefit in kind company car taxation rates – 2017/18 tax year
		Maximum speed (mph)	Acceleration 0-60mph (sec)		Extra-urban driving	Combined figure		First year rate	Standard rate	
Manual										
1.4i Turbo (140PS)	17/18/19	124	9.9	33.2 (8.5)	49.6 (5.7)	44.1 (6.8)	156	£500	£140	30%
1.6CDTi (134PS) Start/Stop ecoFLEX	17	120	10.4	53.3 (5.3)	70.6 (4.0)	62.8 (4.5)	119	£160	£140	25%
1.6CDTi (134PS) Start/Stop	18/19	120	10.4	50.4 (5.6)	67.3 (4.2)	60.1 (4.7)	125	£160	£140	27%
2.0CDTi (170PS) Start/Stop	17	129	9.1	47.1 (6.0)	67.3 (4.2)	57.7 (4.9)	129	£160	£140	27%
2.0CDTi (170PS) Start/Stop	18/19	129	9.1	44.1 (6.4)	62.8 (4.5)	54.3 (5.2)	137	£200	£140	29%
Automatic										
1.4i Turbo (140PS)	17/18/19	122	10.2	30.4 (9.3)	50.4 (5.6)	40.9 (6.9)	160	£500	£140	31%
2.0CDTi (170PS)	17/18/19	127	9.3	34.4 (8.2)	58.9 (4.8)	46.3 (6.1)	161	£500	£140	34%

* = Correct at time of publication.

= Fuel consumption information is official government environmental data, tested in accordance with the relevant EU directive. Official EU-regulated test data is provided for comparison purposes and actual performance will depend on driving style, road conditions and other non-technical factors.

OPTIONAL TRANSMISSION

Six-speed automatic transmission with ActiveSelect® function

A six-speed automatic transmission is optional on 1.4i Turbo (140PS) and 2.0CDTi (170PS) models. On the road, a wide selection of shift patterns is adapted to the style and habits of the driver, anticipating when maximum acceleration or maximum efficiency is required. The electronic control will also adapt to the prevailing road conditions, reducing gear shifting when climbing or descending and using engine braking assistance during down changes. The ActiveSelect® manual mode allows the gear lever to be used like a sequential manual gearbox – you simply push the lever forward or back to change up or down the gears. The driver also benefits from a 'neutral' gear disengagement at idle, which reduces vibration and contributes to improved fuel consumption.

STEERING

- Power-assisted steering
- Turning circle (kerb-to-kerb): – 11.40m (37.4ft.)

SUSPENSION

Front: Independent. Lightweight MacPherson struts with gas-pressure dampers and coil springs. Anti-roll bar.

Rear: Lightweight compound crank rear axle with one-piece, hollow cast trailing arms. Built-in anti-roll bar. Progressive-rate double conical mini-block springs with gas-pressure dampers.

BRAKES

- Anti-lock Braking System (ABS)
- Electronic brakeforce distribution
- Hydraulic brake fade assist
- Cornering brake control
- Emergency brake assist
- Hill start assist
- Electric parking brake (standard on SE, Tech Line and Elite models only)

BODY

Aerodynamic drag co-efficient: – Cd 0.32.

FUEL TANK CAPACITY

58 litres (12.8 gallons)

NEW ZAFIRA TOURER SPECIFICATIONS

EXTERIOR DIMENSIONS millimetres (inches)

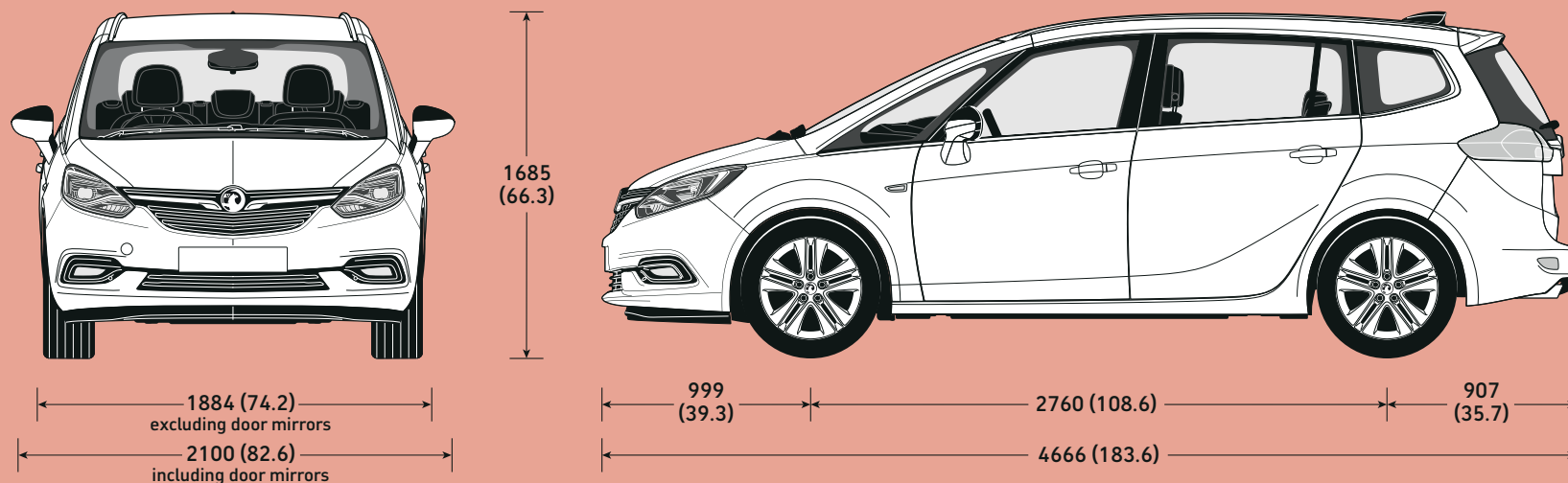

WEIGHTS AND TOWING DATA kg

	Gross vehicle weight	Max. towing weights Trailer with brakes (without brakes)
1.4i Turbo (140PS)	2310	1300 (750)
1.4i Turbo (140PS) automatic	2340	1550 (750)
1.6CDTi (134PS) Start/Stop ecoFLEX	2380	1450 (750)
2.0CDTi (170PS) Start/Stop	2455	1650 (750)
2.0CDTi (170PS) automatic	2470	1650 (750)

Gross vehicle weight is the total permissible weight of the vehicle including passengers and their luggage. The maximum roof rack loading should not exceed 100kg. The maximum towing weights are based on the ability of the car, with two occupants of 75kg each, to restart on a 12% gradient, which is approximately 1 in 8.3, at sea level. The permitted trailer load applies up to the specified incline and up to an altitude of 1000 metres above sea level. The permissible gross train weight decreases by 10% for every 1000 metres of additional altitude. Any extra weight, such as luggage or additional passengers, should be deducted from the maximum towing weight. With a trailer fully loaded, maximum noseweight should not exceed 75kg. Always fit Vauxhall towing attachments and accessories available from your Vauxhall Retailer. They are designed specifically for Vauxhall models and carry a 12-month guarantee. During trailer towing do not exceed a maximum speed of 60mph. This speed limit is also applicable in countries with higher permitted speeds for trailer-vehicle combinations. Pay attention to the local speed limits. For trailers with low driving stability and caravans the use of an oscillation damper is strongly recommended.

LOADSPACE DIMENSIONS millimetres (inches)

Maximum floor length – behind front seats, second-row and third-row seats folded	1842 (72.5)
Maximum floor length – behind second-row seats	1093 (43.0)
Width between wheel arches	1057 (41.6)
Tailgate aperture height	840 (33.0)
Tailgate aperture lower width	1045 (41.1)

LOADSPACE CAPACITIES measured using the ECIE method

	litres (cu.ft.)
Behind third-row seats, to glass line	152 (5.4)
Behind second-row seats, to glass line	710 (25.1)
Behind front seats, to roof	1860 (65.6)

NEW ZAFIRA TOURER ACCESSORIES

	Total (inc. VAT)
INFOTAINMENT	
Sat Nav updates¹	
Please consult your Retailer for latest map updates or visit www.vauxhall.co.uk/accessories .	
1 = For use with optional factory-fit satellite navigation systems.	
CHILD SEATS²	
BABY-SAFE ³ – 0-13kg/birth to 15 months	£132.00
– ISOFIX base	£227.00
DUO ISOFIX ³ – 9-18kg/9 months to 4 years	
with top tether kit	£347.00
KID ³ – 15-36kg or 4 to 12 years	£157.00
2 = Restrictions apply to the use of child seats, please consult your Vauxhall Retailer or request a copy of the Child seats brochure.	
3 = Without transponder.	
SAFETY	
Safety Pack – first aid kit, warning triangle,	
hi-visibility vest, Vauxhall bag	£35.00
First aid kit	£15.00
Warning triangle	£17.00
Fire extinguisher – 2kg	£37.00
Hi-visibility vest	£9.00
Tyre sealant	£68.00
Tyre inflation compressor	£120.00
Tyre repair kit	£150.00
SECURITY	
Locking wheel nuts – set of four	£39.00

	Total (inc. VAT)
FLEXCONNECT RANGE	
FlexConnect bracket	£20.00
FlexConnect hook	£28.00
FlexConnect coat hanger	£58.00
FlexConnect folding table	£68.00
FlexConnect iPad Mini cradle	£98.00
FlexConnect iPad (1-4) cradle	£106.00
FlexConnect iPad Air cradle	£106.00
FlexConnect Samsung Galaxy cradle	£96.00
PRACTICAL	
Spare bulb kit ⁴	£26.00
Premium spare bulb kit ⁴	£32.00
Privacy shades	
– side windows	£91.00
– rear window	£83.00
Stretch tow rope – up to 3000kg	£34.00
Towing bar – up to 2500kg	£85.00
4 = Excludes xenon headlight bulb for models with Adaptive Forward Lighting (AFL).	
PROTECTION	
Rubber floor mats	
– front and second row	£59.00
Velour floor mats – set of four	£69.00
Mudflaps	
– front	£56.00
– rear	£56.00
Alloy-effect sports pedals	from £113.00
Front door sill plates (single)	£28.00
Cargo net – horizontal	£21.00
Cargo liner	£47.00
Load compartment mat	from £163.00
Storage box	£27.00
Dog guard	£206.00
Load compartment divider rail	£95.00

	Total (inc. VAT)
TRANSPORT SYSTEMS	
Roof base carrier (without roof rails)	£170.00
Roof base carrier (with roof rails)	£166.00
Roof carriers (requires base carrier)	
Bike roof carrier – Thule Freeride 532	£76.00
Surf board roof carrier – Thule 833	£101.00
Kayak roof carrier – Thule 837	£168.00
Ski roof carrier (400mm wide)	
– Thule Deluxe 726	£138.00
Ski roof carrier (600mm wide)	
– Thule 739	£235.00
Hard shell roof boxes (requires base carrier)	
Thule Ocean 80	
(320 litre / 1330 x 860 x 370mm)	£235.00
Thule Ocean 200	
(390 litre / 1750 x 820 x 450mm)	£316.00
Thule Dynamic M	
(320 litre / 2060 x 840 x 340mm)	from £625.00
Thule Dynamic L	
(430 litre / 2350 x 940 x 350mm)	£846.00
Thule Excellence	
(520 litre / 2180 x 940 x 400mm)	£898.00
Thule Motion 800	
(460 litre / 2050 x 840 x 450mm)	from £515.00
Thule Touring 200	
(400 litre / 1750 x 820 x 450mm)	£372.00
Thule Touring 780	
(430 litre / 2320 x 700 x 420mm)	£460.00
Soft roof boxes (requires base carrier)	
Thule Ranger 90	
(280 litre / 1100 x 800 x 400mm)	£285.00
Thule Ranger 500	
(300 litre / 1900 x 500 x 300mm)	£378.00
Tailgate carrier	
Bike tailgate carrier – Thule BacPac 973	£282.00
Fitting kit	£48.00

	Total (inc. VAT)
Tow bar carrier system	
Fixed tow bar	
– 13-pin electrics	£638.00
Detachable tow bar	
– 13-pin electrics	£659.00
STYLING	
VX-Line styling pack • Front lower spoiler	
• Rear lower skirt • Rear roof spoiler	
• Side sills	from £1908.00
VX-Line rear roof spoiler ⁵	£642.00

5 = Not suitable for SRi models. Requires additional aerial adaptor of extra cost. Please consult you Retailer for details.

	Total (inc. VAT)
ALLOY WHEELS (set of four with centre caps)⁶	
17-inch 7-spoke	£617.00
18-inch 5-double spoke	£674.00
18-inch 5-spoke	£970.00
18-inch 10-spoke	£1016.00
19-inch 10-spoke	£1373.00
Other designs available	

6 = Different tyres and locking wheel bolts/nuts may be required at extra cost. Price excludes new tyres and locking wheel bolts/nuts, includes static wheel balancing.

Please note:

Prices shown are a fully fitted and painted, where applicable and include VAT. Please check with your local Vauxhall Retailer for details. It is advisable to ensure your insurance policy is adequate to cover additional fitted accessories. Prices correct at time of publication.

NEW ZAFIRA TOURER OFFERS IN DETAIL – TERMS AND CONDITIONS

Unless otherwise stated, all offers described are available on orders or registrations between 1 April 2017 – 3 July 2017. Offer prices quoted are correct at the time of publication (April 2017). Prices are subject to change. In line with Vauxhall's policy of price transparency, the offer price shown is an on-the-road price including VAT on cars (excluding VAT on Commercial Vehicles), number plates and delivery to Retailer of £700.00 (£583.33 excluding VAT), 12 months' Government Vehicle Excise Duty (variable depending upon model – refer to the individual model price guides online) and the DVLA's new vehicle first registration fee of £55.00. Excludes fuel and insurance. Offers may not apply to Retailer stocks and are subject to availability. Restrictions may apply. Contact your Retailer for details. Vauxhall Motors Limited reserves the right to change, amend or withdraw these offers at any point in time.

FLEXIBLE FINANCE

Available on selected models only, at participating Retailers. Conditional sale. Finance subject to status. Terms and Conditions apply. Applicants must be 18+. Finance supplied by Vauxhall Finance, CF15 7YT. Vauxhall Deposit Contributions vary and exclude certain models and are only available when vehicle is financed through Vauxhall Finance. 24-48 month term. Offer will apply to private individuals, Vauxhall Partners and small businesses 1- 24 units (purchase only, excluding B2B supported units). All other customers are excluded. Refer to www.vauxhall.co.uk/offers or contact your local Vauxhall Retailer for details.

FLEXIBLE PCP

Offer subject to availability at participating Retailers only. Personal Contract Purchase. Finance subject to status. Terms and Conditions apply. Applicants must be 18+. Finance by Vauxhall Finance, CF15 7YT. 24-48 month term available. Vauxhall deposit contribution only available when vehicle financed through Vauxhall Finance. At the end of the agreement there are three options: i) Pay the optional final payment to own the vehicle, ii) Return the vehicle, or iii) Replace: Part Exchange the vehicle, where equity is available. UK-supplied vehicles only. Offer applies to private individuals, Vauxhall Partners and small businesses 1-24 units (purchase only excluding B2B supported units). All other customers are excluded.

PERSONAL CONTRACT HIRE

Personal contract hire offer on vehicles ordered by 3 July 2017, subject to availability and status. Age 18+ only. Figures based on a non-maintenance contract hire package. Excess miles over contracted mileage of 24,000 over 36 months charged at a maximum of 13.16 pence per mile. Excess charges also apply if you breach manufacturer servicing or maintenance guidelines or if the car exceeds BVRLA Fair Wear & Tear guidelines for its age/mileage when it is returned to Vauxhall Leasing. Package includes Road Fund Licence and Vauxhall Assistance. Guarantee/indemnity may be required. Prices and details are subject to change without notice. For full specification and Ts&Cs contact your local Retailer. **You will not own the car.** ALD Automotive Ltd., trading as Vauxhall Leasing, BS16 7LB. Authorised and regulated by the Financial Conduct Authority.

Please note not all offers apply to all models.

NEW ZAFIRA TOURER COMPANY CAR DRIVER/FLEET INFORMATION

DESIGN AND TECH LINE HIGH SPEC, LOW P11D

Specifically developed for businesses and company car drivers alike, our Design and Tech Line models are seriously fit for Fleet.

Design models all feature very low P11D values, generous standard specification with a choice of high tech ecoFLEX engines for great fuel economy and low emissions including the 'whisper diesel' 1.6CDTi (from 88g/km and 85.6mpg combined).

For even more standard specification, step up to our Tech Line range again you are guaranteed low P11D values, plus great standard kit including Sat Nav (in lieu of parking sensors and Winter Pack on Meriva), Bluetooth®, USB connection and digital radio (excluding Meriva).

With Design and Tech Line you can take for granted low Whole Life Costs and low company car driver taxation.

COMPANY CAR DRIVER FREE* 3 DAY TEST DRIVE

Our free* 3 Day Test Drive programme is open to all Company Car Drivers which allows you to choose any model in the current Vauxhall line-up (excluding all VXR models and Commercial Vehicles), with full insurance cover provided, to give you a meaningful length of time to make an informed decision about your next company car.

Click below to book your free* test drive www.vauxhall3dtd.co.uk or call 0330 587 8221**



BENEFIT IN KIND COMPANY CAR TAXATION†

The car benefit charge will be the car's list price (including VAT, options and accessories fitted, delivery to Retailer and number plates, but excluding Vehicle Excise Duty and new vehicle first registration fee) multiplied by the percentage charge for the CO₂ emissions band in which the car falls (see table opposite). Multiply this figure by your personal income tax rate (20% for Basic Rate, 40% for Higher Rate) to calculate your annual benefit in kind tax liability.

Example:

New Zafira Tourer Design 1.6CDTi (134PS) Start/Stop ecoFLEX 5-dr MPV (CO₂ emissions 119g/km)

On-the-road RRP	£22185.00
Deduct: Vehicle Excise Duty	(£160.00)
New vehicle first registration fee	(£55.00)
Effective list price	£21970.00
Add: Optional two-coat metallic paint	£555.00

List price for tax purposes (P11D value)
£22525.00

Car benefit charge
2017-18 tax year (25%) £5631.00

Benefit in kind tax liability (2017-18 tax year)

Basic Rate (20%) tax payer	£1126.20
Higher Rate (40%) tax payer	£2252.40

† = Please note this Price Guide provides taxation information as a guide only. Vauxhall does not provide taxation guidance. Drivers should always take professional advice on their own tax position.

CO ₂ emissions in grams per kilometre	Percentage of car's price to be taxed	
	Petrol 2017-18 tax year	Diesel 2017-18 tax year
up to 50	9	12
51-75	13	16
76-94	17	20
95-99	18	21
100-104	19	22
105-109	20	23
110-114	21	24
115-119	22	25
120-124	23	26
125-129	24	27
130-134	25	28
135-139	26	29
140-144	27	30
145-149	28	31
150-154	29	32
155-159	30	33
160-164	31	34
165-169	32	35
170-174	33	36
175-179	34	37
180-184	35	37
185-189	36	37
190 and above	37	37

To calculate your own personal liability a car tax calculator is available at: <https://www.vauxhallfleet.co.uk/toolbox>

FLEET TOOLBOX

Discover the facts in our online Toolbox for both Company Car Drivers and Fleet Decision Makers. The Fleet Toolbox has a host of useful calculators, comparators, interactive listings and information. Visit the Fleet Toolbox by going to www.vauxhall-toolbox.co.uk



ROADTRIP APP

The Vauxhall RoadTrip App is a free app that calculates and logs your mileage expenses for any UK business trips and generates reports to help you complete your mileage claims. Available for both iPhone and Android, visit www.vauxhall-toolbox.co.uk or visit the iPhone or Android stores and search for Vauxhall RoadTrip to download it to your smartphone or tablet.



CONTACT VAUXHALL FLEET

Please contact one of our dedicated sales teams who will be happy to help with your particular enquiry.

Company Car Drivers

Call: 0345 111 2020
Email: company-car@vauxhallinfo.co.uk

Telephone lines are open
– Monday to Friday 8.00am-9.00pm
– Saturday and Sunday 9.00am-6.00pm

Fleet Decision Makers

Depending on the size of your fleet of vehicles, we have a dedicated team to handle your enquiries. The lines are open Monday to Friday excluding Bank Holidays.

1-24 vehicles

Call: 0845 076 2254 (8.30am-5.00pm)
Email: b2bsales@vauxhall.co.uk

25+ vehicles

Call: 0330 587 8222 (8.30am-5.00pm)
Email: vauxhallfleet@vauxhall.co.uk

Special Vehicles (Police, Fire and Ambulance)

Call: 01582 409999 (8.30am-5.00pm)
Email: vauxhallspecialvehicles@vauxhall.co.uk

*The free 3 Day Test Drive programme is open to Company Car Drivers and excludes fuel and lubricants; congestion charges; parking and speeding fines and the £250 insurance excess (if applicable). It features a wide selection of models from the Vauxhall range (excluding all VXR models and Commercial Vehicles and subject to availability). Drivers must be aged 25 years or over, have held a full driving licence for at least a year and hold a major credit card. You will need to have your driving licence (and proof of identity (i.e. passport) where the driving licence is not a photocard licence) when your car is delivered. While every effort will be made to ensure that at least 3 days are provided for the test drive, this cannot always be guaranteed due to delivery and collection dates and timings. Available for UK Mainland only. Terms and conditions apply. **Telephone lines open Monday-Friday 9.00am to 5.00pm excluding Bank Holidays. Calls may be recorded or monitored for quality and/or training purposes.

NEW ZAFIRA TOURER ADDITIONAL INFORMATION

ON-THE-ROAD PRICES

To eliminate uncertainty about hidden costs when buying a new car, Vauxhall publishes on-the-road recommended retail prices (RRP) and these are shown in the pricing tables within this price guide. These prices include the recommended cost of number plates and delivery to a Vauxhall Retailer of £700.00 (including £116.67 VAT), 12 months' Government Vehicle Excise Duty (see opposite for details) and the DVLA new vehicle first registration fee of £55.00*.

Please note: The on-the-road recommended retail price (RRP) does not include fuel supplied by the Retailer, motor insurance or any other goods or services supplied by agreement between the Retailer and the customer.

PRICE PROTECTION

Order a new Vauxhall for build in the current model year (as confirmed by your Retailer) for delivery no more than three months in advance and the price you are quoted is the price you pay. This is irrespective of any subsequent price rises between placing your order and delivery of your new car, but you must take delivery as soon as the car is available. Vauxhall Motors Limited is not liable for price adjustments caused by Government changes in the rate of VAT (currently 20%), Vehicle Excise Duty, DVLA new vehicle first registration fee or by any other applicable legislation or regulations.

E10 FUEL

E10 fuel is cleared for use in all petrol-engined Vauxhall vehicles excluding models with the 2.2 litre direct injection petrol engine (code Z22YH) used in Vectra, Signum and Zafira models. Owners of these vehicles should continue to use regular unleaded or premium unleaded petrol.

VEHICLE EXCISE DUTY

The amount of Vehicle Excise Duty (road fund licence) payable on new cars varies depending on the level of carbon dioxide (CO₂) emissions produced by the vehicle. CO₂ emissions are measured in grammes (g) per kilometre (km) travelled and divided into 13 charging bands shown in the table below.

A 'first year rate' of Vehicle Excise Duty is payable on all new cars and in subsequent years the amount payable reverts to the 'standard rate'. From 1 April 2017 the breakpoints for each of these bands have been revised. Also, for vehicles with a list price over £40,000, including factory-fitted options, an additional £310 is payable for the first five years of standard rate payments.

Vehicle Excise Duty*

	CO ₂ emissions (g/km)	First year rate	Standard rate
Band A	0	£0.00	£0.00
Band B	1-50	£10.00	£140.00
Band C	51-75	£25.00	£140.00
Band D	76-90	£100.00	£140.00
Band E	91-100	£120.00	£140.00
Band F	101-110	£140.00	£140.00
Band G	111-130	£160.00	£140.00
Band H	131-150	£200.00	£140.00
Band I	151-170	£500.00	£140.00
Band J	171-190	£800.00	£140.00
Band K	191-225	£1200.00	£140.00
Band L	226-255	£1700.00	£140.00
Band M	over 255	£2000.00	£140.00

* = Correct at time of issue.

PROTECTING THE ENVIRONMENT

Vauxhall's commitment to the environment is demonstrated by our products' many environmental awards. For even more information on Vauxhall's efforts to achieve an environmentally sustainable future, and how to dispose of your end-of-life vehicle, see www.vauxhall.co.uk/recycling

VAUXHALL ASSISTANCE

Vauxhall Assistance is provided automatically with every new Vauxhall for 12 months from first registration and covers everything from accident assistance, roadside recovery and 'at home' service to flat tyres. With Vauxhall Assistance help is literally just a free** phone call away, 24 hours a day, 365 days a year!

** = Mobile phone users will be charged at their standard tariff.

VAUXHALL LEASING

As Vauxhall's own contract hire and fleet management operation, Vauxhall Leasing provides a one-stop-shop for competitive car and van leasing solutions – for business users and private individuals. Working with the Vauxhall Retailer network, we combine the support of a national contract with the convenience of a local contact.

For further information, please see your local Vauxhall Retailer or call us on **0117 908 6433**. Alternatively, you can visit our website at www.vauxhall-leasing.co.uk

IN THE EVENT OF AN ACCIDENT...

Vauxhall Accident Management helps keep you mobile following an accident. Benefits include vehicle recovery, Vauxhall-approved repairs and contacting your insurer. For more details, visit vauxhall.co.uk/AccidentManagement

VAUXHALL SERVICE PLAN

Vauxhall Retailers offer a great service for owners of all Vauxhall cars. Value for money, regular offers and free check-ups, combined with the peace of mind that comes from using Vauxhall-trained technicians and genuine parts, help keep your car in peak condition at all times.

FOR MORE PRODUCT INFORMATION

For a brochure on any Vauxhall model (up to a maximum of three per caller) or location of your nearest Vauxhall Retailer please call **0345 600 1500**. Alternatively, details can be found on our website at www.vauxhall.co.uk

JOIN US ONLINE:



VAUXHALL INSURANCE WITH ADDED REASSURANCE

Comprehensive cover – Summary of benefits*

- Competitive premiums
- Repairs by a Vauxhall-trained technician
- Genuine Vauxhall parts, guaranteed for three years when we repair your car within our Approved Repairer Network
- Free courtesy car as standard when using an Approved Repairer**
- 24 hour claims helpline
- Personal Accident benefit
- Cover for audio equipment
- Windscreen cover

Call for a quote on 0844 463 2670†

*The benefits listed above are for comprehensive cover only. For details of Third Party, Fire and Theft cover, please call our sales team.
 **Should your car need repairing following an accident we provide a courtesy car (subject to availability) for the duration of the repair. Only genuine Vauxhall parts are used. Terms and conditions apply.
 † Calls may be recorded. Vauxhall Insurance is underwritten by Ageas Insurance Limited.

Every effort has been made to ensure that the contents of this document were accurate and up-to-date at the time of publication – 1 April 2017 (Amended 26 April 2017). The invoice price, including delivery to Retailer, factory-fitted options, accessories fitted by the Retailer and number plates, is subject to VAT. The right is reserved to alter specifications and prices, and withdraw products from sale, without notice. Please note that Vauxhall Retailers are not the agents of Vauxhall Motors Limited and are not authorised to bind Vauxhall Motors Limited by any specific or implied undertaking or representation. It is advisable to ensure that your motor insurance policy provides adequate cover for additional fitted options and accessories. All rights reserved. No part of this publication may be reproduced in any form or by any means, without the prior written permission of Vauxhall Motors Limited.

Vauxhall Motors Limited, Griffin House, UK1-101-135, Osborne Road, Luton, Bedfordshire, LU1 3YT. www.vauxhall.co.uk

©2017 Vauxhall Motors Limited



VAUXHALL