

ADAM ROCKS PRICE/SPECIFICATION GUIDE

18 September 2017



Contents:

Model Year 2018 (pages 2-13)

Model Year 2017.5 (pages 16-27)

ADAM ROCKS PRICES

Model 3-door CUV	Price (£)	VAT (£)	Total (£)	On-the-road RRP (£)	CO ₂ (g/km)
ADAM ROCKS VAUXHALL OnStar					
1.2i (70PS)	12150.00	2430.00	14580.00	15495.00	125
1.0i Turbo (115PS) Start/Stop ecoTEC	13733.33	2746.67	16480.00	17395.00	112
ADAM ROCKS AIR VAUXHALL OnStar					
1.2i (70PS)	12983.33	2596.67	15580.00	16495.00	125
1.4i (87PS)	13125.00	2625.00	15750.00	16665.00	125
1.0i Turbo (115PS) Start/Stop ecoTEC	14566.67	2913.33	17480.00	18395.00	112
ADAM ROCKS S VAUXHALL OnStar					
1.4i Turbo (150PS) Start/Stop	15641.67	3128.33	18770.00	19725.00	139

Please note: On-the-road recommended retail prices (RRP) include number plates and delivery to Retailer of £700.00 (inc. £116.67 VAT), 12 months' Vehicle Excise Duty and new vehicle first registration fee of £55.00. Excludes fuel and insurance.

ADAM ROCKS £15,495-£17,395

Standard features include:

- Vauxhall OnStar
- Anthracite protective mouldings for wheel arches, lower doors and side sills
- Anthracite front and rear bumpers with alloy-effect visible underbody protection
- Ride height increased by 15mm compared to ADAM JAM, GLAM, SLAM and ENERGISED models
- Chrome-effect exhaust tailpipe extension
- Alloy-effect surround for front indicators, reversing light and rear fog light
- Air conditioning
- CD player with USB facility and aux-in socket
- Digital radio
- Bluetooth® mobile phone portal
- Music streaming via Bluetooth®
- Steering wheel mounted audio controls
- Leather-covered steering wheel
- Ocio Black Cloth/Morrocana seats
- Cruise control and trip computer
- Electronic Stability Programme-plus (ESP-plus)
- Anti-lock Braking System (ABS)
- Tyre pressure monitoring system
- Six airbags
- Body-colour door handles with chrome-effect insert
- Chrome-effect upper side window mouldings
- Chrome-effect door sill covers
- 17-inch Sterling Silver Swiss Blade alloy wheels
- Black Jack roof and door mirrors
- Roof and door mirrors in a range of colours available at no cost

ADAM ROCKS AIR £16,495-£18,395

Feature over ADAM ROCKS:

- Electrically operated folding canvas roof

ADAM ROCKS S £19,725

Features over ADAM ROCKS:

- Electrically operated folding canvas roof
- Dark-tinted rear windows
- 18-inch Gloss Black Y-spoke alloy wheels
- Sports suspension
- Uprated brakes with red brake calipers
- Unique rear roof spoiler
- LED daytime running lights
- Red your Engine Black cloth/Morrocana seats
- Red your Engine facia and door panel inserts

Please note: ADAM ROCKS S does not feature chrome-effect inserts in the body-colour door handles.

ADAM ROCKS FEATURES/OPTIONS

SAFETY

Standard features

- Airbags:** • Driver's airbag • Front passenger's airbag • Front seat side-impact airbags • Full-size curtain airbags for front and rear seat passengers • Deactivation switch for front passenger's front and side-impact airbags – Ensures front passenger airbags do not inflate when a child seat is fitted to the front passenger's seat
- Seating:** • Height-adjustable front and rear seat head restraints • Four lap and diagonal inertia-reel seatbelts • Front body-lock diagonal seatbelt pretensioner system – Tightens the seatbelt during the early stages of a frontal impact • Driver's and front passenger's lap belt pretensioner system • Front seatbelt force limiters – Reduces potential upper body injuries during a frontal impact • Anti-submarining ramps in front seats • ISOFIX child seat restraint system for rear seats incorporating top tether (does not include child seat) – Secures specially designed ISOFIX child safety seats to the vehicle itself, virtually eliminating the dangers that can result from improper installation
- Electronic:** • Electronic Stability Programme-plus (ESP-plus) – Reduces the possibility of losing control of the vehicle • Anti-lock Braking System (ABS) • Electronic brakeforce distribution • Cornering brake control • Emergency brake assist – Increases brakeforce applied in emergency braking situations • Hill start assist • Straight line stability control • Traction control • Adaptive brake lights – If the driver brakes hard enough to activate the ABS function the brake lights flash on and off at a frequency of five times per second, warning following vehicles that heavy braking is in progress • Tyre pressure monitoring system
- Body:** • Energy-absorbing steering column • Pedal release system – Reduces potential injury to the driver's legs and feet during a severe frontal impact • Laminated windscreen • Side-impact protection beams • Reinforced passenger safety cell • Deformation zones front and rear
- Pedestrian:** • Collapsible windscreen wiper system – Reduces the risk of head injury • Low density foam near front bumper crossmember – Reduces lower leg injuries • Plastic lower front bumper stiffener – Reduces knee injuries

Additional feature

	ADAM ROCKS	ADAM ROCKS A/R	ADAM ROCKS S	Price (£) exc. VAT	Total (£) inc. VAT
Switchable Electronic Stability Programme-plus (ESP-plus)			●		

SECURITY

- Standard features** • Remote control two-stage central deadlocking (doors, tailgate, fuel filler flap) • Visible Vehicle Identification Number (VIN) plate • Electronic engine deadlock immobiliser • Electronic theft protection for audio equipment • Driver's and front passenger's internal central locking switch • Locking wheel nuts • Luggage area cover • Folding key

Additional feature

	ADAM ROCKS	ADAM ROCKS A/R	ADAM ROCKS S	Price (£) exc. VAT	Total (£) inc. VAT
Remote control security alarm system	○	○	○	216.67	260.00

HEATING AND VENTILATION

- Standard features** • Interior pollen filter • Air recirculation with activation light • Air blend heater

Additional feature

	ADAM ROCKS	ADAM ROCKS A/R	ADAM ROCKS S	Price (£) exc. VAT	Total (£) inc. VAT
Air conditioning with four-speed fan	●	●			
Electronic climate control incorporating air conditioning with six-speed fan	○	○	●	258.33	310.00

● = Standard equipment. ○ = Optional at extra cost.

ADAM ROCKS FEATURES/OPTIONS

FACIA, INSTRUMENTS AND CONTROLS

Standard features • Leather-covered steering wheel • Multi-function trip computer¹ • Cruise control with speed limiter function • Shift-up indication light (Start/Stop models only) • Rev counter • Digital clock with automatic RDS time adjustment • Black instruments with chrome edging • Steering column adjustable for reach and rake • Electronic odometer and trip odometer • Instrument panel light dimmer • Handbrake-on/low brake fluid level and low fuel level warning lights • Service interval monitor • Seatbelt unfastened warning light for front and rear seats

	ADAM ROCKS	ADAM ROCKS AIR	ADAM ROCKS S	Price (£) exc. VAT	Total (£) inc. VAT
Additional features					
City mode button providing lighter steering at parking speeds	●	●			
Winter Pack ² • Electrically heated front seats • Electrically heated leather-covered three-spoke steering wheel	○	○	○ ³	187.50	225.00

INTERIOR FEATURES

Standard features • Driver's and front passenger's seats with reach and rake adjustment • Driver's seat height adjuster • Map pocket on front seat backs • 12-volt auxiliary power socket within centre console • Drinks holder in front centre console with adjustable restraining strap • Two drinks holders in rear centre console • Chrome-effect interior door handles • Colour-keyed fleece velour carpet • Front door pockets • Front assist handles • Fully carpeted and illuminated luggage area • Twin sunvisors incorporating driver's vanity mirror with cover • Courtesy lighting operated by door switches • 50/50 split-folding rear seat back

	ADAM ROCKS	ADAM ROCKS AIR	ADAM ROCKS S	Price (£) exc. VAT	Total (£) inc. VAT
Additional features					
Electro-chromatic anti-dazzle rear-view mirror (part of Sight and Light Pack One)	□	□	□		
Japan Black fascia and door panel inserts	● ⁴	● ⁵	N/C	No-cost option	
Facia and door panel inserts matched to exterior colour	● ⁶				
Pearl White fascia and door panel inserts	● ⁷	● ⁸			
Red your Engine fascia and door panel inserts			●		
Black Cloth/Morrocana interior	●	●	●		
Caramel Cloth/Morrocana interior	N/C			No-cost option	
Black Leather seat facings, electrically heated front seats, electrically heated leather-covered three-spoke steering wheel and front passenger's seat height adjuster	○	○		591.67	710.00
Recaro sports front seats, Black Track Cloth/Morrocana trim and front passenger's seat height adjuster			○ ⁹	875.00	1050.00
Recaro sports front seats, Black Nappa Leather seat facings, electrically heated front seats, electrically heated leather-covered three-spoke steering wheel and front passenger's seat height adjuster			○	1350.00	1620.00
Electrically heated front seats (part of Winter Pack, also included with Leather seat facings)	□	□	□		
Sports pedals			●		
Black ADAM S velour floor mats			●		

MECHANICAL FEATURES

Standard features • Speed-sensitive power-assisted steering • Five-speed manual gearbox (1.2i (70PS) and 1.4i (87PS) models) • Six-speed manual gearbox (1.0i Turbo (115PS) and 1.4i Turbo (150PS) models)

	ADAM ROCKS	ADAM ROCKS AIR	ADAM ROCKS S	Price (£) exc. VAT	Total (£) inc. VAT
Additional features					
Ride height increased by 15mm compared to ADAM JAM, GLAM, SLAM and ENERGISED models	●	●			
Sports suspension			●		

● = Standard equipment. ○ = Optional at extra cost. □ = Available as part of an option pack. N/C = No-cost option.

1 = Information displayed: instantaneous fuel consumption, average fuel consumption, range remaining, outside temperature. 2 = Fitted at no extra cost in conjunction with optional leather seat facings. 3 = Not available in conjunction with Black Track Cloth/Morrocana Recaro sports front seats. 4 = Standard on Black Jack, Shades of Grey and Heavy Metal models. Not available with other exterior colours. 5 = Standard on Orange Alert, Red 'n' Roll, Mint my Mind, Black Jack, Pump up the Blue and Let it Blue models. Not available with other exterior colours. 6 = Standard on Orange Alert, Red 'n' Roll, Mint my Mind, Pump up the Blue and Let it Blue models. Not available with other exterior colours. 7 = Standard on Saturday White Fever and White my Fire models. Not available with other exterior colours. 8 = Standard on Saturday White Fever, White my Fire, Shades of Grey and Heavy Metal models. Not available with other exterior colours. 9 = Not available in conjunction with Winter Pack.

ADAM ROCKS FEATURES/OPTIONS

EXTERIOR FEATURES

Standard features • Anthracite protective mouldings for wheel arches, lower doors and side sills • Anthracite front and rear bumpers with alloy-effect visible underbody protection • Alloy-effect surround for front indicators, reversing light and rear fog light • Tinted glass • Chrome-effect upper side window mouldings • Chrome-effect door sill covers • Heated rear window with automatic timed cut-off • Rear window wash/wipe • Electrically operated front windows with safety autoreverse and one-touch facility • Electrically adjustable/heated door mirrors • Black B-pillars • Lights-on audible warning • Welcome lighting • Twin gas-assisted tailgate struts • Chrome-effect exhaust tailpipe extension

	ADAM ROCKS	ADAM ROCKS AIR	ADAM ROCKS S	Price (£) exc. VAT	Total (£) inc. VAT
Additional features					
Body-colour door handles			●		
Body-colour door handles with chrome-effect insert	●	●			
Electrically operated folding canvas roof in Black		●	●		
Unique ADAM ROCKS S rear roof spoiler			●		
Black Jack Roof Colour Pack • Black Jack roof and door mirrors	●	●	●		
White my Fire Roof Colour Pack • White my Fire roof and door mirrors	N/C	N/C	N/C		No-cost option
Shades of Grey Roof Colour Pack ¹⁰ • Shades of Grey roof and door mirrors	N/C	N/C	N/C		No-cost option
Let it Blue Roof Colour Pack • Let it Blue roof and door mirrors			N/C		No-cost option
Red 'n' Roll Roof Colour Pack • Red 'n' Roll roof and door mirrors			N/C		No-cost option
Body-colour roof and door mirrors	N/C	N/C	N/C		No-cost option
Extreme Carbon Pack • Carbon fibre-effect door mirrors, front grille bar and rear-view mirror	○	○	○	175.00	210.00
Sight and Light Pack One ¹¹ • Rain-sensitive windscreen wipers • Automatic lighting control with tunnel detection • Electro-chromatic anti-dazzle rear-view mirror	○	○	○	200.00	240.00
Sight and Light Pack Two ¹² • Rain-sensitive windscreen wipers • Automatic lighting control with tunnel detection	○	○	○	175.00	210.00
LED daytime running lights			●		
LED tail lights			○	100.00	120.00
Exterior Light Pack • LED daytime running lights • LED tail lights	○	○		175.00	210.00
Technical Pack • R4.0 IntelliLink • Rear parking distance sensors	○	○	○	429.17	515.00
Dark-tinted rear windows	○	○	●	145.83	175.00
Rear parking distance sensors	○	○	○	237.50	285.00

● = Standard equipment. ○ = Optional at extra cost. N/C = No-cost option.

10 = Not available on Heavy Metal models. 11 = Not available in conjunction with Extreme Carbon Pack. 12 = Only available in conjunction with Extreme Carbon Pack.

ADAM ROCKS FEATURES/OPTIONS

EXTERIOR COLOURS





		ADAM ROCKS	ADAM ROCKS AIR	ADAM ROCKS S	Price (£) exc. VAT	Total (£) inc. VAT
	Orange Alert • Solid paint	●	●			
	Red 'n' Roll • Brilliant paint	○	○	●	237.50	285.00
	Saturday White Fever • Brilliant paint					
	White my Fire • Brilliant paint	○	○	○	237.50	285.00
	Mint my Mind • Brilliant paint	○	○		237.50	285.00

● = Standard equipment. ○ = Optional at extra cost.

The colours reproduced may vary slightly from the actual paint colour. As a result they should be used as a guide only. Your Vauxhall Retailer has a comprehensive display of our paint samples.

ADAM ROCKS FEATURES/OPTIONS

EXTERIOR COLOURS

		ADAM ROCKS	ADAM ROCKS AIR	ADAM ROCKS S	Price (£) exc. VAT	Total (£) inc. VAT
	Black Jack • Two-coat metallic paint	<input type="checkbox"/>	<input type="checkbox"/>	<input type="checkbox"/>	470.83	565.00
	Shades of Grey • Two-coat metallic paint					
	Heavy Metal • Two-coat metallic paint • Not available with Shades of Grey Roof Colour Pack					
	Pump up the Blue • Two-coat premium paint	<input type="checkbox"/>	<input type="checkbox"/>	<input type="checkbox"/>	545.83	655.00
	Let it Blue • Two-coat premium paint					

○ = Optional at extra cost.

The colours reproduced may vary slightly from the actual paint colour. As a result they should be used as a guide only. Your Vauxhall Retailer has a comprehensive display of our paint samples.

ADAM ROCKS FEATURES/OPTIONS

AUDIO, COMMUNICATION AND NAVIGATION

Standard features • Digital radio • Bluetooth® mobile phone portal • Bluetooth® audio streaming • Steering wheel mounted audio controls

	ADAM ROCKS	ADAM ROCKS AIR	ADAM ROCKS S	Price (£) exc. VAT	Total (£) inc. VAT
Additional features CD/MP3 CD player/stereo radio • CD/MP3 CD player • USB connection with iPod control • AM/FM stereo radio with 36 station presets • RDS with Traffic Programme • 20 watts per channel output	●	●	●		
R4.0 IntelliLink touchscreen infotainment system – For use with media players, USB memory sticks, mobile phones and smartphone apps Onboard features: • 7-inch colour touchscreen • AM/FM stereo radio with 36 station presets • RDS with Traffic Programme • 20 watts per channel output Media connections: • USB connection with iPod control • Bluetooth® A2DP audio streaming (Advanced Audio Distribution Profile) Mobile phone portal: • Bluetooth® connectivity • Handsfree calls via steering wheel controls • Vehicle microphone • Phone book access – Contacts/last calls/missed calls etc. are mirrored on IntelliLink's display and are easily navigated using the touchscreen (features dependent on mobile phone) Smartphone interface: • Apple CarPlay™ • Android Auto™	□	□	□		
Navi 4.0 IntelliLink touchscreen navigation and infotainment system (not available in conjunction with Technical Pack) – For use with media players, USB memory sticks, mobile phones and smartphone apps Onboard features: • 7-inch colour touchscreen • AM/FM stereo radio with 36 station presets • RDS with Traffic Programme • 20 watts per channel output Navigation features: • Satellite navigation system • 2D street level mapping • European coverage • Structured or one-box destination entry • Points-of-interest search • Eco routing • Map updates via USB Media connections: • USB connection with iPod control • Bluetooth® A2DP audio streaming (Advanced Audio Distribution Profile) Mobile phone portal: • Bluetooth® connectivity • Handsfree calls via steering wheel controls • Vehicle microphone • Phone book access – Contacts/last calls/missed calls etc. are mirrored on IntelliLink's display and are easily navigated using the touchscreen (features dependent on mobile phone) Smartphone interface: • Apple CarPlay™ • Android Auto™ Gallery – only available when vehicle is stationary: • Photo gallery with slide show feature • Video playback with soundtrack played through car speakers	○	○	○	654.17	785.00
Aux-in socket (deleted if optional Technical Pack or Navi 4.0 IntelliLink is specified)	●	●	●		
Six speakers	●	●	●		
Vauxhall OnStar*	●	●	●		

● = Standard equipment. ○ = Optional at extra cost. □ = Available as part of an option pack.

* = Includes 12 months of OnStar services from date of first registration and a 3 month/3 GB Wi-Fi free trial period (whichever comes first) effective from the date the customer accepts the nominated network operator Wi-Fi Ts&Cs. Destination download feature only operates on models fitted with Navi 4.0 IntelliLink satellite navigation system. Theft alert feature only operates if optional security alarm system is specified.

VAUXHALL ONSTAR – YOUR PERSONAL ON BOARD ASSISTANT

Many car brands talk about innovation as soon as they improve their cup holders but this innovative system, now available on selected models**, is revolutionary: 24/7, 365 days a year, Vauxhall OnStar puts you in touch with a trained advisor, not a machine. With OnStar you have access to a host of innovations, from Vehicle Diagnostics and Smartphone Function to a fully integrated 4G Wi-Fi Hotspot†. In the event of an accident, Vauxhall OnStar even automatically calls for help, for an incomparable feeling of safety.

** = The OnStar Services require activation and are subject to mobile network coverage and availability. Wi-Fi Hotspot service requires account with nominated network operator.

† = 4G is subject to mobile network coverage and availability. Charges apply after the free trial period. The OnStar subscription packages could be different from the services included in the free trial package. Check www.vauxhall.co.uk/onstar for terms and conditions, details of availability, coverage and charges.

DIGITAL RADIO

Now widely available in the UK, digital radio broadcasts offer the user a variety of advantages over traditional FM, starting with the digital quality sound which is immune to any hiss or crackle.

You'll often find a broader range of stations on offer too, many of which are not available on FM, and listening to them couldn't be easier – you simply select the station, by name, from the displayed list, thus removing the need to retune or look for stations when travelling around. Some stations will even display the artists' names and song titles on the car's graphic display, while they're played.

INTELLILINK

IntelliLink is Vauxhall's next-generation in-car infotainment system. It features a 7-inch colour touchscreen that enables access to, and operation of, a wide range of functions including music, video, phone, navigation and internet services.

The system isn't equipped with a CD or DVD player. Instead, it's designed to support the latest media sources including Bluetooth® and USB devices, together with smartphones and their applications. All of these features are accessed through the touchscreen's Home menu.

Since many of these features are accessed via smartphone, the IntelliLink unit is designed to allow application updates as and when they become available, thus enabling it to make use of the latest smartphone developments as they happen.



Music can be played either through the radio or from personal music players via USB connection or Bluetooth® audio streaming. When played via USB, IntelliLink's built-in Gracenote® link provides song information and album artwork. Films and slide shows can also be viewed via the USB connection, but this facility is disabled when the car is moving.

IntelliLink is able to pair with up to four Bluetooth® phones simultaneously, with each phone's address book downloaded to the audio unit so that the car effectively becomes the phone. Phone priority can then be set through the touchscreen display.

The smartphone link works in conjunction with Apple CarPlay (including Siri Eyes Free) and Android Auto. These give access to satellite navigation and a wide range of internet radio stations.



ADAM ROCKS FEATURES/OPTIONS

WHEELS AND TYRES

Features		ADAM ROCKS	ADAM ROCKS AIR	ADAM ROCKS S	Price (£) exc. VAT	Total (£) inc. VAT
	17-inch Sterling Silver Swiss Blade alloy wheels • 215/45 R 17 tyres Emergency tyre inflation kit (in lieu of spare wheel)	●	●			
	18-inch Silver Turbine alloy wheels • 225/35 R 18 tyres Emergency tyre inflation kit (in lieu of spare wheel)	○	○		675.00	810.00
	18-inch Gloss Black Y-spoke alloy wheels • 225/35 R 18 tyres Emergency tyre inflation kit (in lieu of spare wheel)			●		
	18-inch Technical Grey Propellor diamond-cut alloy wheels • 225/35 R 18 tyres Emergency tyre inflation kit (in lieu of spare wheel)			N/C	No-cost option	

● = Standard equipment. ○ = Optional at extra cost. N/C = No-cost option.

TYRE RATING

Tyre size	Fuel efficiency group	Wet grip performance	External noise	
			Measured (dB)	Group
215/45 R 17	C	B	71	
225/35 R 18	C	B	77	

Tyre rating according to EU Regulation 1222/2009

ADAM ROCKS SPECIFICATIONS

PETROL ENGINES

	1.2i (70PS)	1.4i (87PS)	1.0i Turbo (115PS) ecoTEC with Start/Stop
Capacity	1229cc	1398cc	998cc
Maximum power	70PS (51kW) @ 5600rpm	87PS (64kW) @ 6000rpm	115PS (85kW) @ 5200rpm
Maximum torque	115Nm (85 lb.ft.) @ 4000rpm	130Nm (96 lb.ft.) @ 4000rpm	170Nm (125 lb.ft.) @ 1800-4500rpm
Configuration	4 cylinders, 4 valves per cylinder, double overhead camshafts	4 cylinders, 4 valves per cylinder, double overhead camshafts	3 cylinders, 4 valves per cylinder, double overhead camshafts
Fuel/induction system	Naturally aspirated. Variable Valve Timing. Multi-point sequential fuel injection	Naturally aspirated. Variable Valve Timing. Multi-point sequential fuel injection	Water-cooled turbocharger with intercooler. Variable Valve Timing (VVT) Central direct injection
Emission compliance	Euro 6	Euro 6	Euro 6
Service interval	20,000 miles or 1 year (whichever occurs sooner)	20,000 miles or 1 year (whichever occurs sooner)	20,000 miles or 1 year (whichever occurs sooner)

	1.4i Turbo (150PS) with Start/Stop
Capacity	1364cc
Maximum power	150PS (110kW) @ 4900-5500rpm
Maximum torque	220Nm (162 lb.ft.) @ 2750-4500rpm
Configuration	4 cylinders, 4 valves per cylinder, double overhead camshafts
Fuel/induction system	Water-cooled turbocharger with intercooler. Variable Valve Timing (VVT) Multi-point sequential fuel injection
Emission compliance	Euro 6
Service interval	20,000 miles or 1 year (whichever occurs sooner)

PERFORMANCE, FUEL ECONOMY AND EMISSIONS

	Wheel size (inches)	Performance (manufacturer's figures)		Fuel economy mpg (litres/100km)#			CO ₂ emissions g/km#	Vehicle Excise Duty*		Benefit in kind company car taxation rates - 2017/18 tax year
		Maximum speed (mph)	Acceleration 0-62mph (sec)	Urban driving	Extra-urban driving	Combined figure		First year rate	Standard rate	
Manual										
1.2i (70PS)	17/18	103	14.9	39.2 (7.2)	65.7 (4.3)	53.3 (5.3)	125	£160	£140	24%
1.4i (87PS)	17/18	109	12.5	39.8 (7.1)	62.8 (4.5)	52.3 (5.4)	125	£160	£140	24%
1.0i Turbo (115PS) Start/Stop ecoTEC	17/18	121	9.9	47.1 (6.0)	67.3 (4.2)	57.6 (4.9)	112	£160	£140	21%
1.4i Turbo (150PS) Start/Stop	18	130	8.5	37.2 (7.6)	57.6 (4.9)	47.9 (5.9)	139	£200	£140	26%

* = Correct at time of publication.

= Fuel consumption information is official government environmental data, tested in accordance with the relevant EU directive. Official EU-regulated test data is provided for comparison purposes and actual performance will depend on driving style, road conditions and other non-technical factors.

ADAM ROCKS SPECIFICATIONS

START/STOP TECHNOLOGY

The ADAM ROCKS Start/Stop system offers real benefits by improving fuel economy and reducing CO₂ emissions, particularly in town. It does this by automatically stopping the engine when you come to a standstill, and then restarting as you prepare to move off.

Before automatically stopping the engine a number of system checks are carried out to ensure that it is both safe and practical to do so. To ensure safety, the driver must depress the clutch pedal, shift in to neutral, and then release the clutch pedal. System checks carried out before Auto Stop activates include:

- Start/Stop system is not manually deactivated via the facia button
- Sufficient brake vacuum is available to prevent the car rolling down an incline
- Battery is in good condition and charged
- Outside air temperature and engine temperature are above specified minima
- Electronic climate control (where fitted) is not in maximum heating or maximum cooling mode

If all of these conditions are satisfied then the vehicle will Auto Stop.

When you are ready to pull away from standstill, Auto Restart is activated by depressing the clutch pedal. Whilst at a standstill the vehicle is continually monitored. If necessary, the engine will automatically be restarted. Conditions that would initiate an Auto Restart include:

- Low battery level
- Cabin temperature is too high
- Driver's seatbelt unfastened or driver's door opened
- Bonnet is released or opened

TRANSMISSION

Five-speed manual gearbox:

Standard on 1.2i (70PS) and 1.4i (87PS) models.

Six-speed manual gearbox:

Standard on 1.0i Turbo (115PS) and 1.4i Turbo (150PS) models.

STEERING

- Speed-sensitive power-assisted steering

SUSPENSION

Front: Independent, MacPherson struts with gas-pressure dampers and coil springs. Anti-roll bar.

Rear: Compound crank with coil springs and gas-pressure dampers.

BRAKING AND STABILITY

- Electronic Stability Programme
- Cornering brake control
- Straight line stability control
- Anti-lock Braking System (ABS)
- Electronic brakeforce distribution
- Emergency brake assist
- Dual circuit, diagonally split braking system

1.2i (70PS)/1.4i (87PS)

Front ventilated discs: 257mm diameter

Rear drums: 203mm diameter

1.0i Turbo (115PS)

Front ventilated discs: 284mm diameter

Rear drums: 228mm diameter

1.4i Turbo (150PS)

Front ventilated discs: 308mm diameter

Rear discs: 264mm diameter

FUEL TANK CAPACITY

- 38 litres (8.4 gallons)

GROSS VEHICLE WEIGHTS kg

1.2i (70PS)	1470
1.4i (87PS)	1480
1.0i Turbo (115PS)	1510
1.4i Turbo (150PS)	1565

Gross vehicle weight is the total permissible weight of the vehicle including passengers and luggage. The maximum roof rack loading should not exceed 50kg.

EXTERIOR DIMENSIONS millimetres (inches)

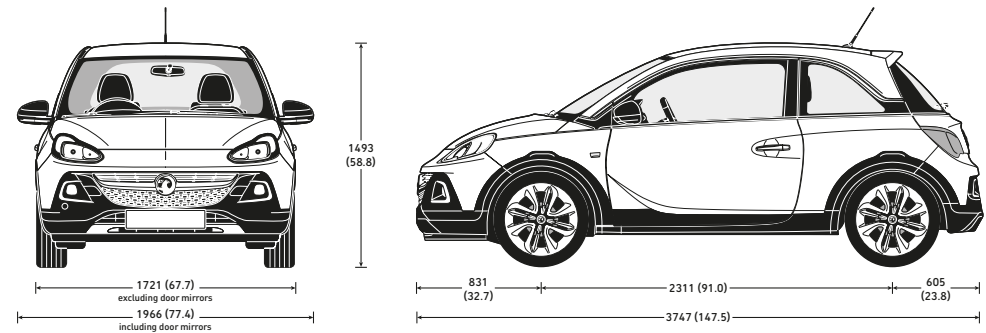

LOADSPACE DIMENSIONS

	millimetres (inches)
Maximum length (behind rear seats)	462 (18.2)
Maximum length (rear seats folded)	1041 (41.0)
Maximum width	963 (37.9)
Width between wheel arches	954 (37.6)
Maximum height	874 (34.4)

LUGGAGE CAPACITIES*

	litres (cu.ft.)
Rear seats up (under luggage compartment cover)	170 (6.0)
Rear seats folded (to upper edge of front seat back)	484 (17.1)
Rear seats folded (to roof)	663 (23.4)

* = Measured using the ECIE method.

ADAM ROCKS ACCESSORIES

	Total (inc. VAT)		Total (inc. VAT)		Total (inc. VAT)		Total (inc. VAT)
CHILD SEATS¹		EXTERIOR		TRANSPORT SYSTEMS		ALLOY WHEELS (set of four with centre caps)⁴	
BABY-SAFE ² – 0-13kg/birth to 15 months	£132.00	Door mirror caps (fitted)	from £105.00	Roof base carrier	£137.00	16-inch Horns	
– ISOFIX base	£227.00	Painted logo bar (fitted)	from £88.00	Roof carriers (requires base carrier)		– Silver	£811.00
DUO ISOFIX ² – 9-18kg/9 months to 4 years		'Fly' decals		Bike roof carrier – Thule Freeride 532	£76.00	– Black	£1052.00
with top tether kit	£347.00	– B-pillar decal (fitted)	£51.00	Surf board roof carrier – Thule 833	£101.00	16-inch Vintage	£954.00
KID ² – 15-36kg or 4 to 12 years	£157.00	– C-pillar decal (fitted)	£160.00	Kayak roof carrier – Thule 837	£168.00	16-inch Boomerang	
		'Splat' graphics		Ski roof carrier (400mm wide)		– Grey / diamond cut face	£758.00
		Front wing/rear quarter decals (fitted)	from £128.00	– Thule Deluxe 726	£ 138.00	– Green / diamond cut face	£1059.00
		'Sport 01' graphics		Ski roof carrier (600mm wide)		– White / diamond cut face	£1001.00
		– Bonnet decal (fitted)	from £93.00	– Thule 739	£235.00	16-inch Triple Cross	
		– Roof decal (fitted)	£113.00	Hard shell roof boxes (requires base carrier)		Titan grey	£804.00
		– C-pillar decal (fitted)	£95.00	Thule Ocean 80		Manoogian	£805.00
		'Stripes' graphics		(320 litre / 1330 x 860 x 370mm)	£235.00	18-inch Turbine	£1078.00
		– Bonnet decal (fitted)	from £130.00	Thule Ocean 200		17-inch Hurricane	
		– Roof decal (fitted)	from £127.00	(390 litre / 1750 x 820 x 450mm)	£316.00	– Manoogian	£1165.00
		– Door decals (fitted)	from £112.00	Thule Dynamic M		– Black	£898.00
		– Door / door mirror decals (fitted)	from £132.00	(320 litre / 2060 x 840 x 340mm)	from £625.00	– White	£891.00
		'Stars and Stripes' graphics		Thule Dynamic L		17-inch Swiss Blade	
		– Roof / B Pillar decals (fitted)	£193.00	(430 litre / 2350 x 940 x 350mm)	£846.00	– Silver	£904.00
		'Chequered' graphics		Thule Excellence		– Black / white rim	£746.00
		– Roof decal (fitted)	£121.00	(520 litre / 2180 x 940 x 400mm)	£898.00	– Black / red rim	£1084.00
		'Motorsport' graphics		Thule Motion 800		– Black / blue rim	£1077.00
		– Bonnet / body side decals (fitted)	£350.00	(460 litre / 2050 x 840 x 450mm)	from £515.00	17-inch Roulette	
		Body side protection mouldings		Thule Touring 200		– Grey	£884.00
		(painted/fitted)	£211.00	(400 litre / 1750 x 820 x 450mm)	£372.00	– Grey / diamond cut face	£1165.00
		PROTECTION		Thule Touring 780		– Grey / white face	£1405.00
		Tyre sealant – 450ml	£67.00	(430 litre / 2320 x 700 x 420mm)	£460.00	– Grey / brown face	£1405.00
		Tyre inflation compressor	£120.00	Soft roof boxes (requires base carrier)		– Grey / green face	£953.00
		Safety pack – first aid kit/hi-visibility vest/ warning triangle	£35.00	Thule Ranger 90		– Copper / white face	£953.00
		First aid kit	£15.00	(280 litre / 1100 x 800 x 400mm)	£285.00	– Copper / diamond cut face	£785.00
		Hi-visibility vest	£9.00	Thule Ranger 500		– Black gloss	£898.00
		Warning triangle	£17.00	(300 litre / 1900 x 500 x 300mm)	£378.00	18-inch Twister	
		Spare bulb kit	£26.00	Tailgate carrier		– Grey	£1942.00
		Protection film – front bumper (fitted)	£167.00	Bike tailgate carrier – Thule BacPac 973	£282.00	– Manoogian	£1961.00
		Protection film – rear bumper (fitted)	£56.00	Fitting kit	£48.00	Coloured wheel clips for Twister wheels (set of four)	from £70.00
		Privacy shades – tailgate/rear side windows	£183.00	Flex-fix bicycle carrier – extension kit for third bicycle	£254.00	Tyre valve caps with Vauxhall logos – set of four	£23.00
		Exterior windscreen cover	£69.00			Locking wheel bolts	£43.00
		Outdoor car cover	from £288.00				
		Mudflaps – front (fitted)	£63.00				
		Mudflaps – rear (fitted)	£56.00				

1 = Restrictions apply to the use of child seats, please consult your Vauxhall Retailer or request a copy of the Child seats brochure.
2 = Without transponder.

FLEXCONNECT RANGE

FlexConnect bracket	£20.00
FlexConnect hook	£28.00
FlexConnect coat hanger	£58.00
FlexConnect folding table	£68.00
FlexConnect iPad Mini cradle	£98.00
FlexConnect iPad (1-4) cradle	£106.00
FlexConnect iPad Air cradle	£106.00
FlexConnect Samsung Galaxy cradle	£96.00

INTERIOR

Velour floor mats (set of four)	from £56.00
Rubber floor mats (set of four)	£46.00
Rear view mirror cap	from £57.00
Front console mat	£37.00
Centre console armrest	£89.00
Cargo box with lid	£183.00
Coloured leather gear knob and gaiter (fitted)	from £64.00
Stainless steel pedal covers – manual (fitted)	£164.00

VXR EXTERIOR STYLING³

VX-Line body styling – front lower spoiler/side sills/ rear lower skirts (painted/fitted)	£1581.00
VX-Line body styling – rear roof spoiler (painted/fitted)	£539.00

3 = Not available on S models.

Please note:

Prices shown are a fully fitted and painted, where applicable and include VAT. Please check with your local Vauxhall Retailer for details. It is advisable to ensure your insurance policy is adequate to cover additional fitted accessories. Prices correct at time of publication.

4 = Different tyres and locking wheel bolts/nuts may be required at extra cost. Price excludes new tyres and locking wheel bolts/nuts, includes static wheel balancing.

ADAM ROCKS COMPANY CAR DRIVER/FLEET INFORMATION



COMPANY CAR DRIVER FREE 3 DAY TEST DRIVE

Our free* 3 Day Test Drive programme is open to all Company Car Drivers which allows you to choose any model in the current Vauxhall line-up (excluding Cascada, all VXR models and Commercial Vehicles), with full insurance cover provided, to give you a meaningful length of time to make an informed decision about your next company car.

Click below to book your free* test drive
www.vauxhall3dtd.co.uk
or call 0330 587 8221**

*The free 3 Day Test Drive programme is open to Company Car Drivers and Fleet Decision Makers. Available for UK Mainland only. Terms and conditions apply. Full terms and conditions can be found at vauxhallfleet.co.uk/testdrive/index/terms. **Telephone lines open Monday-Friday 9.00am to 5.00pm excluding Bank Holidays. Calls may be recorded or monitored for quality and/or training purposes.

FLEET TOOLBOX

Discover the facts in our online Toolbox for both Company Car Drivers and Fleet Decision Makers. The Fleet Toolbox has a host of useful calculators, comparators, interactive listings and information. Visit the Fleet Toolbox by going to www.vauxhall-toolbox.co.uk



ROADTRIP APP

The Vauxhall RoadTrip App is a free app that calculates and logs your mileage expenses for any UK business trips and generates reports to help you complete your mileage claims. Available for both iPhone and Android, visit www.vauxhall-toolbox.co.uk or visit the iPhone or Android stores and search for Vauxhall RoadTrip to download it to your smartphone or tablet.



BENEFIT IN KIND COMPANY CAR TAXATION†

The car benefit charge will be the car's list price (including VAT, options and accessories fitted, delivery to Retailer and number plates, but excluding Vehicle Excise Duty and new vehicle first registration fee) multiplied by the percentage charge for the CO₂ emissions band in which the car falls (see table opposite). Multiply this figure by your personal income tax rate (20% for Basic Rate, 40% for Higher Rate) to calculate your annual benefit in kind tax liability.

Example:

ADAM ROCKS 1.2i (70PS) (CO ₂ emissions 125g/km)	
On-the-road RRP	£15495.00
Deduct: Vehicle Excise Duty	(£160.00)
New vehicle first registration fee	(£55.00)
Effective list price	£15280.00
Add: Optional two-coat metallic paint	£565.00
List price for tax purposes (P11D value)	£15845.00
Car benefit charge	
2017-18 tax year (24%)	£3802.00
Benefit in kind tax liability (2017-18 tax year)	
Basic Rate (20%) tax payer	£760.40
Higher Rate (40%) tax payer	£1520.80

† = Please note this Price Guide provides taxation information as a guide only. Vauxhall does not provide taxation guidance. Drivers should always take professional advice on their own tax position.

CO ₂ emissions in grams per kilometre	Percentage of car's price to be taxed	
	Petrol 2017-18 tax year	Diesel 2017-18 tax year
up to 50	9	12
51-75	13	16
76-94	17	20
95-99	18	21
100-104	19	22
105-109	20	23
110-114	21	24
115-119	22	25
120-124	23	26
125-129	24	27
130-134	25	28
135-139	26	29
140-144	27	30
145-149	28	31
150-154	29	32
155-159	30	33
160-164	31	34
165-169	32	35
170-174	33	36
175-179	34	37
180-184	35	37
185-189	36	37
190 and above	37	37

To calculate your own personal liability a car tax calculator is available at: <https://www.vauxhallfleet.co.uk/toolbox>

CONTACT VAUXHALL FLEET

Please contact one of our dedicated sales teams who will be happy to help with your particular enquiry.

Company Car Drivers

Call: 0345 111 2020

Email: company-car@vauxhallinfo.co.uk

Telephone lines are open

- Monday to Friday 8.00am-9.00pm

- Saturday and Sunday 9.00am-6.00pm

Fleet Decision Makers

Depending on the size of your fleet of vehicles, we have a dedicated team to handle your enquiries. The lines are open Monday to Friday excluding Bank Holidays.

1-24 vehicles

Call: 0845 076 2254 (8.30am-5.00pm)

Email: b2bsales@vauxhall.co.uk

25+ vehicles

Call: 0330 587 8222 (8.30am-5.00pm)

Email: vauxhallfleet@vauxhall.co.uk

Special Vehicles (Police, Fire and Ambulance)

Call: 01582 409999 (8.30am-5.00pm)

Email: vauxhallspecialvehicles@vauxhall.co.uk

ADAM ROCKS ADDITIONAL INFORMATION

ON-THE-ROAD PRICES

To eliminate uncertainty about hidden costs when buying a new car, Vauxhall publishes on-the-road recommended retail prices (RRP) and these are shown in the pricing tables within this price guide. These prices include VAT, number plates and delivery to Retailer of £700.00 (including £116.67 VAT), 12 months' Government Vehicle Excise Duty (see opposite for details) and the DVLA new vehicle first registration fee of £55.00*.

Please note: The on-the-road recommended retail price (RRP) does not include fuel supplied by the Retailer, motor insurance or any other goods or services supplied by agreement between the Retailer and the customer.

PRICE PROTECTION

Order a new Vauxhall for build in the current model year (as confirmed by your Retailer) for delivery no more than three months in advance and the price you are quoted is the price you pay. This is irrespective of any subsequent price rises between placing your order and delivery of your new car, but you must take delivery as soon as the car is available. Vauxhall Motors Limited is not liable for price adjustments caused by Government changes in the rate of VAT (currently 20%), Vehicle Excise Duty, DVLA new vehicle first registration fee or by any other applicable legislation or regulations.

VEHICLE EXCISE DUTY

The amount of Vehicle Excise Duty (road fund licence) payable on new cars varies depending on the level of carbon dioxide (CO₂) emissions produced by the vehicle. CO₂ emissions are measured in grammes (g) per kilometre (km) travelled and divided into 13 charging bands shown in the table below.

A 'first year rate' of Vehicle Excise Duty is payable on all new cars and in subsequent years the amount payable reverts to the 'standard rate'. From 1 April 2017 the breakpoints for each of these bands have been revised. Also, for vehicles with a list price over £40,000, including factory-fitted options, an additional £310 is payable for the first five years of standard rate payments.

Vehicle Excise Duty*

	CO ₂ emissions (g/km)	First year rate	Standard rate
Band A	0	£0.00	£0.00
Band B	1-50	£10.00	£140.00
Band C	51-75	£25.00	£140.00
Band D	76-90	£100.00	£140.00
Band E	91-100	£120.00	£140.00
Band F	101-110	£140.00	£140.00
Band G	111-130	£160.00	£140.00
Band H	131-150	£200.00	£140.00
Band I	151-170	£500.00	£140.00
Band J	171-190	£800.00	£140.00
Band K	191-225	£1200.00	£140.00
Band L	226-255	£1700.00	£140.00
Band M	over 255	£2000.00	£140.00

* = Correct at time of issue.

VAUXHALL LEASING

As Vauxhall's own contract hire and fleet management operation, Vauxhall Leasing provides a one-stop-shop for competitive car and van leasing solutions – for business users and private individuals. Working with the Vauxhall Retailer network, we combine the support of a national contract with the convenience of a local contact.

For further information, please see your local Vauxhall Retailer or call us on **0117 908 6433**. Alternatively, you can visit our website at www.vauxhall-leasing.co.uk

IN THE EVENT OF AN ACCIDENT...

Vauxhall Accident Management helps keep you mobile following an accident. Benefits include vehicle recovery, Vauxhall-approved repairs and contacting your insurer. For more details, visit vauxhall.co.uk/AccidentManagement

TRUST VAUXHALL

CUSTOMER CARE COMMITMENT

For added peace of mind, Vauxhall has an innovative Customer Care Commitment that offers the following:

- Three-year vehicle warranty consisting of a one-year/unlimited mileage manufacturer's warranty and a second and third year manufacturer's warranty with a 60,000 miles limitation
- Vauxhall Assistance for 12 months from first registration
- Six years' body panel anti-perforation warranty

Please note: Warranty is only available on vehicles sourced from Vauxhall Motors Limited. Terms and conditions apply - please see your Vauxhall Retailer for details.

VAUXHALL ASSISTANCE

Vauxhall Assistance is provided automatically with every new Vauxhall for 12 months from first registration and covers everything from accident assistance, roadside recovery and 'at home' service to flat tyres. With Vauxhall Assistance help is literally just a free* phone call away, 24 hours a day, 365 days a year!

* = Mobile phone users will be charged at their standard tariff.

PROTECTING THE ENVIRONMENT

Vauxhall's commitment to the environment is demonstrated by our products' many environmental awards. For even more information on Vauxhall's efforts to achieve an environmentally sustainable future, and how to dispose of your end-of-life vehicle, see www.vauxhall.co.uk/recycling

VAUXHALL SERVICE PLAN

- Fixed monthly payments for the plan duration
- Easy to budget and interest-free
- Genuine parts fitted by Vauxhall-trained technicians

Plus on Gold plans:

- Valet and courtesy car
- Full AA cover
- Engine flush and fuel treatments
- Litre of oil for top ups between services

Full details can be obtained from your local participating Vauxhall Retailer.

VAUXHALL INSURANCE WITH ADDED REASSURANCE

Comprehensive cover – Summary of benefits**

- Competitive premiums
- Repairs by a Vauxhall-trained technician
- Genuine Vauxhall parts, guaranteed for three years when we repair your car within our Approved Repairer Network
- Free courtesy car as standard when using an Approved Repairer†
- 24 hour claims helpline
- Personal Accident benefit
- Cover for audio equipment
- Windscreen cover

Call for a quote on 0844 463 2670††

** = The benefits listed above are for comprehensive cover only. For details of Third Party, Fire and Theft cover, please call our sales team.

† = Should your car need repairing following an accident we provide a courtesy car (subject to availability) for the duration of the repair.

Only genuine Vauxhall parts are used. Terms and conditions apply.

†† = Calls may be recorded. Vauxhall Insurance is underwritten by Ageas Insurance Limited.

FOR MORE PRODUCT INFORMATION

For a brochure on any Vauxhall model (up to a maximum of three per caller) or location of your nearest Vauxhall Retailer please call **0345 600 1500**. Alternatively, details can be found on our website at www.vauxhall.co.uk

JOIN US ONLINE:



PROUD SPONSOR OF OUR NATIONAL FOOTBALL TEAMS



Privacy Policy – For full details please visit: vauxhall.co.uk/privacy

Vauxhall OnStar privacy details are available at vauxhall.co.uk/onstar

The invoice price, including delivery to Retailer, factory-fitted options, accessories fitted by the Retailer and number plates, is subject to VAT. Some feature descriptions in this guide may refer to, and some illustrations may show, optional equipment not included in the standard delivery. The information contained in this guide was accurate at the time of publication. We reserve the right to make changes in design and equipment. Please note that Vauxhall Retailers are not the agents of Vauxhall Motors Limited and are not authorised to bind Vauxhall Motors Limited by any specific or implied undertaking or representation. It is advisable to ensure that your motor insurance policy provides adequate cover for additional fitted options and accessories. The colours in this guide are only approximate actual colours. Illustrated optional equipment is available at extra charge. Availability, technical features and equipment provided on our vehicles can vary by model. For precise information on the equipment provided on our vehicles, please contact your local Vauxhall Retailer.

VAUXHALL

vauxhall.co.uk

©2017 Vauxhall Motors Limited

Published 18 September 2017 Vauxhall Motors Limited

ADAM ROCKS PRICE/SPECIFICATION GUIDE

1 April 2017 | Model Year 2017.5



Model Year 2017.5

ADAM ROCKS COMPANY CAR DRIVER/FLEET INFORMATION

COMPANY CAR DRIVER FREE* 3 DAY TEST DRIVE



Our free* 3 Day Test Drive programme is open to all Company Car Drivers which allows you to choose any model in the current Vauxhall line-up (excluding all VXR models and Commercial Vehicles), with full insurance cover provided, to give you a meaningful length of time to make an informed decision about your next company car.

Click below to book your free* test drive
www.vauxhall3dtd.co.uk
or call 0330 587 8221**

*The free 3 Day Test Drive programme is open to Company Car Drivers and excludes fuel and lubricants; congestion charges; parking and speeding fines and the £250 insurance excess (if applicable). It features a wide selection of models from the Vauxhall range (excluding all VXR models and Commercial Vehicles and subject to availability). Drivers must be aged 25 years or over, have held a full driving licence for at least a year and hold a major credit card. You will need to have your driving licence (and proof of identity (i.e. passport) where the driving licence is not a photocard licence) when your car is delivered. While every effort will be made to ensure that at least 3 days are provided for the test drive, this cannot always be guaranteed due to delivery and collection dates and timings. Available for UK Mainland only. Terms and conditions apply. **Telephone lines open Monday-Friday 9.00am to 5.00pm excluding Bank Holidays. Calls may be recorded or monitored for quality and/or training purposes.

FLEET TOOLBOX



Discover the facts in our online Toolbox for both Company Car Drivers and Fleet Decision Makers. The Fleet Toolbox has a host of useful calculators, comparators, interactive listings and information. Visit the Fleet Toolbox by going to www.vauxhall-toolbox.co.uk

ROADTRIP APP



The Vauxhall RoadTrip App is a free app that calculates and logs your mileage expenses for any UK business trips and generates reports to help you complete your mileage claims. Available for both iPhone and Android, visit www.vauxhall-toolbox.co.uk or visit the iPhone or Android stores and search for Vauxhall RoadTrip to download it to your smartphone or tablet.

BENEFIT IN KIND COMPANY CAR TAXATION†

The car benefit charge will be the car's list price (including VAT, options and accessories fitted, delivery to Retailer and number plates, but excluding Vehicle Excise Duty and new vehicle first registration fee) multiplied by the percentage charge for the CO₂ emissions band in which the car falls (see table opposite). Multiply this figure by your personal income tax rate (20% for Basic Rate, 40% for Higher Rate) to calculate your annual benefit in kind tax liability.

Example:

ADAM ROCKS 1.2i (70PS) (CO ₂ emissions 125g/km)	
On-the-road RRP	£15495.00
Deduct: Vehicle Excise Duty	(£160.00)
New vehicle first registration fee	(£55.00)
Effective list price	£15280.00
Add: Optional two-coat metallic paint	£555.00
List price for tax purposes (P11D value)	£15835.00
Car benefit charge	
2017-18 tax year (24%)	£3800.00
Benefit in kind tax liability (2017-18 tax year)	
Basic Rate (20%) tax payer	£760.00
Higher Rate (40%) tax payer	£1520.00

† = Please note this Price Guide provides taxation information as a guide only. Vauxhall does not provide taxation guidance. Drivers should always take professional advice on their own tax position.

CO ₂ emissions in grams per kilometre	Percentage of car's price to be taxed	
	Petrol 2017-18 tax year	Diesel 2017-18 tax year
up to 50	9	12
51-75	13	16
76-94	17	20
95-99	18	21
100-104	19	22
105-109	20	23
110-114	21	24
115-119	22	25
120-124	23	26
125-129	24	27
130-134	25	28
135-139	26	29
140-144	27	30
145-149	28	31
150-154	29	32
155-159	30	33
160-164	31	34
165-169	32	35
170-174	33	36
175-179	34	37
180-184	35	37
185-189	36	37
190 and above	37	37

To calculate your own personal liability a car tax calculator is available at: <https://www.vauxhallfleet.co.uk/toolbox>

CONTACT VAUXHALL FLEET

Please contact one of our dedicated sales teams who will be happy to help with your particular enquiry.

Company Car Drivers
Call: 0345 111 2020

Email: company-car@vauxhallinfo.co.uk

Telephone lines are open

– Monday to Friday 8.00am-9.00pm

– Saturday and Sunday 9.00am-6.00pm

Fleet Decision Makers

Depending on the size of your fleet of vehicles, we have a dedicated team to handle your enquiries. The lines are open Monday to Friday excluding Bank Holidays.

1-24 vehicles

Call: 0845 076 2254 (8.30am-5.00pm)

Email: b2bsales@vauxhall.co.uk

25+ vehicles

Call: 0330 587 8222 (8.30am-5.00pm)

Email: vauxhallfleet@vauxhall.co.uk

Special Vehicles (Police, Fire and Ambulance)

Call: 01582 409999 (8.30am-5.00pm)

Email: vauxhallspecialvehicles@vauxhall.co.uk

ADAM ROCKS PRICES

Model	Price (£)	VAT (£)	Total (£)	On-the-road RRP (£)	CO ₂ (g/km)
3-door CUV					
ADAM ROCKS VAUXHALL OnStar					
1.2i (70PS)	12150.00	2430.00	14580.00	15495.00	125
1.0i Turbo (115PS) Start/Stop ecoFLEX	13733.33	2746.67	16480.00	17395.00	112
ADAM ROCKS AIR VAUXHALL OnStar					
1.2i (70PS)	12983.33	2596.67	15580.00	16495.00	125
1.4i (87PS)	13125.00	2625.00	15750.00	16665.00	125
1.0i Turbo (115PS) Start/Stop ecoFLEX	14566.67	2913.33	17480.00	18395.00	112
ADAM ROCKS S VAUXHALL OnStar					
1.4i Turbo (150PS) Start/Stop	15641.67	3128.33	18770.00	19725.00	139

Please note: On-the-road recommended retail prices (RRP) include number plates and delivery to Retailer of £700.00 (inc. £116.67 VAT), 12 months' Vehicle Excise Duty and new vehicle first registration fee of £55.00. Excludes fuel and insurance.

ADAM ROCKS £15,495-£17,395

Standard features include:

- Vauxhall OnStar
- Anthracite protective mouldings for wheel arches, lower doors and side sills
- Anthracite front and rear bumpers with alloy-effect visible underbody protection
- Ride height increased by 15mm compared to ADAM JAM, GLAM, SLAM and ENERGISED models
- Dark-tinted rear windows
- Chrome-effect exhaust tailpipe extension
- Alloy-effect surround for front indicators, reversing light and rear fog light
- Air conditioning
- CD player with USB facility and aux-in socket
- Digital radio
- Bluetooth® mobile phone portal
- Music streaming via Bluetooth®
- Steering wheel mounted audio controls
- Leather-covered steering wheel
- Ocio Black Cloth/Morrocana seats
- Cruise control and trip computer
- Electronic Stability Programme-plus (ESP-plus)
- Anti-lock Braking System (ABS)
- Tyre pressure monitoring system
- Six airbags
- Body-colour door handles with chrome-effect insert
- Chrome-effect upper side window mouldings
- Chrome-effect door sill covers
- LED daytime running lights and tail lights
- 17-inch Sterling Silver Swiss Blade alloy wheels
- Black Jack roof and door mirrors
- Roof and door mirrors in a range of colours available at no cost

ADAM ROCKS AIR £16,495-£18,395

Feature over ADAM ROCKS:

- Electrically operated folding canvas roof

ADAM ROCKS S £19,725

Features over ADAM ROCKS:

- Electrically operated folding canvas roof
- 18-inch Gloss Black Y-spoke alloy wheels
- Sports suspension
- Uprated brakes with red brake calipers
- Unique rear roof spoiler
- Red your Engine Black cloth/Morrocana seats
- Red your Engine facia and door panel inserts

Please note: ADAM ROCKS S does not feature chrome-effect inserts in the body-colour door handles.

ADAM ROCKS FEATURES/OPTIONS

SAFETY

Standard features

- Airbags:** • Driver's airbag • Front passenger's airbag • Front seat side-impact airbags • Full-size curtain airbags for front and rear seat passengers • Deactivation switch for front passenger's front and side-impact airbags – Ensures front passenger airbags do not inflate when a child seat is fitted to the front passenger's seat
- Seating:** • Height-adjustable front and rear seat head restraints • Four lap and diagonal inertia-reel seatbelts • Front body-lock diagonal seatbelt pretensioner system – Tightens the seatbelt during the early stages of a frontal impact • Driver's and front passenger's lap belt pretensioner system • Front seatbelt force limiters – Reduces potential upper body injuries during a frontal impact • Anti-submarining ramps in front seats • ISOFIX child seat restraint system for rear seats incorporating top tether (does not include child seat) – Secures specially designed ISOFIX child safety seats to the vehicle itself, virtually eliminating the dangers that can result from improper installation
- Electronic:** • Electronic Stability Programme-plus (ESP-plus) – Reduces the possibility of losing control of the vehicle • Anti-lock Braking System (ABS) • Electronic brakeforce distribution • Cornering brake control • Emergency brake assist – Increases brakeforce applied in emergency braking situations • Hill start assist • Straight line stability control • Traction control • Adaptive brake lights – If the driver brakes hard enough to activate the ABS function the brake lights flash on and off at a frequency of five times per second, warning following vehicles that heavy braking is in progress • Tyre pressure monitoring system
- Body:** • Energy-absorbing steering column • Pedal release system – Reduces potential injury to the driver's legs and feet during a severe frontal impact • Laminated windscreen • Side-impact protection beams • Reinforced passenger safety cell • Deformation zones front and rear
- Pedestrian:** • Collapsible windscreen wiper system – Reduces the risk of head injury • Low density foam near front bumper crossmember – Reduces lower leg injuries • Plastic lower front bumper stiffener – Reduces knee injuries

Additional feature

	ADAM ROCKS	ADAM ROCKS AIR	ADAM ROCKS S	Price (£) exc. VAT	Total (£) inc. VAT
Switchable Electronic Stability Programme-plus (ESP-plus)			●		

SECURITY

- Standard features** • Remote control two-stage central deadlocking (doors, tailgate, fuel filler flap) • Visible Vehicle Identification Number (VIN) plate • Electronic engine deadlock immobiliser • Electronic theft protection for audio equipment • Driver's and front passenger's internal central locking switch • Locking wheel nuts • Luggage area cover • Folding key

Additional feature

	ADAM ROCKS	ADAM ROCKS AIR	ADAM ROCKS S	Price (£) exc. VAT	Total (£) inc. VAT
Remote control security alarm system	○	○	○	216.67	260.00

HEATING AND VENTILATION

- Standard features** • Interior pollen filter • Air recirculation with activation light • Air blend heater

Additional feature

	ADAM ROCKS	ADAM ROCKS AIR	ADAM ROCKS S	Price (£) exc. VAT	Total (£) inc. VAT
Air conditioning with four-speed fan	●	●			
Electronic climate control incorporating air conditioning with six-speed fan	○	○	●	258.33	310.00

● = Standard equipment. ○ = Optional at extra cost.

ADAM ROCKS FEATURES/OPTIONS

FACIA, INSTRUMENTS AND CONTROLS

Standard features • Leather-covered steering wheel • Multi-function trip computer¹ • Cruise control with speed limiter function • Shift-up indication light (Start/Stop models only) • Rev counter • Digital clock with automatic RDS time adjustment • Black instruments with chrome edging • Steering column adjustable for reach and rake • Electronic odometer and trip odometer • Instrument panel light dimmer • Handbrake-on/low brake fluid level and low fuel level warning lights • Service interval monitor • Seatbelt unfastened warning light for front and rear seats

	ADAM ROCKS	ADAM ROCKS AIR	ADAM ROCKS S	Price (£) exc. VAT	Total (£) inc. VAT
Additional features					
City mode button providing lighter steering at parking speeds	●	●			
Winter Pack ² • Electrically heated front seats • Electrically heated leather-covered three-spoke steering wheel	○	○	○ ³	187.50	225.00

INTERIOR FEATURES

Standard features • Driver's and front passenger's seats with reach and rake adjustment • Driver's seat height adjuster • Map pocket on front seat backs • 12-volt auxiliary power socket within centre console • Drinks holder in front centre console with adjustable restraining strap • Two drinks holders in rear centre console • Chrome-effect interior door handles • Colour-keyed fleece velour carpet • Front door pockets • Front assist handles • Fully carpeted and illuminated luggage area • Twin sunvisors incorporating driver's vanity mirror with cover • Courtesy lighting operated by door switches • 50/50 split-folding rear seat back

	ADAM ROCKS	ADAM ROCKS AIR	ADAM ROCKS S	Price (£) exc. VAT	Total (£) inc. VAT
Additional features					
Electro-chromatic anti-dazzle rear-view mirror (part of Sight and Light Pack One)	□	□	□		
Japan Black fascia and door panel inserts	● ⁴	● ⁵	N/C	No-cost option	
Facia and door panel inserts matched to exterior colour	● ⁶				
Pearl White fascia and door panel inserts	● ⁷	● ⁸			
Red your Engine fascia and door panel inserts			●		
Black Cloth/Morrocana interior	●	●	●		
Caramel Cloth/Morrocana interior	N/C			No-cost option	
Black Leather seat facings, electrically heated front seats, electrically heated leather-covered three-spoke steering wheel and front passenger's seat height adjuster	○	○		591.67	710.00
Recaro sports front seats, Black Track Cloth/Morrocana trim and front passenger's seat height adjuster			○ ⁹	875.00	1050.00
Recaro sports front seats, Black Nappa Leather seat facings, electrically heated front seats, electrically heated leather-covered three-spoke steering wheel and front passenger's seat height adjuster			○	1350.00	1620.00
Electrically heated front seats (part of Winter Pack, also included with Leather seat facings)	□	□	□		
Sports pedals			●		
Black ADAM S velour floor mats			●		

MECHANICAL FEATURES

Standard features • Speed-sensitive power-assisted steering • Five-speed manual gearbox (1.2i (70PS) and 1.4i (87PS) models) • Six-speed manual gearbox (1.0i Turbo (115PS) and 1.4i Turbo (150PS) models)

	ADAM ROCKS	ADAM ROCKS AIR	ADAM ROCKS S	Price (£) exc. VAT	Total (£) inc. VAT
Additional features					
Ride height increased by 15mm compared to ADAM JAM, GLAM, SLAM and ENERGISED models	●	●			
Sports suspension			●		

● = Standard equipment. ○ = Optional at extra cost. □ = Available as part of an option pack. N/C = No-cost option.

¹ = Information displayed: instantaneous fuel consumption, average fuel consumption, range remaining, outside temperature. ² = Fitted at no extra cost in conjunction with optional leather seat facings. ³ = Not available in conjunction with Black Track Cloth/Morrocana Recaro sports front seats. ⁴ = Standard on Black Jack, Shades of Grey and Heavy Metal models. Not available with other exterior colours. ⁵ = Standard on Orange Alert, Red 'n' Roll, Mint my Mind, Black Jack, Pump up the Blue and Let it Blue models. Not available with other exterior colours. ⁶ = Standard on Orange Alert, Red 'n' Roll, Mint my Mind, Pump up the Blue and Let it Blue models. Not available with other exterior colours. ⁷ = Standard on Saturday White Fever and White my Fire models. Not available with other exterior colours. ⁸ = Standard on Saturday White Fever, White my Fire, Shades of Grey and Heavy Metal models. Not available with other exterior colours. ⁹ = Not available in conjunction with Winter Pack.

ADAM ROCKS FEATURES/OPTIONS

EXTERIOR FEATURES

Standard features • Anthracite protective mouldings for wheel arches, lower doors and side sills • Anthracite front and rear bumpers with alloy-effect visible underbody protection • Alloy-effect surround for front indicators, reversing light and rear fog light • Tinted glass • Dark-tinted rear windows • Chrome-effect upper side window mouldings • Chrome-effect door sill covers • Heated rear window with automatic timed cut-off • Rear window wash/wipe • Electrically operated front windows with safety autoreverse and one-touch facility • Electrically adjustable/heated door mirrors • Black B-pillars • LED daytime running lights • LED tail lights • Lights-on audible warning • Welcome lighting • Twin gas-assisted tailgate struts • Chrome-effect exhaust tailpipe extension

	ADAM ROCKS	ADAM ROCKS AIR	ADAM ROCKS S	Price (£) exc. VAT	Total (£) inc. VAT
Additional features					
Body-colour door handles			●		
Body-colour door handles with chrome-effect insert	●	●			
Electrically operated folding canvas roof in Black		●	●		
Unique ADAM ROCKS S rear roof spoiler			●		
Black Jack Roof Colour Pack • Black Jack roof and door mirrors	●	●	●		
White my Fire Roof Colour Pack • White my Fire roof and door mirrors	N/C	N/C	N/C		No-cost option
Shades of Grey Roof Colour Pack ¹⁰ • Shades of Grey roof and door mirrors	N/C	N/C	N/C		No-cost option
Let it Blue Roof Colour Pack • Let it Blue roof and door mirrors			N/C		No-cost option
Red 'n' Roll Roof Colour Pack • Red 'n' Roll roof and door mirrors			N/C		No-cost option
Body-colour roof and door mirrors	N/C	N/C	N/C		No-cost option
Extreme Carbon Pack • Carbon fibre-effect door mirrors, front grille bar and rear-view mirror	○	○	○	175.00	210.00
Sight and Light Pack One ¹¹ • Rain-sensitive windscreen wipers • Automatic lighting control with tunnel detection • Electro-chromatic anti-dazzle rear-view mirror	○	○	○	200.00	240.00
Sight and Light Pack Two ¹² • Rain-sensitive windscreen wipers • Automatic lighting control with tunnel detection	○	○	○	175.00	210.00
Technical Pack • R4.0 IntelliLink • Rear parking distance sensors	○	○	○	429.17	515.00
Rear parking distance sensors	○	○	○	237.50	285.00

● = Standard equipment. ○ = Optional at extra cost. N/C = No-cost option.

10 = Not available on Heavy Metal models. 11 = Not available in conjunction with Extreme Carbon Pack. 12 = Only available in conjunction with Extreme Carbon Pack.

ADAM ROCKS FEATURES/OPTIONS

EXTERIOR COLOURS

		ADAM ROCKS	ADAM ROCKS AIR	ADAM ROCKS S	Price (£) exc. VAT	Total (£) inc. VAT
	Orange Alert • Solid paint	●	●			
	Red 'n' Roll • Brilliant paint	○	○	●	237.50	285.00
	Saturday White Fever • Brilliant paint	○	○	○	237.50	285.00
	Mint my Mind • Brilliant paint	○	○		237.50	285.00
	Black Jack • Two-coat metallic paint					
	Heavy Metal • Two-coat metallic paint • Not available with Shades of Grey Roof Colour Pack					
	Let it Blue • Two-coat pearlescent paint					
	Shades of Grey • Two-coat metallic paint					
	Pump up the Blue • Two-coat pearlescent paint	○	○	○	462.50	555.00

● = Standard equipment. ○ = Optional at extra cost.

The colours reproduced may vary slightly from the actual paint colour. As a result they should be used as a guide only. Your Vauxhall Retailer has a comprehensive display of our paint samples.

ADAM ROCKS FEATURES/OPTIONS

AUDIO, COMMUNICATION AND NAVIGATION

Standard features • Digital radio • Bluetooth® mobile phone portal • Bluetooth® audio streaming • Steering wheel mounted audio controls

	ADAM ROCKS	ADAM ROCKS AIR	ADAM ROCKS S	Price (£) exc. VAT	Total (£) inc. VAT
Additional features					
CD/MP3 CD player/stereo radio • CD/MP3 CD player • USB connection with iPod control • AM/FM stereo radio with 36 station presets • RDS with Traffic Programme • 20 watts per channel output	●	●	●		
R4.0 IntelliLink touchscreen infotainment system – For use with MP3 players, USB memory sticks, mobile phones and smartphone apps Onboard features: • 7-inch colour touchscreen • AM/FM stereo radio with 36 station presets • RDS with Traffic Programme • 20 watts per channel output Media connections: • USB connection with iPod control • Bluetooth® A2DP audio streaming (Advanced Audio Distribution Profile) Mobile phone portal: • Bluetooth® connectivity • Handsfree calls via steering wheel controls • Vehicle microphone • Phone book access – Contacts/last calls/missed calls etc. are mirrored on IntelliLink's display and are easily navigated using the touchscreen (features dependent on mobile phone) Smartphone interface: • Apple CarPlay™ • Android Auto™	□	□	□		
Aux-in socket (deleted if optional Technical Pack is specified)	●	●	●		
Six speakers	●	●	●		
Vauxhall OnStar*	●	●	●		

● = Standard equipment. □ = Available as part of an option pack.

* = Includes 12 months of OnStar services from date of first registration and a 3 month/3 GB Wi-Fi free trial period (whichever comes first) effective from the date the customer accepts the nominated network operator Wi-Fi Ts&Cs. Does not include destination download feature. Theft alert feature only operates if optional security alarm system is specified.

VAUXHALL ONSTAR – YOUR PERSONAL ON BOARD ASSISTANT

Many car brands talk about innovation as soon as they improve their cup holders but this innovative system, now available on selected models**, is revolutionary: 24/7, 365 days a year, Vauxhall OnStar puts you in touch with a trained advisor, not a machine. With OnStar you have access to a host of innovations, from Vehicle Diagnostics and Smartphone Function to a fully integrated 4G Wi-Fi Hotspot†. In the event of an accident, Vauxhall OnStar even automatically calls for help, for an incomparable feeling of safety.

** = The OnStar Services require activation and are subject to mobile network coverage and availability. Wi-Fi Hotspot service requires account with nominated network operator.

† = 4G is subject to mobile network coverage and availability. Charges apply after the free trial period. The OnStar subscription packages could be different from the services included in the free trial package. Check www.vauxhall.co.uk/onstar for terms and conditions, details of availability, coverage and charges.

DIGITAL RADIO

Now widely available in the UK, digital radio broadcasts offer the user a variety of advantages over traditional FM, starting with the digital quality sound which is immune to any hiss or crackle.

You'll often find a broader range of stations on offer too, many of which are not available on FM, and listening to them couldn't be easier – you simply select the station, by name, from the displayed list, thus removing the need to retune or look for stations when travelling around. Some stations will even display the artists' names and song titles on the car's graphic display, while they're played.

INTELLILINK

IntelliLink is Vauxhall's next-generation in-car infotainment system. It features a 7-inch colour touchscreen that enables access to, and operation of, a wide range of functions including music, video, phone, navigation and internet services.

The system isn't equipped with a CD or DVD player. Instead, it's designed to support the latest media sources including Bluetooth® and USB devices, together with smartphones and their applications. All of these features are accessed through the touchscreen's Home menu.

Since many of these features are accessed via smartphone, the IntelliLink unit is designed to allow application updates as and when they become available, thus enabling it to make use of the latest smartphone developments as they happen.

Music can be played either through the radio or from personal music players via USB connection or Bluetooth® audio streaming. When played via USB, IntelliLink's built-in Gracenote® link provides song information and album artwork. Films and slide shows can also be viewed via the USB connection, but this facility is disabled when the car is moving.

IntelliLink is able to pair with up to four Bluetooth® phones simultaneously, with each phone's address book downloaded to the audio unit so that the car effectively becomes the phone. Phone priority can then be set through the touchscreen display.

The smartphone link works in conjunction with Apple CarPlay (including Siri Eyes Free) and Android Auto. These give access to satellite navigation and a wide range of internet radio stations.



ADAM ROCKS FEATURES/OPTIONS

WHEELS AND TYRES

Features		ADAM ROCKS	ADAM ROCKS AIR	ADAM ROCKS S	Price (£) exc. VAT	Total (£) inc. VAT
	17-inch Sterling Silver Swiss Blade alloy wheels • 215/45 R 17 tyres Emergency tyre inflation kit (in lieu of spare wheel)	●	●			
	18-inch Silver Turbine alloy wheels • 225/35 R 18 tyres Emergency tyre inflation kit (in lieu of spare wheel)	○	○		675.00	810.00
	18-inch Gloss Black Y-spoke alloy wheels • 225/35 R 18 tyres Emergency tyre inflation kit (in lieu of spare wheel)			●		
	18-inch Technical Grey Propellor diamond-cut alloy wheels • 225/35 R 18 tyres Emergency tyre inflation kit (in lieu of spare wheel)			N/C		No-cost option

● = Standard equipment. ○ = Optional at extra cost. N/C = No-cost option.

TYRE RATING

Tyre size	Fuel efficiency group	Wet grip performance	External noise	
			Measured (dB)	Group
215/45 R 17	C	B	71	
225/35 R 18	C	B	77	

Tyre rating according to EU Regulation 1222/2009

ADAM ROCKS SPECIFICATIONS

PETROL ENGINES

	1.2i (70PS) ECOTEC-4	1.4i (87PS) ECOTEC-4	1.0i Turbo (115PS) with Start/Stop
Capacity	1229cc	1398cc	998cc
Maximum power	70PS (51kW) @ 5600rpm	87PS (64kW) @ 6000rpm	115PS (85kW) @ 5200rpm
Maximum torque	115Nm (85 lb.ft.) @ 4000rpm	130Nm (96 lb.ft.) @ 4000rpm	170Nm (125 lb.ft.) @ 1800-4500rpm
Configuration	4 cylinders, 4 valves per cylinder, double overhead camshafts	4 cylinders, 4 valves per cylinder, double overhead camshafts	3 cylinders, 4 valves per cylinder, double overhead camshafts
Fuel/induction system	Naturally aspirated. Variable Valve Timing. Multi-point sequential fuel injection	Naturally aspirated. Variable Valve Timing. Multi-point sequential fuel injection	Water-cooled turbocharger with intercooler. Variable Valve Timing (VVT) Central direct injection
Emission compliance	Euro 6	Euro 6	Euro 6
Service interval	20,000 miles or 1 year (whichever occurs sooner)	20,000 miles or 1 year (whichever occurs sooner)	20,000 miles or 1 year (whichever occurs sooner)

	1.4i Turbo (150PS) ECOTEC-4 with Start/Stop
Capacity	1364cc
Maximum power	150PS (110kW) @ 4900-5500rpm
Maximum torque	220Nm (162 lb.ft.) @ 2750-4500rpm
Configuration	4 cylinders, 4 valves per cylinder, double overhead camshafts
Fuel/induction system	Water-cooled turbocharger with intercooler. Variable Valve Timing (VVT) Multi-point sequential fuel injection
Emission compliance	Euro 6
Service interval	20,000 miles or 1 year (whichever occurs sooner)

PERFORMANCE, FUEL ECONOMY AND EMISSIONS

	Performance (manufacturer's figures)			Fuel economy mpg (litres/100km)#			CO ₂ emissions g/km#	Vehicle Excise Duty*		Benefit in kind company car taxation rates – 2017/18 tax year
	Wheel size (inches)	Maximum speed (mph)	Acceleration 0-62mph (sec)	Urban driving	Extra- urban driving	Combined figure		First year rate	Standard rate	
Manual										
1.2i (70PS)	17/18	103	14.9	39.2 (7.2)	65.7 (4.3)	53.3 (5.3)	125	£160	£140	24%
1.4i (87PS)	17/18	109	12.5	39.8 (7.1)	62.8 (4.5)	52.3 (5.4)	125	£160	£140	24%
1.0i Turbo (115PS) Start/Stop ecoFLEX	17/18	121	9.9	47.1 (6.0)	67.3 (4.2)	57.6 (4.9)	112	£160	£140	21%
1.4i Turbo (150PS) Start/Stop	18	130	8.5	37.2 (7.6)	57.6 (4.9)	47.9 (5.9)	139	£200	£140	26%

* = Correct at time of publication.

= Fuel consumption information is official government environmental data, tested in accordance with the relevant EU directive. Official EU-regulated test data is provided for comparison purposes and actual performance will depend on driving style, road conditions and other non-technical factors.

ADAM ROCKS SPECIFICATIONS

START/STOP TECHNOLOGY

The ADAM ROCKS Start/Stop system offers real benefits by improving fuel economy and reducing CO₂ emissions, particularly in town. It does this by automatically stopping the engine when you come to a standstill, and then restarting as you prepare to move off.

Before automatically stopping the engine a number of system checks are carried out to ensure that it is both safe and practical to do so. To ensure safety, the driver must depress the clutch pedal, shift in to neutral, and then release the clutch pedal. System checks carried out before Auto Stop activates include:

- Start/Stop system is not manually deactivated via the facia button
- Sufficient brake vacuum is available to prevent the car rolling down an incline
- Battery is in good condition and charged
- Outside air temperature and engine temperature are above specified minima
- Electronic climate control (where fitted) is not in maximum heating or maximum cooling mode

If all of these conditions are satisfied then the vehicle will Auto Stop.

When you are ready to pull away from standstill, Auto Restart is activated by depressing the clutch pedal. Whilst at a standstill the vehicle is continually monitored. If necessary, the engine will automatically be restarted. Conditions that would initiate an Auto Restart include:

- Low battery level
- Cabin temperature is too high
- Driver's seatbelt unfastened or driver's door opened
- Bonnet is released or opened

TRANSMISSION

Five-speed manual gearbox:

Standard on 1.2i (70PS) and 1.4i (87PS) models.

Six-speed manual gearbox:

Standard on 1.0i Turbo (115PS) and 1.4i Turbo (150PS) models.

STEERING

- Speed-sensitive power-assisted steering

SUSPENSION

Front: Independent. MacPherson struts with gas-pressure dampers and coil springs. Anti-roll bar.

Rear: Compound crank with coil springs and gas-pressure dampers.

BRAKING AND STABILITY

- Electronic Stability Programme
- Cornering brake control
- Straight line stability control
- Anti-lock Braking System (ABS)
- Electronic brakeforce distribution
- Emergency brake assist
- Dual circuit, diagonally split braking system

1.2i (70PS)/1.4i (87PS)

Front ventilated discs: 257mm diameter

Rear drums: 203mm diameter

1.0i Turbo (115PS)

Front ventilated discs: 284mm diameter

Rear drums: 228mm diameter

1.4i Turbo (150PS)

Front ventilated discs: 308mm diameter

Rear discs: 264mm diameter

FUEL TANK CAPACITY

- 38 litres (8.4 gallons)

GROSS VEHICLE WEIGHTS ^{kg}

1.2i (70PS)	1470
1.4i (87PS)	1480
1.0i Turbo (115PS)	1510
1.4i Turbo (150PS)	1565

Gross vehicle weight is the total permissible weight of the vehicle including passengers and luggage. The maximum roof rack loading should not exceed 50kg.

EXTERIOR DIMENSIONS ^{millimetres (inches)}

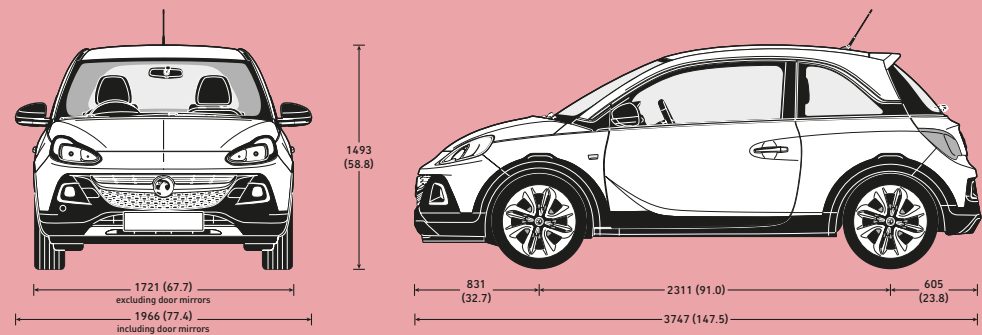

LOADSPACE DIMENSIONS

	millimetres (inches)
Maximum length (behind rear seats)	462 (18.2)
Maximum length (rear seats folded)	1041 (41.0)
Maximum width	963 (37.9)
Width between wheel arches	954 (37.6)
Maximum height	874 (34.4)

LUGGAGE CAPACITIES*

	litres (cu.ft.)
Rear seats up (under luggage compartment cover)	170 (6.0)
Rear seats folded (to upper edge of front seat back)	484 (17.1)
Rear seats folded (to roof)	663 (23.4)

* = Measured using the ECIE method.

ADAM ROCKS ACCESSORIES

	Total (inc. VAT)		Total (inc. VAT)		Total (inc. VAT)		Total (inc. VAT)
CHILD SEATS¹		EXTERIOR		TRANSPORT SYSTEMS		ALLOY WHEELS (set of four with centre caps)⁴	
BABY-SAFE ² – 0-13kg/birth to 15 months	£132.00	Door mirror caps (fitted)	from £105.00	Roof base carrier	£137.00	16-inch Horns	
– ISOFIX base	£227.00	Painted logo bar (fitted)	from £88.00	Roof carriers (requires base carrier)		– Silver	£811.00
DUO ISOFIX ² – 9-18kg/9 months to 4 years		'Fly' decals		Bike roof carrier – Thule Freeride 532	£76.00	– Black	£1052.00
with top tether kit	£347.00	– B-pillar decal (fitted)	£51.00	Surf board roof carrier – Thule 833	£101.00	16-inch Vintage	£954.00
KID ² – 15-36kg or 4 to 12 years	£157.00	– C-pillar decal (fitted)	£160.00	Kayak roof carrier – Thule 837	£168.00	16-inch Boomerang	
		'Splat' graphics		Ski roof carrier (400mm wide)		– Grey / diamond cut face	£758.00
		Front wing/rear quarter decals (fitted)	from £128.00	– Thule Deluxe 726	£ 138.00	– Green / diamond cut face	£1059.00
		'Sport 01' graphics		Ski roof carrier (600mm wide)		– White / diamond cut face	£1001.00
		– Bonnet decal (fitted)	from £93.00	– Thule 739	£235.00	16-inch Triple Cross	
		– Roof decal (fitted)	£113.00	Hard shell roof boxes (requires base carrier)		Titan grey	£804.00
		– C-pillar decal (fitted)	£95.00	Thule Ocean 80		Manoogian	£805.00
		'Stripes' graphics		(320 litre / 1330 x 860 x 370mm)	£235.00	18-inch Turbine	£1078.00
		– Bonnet decal (fitted)	from £130.00	Thule Ocean 200		17-inch Hurricane	
		– Roof decal (fitted)	from £127.00	(390 litre / 1750 x 820 x 450mm)	£316.00	– Manoogian	£1165.00
		– Door decals (fitted)	from £112.00	Thule Dynamic M		– Black	£898.00
		– Door / door mirror decals (fitted)	from £132.00	(320 litre / 2060 x 840 x 340mm)	from £625.00	– White	£891.00
		'Stars and Stripes' graphics		Thule Dynamic L		17-inch Swiss Blade	
		– Roof / B Pillar decals (fitted)	£193.00	(430 litre / 2350 x 940 x 350mm)	£846.00	– Silver	£904.00
		'Chequered' graphics		Thule Excellence		– Black / white rim	£746.00
		– Roof decal (fitted)	£121.00	(520 litre / 2180 x 940 x 400mm)	£898.00	– Black / red rim	£1084.00
		'Motorsport' graphics		Thule Motion 800		– Black / blue rim	£1077.00
		– Bonnet / body side decals (fitted)	£350.00	(460 litre / 2050 x 840 x 450mm)	from £515.00	17-inch Roulette	
		Body side protection mouldings (painted/fitted)	£211.00	Thule Touring 200		– Grey	£884.00
				(400 litre / 1750 x 820 x 450mm)	£372.00	– Grey / diamond cut face	£1165.00
				Thule Touring 780		– Grey / white face	£1405.00
				(430 litre / 2320 x 700 x 420mm)	£460.00	– Grey / brown face	£1405.00
				Soft roof boxes (requires base carrier)		– Grey / green face	£953.00
				Thule Ranger 90		– Copper / white face	£953.00
				(280 litre / 1100 x 800 x 400mm)	£285.00	– Copper / diamond cut face	£785.00
				Thule Ranger 500		– Black gloss	£898.00
				(300 litre / 1900 x 500 x 300mm)	£378.00	18-inch Twister	
				Tailgate carrier		– Grey	£1942.00
				Bike tailgate carrier – Thule BacPac 973	£282.00	– Manoogian	£1961.00
				Fitting kit	£48.00	Coloured wheel clips for Twister wheels (set of four)	from £70.00
				Flex-fix bicycle carrier – extension kit for third bicycle	£254.00	Tyre valve caps with Vauxhall logos – set of four	£23.00
						Locking wheel bolts	£43.00

1 = Restrictions apply to the use of child seats, please consult your Vauxhall Retailer or request a copy of the Child seats brochure.
2 = Without transponder.

FLEXCONNECT RANGE

FlexConnect bracket	£20.00
FlexConnect hook	£28.00
FlexConnect coat hanger	£58.00
FlexConnect folding table	£68.00
FlexConnect iPad Mini cradle	£98.00
FlexConnect iPad (1-4) cradle	£106.00
FlexConnect iPad Air cradle	£106.00
FlexConnect Samsung Galaxy cradle	£96.00

INTERIOR

Velour floor mats (set of four)	from £56.00
Rubber floor mats (set of four)	£46.00
Rear view mirror cap	from £57.00
Front console mat	£37.00
Centre console armrest	£89.00
Cargo box with lid	£183.00
Coloured leather gear knob and gaiter (fitted)	from £64.00
Stainless steel pedal covers – manual (fitted)	£164.00

VXR EXTERIOR STYLING³

VX-Line body styling – front lower spoiler/side sills/rear lower skirts (painted/fitted)	£1581.00
VX-Line body styling – rear roof spoiler (painted/fitted)	£539.00

3 = Not available on S models.

Please note:

Prices shown are a fully fitted and painted, where applicable and include VAT. Please check with your local Vauxhall Retailer for details. It is advisable to ensure your insurance policy is adequate to cover additional fitted accessories. Prices correct at time of publication.

4 = Different tyres and locking wheel bolts/nuts may be required at extra cost. Price excludes new tyres and locking wheel bolts/nuts, includes static wheel balancing.

ADAM ROCKS ADDITIONAL INFORMATION

ON-THE-ROAD PRICES

To eliminate uncertainty about hidden costs when buying a new car, Vauxhall publishes on-the-road recommended retail prices (RRP) and these are shown in the pricing tables within this price guide. These prices include the recommended cost of number plates and delivery to a Vauxhall Retailer of £700.00 (including £116.67 VAT), 12 months' Government Vehicle Excise Duty (see opposite for details) and the DVLA new vehicle first registration fee of £55.00*.

Please note: The on-the-road recommended retail price (RRP) does not include fuel supplied by the Retailer, motor insurance or any other goods or services supplied by agreement between the Retailer and the customer.

PRICE PROTECTION

Order a new Vauxhall for build in the current model year (as confirmed by your Retailer) for delivery no more than three months in advance and the price you are quoted is the price you pay. This is irrespective of any subsequent price rises between placing your order and delivery of your new car, but you must take delivery as soon as the car is available. Vauxhall Motors Limited is not liable for price adjustments caused by Government changes in the rate of VAT (currently 20%), Vehicle Excise Duty, DVLA new vehicle first registration fee or by any other applicable legislation or regulations.

E10 FUEL

E10 fuel is cleared for use in all petrol-engined Vauxhall vehicles excluding models with the 2.2 litre petrol engine (code Z22YH) used in Vectra, Signum and Zafira models. Owners of these vehicles should continue to use regular unleaded or premium unleaded petrol.

VEHICLE EXCISE DUTY

The amount of Vehicle Excise Duty (road fund licence) payable on new cars varies depending on the level of carbon dioxide (CO₂) emissions produced by the vehicle. CO₂ emissions are measured in grammes (g) per kilometre (km) travelled and divided into 13 charging bands shown in the table below.

A 'first year rate' of Vehicle Excise Duty is payable on all new cars and in subsequent years the amount payable reverts to the 'standard rate'. From 1 April 2017 the breakpoints for each of these bands have been revised. Also, for vehicles with a list price over £40,000, including factory-fitted options, an additional £310 is payable for the first five years of standard rate payments.

Vehicle Excise Duty*

	CO ₂ emissions (g/km)	First year rate	Standard rate
Band A	0	£0.00	£0.00
Band B	1-50	£10.00	£140.00
Band C	51-75	£25.00	£140.00
Band D	76-90	£100.00	£140.00
Band E	91-100	£120.00	£140.00
Band F	101-110	£140.00	£140.00
Band G	111-130	£160.00	£140.00
Band H	131-150	£200.00	£140.00
Band I	151-170	£500.00	£140.00
Band J	171-190	£800.00	£140.00
Band K	191-225	£1200.00	£140.00
Band L	226-255	£1700.00	£140.00
Band M	over 255	£2000.00	£140.00

* = Correct at time of issue.

PROTECTING THE ENVIRONMENT

Vauxhall's commitment to the environment is demonstrated by our products' many environmental awards. For even more information on Vauxhall's efforts to achieve an environmentally sustainable future, and how to dispose of your end-of-life vehicle, see www.vauxhall.co.uk/recycling

VAUXHALL ASSISTANCE

Vauxhall Assistance is provided automatically with every new Vauxhall for 12 months from first registration and covers everything from accident assistance, roadside recovery and 'at home' service to flat tyres. With Vauxhall Assistance help is literally just a free** phone call away, 24 hours a day, 365 days a year!

** = Mobile phone users will be charged at their standard tariff.

VAUXHALL LEASING

As Vauxhall's own contract hire and fleet management operation, Vauxhall Leasing provides a one-stop-shop for competitive car and van leasing solutions – for business users and private individuals. Working with the Vauxhall Retailer network, we combine the support of a national contract with the convenience of a local contact.

For further information, please see your local Vauxhall Retailer or call us on **0117 908 6433**. Alternatively, you can visit our website at www.vauxhall-leasing.co.uk

IN THE EVENT OF AN ACCIDENT...

Vauxhall Accident Management helps keep you mobile following an accident. Benefits include vehicle recovery, Vauxhall-approved repairs and contacting your insurer. For more details, visit vauxhall.co.uk/AccidentManagement

VAUXHALL SERVICE PLAN

Vauxhall Retailers offer a great service for owners of all Vauxhall cars. Value for money, regular offers and free check-ups, combined with the peace of mind that comes from using Vauxhall-trained technicians and genuine parts, help keep your car in peak condition at all times.

FOR MORE PRODUCT INFORMATION

For a brochure on any Vauxhall model (up to a maximum of three per caller) or location of your nearest Vauxhall Retailer please call **0345 600 1500**. Alternatively, details can be found on our website at www.vauxhall.co.uk

JOIN US ONLINE:



VAUXHALL INSURANCE WITH ADDED REASSURANCE

Comprehensive cover – Summary of benefits*

- Competitive premiums
- Repairs by a Vauxhall-trained technician
- Genuine Vauxhall parts, guaranteed for three years when we repair your car within our Approved Repairer Network
- Free courtesy car as standard when using an Approved Repairer**
- 24 hour claims helpline
- Personal Accident benefit
- Cover for audio equipment
- Windscreen cover

Call for a quote on 0844 463 2670†

*The benefits listed above are for comprehensive cover only. For details of Third Party, Fire and Theft cover, please call our sales team.
 **Should your car need repairing following an accident we provide a courtesy car (subject to availability) for the duration of the repair. Only genuine Vauxhall parts are used. Terms and conditions apply.
 † Calls may be recorded. Vauxhall Insurance is underwritten by Ageas Insurance Limited.

Every effort has been made to ensure that the contents of this document were accurate and up-to-date at the time of publication – 1 April 2017. The invoice price, including delivery to Retailer, factory-fitted options, accessories fitted by the Retailer and number plates, is subject to VAT. The right is reserved to alter specifications and prices, and withdraw products from sale, without notice. Please note that Vauxhall Retailers are not the agents of Vauxhall Motors Limited and are not authorised to bind Vauxhall Motors Limited by any specific or implied undertaking or representation. It is advisable to ensure that your motor insurance policy provides adequate cover for additional fitted options and accessories. All rights reserved. No part of this publication may be reproduced in any form or by any means, without the prior written permission of Vauxhall Motors Limited.

Vauxhall Motors Limited t/a Vauxhall, Griffin House, UK1-101-135, Osborne Road, Luton, Bedfordshire, LU1 3YT. www.vauxhall.co.uk

©2017 Vauxhall Motors Limited



VAUXHALL