

# ADAM

## PRICE/SPECIFICATION GUIDE

15 June 2018 | Model Year 2019



### Contents:

Model Year 2019 (pages 2-31)

Pre-current Model Year (pages 33-48)



**VAUXHALL**

British Brand since 1903

# ADAM RANGE HIGHLIGHTS



## JAM OTR from £13,450

Standard features include:

**Infotainment:**

- CD 30 BT audio system
  - AM/FM radio
  - CD/MP3 CD player
  - Bluetooth® audio streaming
  - Bluetooth® mobile phone portal
  - USB audio connection
  - Aux-in socket

**Interior convenience / styling:**

- Air conditioning
- Cruise control
- Leather-covered steering wheel
- Steering wheel audio / phone / cruise controls
- Multi-function trip computer

**Exterior convenience / styling:**

- 16-inch alloy wheels
- Electrically operated front windows
- Electrically adjustable / heated door mirrors

**Safety / security features:**

- Electronic Stability Programme (ESP)
- Anti-lock Braking System (ABS)
- Tyre pressure monitoring system
- Six airbags
- Daytime running lights
- Remote control central deadlocking



## GLAM OTR from £14,820

Standard features include:

**Infotainment:**

- CD 30 BT audio system
  - AM/FM/DAB digital radio
  - CD/MP3 CD player
  - Bluetooth® audio streaming
  - Bluetooth® mobile phone portal
  - USB audio connection
  - Aux-in socket

**Interior convenience / styling:**

- Electronic climate control
- Cruise control
- Leather-covered steering wheel
- Steering wheel audio / phone / cruise controls
- Multi-function trip computer

**Exterior convenience / styling:**

- 16-inch alloy wheels
- Fixed glass roof panel with sliding blind
- Electrically operated front windows
- Electrically adjustable / heated door mirrors
- Body-colour door handles with chrome-effect inserts
- Chrome-effect upper side window mouldings
- Chrome-effect door sill covers

**Safety / security features:**

- Electronic Stability Programme (ESP)
- Anti-lock Braking System (ABS)
- Tyre pressure monitoring system
- Six airbags
- Daytime running lights
- Remote control central deadlocking



## SLAM OTR from £15,785

Standard features include:

**Infotainment:**

- CD 30 BT audio system
  - AM/FM/DAB digital radio
  - CD/MP3 CD player
  - Bluetooth® audio streaming
  - Bluetooth® mobile phone portal
  - USB audio connection
  - Aux-in socket

**Interior convenience / styling:**

- Electronic climate control
- Cruise control
- Leather-covered steering wheel
- Steering wheel audio / phone / cruise controls
- Multi-function trip computer

**Exterior convenience / styling:**

- 17-inch alloy wheels
- Black Jack roof and door mirrors
- Roof and door mirrors in a range of colours available at no cost
- Dark-tinted rear windows
- Sports suspension
- Electrically operated front windows
- Electrically adjustable / heated door mirrors
- Chrome-effect upper side window mouldings
- Chrome-effect door sill covers

**Safety / security features:**

- Electronic Stability Programme (ESP)
- Anti-lock Braking System (ABS)
- Tyre pressure monitoring system
- Six airbags
- LED daytime running lights
- Remote control central deadlocking



# ADAM RANGE HIGHLIGHTS



<b>S</b>	<b>OTR £18,875</b>
<p><i>Standard features include:</i></p> <p><b>Infotainment:</b></p> <ul style="list-style-type: none"> <li>• CD 30 BT audio system                             <ul style="list-style-type: none"> <li>– AM/FM/DAB digital radio</li> <li>– CD/MP3 CD player</li> <li>– Bluetooth® audio streaming</li> <li>– Bluetooth® mobile phone portal</li> <li>– USB audio connection</li> <li>– Aux-in socket</li> </ul> </li> </ul> <p><b>Interior convenience / styling:</b></p> <ul style="list-style-type: none"> <li>• Electronic climate control</li> <li>• Cruise control</li> <li>• Leather-covered steering wheel</li> <li>• Steering wheel audio / phone / cruise controls</li> <li>• Multi-function trip computer</li> </ul> <p><b>Exterior convenience / styling:</b></p> <ul style="list-style-type: none"> <li>• 18-inch diamond-cut alloy wheels</li> <li>• Uprated brakes with red brake calipers</li> <li>• Air intakes in front lower bumper</li> <li>• Body-colour front lower spoiler, side sills and rear lower skirt</li> <li>• Unique rear roof spoiler</li> <li>• Black Jack roof and door mirrors</li> <li>• Roof and door mirrors in a range of colours available at no cost</li> <li>• Dark-tinted rear windows</li> <li>• Sports suspension</li> <li>• Electrically adjustable / heated door mirrors</li> <li>• Chrome-effect upper side window mouldings</li> <li>• Chrome-effect door sill covers</li> </ul>	
<p><b>Safety / security features:</b></p> <ul style="list-style-type: none"> <li>• Switchable Electronic Stability Programme (ESP)</li> <li>• Anti-lock Braking System (ABS)</li> <li>• Tyre pressure monitoring system</li> <li>• Six airbags</li> <li>• LED daytime running lights</li> <li>• Remote control central deadlocking</li> </ul>	
	

<b>ENERGISED</b>	<b>OTR £15,295</b>
<p><i>Standard features include:</i></p> <p><b>Infotainment:</b></p> <ul style="list-style-type: none"> <li>• IntelliLink audio system                             <ul style="list-style-type: none"> <li>– 7-inch colour touchscreen</li> <li>– AM/FM/DAB digital radio</li> <li>– Bluetooth® audio streaming</li> <li>– Bluetooth® mobile phone portal</li> <li>– Apple CarPlay™ / Android Auto™</li> <li>– USB audio connection</li> </ul> </li> </ul> <p><b>Interior convenience / styling:</b></p> <ul style="list-style-type: none"> <li>• Air conditioning</li> <li>• Cruise control</li> <li>• Leather-covered steering wheel</li> <li>• Steering wheel audio / phone / cruise controls</li> <li>• Multi-function trip computer</li> </ul> <p><b>Exterior convenience / styling:</b></p> <ul style="list-style-type: none"> <li>• 17-inch black alloy wheels</li> <li>• Black Jack roof and door mirrors</li> <li>• Gloss black front grille bar</li> <li>• Range of brilliant, metallic and premium colours available at no cost</li> <li>• Sports suspension</li> <li>• Electrically operated front windows</li> <li>• Electrically adjustable / heated door mirrors</li> </ul> <p><b>Safety / security features:</b></p> <ul style="list-style-type: none"> <li>• Electronic Stability Programme (ESP)</li> <li>• Anti-lock Braking System (ABS)</li> <li>• Tyre pressure monitoring system</li> <li>• Six airbags</li> <li>• Daytime running lights</li> <li>• Remote control central deadlocking</li> </ul>	
	

<b>ENERGISED BLACK JACK</b>	<b>OTR £15,570</b>
<p><i>Standard features include:</i></p> <p><b>Infotainment:</b></p> <ul style="list-style-type: none"> <li>• IntelliLink audio system                             <ul style="list-style-type: none"> <li>– 7-inch colour touchscreen</li> <li>– AM/FM/DAB digital radio</li> <li>– Bluetooth® audio streaming</li> <li>– Bluetooth® mobile phone portal</li> <li>– Apple CarPlay™ / Android Auto™</li> <li>– USB audio connection</li> </ul> </li> </ul> <p><b>Interior convenience / styling:</b></p> <ul style="list-style-type: none"> <li>• Air conditioning</li> <li>• Carbon fibre-effect rear-view mirror cover</li> <li>• Cruise control</li> <li>• Leather-covered steering wheel</li> <li>• Steering wheel audio / phone / cruise controls</li> </ul> <p><b>Exterior convenience / styling:</b></p> <ul style="list-style-type: none"> <li>• 17-inch black alloy wheels</li> <li>• Black Jack roof, bonnet and door mirrors</li> <li>• Dark-tinted rear windows</li> <li>• Gloss black front grille bar</li> <li>• Range of brilliant, metallic and premium colours available at no cost</li> <li>• Sports suspension</li> <li>• Electrically adjustable / heated door mirrors</li> </ul> <p><b>Safety / security features:</b></p> <ul style="list-style-type: none"> <li>• Electronic Stability Programme (ESP)</li> <li>• Anti-lock Braking System (ABS)</li> <li>• Tyre pressure monitoring system</li> <li>• Six airbags</li> <li>• Daytime running lights</li> <li>• Remote control central deadlocking</li> </ul>	
	





# ADAM JAM

3-door hatchback  
OTR RRP CO<sub>2</sub> (g/km)

## ADAM JAM – ON-THE-ROAD PRICES

Petrol 1.2i (70PS) **£13,450** 128

Please note: On-the-road recommended retail prices (RRP) include VAT at 20%, number plates and delivery to Retailer of £700.00 (inc. £116.67 VAT), 12 months' Vehicle Excise Duty and new vehicle first registration fee of £55.00. Excludes fuel and insurance.

KEY OPTIONS		Total inc. VAT
 <b>Looking good:</b>	Brilliant paint	<b>£285</b>
	Metallic paint	<b>£565</b>
	Premium paint	<b>£655</b>
	<b>Style Pack</b>	
	– Black Jack or White my Fire Roof Colour Pack / 17-inch alloy wheels / dark-tinted rear windows	<b>£705</b>
 <b>Easier parking:</b>	Rear parking sensors	<b>£285</b>
 <b>Driving assistance:</b>	Navi 4.0 IntelliLink navigation system	<b>£785</b>
	<b>Sight and Light Pack One</b> – Automatic lights / wipers / anti-dazzle rear-view mirror	<b>£240</b>
 <b>Warm welcome:</b>	<b>Winter Pack</b> – Heated front seats / steering wheel	<b>£225</b>
 <b>Practicality:</b>	Steel emergency spare wheel (in lieu of emergency tyre inflation kit)	<b>£110</b>

For details of these and other options please see Features / Options pages.



## FEATURES

### Infotainment:

- CD 30 BT audio system
  - AM/FM radio
  - CD/MP3 CD player
  - Bluetooth® audio streaming
  - Bluetooth® mobile phone portal
  - USB audio connection
  - Aux-in socket
- Four speakers

### Interior convenience / styling:

- Cruise control
- Air conditioning
- Leather-covered steering wheel
- Speed-sensitive power-assisted steering
- City mode button
- Steering column adjustable for reach / rake
- Steering wheel audio / phone / cruise controls
- Driver's seat height adjuster
- Multi-function trip computer
- 50/50 split-folding rear seat back





### Exterior convenience / styling:

- Electrically operated front windows
- Electrically adjustable / heated door mirrors
- Body-colour door handles
- Black B-pillars
- 16-inch alloy wheels

### Safety / security features:

- Electronic Stability Programme (ESP)
- Anti-lock Braking System (ABS)
- Six airbags
- Hill start assist
- Seatbelt reminders for all seats
- ISOFIX child seat mounting points on rear seats
- Tyre pressure monitoring system
- Daytime running lights
- Remote control central locking
- Engine deadlock immobiliser

## COMPANY CAR INFORMATION

-  P11D price starting at £13,230
-  From 26% tax band\*
-  From £58 monthly BiK tax\*
-  CO<sub>2</sub> emissions from 128g/km

Please see [www.vauxhall.co.uk/fleet](http://www.vauxhall.co.uk/fleet) for details.

\* = 2018/19 tax year.







# ADAM GLAM

3-door hatchback  
OTR RRP CO<sub>2</sub> (g/km)

## ADAM GLAM – ON-THE-ROAD PRICES

Petrol	1.2i (70PS)	£14,820	128
	1.4i (87PS)	£15,035	133

Please note: On-the-road recommended retail prices (RRP) include VAT at 20%, number plates and delivery to Retailer of £700.00 (inc. £116.67 VAT), 12 months' Vehicle Excise Duty and new vehicle first registration fee of £55.00. Excludes fuel and insurance.

KEY OPTIONS		Total inc. VAT
	<b>Looking good:</b>	
	Brilliant paint	£285
	Metallic / pearlescent paint	£565
	Premium paint	£655
	<b>Easier parking:</b>	
	Rear parking sensors	£285
	<b>Driving assistance:</b>	
	Navi 4.0 IntelliLink navigation system	£785
	<b>Sight and Light Pack One</b>	
	– Automatic lights / wipers / anti-dazzle rear-view mirror	£240
	<b>Warm welcome:</b>	
	Winter Pack – Heated front seats / steering wheel	£225
	<b>Practicality:</b>	
	Steel emergency spare wheel (in lieu of emergency tyre inflation kit)	£110

For details of these and other options please see Features / Options pages.



## FEATURES

### Infotainment:

- CD 30 BT audio system
  - AM/FM/DAB digital radio
  - CD/MP3 CD player
  - Bluetooth® audio streaming
  - Bluetooth® mobile phone portal
  - USB audio connection
  - Aux-in socket
- Six speakers

### Interior convenience / styling:

- Electronic climate control
- Cruise control
- Leather-covered steering wheel
- Speed-sensitive power-assisted steering
- City mode button
- Steering column adjustable for reach / rake
- Steering wheel audio / phone / cruise controls
- Driver's seat height adjuster
- Multi-function trip computer
- 50/50 split-folding rear seat





### Exterior convenience / styling:

- Fixed glass roof panel with sliding blind
- Electrically operated front windows
- Electrically adjustable / heated door mirrors
- Body-colour door handles with chrome-effect inserts
- Chrome-effect upper side window mouldings
- Black B-pillars
- 16-inch alloy wheels

### Safety / security features:

- Electronic Stability Programme (ESP)
- Anti-lock Braking System (ABS)
- Six airbags
- Hill start assist
- Seatbelt reminders for all seats
- ISOFIX child seat mounting points on rear seats
- Tyre pressure monitoring system
- Daytime running lights
- Remote control central locking
- Engine deadlock immobiliser

## COMPANY CAR INFORMATION

-  P11D price starting at £14,600
-  From 26% tax band\*
-  From £64 monthly BiK tax\*
-  CO<sub>2</sub> emissions from 128g/km

Please see [www.vauxhall.co.uk/fleet](http://www.vauxhall.co.uk/fleet) for details.

\* = 2018/19 tax year.

# ADAM SLAM

3-door hatchback  
OTR RRP CO<sub>2</sub> (g/km)

## ADAM SLAM – ON-THE-ROAD PRICES

Petrol	1.4i (87PS)	£15,785	133
	1.4i (100PS)	£16,360	134

Please note: On-the-road recommended retail prices (RRP) include VAT at 20%, number plates and delivery to Retailer of £700.00 (inc. £116.67 VAT), 12 months' Vehicle Excise Duty and new vehicle first registration fee of £55.00. Excludes fuel and insurance.

KEY OPTIONS		Total inc. VAT
	<b>Looking good:</b>	
	Brilliant paint	£285
	Metallic paint	£565
	Premium paint	£655
	<b>VXR Styling Pack</b> – Body-colour front spoiler / side sills / rear lower skirt / rear roof spoiler	£760
<b>Extreme Carbon Pack</b> – Carbon fibre-effect door mirrors / front grille bar / rear-view mirror cover	£210	
	<b>Easier parking:</b>	
	Rear parking sensors	£285
	<b>Driving assistance:</b>	
	Navi 4.0 IntelliLink navigation system	£785
	<b>Sight and Light Pack</b> – Automatic lights / wipers	from £210
	<b>Winter Pack</b> – Heated front seats / steering wheel	£225

For details of these and other options please see Features / Options pages.



## FEATURES

### Infotainment:

- CD 30 BT audio system
  - AM/FM/DAB digital radio
  - CD/MP3 CD player
  - Bluetooth® audio streaming
  - Bluetooth® mobile phone portal
  - USB audio connection
  - Aux-in socket
- Six speakers

### Interior convenience / styling:

- Electronic climate control
- Cruise control
- Leather-covered steering wheel
- Speed-sensitive power-assisted steering
- City mode button
- Steering column adjustable for reach / rake
- Steering wheel audio / phone / cruise controls
- Driver's seat height adjuster
- Multi-function trip computer
- 50/50 split-folding rear seat





### Exterior convenience / styling:

- Black Jack roof and door mirrors
- Dark-tinted rear windows
- Sports suspension
- Electrically operated front windows
- Electrically adjustable / heated door mirrors
- Chrome-effect upper side window mouldings
- Black B-pillars
- 17-inch alloy wheels

### Safety / security features:

- Electronic Stability Programme (ESP)
- Anti-lock Braking System (ABS)
- Six airbags
- Hill start assist
- Seatbelt reminders for all seats
- ISOFIX child seat mounting points on rear seats
- Tyre pressure monitoring system
- LED daytime running lights
- Remote control central locking
- Engine deadlock immobiliser

## COMPANY CAR INFORMATION

-  P11D price starting at £15,525
-  From 27% tax band\*
-  From £70 monthly BiK tax\*
-  CO<sub>2</sub> emissions from 133g/km

Please see [www.vauxhall.co.uk/fleet](http://www.vauxhall.co.uk/fleet) for details.

\* = 2018/19 tax year.

# ADAM S

3-door hatchback  
OTR RRP CO<sub>2</sub> (g/km)

## ADAM S – ON-THE-ROAD PRICES

Petrol 1.4i Turbo (150PS) Start/Stop **£18,875** 145

Please note: On-the-road recommended retail prices (RRP) include VAT at 20%, number plates and delivery to Retailer of £700.00 (inc. £116.67 VAT), 12 months' Vehicle Excise Duty and new vehicle first registration fee of £55.00. Excludes fuel and insurance.

KEY OPTIONS		Total inc. VAT
 <b>Looking good:</b>	Brilliant paint	<b>£285</b>
	Metallic paint	<b>£565</b>
	Premium paint	<b>£655</b>
	<b>Extreme Carbon Pack</b> – Carbon fibre-effect door mirrors / front grille bar / rear-view mirror cover / lower front and rear bumper inserts	<b>£285</b>
	Roof Colour Packs in a choice of colours	<b>No-cost</b>
 <b>Easier parking:</b>	Black Jack bonnet	<b>£100</b>
	Rear parking sensors	<b>£285</b>
 <b>Driving assistance:</b>	Navi 4.0 IntelliLink navigation system	<b>£785</b>
 <b>Sitting comfortably:</b>	<b>Recaro sports front seats</b> – Black Nappa leather seat facings / heated front seats / heated steering wheel	<b>£2300</b>
	<b>Winter Pack</b> – Heated front seats / steering wheel	<b>£225</b>

For details of these and other options please see Features / Options pages.



## FEATURES

### Infotainment:

- CD 30 BT audio system
  - AM/FM/DAB digital radio
  - CD/MP3 CD player
  - Bluetooth® audio streaming
  - Bluetooth® mobile phone portal
  - USB audio connection
  - Aux-in socket
- Six speakers

### Interior convenience / styling:

- Electronic climate control
- Cruise control
- Leather-covered steering wheel
- Sports pedals
- Steering column adjustable for reach / rake
- Steering wheel audio / phone / cruise controls
- Driver's seat height adjuster
- Multi-function trip computer
- 50/50 split-folding rear seat





### Exterior convenience / styling:

- Black Jack roof and door mirrors
- Uprated brakes with red brake calipers
- Body-colour front lower spoiler, side sills and rear lower skirt
- Unique rear roof spoiler
- Air intakes in front lower bumper
- Dark-tinted rear windows
- Sports suspension
- Electrically adjustable / heated door mirrors
- Black B-pillars
- 18-inch diamond-cut alloy wheels

### Safety / security features:

- Switchable Electronic Stability Programme (ESP)
- Anti-lock Braking System (ABS)
- Six airbags
- Hill start assist
- ISOFIX child seat mounting points on rear seats
- Tyre pressure monitoring system
- LED daytime running lights
- Remote control central locking
- Engine deadlock immobiliser

## COMPANY CAR INFORMATION

-  P11D price starting at £18,615
-  From 30% tax band\*
-  From £94 monthly BiK tax\*
-  CO<sub>2</sub> emissions from 145g/km

Please see [www.vauxhall.co.uk/fleet](http://www.vauxhall.co.uk/fleet) for details.

\* = 2018/19 tax year.

# ADAM ENERGISED

3-door hatchback  
OTR RRP CO<sub>2</sub> (g/km)

## ADAM ENERGISED – ON-THE-ROAD PRICES

Petrol 1.2i (70PS) £15,295 128

## ADAM ENERGISED BLACK JACK – ON-THE-ROAD PRICES

Petrol 1.2i (70PS) £15,570 128

Please note: On-the-road recommended retail prices (RRP) include VAT at 20%, number plates and delivery to Retailer of £700.00 (inc. £116.67 VAT), 12 months' Vehicle Excise Duty and new vehicle first registration fee of £55.00. Excludes fuel and insurance.

KEY OPTIONS		Total inc. VAT
 <b>Looking good:</b>	Brilliant paint	<b>No-cost</b>
	Metallic paint	<b>No-cost</b>
	Premium paint	<b>No-cost</b>
	Dark-tinted rear windows	<b>£175</b>

For details of these and other options please see Features / Options pages.



## FEATURES

### Infotainment:

- IntelliLink audio system
  - 7-inch colour touchscreen
  - AM/FM/DAB digital radio
  - Bluetooth® audio streaming
  - Bluetooth® mobile phone portal
  - Apple CarPlay™ / Android Auto™
  - USB audio connection
- Four speakers

### Interior convenience / styling:

- Air conditioning
- Leather-covered steering wheel
- Cruise control
- Speed-sensitive power-assisted steering
- City mode button
- Steering column adjustable for reach / rake
- Steering wheel audio / phone / cruise controls
- Driver's seat height adjuster
- Multi-function trip computer
- 50/50 split-folding rear seat

### Exterior convenience / styling:

- Black Jack roof and door mirrors
- Gloss black front grille bar
- Range of brilliant, metallic and premium colours available at no cost
- Electrically operated front windows
- Electrically adjustable / heated door mirrors
- Sports suspension
- 17-inch black alloy wheels

### Safety / security features:

- Electronic Stability Programme (ESP)
- Anti-lock Braking System (ABS)
- Six airbags
- Hill start assist
- Seatbelt reminders for all seats
- ISOFIX child seat mounting points on rear seats
- Tyre pressure monitoring system
- Daytime running lights
- Remote control central locking

### ADAM ENERGISED BLACK JACK models also feature:

- Black Jack bonnet
- Dark-tinted rear windows
- Carbon-fibre effect rear-view mirror cover



## COMPANY CAR INFORMATION

- ✓ P11D price starting at £15,075
- ✓ From 26% tax band\*
- ✓ From £66 monthly BiK tax\*
- ✓ CO<sub>2</sub> emissions from 128g/km

Please see [www.vauxhall.co.uk/fleet](http://www.vauxhall.co.uk/fleet) for details.

\* = 2018/19 tax year.



# ADAM PRICES

Model 3-door hatch	Price (£)	VAT (£)	Total (£)	On-the-road RRP (£)	CO <sub>2</sub> (g/km)
<b>ADAM JAM</b>					
1.2i (70PS)	10441.67	2088.33	12530.00	<b>13450.00</b>	128
<b>ADAM GLAM</b>					
1.2i (70PS)	11583.33	2316.67	13900.00	<b>14820.00</b>	128
1.4i (87PS)	11729.17	2345.83	14075.00	<b>15035.00</b>	133
<b>ADAM SLAM</b>					
1.4i (87PS)	12354.17	2470.83	14825.00	<b>15785.00</b>	133
1.4i (100PS)	12833.33	2566.67	15400.00	<b>16360.00</b>	134
<b>ADAM S</b>					
1.4i Turbo (150PS) Start/Stop	14929.17	2985.83	17915.00	<b>18875.00</b>	145
<b>ADAM ENERGISED (SPECIAL EDITION MODEL)</b>					
1.2i (70PS)	11979.17	2395.83	14375.00	<b>15295.00</b>	128
<b>ADAM ENERGISED BLACK JACK (SPECIAL EDITION MODEL)</b>					
1.2i (70PS)	12208.33	2441.67	14650.00	<b>15570.00</b>	128

Please note: On-the-road recommended retail prices (RRP) include number plates and delivery to Retailer of £700.00 (inc. £116.67 VAT), 12 months' Vehicle Excise Duty and new vehicle first registration fee of £55.00. Excludes fuel and insurance.

# ADAM FEATURES / OPTIONS

## SAFETY

### Driver/passenger airbags

- Driver's airbag • Front passenger's airbag • Front seat side-impact airbags
- Full-size curtain airbags for front and rear seat passengers

### Seating

- Height-adjustable front seat head restraints • Outer rear seat head restraints
- Anti-submarining ramps in front seats – Helps prevent occupants sliding underneath the lap belt during a collision.

### Seatbelts

- Height-adjustable front seatbelts • Four inertia-reel lap and diagonal seatbelts • Front seatbelt pretensioner system – Pretensioners tighten the seatbelt in the event of an accident limiting forward movement. • Front seatbelt force limiters – Reduces potential upper body injuries during a frontal impact. • Front and rear 'seatbelt unfastened' warning light

### Child safety

- Deactivation switch for front passenger's front and side-impact airbags – Permits the safe use of a child seat in the front passenger seat. • ISOFIX child seat mountings incorporating top tether anchor points located on rear seats (does not include child seat) – Allows ISOFIX child safety seats to be securely fixed into the car. The ISOFIX mounting system reduces forward movement in an accident and makes the child seat easier to install.

### Driver/passenger safety

- Energy-absorbing steering column • Pedal release system – Reduces potential injury to the driver's legs and feet during a severe frontal impact. • Laminated windscreen • Side-impact protection beams • Reinforced passenger safety cell • Deformation zones front and rear

### Pedestrian safety

- Bonnet/headlight/wiper structure – Designed to reduce pedestrian head and upper body injuries.
- Upper and lower bumper design – Reduces upper and lower leg injuries.

### Stability

#### Electronic Stability Programme (ESP):

– Works in conjunction with the vehicle's electronic braking and engine systems to keep the car stable in many different situations. ESP monitors many different inputs to determine when the car starts to lose traction, it can then immediately respond by varying the brake pressure between up to three wheels and adjust the engine output to help correct the loss of traction and improve stability.

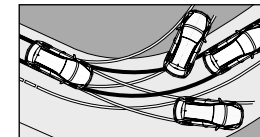

#### Additional ESP features:

- Traction control • Cornering brake control
- Straight line stability control

### Braking

#### Anti-lock Braking System (ABS):

– Prevents the vehicle's wheels from locking up under heavy braking by momentarily reducing brake pressure at the appropriate wheel, ensuring that you can maintain control of the steering.

#### Additional braking features:

– The same electronic systems used in the ABS and ESP also deliver exceptional braking performance.

- Emergency brake assist – When emergency braking is detected the vehicle automatically applies the maximum possible braking assistance.
- Electronic brakeforce distribution – Automatically apportions the optimum braking force to each wheel. • Adaptive brake lights – Automatically warns other road users of heavy braking. • Hill start assist – Briefly maintains rear brake pressure to stop the vehicle rolling back on an incline. • Hazard warning lights

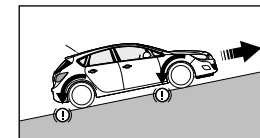

### Tyre pressure

- Tyre pressure monitoring system

	JAM	GLAM	SLAM	S	ENERGISED	ENERGISED BLACK-JACK	Price (£) exc. VAT	Total (£) inc. VAT
<b>Additional feature</b>				●				
• Switchable Electronic Stability Programme								

# ADAM FEATURES / OPTIONS

	JAM	GLAM	SLAM	S	ENERGISED	ENERGISED BLACK JACK	Price (£) exc. VAT	Total (£) inc. VAT
<b>DRIVER ASSISTANCE</b>								
<b>Cruise control with speed limiter</b> <i>Cruise control feature – enables you to maintain a constant speed – making it ideal for economical motorway driving.</i> <ul style="list-style-type: none"> <li>• The speed limiter function – can be set to ensure that you do not exceed the speed limit and can be easily overridden if required.</li> <li>• Steering wheel mounted controls</li> </ul>	●	●	●	●	●	●		
<b>Parking sensors</b> <ul style="list-style-type: none"> <li>• Rear parking distance sensors – audible warning.</li> </ul>  <b>Easier parking</b>	○	○	○	○			237.50	<b>285.00</b>
<b>Technical Pack</b> <ul style="list-style-type: none"> <li>• Rear parking distance sensors • R4.0 IntelliLink – see infotainment section for details.</li> </ul>	○	○	○	○			500.00	<b>600.00</b>
<b>Steering</b> <ul style="list-style-type: none"> <li>• Speed-sensitive electric power-assisted steering</li> </ul>	●	●	●	●	●	●		
<ul style="list-style-type: none"> <li>• City mode button – Provides lighter steering at parking speeds</li> </ul>	●	●	●		●	●		
<b>SECURITY</b>								
<b>Standard security features</b> <ul style="list-style-type: none"> <li>• ‘Key left in ignition’ audible warning • Electronically protected audio equipment</li> <li>• Engine deadlock immobiliser • Visible Vehicle Identification Number (VIN)</li> <li>• Locking wheel bolts for alloy wheels</li> </ul>	●	●	●	●	●	●		
<b>Central locking</b> <ul style="list-style-type: none"> <li>• Remote control • Operates on doors, tailgate and fuel filler flap</li> <li>• Deadlocking • Central locking activation switch on facia</li> <li>• One folding key/one static key each with integral remote control function (folding key is colour-keyed to body colour on ADAM JAM, GLAM, SLAM and ENERGISED models)</li> </ul>	●	●	●	●	●	●		

● = Standard equipment. ○ = Optional at extra cost.

# ADAM FEATURES / OPTIONS

<b>DRIVER INFORMATION</b>	JAM	GLAM	SLAM	S	ENERGISED	ENERGISED BLACK JACK	Price (£) exc. VAT	Total (£) inc. VAT
<b>Instrumentation</b> <ul style="list-style-type: none"> <li>• Black instruments with chrome edging • Speedometer • Rev counter</li> <li>• Fuel gauge with low fuel level warning light • Water temperature gauge</li> <li>• Instrument panel light dimmer • Shift-up indication light (Start/Stop models)</li> <li>– Indicates when to change gear for optimum fuel economy</li> </ul>	●	●	●	●	●	●		
<b>Driver information display (centrally located in instrument cluster)</b> <ul style="list-style-type: none"> <li>• Displays trip computer data • Total mileage • Service-due indicator</li> <li>• Tyre pressure monitoring system • Handbrake-on / low brake fluid level warning lights</li> </ul>	●	●	●	●	●	●		
<b>Central fascia display (format dependent on infotainment unit)</b> <ul style="list-style-type: none"> <li>• Audio information • Digital clock with automatic RDS time adjustment</li> <li>• Outside air temperature with ice warning function</li> <li>• Additional features dependent on infotainment unit (see infotainment for details)</li> </ul>	●	●	●	●	●	●		
<b>Multi-function trip computer (displayed on driver information display)</b> <ul style="list-style-type: none"> <li>• Trip mileage • Vehicle range based on remaining fuel • Average fuel economy • Instantaneous fuel economy</li> </ul>	●	●	●	●	●	●		

● = Standard equipment.

# ADAM FEATURES / OPTIONS

<b>INTERIOR STYLING</b>	JAM	GLAM	SLAM	S	ENERGISED	ENERGISED BLACK JACK	Price (£) exc. VAT	Total (£) inc. VAT
<b>JAM interior décor</b> Steering wheel: • Three-spoke design • Leather-covered • Satin chrome-effect bezel Facia and door trim: • Japan Black facia and door panel inserts (Black Jack, Orange Alert, Pump up the Blue and The Green Gatsby models) • Pearl White facia and door panel inserts (Saturday White Fever, Shades of Grey and Heavy Metal models) • Facia and door panel inserts matched to exterior colour (all other models) • Black door panels with black Atlantis cloth inserts • Chrome-effect interior door handles Seat trim: • Imix black fabric seat trim inserts • Plain black fabric side bolsters and surrounds	●							
<b>GLAM interior décor</b> Steering wheel: • Three-spoke design • Leather-covered • Satin chrome-effect bezel Facia and door trim: • Japan Black facia and door panel inserts • Black door panels with black Atlantis cloth inserts • Chrome-effect interior door handles Seat trim: • Imix black fabric seat trim inserts • Plain black fabric side bolsters and surrounds Door sill covers: • Chrome-effect Seat trim: • Ocio black fabric seat trim inserts • Black leather-effect side bolsters and surrounds		●					300.00	<b>360.00</b>
<b>SLAM interior décor</b> Steering wheel: • Three-spoke design • Leather-covered • Satin chrome-effect bezel Facia and door trim: • Facia and door panel inserts matched to exterior colour (Red 'n' Roll and Let it Blue models) • Japan Black facia and door panel inserts (all other models) • Black door panels with black leather-effect inserts • Chrome-effect interior door handles Seat trim: • Superheroes black fabric seat trim inserts • Black leather-effect side bolsters and surrounds Door sill covers: • Chrome-effect			●					
<b>S interior décor</b> Steering wheel: • VX-Line three-spoke design • Leather-covered flat bottom • Satin chrome-effect bezel Gear knob: • VX-Line leather-covered Facia and door trim: • Red your Engine facia and door panel inserts • Black door panels with black leather-effect inserts • Chrome-effect interior door handles Seat trim: • Red your Engine black fabric seat trim inserts • Black leather-effect side bolsters and surrounds with accent stitching Pedals: • Sports, alloy-effect Door sill covers: • Chrome-effect				●				
<b>ENERGISED / ENERGISED BLACK JACK interior décor</b> Steering wheel: • Three-spoke design • Leather-covered • Satin chrome-effect bezel Facia and door trim: • Japan Black facia and door panel inserts (Orange Alert, White My Fire, Shades of Grey and Red Hot Chilli models) • Facia and door panel inserts matched to exterior colour (all other models) • Black door panels with black leather-effect inserts • Chrome-effect interior door handles Seat trim: • Ocio black fabric seat trim inserts • Black leather-effect side bolsters and surrounds Rear-view mirror cover: • Carbon fibre-effect (ENERGISED BLACK JACK models only) Pedals: • Sports, alloy-effect					●	●		
Japan Black facia and door panel inserts				N/C			<b>No-cost option</b>	

● = Standard equipment. ○ = Optional at extra cost. N/C = No-cost option.

# ADAM FEATURES / OPTIONS

<b>INFOTAINMENT</b>	JAM	GLAM	SLAM	S	ENERGISED	ENERGISED BLACK JACK	Price (£) exc. VAT	Total (£) inc. VAT
<p><b>CD 30 BT</b></p> <p><b>Onboard features:</b> • CD/MP3 CD player • AM/FM stereo radio with 36 station presets • RDS with Traffic Programme</p> <p><b>Media connections:</b> • USB connection with iPod control • Aux-in socket</p> <p><b>Mobile phone portal:</b> • Bluetooth® connectivity • Handsfree calls via steering wheel controls • Vehicle microphone • Phone book access</p>	●	●	●	●				
<p><b>R4.0 IntelliLink touchscreen infotainment system</b></p> <p><i>For use with media players, USB memory sticks, mobile phones and smartphone apps.</i></p> <p><b>Onboard features:</b> • 7-inch colour touchscreen • AM/FM stereo radio with 36 station presets • RDS with Traffic Programme</p> <p><b>Media connections:</b> • USB connection with iPod control • Bluetooth® A2DP audio streaming (Advanced Audio Distribution Profile)</p> <p><b>Mobile phone portal:</b> • Bluetooth® connectivity • Handsfree calls via steering wheel controls • Vehicle microphone • Phone book access – <i>The majority of the phone's functions – contacts/last calls/missed calls etc. – are mirrored on IntelliLink's display and are easily navigated using the touchscreen (features dependent on mobile phone).</i></p> <p><b>Smartphone interface:</b> • Apple CarPlay™ • Android Auto™ – <i>Smartphone projection that allows operations via voice command, touchscreen and buttons to control apps and music playback</i></p> <p><b>Gallery – only available when the vehicle is stationary:</b> • Photo gallery with slide show feature • Video playback with soundtrack played through car speakers</p>	☐	☐	☐	☐	●	●		

● = Standard equipment. ☐ = Available as part of an extra-cost option pack.

# ADAM FEATURES / OPTIONS







## INFOTAINMENT

	JAM	GLAM	SLAM	S	ENERGISED	ENERGISED BLACK JACK	Price (£) exc. VAT	Total (£) inc. VAT
<b>Navi 4.0 IntelliLink touchscreen navigation and infotainment system (not available in conjunction with Technical Pack)</b> <i>For use with media players, USB memory sticks, mobile phones and smartphone apps.</i> <b>Onboard features:</b> • 7-inch colour touchscreen • AM/FM stereo radio with 36 station presets • RDS with Traffic Programme <b>Navigation features:</b> • Satellite navigation system • 2D street level mapping • European coverage • Structured or one-box destination entry • Points-of-interest search • Eco routing • Map updates via USB <b>Media connections:</b> • USB connection with iPod control • Bluetooth® A2DP audio streaming (Advanced Audio Distribution Profile) <b>Mobile phone portal:</b> • Bluetooth® connectivity • Handsfree calls via steering wheel controls • Vehicle microphone • Phone book access – <i>The majority of the phone's functions – contacts/last calls/missed calls etc. – are mirrored on IntelliLink's display and are easily navigated using the touchscreen (features dependent on mobile phone).</i> <b>Smartphone interface:</b> • Apple CarPlay™ • Android Auto™ – <i>Smartphone projection that allows operations via voice command, touchscreen and buttons to control apps and music playback.</i> <b>Gallery – only available when the vehicle is stationary:</b> • Photo gallery with slide show feature • Video playback with soundtrack played through car speakers	○	○	○	○			654.17	785.00
Digital radio		●	●	●	●	●		
Number of speakers	4*	6	6	6	4	4		
Steering wheel mounted audio controls	●	●	●	●	●	●		

● = Standard equipment. ○ = Optional at extra cost.

\* = 6 speakers are fitted when optional Technical Pack or rear parking distance sensors are specified.

# ADAM FEATURES / OPTIONS





<b>ONSTAR</b>						JAM	GLAM	SLAM	S	ENERGISED	ENERGISED BLACK JACK	Price (£) exc. VAT	Total (£) inc. VAT
													
Automatic Crash Response	Wi-Fi Hotspot	Smartphone App	Stolen Vehicle Assistance	Vehicle Diagnostics	Destination Download								
<p><b>OnStar – your personal on board assistant*</b></p> <p>Many car brands talk about innovation as soon as they improve their cup holders but this innovative system, now available on selected models**, is revolutionary: 24/7, 365 days a year, OnStar puts you in touch with a trained advisor, not a machine. With OnStar you have access to a host of innovations, from Vehicle Diagnostics and Smartphone Function to a fully integrated 4G Wi-Fi Hotspot†. In the event of an accident, OnStar even automatically calls for help, for an incomparable feeling of safety.</p> <p>* = Includes 12 months of OnStar services from date of first registration and a 3 month/3 GB Wi-Fi free trial period (whichever comes first) effective from the date the customer accepts the nominated network operator Wi-Fi T's&amp;C's. Destination download feature only operates on models fitted with Navi 4.0 IntelliLink satellite navigation system.</p> <p>** = The OnStar Services require activation and are subject to mobile network coverage and availability. Wi-Fi Hotspot service requires account with nominated network operator.</p> <p>† = 4G is subject to mobile network coverage and availability. Charges apply after the free trial period. The OnStar subscription packages could be different from the services included in the free trial package. Check <a href="http://www.vauxhall.co.uk/onstar">www.vauxhall.co.uk/onstar</a> for terms and conditions, details of availability, coverage and charges.</p>						○	○	○	○	○	○	345.83	415.00
													

○ = Optional at extra cost.

All OnStar services and Wi-Fi services will cease to be available on 31 December 2020. No trial or paid subscriptions or services, including emergency response services, will be available after that date.



# ADAM FEATURES / OPTIONS

	JAM	GLAM	SLAM	S	ENERGISED	ENERGISED BLACK JACK	Price (£) exc. VAT	Total (£) inc. VAT
<b>HEATING AND VENTILATION</b>								
<b>Air conditioning</b> • Air recirculation facility • Cabin particulate filter – <i>Removes dust, airborne particles and pollen</i> • Four-speed fan • Illuminated controls	●				●	●		
<b>Electronic climate control incorporating air conditioning</b> • Single-zone control • Advanced predictive logic control system using sun sensor • Cabin charcoal filter – <i>Removes dust, airborne particles, pollen and unpleasant odours</i> • Automatic air direction and fan speed with manual override • LCD temperature display • Six-speed fan • Illuminated controls  <b>Set and forget temperature control</b>		●	●	●				
<b>Winter Pack (fitted at no extra cost in conjunction with optional leather seat facings)</b> • Heated leather-covered steering wheel • Heated front seats  <b>Warm welcome</b>  	○	○	○	○			187.50	225.00
<b>Additional features</b> • Four adjustable facia vents • Windscreen demist vents • Side window demist vents • Heated rear screen with timed cut-off	●	●	●	●	●	●		
<b>SEATING AND COMFORT</b>								
Reach and rake adjustable steering	●	●	●	●	●	●		
<b>Comfort front seats</b> Driver's seat (eight-way adjustable): • Height (up/down) • Reach (fore/aft) • Backrest (upright/recline) • Head restraint (up/down) Front passenger's seat (six-way adjustable): • Reach (fore/aft) • Backrest (upright/recline) • Head restraint (up/down)	●	●	●	●	●	●		
<b>Recaro sports front seats in black premium Nappa leather</b> Driver's and front passenger's seat (six-way adjustable): • Height (up/down) • Reach (fore/aft) • Backrest (upright/recline)				○			1916.67	2300.00
Easy-entry front seats with memory function	●	●	●	●	●	●		
Front passenger's seat height adjuster (fitted at no extra cost in conjunction with optional Recaro sports front seats)				○				
<b>Rear seats</b> • Two-person layout • 50/50 split-folding rear seat back • Removable head restraints • ISOFIX child seat mountings incorporating top tether anchor points located on rear seats (does not include child seat) – <i>Allows ISOFIX child safety seats to be securely fixed into the car. The ISOFIX mounting system reduces forward movement in an accident and makes the child seat easier to install.</i>	●	●	●	●	●	●		

● = Standard equipment. ○ = Optional at extra cost.

# ADAM FEATURES / OPTIONS

	JAM	GLAM	SLAM	S	ENERGISED	ENERGISED BLACK JACK	Price (£) exc. VAT	Total (£) inc. VAT
<b>INTERIOR CONVENIENCE</b>								
<b>Convenience features</b> • Front 12-volt electrical accessory socket • Driver's and front passengers sunvisors • Driver's vanity mirror with cover • Dipping rear-view mirror • Driver's and front passenger's tiltable assist handles	●	●	●	●	●	●		
Automatically dimming anti-dazzle rear-view mirror	□	□	□	□				
Velour floor mats				●				
<b>Interior lighting</b> • Central front courtesy light • Fade up/fade down • Front map reading lights	●	●	●	●	●	●		
<b>Interior storage</b> • Storage box on driver's side lower fascia • Glovebox with lid • Front door pockets • Two drinks holders in rear of centre console • Rear stowage compartments in side panel	●	●	●	●	●	●		
• Storage pockets on front seat backs			●	●				
• Drinks holder in front centre console with adjustable restraining strap		●	●	●				
<b>Luggage area</b> • Luggage compartment cover • Illuminated, carpeted, luggage area • Interior tailgate handles • Load restraint lashing eyes • Twin gas-assisted tailgate struts	●	●	●	●	●	●		
<b>MECHANICAL</b>								
<b>Standard features</b> • Front-wheel drive • Gas-pressure dampers • Front anti-roll bar • Speed-sensitive electric power-assisted steering	●	●	●	●	●	●		
• Sports suspension – fitted to JAM and GLAM models in conjunction with optional 17-inch wheels. Not available separately.	○	○	●	●	●	●		

● = Standard equipment. ○ = Optional at extra cost. □ = Available as part of an extra-cost option pack.

# ADAM FEATURES / OPTIONS

	JAM	GLAM	SLAM	S	ENERGISED	ENERGISED BLACK JACK	Price (£) exc. VAT	Total (£) inc. VAT
<b>EXTERIOR LIGHTING</b>								
<b>Standard lighting features</b> • Halogen headlights • Welcome lighting • Lights-on audible warning • Electric headlight beam levelling • High-level LED centre rear brake light • Rear fog light	●	●	●	●	●	●		
Daytime running lights	●	●			●	●		
LED daytime running lights			●	●				
LED tail lights			○	○			100.00	120.00
<b>Exterior Light Pack</b> • LED daytime running lights • LED tail lights	○	○			○	○	175.00	210.00
<b>Sight and Light Pack One (not available with Extreme Carbon Pack)</b> • Rain-sensitive windscreen wipers • Automatic lighting control with tunnel detection • Automatically dimming anti-dazzle rear-view mirror	○	○	○	○			200.00	240.00
<b>Sight and Light Pack Two (only available with Extreme Carbon Pack)</b> • Rain-sensitive windscreen wipers • Automatic lighting control with tunnel detection			○	○			175.00	210.00

## EXTERIOR CONVENIENCE

<b>Windscreen wipers</b> • Two-speed windscreen wipers with variable intermittent wipe • Intermittent rear window wash/wipe • Rain-sensitive windscreen wipers – <i>Fitted in conjunction with Sight and Light Packs. Not available separately.</i>	●	●	●	●	●	●		
	□	□	□	□				
<b>Door mirrors</b> • Electrically adjustable/heated door mirrors (wide-angle on driver's side), manually foldable	●	●	●	●	●	●		
<b>Windows</b> • Electrically operated front windows with safety autoreverse and one-touch facility • Heated rear window with automatic timed cut-off	●	●	●	●	●	●		
Fixed glass roof panel with sliding blind		●						

● = Standard equipment. ○ = Optional at extra cost. □ = Available as part of an extra-cost option pack.

# ADAM FEATURES / OPTIONS

	JAM	GLAM	SLAM	S	ENERGISED	ENERGISED BLACK JACK	Price (£) exc. VAT	Total (£) inc. VAT
<b>EXTERIOR STYLING</b>								
Body-colour door handles	●		●	●	●	●		
Body-colour door handles with chrome-effect insert	□	●						
Body-colour roof and door mirrors	●	●	N/C	N/C				<b>No-cost option</b>
<b>Roof Colour Packs</b> <i>The roof and door mirrors are available in a range of colours</i>								
• Black Jack	□	○	●	●	●	●	254.17	<b>305.00</b>
• White my Fire	□	○		N/C			254.17	<b>305.00</b>
• Let it Blue				N/C				<b>No-cost option</b>
• Red 'n' Roll				N/C				<b>No-cost option</b>
<b>Style Pack</b> • Choice of Black Jack or White my Fire Roof Colour Pack • 17-inch Swiss Blade Silver alloy wheels • Dark-tinted rear windows	○						587.50	<b>705.00</b>
<b>Extreme Carbon Pack</b> • Carbon fibre-effect door mirrors, front grille bar and rear-view mirror cover			○				175.00	<b>210.00</b>
<b>Extreme Carbon Pack</b> • Carbon fibre-effect door mirrors, front grille bar and rear-view mirror cover • Carbon fibre-effect inserts on lower front and rear bumpers				○			237.50	<b>285.00</b>
Chrome-effect upper side window mouldings	□	●	●	●				
Chrome-effect front grille bar	●	●	●	●				
High-gloss black front grille bar					●	●		
Black Jack bonnet				○		●	83.33	<b>100.00</b>
Black B-pillars	●	●	●	●	●	●		
Rear roof spoiler			□					
Unique ADAM S rear roof spoiler				●				
<b>VXR Styling Pack</b> • Body-colour front lower spoiler / side sills / rear lower skirt / rear roof spoiler. Please note: ADAM S models feature a unique rear roof spoiler			○				633.33	<b>760.00</b>
Chrome-effect exhaust tailpipe extension				●				
<b>Urban Pack</b> • Chrome-effect upper side window mouldings • Chrome-effect door sill covers • Chrome-effect inserts on exterior door handles • LED daytime running lights and tail lights • Multi-colour illumination (eight colours) of centre console, door trim and footwells • Twin sunvisors incorporating illuminated driver's and front passenger's vanity mirrors with covers	○						341.67	<b>410.00</b>
<b>Windows</b> • Tinted windows	●	●	●	●	●	●		
• Dark-tinted rear windows (also available as part of optional Style Pack)	○	○	●	●	○	●	145.83	<b>175.00</b>

● = Standard equipment. ○ = Optional at extra cost. N/C = No-cost option. □ = Available as part of an extra-cost option pack.







# ADAM FEATURES / OPTIONS

<b>EXTERIOR COLOURS</b>		JAM	GLAM	SLAM	S	ENERGISED	ENERGISED BLACK JACK	Price (£) exc. VAT	Total (£) inc. VAT
	<b>Orange Alert</b> • Solid paint	●	●	●		N/C	N/C		
	<b>Red 'n' Roll</b> • Brilliant paint	○	○	○	●	●	●	237.50	285.00
	<b>Saturday White Fever</b> • Brilliant paint	○	○	○	○	N/C	N/C	237.50	285.00
	<b>White my Fire</b> • Brilliant paint		○			N/C	N/C	237.50	285.00

● = Standard equipment. ○ = Optional at extra cost. N/C = No-cost option.

The colours reproduced may vary slightly from the actual paint colour. As a result they should be used as a guide only. Your Vauxhall Retailer has a comprehensive display of our paint samples.



# ADAM FEATURES / OPTIONS

<b>EXTERIOR COLOURS</b>		JAM	GLAM	SLAM	S	ENERGISED	ENERGISED BLACK JACK	Price (£) exc. VAT	Total (£) inc. VAT
	<b>Black Jack</b> • Two-coat metallic paint	<input type="radio"/>	<input type="radio"/>	<input type="radio"/>	<input type="radio"/>	N/C		470.83	<b>565.00</b>
	<b>Shades of Grey</b> • Two-coat metallic paint	<input type="radio"/>	<input type="radio"/>	<input type="radio"/>	<input type="radio"/>	N/C	N/C	470.83	<b>565.00</b>
	<b>Purple Fiction</b> • Two-coat pearlescent paint		<input type="radio"/>					470.83	<b>565.00</b>
	<b>Heavy Metal</b> • Two-coat metallic paint	<input type="radio"/>	<input type="radio"/>	<input type="radio"/>	<input type="radio"/>			470.83	<b>565.00</b>
	<b>Red Hot Chilli</b> • Two-coat metallic paint					N/C	N/C	<b>No-cost option</b>	
	<b>The Green Gatsby</b> • Two-coat metallic paint	<input type="radio"/>	<input type="radio"/>					470.83	<b>565.00</b>

○ = Optional at extra cost. N/C = No-cost option.

The colours reproduced may vary slightly from the actual paint colour. As a result they should be used as a guide only. Your Vauxhall Retailer has a comprehensive display of our paint samples.







# ADAM FEATURES / OPTIONS

<b>EXTERIOR COLOURS</b>		JAM	GLAM	SLAM	S	ENERGISED	ENERGISED BLACK JACK	Price (£) exc. VAT	Total (£) inc. VAT
	<b>Let it Blue</b> • Two-coat premium paint			○	○	N/C	N/C	545.83	<b>655.00</b>
	<b>Pump up the Blue</b> • Two-coat premium paint	○	○	○	○			545.83	<b>655.00</b>

○ = Optional at extra cost. N/C = No-cost option.



The colours reproduced may vary slightly from the actual paint colour. As a result they should be used as a guide only. Your Vauxhall Retailer has a comprehensive display of our paint samples.

# ADAM FEATURES / OPTIONS

<b>WHEELS AND TYRES</b>		JAM	GLAM	SLAM	S	ENERGISED	ENERGISED BLACK JACK	Price (£) exc. VAT	Total (£) inc. VAT
		Emergency spare wheel (in lieu of emergency tyre inflation kit)		○	○	○			
	<b>16-inch Horns Silver alloy wheels</b> • 195/55 R 16 tyres • Emergency tyre inflation kit (in lieu of spare wheel)	●							
	<b>16-inch Silver Vintage alloy wheels</b> • 195/55 R 16 tyres • Emergency tyre inflation kit (in lieu of spare wheel)		●						
	<b>17-inch Gloss Black Hurricane alloy wheels</b> • 215/45 R 17 tyres • Emergency tyre inflation kit (in lieu of spare wheel)			●		●	●		
	<b>17-inch Swiss Blade Silver alloy wheels</b> • 215/45 R 17 tyres • Emergency tyre inflation kit (in lieu of spare wheel)	□							
	<b>17-inch High-gloss Black Roulette diamond-cut alloy wheels</b> • 215/45 R 17 tyres • Emergency tyre inflation kit (in lieu of spare wheel)		○					425.00	510.00
	<b>18-inch Technical Grey Propellor diamond-cut alloy wheels</b> • 225/35 R 18 tyres • Emergency tyre inflation kit (in lieu of spare wheel)				●				

● = Standard equipment. ○ = Optional at extra cost. □ = Available as part of an extra-cost option pack.

## TYRE RATING

Tyre size	Fuel efficiency group	Wet grip performance	External noise	
			Measured (dB)	Group
195/55 R 16	B-C	B	71	
215/45 R 17	C	B	71	
225/35 R 18	C	B	77	

Tyre rating according to EU Regulation 1222/2009



# ADAM SPECIFICATIONS

## PETROL ENGINES

	1.2i (70PS)	1.4i (87PS)	1.4i (100PS)
Capacity	1229cc	1398cc	1398cc
Maximum power	70PS (51kW) @ 5600rpm	87PS (64kW) @ 6000rpm	100PS (74kW) @ 6000rpm
Maximum torque	115Nm (85 lb.ft.) @ 4000rpm	130Nm (96 lb.ft.) @ 4000rpm	130Nm (96 lb.ft.) @ 4000rpm
Configuration	4 cylinders, 4 valves per cylinder, double overhead camshafts	4 cylinders, 4 valves per cylinder, double overhead camshafts	4 cylinders, 4 valves per cylinder, double overhead camshafts
Fuel/induction system	Naturally aspirated. Variable Valve Timing. Multi-point sequential fuel injection	Naturally aspirated. Variable Valve Timing. Multi-point sequential fuel injection	Naturally aspirated. Variable Valve Timing. Multi-point sequential fuel injection
Emission compliance	Euro 6d-TEMP (6.2)	Euro 6d-TEMP (6.2)	Euro 6d-TEMP (6.2)
Service interval	20,000 miles or 1 year (whichever occurs sooner)	20,000 miles or 1 year (whichever occurs sooner)	20,000 miles or 1 year (whichever occurs sooner)

	1.4i Turbo (150PS) with Start/Stop
Capacity	1364cc
Maximum power	150PS (110kW) @ 4900-5500rpm
Maximum torque	220Nm (162 lb.ft.) @ 2750-4500rpm
Configuration	4 cylinders, 4 valves per cylinder, double overhead camshafts
Fuel/induction system	Water-cooled turbocharger with intercooler. Variable Valve Timing (VVT) Multi-point sequential fuel injection
Emission compliance	Euro 6d-TEMP (6.2)
Service interval	20,000 miles or 1 year (whichever occurs sooner)

## PERFORMANCE, FUEL ECONOMY AND EMISSIONS

	Wheel size (inches)	Performance (manufacturer's figures)		Fuel economy mpg (litres/100km) <sup>#</sup>			CO <sub>2</sub> emissions g/km <sup>#</sup>	Vehicle Excise Duty* <sup>#</sup>		Benefit in kind company car taxation rates – 2018/19 tax year
		Maximum speed (mph)	Acceleration 0-62mph (sec)	Urban driving	Extra-urban driving	Combined figure		First year rate	Standard rate	
<b>Manual</b>										
1.2i (70PS)	16/17	103	14.9	38.7 (7.3)	61.4 (4.6)	50.4 (5.6)	128	£165	£140	26%
1.4i (87PS)	16/17	109	12.5	37.2 (7.6)	58.9 (4.8)	48.7 (5.8)	133	£205	£140	27%
1.4i (100PS)	17	115	11.5	37.7 (7.5)	57.7 (4.9)	48.7 (5.8)	134	£205	£140	27%
1.4i Turbo (150PS) Start/Stop	18	130	8.5	34.4 (8.2)	53.3 (5.3)	44.1 (6.4)	145	£205	£140	30%

\* = Correct at time of publication.

<sup>#</sup> = Fuel consumption data and CO<sub>2</sub> emission data are determined using the Worldwide harmonized Light vehicles Test Procedure (WLTP), and the relevant values are translated back to allow the comparability into NEDC, according to regulations R (EC) No. 715/2007, R (EU) No. 2017/1153 and R (EU) No. 2017/1151. The values do not take into account in particular use and driving conditions, equipment or options and may vary depending on the format of tyres. For more information on official fuel consumption and CO<sub>2</sub> emission values, please read the guidelines at <http://carfueldata.dft.gov.uk/> and for more information on WLTP please see [www.vauxhall.co.uk/wltp](http://www.vauxhall.co.uk/wltp)

# ADAM SPECIFICATIONS

## START/STOP TECHNOLOGY

The ADAM Start/Stop system offers real benefits by improving fuel economy and reducing CO<sub>2</sub> emissions, particularly in town. It does this by automatically stopping the engine when you come to a standstill, and then restarting as you prepare to move off.

Before automatically stopping the engine a number of system checks are carried out to ensure that it is both safe and practical to do so. To ensure safety, the driver must depress the clutch pedal, shift in to neutral, and then release the clutch pedal.

System checks carried out before Auto Stop activates include:

- Start/Stop system is not manually deactivated via the facia button
- Sufficient brake vacuum is available to prevent the car rolling down an incline
- Battery is in good condition and charged
- Outside air temperature and engine temperature are above specified minima
- Electronic climate control (where fitted) is not in maximum heating or maximum cooling mode

If all of these conditions are satisfied then the vehicle will Auto Stop.

When you are ready to pull away from standstill, Auto Restart is activated by depressing the clutch pedal.

Whilst at a standstill the vehicle is continually monitored. If necessary, the engine will automatically be restarted. Conditions that would initiate an Auto Restart include:

- Low battery level
- Cabin temperature is too high
- Driver's seatbelt unfastened or driver's door opened
- Bonnet is released or opened

## TRANSMISSION

### Five-speed manual gearbox:

Standard on all models (except 1.4i Turbo (150PS)).

### Six-speed manual gearbox:

Standard on 1.4i Turbo (150PS) models only.

## STEERING

- Speed-sensitive power-assisted steering

## SUSPENSION

**Front:** Independent. MacPherson struts with gas-pressure dampers and coil springs. Anti-roll bar.

**Rear:** Compound crank with coil springs and gas-pressure dampers.

## BRAKING AND STABILITY

- Electronic Stability Programme – switchable on ADAM S models
  - Cornering brake control
  - Straight line stability control
  - Anti-lock Braking System (ABS)
  - Electronic brakeforce distribution
  - Emergency brake assist
  - Dual circuit, diagonally split braking system
  - ADAM S models feature red calipers
- 1.2i (70PS) / 1.4i (87PS)**  
 Front ventilated discs: 257mm diameter  
 Rear drums: 203mm diameter
- 1.4i (100PS)**  
 Front ventilated discs: 257mm diameter  
 Rear drums: 228mm diameter
- 1.4i Turbo (150PS)**  
 Front ventilated discs: 308mm diameter  
 Rear discs: 264mm diameter

## FUEL TANK CAPACITY

- 38 litres (8.4 gallons)

## GROSS VEHICLE WEIGHTS kg

1.2i (70PS)	1470
1.4i (87PS)	1480
1.4i (100PS)	1480
1.4i Turbo (150PS)	1565

Gross vehicle weight is the total permissible weight of the vehicle including passengers and luggage. The maximum roof rack loading should not exceed 50kg.

## INSURANCE GROUPS

1.2i (70PS)	3E
1.4i (87PS)	6E
1.4i (100PS)	9E
1.4i Turbo (150PS)	15E

# ADAM SPECIFICATIONS

## EXTERIOR DIMENSIONS millimetres (inches)

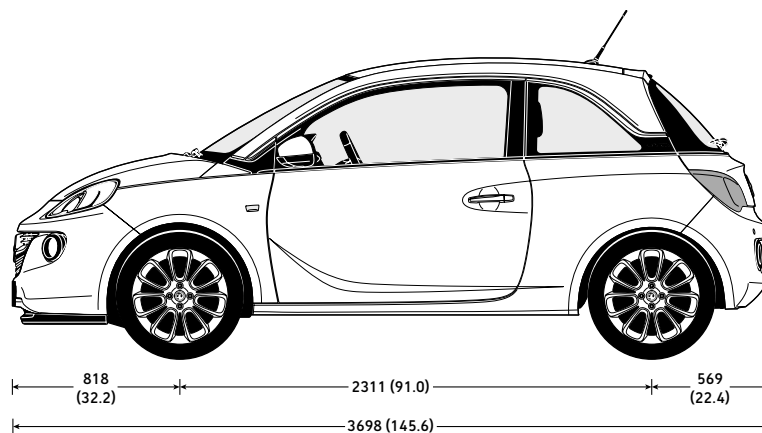
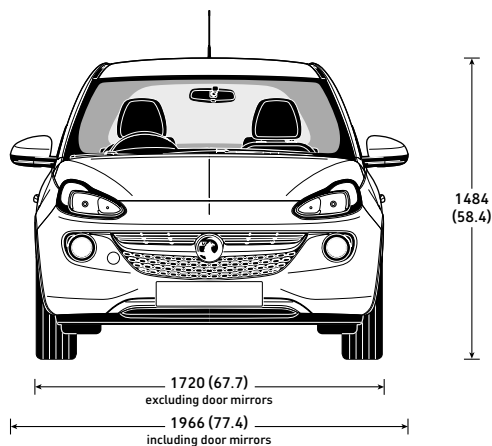

## LOADSPACE DIMENSIONS mm (inches)

Maximum length (behind rear seats)	462 (18.2)
Maximum length (rear seats folded)	1041 (41.0)
Maximum width	963 (37.9)
Width between wheel arches	954 (37.6)
Maximum height	874 (34.4)

## LOADSPACE CAPACITIES\* litres (cu.ft.)

Rear seats up (under luggage compartment cover)	170 (6.0)
Rear seats folded (to upper edge of front seat back)	484 (17.1)
Rear seats folded (to roof)	663 (23.4)

\* = Measured using the ECIE method.

# ADAM ACCESSORIES

	Total (inc. VAT)
<b>CHILD SEATS<sup>1</sup></b>	
BABY-SAFE <sup>2</sup> – 0-13kg/birth to 15 months	£135.00
– ISOFIX base	£234.00
DUO ISOFIX <sup>2</sup> – 9-18kg/9 months to 4 years	
with top tether kit	£358.00
KID2 –15-36kg or 4 to 12 years	£162.00

1 = Restrictions apply to the use of child seats, please consult your Vauxhall Retailer or request a copy of the Child seats brochure.

2 = Without transponder.

## FLEXCONNECT RANGE

FlexConnect bracket	£21.00
FlexConnect hook	£31.00
FlexConnect coat hanger	£33.00
FlexConnect folding table	£74.00
FlexConnect iPad Mini cradle	£105.00
FlexConnect iPad (1-4) cradle	£113.00
FlexConnect iPad Air cradle	£112.00
FlexConnect Samsung Galaxy cradle	£102.00

## INTERIOR

Velour floor mats (set of four)	from £56.00
Rubber floor mats (set of four)	£47.00
Rear view mirror cap (fitted)	from £56.00
Front console mat	£40.00
Centre console armrest (fitted)	£119.00
Cargo box with lid	£187.00
Coloured leather gear knob and gaiter (fitted)	from £63.00
Stainless steel pedal covers – manual (fitted)	£158.00

## VXR EXTERIOR STYLING<sup>3</sup>

VX-Line body styling – front lower spoiler/side sills/rear lower skirts (painted/fitted)	£1591.00
VX-Line body styling – rear roof spoiler (painted/fitted)	£550.00

3 = Not available on S models.

### Please note:

Prices shown are fully fitted and painted, where applicable and include VAT. Please check with your local Vauxhall Retailer for details. It is advisable to ensure your insurance policy is adequate to cover additional fitted accessories. Prices correct at time of publication.

	Total (inc. VAT)
<b>EXTERIOR</b>	
Door mirror caps (fitted)	from £112.00
Painted radiator grille (fitted)	from £106.00
'Fly' decals	
– B-pillar decal (fitted)	£62.00
– C-pillar decal (fitted)	£164.00
'Splat' graphics	
Front wing/rear quarter decals (fitted)	from £150.00
'Sport 01' graphics	
– Bonnet decal (fitted)	£80.00
– Roof decal (fitted)	£100.00
– C-pillar decal (fitted)	£74.00
'Stripes' graphics	
– Bonnet decal (fitted)	from £153.00
– Roof decal (fitted)	from £149.00
– Door decals (fitted)	from £133.00
– Door / door mirror decals (fitted)	from £133.00
'Stars and Stripes' graphics	
– Roof / B Pillar decals (fitted)	£197.00
'Chequered' graphics	
– Roof decal (fitted)	£123.00
'Motorsport' graphics	
– Bonnet / body side decals (fitted)	£401.00
Body side protection mouldings (painted/fitted)	
	£225.00

## PROTECTION

Tyre sealant – 450ml	£75.00
Tyre repair kit	£113.00
Safety pack – first aid kit/hi-visibility vest/warning triangle	
First aid kit	£36.00
Hi-visibility vest	£15.00
Warning triangle	£9.00
Spare bulb kit	£17.00
Protection film – front bumper (fitted)	£27.00
Protection film – rear bumper (fitted)	£171.00
Privacy shades – tailgate/rear side windows	£41.00
Exterior windscreen cover	£188.00
Outdoor car cover	£47.00
Mudflaps – front (fitted)	£99.00
Mudflaps – rear (fitted)	£66.00
Mudflaps – rear (fitted)	£58.00

	Total (inc. VAT)
<b>TRANSPORT SYSTEMS</b>	
Roof base carrier	£145.00
<b>Roof carriers (requires base carrier)</b>	
Bike roof carrier – Thule Freeride 532	£76.00
Surf board roof carrier – Thule 833	£80.00
Kayak roof carrier – Thule 837	£168.00
Ski roof carrier (400mm wide)	
– Thule Deluxe 726	£141.00
Ski roof carrier (600mm wide)	
– Thule 739	£205.00
<b>Hard shell roof boxes (requires base carrier)</b>	
Thule Ocean 80	
(320 litre / 1330 x 860 x 370mm)	£150.00
Thule Ocean 200	
(390 litre / 1750 x 820 x 450mm)	£316.00
Thule Dynamic 800	
(320 litre / 2060 x 840 x 340mm)	£625.00
Thule Dynamic 900	
(430 litre / 2350 x 940 x 350mm)	£750.00
Thule Excellence	
(520 litre / 2180 x 940 x 400mm)	£898.00
Thule Motion 800	
(460 litre / 2050 x 840 x 450mm)	from £452.00
Thule Touring 200	
(400 litre / 1750 x 820 x 450mm)	£330.00
Thule Touring 780	
(430 litre / 2320 x 700 x 420mm)	£370.00
<b>Soft roof boxes (requires base carrier)</b>	
Thule Ranger 90	
(280 litre / 1100 x 800 x 400mm)	£285.00
Thule Ranger 500	
(300 litre / 1900 x 500 x 300mm)	£378.00

	Total (inc. VAT)
<b>ALLOY WHEELS (set of four with centre caps)<sup>4</sup></b>	
16-inch Horns	
– Silver	£1200.00
– Black	£1194.00
16-inch Vintage	
	£1200.00
16-inch Boomerang	
– Grey / diamond cut face	£1194.00
– Green / diamond cut face	£1194.00
– White / diamond cut face	£1194.00
16-inch Triple Cross	
– Titan grey	£1200.00
– Manoogian	£1194.00
18-inch Turbine	
	£1712.00
17-inch Hurricane	
– Manoogian	£1362.00
– Black	£1362.00
– White	£1194.00
17-inch Swiss Blade	
– Silver	£1214.00
– Black / white rim	£1382.00
– Black / red rim	£1382.00
– Black / blue rim	£1382.00
17-inch Roulette	
– Grey	£1194.00
– Grey / diamond cut face	£1362.00
– Grey / white face	£1362.00
– Grey / brown face	£1362.00
– Grey / green face	£1362.00
– Copper / white face	£1362.00
– Copper / diamond cut face	£1362.00
– Black gloss	£1362.00
18-inch Twister	
– Grey	£1938.00
– Manoogian	£1938.00

Coloured wheel clips for Twister wheels (set of four)	
	from £52.00
Tyre valve caps with Vauxhall logos – set of four	
	£23.00

4 = Different tyres and locking wheel bolts/nuts may be required at extra cost. Price excludes new tyres and locking wheel bolts/nuts, includes static wheel balancing.	
---	--

# ADAM COMPANY CAR DRIVER/FLEET INFORMATION



## COMPANY CAR DRIVER FREE 3 DAY TEST DRIVE

Our free\* 3 Day Test Drive programme is open to all Company Car Drivers. It allows you to choose most models in the current Vauxhall line-up (exclusions apply). With full insurance cover provided, it gives you a meaningful length of time to make an informed decision about your next company car.

Click below to book your free\* test drive  
[www.vauxhall3dtd.co.uk](http://www.vauxhall3dtd.co.uk)  
or call 0330 587 8221\*\*

\*The free 3 Day Test Drive programme is open to Company Car Drivers and Fleet Decision Makers. Available for UK Mainland only. Terms and conditions apply. Full terms and conditions can be found at [vauxhallfleet.co.uk/testdrive/index/terms](http://vauxhallfleet.co.uk/testdrive/index/terms). \*\*Telephone lines open Monday-Friday 9.00am to 5.00pm excluding Bank Holidays. Calls may be recorded or monitored for quality and/or training purposes.

## FLEET TOOLBOX

Discover the facts in our online Toolbox for both Company Car Drivers and Fleet Decision Makers. The Fleet Toolbox has a host of useful calculators, comparators, interactive listings and information. Visit the Fleet Toolbox by going to [www.vauxhall-toolbox.co.uk](http://www.vauxhall-toolbox.co.uk)



## ROADTRIP APP

The Vauxhall RoadTrip App is a free app that calculates and logs your mileage expenses for any UK business trips and generates reports to help you complete your mileage claims. Available for both iPhone and Android, visit [www.vauxhall-toolbox.co.uk](http://www.vauxhall-toolbox.co.uk) or visit the iPhone or Android stores and search for Vauxhall RoadTrip to download it to your smartphone or tablet.



## BENEFIT IN KIND COMPANY CAR TAXATION†

The car benefit charge will be the car's list price (including VAT, options and accessories fitted, delivery to Retailer and number plates, but excluding Vehicle Excise Duty and new vehicle first registration fee) multiplied by the percentage charge for the CO<sub>2</sub> emissions band in which the car falls (see table opposite). Multiply this figure by your personal income tax rate (20%†† for Basic Rate, 40%†† for Higher Rate) to calculate your annual benefit in kind tax liability.

### Example:

**ADAM JAM 1.2i (70PS)**  
(CO<sub>2</sub> emissions 128g/km)

<b>On-the-road RRP</b>	£13450.00
Deduct: Vehicle Excise Duty	(£165.00)
New vehicle first registration fee	(£55.00)
<b>Effective list price</b>	£13230.00
Add: Optional two-coat metallic paint	£565.00

**List price for tax purposes (P11D value)**  
£13795.00

**Car benefit charge**  
2018-19 tax year (26%) £3586.00

<b>Benefit in kind tax liability (2018-19 tax year)</b>	
Basic Rate (20%) tax payer	£717.20
Higher Rate (40%) tax payer	£1434.40

† = Please note this Price Guide provides taxation information as a guide only. Vauxhall does not provide taxation guidance. Drivers should always take professional advice on their own tax position. †† = Excludes residents of Scotland.

### BIK FOR SCOTTISH RESIDENTS

Effective 6 April 2018 the Scottish Government have introduced their own BIK taxation structure. This only applies to Company Car Drivers that are Scottish taxpayers. HMRC will determine whether or not an individual is a Scottish taxpayer based on where their main place of residence is.

#### The BIK rates for Scotland are:

- Over £11,850-£13,850 Starter Rate 19%
- Over £13,850-£24,000 Basic Rate 20%
- Over £24,000-£43,430 Intermediate Rate 21%
- Over £43,430-£150,000 Higher Rate 41%
- Above £150,000 Top Rate 46%

CO <sub>2</sub> emissions in grams per kilometre	Percentage of car's price to be taxed	
	Non-Diesel† 2018-19 tax year	Diesel†† 2018-19 tax year
Up to 50	13	17
51-75	16	20
76-94	19	23
95-99	20	24
100-104	21	25
105-109	22	26
110-114	23	27
115-119	24	28
120-124	25	29
125-129	26	30
130-134	27	31
135-139	28	32
140-144	29	33
145-149	30	34
150-154	31	35
155-159	32	36
160-164	33	37
165-169	34	37
170-174	35	37
175-179	36	37
180 and above	37	37

‡ = Also applies to diesel vehicles that meet the Real Driving Emissions Step 2 (RDE2). †† = Applies to vehicles that do not meet the Real Driving Emissions Step 2 (RDE2).

To calculate your own personal liability a car tax calculator is available at: <https://www.vauxhallfleet.co.uk/toolbox>

## CONTACT VAUXHALL FLEET

Please contact one of our dedicated sales teams who will be happy to help with your particular enquiry.

### Company Car Drivers

Call: 0345 111 2020

Email: [company-car@vauxhallinfo.co.uk](mailto:company-car@vauxhallinfo.co.uk)

Telephone lines are open

– Monday to Friday 8.00am-9.00pm

– Saturday and Sunday 9.00am-6.00pm

### Fleet Decision Makers

Depending on the size of your fleet of vehicles, we have a dedicated team to handle your enquiries.

The lines are open Monday to Friday excluding Bank Holidays.

### 1-24 vehicles

Call: 0845 076 2254 (8.30am-5.00pm)

Email: [b2bsales@vauxhall.co.uk](mailto:b2bsales@vauxhall.co.uk)

### 25+ vehicles

Call: 0330 587 8222 (8.30am-5.00pm)

Email: [vauxhallfleet@vauxhall.co.uk](mailto:vauxhallfleet@vauxhall.co.uk)

### Special Vehicles (Police, Fire and Ambulance)

Call: 01582 409999 (8.30am-5.00pm)

Email: [vauxhallspecialvehicles@vauxhall.co.uk](mailto:vauxhallspecialvehicles@vauxhall.co.uk)

# ADAM ADDITIONAL INFORMATION

## ON-THE-ROAD PRICES

To eliminate uncertainty about hidden costs when buying a new car, Vauxhall publishes on-the-road recommended retail prices (RRP) and these are shown in the pricing tables within this price guide. These prices include VAT, number plates and delivery to Retailer of £700.00 (including £116.67 VAT), 12 months' Government Vehicle Excise Duty (see opposite for details) and the DVLA new vehicle first registration fee of £55.00\*.

Please note: The on-the-road recommended retail price (RRP) does not include fuel supplied by the Retailer, motor insurance or any other goods or services supplied by agreement between the Retailer and the customer.

## PRICE PROTECTION

Order a new Vauxhall for build in the current model year (as confirmed by your Retailer) for delivery no more than three months in advance and the price you are quoted is the price you pay. This is irrespective of any subsequent price rises between placing your order and delivery of your new car, but you must take delivery as soon as the car is available. Vauxhall Motors Limited is not liable for price adjustments caused by Government changes in the rate of VAT (currently 20%), Vehicle Excise Duty, DVLA new vehicle first registration fee or by any other applicable legislation or regulations.

## VAUXHALL FINANCE LEASING

Vauxhall Finance Leasing is a trading style of Vauxhall Finance plc. Working with the Vauxhall Retailer network we provide competitive car and van leasing solutions for business users and private individuals. We combine the support of a national contract with the convenience of a local contact. For further information, please contact your local Vauxhall Retailer or visit [www.vauxhall.co.uk/leasing](http://www.vauxhall.co.uk/leasing)

## IN THE EVENT OF AN ACCIDENT...

Vauxhall Accident Management helps keep you mobile following an accident. Benefits include vehicle recovery, Vauxhall-approved repairs and contacting your insurer. For more details, visit [vauxhall.co.uk/AccidentManagement](http://vauxhall.co.uk/AccidentManagement)

## VEHICLE EXCISE DUTY

The amount of Vehicle Excise Duty (road fund licence) payable on new cars varies depending on the level of carbon dioxide (CO<sub>2</sub>) emissions produced by the vehicle. CO<sub>2</sub> emissions are measured in grammes (g) per kilometre (km) travelled and divided into 13 charging bands shown in the table below.

A 'first year rate' of Vehicle Excise Duty is payable on all new cars and in subsequent years the amount payable reverts to the 'standard rate'. From 1 April 2017 the breakpoints for each of these bands have been revised. Also, for vehicles with a list price over £40,000, including factory-fitted options, an additional £310 is payable for the first five years of standard rate payments.

## VEHICLE EXCISE DUTY\*

	CO <sub>2</sub> emissions	First year rate		Standard rate
		Non-diesel**	Diesel†	
<b>Band A</b>	0g/km	£0.00	£0.00	£0.00
<b>Band B</b>	1 – 50g/km	£10.00	£25.00	£140.00
<b>Band C</b>	51 – 75g/km	£25.00	£105.00	£140.00
<b>Band D</b>	76 – 90g/km	£105.00	£125.00	£140.00
<b>Band E</b>	91 – 100g/km	£125.00	£145.00	£140.00
<b>Band F</b>	101 – 110g/km	£145.00	£165.00	£140.00
<b>Band G</b>	111 – 130g/km	£165.00	£205.00	£140.00
<b>Band H</b>	131 – 150g/km	£205.00	£515.00	£140.00
<b>Band I</b>	151 – 170g/km	£515.00	£830.00	£140.00
<b>Band J</b>	171 – 190g/km	£830.00	£1,240.00	£140.00
<b>Band K</b>	191 – 225g/km	£1,240.00	£1,760.00	£140.00
<b>Band L</b>	226 – 255g/km	£1,760.00	£2,070.00	£140.00
<b>Band M</b>	over 255g/km	£2,070.00	£2,070.00	£140.00

\* = Correct at time of issue. \*\* = Also applies to diesel vehicles that meet the Real Driving Emissions Step 2 (RDE2).

† = Applies to vehicles that do not meet the Real Driving Emissions Step 2 (RDE2).

# TRUST VAUXHALL

## CUSTOMER CARE COMMITMENT

For added peace of mind, Vauxhall has an innovative Customer Care Commitment that offers the following:

- Three-year vehicle warranty consisting of a one-year/unlimited mileage manufacturer's warranty and a second and third year manufacturer's warranty with a 60,000 miles limitation
- Vauxhall Assistance for 12 months from first registration
- Six years' body panel anti-perforation warranty

Please note: Warranty is only available on vehicles sourced from Vauxhall Motors Limited. Terms and conditions apply – please see your Vauxhall Retailer for details.

## VAUXHALL ASSISTANCE

Vauxhall Assistance is provided automatically with every new Vauxhall for 12 months from first registration and covers everything from accident assistance, roadside recovery and 'at home' service to flat tyres. With Vauxhall Assistance help is literally just a free\* phone call away, 24 hours a day, 365 days a year!

\* = Mobile phone users will be charged at their standard tariff.

## PROTECTING THE ENVIRONMENT

Vauxhall's commitment to the environment is demonstrated by our products' many environmental awards. For even more information on Vauxhall's efforts to achieve an environmentally sustainable future, and how to dispose of your end-of-life vehicle, see [www.vauxhall.co.uk/recycling](http://www.vauxhall.co.uk/recycling)

## VAUXHALL SERVICE PLAN

- Fixed monthly payments for the plan duration
- Easy to budget and interest-free
- Genuine parts fitted by Vauxhall-trained technicians

### Plus on Gold plans:

- Valet and courtesy car
- Full AA cover
- Engine flush and fuel treatments
- Litre of oil for top ups between services

Full details can be obtained from your local participating Vauxhall Retailer.

## VAUXHALL INSURANCE WITH ADDED REASSURANCE

Comprehensive cover – Summary of benefits\*\*

- Competitive premiums
- Repairs by a Vauxhall-trained technician
- Genuine Vauxhall parts, guaranteed for three years when we repair your car within our Approved Repairer Network
- Free courtesy car as standard when using an Approved Repairer†
- 24 hour claims helpline
- Personal Accident benefit
- Cover for audio equipment
- Windscreen cover

## Call for a quote on 0844 463 2670††

\*\* = The benefits listed above are for comprehensive cover only. For details of Third Party, Fire and Theft cover, please call our sales team.  
† = Should your car need repairing following an accident we provide a courtesy car (subject to availability) for the duration of the repair. Only genuine Vauxhall parts are used. Terms and conditions apply.  
†† = Calls may be recorded. Vauxhall Insurance is underwritten by Ageas Insurance Limited.

## FOR MORE PRODUCT INFORMATION

For a brochure on any Vauxhall model (up to a maximum of three per caller) or location of your nearest Vauxhall Retailer please call **0345 600 1500**. Alternatively, details can be found on our website at [www.vauxhall.co.uk](http://www.vauxhall.co.uk)

## JOIN US ONLINE:



Privacy Policy – For full details please visit: [vauxhall.co.uk/privacy](http://vauxhall.co.uk/privacy)

OnStar privacy details are available at [vauxhall.co.uk/onstar](http://vauxhall.co.uk/onstar)

The invoice price, including delivery to Retailer, factory-fitted options, accessories fitted by the Retailer and number plates, is subject to VAT. Some feature descriptions in this guide may refer to, and some illustrations may show, optional equipment not included in the standard delivery. The information contained in this guide was accurate at the time of publication. We reserve the right to make changes in design and equipment. Please note that Vauxhall Retailers are not the agents of Vauxhall Motors Limited and are not authorised to bind Vauxhall Motors Limited by any specific or implied undertaking or representation. It is advisable to ensure that your motor insurance policy provides adequate cover for additional fitted options and accessories. The colours in this guide are only approximate actual colours. Illustrated optional equipment is available at extra charge. Availability, technical features and equipment provided on our vehicles can vary by model. For precise information on the equipment provided on our vehicles, please contact your local Vauxhall Retailer.

# VAUXHALL

[vauxhall.co.uk](http://vauxhall.co.uk)

©2018 Vauxhall Motors Limited

Published 15 June 2018 (Amended 17 September 2018) Vauxhall Motors Limited

# ADAM

## PRICE/SPECIFICATION GUIDE

19 December 2017

**Pre-current Model Year**



**VAUXHALL**



# ADAM PRICES

Model 3-door hatch	Price (£)	VAT (£)	Total (£)	On-the-road RRP (£)	CO <sub>2</sub> (g/km)
<b>ADAM JAM</b>					
1.2i (70PS)	10316.67	2063.33	12380.00	<b>13295.00</b>	125
1.4i (87PS)	10462.50	2092.50	12555.00	<b>13470.00</b>	125
<b>ADAM GLAM</b>					
1.2i (70PS)	11458.33	2291.67	13750.00	<b>14665.00</b>	125
1.4i (87PS)	11604.17	2320.83	13925.00	<b>14840.00</b>	125
1.4i (87PS) Easytronic	12062.50	2412.50	14475.00	<b>15390.00</b>	118
<b>ADAM S </b>					
1.4i Turbo (150PS) Start/Stop	14804.17	2960.83	17765.00	<b>18720.00</b>	139
<b>ADAM ENERGISED (SPECIAL EDITION MODEL)</b>					
1.2i (70PS)	11854.17	2370.83	14225.00	<b>15140.00</b>	125
<b>ADAM ENERGISED BLACK JACK PACK (SPECIAL EDITION MODEL)</b>					
1.2i (70PS)	12083.33	2416.67	14500.00	<b>15415.00</b>	125
<b>ADAM UNLIMITED</b>					
1.2i (70PS)	10566.67	2113.33	12680.00	<b>13595.00</b>	125
1.0i Turbo (115PS) Start/Stop ecoTEC	12150.00	2430.00	14580.00	<b>15475.00</b>	108

Please note: On-the-road recommended retail prices (RRP) include number plates and delivery to Retailer of £700.00 (inc. £116.67 VAT), 12 months' Vehicle Excise Duty and new vehicle first registration fee of £55.00. Excludes fuel and insurance.

# ADAM FEATURES/OPTIONS

## SAFETY

### Standard features

**Airbags:** • Driver's airbag • Front passenger's airbag • Front seat side-impact airbags • Full-size curtain airbags for front and rear seat passengers • Deactivation switch for front passenger's front and side-impact airbags – Ensures front passenger airbags do not inflate when a child seat is fitted to the front passenger's seat

**Seating:** • Height-adjustable front and rear seat head restraints • Four lap and diagonal inertia-reel seatbelts • Front body-lock diagonal seatbelt pretensioner system – Tightens the seatbelt during the early stages of a frontal impact • Driver's and front passenger's lap belt pretensioner system • Front seatbelt force limiters – Reduces potential upper body injuries during a frontal impact • Anti-submarining ramps in front seats • ISOFIX child seat restraint system for rear seats incorporating top tether (does not include child seat) – Secures specially designed ISOFIX child safety seats to the vehicle itself, virtually eliminating the dangers that can result from improper installation

**Electronic:** • Electronic Stability Programme-plus (ESP-plus) – Reduces the possibility of losing control of the vehicle • Anti-lock Braking System (ABS) • Electronic brakeforce distribution • Cornering brake control • Emergency brake assist – Increases brakeforce applied in emergency braking situations • Hill start assist • Straight line stability control • Traction control • Adaptive brake lights – If the driver brakes hard enough to activate the ABS function the brake lights flash on and off at a frequency of five times per second, warning following vehicles that heavy braking is in progress • Tyre pressure monitoring system

**Body:** • Energy-absorbing steering column • Pedal release system – Reduces potential injury to the driver's legs and feet during a severe frontal impact • Laminated windscreen • Side-impact protection beams • Reinforced passenger safety cell • Deformation zones front and rear

**Pedestrian:** • Collapsible windscreen wiper system – Reduces the risk of head injury • Low density foam near front bumper crossmember – Reduces lower leg injuries • Plastic lower front bumper stiffener – Reduces knee injuries

Additional feature	ADAM JAM	ADAM GLAM	ADAM SLAM	ADAM S	ADAM ENERGISED	Price (£) exc. VAT	Total (£) inc. VAT
Switchable Electronic Stability Programme-plus (ESP-plus)				●			

## SECURITY

**Standard features** • Remote control two-stage central deadlocking (doors, tailgate, fuel filler flap) • Visible Vehicle Identification Number (VIN) plate • Electronic engine deadlock immobiliser • Electronic theft protection for audio equipment • Driver's and front passenger's internal central locking switch • Luggage area cover • Folding key (colour-keyed to body colour on ADAM JAM, GLAM, SLAM and ENERGISED models)

Additional features	ADAM JAM	ADAM GLAM	ADAM SLAM	ADAM S	ADAM ENERGISED	Price (£) exc. VAT	Total (£) inc. VAT
Locking wheel nuts	●	●	●	●	●		
Remote control security alarm system	○	○	○	○		216.67	260.00

## FACIA, INSTRUMENTS AND CONTROLS

**Standard features** • Leather-covered steering wheel • Multi-function trip computer<sup>1</sup> • Cruise control with speed limiter function • Shift-up indication light (Start/Stop models only) • Rev counter • Digital clock with automatic RDS time adjustment • Black instruments with chrome edging • Steering column adjustable for reach and rake • Electronic odometer and trip odometer • Instrument panel light dimmer • Handbrake-on/low brake fluid level and low fuel level warning lights • Service interval monitor • Seatbelt unfastened warning light for front and rear seats

Additional features	ADAM JAM	ADAM GLAM	ADAM SLAM	ADAM S	ADAM ENERGISED	Price (£) exc. VAT	Total (£) inc. VAT
City mode button providing lighter steering at parking speeds	●	●	●		●		
Winter Pack <sup>2</sup> • Electrically heated front seats • Electrically heated leather-covered steering wheel	○	○	○	○ <sup>3</sup>		187.50	225.00

● = Standard equipment. ○ = Optional at extra cost.

1 = Information shown in the following order: instantaneous fuel consumption, average fuel consumption, range remaining, outside temperature. 2 = Fitted at no extra cost in conjunction with optional leather seat facings. 3 = Not available in conjunction with Black Track Cloth/Morrocana Recaro sports front seats.

# ADAM FEATURES/OPTIONS

## HEATING AND VENTILATION

Standard features • Interior pollen filter • Air recirculation with activation light • Air blend heater

	ADAM JAM	ADAM GLAM	ADAM SLAM	ADAM S	ADAM ENERGISED	Price (£) exc. VAT	Total (£) inc. VAT
<b>Additional features</b>							
Air conditioning with four-speed fan	●				●		
Electronic climate control incorporating air conditioning with six-speed fan		●	●	●			

## INTERIOR FEATURES

Standard features • Driver's and front passenger's seats with reach and rake adjustment • Driver's seat height adjuster • 12-volt auxiliary power socket within centre console • Two drinks holders in rear centre console • Chrome-effect interior door handles • Colour-keyed fleece velour carpet • Front door pockets • Front assist handles • Fully carpeted and illuminated luggage area • Twin sunvisors incorporating driver's vanity mirror with cover • Courtesy lighting operated by door switches • 50/50 split-folding rear seat back

	ADAM JAM	ADAM GLAM	ADAM SLAM	ADAM S	ADAM ENERGISED	Price (£) exc. VAT	Total (£) inc. VAT
<b>Additional features</b>							
Drinks holder in front centre console with adjustable restraining strap		●	●	●			
Electro-chromatic anti-dazzle rear-view mirror	□	□	□	□			
Japan Black facia and door panel inserts	● <sup>4</sup>	●	● <sup>5</sup>	N/C		<b>No-cost option</b>	
Facia and door panel inserts matched to exterior colour	● <sup>6</sup>		● <sup>6</sup>		●		
Pearl White facia and door panel inserts	● <sup>7</sup>						
Red your Engine facia and door panel inserts				●			
Black Cloth interior	●	●					
Black Cloth/Morrocana interior		○	●	●	●	300.00	360.00
Black Leather seat facings, electrically heated front seats, electrically heated leather-covered three-spoke steering wheel and front passenger's seat height adjuster			○			591.67	710.00
Recaro sports front seats, Black Track Cloth/Morrocana trim and front passenger's seat height adjuster				○ <sup>8</sup>		875.00	1050.00
Recaro sports front seats, Black Nappa Leather seat facings, electrically heated front seats, electrically heated three-spoke leather-covered steering wheel and front passenger's seat height adjuster				○		1350.00	1620.00
Electrically heated front seats	□	□	□	□			
Map pocket on front seat backs			●	●			
Sports pedals				●	●		

● = Standard equipment. ○ = Optional at extra cost. □ = Available as part of an option pack. N/C = No-cost option.

4 = Standard on Black Jack models. Not available with other exterior colours. 5 = Standard on Saturday White Fever, Black Jack, Shades of Grey, Heavy Metal and Pump up the Blue models. Not available with other exterior colours. 6 = Standard on Orange Alert, Red 'n' Roll, James Blonde, Mint my Mind, Pump up the Blue (on ADAM JAM) and (on ADAM SLAM) Let it Blue models. Not available with other exterior colours. 7 = Standard on Saturday White Fever, Shades of Grey and Heavy Metal models. Not available with other exterior colours. 8 = Not available in conjunction with Winter Pack.

# ADAM FEATURES/OPTIONS

## MECHANICAL FEATURES

<i>Features</i>	<i>ADAM JAM</i>	<i>ADAM GLAM</i>	<i>ADAM SLAM</i>	<i>ADAM S</i>	<i>ADAM ENERGISED</i>	Price (£) exc. VAT	Total (£) inc. VAT
Speed-sensitive power-assisted steering	●	●	●	●	●		
Sports suspension	○ <sup>9</sup>	○ <sup>9</sup>	●	●	●		
Five-speed manual gearbox (excluding 1.0i Turbo (115PS)/1.4i Turbo (150PS) models)	●	●	●		●		
Six-speed manual gearbox (1.0i Turbo (115PS)/1.4i Turbo (150PS) models only)			●	●			
Easytronic five-speed transmission with sequential manual gearshift or automatic mode (1.4i (87PS) models only)		▲					

● = Standard equipment. ○ = Optional at extra cost. ▲ = See price pages for details.

<sup>9</sup> = Fitted in conjunction with optional 17-inch wheels, not available separately.

# ADAM FEATURES/OPTIONS

## EXTERIOR FEATURES

Standard features • Tinted glass • Heated rear window with automatic timed cut-off • Rear window wash/wipe • Electrically operated front windows with safety autoreverse and one-touch facility  
 • Electrically adjustable/heated door mirrors • Black B-pillars • Lights-on audible warning • Welcome lighting • Twin gas-assisted tailgate struts



	ADAM JAM	ADAM GLAM	ADAM SLAM	ADAM S	ADAM ENERGISED	Price (£) exc. VAT	Total (£) inc. VAT
<b>Additional features</b>							
Body-colour door handles	●		●	●	●		
Body-colour door handles with chrome-effect insert	□	●					
Body-colour door mirrors	●	●	N/C	N/C			<b>No-cost option</b>
Body-colour roof	●	●	N/C	N/C			<b>No-cost option</b>
Rear roof spoiler			□				
Unique ADAM S rear roof spoiler				●			
<b>Black Jack Roof Colour Pack</b> • Black Jack roof and door mirrors	□	○	●	●	●	254.17	<b>305.00</b>
<b>White my Fire Roof Colour Pack</b> • White my Fire roof and door mirrors	□	○	N/C	N/C		254.17	<b>305.00</b>
<b>Let it Blue Roof Colour Pack</b> • Let it Blue roof and door mirrors				N/C			<b>No-cost option</b>
<b>Shades of Grey Roof Colour Pack</b> <sup>10</sup> • Shades of Grey roof and door mirrors			N/C	N/C			<b>No-cost option</b>
<b>Red 'n' Roll Roof Colour Pack</b> • Red 'n' Roll roof and door mirrors				N/C			<b>No-cost option</b>
<b>Style Pack</b> • Choice of White my Fire or Black Jack Roof Colour Pack • 17-inch Technical Grey Roulette alloy wheels • Dark-tinted rear windows	○	○				587.50	<b>705.00</b>
<b>Extreme Carbon Pack</b> • Carbon fibre-effect door mirrors, front grille bar and rear-view mirror			○			175.00	<b>210.00</b>
<b>Extreme Carbon Pack</b> • Carbon fibre-effect door mirrors, front grille bar and rear-view mirror • Carbon fibre-effect inserts on lower front and rear bumpers				○		237.50	<b>285.00</b>
High-gloss black front grille bar					●		
Chrome-effect upper side window mouldings	□	●	●	●			
Chrome-effect door sill covers	□	●	●	●			
<b>Sight and Light Pack One</b> <sup>11</sup> • Rain-sensitive windscreen wipers • Automatic lighting control with tunnel detection • Electro-chromatic anti-dazzle rear-view mirror	○	○	○	○		200.00	<b>240.00</b>
<b>Sight and Light Pack Two</b> <sup>12</sup> • Rain-sensitive windscreen wipers • Automatic lighting control with tunnel detection			○	○		175.00	<b>210.00</b>
Daytime running lights	●	●			●		
LED daytime running lights			●	●			
LED tail lights			○	○		100.00	<b>120.00</b>
<b>Exterior Light Pack</b> • LED daytime running lights • LED tail lights	○	○			○	175.00	<b>210.00</b>
<b>Urban Pack</b> • Chrome-effect upper side window mouldings • Chrome-effect door sill covers • Chrome-effect inserts on exterior door handles • LED daytime running lights and tail lights • Multi-colour illumination (eight colours) of centre console, door trim and footwells • Twin sunvisors incorporating illuminated driver's and front passenger's vanity mirrors with covers	○					341.67	<b>410.00</b>
Fixed glass roof panel with sliding blind		●					
Rear parking distance sensors	○	○	○	○		237.50	<b>285.00</b>
<b>Technical Pack</b> • R4.0 IntelliLink • Rear parking distance sensors	○ <sup>13</sup>	○	○	○		429.17	<b>515.00</b>
Dark-tinted rear windows (also available as part of optional style pack)	○	○	●	●	○	145.83	<b>175.00</b>
<b>VXR Styling Pack</b> <sup>14</sup> • Body-colour front lower spoiler/side sills/rear lower skirt/rear roof spoiler			○	●		633.33	<b>760.00</b>
Chrome-effect exhaust tailpipe extension				●			

● = Standard equipment. ○ = Optional at extra cost. □ = Available as part of an option pack. N/C = No-cost option.

10 = Not available on Heavy Metal models. 11 = Not available in conjunction with optional Extreme Carbon Pack. 12 = Only available in conjunction with optional Extreme Carbon Pack. 13 = ADAM JAM models do not feature digital radio. 14 = Not available on 1.2i (70PS) models. ADAM S models feature a unique rear roof spoiler.

# ADAM FEATURES/OPTIONS

## EXTERIOR COLOURS

	ADAM JAM	ADAM GLAM	ADAM SLAM	ADAM S	ADAM ENERGISED	Price (£) exc. VAT	Total (£) inc. VAT
 <p><b>Orange Alert</b> • Solid paint</p>	●	●	●				
 <p><b>Red 'n' Roll</b> • Brilliant paint</p>	○	○	○	●	●	237.50	285.00
 <p><b>Saturday White Fever</b> • Brilliant paint</p>	○	○	○	○	N/C	237.50	285.00
 <p><b>White my Fire</b> • Brilliant paint</p>		○				237.50	285.00
 <p><b>Mint my Mind</b> • Brilliant paint</p>	○	○	○		N/C	237.50	285.00

● = Standard equipment. ○ = Optional at extra cost. N/C = No-cost option.

The colours reproduced may vary slightly from the actual paint colour. As a result they should be used as a guide only. Your Vauxhall Retailer has a comprehensive display of our paint samples.

# ADAM FEATURES/OPTIONS

## EXTERIOR COLOURS





	ADAM JAM	ADAM GLAM	ADAM SLAM	ADAM S	ADAM ENERGISED	Price (£) exc. VAT	Total (£) inc. VAT
 <p><b>Black Jack</b> • Two-coat metallic paint</p>	<input type="radio"/>	<input type="radio"/>	<input type="radio"/>	<input type="radio"/>	N/C	470.83	565.00
 <p><b>Shades of Grey</b> • Two-coat metallic paint</p>	<input type="radio"/>	<input type="radio"/>	<input type="radio"/>	<input type="radio"/>		470.83	565.00
 <p><b>Purple Fiction</b> • Two-coat pearlescent paint</p>		<input type="radio"/>				470.83	565.00
 <p><b>Heavy Metal</b> • Two-coat metallic paint • Not available with Shades of Grey Roof Colour Pack</p>	<input type="radio"/>	<input type="radio"/>	<input type="radio"/>	<input type="radio"/>		470.83	565.00

= Optional at extra cost. N/C = No-cost option.

The colours reproduced may vary slightly from the actual paint colour. As a result they should be used as a guide only. Your Vauxhall Retailer has a comprehensive display of our paint samples.

# ADAM FEATURES/OPTIONS

## EXTERIOR COLOURS

	ADAM JAM	ADAM GLAM	ADAM SLAM	ADAM S	ADAM ENERGISED	Price (£) exc. VAT	Total (£) inc. VAT
 <p><b>James Blonde</b> • Premium paint</p>	<input type="radio"/>	<input type="radio"/>	<input type="radio"/>			543.83	<b>655.00</b>
 <p><b>Goldbusters</b> • Two-coat premium paint</p>					N/C	<b>No-cost option</b>	
 <p><b>Let it Blue</b> • Two-coat premium paint</p>			<input type="radio"/>	<input type="radio"/>	N/C	543.83	<b>655.00</b>
 <p><b>Pump up the Blue</b> • Two-coat premium paint</p>	<input type="radio"/>	<input type="radio"/>	<input type="radio"/>	<input type="radio"/>		543.83	<b>655.00</b>

= Optional at extra cost. N/C = No-cost option.

The colours reproduced may vary slightly from the actual paint colour. As a result they should be used as a guide only. Your Vauxhall Retailer has a comprehensive display of our paint samples.



# ADAM FEATURES/OPTIONS

## AUDIO, COMMUNICATION AND NAVIGATION

Features	ADAM JAM	ADAM GLAM	ADAM SLAM	ADAM S	ADAM ENERGISED	Price (£) exc. VAT	Total (£) inc. VAT
<b>CD/MP3 CD player/stereo radio</b> • CD/MP3 CD player • USB connection with iPod control • AM/FM stereo radio with 36 station presets • RDS with Traffic Programme • 20 watts per channel output	●	●	●	●			
<b>R4.0 IntelliLink touchscreen infotainment system – For use with media players, USB memory sticks, mobile phones and smartphone apps</b> <b>Onboard features:</b> • 7-inch colour touchscreen • AM/FM stereo radio with 36 station presets • RDS with Traffic Programme <b>Media connections:</b> • USB connection with iPod control • Bluetooth® A2DP audio streaming (Advanced Audio Distribution Profile) <b>Mobile phone portal:</b> • Bluetooth® connectivity • Handsfree calls via steering wheel controls • Vehicle microphone • Phone book access – Contacts/last calls/missed calls etc. are mirrored on IntelliLink's display and are easily navigated using the touchscreen (features dependent on mobile phone) <b>Smartphone interface:</b> • Apple CarPlay™ • Android Auto™	□	□	□	□	●		
<b>Navi 4.0 IntelliLink touchscreen navigation and infotainment system (not available in conjunction with Technical Pack) – For use with media players, USB memory sticks, mobile phones and smartphone apps</b> <b>Onboard features:</b> • 7-inch colour touchscreen • AM/FM stereo radio with 36 station presets • RDS with Traffic Programme • 20 watts per channel output <b>Navigation features:</b> • Satellite navigation system • 2D street level mapping • European coverage • Structured or one-box destination entry • Points-of-interest search • Eco routing • Map updates via USB <b>Media connections:</b> • USB connection with iPod control • Bluetooth® A2DP audio streaming (Advanced Audio Distribution Profile) <b>Mobile phone portal:</b> • Bluetooth® connectivity • Handsfree calls via steering wheel controls • Vehicle microphone • Phone book access – Contacts/last calls/missed calls etc. are mirrored on IntelliLink's display and are easily navigated using the touchscreen (features dependent on mobile phone) <b>Smartphone interface:</b> • Apple CarPlay™ • Android Auto™ <b>Gallery</b> – only available when vehicle is stationary: • Photo gallery with slide show feature • Video playback with soundtrack played through car speakers	○	○	○	○		654.17	785.00
Aux-in socket (deleted if optional Technical Pack or Navi 4.0 IntelliLink is specified)	●	●	●	●			
Digital radio		●	●	●	●		
Number of speakers	4*	6	6	6	4		
Bluetooth® mobile phone portal	●	●	●	●	●		
Music streaming via Bluetooth®	●	●	●	●	●		
Vauxhall OnStar**	○	○	●	●	○	345.83	415.00
Steering wheel mounted audio controls	●	●	●	●	●		

● = Standard equipment. ○ = Optional at extra cost. □ = Available as part of an option pack.

\* = 6 speakers are fitted when optional Technical Pack or rear parking distance sensors are specified. \*\* = Includes 12 months of OnStar services from date of first registration and a 3 month/3 GB Wi-Fi free trial period (whichever comes first) effective from the date the customer accepts the nominated network operator Wi-Fi Ts&Cs. Destination download feature only operates on models fitted with Navi 4.0 IntelliLink satellite navigation system. Theft alert feature only operates if optional security alarm system is specified.

# ADAM FEATURES/OPTIONS

## VAUXHALL ONSTAR – YOUR PERSONAL ON BOARD ASSISTANT

Many car brands talk about innovation as soon as they improve their cup holders but this innovative system, now available on selected models†, is revolutionary: 24/7, 365 days a year, Vauxhall OnStar puts you in touch with a trained advisor, not a machine. With OnStar you have access to a host of innovations, from Vehicle Diagnostics and Smartphone Function to a fully integrated 4G Wi-Fi Hotspot††. In the event of an accident, Vauxhall OnStar even automatically calls for help, for an incomparable feeling of safety.

† = The OnStar Services require activation and are subject to mobile network coverage and availability. Wi-Fi Hotspot service requires account with nominated network operator.

†† = 4G is subject to mobile network coverage and availability. Charges apply after the free trial period. The OnStar subscription packages could be different from the services included in the free trial package. Check [www.vauxhall.co.uk/onstar](http://www.vauxhall.co.uk/onstar) for terms and conditions, details of availability, coverage and charges.

## DIGITAL RADIO

Now widely available in the UK, digital radio broadcasts offer the user a variety of advantages over traditional FM, starting with the digital quality sound which is immune to any hiss or crackle.

You'll often find a broader range of stations on offer too, many of which are not available on FM, and listening to them couldn't be easier – you simply select the station, by name, from the displayed list, thus removing the need to retune or look for stations when travelling around. Some stations will even display the artists' names and song titles on the car's graphic display, while they're played.

## INTELLILINK

IntelliLink is Vauxhall's next-generation in-car infotainment system. It features a 7-inch colour touchscreen that enables access to, and operation of, a wide range of functions including music, video, phone, navigation and internet services.

The system isn't equipped with a CD or DVD player. Instead, it's designed to support the latest media sources including Bluetooth® and USB devices, together with smartphones and their applications. All of these features are accessed through the touchscreen's Home menu.

Since many of these features are accessed via smartphone, the IntelliLink unit is designed to allow application updates as and when they become available, thus enabling it to make use of the latest smartphone developments as they happen.





Music can be played either through the radio or from personal music players via USB connection or Bluetooth® audio streaming. When played via USB, IntelliLink's built-in Gracenote® link provides song information and album artwork. Films and slide shows can also be viewed via the USB connection, but this facility is disabled when the car is moving.

IntelliLink is able to pair with up to four Bluetooth® phones simultaneously, with each phone's address book downloaded to the audio unit so that the car effectively becomes the phone. Phone priority can then be set through the touchscreen display.

The smartphone link works in conjunction with Apple CarPlay™ (including Siri Eyes Free) and Android Auto™. These give access to satellite navigation and a wide range of internet radio stations.

# ADAM FEATURES/OPTIONS

## WHEELS AND TYRES

Features		ADAM JAM	ADAM GLAM	ADAM SLAM	ADAM S	ADAM ENERGISED	Price (£) exc. VAT	Total (£) inc. VAT
Emergency spare wheel (in lieu of emergency tyre inflation kit)		○	○	○			91.67	110.00
	<b>16-inch Titan Triple Cross alloy wheels</b> • 195/55 R 16 tyres • Emergency tyre inflation kit (in lieu of spare wheel)	●						
	<b>16-inch Silver Vintage alloy wheels</b> • 195/55 R 16 tyres • Emergency tyre inflation kit (in lieu of spare wheel)		●					
	<b>17-inch Manoogian Hurricane alloy wheels</b> • 215/45 R 17 tyres • Emergency tyre inflation kit (in lieu of spare wheel)			●				
	<b>17-inch Gloss Black Hurricane alloy wheels</b> • 215/45 R 17 tyres • Emergency tyre inflation kit (in lieu of spare wheel)			N/C		●	<b>No-cost option</b>	
	<b>17-inch Technical Grey Roulette alloy wheels</b> • 215/45 R 17 tyres • Emergency tyre inflation kit (in lieu of spare wheel)	□	○				341.67	410.00
	<b>18-inch Silver Turbine alloy wheels</b> • 225/35 R 18 tyres • Emergency tyre inflation kit (in lieu of spare wheel)			○			675.00	810.00
	<b>18-inch Technical Grey Propellor diamond-cut alloy wheels</b> • 225/35 R 18 tyres • Emergency tyre inflation kit (in lieu of spare wheel)				●			

● = Standard equipment. ○ = Optional at extra cost. □ = Available as part of an option pack. N/C = No-cost option.

# ADAM SPECIFICATIONS

## PETROL ENGINES

	1.2i (70PS)	1.4i (87PS)	1.4i (100PS)
Capacity	1229cc	1398cc	1398cc
Maximum power	70PS (51kW) @ 5600rpm	87PS (64kW) @ 6000rpm	100PS (74kW) @ 6000rpm
Maximum torque	115Nm (85 lb.ft.) @ 4000rpm	130Nm (96 lb.ft.) @ 4000rpm	130Nm (96 lb.ft.) @ 4000rpm
Configuration	4 cylinders, 4 valves per cylinder, double overhead camshafts	4 cylinders, 4 valves per cylinder, double overhead camshafts	4 cylinders, 4 valves per cylinder, double overhead camshafts
Fuel/induction system	Naturally aspirated. Variable Valve Timing. Multi-point sequential fuel injection	Naturally aspirated. Variable Valve Timing. Multi-point sequential fuel injection	Naturally aspirated. Variable Valve Timing. Multi-point sequential fuel injection
Emission compliance	Euro 6	Euro 6	Euro 6
Service interval	20,000 miles or 1 year (whichever occurs sooner)	20,000 miles or 1 year (whichever occurs sooner)	20,000 miles or 1 year (whichever occurs sooner)

	1.0i Turbo (115PS) ecoTEC with Start/Stop	1.4i Turbo (150PS) with Start/Stop
Capacity	998cc	1364cc
Maximum power	115PS (85kW) @ 5200rpm	150PS (110kW) @ 4900-5500rpm
Maximum torque	170Nm (125 lb.ft.) @ 1800-4500rpm	220Nm (162 lb.ft.) @ 2750-4500rpm
Configuration	3 cylinders, 4 valves per cylinder, double overhead camshafts	4 cylinders, 4 valves per cylinder, double overhead camshafts
Fuel/induction system	Water-cooled turbocharger with intercooler. Variable Valve Timing (VVT) Central direct injection	Water-cooled turbocharger with intercooler. Variable Valve Timing (VVT) Multi-point sequential fuel injection
Emission compliance	Euro 6	Euro 6
Service interval	20,000 miles or 1 year (whichever occurs sooner)	20,000 miles or 1 year (whichever occurs sooner)

## PERFORMANCE, FUEL ECONOMY AND EMISSIONS

	Wheel size (inches)	Performance (manufacturer's figures)		Fuel economy mpg (litres/100km) <sup>#</sup>			CO <sub>2</sub> emissions g/km <sup>#</sup>	Vehicle Excise Duty* Standard rate		Benefit in kind company car taxation rates – 2017/18 tax year
		Maximum speed (mph)	Acceleration 0-62mph (sec)	Urban driving	Extra-urban driving	Combined figure		First year rate		
<b>Manual</b>										
1.2i (70PS)	16/17/18	103	14.9	39.2 (7.2)	65.7 (4.3)	53.3 (5.3)	125	£160	£140	24%
1.4i (87PS)	16/17/18	109	12.5	39.8 (7.1)	62.8 (4.5)	52.3 (5.4)	125	£160	£140	24%
1.4i (100PS)	17/18	115	11.5	39.8 (7.1)	62.8 (4.5)	52.3 (5.4)	125	£160	£140	24%
1.0i Turbo (115PS) Start/Stop ecoTEC	17/18	121	9.9	47.1 (6.0)	67.3 (4.2)	57.6 (4.9)	112	£160	£140	21%
1.4i Turbo (150PS) Start/Stop	18	130	8.5	37.2 (7.6)	57.6 (4.9)	47.9 (5.9)	139	£200	£140	26%
<b>Easytronic</b>										
1.4i (87PS)	16/17	111	13.9	42.8 (6.6)	68.9 (4.1)	56.5 (5.0)	118	£160	£140	22%

\* = Correct at time of publication.

<sup>#</sup> = Fuel consumption information is official government environmental data, tested in accordance with the relevant EU directive. Official EU-regulated test data is provided for comparison purposes and actual performance will depend on driving style, road conditions and other non-technical factors.

# ADAM SPECIFICATIONS

## TRANSMISSION

### Five-speed manual gearbox:

Standard on all models (except 1.0i Turbo (115PS)/1.4i Turbo (150PS)).

### Six-speed manual gearbox:

Standard on 1.0i Turbo (115PS)/1.4i Turbo (150PS) models only.

### Five-speed Easytronic transmission:

Available at extra cost on 1.4i (87PS) ADAM GLAM models only. Easytronic transmission is a five-speed manual gearbox with a fully automatic mode. In manual mode you simply push the lever forward or back to shift gears up or down sequentially. The facia display tells you what gear you're in – 1 to 5, N for Neutral or A for Auto. Switch to fully automatic

mode and it has many of the features of a regular automatic including a kickdown function. There's no clutch pedal so you can drive it on an automatic-only driving licence.

## STEERING

- Speed-sensitive power-assisted steering

## SUSPENSION

**Front:** Independent. MacPherson struts with gas-pressure dampers and coil springs. Anti-roll bar.

**Rear:** Compound crank with coil springs and gas-pressure dampers.

## BRAKING AND STABILITY

- Electronic Stability Programme – switchable on ADAM S models
- Cornering brake control
- Straight line stability control
- Anti-lock Braking System (ABS)
- Electronic brakeforce distribution
- Emergency brake assist
- Dual circuit, diagonally split braking system
- ADAM S models feature red calipers

### 1.2i (70PS)/1.4i (87PS)

Front ventilated discs: 257mm diameter

Rear drums: 203mm diameter

### 1.4i (100PS)

Front ventilated discs: 257mm diameter

Rear drums: 228mm diameter

### 1.0i Turbo (115PS)

Front ventilated discs: 284mm diameter

Rear drums: 228mm diameter

### 1.4i Turbo (150PS)

Front ventilated discs: 308mm diameter

Rear discs: 264mm diameter

## FUEL TANK CAPACITY

- 38 litres (8.4 gallons)

## GROSS VEHICLE WEIGHTS kg

1.2i (70PS)	1470
1.4i (87PS)	1480
1.4i (100PS)	1480
1.0i Turbo (115PS)	1510
1.4i Turbo (150PS)	1565

Gross vehicle weight is the total permissible weight of the vehicle including passengers and luggage. The maximum roof rack loading should not exceed 50kg.

## TYRE RATING

Tyre size	Fuel efficiency group	Wet grip performance	External noise	
			Measured (dB)	Group
195/55 R 16	B-C	B	71	(A)
215/45 R 17	C	B	71	(A)
225/35 R 18	C	B	77	(B)

Tyre rating according to EU Regulation 1222/2009

## EXTERIOR DIMENSIONS millimetres (inches)

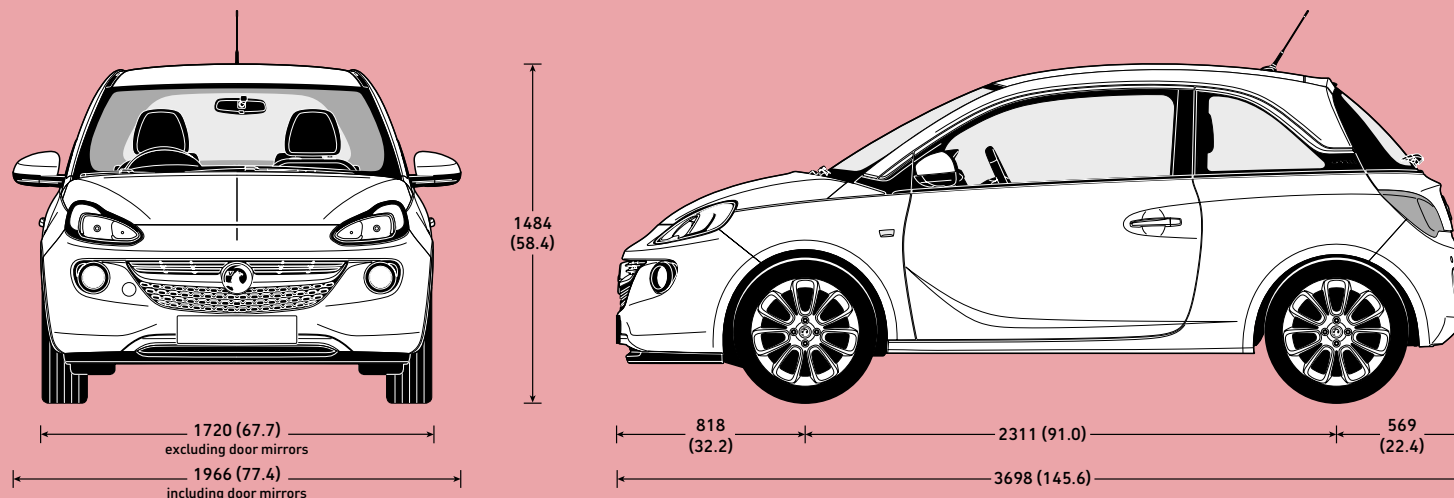

## LOADSPACE DIMENSIONS

	millimetres (inches)
Maximum length (behind rear seats)	462 (18.2)
Maximum length (rear seats folded)	1041 (41.0)
Maximum width	963 (37.9)
Width between wheel arches	954 (37.6)
Maximum height	874 (34.4)

## LUGGAGE CAPACITIES\*

	litres (cu.ft.)
Rear seats up (under luggage compartment cover)	170 (6.0)
Rear seats folded (to upper edge of front seat back)	484 (17.1)
Rear seats folded (to roof)	663 (23.4)

\* = Measured using the ECIE method.

# ADAM ACCESSORIES

	Total (inc. VAT)
<b>CHILD SEATS<sup>1</sup></b>	
BABY-SAFE2 – 0-13kg/birth to 15 months	£132.00
– ISOFIX base	£227.00
DUO ISOFIX2 – 9-18kg/9 months to 4 years	
with top tether kit	£347.00
KID2 –15-36kg or 4 to 12 years	£157.00

1 = Restrictions apply to the use of child seats, please consult your Vauxhall Retailer or request a copy of the Child seats brochure.

2 = Without transponder.

	Total (inc. VAT)
<b>FLEXCONNECT RANGE</b>	
FlexConnect bracket	£20.00
FlexConnect hook	£28.00
FlexConnect coat hanger	£58.00
FlexConnect folding table	£68.00
FlexConnect iPad Mini cradle	£98.00
FlexConnect iPad (1-4) cradle	£106.00
FlexConnect iPad Air cradle	£106.00
FlexConnect Samsung Galaxy cradle	£96.00

	Total (inc. VAT)
<b>INTERIOR</b>	
Velour floor mats (set of four)	from £56.00
Rubber floor mats (set of four)	£46.00
Rear view mirror cap	from £57.00
Front console mat	£37.00
Centre console armrest	£89.00
Cargo box with lid	£183.00
Coloured leather gear knob and gaiter (fitted)	from £64.00
Stainless steel pedal covers – manual (fitted)	£164.00

	Total (inc. VAT)
<b>VXR EXTERIOR STYLING<sup>3</sup></b>	
VX-Line body styling – front lower spoiler/side sills/rear lower skirts (painted/fitted)	£1581.00
VX-Line body styling – rear roof spoiler (painted/fitted)	£539.00

3 = Not available on S models.

**Please note:**

Prices shown are a fully fitted and painted, where applicable and include VAT. Please check with your local Vauxhall Retailer for details. It is advisable to ensure your insurance policy is adequate to cover additional fitted accessories. Prices correct at time of publication.

	Total (inc. VAT)
<b>EXTERIOR</b>	
Door mirror caps (fitted)	from £105.00
Painted logo bar (fitted)	from £88.00
'Fly' decals	
– B-pillar decal (fitted)	£51.00
– C-pillar decal (fitted)	£160.00
'Splat' graphics	
Front wing/rear quarter decals (fitted)	from £128.00
'Sport 01' graphics	
– Bonnet decal (fitted)	from £93.00
– Roof decal (fitted)	£113.00
– C-pillar decal (fitted)	£95.00
'Stripes' graphics	
– Bonnet decal (fitted)	from £130.00
– Roof decal (fitted)	from £127.00
– Door decals (fitted)	from £112.00
– Door / door mirror decals (fitted)	from £132.00
'Stars and Stripes' graphics	
– Roof / B Pillar decals (fitted)	£193.00
'Chequered' graphics	
– Roof decal (fitted)	£121.00
'Motorsport' graphics	
– Bonnet / body side decals (fitted)	£350.00
Body side protection mouldings (painted/fitted)	£211.00

	Total (inc. VAT)
<b>PROTECTION</b>	
Tyre sealant – 450ml	£67.00
Tyre inflation compressor	£120.00
Safety pack – first aid kit/hi-visibility vest/warning triangle	£35.00
First aid kit	£15.00
Hi-visibility vest	£9.00
Warning triangle	£17.00
Spare bulb kit	£26.00
Protection film – front bumper (fitted)	£167.00
Protection film – rear bumper (fitted)	£56.00
Privacy shades – tailgate/rear side windows	£183.00
Exterior windscreen cover	£69.00
Outdoor car cover	from £288.00
Mudflaps – front (fitted)	£63.00
Mudflaps – rear (fitted)	£56.00

	Total (inc. VAT)
<b>TRANSPORT SYSTEMS</b>	
Roof base carrier	£137.00
<b>Roof carriers (requires base carrier)</b>	
Bike roof carrier – Thule Freeride 532	£76.00
Surf board roof carrier – Thule 833	£101.00
Kayak roof carrier – Thule 837	£168.00
Ski roof carrier (400mm wide)	
– Thule Deluxe 726	£ 138.00
Ski roof carrier (600mm wide)	
– Thule 739	£235.00
<b>Hard shell roof boxes (requires base carrier)</b>	
Thule Ocean 80	
(320 litre / 1330 x 860 x 370mm)	£235.00
Thule Ocean 200	
(390 litre / 1750 x 820 x 450mm)	£316.00
Thule Dynamic M	
(320 litre / 2060 x 840 x 340mm)	from £625.00
Thule Dynamic L	
(430 litre / 2350 x 940 x 350mm)	£846.00
Thule Excellence	
(520 litre / 2180 x 940 x 400mm)	£898.00
Thule Motion 800	
(460 litre / 2050 x 840 x 450mm)	from £515.00
Thule Touring 200	
(400 litre / 1750 x 820 x 450mm)	£372.00
Thule Touring 780	
(430 litre / 2320 x 700 x 420mm)	£460.00
<b>Soft roof boxes (requires base carrier)</b>	
Thule Ranger 90	
(280 litre / 1100 x 800 x 400mm)	£285.00
Thule Ranger 500	
(300 litre / 1900 x 500 x 300mm)	£378.00

	Total (inc. VAT)
<b>Tailgate carrier</b>	
Bike tailgate carrier – Thule BacPac 973	£282.00
Fitting kit	£48.00
Flex-fix bicycle carrier – extension kit for third bicycle	£254.00

	Total (inc. VAT)
<b>ALLOY WHEELS (set of four with centre caps)<sup>4</sup></b>	
16-inch Horns	
– Silver	£811.00
– Black	£1052.00
16-inch Vintage	£954.00
16-inch Boomerang	
– Grey / diamond cut face	£758.00
– Green / diamond cut face	£1059.00
– White / diamond cut face	£1001.00
16-inch Triple Cross	
– Titan grey	£804.00
– Manoogian	£805.00
18-inch Turbine	£1078.00
17-inch Hurricane	
– Manoogian	£1165.00
– Black	£898.00
– White	£891.00
17-inch Swiss Blade	
– Silver	£904.00
– Black / white rim	£746.00
– Black / red rim	£1084.00
– Black / blue rim	£1077.00
17-inch Roulette	
– Grey	£884.00
– Grey / diamond cut face	£1165.00
– Grey / white face	£1405.00
– Grey / brown face	£1405.00
– Grey / green face	£953.00
– Copper / white face	£953.00
– Copper / diamond cut face	£785.00
– Black gloss	£898.00
18-inch Twister	
– Grey	£1942.00
– Manoogian	£1961.00
Coloured wheel clips for Twister wheels (set of four)	from £70.00
Tyre valve caps with Vauxhall logos – set of four	£23.00
Locking wheel bolts	£43.00

4 = Different tyres and locking wheel bolts/nuts may be required at extra cost. Price excludes new tyres and locking wheel bolts/nuts, includes static wheel balancing.

# ADAM ADDITIONAL INFORMATION

## ON-THE-ROAD PRICES

To eliminate uncertainty about hidden costs when buying a new car, Vauxhall publishes on-the-road recommended retail prices (RRP) and these are shown in the pricing tables within this price guide. These prices include VAT, number plates and delivery to Retailer of £700.00 (including £116.67 VAT), 12 months' Government Vehicle Excise Duty (see opposite for details) and the DVLA new vehicle first registration fee of £55.00\*.

Please note: The on-the-road recommended retail price (RRP) does not include fuel supplied by the Retailer, motor insurance or any other goods or services supplied by agreement between the Retailer and the customer.

## PRICE PROTECTION

Order a new Vauxhall for build in the current model year (as confirmed by your Retailer) for delivery no more than three months in advance and the price you are quoted is the price you pay. This is irrespective of any subsequent price rises between placing your order and delivery of your new car, but you must take delivery as soon as the car is available. Vauxhall Motors Limited is not liable for price adjustments caused by Government changes in the rate of VAT (currently 20%), Vehicle Excise Duty, DVLA new vehicle first registration fee or by any other applicable legislation or regulations.

## VEHICLE EXCISE DUTY

The amount of Vehicle Excise Duty (road fund licence) payable on new cars varies depending on the level of carbon dioxide (CO<sub>2</sub>) emissions produced by the vehicle. CO<sub>2</sub> emissions are measured in grammes (g) per kilometre (km) travelled and divided into 13 charging bands shown in the table below.

A 'first year rate' of Vehicle Excise Duty is payable on all new cars and in subsequent years the amount payable reverts to the 'standard rate'. From 1 April 2017 the breakpoints for each of these bands have been revised. Also, for vehicles with a list price over £40,000, including factory-fitted options, an additional £310 is payable for the first five years of standard rate payments.

### Vehicle Excise Duty\*

	CO <sub>2</sub> emissions (g/km)	First year rate	Standard rate
Band A	0	£0.00	£0.00
Band B	1-50	£10.00	£140.00
Band C	51-75	£25.00	£140.00
Band D	76-90	£100.00	£140.00
Band E	91-100	£120.00	£140.00
Band F	101-110	£140.00	£140.00
Band G	111-130	£160.00	£140.00
Band H	131-150	£200.00	£140.00
Band I	151-170	£500.00	£140.00
Band J	171-190	£800.00	£140.00
Band K	191-225	£1200.00	£140.00
Band L	226-255	£1700.00	£140.00
Band M	over 255	£2000.00	£140.00

\* = Correct at time of issue.

## VAUXHALL LEASING

As Vauxhall's own contract hire and fleet management operation, Vauxhall Leasing provides a one-stop-shop for competitive car and van leasing solutions – for business users and private individuals. Working with the Vauxhall Retailer network, we combine the support of a national contract with the convenience of a local contact.

For further information, please see your local Vauxhall Retailer or call us on **0117 908 6433**. Alternatively, you can visit our website at [www.vauxhall-leasing.co.uk](http://www.vauxhall-leasing.co.uk)

## IN THE EVENT OF AN ACCIDENT...

Vauxhall Accident Management helps keep you mobile following an accident. Benefits include vehicle recovery, Vauxhall-approved repairs and contacting your insurer. For more details, visit [vauxhall.co.uk/AccidentManagement](http://vauxhall.co.uk/AccidentManagement)

# TRUST VAUXHALL

## CUSTOMER CARE COMMITMENT

For added peace of mind, Vauxhall has an innovative Customer Care Commitment that offers the following:

- Three-year vehicle warranty consisting of a one-year/unlimited mileage manufacturer's warranty and a second and third year manufacturer's warranty with a 60,000 miles limitation
- Vauxhall Assistance for 12 months from first registration
- Six years' body panel anti-perforation warranty

Please note: Warranty is only available on vehicles sourced from Vauxhall Motors Limited. Terms and conditions apply – please see your Vauxhall Retailer for details.

## VAUXHALL ASSISTANCE

Vauxhall Assistance is provided automatically with every new Vauxhall for 12 months from first registration and covers everything from accident assistance, roadside recovery and 'at home' service to flat tyres. With Vauxhall Assistance help is literally just a free\* phone call away, 24 hours a day, 365 days a year!

\* = Mobile phone users will be charged at their standard tariff.

## PROTECTING THE ENVIRONMENT

Vauxhall's commitment to the environment is demonstrated by our products' many environmental awards. For even more information on Vauxhall's efforts to achieve an environmentally sustainable future, and how to dispose of your end-of-life vehicle, see [www.vauxhall.co.uk/recycling](http://www.vauxhall.co.uk/recycling)

## VAUXHALL SERVICE PLAN

- Fixed monthly payments for the plan duration
- Easy to budget and interest-free
- Genuine parts fitted by Vauxhall-trained technicians

### Plus on Gold plans:

- Valet and courtesy car
- Full AA cover
- Engine flush and fuel treatments
- Litre of oil for top ups between services

Full details can be obtained from your local participating Vauxhall Retailer.

## VAUXHALL INSURANCE WITH ADDED REASSURANCE

Comprehensive cover – Summary of benefits\*\*

- Competitive premiums
- Repairs by a Vauxhall-trained technician
- Genuine Vauxhall parts, guaranteed for three years when we repair your car within our Approved Repairer Network
- Free courtesy car as standard when using an Approved Repairer†
- 24 hour claims helpline
- Personal Accident benefit
- Cover for audio equipment
- Windscreen cover

Call for a quote on 0844 463 2670††

\*\* = The benefits listed above are for comprehensive cover only. For details of Third Party, Fire and Theft cover, please call our sales team.  
† = Should your car need repairing following an accident we provide a courtesy car (subject to availability) for the duration of the repair. Only genuine Vauxhall parts are used. Terms and conditions apply.  
†† = Calls may be recorded. Vauxhall Insurance is underwritten by Ageas Insurance Limited.

## FOR MORE PRODUCT INFORMATION

For a brochure on any Vauxhall model (up to a maximum of three per caller) or location of your nearest Vauxhall Retailer please call **0345 600 1500**. Alternatively, details can be found on our website at [www.vauxhall.co.uk](http://www.vauxhall.co.uk)

## JOIN US ONLINE:



Privacy Policy – For full details please visit: [vauxhall.co.uk/privacy](http://vauxhall.co.uk/privacy)

Vauxhall OnStar privacy details are available at [vauxhall.co.uk/onstar](http://vauxhall.co.uk/onstar)

The invoice price, including delivery to Retailer, factory-fitted options, accessories fitted by the Retailer and number plates, is subject to VAT. Some feature descriptions in this guide may refer to, and some illustrations may show, optional equipment not included in the standard delivery. The information contained in this guide was accurate at the time of publication. We reserve the right to make changes in design and equipment. Please note that Vauxhall Retailers are not the agents of Vauxhall Motors Limited and are not authorised to bind Vauxhall Motors Limited by any specific or implied undertaking or representation. It is advisable to ensure that your motor insurance policy provides adequate cover for additional fitted options and accessories. The colours in this guide are only approximate actual colours. Illustrated optional equipment is available at extra charge. Availability, technical features and equipment provided on our vehicles can vary by model. For precise information on the equipment provided on our vehicles, please contact your local Vauxhall Retailer.

# VAUXHALL

[vauxhall.co.uk](http://vauxhall.co.uk)

©2017 Vauxhall Motors Limited

Published 19 December 2017 Vauxhall Motors Limited