

# GTC PRICE/SPECIFICATION GUIDE

2 July 2015



Proud Sponsor of Home Nations Football



# GTC CUSTOMER OFFERS

At Vauxhall we know that customers appreciate flexibility. Not only do we have an extensive range of GTC models to choose from, but we have a range of ways to purchase too. Here's an example on our Flexible PCP programme:

## FREE YOUR SPIRIT SPORT 1.4i 120PS



### FLEXIBLE PCP\* Representative example:

35 Monthly Payments of	£269
On-the-road cash price including customer saving	£20,141.32
Vauxhall Deposit Contribution	£2,700
Customer Deposit	£2,799
Amount of Credit	£14,642.32
Interest Charges	£888.68
Total Amount Payable	£21,030
Optional Final Payment (GFV)	£6,116
Fixed Rate of Interest per year, true	2.84%
Mileage per annum	10,000
Excess mileage charge, per mile	£0.09
Duration of Agreement	36 months
Representative APR	2.9% APR

For even more great deals contact your local retailer or call 0345 600 1500 or visit [www.vauxhall.co.uk/offers](http://www.vauxhall.co.uk/offers)

**TERMS AND CONDITIONS:** \*Offer subject to availability at participating Retailers only. Offer applies to pre-model year 2016 vehicles only. See Retailers for further details. Personal Contract Purchase. Finance subject to status, terms and conditions apply. Applicants must be 18 years or over. Finance by Vauxhall Finance, PO Box 6666, Cardiff, CF15 7YT. Customer deposit shown after deduction of Vauxhall contribution. Vauxhall Deposit Contribution only available when vehicle financed through Vauxhall Finance. At the end of the agreement there are three options: i) Retain the vehicle: Pay the optional final payment to own the vehicle, ii) Return the vehicle, or iii) Replace: Part Exchange the vehicle, where equity is available. Offer applies to private individuals, Vauxhall Partners and small businesses 1-24 units (purchase only excluding B2B supported units). All other customers are excluded. Offer available on orders or registrations between 2 July 2015 and 7 October 2015.

# GTC COMPANY CAR DRIVER/FLEET INFORMATION

## COMPANY CAR DRIVER FREE\* 3 DAY TEST DRIVE



Our free\* 3 Day Test Drive programme is open to all Company Car Drivers which allows you to choose any model in the current Vauxhall line-up (excluding Ampera, all VXR models and Commercial Vehicles), with full insurance cover provided, to give you a meaningful length of time to make an informed decision about your next company car.

Click below to book your free\* test drive  
[www.vauxhall3dtd.co.uk](http://www.vauxhall3dtd.co.uk)  
or call 0870 240 4848\*\*

\*The free 3 Day Test Drive programme is open to Company Car Drivers and excludes fuel and lubricants; congestion charges; parking and speeding fines and the £250 insurance excess (if applicable). It features a wide selection of models from the Vauxhall range (excluding Ampera, all VXR models and Commercial Vehicles and subject to availability). Drivers must be aged 25 years or over, have held a full driving licence for at least a year and hold a major credit card. You will need to have your driving licence (and proof of identity (i.e. passport) where the driving licence is not a photocard licence) when your car is delivered. While every effort will be made to ensure that at least 3 days are provided for the test drive, this cannot always be guaranteed due to delivery and collection dates and timings. Available for UK Mainland only. Terms and conditions apply. \*\*Telephone lines open Monday-Friday 9.00am to 5.00pm excluding Bank Holidays. Calls may be recorded or monitored for quality and/or training purposes.

## FLEET TOOLBOX



Discover the facts in our online Toolbox for both Company Car Drivers and Fleet Decision Makers. The Fleet Toolbox has a host of useful calculators, comparators, interactive listings and information. Visit the Fleet Toolbox by going to [www.vauxhall-toolbox.co.uk](http://www.vauxhall-toolbox.co.uk)

## ROADTRIP APP



The Vauxhall RoadTrip App is a free app that calculates and logs your mileage expenses for any UK business trips and generates reports to help you complete your mileage claims. Available for both iPhone and Android, visit [www.vauxhall-toolbox.co.uk](http://www.vauxhall-toolbox.co.uk) or visit the iPhone or Android stores and search for Vauxhall RoadTrip to download it to your smartphone or tablet.

## BENEFIT IN KIND COMPANY CAR TAXATION†

The car benefit charge will be the car's list price (including VAT, options and accessories fitted, delivery to retailer and number plates, but excluding Vehicle Excise Duty and new vehicle first registration fee) multiplied by the percentage charge for the CO<sub>2</sub> emissions band in which the car falls (see table opposite). Multiply this figure by your personal income tax rate (20% for Basic Rate, 40% for Higher Rate) to calculate your annual benefit in kind tax liability.

### Example:

**GTC Sport 1.6CDTi 110PS Start/Stop ecoFLEX**  
(CO<sub>2</sub> emissions 111g/km)

**On-the-road RRP** £22560.00

Deduct: Vehicle Excise Duty (£0.00)

New vehicle first registration fee (£55.00)

**Effective list price** £22505.00

Add: Optional two-coat metallic paint  
£545.00

**List price for tax purposes (P11D value)**  
£23050.00

**Car benefit charge**  
2015-16 tax year (20%) £4610.00

**Benefit in kind tax liability**  
(2015-16 tax year)

Basic Rate (20%) tax payer £922.00

Higher Rate (40%) tax payer £1844.00

† = Please note this Price Guide provides taxation information as a guide only. Vauxhall does not provide taxation guidance. Drivers should always take professional advice on their own tax position.

CO <sub>2</sub> emissions in grams per kilometre	Percentage of car's price to be taxed	
	Petrol 2015-16 tax year	Diesel 2015-16 tax year
up to 50	5	8
51-75	9	12
76-94	13	16
95-99	14	17
100-104	15	18
105-109	16	19
110-114	17	20
115-119	18	21
120-124	19	22
125-129	20	23
130-134	21	24
135-139	22	25
140-144	23	26
145-149	24	27
150-154	25	28
155-159	26	29
160-164	27	30
165-169	28	31
170-174	29	32
175-179	30	33
180-184	31	34
185-189	32	35
190-194	33	36
195-199	34	37
200-204	35	37
205-209	36	37
210 and above	37	37

To calculate your own personal liability a car tax calculator is available at:  
<https://www.vauxhallfleet.co.uk/toolbox>

## CONTACT VAUXHALL FLEET

Please contact one of our dedicated sales teams who will be happy to help with your particular enquiry.

### Company Car Drivers

Call: 0345 111 2020

Email: [company-car@vauxhallinfo.co.uk](mailto:company-car@vauxhallinfo.co.uk)

Telephone lines are open

– Monday to Friday 8.00am-9.00pm

– Saturday and Sunday 9.00am-6.00pm

### Fleet Decision Makers

Depending on the size of your fleet of vehicles, we have a dedicated team to handle your enquiries. The lines are open Monday to Friday excluding Bank Holidays.

### 1-24 vehicles

Call: 0845 076 2254 (8.30am-5.00pm)

Email: [b2bsales@vauxhall.co.uk](mailto:b2bsales@vauxhall.co.uk)

### 25+ vehicles

Call: 0870 010 0651 (8.30am-5.00pm)

Email: [vauxhallfleet@vauxhall.co.uk](mailto:vauxhallfleet@vauxhall.co.uk)

### Special Vehicles (Police, Fire and Ambulance)

Call: 01525 408 320 (8.30am-5.00pm)

Email: [vauxhallspecialvehicles@vauxhall.co.uk](mailto:vauxhallspecialvehicles@vauxhall.co.uk)

# GTC RANGE HIGHLIGHTS

## **SPORT** **£19,355-£23,780**

- Electronic Stability Programme (ESP)
- Driver's and front passenger's airbags
- Front seat side-impact airbags
- Full-size curtain airbags
- Active-safety front seat head restraints
- Daytime running lights
- 18-inch 7-spoke alloy wheels
- Tyre pressure monitoring system
- Air conditioning
- CD/MP3 CD player with stereo radio (CD 400+)
- Aux-in socket
- Digital radio
- Shark fin aerial
- USB connection with iPod control
- Electrically operated front windows
- Dual-tone horn
- Cruise control
- Remote control central deadlocking
- Three-spoke leather-covered steering wheel
- Steering column adjustable for reach and rake
- Steering wheel mounted audio controls
- Illuminated vanity mirrors
- Driver's and front passenger's seat height adjuster
- 60/40 split-folding rear seat back
- Front seat back storage pockets
- Remote control alarm system (optional at extra cost on 1.4i 120PS Turbo)

## **LIMITED EDITION** **£20,299-£24,480**

### **Features over Sport**

- 20-inch bi-colour alloy wheels
- Sports style front and rear bumper, body-colour front upper grille, side sills, rear lower skirt and rear roof spoiler
- Bluetooth® connectivity
- Dark-tinted rear windows

## **SRI** **£21,070-£25,005**

### **Features over Sport**

- Sports front seats
- Rain-sensitive windscreen wipers
- Automatic lighting control with tunnel detection and digital high beam assist
- Electro-chromatic anti-dazzle rear-view mirror
- Front fog lights
- Multi-function trip computer
- Front centre armrest with storage facility
- Chrome-effect exterior side window surround
- Ambient lighting in doors
- Door sill covers
- Dark-tinted rear windows
- Remote control alarm system

## **BiTurbo** **£24,520**

### **Features over SRI**

- Lowered and uprated suspension
- Three-spoke chrome-bezelled flat-bottom leather-covered steering wheel
- Electric parking brake
- Hill start assist
- Sports pedals
- Sports style front bumper, body-colour front upper grille, side sills, rear lower skirt and rear roof spoiler
- Twin visible stainless steel exhaust tailpipes

# GTC PRICES

Model 3-door hatchback	Price (£)	VAT (£)	Total (£)	On-the-road RRP (£)	CO <sub>2</sub> (g/km)
<b>SPORT</b>					
1.4i 120PS Turbo Start/Stop	15379.17	3075.83	18455.00	<b>19355.00</b>	142
1.4i 140PS Turbo Start/Stop	16120.83	3224.17	19345.00	<b>20245.00</b>	142
1.4i 140PS Turbo auto	17195.83	3439.17	20635.00	<b>21570.00</b>	154
1.6i 200PS Direct Injection Turbo Start/Stop	17245.83	3449.17	20695.00	<b>21595.00</b>	149
<i>Diesel</i>					
1.6CDTi 110PS Start/Stop ecoFLEX	18170.83	3634.17	21805.00	<b>22560.00</b>	111
1.6CDTi 136PS Start/Stop ecoFLEX	18850.00	3770.00	22620.00	<b>23375.00</b>	115
2.0CDTi 165PS Start/Stop	17954.17	3590.83	21545.00	<b>22300.00</b>	124
2.0CDTi 165PS auto	19066.67	3813.33	22880.00	<b>23780.00</b>	149
<b>LIMITED EDITION</b>					
1.4i 120PS Turbo Start/Stop	16165.83	3233.17	19399.00	<b>20299.00</b>	142
1.4i 140PS Turbo Start/Stop	16704.17	3340.83	20045.00	<b>20945.00</b>	142
1.4i 140PS Turbo auto	17779.17	3555.83	21335.00	<b>22270.00</b>	154
1.6i 200PS Direct Injection Turbo Start/Stop	17829.17	3565.83	21395.00	<b>22295.00</b>	149
<i>Diesel</i>					
1.6CDTi 110PS Start/Stop ecoFLEX	18754.17	3750.83	22505.00	<b>23260.00</b>	111
1.6CDTi 136PS Start/Stop ecoFLEX	19433.33	3886.67	23320.00	<b>24075.00</b>	115
2.0CDTi 165PS Start/Stop	18537.50	3707.50	22245.00	<b>23000.00</b>	125
2.0CDTi 165PS auto	19650.00	3930.00	23580.00	<b>24480.00</b>	150
<b>SRI</b>					
1.4i 120PS Turbo Start/Stop	16808.33	3361.67	20170.00	<b>21070.00</b>	142
1.4i 140PS Turbo Start/Stop	17141.67	3428.33	20570.00	<b>21470.00</b>	142
1.4i 140PS Turbo auto	18216.67	3643.33	21860.00	<b>22795.00</b>	154
1.6i 200PS Direct Injection Turbo Start/Stop	18266.67	3653.33	21920.00	<b>22820.00</b>	149
<i>Diesel</i>					
1.6CDTi 110PS Start/Stop ecoFLEX	19195.83	3839.17	23035.00	<b>23790.00</b>	111
1.6CDTi 136PS Start/Stop ecoFLEX	19875.00	3975.00	23850.00	<b>24605.00</b>	115
2.0CDTi 165PS Start/Stop	18975.00	3795.00	22770.00	<b>23525.00</b>	124
2.0CDTi 165PS auto	20087.50	4017.50	24105.00	<b>25005.00</b>	149
<b>BiTurbo</b>					
2.0CDTi 195PS Start/Stop	19804.17	3960.83	23765.00	<b>24520.00</b>	129

Please note: On-the-road recommended retail prices (RRP) include number plates and delivery to retailer of £700.00 (inc. £116.67 VAT), 12 months' Vehicle Excise Duty and new vehicle first registration fee of £55.00. Excludes fuel and insurance.

# GTC FEATURES/OPTIONS

## SAFETY

### Standard features

**Airbags:** • Driver's airbag • Front passenger's airbag • Front seat side-impact airbags • Full-size curtain airbags • Deactivation switch for front passenger's front and side-impact airbags – Ensures front passenger airbags do not inflate when a child seat is fitted to the front passenger's seat

**Seating:** • Active-safety front seat head restraints • Height-adjustable front and outer rear seat head restraints • Five lap and diagonal inertia-reel seatbelts • Front body-lock diagonal seatbelt pretensioner system – Tightens the seatbelt during the early stages of a frontal impact • Drivers and front passenger's lap belt pretensioner system • Front seatbelt force limiters – Reduces potential upper body injuries during a frontal impact • Anti-submerging ramps in front seats – Help prevent occupants sliding underneath the lap belt during a collision • ISOFIX child seat restraint system for outer rear seats incorporating top tether (does not include child seat) – Secures specially designed ISOFIX child safety seats to the vehicle itself, virtually eliminating the dangers that can result from improper installation

**Electronic:** • Electronic Stability Programme-plus (ESP-plus) – Reduces the possibility of losing control of the vehicle • Anti-lock Braking System (ABS) • Electronic brakeforce distribution • Cornering brake control • Hydraulic brake fade assist – Automatically raises braking pressure to compensate for brake fade under repeated applications of heavy braking • Emergency brake assist – Increases brake force applied in emergency braking situations • Straight line stability control • Traction control • Adaptive brake lights – If the driver brakes hard enough to activate the ABS function the brake lights flash on and off at a frequency of four times per second, warning following vehicles that heavy braking is in progress • Tyre pressure monitoring system

**Body:** • Energy-absorbing steering column • Pedal release system – Reduces potential injury to the driver's legs and feet during a severe frontal impact • Laminated windscreen • Side-impact protection beams • Reinforced passenger safety cell • Deformation zones front and rear • Burst-proof door locks and anti-jam door design

## SECURITY

**Standard features** • Driver's internal central locking switch • 'Key left in ignition' audible warning • Electronic theft protection for audio equipment • Remote control central deadlocking (doors, tailgate, fuel filler flap) • Electronic engine deadlock immobiliser • Visible Vehicle Identification Number (VIN) plate • Freewheeling door locks • Locking wheel nuts for alloy wheels

Additional features	Sport	Limited Edition	SRI	BiTurbo	Price (£) exc. VAT	Total (£) inc. VAT
<b>Driving Assistance Pack</b> <sup>1</sup> • Forward collision alert • Lane departure warning • Traffic sign recognition • Automatic lighting control with tunnel detection • Rain-sensitive windscreen wipers • Electro-chromatic anti-dazzle rear-view mirror • Digital high beam assist • Following distance indicator • Intelligent light ranging <sup>2</sup> • Translucent instruments with chrome edging <sup>3</sup>	○	○	○	○	625.00	<b>750.00</b>
Remote control ultrasonic security alarm system <sup>1</sup>	○ <sup>4</sup>	●	●	●	204.17	<b>245.00</b>

## HEATING AND VENTILATION

**Standard features** • Air conditioning with air recirculation • Air blend heater with six-speed fan • Side window demist vents and adjustable face-level air vents • Interior pollen filter

Additional feature	Sport	Limited Edition	SRI	BiTurbo	Price (£) exc. VAT	Total (£) inc. VAT
Dual-zone electronic climate control incorporating air conditioning with humidity sensor	○	○	○	○	329.17	<b>395.00</b>

● = Standard equipment. ○ = Optional at extra cost.

1 = Not available in conjunction with optional panoramic windscreen. 2 = Requires Premium Forward Lighting Pack. 3 = Sport models only. 4 = Optional at extra cost on 1.4i 120PS Turbo Sport models. Standard on all other models.

# GTC FEATURES/OPTIONS

## FACIA, INSTRUMENTS AND CONTROLS

**Standard features** • Cruise control • Rev counter • Multi-function display showing time, date, audio information and outside air temperature • Digital clock with automatic RDS time adjustment • Steering column adjustable for reach and rake • Electronic odometer and trip odometer • Instrument panel light dimmer • Parking brake-on/low brake fluid level and low fuel level warning lights • Service interval monitor • Seatbelt unfastened warning light (front seats only)

	Sport	Limited Edition	SRi	BiTurbo	Price (£) exc. VAT	Total (£) inc. VAT
<b>Additional features</b>						
Three-spoke chrome-bezelled leather-covered steering wheel	●	●	●			
Three-spoke chrome-bezelled leather-covered flat-bottomed steering wheel				●		
Electric parking brake			○	●	187.50	225.00
Leather-covered gear knob (manual models only)			●	●		
Multi-function trip computer (instantaneous fuel consumption, average fuel consumption, range remaining, two trip odometers running concurrently, instantaneous speed, average speed)			●	●		

## INTERIOR LIGHTING

**Standard features** • Fade up/fade down courtesy lights operated by door switches • Map reading lights integral with front courtesy light • Illuminated glovebox and luggage area

	Sport	Limited Edition	SRi	BiTurbo	Price (£) exc. VAT	Total (£) inc. VAT
<b>Additional features</b>						
Ambient lighting in front doors			●	●		
Ambient lighting in centre console surround			●	●		

## SEATING AND UPHOLSTERY

**Standard features** • Driver's and front passenger's seats with height, reach and recline adjustment • 60/40 split-folding rear seat back • Storage pockets on front seat backs

	Sport	Limited Edition	SRi	BiTurbo	Price (£) exc. VAT	Total (£) inc. VAT
<b>Additional features</b>						
Silvanus cloth seat trim	●	●				
Jet Black Imola cloth seat trim with Morrocana-trimmed side bolsters			●			
Jet Black Track cloth seat trim with Morrocana-trimmed side bolsters				●		
Morrello Red Imola cloth seat trim with Morrocana-trimmed side bolsters (not available with Deep Sky Blue, Sculpture Bronze, Emerald Green and Flaming Yellow exterior colours)			N/C		No-cost option	
<b>Leather Pack</b> • Leather seat facings (front and outer rear seats) with Morrocana-trimmed side bolsters • Electrically heated front seats • Driver's ergonomic AGR* sports front seat • Front passenger's extendable seat cushion			○	○	875.00	1050.00
Sports front seats			●	●		
<b>Seat Comfort Pack One</b> • Driver's seat with six-way manual adjustment and four-way electrical lumbar adjustment	○	○	○ <sup>5</sup>	○ <sup>5</sup>	141.67	170.00
<b>Seat Comfort Pack Two</b> <sup>6</sup> • Driver's and front passenger's seat with six-way manual adjustment and four-way electrical lumbar adjustment	○	○	○ <sup>5</sup>	○ <sup>5</sup>	266.67	320.00

● = Standard equipment. ○ = Optional at extra cost. N/C = No-cost option. \* = AGR (The Campaign for Healthier Backs) is an independent centre of excellence for ergonomics, based in Germany.

5 = Not available in conjunction with Leather Pack. 6 = Seat Comfort Pack Two includes the contents of Seat Comfort Pack One. Can be ordered separately.

# GTC FEATURES/OPTIONS

## ADDITIONAL INTERIOR FEATURES

**Standard features** • 12-volt auxiliary power socket within front centre console • Twin sunvisors incorporating illuminated driver's and front passenger's vanity mirrors with covers • Chrome-effect internal door handles • Storage box on driver's side lower fascia • Front door pockets • Fully carpeted luggage area • Load restraint lashing eyes • Luggage compartment cover

<i>Additional features</i>	<i>Sport</i>	<i>Limited Edition</i>	<i>SRi</i>	<i>BiTurbo</i>	<b>Price (£) exc. VAT</b>	<b>Total (£) inc. VAT</b>
Dolomite pearl-effect centre console and Jet black/Dolomite pearl-effect door inserts	●	●				
Liquid palladium/piano black-effect centre console and Jet black/Piano black door inserts			●	●		
Central storage facility with twin covered drinks holders			●	●		
Electro-chromatic anti-dazzle rear-view mirror <sup>1</sup> (part of Sight and Light Pack)	□	□	●	●		

## MECHANICAL

**Standard features** • HiPerStrut (High Performance Strut) • Semi-independent rear suspension with Watt's link and gas-pressure dampers • Sports suspension • Power-assisted steering • Six-speed manual gearbox

<i>Additional features</i>	<i>Sport</i>	<i>Limited Edition</i>	<i>SRi</i>	<i>BiTurbo</i>	<b>Price (£) exc. VAT</b>	<b>Total (£) inc. VAT</b>
Lowered and uprated suspension				●		
FlexRide adaptive chassis control system with continuous damping control	○	○	○	○	658.33	<b>790.00</b>

## EXTERIOR STYLING AND PROTECTION

**Standard features** • Body-colour door handles • Body-colour door mirrors • Black trim on door pillars

<i>Additional features</i>	<i>Sport</i>	<i>Limited Edition</i>	<i>SRi</i>	<i>BiTurbo</i>	<b>Price (£) exc. VAT</b>	<b>Total (£) inc. VAT</b>
Chrome-effect front door sill covers and upper side window mouldings			●	●		
Chrome-effect upper grille surround	●		●			
Body-colour upper grille				●		
Sports style front and rear body-colour bumpers		●		●		
Body-colour rear roof spoiler		●	○	●	333.33	<b>400.00</b>
Visible stainless steel exhaust tailpipe (excludes 1.4i 120PS Turbo/1.6CDTi)	●	●	●			
Twin visible stainless steel exhaust tailpipes (1.6i 200PS Direct Injection Turbo and 2.0CDTi 195PS BiTurbo only)	●	●	●	●		
<b>Perimeter Protection Pack</b> <sup>7</sup> • Advance park assist • Side blind spot alert • Electrically foldable door mirrors	○		○		662.50	<b>795.00</b>
Brilliant paint	○	○	○	○	229.17	<b>275.00</b>
Two-coat metallic or pearlescent paint	○	○	○	○	454.17	<b>545.00</b>

● = Standard equipment. ○ = Optional at extra cost. □ = Available as part of an option pack.

<sup>1</sup> = Not available in conjunction with optional panoramic windscreen. <sup>7</sup> = Not available in conjunction with optional VXR Styling Pack.



# GTC FEATURES/OPTIONS

## EXTERIOR LIGHTING

**Standard features** • Lights-on audible warning • LED centre brake light • Reversing light, rear fog light, hazard warning lights, side repeat indicators • Ellipsoid headlights • Electric headlight beam levelling  
• Dark-style headlights • Daytime running lights • Dark-style tail lights

<i>Additional features</i>	<i>Sport</i>	<i>Limited Edition</i>	<i>SRi</i>	<i>BiTurbo</i>	<b>Price (£) exc. VAT</b>	<b>Total (£) inc. VAT</b>
<b>Sight and Light Pack</b> <sup>1</sup> • Automatic lighting control with tunnel detection • Rain-sensitive windscreen wipers • Electro-chromatic anti-dazzle rear-view mirror • Digital high beam assist	○	○	●	●	191.67	<b>230.00</b>
<b>Premium Forward Lighting Pack</b> • Intelligent Adaptive Forward Lighting (AFL) <sup>8</sup> • Dark-style bi-xenon headlights with dynamic beam levelling • LED daytime running lights • High-pressure headlight washers	○ <sup>9</sup>	○ <sup>9</sup>	○	○	658.33	<b>790.00</b>
Front fog lights			●	●		
LED rear lights	○	○	○	○	95.83	<b>115.00</b>

## EXTERIOR AND CONVENIENCE FEATURES

**Standard features** • Electrically operated front windows with safety autoreverse and one-touch facility • Twin electrically adjustable/heated door mirrors (wide angle on driver's side) • Manually foldable door mirrors • Tinted glass • Windscreen wipers with variable intermittent facility and flick-wipe • Twin-jet windscreen washer nozzles • Heated rear window with automatic timed cut-off • Intermittent rear window wash/wipe • Gas-assisted tailgate struts • Folding key • Dual-tone horn

<i>Additional features</i>	<i>Sport</i>	<i>Limited Edition</i>	<i>SRi</i>	<i>BiTurbo</i>	<b>Price (£) exc. VAT</b>	<b>Total (£) inc. VAT</b>
Hill start assist	● <sup>10</sup>	● <sup>10</sup>	● <sup>10</sup>	●		
Electrically foldable door mirrors	○	○	○	○	145.83	<b>175.00</b>
Rain-sensitive windscreen wipers <sup>1</sup> (part of the Sight and Light Pack)	□	□	●	●		
Dark-tinted rear windows	○	●	●	●	220.83	<b>265.00</b>
Front and rear parking distance sensors	○		○		375.00	<b>450.00</b>
Rear parking distance sensors				○	162.50	<b>195.00</b>
Panoramic windscreen <sup>11</sup>	○	○	○	○	708.33	<b>850.00</b>
<b>VXR Styling Pack</b> <sup>12</sup> • Body-colour front lower spoiler, side sills, rear lower skirt and rear spoiler	○		○		666.67	<b>800.00</b>
<b>Towing Pack</b> • Detachable tow bar • Trailer stability programme	○		○	○	291.67	<b>350.00</b>

● = Standard equipment. ○ = Optional at extra cost. □ = Available as part of an option pack.

<sup>1</sup> = Not available in conjunction with optional panoramic windscreen. <sup>8</sup> = Only features Static cornering and Dynamic curve functions when ordered in conjunction with optional panoramic windscreen. <sup>9</sup> = Only available in conjunction with optional Sight and Light Pack. <sup>10</sup> = Only in conjunction with optional electronic parking brake or automatic transmission. <sup>11</sup> = Not available in conjunction with optional Navi 950 IntelliLink, mobile phone system with Bluetooth® or Sight and Light Pack. Deletes remote control ultrasonic security alarm system and twin sunvisors incorporating illuminated driver's and front passenger's vanity mirrors with covers. On SRi and BiTurbo models Sight and Light Pack is deleted. On Limited Edition models Bluetooth® mobile phone system is deleted. <sup>12</sup> = Does not include visible stainless steel exhaust tailpipe. Not available in conjunction with optional Perimeter Protection Pack.

# GTC FEATURES/OPTIONS

## AUDIO, COMMUNICATION AND NAVIGATION

Features	Sport	Limited Edition	SRI	BITurbo	Price (£) exc. VAT	Total (£) inc. VAT
<b>CD 400+</b> • CD/MP3 CD player • AM/FM stereo radio with 36 station presets • Aux-in socket • RDS with Traffic Programme • Graphic display • 20 watts per channel output • 6 speakers • Shark fin/integrated aerial	●	●	●	●		
<b>Navi 650*</b> • Satellite navigation system • Street level mapping for UK and Ireland • Major route mapping for Western Europe • CD/MP3 CD player • Aux-in socket • USB connection with iPod control • AM/FM stereo radio with 36 station presets • RDS with Traffic Programme • High resolution 7-inch colour monitor • 20 watts per channel output • 6 premium speakers • Shark fin/integrated aerial	○	○	○	○	712.50	<b>855.00</b>
<b>Navi 950 IntelliLink<sup>1</sup></b> • Satellite navigation system • Street level mapping for Europe • CD/MP3 CD player • Mobile phone system with Bluetooth® (does not include phone) • Aux-in socket • USB connection with iPod control • AM/FM stereo radio with 36 station presets • Audio streaming • IntelliLink • RDS with Traffic Programme • High resolution 7-inch colour monitor • 20 watts per channel output • 6 premium speakers • Shark fin/integrated aerial	○	○	○	○	1000.00	<b>1200.00</b>
<b>Infinity® Premium Sound System<sup>13</sup></b> • 7 x 45 Watt amplifier (315 Watt total) • Digital Sound Processor (DSP) • One front mounted 3.5-inch medium range speaker • Two A-pillar mounted 1-inch tweeters • Two front door mounted 6.5-inch subwoofers • Two rear mounted 6.5-inch wide-band speakers • One 8-inch subwoofer box in luggage compartment	○	○	○	○	437.50	<b>525.00</b>
Digital radio with integrated aerial	●	●	●	●		
USB connection with iPod control	●	●	●	●		
Steering wheel mounted audio controls	●	●	●	●		
Bluetooth® mobile phone system (does not include phone) <sup>1</sup>	○	●	○	○	245.83	<b>295.00</b>

● = Standard equipment. ○ = Optional at extra cost. \* = Voice control not available in conjunction with Navi 650.

<sup>1</sup> = Not available in conjunction with optional panoramic windscreen. <sup>13</sup> = Adds FlexFloor luggage compartment. Luggage capacity will be reduced.

### SATELLITE NAVIGATION

The optional Navi 650/950 satellite navigation systems offer dynamic route guidance via RDS-TMC (Traffic Message Channel) with directions given audibly and via the 7-inch colour monitor. TMC is a specific application of RDS used for broadcasting real-time traffic information. It alerts the driver to a problem on the planned route and calculates an alternative route to avoid the incident.

In addition to route planning criteria such as 'shortest distance' or 'avoiding toll roads', you can now select an energy-optimised 'green route'. Here you can specify parameters such as if you are towing a caravan or have a roof box fitted. The system will use this information, in conjunction with known factors including your vehicle's weight and engine type, to calculate the most fuel-efficient route.

The Navi 650 system covers all major link roads and streets in towns and cities across mainland Britain and Ireland, plus trunk and main roads for Western Europe. Additional country-specific maps with street level detail are available to download. Navi 950 IntelliLink covers street level mapping across Europe. The CD player plays regular audio CDs and MP3 tracks recorded to CD.

### DIGITAL RADIO

Now widely available in the UK, digital multi-media broadcasts offer the user a variety of advantages over traditional FM, starting with the digital quality sound which is immune to any hiss or crackle. You'll often find a broader range of stations on offer too, many of which are not available on FM, and listening to them couldn't be easier – you simply select the station, by name, from the displayed list, thus removing the need to retune or look for stations when travelling around. Some stations will even display the artists' names and song titles on the car's graphic display, while they're played.

### BLUETOOTH® MOBILE PHONE SYSTEM WITH VOICE ACTIVATION

Vauxhall's optional factory-fit dual-band Bluetooth® system has been considerably enhanced. Now fully integrated into the audio and communication system, it also features voice control\* for certain functions.

All the required information is displayed on the graphic information display when a mobile phone is in use, while the menus are easily navigated by either the steering wheel audio controls or the multi-function button on the radio.

\* = Please note, voice control is not available with Navi 650 units.

### USB CONNECTION

Fitted as standard, the USB connection is located alongside the aux-in within the centre console. It provides iPod control and read-out of iPod functions through the audio system display. Traditional aux-in only allow control of volume through the car's audio system. The USB connection also means that the iPod will charge whilst it is connected.

### INTELLILINK





The Navi 950 audio system includes the latest IntelliLink technology, designed to support portable Bluetooth® and USB audio devices, so you can hook up your smartphones or tablets to make calls and access your own music, slideshows, podcasts and more.

### INFINITY® PREMIUM SOUND SYSTEM

For the ultimate in premium sound performance GTC can also be specified with the Infinity Sound System. Featuring a 7 x 45 Watt amplifier and Digital Sound Processor, the system comprises eight premium speakers, including one rear-mounted 8-inch subwoofer, two door-mounted and two rear mounted 6.5-inch wide band speakers, two 1-inch tweeters mounted in the A-pillar and a front-mounted 3.5-inch medium range unit. The unit is optional at extra cost on all models.

# GTC FEATURES/OPTIONS

## WHEELS AND TYRES

	<i>Sport</i>	<i>Limited Edition</i>	<i>SRi</i>	<i>BTurbo</i>	Price (£) exc. VAT	Total (£) inc. VAT
<b>Emergency tyre inflation kit (in lieu of spare wheel)</b>	●	●	●	●		
<b>Space-saver spare wheel (in lieu of emergency tyre inflation kit)</b>	○	○	○		79.17	<b>95.00</b>
 <b>18-inch alloy wheels:</b> 235/50 R 18 tyres	●					
 <b>18-inch alloy wheels:</b> 235/50 R 18 tyres			●			
 <b>18-inch alloy wheels:</b> 235/50 R 18 tyres				●		
 <b>19-inch alloy wheels:</b> 235/45 R 19 tyres	○		○	○	470.83	<b>565.00</b>
 <b>20-inch alloy wheels:</b> 245/40 R 20 tyres			○		833.33	<b>1000.00</b>

● = Standard equipment. ○ = Optional at extra cost.



# GTC FEATURES/OPTIONS

## WHEELS AND TYRES

	<i>Sport</i>	<i>Limited Edition</i>	<i>SRi</i>	<i>BiTurbo</i>	Price (£) exc. VAT	Total (£) inc. VAT
 <p><b>20-inch bi-colour alloy wheels:</b> 245/40 R 20 tyres</p>		●		○	833.33	<b>1000.00</b>

● = Standard equipment. ○ = Optional at extra cost.

## TYRE RATING

Tyre size	Fuel efficiency group	Wet grip performance	External noise	
			Measured (dB)	Group
235/50 R 18	E	B	71	
235/45 R 19	E	B	68	
245/40 R 20	E	B	71	

Tyre rating according to EU Regulation 1222/2009

# GTC SPECIFICATIONS

## PETROL ENGINES

	<b>1.4i 120PS Turbo ECOTEC-4 with Start/Stop</b>	<b>1.4i 140PS Turbo ECOTEC-4 with Start/Stop*</b>	<b>1.6i 200PS ECOTEC-4 Direct Injection Turbo with Start/Stop</b>
Capacity	1364cc	1364cc	1598cc
Maximum power	120PS (88kW) @ 4200-6000rpm	140PS (103kW) @ 4900-6000rpm	200PS (147kW) @ 5500rpm
Maximum torque	200Nm (147 lb.ft.) @ 1850-4200rpm	200Nm (147 lb.ft.) @ 1850-4900rpm	280Nm (206 lb.ft.)** @ 1650-3500rpm
Configuration	4 cylinders, 4 valves per cylinder, double overhead camshafts	4 cylinders, 4 valves per cylinder, double overhead camshafts	4 cylinders, 4 valves per cylinder, double overhead camshafts
Fuel/induction system	Water-cooled turbocharger with intercooler. Variable Valve Timing (VVT). Multi-point sequential fuel injection	Water-cooled turbocharger with intercooler. Variable Valve Timing (VVT). Multi-point sequential fuel injection	Water-cooled turbocharger with intercooler. Variable Valve Timing (VVT). Central direct fuel injection
Emission compliance	Euro 6	Euro 6	Euro 6
Service interval	20,000 miles or 1 year (whichever occurs sooner)	20,000 miles or 1 year (whichever occurs sooner)	20,000 miles or 1 year (whichever occurs sooner)

\* = Start/Stop function is not available on automatic models. \*\* = Increased to 300Nm (221 lb.ft.) with overboost.

## DIESEL ENGINES

	<b>1.6CDTi 110PS ECOTEC-4 Turbo diesel with Start/Stop</b>	<b>1.6CDTi 136PS ECOTEC-4 Turbo diesel with Start/Stop</b>	<b>2.0CDTi 165PS ECOTEC-4 Turbo diesel with Start/Stop*</b>
Capacity	1598cc	1598cc	1956cc
Maximum power	110PS (81kW) @ 4000rpm	136PS (100kW) @ 3500-4000rpm	165PS (121kW) @ 4000rpm
Maximum torque	300Nm (221 lb.ft.) @ 2000rpm	320Nm (236 lb.ft.) @ 2000rpm	350Nm (258 lb.ft.) @ 1750-2500rpm
Configuration	4 cylinders, 4 valves per cylinder, double overhead camshafts	4 cylinders, 4 valves per cylinder, double overhead camshafts	4 cylinders, 4 valves per cylinder, double overhead camshafts
Fuel/induction system	Variable geometry turbocharger with intercooler. Common rail fuel injection	Variable geometry turbocharger with intercooler. Common rail fuel injection	Variable geometry turbocharger with intercooler. Common rail fuel injection
Emission compliance	Euro 6 with Diesel Particulate Filter	Euro 6 with Diesel Particulate Filter	Euro 5 with Diesel Particulate Filter
Service interval	20,000 miles or 1 year (whichever occurs sooner)	20,000 miles or 1 year (whichever occurs sooner)	20,000 miles or 1 year (whichever occurs sooner)

	<b>2.0CDTi 195PS BiTurbo ECOTEC-4 Start/Stop</b>
Capacity	1956cc
Maximum power	195PS (143kW) @ 4000rpm
Maximum torque	400Nm (295 lb.ft.) @ 1750-2500rpm
Configuration	4 cylinders, 4 valves per cylinder, double overhead camshafts
Fuel/induction system	2 turbochargers with intercooler. Common rail fuel injection
Emission compliance	Euro 5 with Diesel Particulate Filter
Service interval	20,000 miles or 1 year (whichever occurs sooner)

\* = Start/Stop function is not available on automatic models.

# GTC SPECIFICATIONS

## PERFORMANCE, FUEL ECONOMY AND EMISSIONS

	Wheel size (inches)	Performance (manufacturer's figures)		Fuel economy mpg (litres/100km)#			CO <sub>2</sub> emissions g/km#	Vehicle Excise Duty*		Benefit in kind company car taxation rates – 2015/16 tax year
		Maximum speed (mph)	Acceleration 0-60mph (sec)	Urban driving	Extra-urban driving	Combined figure		First year rate	Standard rate	
<b>Manual</b>										
1.4i 120PS Turbo Start/Stop	18/19/20	119	10.1	37.2 (7.6)	54.3 (5.2)	47.1 (6.0)	142	£145	£145	23%
1.4i 140PS Turbo Start/Stop	18/19/20	125	8.9	37.2 (7.6)	54.3 (5.2)	47.1 (6.0)	142	£145	£145	23%
1.6i 200PS Direct Injection Turbo Start/Stop	18/19/20	143	7.3	34.4 (8.2)	53.3 (5.3)	44.8 (6.3)	149	£145	£145	24%
1.6CDTi 110PS Start/Stop ecoFLEX	18/19/20	113	11.6	60.1 (4.7)	72.4 (3.9)	67.3 (4.2)	111	£0	£30	20%
1.6CDTi 136PS Start/Stop ecoFLEX	18/19/20	123	9.5	56.5 (5.0)	70.6 (4.0)	65.7 (4.3)	115	£0	£30	21%
2.0CDTi 165PS Start/Stop	18/19	131	8.4	50.4 (5.6)	67.3 (4.2)	60.1 (4.7)	124	£0	£110	22%
2.0CDTi 165PS Start/Stop	20	131	8.4	50.4 (5.6)	67.3 (4.2)	60.1 (4.7)	125	£0	£110	23%
2.0CDTi 195PS BiTurbo Start/Stop	18/19/20	140	7.7	47.0 (6.0)	66.7 (4.2)	57.7 (4.9)	129	£0	£110	23%
<b>Automatic</b>										
1.4i 140PS Turbo	18/19/20	124	9.9	33.2 (8.5)	52.3 (5.4)	42.8 (6.6)	154	£180	£180	25%
2.0CDTi 165PS	18/19	129	8.6	36.2 (7.8)	62.8 (4.5)	49.6 (5.7)	149	£145	£145	27%
2.0CDTi 165PS	20	129	8.6	36.2 (7.8)	62.8 (4.5)	49.6 (5.7)	150	£145	£145	28%

\* = Correct at time of publication.

# = Official Government Test Environmental Data. Official EU-regulated test data is provided for comparison purposes and actual performance will depend on driving style, road conditions and other non-technical factors.

# GTC SPECIFICATIONS

## TRANSMISSION

### Six-speed automatic transmission with ActiveSelect® function

A six-speed automatic transmission is optional on 1.4i 140PS Turbo and 2.0CDTi 165PS models. On the road, a wide selection of shift patterns is adapted to the style and habits of the driver, anticipating when maximum acceleration or maximum efficiency is required. The electronic control will also adapt to the prevailing road conditions, reducing gear shifting when climbing or descending and using engine braking assistance during down changes.

The ActiveSelect® manual mode allows the gear lever to be used like a sequential manual gearbox – you simply push the lever forward or back to change up or down the gears. The driver also benefits from a 'neutral' gear disengagement at idle, which reduces vibration and contributes to improved fuel consumption.

## STEERING

- Power-assisted steering
- Turning circle (kerb-to-kerb):  
– 10.9m (35.7ft.)

## SUSPENSION

The HiPerStrut (High Performance Strut) front suspension improves grip and allows more power to be applied during cornering. The reduced kingpin angle means less camber loss, which allows the front tyres to retain more of their contact patch with the road during cornering, therefore delaying the onset of understeer. The shorter spindle length significantly reduces torque steer reactions and improves resistance to steering kickback through uneven bends.

**Front:** Independent. HiPerStrut sports suspension with gas-pressure dampers and coil springs. Anti-roll bar.

**Rear:** Lightweight compound crank rear axle with one-piece, hollow cast trailing arms. Built-in anti-roll bar. Progressive-rate double conical mini-block springs with Watt's link and gas-pressure dampers.

## BRAKES

- Anti-lock Braking System (ABS)
- Electronic brakeforce distribution
- Hydraulic brake fade assist
- Cornering brake control
- Emergency brake assist
- Electric parking brake (standard on BiTurbo models)
- Hill start assist (standard on BiTurbo models)

## FUEL TANK CAPACITY

All models: 56 litres (12.3 gallons)

## WEIGHTS AND TOWING DATA <sup>kg</sup>

	Gross vehicle weight	Max. towing weights Trailer with brakes (without brakes)
1.4i 120PS Turbo Start/Stop	1960	1350 (700)
1.4i 140PS Turbo Start/Stop	1960	1350 (700)
1.4i 140PS Turbo (automatic)	1980	1350 (700)
1.6i 200PS Direct Injection Turbo Start Stop	1990	1500 (730)
1.6CDTi 110PS Start/Stop ecoFLEX	tba	tba
1.6CDTi 136PS Start/Stop ecoFLEX	tba	tba
2.0CDTi 165PS Start/Stop	2040	1500 (750)
2.0CDTi 165PS (automatic)	2060	1450 (750)
2.0CDTi 195PS BiTurbo Start/Stop	2040	1500 (750)

Gross vehicle weight is the total permissible weight of the vehicle including passengers and their luggage. The maximum roof rack loading should not exceed 100kg. The maximum towing weights are based on the ability of the car, with two occupants of 75kg each, to restart on a 12% gradient, which is approximately 1 in 8.3, at sea level. At altitudes above 1500 metres, the engine output may drop with a corresponding reduction in towing capability. Any extra weight, such as luggage or additional passengers, should be deducted from the maximum towing weight. With a trailer fully loaded, maximum noseweight should not exceed 75kg. Always fit Vauxhall towing attachments and accessories available from your Vauxhall retailer. They are designed specifically for Vauxhall models and carry a 12-month guarantee.

# GTC SPECIFICATIONS

## EXTERIOR DIMENSIONS millimetres (inches)

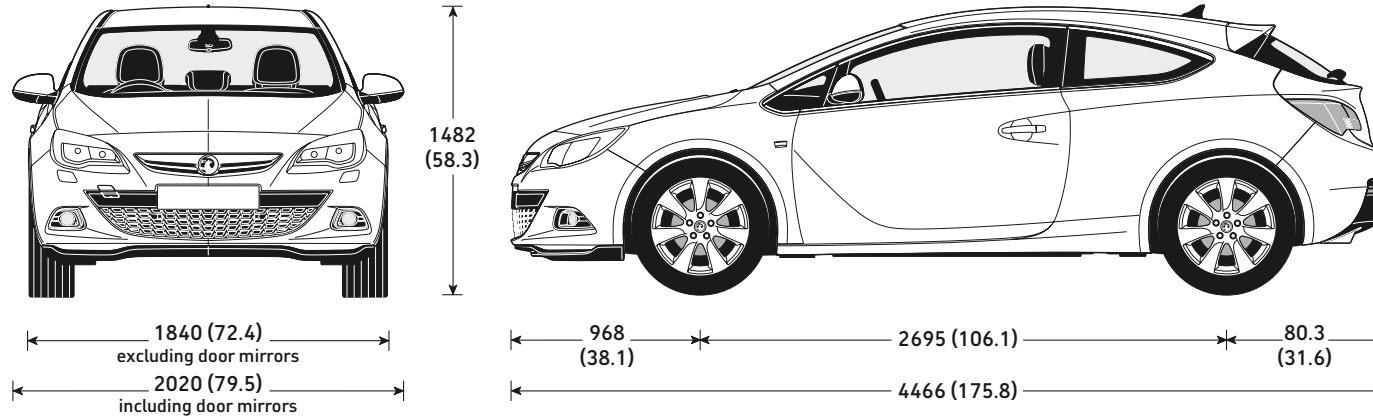

## LUGGAGE CAPACITIES\*

	litres (cu.ft.)
Rear seats up	380 (13.4)
Rear seats down	1165 (41.1)

Please note fitment of Infinity® Sound System reduces load volume by 38 litres.

\* = Measured using the ECIE method.



# GTC ACCESSORIES

	Total (inc. VAT)
<b>INFOTAINMENT</b>	
<b>iPod connection kit</b>	
Connects2 i-Connect FM – FM modular	£129.00
<b>Bury Bluetooth® phone kits</b>	
Classic – Fully integrated, phone charging function, illuminated controls	£129.00
CC9060 – Fully integrated, detachable colour screen, voice recognition	£149.00
<b>Garmin Portable Sat Navs (includes case)</b>	
Nüvi 42 (UK/Ireland) – 4.3-inch screen	£79.00
Nüvi 55 (UK/Ireland) – 5-inch screen, Bluetooth, eco route, lifetime traffic alerts	£89.00
Nüvi 55 (Western Europe) – 5-inch screen, Bluetooth, eco route	£99.00
<b>Digital radio</b>	
Fully integrated digital radio	£195.00
<b>Multimedia</b>	
Parrot Asteroid Mini	£399.00
Parrot Asteroid Tablet	£499.00
<b>TomTom semi-integrated sat nav</b>	
TomTom Start 25	£249.00
TomTom Via Business	£279.00
TomTom GO Business	£349.00
TomTom GO 5000	£379.00
<b>Sat Nav updates<sup>1</sup></b>	
Please consult your retailer for latest map updates or visit <a href="http://www.vauxhall.co.uk/accessories">www.vauxhall.co.uk/accessories</a> .	

1 = For use with optional factory-fit satellite navigation systems.

	Total (inc. VAT)
<b>CHILD SEATS<sup>2</sup></b>	
BABY-SAFE <sup>3</sup> – 0-13kg/birth to 15 months	£119.00
– ISOFIX base	£208.00
DUO ISOFIX <sup>3</sup> – 9-18kg/9 months to 4 years	
with top tether kit	£317.00
KID <sup>3</sup> – 15-36kg or 4 to 12 years	£144.00
2 = Restrictions apply to the use of child seats, please consult your Vauxhall retailer.	
3 = Without transponder.	
<b>SAFETY</b>	
Privacy shades – rear and rear side windows	£102.00
<b>Parking sensors</b>	
– four fully flush front bumper mounted sensors	
– unpainted	£320.00
– painted	£350.00
– four fully flush rear bumper mounted sensors	
– unpainted	£300.00
– painted	£330.00
<b>Safety Pack – first aid kit, warning triangle, hi-visibility vest, Vauxhall bag</b>	
First aid kit	£13.00
Warning triangle	£16.00
Fire extinguisher – 2kg	£34.00
Hi-visibility vest	£8.00
Temporary tyre inflation kit	£101.00
Tyre sealant	£48.00
<b>PRACTICAL</b>	
Spare bulb kit <sup>4</sup>	£17.00
Premium spare bulb kit <sup>4</sup>	£23.00
<b>Jump leads</b>	
– petrol engines (16mm standard)	£42.00
– petrol/diesel engines (25mm heavy duty)	£75.00
Stretch tow rope – 2 tonne	£31.00
Smoker pack	£39.00

4 = Excludes xenon headlight bulb for models with Adaptive Forward Lighting (AFL).

	Total (inc. VAT)
<b>PROTECTION</b>	
Economy floor mats – set of four	£28.00
Rubber floor mats – set of four	£58.00
Velour floor mats – set of four	£52.00
Cargo net – horizontal	£39.00
Storage net – front passenger seat	£43.00
<b>TOURING</b>	
T-track base carrier – two roof bars	£133.00
Thule bike carrier <sup>5</sup>	from £70.00
Thule ski carrier <sup>5</sup>	from £105.00
Thule surfboard carrier <sup>5</sup>	from £79.00
Thule Ocean 80 hard roof box (340 litres) <sup>5</sup>	£215.00
Thule Pacific 200 hard roof box (460 litres) <sup>5</sup>	from £320.00
Thule Ranger 90 soft roof box (340 litres) <sup>5</sup>	£260.00
More available, please consult your retailer for details.	
<b>Tow bar carrier system</b>	
Thule tow bar Euroride 940	
two-bicycle carrier	£226.00
Thule tow bar Euroway	
two-bicycle carrier	£345.00
Thule tow bar Euroway	
three-bicycle carrier	£430.00
Thule tow bar extension for fourth bicycle	£109.00
Detachable tow bar <sup>6</sup>	from £720.00

5 = Must be used in conjunction with a base carrier.

6 = Available with 12N, 12N/12S or 13-pin electrics. Please consult your retailer for details.

	Total (inc. VAT)
<b>VXR STYLING</b>	
Door sill plates	£70.00

**Please note:**

Prices shown are a fully fitted and painted, where applicable and include VAT. Please check with your local Vauxhall retailer for details. It is advisable to ensure your insurance policy is adequate to cover additional fitted accessories. Prices correct at time of publication.

# GTC ADDITIONAL INFORMATION

## ON-THE-ROAD PRICES

To eliminate uncertainty about hidden costs when buying a new car, Vauxhall publishes on-the-road recommended retail prices (RRP) and these are shown in the pricing tables within this price guide. These prices include the recommended cost of number plates and delivery to a Vauxhall retailer of £700.00 (including £116.67 VAT), 12 months' Government Vehicle Excise Duty (see opposite for details) and the DVLA new vehicle first registration fee of £55.00\*.

Please note: The on-the-road recommended retail price (RRP) does not include fuel supplied by the retailer, motor insurance or any other goods or services supplied by agreement between the retailer and the customer.

## PRICE PROTECTION

Order a new Vauxhall for build in the current model year (as confirmed by your retailer) for delivery no more than three months in advance and the price you are quoted is the price you pay. This is irrespective of any subsequent price rises between placing your order and delivery of your new car, but you must take delivery as soon as the car is available. General Motors UK Limited is not liable for price adjustments caused by Government changes in the rate of VAT (currently 20%), Vehicle Excise Duty, DVLA new vehicle first registration fee or by any other applicable legislation or regulations.

## VEHICLE EXCISE DUTY

The amount of Vehicle Excise Duty (road fund licence) payable on new cars varies depending on the level of carbon dioxide (CO<sub>2</sub>) emissions produced by the vehicle. CO<sub>2</sub> emissions are measured in grammes (g) per kilometre (km) travelled and divided into 13 charging bands shown in the table below.

From 1 April 2010 the Government introduced a new 'first year rate' of Vehicle Excise Duty payable on all new cars. In subsequent years the amount of Vehicle Excise Duty payable will revert to the standard rate.

### Vehicle Excise Duty\*

	CO <sub>2</sub> emissions (g/km)	First year rate	Standard rate
<b>Band A</b>	up to 100	£0.00	£0.00
<b>Band B</b>	101-110	£0.00	£20.00
<b>Band C</b>	111-120	£0.00	£30.00
<b>Band D</b>	121-130	£0.00	£110.00
<b>Band E</b>	131-140	£130.00	£130.00
<b>Band F</b>	141-150	£145.00	£145.00
<b>Band G</b>	151-165	£180.00	£180.00
<b>Band H</b>	166-175	£295.00	£205.00
<b>Band I</b>	176-185	£350.00	£225.00
<b>Band J</b>	186-200	£490.00	£265.00
<b>Band K</b>	201-225	£640.00	£290.00
<b>Band L</b>	226-255	£870.00	£490.00
<b>Band M</b>	over 255	£1100.00	£505.00

\* = Correct at time of issue.

## E10 FUEL

E10 fuel is cleared for use in all petrol-engined Vauxhall vehicles excluding models with the 2.2 litre direct injection petrol engine (code Z22YH) used in Vectra, Signum and Zafira models. Owners of these vehicles should continue to use regular unleaded or premium unleaded petrol.

## PROTECTING THE ENVIRONMENT

Vauxhall's commitment to the environment is demonstrated by our products' many environmental awards. For even more information on Vauxhall's efforts to achieve an environmentally sustainable future, see [www.vauxhall.co.uk/recycling](http://www.vauxhall.co.uk/recycling)

## VAUXHALL ASSISTANCE

Vauxhall Assistance is provided automatically with every new Vauxhall for 12 months from first registration and covers everything from accident assistance, roadside recovery and 'at home' service to flat tyres. With Vauxhall Assistance help is literally just a free\*\* phone call away, 24 hours a day, 365 days a year!

\*\* = Mobile phone users will be charged at their standard tariff.

## VAUXHALL LEASING

As Vauxhall's own contract hire and fleet management operation, Vauxhall Leasing provides a one-stop-shop for competitive car and van leasing solutions – for business users and private individuals. Working with the Vauxhall retailer network, we combine the support of a national contract with the convenience of a local contact.

For further information, please see your local Vauxhall retailer or call us on **0870 737 2557**. Alternatively, you can visit our website at [www.vauxhall-leasing.co.uk](http://www.vauxhall-leasing.co.uk)

## IN THE EVENT OF AN ACCIDENT...

Vauxhall Accident Support helps keep you mobile following an accident. Benefits include scene-of-accident advice, message service, assistance with claims and vehicle recovery. For further details call **0800 010 304**.

Alternatively, details can be found on our website at [www.vauxhall.co.uk](http://www.vauxhall.co.uk)

## VAUXHALL SERVICE PLAN

Vauxhall retailers offer a great service for owners of all Vauxhall cars. Value for money, regular offers and free check-ups, combined with the peace of mind that comes from using Vauxhall-trained technicians and genuine parts, help keep your car in peak condition at all times.

## FOR MORE PRODUCT INFORMATION

For a brochure on any Vauxhall model (up to a maximum of three per caller) or location of your nearest Vauxhall retailer please call **0345 600 1500**. Alternatively, details can be found on our website at [www.vauxhall.co.uk](http://www.vauxhall.co.uk)

## VAUXHALL INSURANCE WITH ADDED REASSURANCE

### Comprehensive cover – Summary of benefits\*

- Competitive premiums
- Repairs by a Vauxhall-trained technician
- Genuine Vauxhall parts, guaranteed for three years when we repair your car within our Approved Repairer Network
- Free courtesy car as standard when using an Approved Repairer\*\*
- 24 hour claims helpline
- Personal Accident benefit
- Cover for audio equipment
- Windscreen cover

Call for a quote on **0844 463 2670†**

\*The benefits listed above are for comprehensive cover only. For details of Third Party, Fire and Theft cover, please call our sales team.  
\*\*Should your car need repairing following an accident we provide a courtesy car (subject to availability) for the duration of the repair. Only genuine Vauxhall parts are used. Terms and conditions apply.  
†Calls may be recorded. Vauxhall Motor Insurance is underwritten by Ageas Insurance Limited.

Every effort has been made to ensure that the contents of this document were accurate and up-to-date at the time of publication – 2 July 2015. The invoice price, including delivery to retailer, factory-fitted options, accessories fitted by the retailer and number plates, is subject to VAT. The right is reserved to alter specifications and prices, and withdraw products from sale, without notice. Please note that Vauxhall retailers are not the agents of General Motors UK Limited t/a Vauxhall and are not authorised to bind General Motors UK Limited by any specific or implied undertaking or representation. It is advisable to ensure that your motor insurance policy provides adequate cover for additional fitted options and accessories. All rights reserved. No part of this publication may be reproduced in any form or by any means, without the prior written permission of General Motors UK Limited.

Base information prepared by Graymatter. General Motors UK Limited, Luton LU1 3YT [www.vauxhall.co.uk](http://www.vauxhall.co.uk)

©2015 General Motors UK Limited



**VAUXHALL**