

MY 2022



LCV Range

Price Guide



Combo

Including Combo-e Range

Contents

To find the information you want use the links below to navigate around the guide:

[Choose Your Trim Level](#)

[Range Highlights](#)

[Models](#)

[Prices and Weights](#)

[Fuel Economy and Emissions](#)

[Features/Options](#)

[Infotainment](#)

[Interior Style and Comfort](#)

[Exterior Colours](#)

[Wheels and Tyres](#)

[Engines and Technical Data](#)

[Specifications](#)

[Dimensions and Capacities](#)

[Accessories](#)

[Glossary of Terms](#)

[Further Information](#)

Choose Your Trim Level

Combo-e Dynamic

VX_COMV_e_31985



First up is the Combo-e Dynamic, loaded with features and future-proofed technology to match.

Combo-e Sportive

VX_COMV_e_33062



The Combo-e Sportive is a fully-electric van with an edge, offering low running costs and even more practicality.

Dynamic

VX_COMV_31997



Boasting superb value for money the Dynamic diesel model is an entry-level to new van ownership.

Sportive

VX_COMV_33061



The Combo Sportive diesel offers an edge with low running costs, good looks and even more practicality.

Elite

VX_COMV_33060



Our range-topping and extra impressive safety-orientated Combo Elite completes the range.

New Combo-e Range Highlights

Dynamic

Standard features include:

- Radio
 - 5-inch mono display
 - AM/FM/DAB digital radio
 - Bluetooth®
 - USB connection
- Four speakers
- Vauxhall Connect
- Air conditioning
- 16-inch steel wheels with centre caps
- Cruise control with speed limiter
- Steering column adjustable for reach and rake
- Electrically adjustable/heated door mirrors
- Electrically operated front windows
- Nearside sliding side-access door (L1 models only)
- Nearside and offside sliding side-access doors (L2 models only)
- Twin solid rear doors
- Rear parking distance sensors
- Remote control security alarm system
- Emergency tyre inflation kit
- Side-protection mouldings
- Driver's airbag
- Electronic stability programme with traction control
- Anti-lock braking system
- Hill start assist
- Full-height steel bulkhead
- Daytime running lights

- Automatic lighting control
- Remote control central deadlocking
- Steering wheel mounted audio controls
- Engine deadlock immobiliser
- Electronically protected audio equipment
- Full-width overhead storage shelf
- Height-adjustable driver's seat with manual lumbar adjustment
- Four-way adjustable passenger's seat with underseat storage
- Driver's top-lidded glovebox

Crew Van Dynamic

Additionally feature:

- Two-position moveable ladder frame bulkhead
- Three-seat second-row bench
- Rear lap and diagonal inertia-reel seatbelts
- Nearside and offside sliding side-access doors
- Front passenger's airbag
- Driver and front passenger's side-impact airbags

Sportive

Features over Dynamic models:

- Multimedia audio system
 - 8-inch colour touchscreen
- FlexCargo Pack
 - Dual front passengers' fixed bench seat
 - Fold-flat centre seat backrest with table
 - Two-way foldable outer seat
 - Load-through bulkhead
- Electronic parking brake
- Body-colour front and rear bumpers
- Metallic paint
- 16-inch steel wheels with full-diameter wheel trims
- Front fog lights

Combo Range Highlights

Dynamic

Standard features include:

- Radio
 - 5-inch mono display
 - AM/FM/DAB digital radio
 - Bluetooth®
 - USB connection
- Four speakers
- Vauxhall Connect
- Air conditioning
- 15-inch steel wheels with centre caps (2000 models)
- 16-inch steel wheels with centre caps (2300 models)
- Cruise control with speed limiter
- Steering column adjustable for reach and rake
- Electrically adjustable/heated door mirrors
- Electrically operated front windows
- Nearside sliding side-access door (L1 models only)
- Nearside and offside sliding side-access doors (L2 models only)
- Twin solid rear doors
- Rear parking distance sensors
- Remote control security alarm system
- Emergency tyre inflation kit
- Side-protection mouldings
- Driver's airbag
- Electronic stability programme with traction control
- Anti-lock braking system
- Hill start assist
- Full-height steel bulkhead
- Daytime running lights

- Automatic lighting control
- Remote control central deadlocking
- Steering wheel mounted audio controls
- Engine deadlock immobiliser
- Electronically protected audio equipment
- Full-width overhead storage shelf
- Height-adjustable driver's seat with manual lumbar adjustment
- Four-way adjustable passenger's seat with underseat storage
- Driver's top-lidded glovebox

Dynamic 4x4*

Additionally feature:

- Selectable 4x4 drive system with viscous-coupling
- ECO front-wheel drive mode
- Increased ground clearance 185mm
- Underbody protection for engine, gearbox and fuel tank

Crew Van Dynamic

Additionally feature:

- Two-position moveable ladder frame bulkhead
- Three-seat second-row bench
- Rear lap and diagonal inertia-reel seatbelts
- Nearside and offside sliding side-access doors
- Front passenger's airbag
- Driver and front passenger's side-impact airbags

Sportive

Features over Dynamic models:

- Multimedia audio system
 - 8-inch colour touchscreen
- FlexCargo Pack
 - Dual front passengers' fixed bench seat
 - Fold-flat centre seat backrest with table
 - Two-way foldable outer seat
 - Load-through bulkhead
- Electronic parking brake
- Body-colour front and rear bumpers
- Metallic paint
- 16-inch steel wheels with full-diameter wheel trims
- Front fog lights

Elite

Features over Sportive models:

- Multimedia Navi Pro system
 - Satellite navigation
 - Voice control
- Sight and Light Pack
- Surround rear vision
- 16-inch alloy wheels
- Front and rear parking distance sensors
- Body-colour sliding side-access door rail cover
- Full-height steel bulkhead
- Four-way adjustable passenger's seat with underseat storage
- Traffic sign recognition
- Lane departure warning with lane keep assist
- Driver drowsiness system
- Forward collision alert
- Automatic emergency braking with pedestrian detection
- Leather-covered steering wheel
- Front passenger's airbag
- Driver and front passenger's side-impact airbags
- LED daytime running lights

New Combo-e Dynamic



VX_COMV_e_31988

Dynamic OTR £25,273.33*

Infotainment:

- Radio
 - 5-inch mono display
 - AM/FM/DAB digital radio
 - Bluetooth®
 - USB connection
- Four speakers
- Vauxhall Connect

Interior convenience/styling:

- Steering column adjustable for reach and rake
- Full-width overhead storage shelf
- Air conditioning
- Driver's top-lidded glovebox
- Cruise control with speed limiter
- Steering wheel mounted audio controls
- Six-way adjustable driver's seat with manual lumbar adjustment and armrest
- Four-way adjustable front passenger's seat with underseat storage

Exterior convenience/styling:

- Electrically adjustable/heated door mirrors
- Electrically operated front windows with one-touch facility
- Nearside sliding side-access door
- Twin solid rear doors
- Rear parking distance sensors
- Emergency tyre inflation kit
- Side-protection mouldings
- 16-inch steel wheels with centre caps

Safety/security:

- Driver's airbag
- Height-adjustable front seatbelts
- Electronic stability programme with traction control
- Anti-lock braking system
- Full-height steel bulkhead
- Hill start assist
- Daytime running lights
- Remote control central deadlocking
- Engine deadlock immobiliser
- Electronically protected audio equipment
- Remote control security alarm system

Crew Van OTR £28,123.33*

Additionally feature:

- Three-seat second-row bench
- Vinyl load floor covering
- Nearside and offside sliding side-access doors
- Rear lap and diagonal seatbelts
- Two-position moveable ladder frame bulkhead
- Front passenger's airbag
- Driver and front passenger's side-impact airbags

*Price shown is after allowing for PiVG (Plug-in Van Grant) and excludes VAT.

New Combo-e Sportive



VX_COMV_e_33063

Sportive

OTR £26,413.33*

Infotainment:

- Multimedia system
 - 8-inch colour touchscreen
 - AM/FM/DAB digital radio
 - Bluetooth®
 - USB connection
- Four speakers
- Vauxhall Connect

Interior convenience/styling:

- Air conditioning
- Driver's top-lidded glovebox
- Six-way adjustable driver's seat with manual lumbar adjustment and armrest
- Full-width overhead storage shelf
- Cruise control with speed limiter
- Steering wheel mounted audio controls
- Steering column adjustable for reach and rake
- FlexCargo Pack
 - Dual front passengers' fixed bench seat
 - Fold-flat centre seat backrest with table
 - Two-way foldable outer seat
 - Load-through bulkhead
 - Electronic parking brake

Exterior convenience/styling:

- Electrically adjustable/heated door mirrors
- Electrically operated front windows with one-touch facility
- Front fog lights
- Nearside sliding side-access door
- Rear parking distance sensors
- Body-colour front and rear bumpers
- Twin solid rear doors
- Metallic paint
- 16-inch steel wheels with full-diameter wheel trims
- Emergency tyre inflation kit

Safety/security:

- Driver's airbag
- Height-adjustable front seatbelts
- Electronic stability programme with traction control
- Anti-lock braking system
- Hill start assist
- Daytime running lights
- Remote control central deadlocking
- Remote control security alarm system
- Engine deadlock immobiliser
- Electronically protected audio equipment

*Price shown is after allowing for PiVG (Plug-in Van Grant) and excludes VAT.

Combo Dynamic



VX_COMV_31992

Dynamic OTR £19,058.33*

Infotainment:

- Radio
 - 5-inch mono display
 - AM/FM/DAB digital radio
 - Bluetooth®
 - USB connection
- Four speakers
- Vauxhall Connect

Interior convenience/styling:

- Steering column adjustable for reach and rake
- Full-width overhead storage shelf
- Air conditioning
- Driver's top-lidded glovebox
- Cruise control with speed limiter
- Steering wheel mounted audio controls
- Six-way adjustable driver's seat with manual lumbar adjustment and armrest
- Four-way adjustable front passenger's seat with underseat storage

Exterior convenience/styling:

- Electrically adjustable/heated door mirrors
- Electrically operated front windows with one-touch facility
- Nearside sliding side-access door
- Twin solid rear doors
- Rear parking distance sensors
- Emergency tyre inflation kit
- Side-protection mouldings
- 15-inch steel wheels with centre caps (2000 models)
- 16-inch steel wheels with centre caps (2300 models)

Safety/security:

- Driver's airbag
- Height-adjustable front seatbelts
- Electronic stability programme with traction control
- Anti-lock braking system
- Full-height steel bulkhead
- Hill start assist
- Daytime running lights
- Remote control central deadlocking
- Engine deadlock immobiliser
- Electronically protected audio equipment
- Remote control security alarm system

Automatic models additionally feature:

- Leather-covered steering wheel
- Safety Pack
- Sight and Light Pack
- Keyless entry and start
- Front passenger's airbag

Crew Van OTR £21,318.33*

Additionally feature:

- Three-seat second-row bench
- Vinyl load floor covering
- Nearside and offside sliding side-access doors
- Rear lap and diagonal seatbelts
- Two-position moveable ladder frame bulkhead
- Front passenger's airbag
- Driver and front passenger's side-impact airbags

*OTR price excluding VAT.

Combo Sportive



VX_COMV_33061

Sportive

OTR £20,013.33*

Infotainment:

- Multimedia system
 - 8-inch colour touchscreen
 - AM/FM/DAB digital radio
 - Bluetooth®
 - USB connection
- Four speakers
- Vauxhall Connect

Interior convenience/styling:

- Air conditioning
- Driver's top-lidded glovebox
- Six-way adjustable driver's seat with manual lumbar adjustment and armrest
- Full-width overhead storage shelf
- Cruise control with speed limiter
- Steering wheel mounted audio controls
- Steering column adjustable for reach and rake
- FlexCargo Pack
 - Dual front passengers' fixed bench seat
 - Fold-flat centre seat backrest with table
 - Two-way foldable outer seat
 - Load-through bulkhead
 - Electronic parking brake

Exterior convenience/styling:

- Electrically adjustable/heated door mirrors
- Electrically operated front windows with one-touch facility
- Front fog lights
- Nearside sliding side-access door
- Rear parking distance sensors
- Body-colour front and rear bumpers
- Twin solid rear doors
- Metallic paint
- 16-inch steel wheels with full-diameter wheel trims
- Emergency tyre inflation kit

Safety/security:

- Driver's airbag
- Height-adjustable front seatbelts
- Electronic stability programme with traction control
- Anti-lock braking system
- Hill start assist
- Daytime running lights
- Remote control central deadlocking
- Remote control security alarm system
- Engine deadlock immobiliser
- Electronically protected audio equipment

*OTR price excluding VAT.

Combo Elite



VX_COMV_33060

Elite

OTR £22,623.33*

Infotainment:

- Multimedia Navi Pro system
 - 8-inch colour touchscreen
 - Satellite navigation
 - Voice control
 - AM/FM/DAB digital radio
 - Bluetooth®
 - USB connection
- Four speakers
- Vauxhall Connect

Interior convenience/styling:

- 3.5-inch colour instrument cluster
- Automatic anti-dazzle rear-view mirror
- Rain-sensitive windscreen wipers
- Air conditioning
- Driver's top-lidded glovebox
- Six-way adjustable driver's seat with manual lumbar adjustment and armrest
- Four-way adjustable passenger's seat with underseat storage
- Full-width overhead storage shelf
- Cruise control with speed limiter
- Steering wheel mounted audio controls
- Steering column adjustable for reach and rake
- Surround rear vision
- Leather-covered steering wheel

Exterior convenience/styling:

- 16-inch alloy wheels
- High beam assist
- Electrically adjustable/heated door mirrors
- Electrically operated front windows with one-touch facility
- Nearside sliding side-access door
- Body-colour sliding side-access door rail cover
- Body-colour front and rear bumpers
- Front fog lights
- Twin solid rear doors
- Metallic paint
- Front and rear parking distance sensors
- Emergency tyre inflation kit

Safety/security:

- Driver drowsiness system
- Driver's airbag
- Height-adjustable front seatbelts
- Electronic stability programme with traction control
- Anti-lock braking system
- LED daytime running lights
- Hill start assist
- Remote control central deadlocking
- Remote control security alarm system
- Engine deadlock immobiliser
- Electronically protected audio equipment
- Full-height steel bulkhead
- Traffic sign recognition
- Lane departure warning with lane keep assist
- Forward collision alert
- Automatic emergency braking with pedestrian detection

*OTR price excluding VAT.

New Combo-e Panel Van Prices/Weights*

	Model/ Pack Code	Orderable Option Code	Minimum Mass (kg)**	Maximum indicative payload (kg)**	Gross Vehicle Weights (GVW) (kg)	Plated weights (kg)		Towing weights (kg) Braked	Plated Gross Combination Weights (GCW) (kg)	Price (£) exc. VAT	On-the-road RRP before PiVG (£) exc. VAT	On-the-road RRP after PiVG (£) exc. VAT
						Front axle	Rear axle					
L1 Dynamic Panel Van												
2300 100kW (136PS) auto – 50kWh battery	DA05 9EQ1	XIAA	1607	803	2410	1200	1400	750	3160	27,135.00	27,773.33	25,273.33
L1 Sportive Panel Van												
2300 100kW (136PS) auto – 50kWh battery	DC05 9EQ1	XIAA	1607	803	2410	1200	1400	750	3160	28,135.00	28,773.33	26,273.33
L2 Dynamic Panel Van												
2300 100kW (136PS) auto – 50kWh battery	DA05 9EQ1	XIAD	1649	751	2400	1200	1400	750	3150	28,275.00	28,913.33	26,413.33
L2 Sportive Panel Van												
2300 100kW (136PS) auto – 50kWh battery	DC05 9EQ1	XIAD	1649	751	2400	1200	1400	750	3150	29,275.00	29,913.33	27,413.33
L2 Dynamic Crew Van												
2300 100kW (136PS) auto – 50kWh battery	DHC5 9EQ1	XIAD	1729	721	2450	1200	1400	750	3200	29,985.00	30,623.33	28,123.33

Please note: On-the-road recommended retail prices (RRP) include number plates and delivery to Retailer of £583.33 exc. VAT (£700.00 inc. VAT) and new vehicle first registration fee of £55.00 (correct at time of publication). Excludes fuel and insurance. Price has been calculated using manufacturer estimates and includes an OZEV grant of up to £2,500.00 which has been deducted from the price of the vehicle (OZEV Grant not available in the Isle of Man). The grant is a government incentive and is subject to withdrawal prior to delivery of your vehicle. Retailers may be required to carry out more than one credit check during the course of the order process. You may be required to place a deposit when placing your order with your supplying Retailer. In the event of a price change, deposit refunds will be governed by your supplying Retailer's policy and as such must be discussed with the supplying Retailer.

Gross plated weights (including axle weights) quoted on the vehicle plate are to UK plated weight specification and must never be exceeded.

*Provisional data. **Minimum Mass for standard vehicles will vary according to the vehicle specification (including trim, options and accessories) with a corresponding variation in payload.

Combo-e is not covered by our Price Protection Guarantee. See 'Further Information' page for details.

New Combo-e Battery Range

	WLTP Combined Range (miles) [#] – pack code	WLTP City Range (miles) [#] – pack code
L1 Dynamic Panel Van		
2300 100kW (136PS) auto – 50kWh battery	tba	tba
L1 Sportive Panel Van		
2300 100kW (136PS) auto – 50kWh battery	175	270
L2 Dynamic Panel Van		
2300 100kW (136PS) auto – 50kWh battery	tba	tba
L2 Sportive Panel Van		
2300 100kW (136PS) auto – 50kWh battery	171	251
L2 Dynamic Crew Van		
2300 100kW (136PS) auto – 50kWh battery	150	237

WLTP figures are based on a configured vehicle as per pack code for UK with no options fitted as at 23 November 2021.

[#]The Combo-e is a battery electric vehicle requiring mains electricity for charging. Range data given has been determined according to WLTP test procedure methodology. The figures shown are intended for comparability purposes only and should only be compared to other cars tested to the same technical standard. The range you achieve under real world driving conditions will depend upon a number of factors, including but not limited to: the accessories fitted (pre and post registration); charging frequency; personal driving style; vehicle load and route characteristics; variations in weather; heating/air conditioning; pre-conditioning and battery condition. For more information, contact your local Vauxhall Retailer.

Combo Panel/Crew Van Prices/Weights Euro 6D (6.3) (Provisional data)

	Pack Code	Orderable Option Code	Minimum Mass (kg)*	Maximum indicative payload (kg)*	Gross Vehicle Weights (GVW) (kg)	Plated weights (kg)		Towing weights (kg) Braked	Plated Gross Combination Weights (GCW) (kg)	Price (£) exc. VAT	On-the-road RRP (£) exc. VAT	Insurance groups
						Front axle	Rear axle					
L1 Dynamic Panel Van Euro 6D (6.3)												
2000 1.5 (100PS) Turbo D	DF05 HY61	XIAA	1320	665	1985	1200	1075	1350	3335	18,145.00	19,058.33	29E
2300 1.5 (100PS) Turbo D	DF05 HY61	XIAB	1347	998	2345	1200	1400	1000	3345	18,455.00	19,368.33	tbc
2300 1.5 (130PS) Turbo D	DF05 HX61	XIAB	1368	1002	2370	1200	1400	1200	3500	19,035.00	19,948.33	33E
2300 1.5 (130PS) Turbo D Automatic	DF05 HF81	XIAB	1380	1000	2380	1200	1400	1000	3500	20,270.00	21,183.33	tbc
L1 Sportive Panel Van Euro 6D (6.3)												
2000 1.5 (100PS) Turbo D	DL05 HY61	XIAA	1320	665	1985	1200	1075	1350	3335	19,100.00	20,013.33	29E
2300 1.5 (100PS) Turbo D	DL05 HY61	XIAB	1347	998	2345	1200	1400	1000	3345	19,410.00	20,323.33	31E
2300 1.5 (130PS) Turbo D	DL05 HX61	XIAB	1347	998	2345	1200	1400	1000	3345	19,990.00	20,903.33	33E
L1 Elite Panel Van Euro 6D (6.3)												
2300 1.5 (100PS) Turbo D	DE05 HY61	XIAB	1347	998	2345	1200	1400	1000	3345	21,710.00	22,623.33	32E
L2 Dynamic Panel Van Euro 6D (6.3)												
2300 1.5 (100PS) Turbo D	DF05 HY61	XIAE	1402	953	2355	1200	1400	1000	3355	19,580.00	20,493.33	31E
2300 1.5 (130PS) Turbo D	DF05 HX61	XIAE	1402	953	2355	1200	1400	1000	3355	20,160.00	21,073.33	33E
2300 1.5 (130PS) Turbo D Automatic	DF05 HF81	XIAE	1430	950	2380	1200	1400	1000	3380	21,395.00	22,308.33	tbc
L2 Sportive Panel Van Euro 6D (6.3)												
2300 1.5 (100PS) Turbo D	DL05 HY61	XIAE	1402	953	2355	1200	1400	1000	3355	20,535.00	21,448.33	tbc
L2 Elite Panel Van Euro 6D (6.3)												
2300 1.5 (100PS) Turbo D	DE05 HY61	XIAE	1402	953	2355	1200	1400	1000	3355	22,840.00	23,753.33	tbc
L2 Dynamic Crew Van Euro 6D (6.3)												
2300 1.5 (100PS) Turbo D	DMC5 HY61	XIAE	1475	900	2375	1200	1400	1050	3425	20,405.00	21,318.33	tbc

Please note: On-the-road recommended retail prices (RRP) include number plates and delivery to Retailer of £583.33, 12 months' Vehicle Excise Duty and new vehicle first registration fee of £55.00. Excludes fuel and insurance.

VAT reclaimable status requires a minimum 1-tonne payload for Crew Vans in accordance with HMRC guidance. Crew Vans with a payload of less than 1-tonne may be eligible for VAT reclaimable status, subject to further HMRC assessment. Customers are advised to consult their local HMRC office or visit www.gov.uk/government/organisations/hm-revenue-customs for further details in relation to VAT reclaimable status. Payload calculations should take into consideration local UK Specification and Trim Level. Ordered options may also impact payload.

Gross plated weights (including axle weights) quoted on the vehicle plate are to UK plated weight specification and must never be exceeded. Unbraked towing weight 600kg – all models.

*Minimum Mass for standard vehicles include coolant, oil and 90% full fuel tank. They will vary according to the vehicle specification (including trim, options and accessories) with a corresponding variation in payload.

Combo 4x4 Prices/Weights Euro 6D (6.3) (Provisional data)

	Pack Code	Orderable Option Code	Minimum Mass (kg)*	Maximum indicative payload (kg)*	Gross Vehicle Weights (GVW) (kg)	Plated weights (kg)		Towing weights (kg) Braked	Plated Gross Combination Weights (GCW) (kg)	Price (£) exc. VAT	On-the-road RRP (£) exc. VAT
						Front axle	Rear axle				
L1 Dynamic Panel Van Euro 6D (6.3)**											
2300 1.5 (130PS) Turbo D 4x4	DF05 HX62	XIAB	1478	892	2370	1200	1400	1200	3500	34,280.00	35,193.33
L2 Dynamic Panel Van Euro 6D (6.3)**											
2300 1.5 (130PS) Turbo D 4x4	DF05 HX62	XIAE	1532	848	2380	1200	1400	1200	3500	35,405.00	36,318.33

Combo 4x4

Combo 4x4 is an approved 3rd party conversion that is included in this guide for ease of ordering:

- Converter warranty is 3 years/60k miles and is equivalent to base vehicle
- Oil servicing transfer box/rear axle 16k miles or 2 years

For Aftersales/Warranty information

Contact: assistance@dangel.com or +33 3 89 38 98 89

The Dangel 4x4 system

The Dangel 4x4 system features 4x4 on demand via an On/Off mode selector (default on start-up is FWD). It adapts to varying roads and weather conditions and can easily change into two modes.

ECO 2WD mode: In this mode the 4x4 driveline is disengaged by a jaw clutch in the front transfer case. The vehicle works in FWD and this improves fuel economy and reduces tyre wear when 4x4 is not necessary.

AUTO 4WD mode: In conditions of normal surface grip, the vehicle works in standard FWD. If the front axle loses traction, the viscous-coupling unit transfers a part of the available torque to the rear axle. This intervention is automatic, smooth and only when necessary. The vehicle returns to FWD as soon as the front axle retains sufficient traction.

Advantages...

- 4X4 with viscous-coupling and ECO 2WD position
- Standard ground clearance 180mm (+90 mm with further increase available with 4x4 Plus Pack)
- Underbody protection for engine, gearbox and fuel tank
- Dangel 4x4 system adds just 110kg

Please note: On-the-road recommended retail prices (RRP) include number plates and delivery to Retailer of £583.33, 12 months' Vehicle Excise Duty and new vehicle first registration fee of £55.00. Excludes fuel and insurance.

Gross plated weights (including axle weights) quoted on the vehicle plate are to UK plated weight specification and must never be exceeded. Unbraked towing weight 600kg – all models.

*Minimum Mass for standard vehicles include coolant, oil and 90% full fuel tank. They will vary according to the vehicle specification (including trim, options and accessories) with a corresponding variation in payload. **Please note Combo 4x4 models are not currently available to factory order.

Combo Fuel Economy/Emissions Euro 6D (6.3) (Provisional data)

	WLTP Combined CO ₂ /mpg# – pack code	WLTP Fuel economy mpg (litres/100km)#		CO ₂ (g/km)#	
		Combined Low	Combined High	High	Low
L1 Dynamic Panel Van					
2000 1.5 (100PS) Turbo D	54.3/137	47.1 (6.0)	52.3 (5.4)	158	140
2300 1.5 (100PS) Turbo D	tba	47.1 (6.0)	52.3 (5.4)	158	140
2300 1.5 (130PS) Turbo D	51.3/145	42.2 (6.7)	44.1 (6.4)	176	167
2300 1.5 (130PS) Turbo D Automatic	tba	45.6 (6.2)	48.7 (5.8)	162	151
L1 Dynamic Panel Van					
2300 1.5 (130PS) Turbo D 4x4	tba	42.2 (6.7)	44.1 (6.4)	176	167
L1 Sportive Panel Van					
2000 1.5 (100PS) Turbo D	52.3/140	47.1 (6.0)	52.3 (5.4)	158	140
2300 1.5 (100PS) Turbo D	51.2/144	47.1 (6.0)	52.3 (5.4)	158	140
2300 1.5 (130PS) Turbo D	50.4/146	42.2 (6.7)	44.1 (6.4)	176	167
L1 Elite Panel Van					
2300 1.5 (100PS) Turbo D	tba	47.1 (6.0)	52.3 (5.4)	158	140
L2 Dynamic Panel Van					
2300 1.5 (100PS) Turbo D	tba	47.1 (6.0)	52.3 (5.4)	158	140
2300 1.5 (130PS) Turbo D	49.5/149	42.2 (6.7)	44.1 (6.4)	176	167
2300 1.5 (130PS) Turbo D Automatic	tba	45.6 (6.2)	48.7 (5.8)	162	151
L2 Dynamic Panel Van					
2300 1.5 (130PS) Turbo D 4x4	tba	42.2 (6.7)	44.1 (6.4)	176	167
L2 Sportive Panel Van					
2300 1.5 (100PS) Turbo D	51.3/145	47.1 (6.0)	52.3 (5.4)	158	140
L2 Elite Panel Van Euro					
2300 1.5 (100PS) Turbo D	tba	47.1 (6.0)	52.3 (5.4)	158	140
L2 Dynamic Crew Van					
2300 1.5 (100PS) Turbo D	tba	47.1 (6.0)	52.3 (5.4)	158	140

WLTP figures are based on a configured vehicle as per pack code for UK with no options fitted as at 23 November 2021.

#Figures shown are for comparison purposes and should only be compared to the fuel consumption and CO₂ values of other vehicles tested to the same technical standard. The fuel consumption achieved, and CO₂ produced, in real world conditions will depend upon a number of factors including, but not limited to: the accessories fitted (pre and post registration); variations in weather; driving styles and vehicle load. The WLTP (Worldwide Harmonised Light Vehicles Test Procedure) is used to measure fuel consumption and CO₂ figures. The CO₂ figures display a range to reflect the highest value for the highest emitting version with all available options added, through to a minimum value to represent the lowest emitting version in standard specification.

Safety

Standard Features – The following features are standard across the entire Combo range.



Airbags

- Driver's airbag
- Front passenger's airbag (Automatic and Elite models only)
- Driver and front passenger's side-impact airbags (Elite models)

Braking

- Anti-lock braking system (ABS)
- Electronic stability programme
- Electronic brakeforce distribution – Automatically apportions the optimum braking force to each wheel
- Emergency brake assist
- Hill start assist – Briefly maintains rear brake pressure to stop the vehicle rolling back on an incline

Bulkhead

- Full-height steel bulkhead – Sportive models include load-through facility

Driver/passenger safety

- Energy-absorbing steering column
- Side-impact protection beams
- Reinforced passenger safety cell
- Deformation zones front and rear
- Height-adjustable front seatbelts

Stability

- Electronic Stability Programme (ESP) – ESP monitors many different inputs to determine when the car starts to lose traction, it can then immediately respond by varying the brake pressure between up to three wheels and adjust the engine output to help correct the loss of traction and improve stability

Additional ESP features

- Traction control
- Corner stability control
- Engine drag torque control – Improves directional stability by preventing the driven wheels from locking on slippery surfaces under the influence of engine braking

Additionally Crew Van models feature

- Rear lap and diagonal seatbelts
- Two-position moveable ladder frame bulkhead
- Front passenger's airbag
- Driver and front passenger's side-impact airbags

VX_COMV_28938

Full-height steel bulkhead.

Safety

Model Specific Features/Options

	Option code*	Electric model			Dynamic	Sportive	Elite	Dynamic Crew Van
		Dynamic	Sportive	Dynamic Crew Van				
Safety								
Front passenger's airbag	AK5	£120	£120		£120	£120		
Driver and front passenger airbags, and side-impact airbags	AJ7	£490	£490	●	£490	£490	●	●
Driver and front passenger airbags, side-impact airbags and curtain airbags	AKB	£490	£490		£490	£490		
Deactivation switch for front passenger's front and side-impact airbags (when specified)**		●	●	●	●	●		●
Tyre pressure monitoring system – Not available on 4x4 models	UJO	£185	£185	£185	£185	£185	£185	£185
Overload indicator – Not available on 4x4 models	J89	£260	£260		£260	£260		
Full-height steel bulkhead with window	AX9	£175			£175		£175	
Two-position moveable ladder frame bulkhead				●				●
Safety Pack – Standard on Automatic Diesel models. Leather-covered steering wheel/ Front camera system/Lane departure warning with lane keep assist/Speed sign recognition/Driver drowsiness system/Forward collision alert/Automatic emergency braking with pedestrian detection. Requires cruise control or adaptive cruise control. Not available on 4x4 models	B26/N35	£805	£805	£805	£805	£805	●	£805

*Optional at extra cost excluding VAT. **Only available when passenger's airbag options are specified.

Driver Assistance

Standard Features – The following features are standard across the entire Combo range.
 Specific features by model are outlined in the separate tabular information.

Parking sensors

- Rear parking distance sensors

Cruise control with speed limiter

With steering wheel mounted controls. Enables you to maintain a constant speed, making it ideal for economical motorway driving.

Driver drowsiness system

The system monitors driving time and driving behaviour to help prevent accidents caused by tiredness.
 (Dynamic auto only)

Wipers

- Two-speed windscreen wipers with variable intermittent wipe
- Rain-sensitive windscreen wipers (Dynamic auto only)
- Magic Wash System – Mounted in the front windscreen wipers, Combo models benefit from our innovative windscreen wash system, designed to more effectively distribute water and reduce wastage. Using nozzles located above the wiper blades, fluid is distributed as the wiper sweeps the windscreen. This avoids the ‘temporary blindness’ of more conventional bonnet mounted systems between fluid release and wiper sweeping, improving visibility

Speed sign recognition (Automatic Dynamic models only)

Detects and then displays speed limits, reducing uncertainty and the risk of speeding.

- Recognises different speed signs, including temporary speed restrictions
- Displays reminder in the instrument cluster
- Works in conjunction with the cruise control/speed limiter to help the driver adapt to the recognised speed limit

Model Specific Features/Options

	Option code*	Electric model			Dynamic	Sportive	Elite	Dynamic Crew Van
		Dynamic	Sportive	Dynamic Crew Van				
Driver Assistance								
Floor-mounted handbrake lever – Standard on Dynamic manual models only					●	●	●	●
Electronic parking brake – Dynamic automatic models only		●	●	●	●			
Adaptive Cruise Control – 1.5 (130PS) diesel manual models. Only available in conjunction with Safety Pack	K38		£250			£250		
Front and rear parking distance sensors	UD5	£400	£400		£400	£400	●	

*Optional at extra cost excluding VAT.

Driver Assistance

Model Specific Features/Options

	Option code*	Electric model			Dynamic	Sportive	Elite	Dynamic Crew Van
		Dynamic	Sportive	Dynamic Crew Van				
Driver Assistance								
Surround rear vision – Only available in conjunction with front fog lights and front/rear parking distance sensors Permanent display through digital rear-view mirror with three functions: • Side passenger view – Enables passenger side blind spot to be seen • Rear-view monitoring – Provides an image from the rear and effectively replaces rear-view mirror • Visual aid for reversing – Displays area to the rear of the vehicle when in reverse gear and indicates the width of the vehicle with the rear-view mirrors extended	UL3	£500	£500		£500	£500	●	
Rear-view camera – Only available with front fog lights and rear, or front/rear parking distance sensors. Not available on Crew Van	UVC	£250	£250		£250	£250		
Sight and Light Pack – High beam assist/Rain-sensitive windscreen wipers/ 3.5-inch colour information display/Driver drowsiness system/Automatic anti-dazzle rear-view mirror	CWX		£225			£225	●	
Construction Pack with IntelliGrip (PS4) – Underride protection/215/65 R16 tyres/ Increased chassis height (+30mm)/IntelliGrip – Not available on 4x4 models	HMG/PS4	£930		£930	£930			£930

*Optional at extra cost excluding VAT.

Driver Information and Security

Standard Features – The following features are standard across the entire Combo range.
 Specific features by model are outlined in the separate tabular information.

Driver Information

Instrumentation

- Speedometer and rev counter
- Fuel gauge with low fuel level warning light
- Water temperature gauge with warning light
- Shift-up indication light (manual models only) – Indicates when to change gear for optimum fuel economy

Driver information display

(centrally located in instrument cluster)

- 3.5-inch colour display (Standard on automatic Dynamic models only)
- Trip computer data
- Total mileage
- Service-due indicator

Multi-function trip computer (displayed on driver information display)

- Trip mileage
- Vehicle range based on remaining fuel
- Average speed
- Average fuel economy
- Instantaneous fuel economy

Central facia display (format dependent on infotainment unit)

- Audio information
- Digital clock with automatic RDS time adjustment
- Outside air temperature with ice warning function
- Additional features dependent on infotainment unit (see infotainment for details)

Security

- Electronically protected audio equipment
- Engine deadlock immobiliser
- Visible Vehicle Identification Number (VIN)
- Locking wheel bolts for alloy wheels

Remote control central locking

- Operates on doors and fuel filler/EV charging flap
- Deadlocking
- Central locking activation switch on driver's door
- Two folding keys

Model Specific Features

		Electric model						
	Option code	Dynamic	Sportive	Dynamic Crew Van	Dynamic	Sportive	Elite	Dynamic Crew Van
Security								
Keyless entry and start – Standard on automatic models only					●			
Remote control ultrasonic security alarm system		●	●	●	●	●	●	●

Convenience

Standard Features – The following features are standard across the entire Combo range.
 Specific features by model are outlined in the separate tabular information.

Interior Convenience

- 12v accessory socket
- Driver's and front passenger's sun visors.
 Vanity mirror on rear of driver's sunvisor
- Dipping rear-view mirror
- Reach and rake-adjustable steering
- USB connection
- Steering wheel mounted audio controls

Interior Storage

- Two facia-mounted drinks holders
- Two drinks holders in centre console
- Large open storage pocket behind infotainment screen
- Small open storage compartment behind gear lever
- Two large and two small open door pockets
- Open storage compartment below glovebox
- Full-width overhead storage shelf with ambient lighting

Heating and Ventilation

- Air conditioning • Cab heating with six-speed fan
- Illuminated controls • Four adjustable facia vents
- Windscreen demist vents • Side window demist vents

Exterior Convenience

Door mirrors

- Twin electrically adjustable/heated door mirrors

Windows

- Solar heat-absorbing windscreen
- Electrically operated windows with safety autoreverse and one-touch up/down facility
- Glazed tailgate with heated window and wash/wipe facility
- Tinted windows

Model Specific Features/Options

	Option code*	Electric model			Dynamic	Sportive	Elite	Dynamic Crew Van
		Dynamic	Sportive	Dynamic Crew Van				
Interior Convenience								
230-volt electrical accessory socket	KI5		£100			£100	£100	
Heating and Ventilation								
Dual zone electronic climate control – Only available when the Sight and Light Pack is specified	CJ2		£200			£200	£200	
Exterior Convenience								
Tow bar pre-installation kit – Not available on 4x4 models	JNK				£410	£410	£410	£410
Roof rails	E2R		£125			£125	£125	
11kW three-phase on-board charger with mode-3 7kW cable (added at POE)	K29	£300	£300	£300				

*Optional at extra cost excluding VAT.

Exterior Style and Lighting

Standard Features – The following features are standard across the entire Combo range.
 Specific features by model are outlined in the separate tabular information.

Exterior Styling

- Nearside sliding side-access door
- Twin solid rear doors
- Side-protection mouldings
- Black door mirrors

Exterior Lighting

- Daytime running lights
- Automatic lighting control
- Lights-on audible warning – When driver’s door is opened an audible warning sounds to alert the lights have been left on

- Manual headlight beam levelling. Use to adapt headlight range to the vehicle load to prevent dazzling
- Rear fog light
- Reversing light
- Hazard warning lights

Model Specific Features/Option

	Option code*	Electric model			Dynamic	Sportive	Elite	Dynamic Crew Van
		Dynamic	Sportive	Dynamic Crew Van				
Exterior Style								
Body-colour front and rear bumpers			●			●	●	
Body-colour sliding side-access door rail cover							●	
Exterior Lighting								
Front fog lights	T3U	£125	●		£125	●	●	
LED daytime running lights							●	

*Optional at extra cost excluding VAT.

Load Area

Standard Features – The following features are standard across the entire Combo range.
 Specific features by model are outlined in the separate tabular information.

Load access

Side access – Unglazed

- Nearside sliding side-access door – L1 models

Rear access – Unglazed

- Twin solid rear doors

Load restraint

Six fixed floor-mounted load restraint lashing eyes

Model Specific Features/Options

	Option code*	Electric model			Dynamic	Sportive	Elite	Dynamic Crew Van
		Dynamic	Sportive	Dynamic Crew Van				
Load Area								
Plywood load floor covering	CRJ	£180	£180		£180	£180	£180	
Vinyl load floor covering	CRK	£60	£60	●	£60	£60	£60	●
LED illuminated load area	8G8	£200	£200		£200	£200	£200	
Nearside and offside sliding side-access doors – Standard on L2	CVM	£220	£220	●	£220	£220	£220	●
Fixed window in nearside sliding side-access door. Fixed window in opposite panel – L1 models. Fixed window in offside sliding side-access door – L2 models	BSB	£320	£320		£320	£320	£320	
Offside sliding side-access door. Fixed window in nearside sliding side-access door. Fixed window in offside sliding side-access door – L1 models	BSA	£540	£540		£540	£540	£540	
Twin glazed rear doors – Only available with glazed bulkhead options	J1X	£160	£160	£160	£160	£160	£160	£160

*Optional at extra cost excluding VAT.

Load Area – FlexCargo



Model Specific Features/Options

	Option code*	Electric model			Dynamic	Sportive	Elite	Dynamic Crew Van
		Dynamic	Sportive	Dynamic Crew Van				
FlexCargo Pack – Dual front passenger’s fixed bench seat/Fold-flat centre seat backrest with table/Two-way foldable outer seat/Load-through bulkhead/ Electronic parking brake/Seatbelt unfastened’ audible warning and warning light. Not available on Diesel Automatic models	AYW/AEO	£612	●		£612	●	£612	
FlexCargo Glazed Pack – Dual front passenger’s fixed bench seat/Fold-flat centre seat backrest with table/Two-way foldable outer seat/Load-through glazed bulkhead/ Electronic parking brake/Seatbelt unfastened’ audible warning and warning light. Not available on Diesel Automatic models. Available only when glazed rear door option is specified	AYV/AEO	£690	£80		£690	£80	£690	

*Optional at extra cost excluding VAT.

Infotainment

Standard Features

Radio with 5-inch mono display

Standard on Combo-e Dynamic

Standard on Dynamic

Onboard features:

- AM/FM stereo radio • DAB Digital radio
- RDS with Traffic Programme • Four speakers

Media connections:

- USB connection
- Bluetooth® A2DP audio streaming (Advanced Audio Distribution Profile)

Mobile phone portal:

- Bluetooth® connectivity
- Vehicle microphone
- Handsfree calls via steering wheel controls

Additional features:

- Steering wheel mounted audio controls
- Flexible roof-mounted aerial

Vauxhall Connect*

e-Call and b-Call:

Help when you need it, 24/7, 365 days a year, that's what you get with new Vauxhall Connect. In an emergency or breakdown, you'll be put in touch with a trained advisor, with just the touch of a button.

Live Navigation Plus and more:

You can also access live navigation services, receive regular vehicle diagnostic info plus there's a host of remote convenience features available through the MyVauxhall app.

Multimedia with 8-inch touchscreen (IO5)

Standard on Combo-e Sportive. Optional at extra cost on Combo-e Dynamic at £400 excluding VAT

Standard on Sportive and optional at extra cost on Dynamic at £400 excluding VAT

Features as Radio, with the addition of:

- 8-inch colour touchscreen
- Phone book access

Smartphone interface:

- Apple CarPlay • Android Auto™
- Smartphone projection

Multimedia Navi Pro with 8-inch touchscreen (IO6)

Optional at extra cost on Combo-e Dynamic at £550 excluding VAT and Sportive at £150 excluding VAT

Standard on Elite and optional at extra cost on Dynamic at £550 excluding VAT and Sportive at £150 excluding VAT

Features as Multimedia, with the addition of:

- Satellite navigation system

- **Peace of mind:** emergency call, breakdown call and regular vehicle status and information
- **Convenience:** remote functions (e.g. lock/unlock the door)
- **Our additional services for electric vehicles:** trip planning, remote settings or public charging solutions – we keep you going!
- **Smart driving:** enjoy a relaxed ride thanks to live navigation and trip management
- **Traffic alerts:** Live Navigation Plus introduces speed camera, traffic light camera and accident hotspot alerts

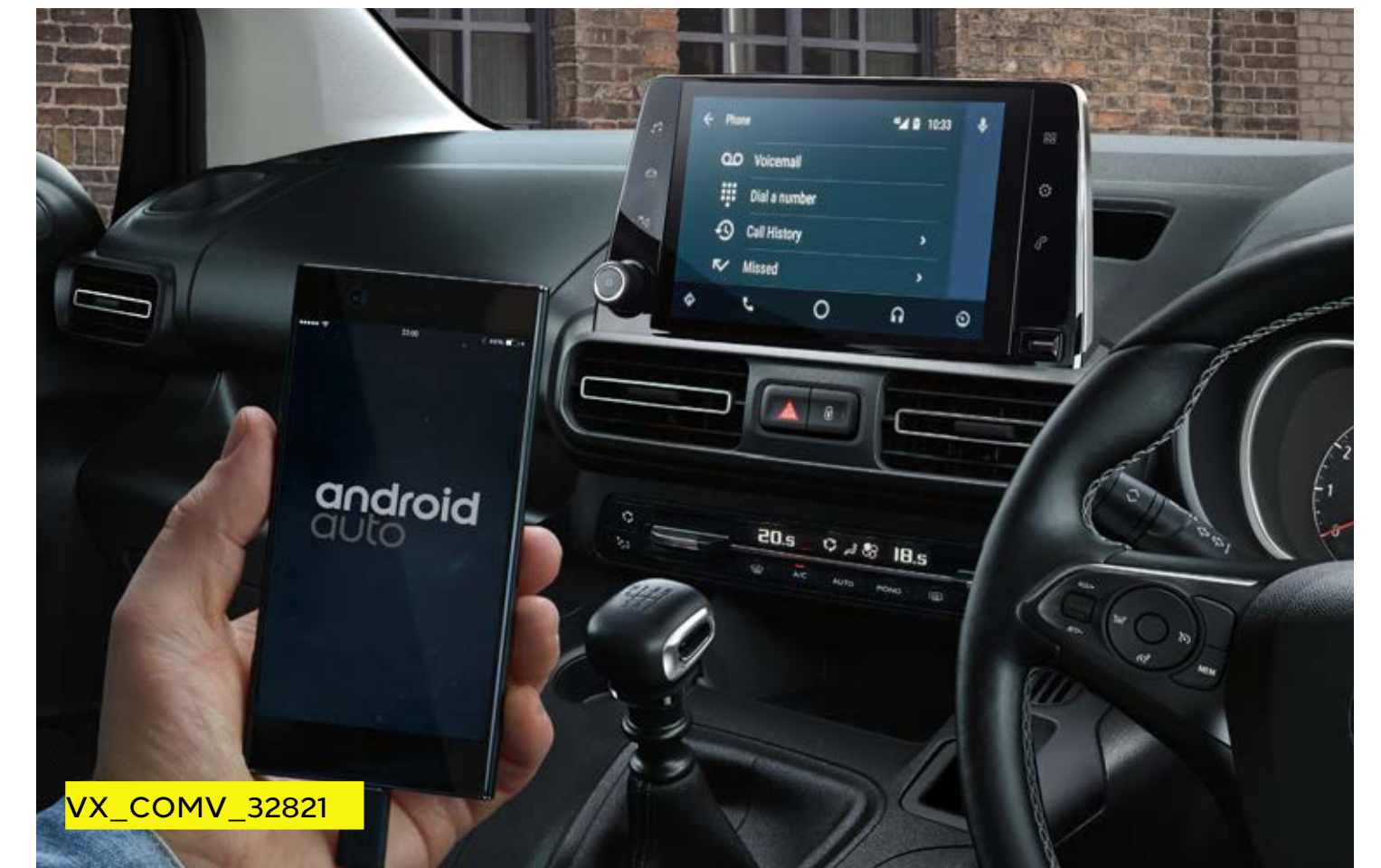

Please note that compatibility and certain functions may be different depending on the type of device and operating system you're using with the Multimedia systems. Apple CarPlay is a trademark of Apple Inc. Apple and iPhone are trademarks of Apple Inc., registered in the U.S. and other countries. Android is a trademark of Google Inc, also registered in the U.S. and other countries. *Services may require a subscription/fee and are subject to mobile network coverage and availability. Live navigation services are included for 3 years and thereafter are subject to an additional subscription fee. Only available on models with satellite navigation.

Seating and Comfort

All models



Steering wheel:

- Three-spoke flat-bottomed design
- Satin chrome-effect bezel

Seat trim:

- Mistral/Lama grey fabric seat trim inserts
- Mistral grey fabric side bolsters

Front seating:

- Driver's seat (six-way adjustable):
 - Height – Reach – Backrest
 - Manual lumbar adjustment
 - Armrest – Head restraint
- Passenger's seat:
 - Single fixed – Head restraint

Additional Sportive features:

- Passenger's bench seat:
 - Dual front passengers' fixed bench seat
 - Fold-flat centre seat backrest with table
 - Two-way foldable outer seat
 - Head restraints

Additional Elite features:

- Four-way adjustable passenger's seat with underseat storage
- Leather-covered steering wheel

Additional Crew Van features:

- Four-way adjustable passenger's seat with underseat storage
- Three-seat second-row split-folding bench
- Vinyl load floor covering

Exterior Colours

Jade White (G20)*
Solid paint



VX_COMV_28902

Moonstone Grey (G40)**
Two-coat metallic paint £475



VX_COMV_28900

Quartz Silver (G41)**
Two-coat metallic paint £475



VX_COMV_28906

Pearl Black (G70)**
Two-coat metallic paint £475



VX_COMV_28905

Diesel Engines

	1.5 (100PS) Turbo D BlueInjection	1.5 (100PS) Turbo D BlueInjection*	1.5 (130PS) Turbo D BlueInjection
Capacity	1499cc	1499cc	1499cc
Maximum power	100PS (75kW) @ 3500rpm	100PS (75kW) @ 3500rpm	130PS (96kW) @ 3750rpm
Maximum torque	250Nm (184lb.ft.) @ 1750rpm	250Nm (184lb.ft.) @ 1750rpm	300Nm (221lb.ft.) @ 1750rpm
Configuration	4 cylinders, 4 valves per cylinder, double overhead camshafts	4 cylinders, 4 valves per cylinder, double overhead camshafts	4 cylinders, 4 valves per cylinder, double overhead camshafts
Fuel/induction system	Variable-nozzle turbocharger with electric switching. Common rail direct injection	Variable-nozzle turbocharger with electric switching. Common rail direct injection	Variable-nozzle turbocharger with electric switching. Common rail direct injection
Emission compliance	Euro 6D TEMP (6.2)	Euro 6D (6.3)	Euro 6D (6.3)
Service interval	25,000 miles or 2 years (whichever occurs sooner)	25,000 miles or 2 years (whichever occurs sooner)	25,000 miles or 2 years (whichever occurs sooner)

*Provisional data.

New Combo-e Specifications*

Single-speed electronic drive selector

As the motor is an all-electric single-speed drive unit, there is no need for multiple gears. Instead, the shifter lets the driver select from the following:

- Park
- Reverse
- Neutral
- Drive
- Braking (for increased regenerative braking)

Drive Mode Selector

The driver can determine the driving style through selecting one of the following modes:

- **Power:** with high power reserves for the highest top speed and torque. Recommended at full capacity
- **Normal:** for a balanced drive that offers a compromise between performance and energy efficiency. WLTP range is validated in this mode
- **ECO:** for maximum range and energy efficiency. The ECO mode deactivates all unnecessary energy-consuming features and reduces the top speed, torque and overall performance

Braking

Energy recuperation

The regenerative braking system works when the vehicle is in motion, energy created by the resistance of the brakes against the drivetrain is converted into DC voltage to partially recharge the battery. The driver can also engage braking mode through the drive selector to increase the level of energy recuperation.

Single foot driving experience

The system not only utilises the energy when the brakes are being used, but also engages when the vehicle is coasting, recovering more energy and enabling single foot driving as the brakes automatically engage when the throttle pedal is released.

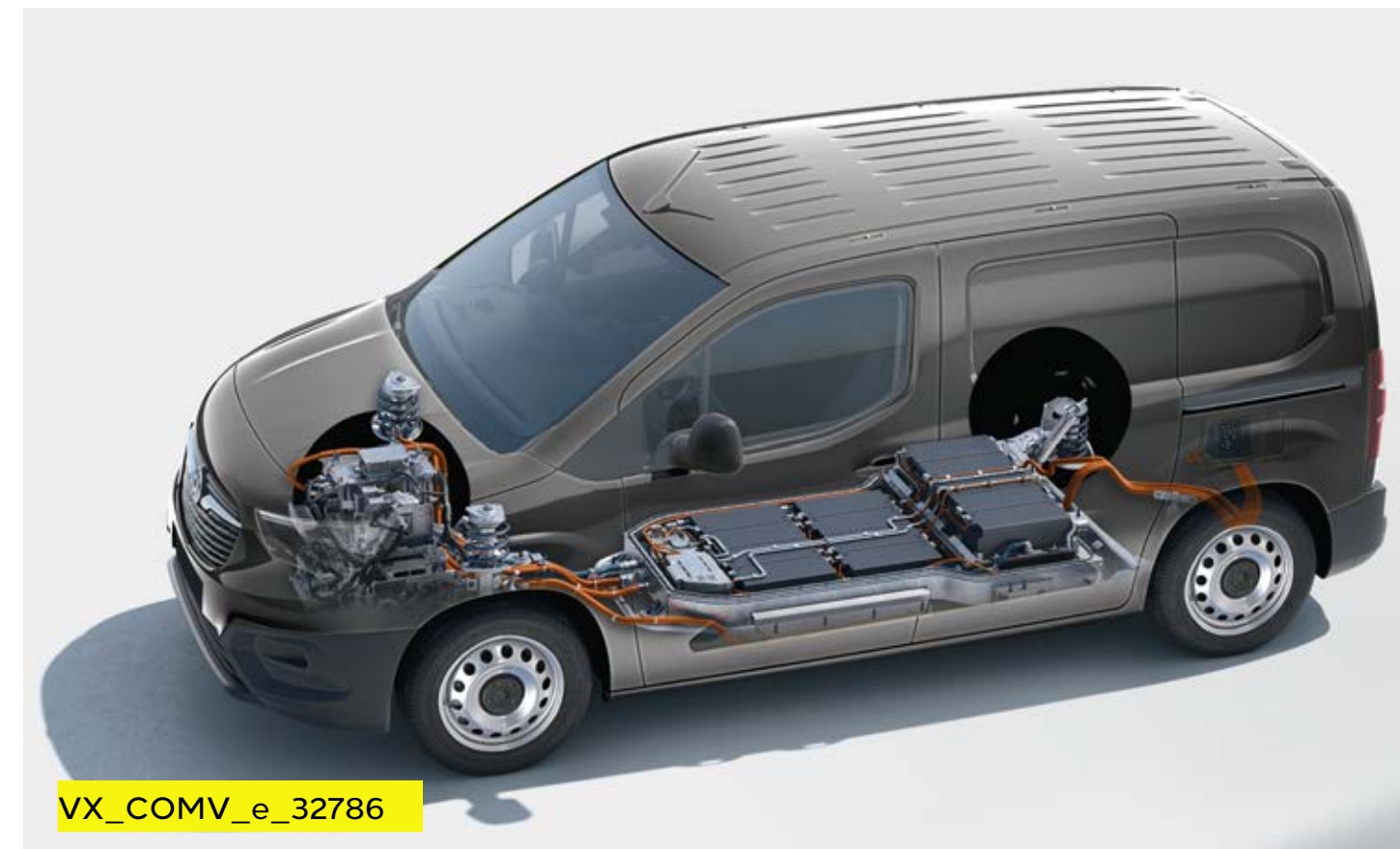

VX_COMV_e_32786

Drivetrain	Combo-e
CO ₂ emissions	0g/km
Maximum power	100/136kW/PS
Maximum torque	260/192 Nm/lb. ft.
Acceleration 0-62mph	11.7 sec
Maximum speed	81mph
Transmission	Automatic electric drive with fixed gear ratio
Service interval	Every 25,000 miles or 2 years (whichever comes sooner). Initial inspection at 12,500 miles or 1 year (whichever comes sooner)

The Combo-e is a battery electric vehicle requiring mains electricity for charging. Range data given has been determined according to WLTP test procedure methodology. The figures shown are intended for comparability purposes only and should only be compared to other cars tested to the same technical standard. The range you achieve under real world driving conditions will depend upon a number of factors, including but not limited to: the accessories fitted (pre and post registration); charging frequency; personal driving style; vehicle load and route characteristics; variations in weather; heating/air conditioning; pre-conditioning and battery condition. For more information, contact your local Vauxhall Retailer.

*Provisional data.

New Combo-e Specifications*

Charging

Combo-e comes fitted with an 7.4kW on-board charger and mode 3 cable. An 11kW on-board charger is available as an extra cost option.

The charging flap's Padlock LED lights up when the cable is correctly plugged in and locked and then acts as a user interface to show the charging status via coloured LED lights:

- **White:** welcome light that helps to light up the area, especially useful in dark conditions
- **Flashing green:** charging in progress
- **Solid green:** charging complete
- **Solid blue:** delayed charging toggled; changes to flashing green when charging commences
- **Solid red:** malfunction

The driver may also choose from two settings:

- **Immediate charging (the standard setting):** Starts charging as soon as the vehicle is docked for charging
- **Delayed charging:** This is especially useful for when cheaper electric rates are desired, e.g. charging at night. Simply enter a charging start time

Please note, EV range assumes that vehicle has been pre-conditioned prior to journey. This function can be accessed either via MyVauxhall App (standard with all Combo-e models or with optional Navi Pro). For WLTP definitions see Glossary of Terms.

Charging		
Supply	Socket	Charge Time (0-100%)
AC current – Domestic 3 pin socket (2.3kW)	Type 2	21h 45m
AC current – Home wallbox or public charger (7kW)	Type 2	7h 30m
AC current – Public charger (11kW)**	Type 2	5h
DC current – Rapid charger (100kW)	CCS	30m (0-80%)

Battery	
Battery capacity	50kWh
AC on-board charger speed (standard)	7.4kW
WLTP Range (Combined)	150-175 miles
WLTP Range (City)	205-271 miles
Energy consumption (Combined low/high)	19.5-23.0kWh/100km
Battery warranty	8 years/100,000 miles/70% capacity



The Combo-e is a battery electric vehicle requiring mains electricity for charging. Range data given has been determined according to WLTP test procedure methodology. The figures shown are intended for comparability purposes only and should only be compared to other cars tested to the same technical standard. The range you achieve under real world driving conditions will depend upon a number of factors, including but not limited to: the accessories fitted (pre and post registration); charging frequency; personal driving style; vehicle load and route characteristics; variations in weather; heating/air conditioning; pre-conditioning and battery condition. For more information, contact your local Vauxhall Retailer.

*Provisional data. **Requires optional 11kW on board charger.

Specifications

Transmission

- Front-wheel drive
- Five-speed manual gearbox 1.5 (100PS) Turbo D models
– Euro 6D TEMP (6.2)
- Six-speed manual gearbox 1.5 (100PS) Turbo D models
– Euro 6D (6.3)
- Six-speed manual gearbox – 1.5 (130PS)
Turbo D models
- Eight-speed Automatic transmission
– available on 1.5 (130PS) Turbo D models

Replacing the traditional lever, the Automatic transmission selection-mode dial/drive wheel is an innovative solution that is both elegant and intuitive. By simply twisting the dial, the following modes can be selected:

- Park, for when the vehicle is stationary and the wheels are locked
- Drive, for Automatic forward motion
- Neutral, for when the vehicle is stationary, wheels are free
- Reverse, for Automatic backward motion

For an extra experience of dynamism, the shift paddles for Automatic transmissions are located behind the steering wheel, offering drivers an extra level of control that is highly ergonomic and intuitive. The shift paddles function in the following way:

- To go up a gear, the driver must pull the right lever towards themselves
- To go down a gear, the driver must pull the left lever towards themselves*

Steering

- Speed-sensitive electric power-assisted system
- Turning circle (kerb-to-kerb) –
11.0m (36 ft) L1 models, 11.8m (38.7 ft) L2 models

Suspension

Front: Independent. MacPherson struts with gas-pressure dampers and linear-rate coil springs. Anti-roll bar

Rear: Torsion beam with gas-pressure dampers and constant-rate coil springs (variable-rate on 2300 models)

Fuel tank capacity

- 50 litres (10.9 gallons)

AdBlue® tank capacity

- 17 litres (3.7 gallons)

Dimensions and Capacities

All measurements in mm (inches) unless stated otherwise. Heights shown unladen.

Loadspace Dimensions	Panel Van		Crew Van
	L1	L2	L2
Load length	1527 (60.1) – 1817 (71.5)	1877 (73.9) – 2167 (85.3)	1051 (41.4) – 2110 (83.1)
Load length – With ‘load through’	3090 (121.7)	3440 (135.4)	3050 (120.1)
Maximum load height	1236 (48.7)	1243 (48.9)	1243 (48.9)
Load width – With nearside side-access door	1630 (64.2)	–	–
Load width – With nearside and offside side-access doors	1527 (60.1)	1527 (60.1)	1527 (60.1)
Maximum width between wheel arches	1229 (48.4)	1229 (48.4)	1229 (48.4)
Loading height	548 (21.6) – 610 (24.0)	548 (21.6) – 610 (24.0)	620 (24.4)
Maximum rear door aperture width	1241 (48.9)	1241 (48.9)	1241 (48.9)
Maximum rear door aperture height	1196 (47.1)	1196 (47.1)	1196 (47.1)
Maximum side-access aperture width	675 (26.6)	675 (26.6)	759 (29.9)
Maximum side-access aperture height	1072 (42.2)	1072 (42.2)	1072 (42.2)
Loadspace Volumes cu.m (cu.ft.)			
Panel Van	3.3 (116.5)	3.9 (137.7)	–
Panel Van – With ‘load through’	3.8 (134.2)	4.4 (155.4)	–
Crew Van – With seats folded	–	–	4.0 (141.2)
Crew Van – With seats up (to top of seats)	–	–	1.8 (63.6)
Crew Van – With seats up (to roof)	–	–	3.5 (123.6)

L1

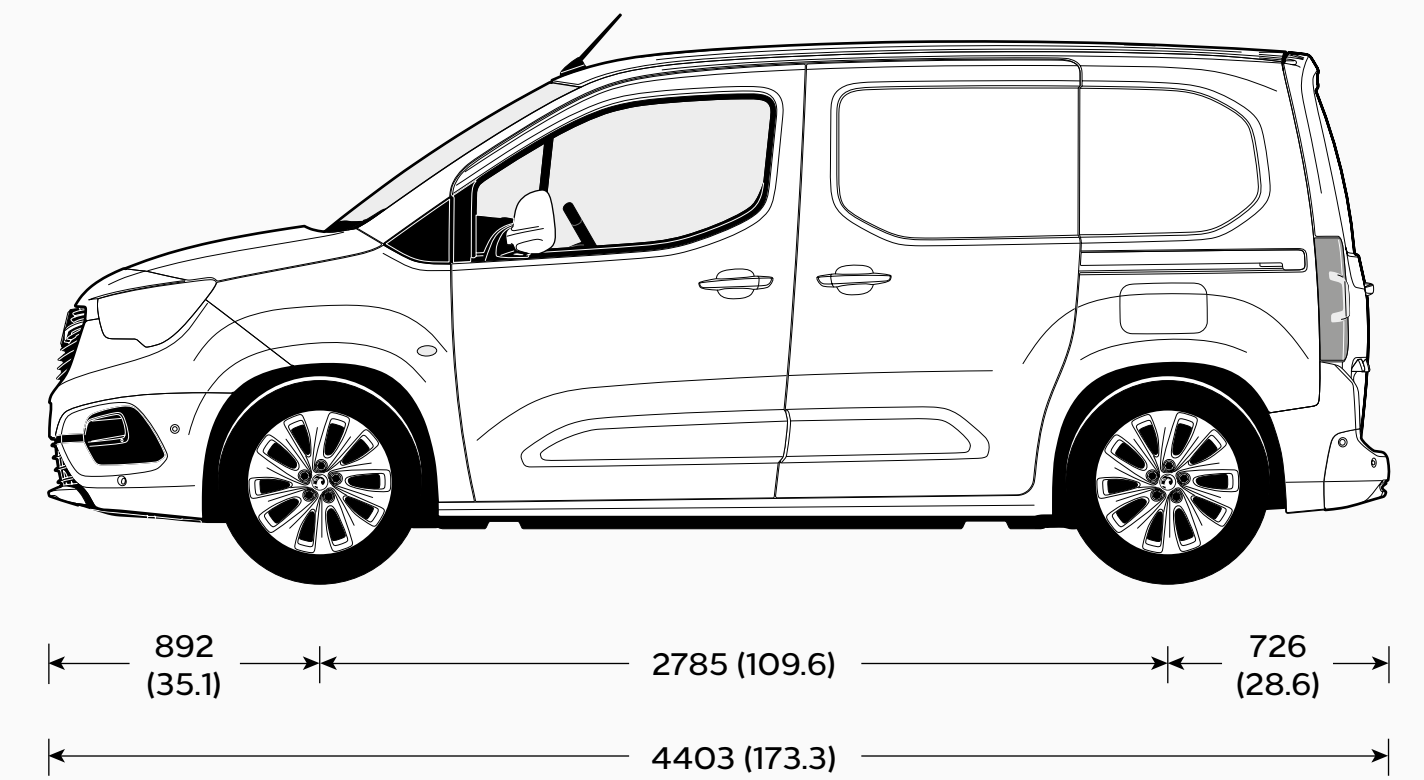
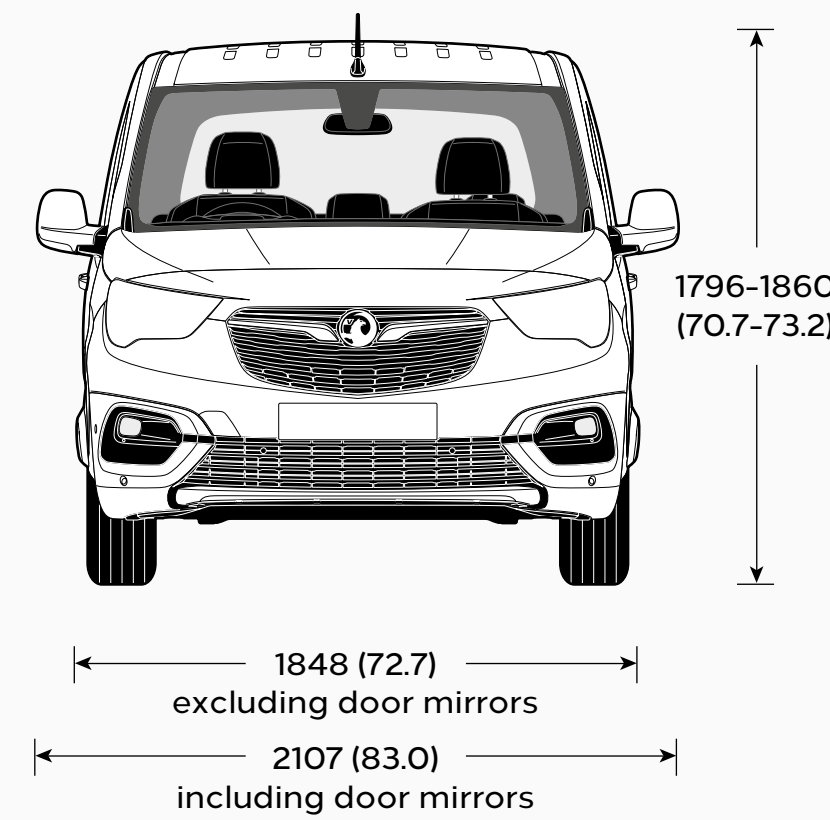

L2

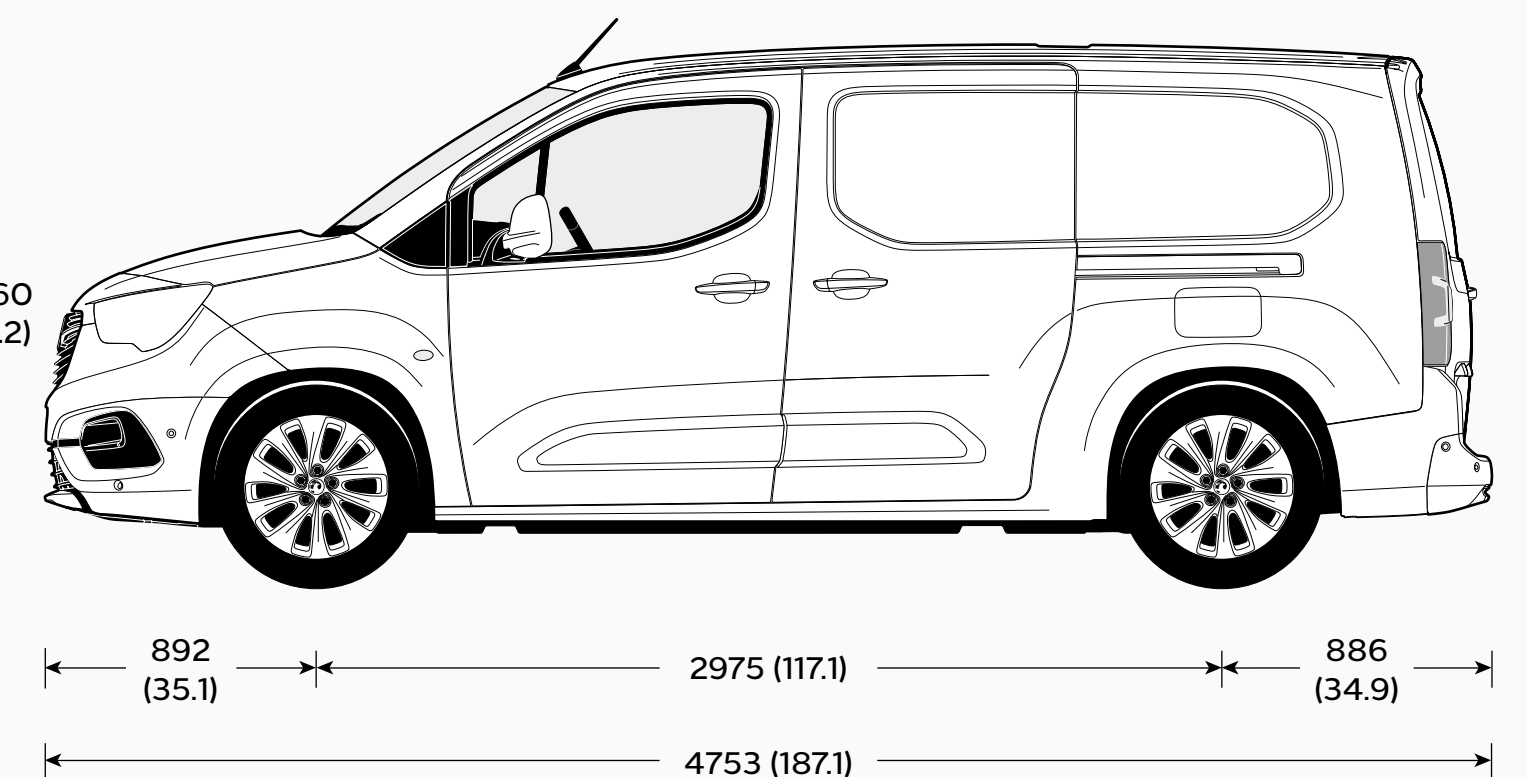
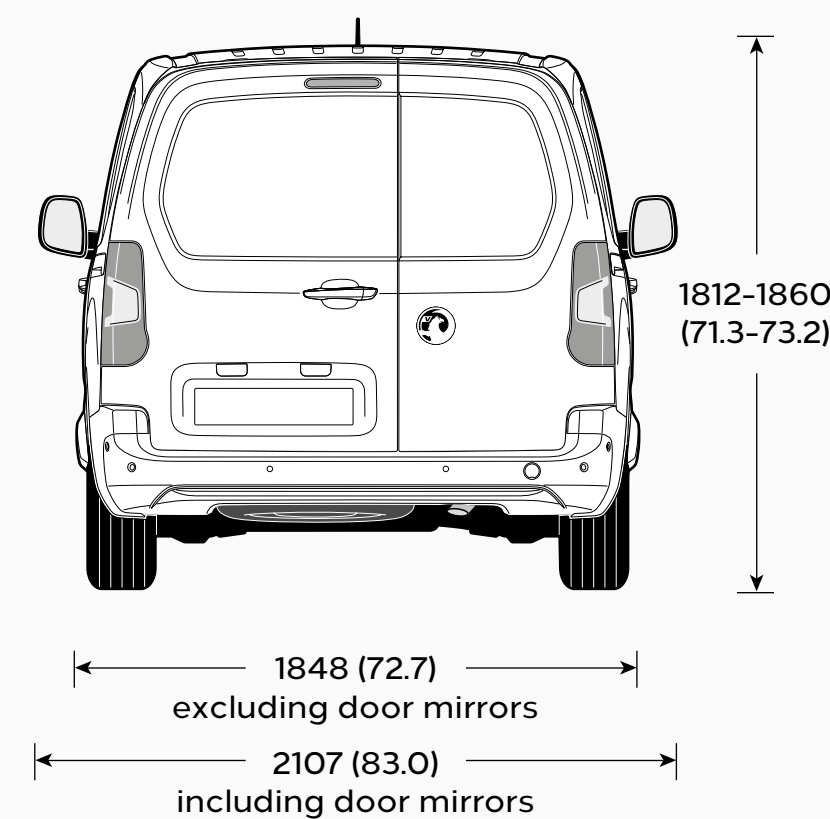

Accessories

Safety	Total (exc. VAT)
Safety kit (first aid kit, hi-vis vest and warning triangle)	£13
Warning triangle	£7
First aid kit	£12
Hi-vis safety vest – Adult	£3
Emergency seat belt cutter and hammer	£15
Philips ADR620 dash cam	£90
Practical	
Spare bulb kit	£56
Stretch tow rope – 3 tonne	£28
Smokers pack	£32
Protection	
Carpet mats (set of 2 – front)	£44
Rubber mats (set of 2 – front)	£41
Front parking sensors	£383
Rear parking sensors	£365
Rear window grilles	£143
Splash guards (rear)	£55
Wooden floor protection	
– Except sliding Door – L1	£218
Wooden floor protection – L2	£212
Wooden side panels	
– Except sliding door – L1	£385
Wooden side panels	
– For sliding door – L1	£385
Wooden side panels	
– For sliding door – L2	£416
Plastic floor protection	
– Except sliding door – L1	£238
Plastic floor protection – L2	£300
Plastic side panels	
– Except sliding door – L1	£578
Plastic side panels – For sliding door – L2	£679

Transport solutions	Total (exc. VAT)
Roof base carrier ¹ (set of 2 bars) for vehicles without roof rails	£146
Roof base carrier (set of 2 bars) for vehicles with roof rails ¹	£173
Additional roof base carrier (1 bar)	£80
Aluminium roof rack (without roof rails)	
– L1	£668
– L2	£720
Steel roof rack (without roof rails)	
– L1	£545
– L2	£623
Roof Carriers	
Thule ladder tilt 311	£498
Thule ladder holder 330	£116
Thule ladder roller 335	£75
Thule front load stop system (side profiles)	£168
Thule front load stop system 321 (front)	£79
Thule ratchet tie down strap	£25
Thule fold down load stop 315	£50
Thule square bar adapter	£37
Roof carriers (requires base carrier)	
Bike roof carrier – Thule FreeRide 532	£65
Bike roof carrier – Thule Expert 298	£109
Surfboard roof carrier – Thule 833	£68
Ski roof carrier (up to 4 pairs) – Thule 7324	£116
Ski roof carrier (up to 6 pairs) – Thule 7326	£210

Transport solutions	Total (exc. VAT)
Hard shell roof boxes (requires base carrier)	
Thule Ocean 80	£205
Thule Ocean 200	£312
Thule Touring 200	£357
Thule Touring 700	£410
Thule Motion 800	from £441

Please note: Prices shown are fully fitted and painted, where applicable and include VAT. Please check with your local Vauxhall Retailer for details. It is advisable to ensure your insurance policy is adequate to cover additional fitted accessories. Prices correct at time of publication.

¹A dedicated T-Track adapter (Thule 697-4 or Thule 697-6) is required for the installation of specific roof boxes, contact your local Vauxhall Retailer for details.

Glossary of Terms

Plated weight

The maximum weight to which a vehicle or an axle may be loaded, determined either by the design of the components or by legislation. All commercial vehicles must carry a manufacturer's 'plate' showing the vehicle and axle gross 'plated weights'. It is an offence to drive a vehicle in a condition where any of these weights are exceeded.

Minimum Mass

Minimum Mass ('Mass in running order' on Certificate of Conformity and 'Mass in Service' on V5C form) is defined according to European Type Approval and include all fluids, tools and 90% fuel load. It is minimum mass for this variant and does not consider local specification/trim or deletable options (specific to Movano). Weights are also subject to manufacturing tolerances (EU Legislation allows 5% tolerance).

Gross Vehicle Weight (GVW)

The total permissible weight of a vehicle including payload and passengers, as shown on the manufacturer's plate.

Gross Combination Weight (GCW)

The maximum permissible weight of a vehicle, including payload and passengers, combined with the total weight of any trailer it is towing. The maximum GCW weight limit is quoted on the vehicle plate and must not be exceeded.

Payload

The total permissible weight that can be carried without exceeding the vehicle's plated weight. Payload do not include driver but do take into consideration specification/trim level:

Weights are also subject to manufacturing tolerances (EU Legislation allows 5% tolerance). Payload does not consider any additional options that a customer may order.

Roof loads

- Combo roof load should not exceed 100kg including the weight of the roof rack/carrier

Maximum towing weight

The maximum weight of any trailer and its load which may be towed within the limit of the vehicle's plated Gross Combination Weight (GCW). It is based on the ability of the vehicle – at full GCW – to restart on a 12% gradient, which is approximately 1 in 8.3, at sea level. At altitudes above 1500 metres, the engine output may drop with a corresponding reduction in towing capability. It is the operator's responsibility to ensure that the trailer noseweight does not cause the rear axle plated weight of the towing vehicle to be exceeded.

Always fit Vauxhall towing attachments and accessories available from your Vauxhall Commercial Vehicle Retailer. They are designed specifically for Vauxhall models and carry a 12-month warranty.

Conversions

A new conversion portal has been introduced. This significantly improves the transparency and response of all communication with body-builders, and converters: converters-and-groupe-psa.com

This website contains complete technical guidelines necessary to convert Vauxhall commercial vehicles – Combo (eK9/K9); Vivaro (eKO/KO); Movano (eX250/X250).

- Conversion Guidelines
- 2D Drawings
- 3D CAD
- WLTP Range/Emission Calculator
- Technical Questions
- Conversion Approval including LONO

Any converter of Vauxhall product should create an account on this portal including those using IVA as approval process. In fact WLTP will make this necessary.

Glossary of Terms

Commercial Vehicle Categories

Differences between M1/N1 and M2/N2 (Vehicles with GVW above 3500kg)

Category M: Passenger carriers

Category M1: Vehicles designed and constructed for the carriage of passengers and comprising no more than eight seats in addition to the driver's seat.

Category M2: Vehicles designed and constructed for the carriage of passengers, comprising more than eight seats in addition to the driver's seat, and having a maximum mass not exceeding 5 tonnes.

Category N: Goods vehicles

Category N1: Vehicles designed and constructed for the carriage of goods and having a maximum mass not exceeding 3.5 tonnes.

Category N2: Vehicles designed and constructed for the carriage of goods and having a maximum mass exceeding 3.5 tonnes but not exceeding 12 tonnes.

Specific differences, all M2/N2 require the following:

Speed limiter: All M2/N2 vehicles are legally required to be speed limited. M2 to 62mph and N2 to 56mph.

Driver licence: Commercial vehicles with GVW greater than 3.5 tonnes have different license requirements. For any new drivers C1 category is necessary. Under some circumstances (social purposes for a non-commercial body) it is possible to drive a minibus without a D1 entitlement (Minibus) however eligibility for this exemption should be confirmed with DVSA.

Driver CPC: Driver Certificate of Professional Competence mandates 35 hours of periodic training every 5 years to maintain licence (from September 2014).

Tachograph: It is a legal requirement to administer the activities of drivers subject to the EU or AETR drivers' hours rules, and also record the vehicle's speed, distance and time. A Smart Card is required for digital tachograph and these are available from the DVLA. The tachograph of a new vehicle must be calibrated within two weeks of first registration.

Operator's Licence: This may also be required to ensure that vehicles are kept safe and in good condition at all times. Specifically for M2, PSV (public service vehicle) operator's licence is required. Exemptions in some circumstances may be permitted but this should always be confirmed with DVSA.

MOT Testing: M2/N2 must be tested each year, and vehicle presented with a completed Certificate of Conformity (CoC). This is available from Vauxhall (regdata@gm.com) or from converter in case of second-stage conversion.

WLTP (Worldwide harmonized Light-duty vehicles Test Procedure)

The test consists of four cycles:

- Low – City centre driving (maximum speed 35mph)
- Medium – Suburban driving (maximum speed 50mph)
- High – Rural driving (maximum speed 60mph)
- Extra-High – Motorway driving (Maximum speed 81mph)

Combined range consists of all four cycles and City range is the first two cycles only (Low and Medium).

Further Information

Vauxhall on-the-road recommended retail prices (RRP)

To eliminate uncertainty about hidden costs incurred when buying a new commercial vehicle, Vauxhall publishes on-the-road prices and these are shown in the pricing tables within this price guide. The prices shown are manufacturer's recommended retail prices (RRP) unless otherwise stated, exclusive of VAT (currently at a rate of 20% which may be payable). These prices include the recommended cost of number plates, delivery to a Vauxhall Retailer of £583.33 (£700.00 including VAT), 12 months' Government Vehicle Excise Duty* and the DVLA new vehicle first registration fee of £55.00*.

Please note: The RRP does not include fuel supplied by the Retailer, motor insurance or any other goods or services supplied by agreement between the Retailer and customer.

Price protection

Order a new Vauxhall for build in the current model year (as confirmed by your Retailer) for delivery no more than three months in advance and the price you are quoted is the price you pay. This is irrespective of any subsequent price rises between placing your order and delivery of your new car, but you must take delivery as soon as the car is available.

Please note: Price protection does not apply to electric/hybrid models. Vauxhall Motors Limited is not liable for price adjustments caused by Government changes in the rate of VAT (currently 20%), Vehicle Excise Duty, DVLA new vehicle first registration fee or by any other applicable legislation or regulations.

In the event of an accident...

Vauxhall Accident Management helps keep you mobile following an accident. Benefits include vehicle recovery, Vauxhall-approved repairs and contacting your insurer. For more details, visit vauxhall.co.uk/AccidentManagement

Vehicle Excise Duty

The amount of Vehicle Excise Duty (road fund licence) payable on new commercial vehicles varies depending on gross vehicle weight (GVW) and European standard emissions compliance, as shown below*.

Up to 3500kg GVW	£275.00
Over 3500kg GVW	£165.00

*Correct at time of publication.

Customer Care Commitment

For added peace of mind, Vauxhall has an innovative Customer Care Commitment** that offers the following:

- Three-year vehicle warranty consisting of a one-year/unlimited mileage manufacturer's warranty and a second and third year manufacturer's warranty with a 60,000 miles limitation
- Vauxhall Assistance for 12 months from first registration
- Five years' body panel anti-perforation warranty

**Warranty is only on vehicles sourced from Vauxhall Motors Limited. Terms and conditions apply – please see your Vauxhall Retailer for details.

Vauxhall Assistance

Vauxhall Assistance is provided Automatically with every new Vauxhall Commercial Vehicle for 12 months from first registration and covers everything from accidents, mechanical breakdown to flat tyres. With Vauxhall Assistance help is literally just a free[†] phone call away, 24 hours a day, 365 days a year!

[†]Mobile phone users will be charged at their standard tariff.

Vauxhall Extended Warranty

For complete peace of mind Vauxhall offers an extended warranty that can be purchased on an annual basis following the expiry of the original new vehicle warranty. It covers most mechanical

and electrical components. Terms and conditions apply, for further details please contact your local Vauxhall Retailer.

Protecting the environment

Our products are increasingly winning environmental awards, both through the use of more recycled materials and by becoming cleaner and more efficient. For information on Vauxhall's efforts to achieve an environmentally sustainable future, including information on Design for Recycling, take-back of End-of-Life Vehicles (ELVs), and the recycling of ELVs, see vauxhall.co.uk/recycling

Van Business Centres

Keeping your van on the road. We know how important your van is to you, that's why we're geared up to minimise your downtime.

Our nationwide Van Business Centres provide fast, convenient value for money servicing, repairs and MOTs.

- All work is carried out by Vauxhall trained technicians using only genuine parts
- No appointments are required for diagnosis and we offer a 'while you wait' service

We have all the expertise required and will spare no effort to get you back in business as soon as possible.

Vauxhall Service Plan

Vauxhall Retailers offer a great service for owners of all Vauxhall vehicles. Value for money, regular offers and free check-ups, combined with the peace of mind that comes from using Vauxhall-trained technicians and genuine parts, help keep your vehicle in peak condition at all times. Every Vauxhall Retailer supports our customer promise:

We are Vauxhall experts

- Fully Vauxhall-trained technicians
- We use Vauxhall approved diagnostic equipment and specialist tools
- Full access to Vauxhall repair databases and technical centres

We are transparent

- Our invoicing will clearly set out the work at the price agreed with no hidden extras

We are never beaten on price

- We will match any written like for like service/repair quote from a local^{††} competitor using genuine repair methods and parts

We are convenient

- Flexible booking times to suit you
- 'One-stop shop' for every type of Vauxhall service
- While you wait facility on stocked tyres, batteries and exhausts
- Free courtesy vehicle or local collection with annual services and warranty work

We are thorough

- 25 point safety check with any workshop visit
- No obligation advice on essential and non-essential work
- Free check for safety enhancements and upgrades to your vehicle and software
- Free 'Wash and Vac' with every annual service
- Free fitting of wipers and external bulbs with annual services

^{††}A radius of five miles/20 minutes from your Vauxhall Retailer.

For more product information

For further information on the Vauxhall range or location of your nearest Vauxhall Retailer please call **0345 600 1500**. Alternatively, details can be found on our website at vauxhall.co.uk

For more information call **0345 600 1500**

Discover the full Vauxhall range at **[vauxhall.co.uk](https://www.vauxhall.co.uk)**

Join us online

The invoice price, including delivery to Retailer, factory-fitted options, accessories fitted by the Retailer and number plates, is subject to VAT. Some feature descriptions in this guide may refer to, and some illustrations may show, optional equipment not included in the standard delivery. The information contained in this guide was accurate at the time of publication. We reserve the right to make changes in design and equipment. Please note that Vauxhall Retailers are not the agents of Vauxhall Motors Limited and are not authorised to bind Vauxhall Motors Limited by any specific or implied undertaking or representation. It is advisable to ensure that your motor insurance policy provides adequate cover for additional fitted options and accessories. The colours in this guide are only approximate actual colours. Illustrated optional equipment is available at extra charge. Availability, technical features and equipment provided on our vehicles can vary by model. For precise information on the equipment provided on our vehicles, please contact your local Vauxhall Retailer.

VAUXHALL

Price and Specification Guide
17 December 2021 | Model Year 2022A



Vivaro

Including Vivaro-e Range

Contents

To find the information you want use the links below to navigate around the guide:

[Choose Your Trim Level](#)

[Range Highlights](#)

[Models](#)

[Prices and Weights](#)

[Fuel Economy and Emissions](#)

[Features/Options](#)

[Infotainment](#)

[Interior Style and Comfort](#)

[Exterior Colours](#)

[Wheels and Tyres](#)

[Engines and Technical Data](#)

[Specifications](#)

[Dimensions and Capacities](#)

[Accessories](#)

[Glossary of Terms](#)

[Further Information](#)

Choose Your Trim Level

Vivaro-e Dynamic

VX_VIV_e_32018



First up is the Vivaro-e Dynamic, loaded with features and future-proofed technology to match.

Vivaro-e Elite

VX_VIV_32762_Shadow_Job_Only



The Vivaro-e Elite is the superbly-equipped fully-electric van, offering low running costs with style to match.

Dynamic

VX_VIV_32017



Boasting superb value for money the Dynamic diesel model is an entry-level to new van ownership.

Sportive

VX_VIV_32763_Shadow_Job_Only



The Vivaro Sportive diesel offers an edge with low running costs, good looks and even more practicality.

Elite

VX_VIV_32764_Shadow_Job_Only



Our range-topping and extra impressive safety-orientated Vivaro Elite completes the range.

Vivaro-e Range Highlights

Dynamic

Standard features include:

- Automatic transmission with e-toggle shift
- Electronic parking brake
- Electronic stability programme
- Traction control
- ABS with electronic brakeforce distribution
- Hill start assist
- Driver and front passengers' airbag
- Remote control central deadlocking
- Selective door locking
- Full-height steel bulkhead (Panel Van only)
- Six-way adjustable driver's seat with lumbar adjustment and armrest
- Dual front passengers' bench seat with underseat storage
- Multi-function trip computer
- 3.5-inch digital instrument cluster
- Vauxhall Connect
- Multimedia infotainment unit
- 7-inch colour touchscreen
- Digital radio/AM/FM stereo radio
- Bluetooth® connectivity
- Nearside and offside sliding side-access doors
- Twin solid rear doors
- Electrically operated front windows with one-touch facility
- Electrically adjustable/heated door mirrors
- Remote control security alarm system
- Cab soundproofing
- Laminated acoustic windscreen
- Front fog lights
- Rear parking distance sensors
- Rain-sensitive windscreen wipers
- Automatic lighting control
- 16-inch steel wheels
- Steel spare wheel

Elite – MY22B specification shown*

Features over Dynamic models:

- FlexCargo load-through bulkhead (Panel Van only)
- Fold-flat centre seat backrest providing flat work surface
- Multimedia Navi Pro satellite navigation system
- 7-inch colour touchscreen
- Driver drowsiness alert (based on driving time)
- Panoramic rear-view camera
- Body-colour front bumpers
- Body-colour rear bumpers (L1)
- Body-colour rear corner bumper with black centre section (L2)
- Chrome-effect front grille
- Front fog lights
- Rain-sensitive windscreen wipers
- Automatic lighting control
- LED daytime running lights
- Lane departure warning
- Speed sign recognition with intelligent speed adaptation
- Side blind spot alert
- Electrically folding door mirrors
- 17-inch silver alloy wheels
- Two-coat metallic paint

Doublecab Elite

Additionally feature:

- Driver and front passengers' curtain and side-impact airbags
- Three-individually contoured rear seats
- Full-height ABS plastic bulkhead with window

*From February production.

Vivaro Range Highlights

Dynamic

Standard features include:

- Hill start assist
- Driver and front passengers' airbag
- Remote control central deadlocking
- Selective door locking
- Full-height steel bulkhead (Panel Van only)
- Six-way adjustable driver's seat
- Dual front passengers' bench seat
- Multi-function trip computer
- Vauxhall Connect
- Facia-mounted drinks holders
- Nearside and offside sliding side-access doors
- Twin solid rear doors
- Electrically operated front windows
- Electrically adjustable/heated door mirrors
- 16-inch steel wheels
- Steel spare wheel
- Remote control security alarm system
- Cab soundproofing
- Multimedia infotainment unit
- 7-inch colour touchscreen

- Air conditioning
- Laminated acoustic windscreen
- Front fog lights
- Rear parking distance sensors
- Rain-sensitive windscreen wipers
- Automatic lighting control

Doublecab Dynamic

Additionally feature:

- Driver and front passengers' curtain and side-impact airbags
- Three-individually contoured rear seats
- Full-height ABS plastic bulkhead with window

Sportive

Features over Dynamic models:

- FlexCargo load-through bulkhead
- Fold-flat centre seat backrest providing flat work surface
- Body-colour front bumpers
- Body-colour rear bumpers (L1)
- Body-colour rear corner bumper with black centre section (L2)
- Chrome-effect front grille
- LED daytime running lights
- 16-inch steel wheels with full-diameter wheel trims
- Two-coat metallic paint

Elite – MY22B specification shown*

Features over Sportive models:

- Multimedia Navi Pro satellite navigation system
- Lane departure warning
- Speed sign recognition with intelligent speed adaptation
- Side blind spot alert
- Driver drowsiness alert (based on driving time)
- Panoramic rear-view camera
- Electrically folding door mirrors
- 17-inch silver alloy wheels

Doublecab Elite

Additionally feature:

- Driver and front passengers' curtain and side-impact airbags
- Three-individually contoured rear seats
- Full-height ABS plastic bulkhead with window

Please note: FlexCargo load-through bulkhead is standard on Panel Van only.

*From February production.

Vivaro-e Dynamic



VX_VIV_e_32018

Dynamic OTR from £31,528.33*

Infotainment:

- Multimedia audio system
 - 7-inch colour touchscreen
 - 3.5-inch digital instrument cluster
 - AM/FM/DAB digital radio
 - Bluetooth® audio streaming
 - Bluetooth® mobile phone portal
 - Apple CarPlay/Android Auto™
 - USB audio connection

Interior convenience/styling:

- Automatic transmission with e-toggle shift
- Electric parking brake
- Air conditioning
- Multi-function trip computer
- Vauxhall Connect
- Six-way adjustable driver's seat with lumbar adjustment and armrest
- Dual front passengers' bench seat with underseat storage

Exterior convenience/styling:

- Rear parking distance sensors
- Laminated acoustic windscreen
- Front fog lights
- High beam assist
- Daytime running lights
- Rain-sensitive windscreen wipers
- Electrically adjustable/heated door mirrors
- Electrically operated front windows
- Nearside and offside sliding side-access doors
- Twin solid rear doors
- Side-protection mouldings
- 16-inch steel wheels

Safety/security:

- Driver and front passengers' airbags
- Height-adjustable front lap and diagonal inertia-reel seatbelts
- Electronic stability programme with traction control
- Anti-lock braking system
- Full-height steel bulkhead
- Hill start assist
- Remote control central deadlocking
- Selective door locking
- Electronic engine deadlock immobiliser
- Remote control security alarm system

*Price shown is after allowing for PiVG (Plug-in Van Grant) and excludes VAT.

Vivaro-e

Elite – MY22B specification shown (from February production)



VX_VIV_32762_Shadow_Job_Only

Elite

OTR from £37,203.33*

Infotainment:

- Multimedia Navi Pro
 - Fully integrated European sat nav system
 - 7-inch colour touchscreen
 - 3.5-inch digital instrument cluster
- Voice control
- AM/FM/DAB digital radio
- Bluetooth® audio streaming
- Bluetooth® mobile phone portal
- USB audio connection
- Second USB charging connection
- Four speakers

Interior convenience/styling:

- Automatic transmission with e-toggle shift
- Electric parking brake
- Air conditioning
- FlexCargo load-through bulkhead
- Multi-function trip computer
- Vauxhall Connect
- Six-way adjustable driver's seat with lumbar adjustment and armrest
- Dual front passengers' bench seat with underseat storage

Exterior convenience/styling:

- Rear parking distance sensors
- Heat-reflective/acoustic windscreen
- Body-colour front bumpers
- Body-colour rear bumpers (L1)
- Body-colour rear corner bumper with black centre section (L2)
- Chrome-effect front grille
- Front fog lights
- Rain-sensitive windscreen wipers
- Electrically adjustable/heated door mirrors
- Electrically folding door mirrors
- Electrically operated front windows

- Nearside and offside sliding side-access doors
- Twin solid rear doors
- Side-protection mouldings
- 17-inch silver alloy wheels

Safety/security:

- Lane departure warning
- Speed sign recognition with intelligent speed adaptation
- Side blind spot alert
- Panoramic rear-view camera
- Driver drowsiness alert
- Driver and front passengers' airbags
- Electronic stability programme with traction control
- Anti-lock braking system
- Full-height steel bulkhead
- Hill start assist
- LED daytime running lights
- Remote control central deadlocking
- Selective door locking
- Electronic engine deadlock immobiliser
- Remote control security alarm system

Doublecab OTR from £40,878.33*

Additionally feature:

- Driver and front passengers' curtain and side-impact airbags
- Three-individually contoured rear seats
- Full-height ABS plastic bulkhead with window

Please note: Doublecab rear seating is not equipped with ISOFIX child seat mountings.

*Price shown is after allowing for PiVG (Plug-in Van Grant) and excludes VAT.

Vivaro Dynamic



VX_VIV_32017

Dynamic OTR from £24,818.33*

Infotainment:

- Multimedia audio system
 - 7-inch colour touchscreen
 - AM/FM/DAB digital radio
 - Bluetooth® audio streaming
 - Bluetooth® mobile phone portal
 - Apple CarPlay/Android Auto™
 - USB audio connection

Interior convenience/styling:

- Air conditioning
- Multi-function trip computer
- Vauxhall Connect
- Six-way adjustable driver's seat with lumbar adjustment and armrest
- Dual front passengers' bench seat with underseat storage

Exterior convenience/styling:

- Rear parking distance sensors
- Laminated acoustic windscreen
- Front fog lights
- High beam assist
- Daytime running lights
- Rain-sensitive windscreen wipers
- Electrically adjustable/heated door mirrors
- Electrically operated front windows
- Nearside and offside sliding side-access doors
- Twin solid rear doors
- Side-protection mouldings
- 16-inch steel wheels

Safety/security:

- Driver and front passengers' airbags
- Height-adjustable front lap and diagonal inertia-reel seatbelts
- Electronic stability programme with traction control
- Anti-lock braking system
- Full-height steel bulkhead
- Hill start assist
- Remote control central deadlocking
- Selective door locking
- Electronic engine deadlock immobiliser
- Remote control security alarm system

Doublecab OTR from £29,828.33*

Additionally feature:

- Driver and front passengers' curtain and side-impact airbags
- Three-individually contoured rear seats
- Full-height ABS plastic bulkhead with window

Please note: Doublecab rear seating is not equipped with ISOFIX child seat mountings.

*OTR price excluding VAT.

Vivaro Sportive



VX_VIV_32763_Shadow_Job_Only

Sportive OTR from £26,378.33*

Infotainment:

- Multimedia audio system
 - 7-inch colour touchscreen
 - AM/FM/DAB digital radio
 - Bluetooth® audio streaming
 - Bluetooth® mobile phone portal
 - Apple CarPlay/Android Auto™
 - Bluetooth® mobile phone portal
 - USB audio connection

Interior convenience/styling:

- Air conditioning
- FlexCargo load-through bulkhead
- Multi-function trip computer
- Vauxhall Connect
- Six-way adjustable driver's seat with lumbar adjustment and armrest
- Dual front passengers' bench seat with underseat storage

Exterior convenience/styling:

- Rear parking distance sensors
- Laminated acoustic windscreen
- Body-colour front bumpers
- Body-colour rear bumpers (L1)
- Body-colour rear corner bumper with black centre section (L2)
- Body-colour side-protection mouldings
- Body-colour door handles
- Chrome-effect front grille
- Front fog lights
- High beam assist
- Rain-sensitive windscreen wipers

- Electrically adjustable/heated door mirrors
- Electrically operated front windows
- Nearside and offside sliding side-access doors
- Twin solid rear doors
- Side-protection mouldings
- 16-inch steel wheels with full-diameter wheel trims

Safety/security:

- Driver and front passengers' airbags
- Electronic stability programme with traction control
- Anti-lock braking system
- Full-height steel bulkhead
- Hill start assist
- Remote control central deadlocking
- Selective door locking
- Electronic engine deadlock immobiliser
- Remote control security alarm system
- LED daytime running lights

*OTR price excluding VAT.

Vivaro Elite

– MY22B specification shown
(from February production)



VX_VIV_32764_Shadow_Job_Only

Elite OTR from £29,998.33*

Infotainment:

- Multimedia Navi Pro
 - Fully integrated European sat nav system
 - 7-inch colour touchscreen
 - Voice control
 - AM/FM/DAB digital radio
 - Bluetooth® audio streaming
 - Bluetooth® mobile phone portal
 - USB audio connection
 - Second USB charging connection
 - Four speakers

Interior convenience/styling:

- Air conditioning
- FlexCargo load-through bulkhead
- Multi-function trip computer
- Vauxhall Connect
- Six-way adjustable driver's seat with lumbar adjustment and armrest
- Dual front passengers' bench seat with underseat storage

Exterior convenience/styling:

- Rear parking distance sensors
- Heat-reflective/acoustic windscreen
- Body-colour front bumpers
- Body-colour rear bumpers (L1)
- Body-colour rear corner bumper with black centre section (L2)
- Chrome-effect front grille
- Front fog lights
- Rain-sensitive windscreen wipers
- Electrically adjustable/heated door mirrors
- Electrically folding door mirrors
- Electrically operated front windows

- Nearside and offside sliding side-access doors
- Twin solid rear doors
- Side-protection mouldings
- 17-inch silver alloy wheels

Safety/security:

- Lane departure warning
- Speed sign recognition with intelligent speed adaptation
- Side blind spot alert
- Panoramic rear-view camera
- Driver drowsiness alert
- Driver and front passengers' airbags
- Electronic stability programme with traction control
- Anti-lock braking system
- Full-height steel bulkhead
- Hill start assist
- Remote control central deadlocking
- Selective door locking
- Electronic engine deadlock immobiliser
- Remote control security alarm system
- LED daytime running lights

Doublecab OTR from £33,308.33*

Additionally feature:

- Driver and front passengers' curtain and side-impact airbags
- Three-individually contoured rear seats
- Full-height ABS plastic bulkhead with window

Please note: Doublecab rear seating is not equipped with ISOFIX child seat mountings.

*OTR price excluding VAT.

New Vivaro-e Panel Van Prices/Weights

	Model/ Pack Code	Orderable Option Code	Minimum Mass (kg)*	Maximum indicative payload (kg)*	Gross Vehicle Weights (GVW) (kg)	Plated weights (kg)		Towing weights (kg) Braked	Plated Gross Combination Weights (GCW) (kg)	Price (£) exc. VAT	On-the-road RRP before PiVG (£) exc. VAT	On-the-road RRP after PiVG (£) exc. VAT	Insurance groups
						Front axle	Rear axle						
L1 Dynamic Panel Van													
3100 100kW (136PS) auto – 50kWh battery	8G05 9CQ2	XiFD	1874	1226	3100	1500	1800	1000	4100	35,890.00	36,528.33	31,528.33	41E
3100 100kW (136PS) auto – 75kWh battery	8G05 9DQ1	XiFC	2025	1000	3025	1500	1800	1000	4100	37,965.00	38,603.33	33,603.33	43E
L1 Elite Panel Van													
3100 100kW (136PS) auto – 75kWh battery	8H05 9DQ1	XiFC	2025	1000	3025	1500	1800	1000	4100	41,565.00	42,203.33	37,203.33	36E
L2 Dynamic Panel Van													
3100 100kW (136PS) auto – 50kWh battery	8G05 9CQ2	XiFE	1902	1198	3100	1500	1800	1000	4100	37,035.00	37,673.33	32,673.33	41E
3100 100kW (136PS) auto – 75kWh battery	8G05 9DQ1	XiFF	2053	1002	3055	1500	1500	1000	4055	39,040.00	39,678.33	34,678.33	44E
L2 Elite Panel Van													
3100 100kW (136PS) auto – 75kWh battery	8H05 9DQ1	XiFF	2053	1002	3055	1500	1800	1000	4055	42,640.00	43,278.33	38,278.33	36E
L2 Elite Doublecab													
3100 100kW (136PS) auto – 75kWh battery**	8HC5 9DQ1	XiFF	2113	987	3100	1500	1800	1000	4100	45,240.00	45,878.33	40,878.33	37E
L1 Dynamic Platform Cab													
3100 100kW (136PS) auto – 50kWh battery	8F03 9CQ2	XiFD	1708	1392	3100	1500	1800	1000	4100	34,835.00	35,473.33	N/A†	-
3100 100kW (136PS) auto – 75kWh battery	8F03 9DQ1	XiFC	1859	1241	3100	1500	1800	1000	4100	36,965.00	37,603.33	N/A†	-

Please note: On-the-road recommended retail prices (RRP) include number plates and delivery to Retailer of £583.33 exc. VAT (£700.00 inc. VAT) and new vehicle first registration fee of £55.00 (correct at time of publication). Excludes fuel and insurance. Price has been calculated using manufacturer estimates and includes an OZEV grant of up to £5,000.00 which has been deducted from the price of the vehicle (OZEV Grant not available in the Isle of Man). The grant is a government incentive and is subject to withdrawal prior to delivery of your vehicle. Retailers may be required to carry out more than one credit check during the course of the order process. You may be required to place a deposit when placing your order with your supplying Retailer. In the event of a price change, deposit refunds will be governed by your supplying Retailer's policy and as such must be discussed with the supplying Retailer.

Gross plated weights (including axle weights) quoted on the vehicle plate are to UK plated weight specification and must never be exceeded. Unbraked towing weight 750kg – all models.

*Minimum Mass for standard vehicles will vary according to the vehicle specification (including trim, options and accessories) with a corresponding variation in payload.

**VAT reclaimable status requires a minimum 1-tonne payload for Doublecabs in accordance with HMRC guidance. Doublecabs with a payload of less than 1-tonne may be eligible for VAT reclaimable status, subject to further HMRC assessment. Customers are advised to consult their local HMRC office or visit <https://www.gov.uk/government/organisations/hm-revenue-customs> for further details in relation to VAT reclaimable status. Payload calculations should take into consideration local UK Specification and Trim Level. Ordered options may also impact payload.

†Current incomplete e-LCV are not eligible for PiVG.

Vivaro-e Battery Range

	WLTP Combined Range (miles) [#] – pack code	WLTP City Range (miles) [#] – pack code
L1 Dynamic Panel Van		
3100 100kW (136PS) auto – 50kWh battery	133	196
3100 100kW (136PS) auto – 75kWh battery	196	267
L1 Elite Panel Van		
3100 100kW (136PS) auto – 75kWh battery	189	255
L2 Dynamic Panel Van		
3100 100kW (136PS) auto – 50kWh battery	132	194
3100 100kW (136PS) auto – 75kWh battery	194	263
L2 Elite Panel Van		
3100 100kW (136PS) auto – 75kWh battery	188	252
L2 Elite Doublecab		
3100 100kW (136PS) auto – 75kWh battery	185	246
L1 Dynamic Platform Cab		
3100 100kW (136PS) auto – 50kWh battery	N/A*	N/A*
3100 100kW (136PS) auto – 75kWh battery	N/A*	N/A*

WLTP figures are based on a configured vehicle as per pack code for UK with no options fitted as at 23 November 2021.

[#]The Vivaro-e is a battery electric vehicle requiring mains electricity for charging. Range data given has been determined according to WLTP test procedure methodology. The figures shown are intended for comparability purposes only and should only be compared to other cars tested to the same technical standard. The range you achieve under real world driving conditions will depend upon a number of factors, including but not limited to: the accessories fitted (pre and post registration); charging frequency; personal driving style; vehicle load and route characteristics; variations in weather; heating/air conditioning; pre-conditioning and battery condition. For more information, contact your local Vauxhall Retailer.

*Current incomplete e-LCV are not eligible for PiVG.

Vivaro Panel Van Prices/Weights

	Pack Code	Orderable Option Code	Minimum Mass (kg)*	Maximum indicative payload (kg)*	Gross Vehicle Weights (GVW) (kg)	Plated weights (kg)		Towing weights (kg) Braked	Plated Gross Combination Weights (GCW) (kg)	Price (£) exc. VAT	On-the-road RRP (£) exc. VAT	Insurance groups
						Front axle	Rear axle					
L1 Dynamic Panel Van Euro 6D (6.3)												
2700 1.5 (100PS) Turbo D S/S	8D05 i3L1	XiFC	1660	975	2635	1500	1500	1800	4435	23,905.00	24,818.33	34E
2700 1.5 (120PS) Turbo D S/S	8D05 i4L1	XiFC	1581	1079	2660	1500	1500	1800	4460	24,545.00	25,458.33	37E
2900 1.5 (100PS) Turbo D S/S	8D05 i3L2	XiFD	1660	1170	2830	1500	1800	2000	4830	24,360.00	25,273.33	35E
3100 2.0 (145PS) Turbo D S/S	8D05 MQP2	XiFD	1642	1458	3100	1500	1800	2500	5600	25,000.00	25,913.33	40E
3100 2.0 (145PS) Turbo D S/S auto	8D05 MK82	XiFD	1642	1458	3100	1500	1800	2500	5600	26,640.00	27,553.33	41E
L1 Sportive Panel Van Euro 6D (6.3)												
2700 1.5 (100PS) Turbo D S/S	8C05 i3L1	XiFC	1660	975	2635	1500	1500	1800	4435	25,465.00	26,378.33	35E
2700 1.5 (120PS) Turbo D S/S	8C05 i4L1	XiFC	1581	1079	2660	1500	1500	2000	4660	26,120.00	27,033.33	37E
2900 1.5 (100PS) Turbo D S/S	8C05 i3L2	XiFD	1581	1079	2660	1500	1500	2000	4660	25,930.00	26,843.33	39E
3100 2.0 (145PS) Turbo D S/S	8C05 MQP2	XiFD	1642	1458	3100	1500	1800	2500	5600	26,585.00	27,498.33	40E
L1 Elite Panel Van Euro 6D (6.3)												
3100 2.0 (145PS) Turbo D S/S	8E05 MQP2	XiFD	1642	1458	3100	1500	1800	2500	5600	29,085.00	29,998.33	36E
3100 2.0 (145PS) Turbo D S/S auto	8E05 MK82	XiFD	1682	1418	3100	1500	1800	2500	5600	30,760.00	31,673.33	42E
L2 Dynamic Panel Van Euro 6D (6.3)												
2900 1.5 (100PS) Turbo D S/S	8D05 i3L2	XiFE	1770	1060	2830	1500	1800	2000	4830	24,725.00	25,638.33	36E
3100 2.0 (145PS) Turbo D S/S	8D05 MQP2	XiFE	1685	1415	3100	1500	1800	2500	5600	25,820.00	26,733.33	39E
3100 2.0 (145PS) Turbo D S/S auto	8D05 MK82	XiFE	1695	1405	3100	1500	1800	2500	5600	27,460.00	28,373.33	41E
L2 Sportive Panel Van Euro 6D (6.3)												
2900 1.5 (100PS) Turbo D S/S	8C05 i3L2	XiFE	1770	1060	2830	1500	1800	2000	4830	26,305.00	27,218.33	36E
3100 2.0 (145PS) Turbo D S/S	8C05 MQP2	XiFE	1685	1415	3100	1500	1800	2500	5600	27,420.00	28,333.33	40E
L2 Elite Panel Van Euro 6D (6.3)												
3100 2.0 (145PS) Turbo D S/S	8E05 MQP2	XiFE	1685	1415	3100	1500	1800	2500	5600	29,925.00	30,838.33	36E

S/S = Start/Stop.

Please note: On-the-road recommended retail prices (RRP) include number plates and delivery to Retailer of £583.33 exc. VAT (£700.00 inc. VAT), 12 months' Vehicle Excise Duty and new vehicle first registration fee of £55.00 (correct at time of publication). Excludes fuel and insurance.

Gross plated weights (including axle weights) quoted on the vehicle plate are to UK plated weight specification and must never be exceeded. Unbraked towing weight 750kg – all models.

*Minimum Mass for standard vehicles include coolant, oil and 90% full fuel tank. They will vary according to the vehicle specification (including trim, options and accessories) with a corresponding variation in payload.

Vivaro Doublecab Prices/Weights

	Pack Code	Orderable Option Code	Minimum Mass (kg)*	Maximum indicative payload (kg)*	Gross Vehicle Weights (GVW) (kg)	Plated weights (kg)		Towing weights (kg) Braked	Plated Gross Combination Weights (GCW) (kg)	Price (£) exc. VAT	On-the-road RRP (£) exc. VAT	Insurance groups
						Front axle	Rear axle					
L2 Dynamic Doublecab Euro 6D (6.3)												
3100 2.0 (145PS) Turbo D S/S	8DC5 MQP2	XiFE	1770	1170	2940	1500	1800	2500	5440	28,915.00	29,828.33	39A
L2 Elite Doublecab Euro 6D (6.3)												
3100 2.0 (145PS) Turbo D S/S	8EC5 MQP2	XiFE	1695	1245	2940	1500	1800	2500	5440	32,395.00	33,308.33	40E
3100 2.0 (145PS) Turbo D S/S auto	8EC5 MK82	XIFE	1741	1259	3000	1500	1800	2500	5500	34,050.00	34,963.33	42E

S/S = Start/Stop.

Please note: On-the-road recommended retail prices (RRP) include number plates and delivery to Retailer of £583.33 exc. VAT (£700.00 inc. VAT), 12 months' Vehicle Excise Duty and new vehicle first registration fee of £55.00 (correct at time of publication). Excludes fuel and insurance.

Gross plated weights (including axle weights) quoted on the vehicle plate are to UK plated weight specification and must never be exceeded. Unbraked towing weight 750kg – all models.

*Minimum Mass for standard vehicles include coolant, oil and 90% full fuel tank. They will vary according to the vehicle specification (including trim, options and accessories) with a corresponding variation in payload.

Vivaro Fuel Economy/Emissions

	WLTP Combined CO ₂ /mpg# - pack code	WLTP Fuel economy mpg (litres/100km)#		CO ₂ (g/km)#	
		Combined Low	Combined High	High	Low
L1 Dynamic Panel Van Euro 6D (6.3)					
2700 1.5 (100PS) Turbo D S/S	175/42.1	39.8 (7.1)	42.8 (6.6)	186	172
2700 1.5 (120PS) Turbo D S/S	178/41.5	39.2 (7.2)	42.1 (6.7)	188	175
2900 1.5 (100PS) Turbo D S/S	175/42.1	39.8 (7.1)	42.8 (6.6)	185	172
3100 2.0 (145PS) Turbo D S/S	194/38.1	37.1 (7.6)	42.1 (6.7)	200	176
3100 2.0 (145PS) Turbo D S/S auto	197/37.6	35.7 (7.9)	38.1 (7.4)	207	194
L1 Sportive Panel Van Euro 6D (6.3)					
2700 1.5 (100PS) Turbo D S/S	175/42.1	40.9 (6.9)	42.8 (6.6)	181	172
2700 1.5 (120PS) Turbo D S/S	177/41.5	40.3 (7.0)	42.1 (6.7)	182	175
2900 1.5 (100PS) Turbo D S/S	175/42.1	40.9 (6.9)	42.8 (6.6)	181	172
3100 2.0 (145PS) Turbo D S/S	194/38.1	37.1 (7.6)	38.7 (7.3)	199	191
L1 Elite Panel Van Euro 6D (6.3)					
3100 2.0 (145PS) Turbo D S/S	195/37.6	37.1 (7.6)	42.1 (6.7)	200	176
3100 2.0 (145PS) Turbo D S/S auto	198/37.1	35.3 (8.0)	37.6 (7.5)	209	196
L2 Dynamic Panel Van Euro 6D (6.3)					
2900 1.5 (100PS) Turbo D S/S	181/40.9	39.2 (7.2)	41.5 (6.8)	188	178
3100 2.0 (145PS) Turbo D S/S	196/37.6	35.7 (7.9)	38.1 (7.4)	206	193
3100 2.0 (145PS) Turbo D S/S auto	199/37.1	35.3 (8.0)	37.6 (7.5)	208	195
L2 Sportive Panel Van Euro 6D (6.3)					
2900 1.5 (100PS) Turbo D S/S	179/41.5	39.8 (7.1)	42.1 (6.7)	186	177
3100 2.0 (145PS) Turbo D S/S auto	195/38.1	36.7 (7.7)	38.7 (7.3)	201	192
L2 Elite Panel Van Euro 6D (6.3)					
3100 2.0 (145PS) Turbo D S/S	197/37.6	35.7 (7.9)	38.1 (7.4)	208	195

WLTP Combined CO₂ (g/km)/Miles Per Gallon (mpg) figures are based on a configured vehicle as per pack code for UK with no options fitted as at 23 November 2021.

S/S = Start/Stop.

#Figures shown are for comparison purposes and should only be compared to the fuel consumption and CO₂ values of other vehicles tested to the same technical standard. The fuel consumption achieved, and CO₂ produced, in real world conditions will depend upon a number of factors including, but not limited to: the accessories fitted (pre and post registration); variations in weather; driving styles and vehicle load. The WLTP (Worldwide Harmonised Light Vehicles Test Procedure) is used to measure fuel consumption and CO₂ figures. The CO₂ figures display a range to reflect the highest value for the highest emitting version with all available options added, through to a minimum value to represent the lowest emitting version in standard specification.

Vivaro Fuel Economy/Emissions

	WLTP Combined CO ₂ /mpg# - pack code	WLTP Fuel economy mpg (litres/100km)#		CO ₂ (g/km)#	
		Combined Low	Combined High	High	Low
L2 Dynamic Doublecab Euro 6D (6.3)					
3100 2.0 (145PS) Turbo D S/S	197/37.6	35.7 (7.9)	37.6 (7.5)	207	195
L2 Elite Doublecab Euro 6D (6.3)					
3100 2.0 (145PS) Turbo D S/S	198/37.1	35.3 (8.0)	37.6 (7.5)	209	197
3100 2.0 (145PS) Turbo D S/S auto	202/36.7	35.3 (8.0)	40.9 (6.9)	210	181

WLTP Combined CO₂ (g/km)/Miles Per Gallon (mpg) figures are based on a configured vehicle as per pack code for UK with no options fitted as at 23 November 2021.

S/S = Start/Stop.

#Figures shown are for comparison purposes and should only be compared to the fuel consumption and CO₂ values of other vehicles tested to the same technical standard. The fuel consumption achieved, and CO₂ produced, in real world conditions will depend upon a number of factors including, but not limited to: the accessories fitted (pre and post registration); variations in weather; driving styles and vehicle load. The WLTP (Worldwide Harmonised Light Vehicles Test Procedure) is used to measure fuel consumption and CO₂ figures. The CO₂ figures display a range to reflect the highest value for the highest emitting version with all available options added, through to a minimum value to represent the lowest emitting version in standard specification.

Safety and Security

Standard Features – The following features are standard across the entire Vivaro range.



Safety

Airbags

- Driver's and front passengers' airbag
- Front passengers' airbag with deactivation switch

Braking

- Four-channel Anti-lock Braking System (ABS) – Prevents the vehicle's wheels from locking up under heavy braking by momentarily reducing brake pressure at the appropriate wheel, ensuring that you can maintain control of the steering
- Emergency brake assist – When emergency braking is detected the vehicle automatically applies the maximum possible braking assistance
- Electronic brakeforce distribution – Automatically apportions the optimum braking force to each wheel
- Hill start assist – Briefly maintains rear brake pressure to stop the vehicle rolling back on an incline

Bulkhead

- Full-height steel bulkhead without window – Standard on Panel Van
- Full-height ABS plastic bulkhead with window – Doublecab only

Stability

- Electronic Stability Programme-plus (ESP-plus) with traction control – Works in conjunction with the vehicle's electronic braking and engine systems to keep the vehicle stable in many different situations. ESP monitors a variety of inputs to determine when the vehicle starts to lose traction, it can then immediately respond by varying the brake pressure between up to three wheels and adjust the engine output to help correct the loss of traction and improve stability

Security

- Electronic engine deadlock immobiliser
- Steering column lock
- Lockable fuel filler/Electric charge flap
- Anti-theft spare wheel cradle

Remote control door locking (features depending on body type)

- Remote control door locking
- Two keys with integral remote
- Door deadlocks
- Selective door locking

Security alarm system

- System monitors doors, tailgate, bonnet and the passenger compartment

VX_VIV_29612

Full-height steel bulkhead.

Safety and Security

Model Specific Features/Options

	Option code*	Electric model		Dynamic	Sportive	Elite
		Dynamic	Elite			
Safety						
Tyre pressure monitoring system	UJO	£50	£50	£50		£50
Full-height steel bulkhead with window – Panel Van	AX9	£150		£150		
Polycarbonate contoured bulkhead – Panel Van	E30	£180		£180		
Security						
Keyless open and start	ATH	£200	£200	£200		£200

*Optional at extra cost excluding VAT.

Driver Assistance

Standard Features – The following features are standard across the entire Vivaro range.
Specific features by model are outlined in the separate tabular information.

Visibility Pack

- Laminated acoustic windscreen
- Rain-sensitive windscreen wipers
- Automatic lighting control

Multi-function trip computer

- Trip odometer
- Vehicle range based on remaining fuel
- Average speed
- Average fuel economy
- Instantaneous fuel economy
- Driving time

Parking distance sensors

- Rear parking distance sensors

Vivaro-e Features

- 3.5-inch digital instrument cluster
- 7.4kW single-phase on-board charger with 6m mode-3 7kW cable (added at POE)

Model Specific Features/Options

	Option code*	Electric model		Dynamic	Sportive	Elite
		Dynamic	Elite			
Driver Assistance						
Floor-mounted handbrake lever				●	●	
Electronic parking brake		●	●			●
Driver Assistance Pack – Lane departure warning/Speed sign recognition with intelligent speed adaptation/High beam assist/Driver drowsiness system/White text Instrument panel	E9A	£320	●	£320		●
Panoramic rear-view camera	UL3	£700	●	£700	£700	●
11kW three-phase on-board charger with mode-3 22kW cable (added at POE)	K29	£300	£300			

*Optional at extra cost excluding VAT.

Convenience

Standard Features – The following features are standard across the entire Vivaro range.
Specific features by model are outlined in the separate tabular information.

Interior Convenience

- Reach and rake-adjustable steering wheel
- Facia-mounted gear lever
- Height-adjustable outer front seatbelts

Cabin Storage

Facia storage

- Upper glovebox
- Open lower glovebox with 12v socket and aux-in facility
- Lower shelf
- A4 storage compartment on top of facia
- Open storage compartments in facia
- Two drinks holders on top of facia
- Storage pocket in front of gear lever

Front door pockets

- Three separate compartments in each door

Heating and Ventilation

- Air conditioning
- Air recirculation facility
- Pollen filter
- Illuminated controls
- Chilled glovebox facility

Model Specific Features/Options

	Option code*	Electric model		Dynamic	Sportive	Elite
		Dynamic	Elite			
Heating and Ventilation						
Electronic climate control – LCD temperature display/Automatic air direction and fan speed with manual override	CJ2	£500	£500	£500		£500
Exterior Convenience						
CANbus interface	WRF			£90		£90

*Optional at extra cost excluding VAT.

Exterior Style and Lighting

Standard Features – The following features are standard across the entire Vivaro range.
 Specific features by model are outlined in the separate tabular information.

Exterior Styling

- Side protection mouldings

Exterior Lighting

- Front fog lights
- Lights-on audible warning
- Reversing lights
- Hazard warning lights
- Rear fog lights
- High-level brake light
- Side-repeat indicators
- Daytime running lights – LED on Sportive/Elite models

Exterior Convenience

Door mirrors

- Foldable electrically adjustable/heated door mirrors

Windows

- Electrically operated front windows with one-touch up/down facility

Model Specific Feature

Model Specific Feature	Option code*	Electric model		Dynamic	Sportive	Elite
		Dynamic	Elite			
Exterior Style						
Appearance Pack – Body-colour front bumper/Body-colour rear bumper (L1 models only)/ Body-colour rear corner bumper with black centre section (L2)/Body-colour side-protection mouldings/Chrome-effect front grille/LED daytime running lights			●		●	●

*Optional at extra cost excluding VAT.

Load Area

Standard Features – The following features are standard across the entire Vivaro range.
Specific features by model are outlined in the separate tabular information.

Load access

Side access – Unglazed

- Nearside sliding side-access door
- Offside sliding side-access door
– Panel Van only

Rear access – Unglazed

- Twin rear doors
- 90°/180° opening

Load Restraint

Load anchorage

- Fixed floor-mounted load restraint lashing eyes
– Six on L1 and 8 on L2 models

Model Specific Features/Options

	Option code*	Electric model		Dynamic	Sportive	Elite
		Dynamic	Elite			
Load Area						
Nearside and offside access – Fixed window to nearside side-access door/ Fixed window to offside side-access door – Standard on Doublecab	8P9	£100	£100	£100	£100	£100
Rear glazed doors – 90°/180° opening/Heated rear windows with wash/wipe facility	J1X	£200	£200	£200	£200	£200
Tailgate – Glazed tailgate/Heated rear windows with wash/wipe facility	J1U	£200	£200	£200	£200	£200
Load Restraint						
Load lining – 6mm untreated wooden load side and wheel arch lining – Panel Van only. Not available when tailgate option is specified. Includes 9mm wooden load floor (CR1)	ERK	£480	£480	£480	£480	£480
9mm coated anti-slip wooden load floor with aluminium rails	CR1	£225	£225	£225	£225	£225

*Optional at extra cost excluding VAT.

Load Area – FlexCargo



Model Specific Feature/Option

	Option code*	Electric model		Dynamic	Sportive	Elite
		Dynamic	Elite			
FlexCargo load-through bulkhead – Dual front passengers’ seat/Load-through bulkhead – Panel Van only	ATM	£425	●	£425	●	●

*Optional at extra cost excluding VAT.

Infotainment

Standard Features

Multimedia with 7-inch touchscreen (IO5)

Standard on Dynamic/Sportive models

Onboard features:

- 7-inch colour touchscreen
- AM/FM stereo radio
- DAB Digital radio
- RDS with Traffic Programme
- Four speakers

Media connections:

- USB connection
- Bluetooth® A2DP audio streaming (Advanced Audio Distribution Profile)

Mobile phone portal:

- Bluetooth® connectivity
- Vehicle microphone
- Phone book access – Contacts/last calls/missed calls etc. are mirrored on the display and are easily navigated using the touchscreen (features dependent on mobile phone)
- Smartphone interface – Apple CarPlay/Android Auto™

Additional feature:

- Flexible roof-mounted aerial

Multimedia Navi Pro with 7-inch touchscreen (IO6)

Standard on Elite models and optional at extra cost on Dynamic models at £350 excluding VAT

Features as Multimedia, with the addition of:

- Satellite navigation system • 2D/3D street level mapping
- European coverage • Points-of-interest search
- Eco routing • Map updates via USB
- Second USB connection
- Three years subscription to TomTom Live*
- On-line navigation services provided by TomTom®
- Vivaro-e shortcut key – Energy flow visualization
 - Energy stats visualization
 - Deferred charging options
 - Thermal pre-conditioning
 - Battery/range check
- Ten speakers

Vauxhall Connect**

e-Call and b-Call:

Help when you need it, 24/7, 365 days a year, that's what you get with new Vauxhall Connect. In an emergency or breakdown, you'll be put in touch with a trained advisor, with just the touch of a button.

Live Navigation Plus and more:

You can also access live navigation services, receive regular vehicle diagnostic info plus there's a host of remote convenience features available through the MyVauxhall app.

- **Peace of mind:** emergency call, breakdown call and regular vehicle status and information
- **Convenience:** remote functions (e.g. lock/unlock the door)
- **Our additional services for electric vehicles:** trip planning, remote settings or public charging solutions – we keep you going!
- **Smart driving:** enjoy a relaxed ride thanks to live navigation and trip management
- **Traffic alerts:** Live Navigation Plus introduces speed camera, traffic light camera and accident hotspot alerts



Please note that compatibility and certain functions may be different depending on the type of device and operating system you're using with the Multimedia systems. Apple CarPlay is a trademark of Apple Inc. Apple and iPhone are trademarks of Apple Inc., registered in the U.S. and other countries. Android is a trademark of Google Inc, also registered in the U.S. and other countries. *Additional terms and conditions apply to connected services, including customer acceptance of location sharing prior to activation. **Services may require a subscription/fee and are subject to mobile network coverage and availability. Standard on Nav models only. Live navigation services are included for 3 years and thereafter are subject to an additional subscription fee.

Seating and Comfort



Steering wheel:

- Three-spoke design
- Satin chrome-effect bezel

Seat trim:

- Curitiba Tritone Grey cloth inert with Carla black vinyl side bolsters

Facia and door trim:

- Mistral Black/Grey

Front seating:

- Driver's seat
 - Height - Reach - Backrest recline
 - Lumbar adjustment
 - Driver's seat armrest
 - Padded head restraint

- Dual front passengers' seat with underseat storage
 - Fixed position bench seat and backrest
 - Height-adjustable padded head restraints

No-cost option - Elite models only:

- Single front passenger's seat (AQR)
 - Reach - Backrest recline
 - Padded head restraint
 - Folding backrest
 - Passenger's seat armrest

Steering wheel:

- Three-spoke design
- Satin chrome-effect bezel

Seat trim:

- Curitiba Tritone Grey cloth

Facia and door trim:

- Mistral Black/Grey

Front seating:

- Driver's seat
 - Height - Reach - Backrest recline
 - Lumbar adjustment
 - Driver's seat armrest
 - Padded head restraint

- Dual front passengers' seat with underseat storage
 - Fixed position bench seat and backrest
 - Height-adjustable padded head restraints

Rear seating - Doublecab:

- Second-row seating
 - Three-individually contoured rear seats
 - Inertia-reel lap and diagonal seatbelts
 - Height-adjustable padded head restraints

Please note: Doublecab rear seating is not equipped with ISOFIX child seat mountings.

Exterior Colours

Jade White (G2o)*
Solid paint



Moonstone Grey metallic (G4o)**
Two-coat metallic paint £500

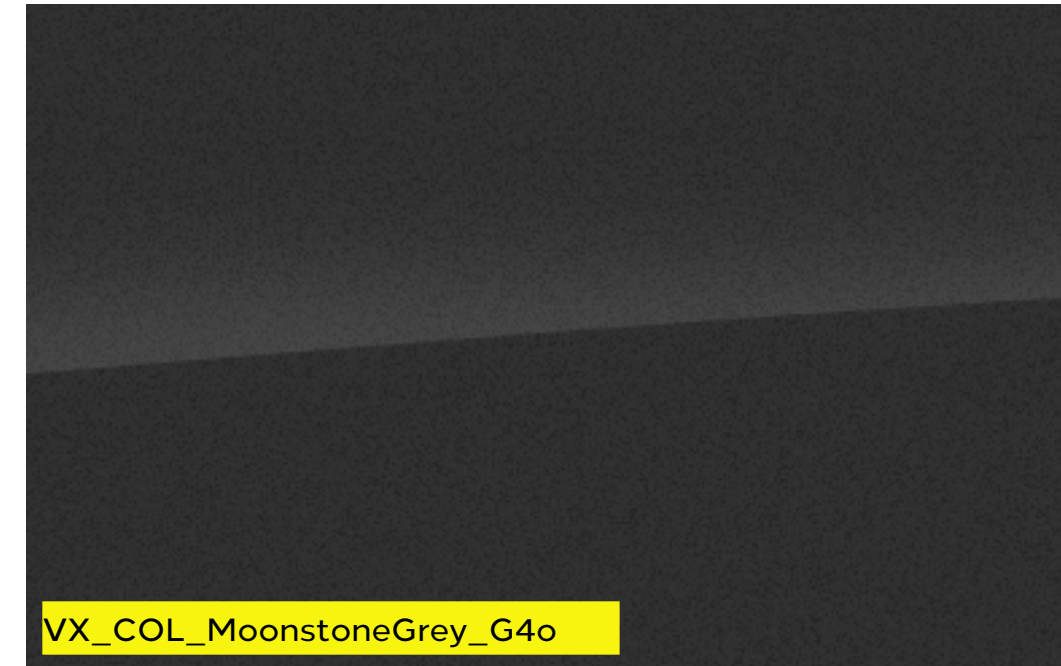

Quartz Silver metallic (G4i)**
Two-coat metallic paint £500

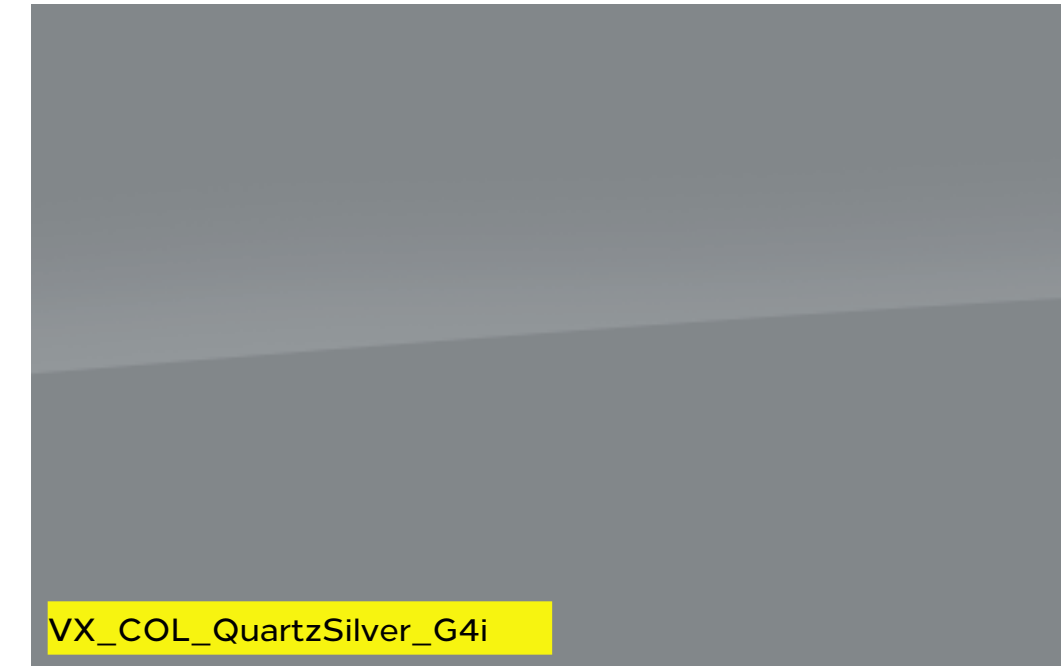

Diamond Black metallic (G7o)**
Two-coat metallic paint £500



Special Colours

Post Yellow (GV4)*
Special Colours **£800**



Post Red (GHU)*
Special Colours **£800**



Genet Yellow (GRT/RAL 1032)*
Special Colours **£800**



Power Blue (GRP)*
Special Colours **£800**



Imperial Blue (GIB)*
Special Colours **£800**



Fire Red (GRR/RAL 3000)*
Special Colours **£800**



Golden Yellow (GRU/RAL 1004)*
Special Colours **£800**



Flaming Red (GEO)*
Special Colours **£800**

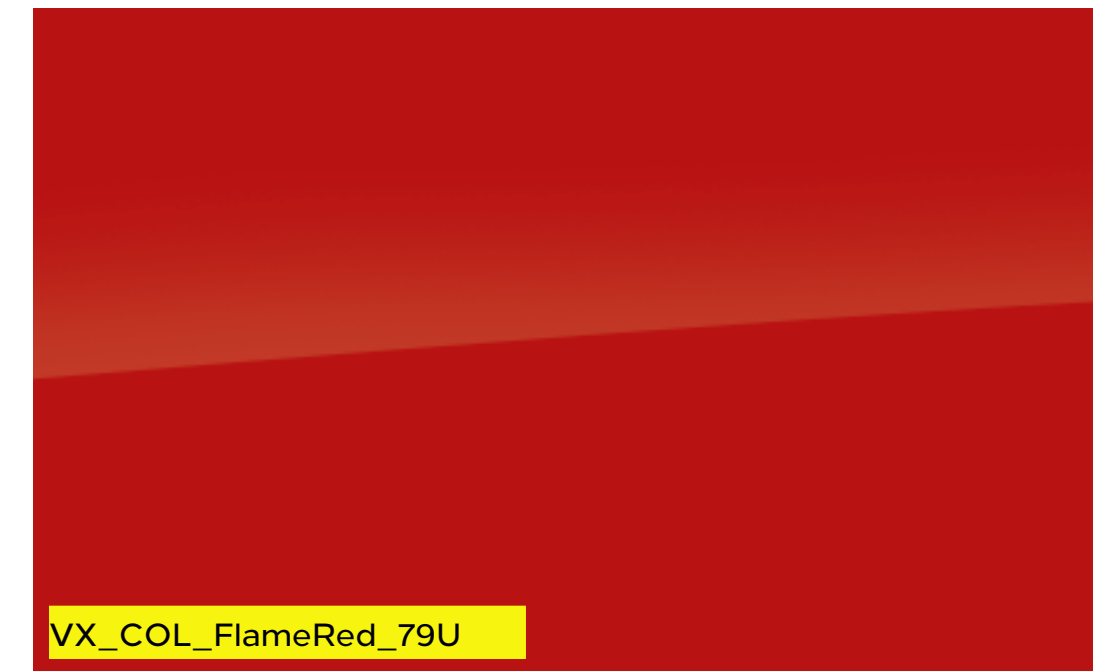

Additional lead-time for special paint will be confirmed at order placement (event 25). Consult Retailer for details.
The colours reproduced may vary slightly from the actual paint colour. As a result they should be used as a guide only.
*Optional at extra cost excluding VAT. Not available on Sportive and Elite models.

Special Colours

Beige Tropic (GCL/RAL 1015)*
Special Colours **£800**



Sky Blue Centrica (GRV)*
Special Colours **£800**



Squid Ink Grey (23U)*
Special Colours **£800**



Additional lead-time for special paint will be confirmed at order placement (event 25). Consult Retailer for details.
The colours reproduced may vary slightly from the actual paint colour. As a result they should be used as a guide only.
*Optional at extra cost excluding VAT. Not available on Sportive and Elite models.

Wheels and Tyres

		Option code*	Electric model		Dynamic	Sportive	Elite
			Dynamic	Elite			
	16-inch steel wheels with centre cap • 215/65 R 16 tyres		●		●		
	16-inch steel wheels with full-diameter wheel trims • 215/65 R 16 tyres	RBK	No-cost		No-cost	●	
	17-inch silver alloy wheels • 215/60 R 17 tyres • Locking wheel bolts	RVF	£400	●	£400		●
	17-inch steel wheels with full-diameter wheel trims • 215/60 R 17 tyres	RVE			£200		
Full-size spare wheel			●	●	●	●	●
Tyre inflation kit in lieu of spare wheel		KTi	No-cost	No-cost	No-cost	No-cost	No-cost

*Optional at extra cost excluding VAT.

Diesel Engines

	1.5 (100PS) Turbo D Start/Stop BlueInjection	1.5 (120PS) Turbo D Start/Stop BlueInjection	2.0 (145PS) Turbo D Start/Stop BlueInjection
Capacity	1499cc	1499cc	1997cc
Maximum power	100PS (75kW) @ 3500rpm	120PS (88kW) @ 3500rpm	145PS (106kW) @ 3750rpm
Maximum torque	270Nm (199lb.ft.) @ 1600rpm	300Nm (221lb.ft.) @ 1750rpm	340Nm (251lb.ft.) @ 2000rpm
Configuration	4 cylinders, 4 valves per cylinder, double overhead camshafts	4 cylinders, 4 valves per cylinder, double overhead camshafts	4 cylinders, 4 valves per cylinder, double overhead camshafts
Fuel/induction system	High pressure turbo-charged direct injection	High pressure turbo-charged direct injection	High pressure turbo-charged direct injection
Emission compliance	Euro 6D (6.3)	Euro 6D (6.3)	Euro 6D (6.3)
Service interval	25,000 miles or 2 years (whichever occurs sooner)	25,000 miles or 2 years (whichever occurs sooner)	30,000 miles or 2 years (whichever occurs sooner)

	2.0 (145PS) Turbo D Start/Stop BlueInjection auto
Capacity	1997cc
Maximum power	145PS (106kW) @ 3750rpm
Maximum torque	370Nm (273lb.ft.) @ 2000rpm
Configuration	4 cylinders, 4 valves per cylinder, double overhead camshafts
Fuel/induction system	High pressure turbo-charged direct injection
Emission compliance	Euro 6D (6.3)
Service interval	30,000 miles or 2 years (whichever occurs sooner)

Vivaro-e Specifications*

Single-speed electronic drive selector

All-electric single speed drive means there is no need for multiple gears. Instead the e-toggle enables the driver to select from the following:

- Park
- Reverse
- Neutral
- Drive
- Braking (for increased regenerative braking)

Drive Mode Selector

The driver can determine the driving style through selecting one of the following modes:

- **Power (136PS):** with high power reserves for the highest top speed and torque. Recommended at full capacity
- **Normal (107PS):** for a balanced drive that offers a compromise between performance and energy efficiency. WLTP range is validated in this mode
- **ECO (80PS):** for maximum range and energy efficiency. The ECO mode deactivates all unnecessary energy-consuming features and reduces the top speed, torque and overall performance

Braking

Energy recuperation

The regenerative braking system works when the van is in motion, energy created by the resistance of the brakes against the drivetrain is converted into DC voltage to partially recharge the battery. The driver can also engage braking mode through the drive selector to increase the level of energy recuperation.

Single foot driving experience

The system not only utilises the energy when the brakes are being used, but also engages when the vehicle is coasting, recovering more energy and enabling single foot driving as the brakes automatically engage when the throttle pedal is released.



Opel_511696

Drivetrain	50kWh	75kWh
CO ₂ emissions g/km	0	0
Maximum power kW/PS	100/136	100/136
Maximum torque Nm/lb. ft.	260/192	260/192
Acceleration 0-62mph (sec)	13.1	14.3
Maximum speed mph	81	81
Transmission	Automatic electric drive with fixed gear ratio	
Service interval	Every 25,000 miles or 2 years (whichever comes sooner). Initial inspection at 12,500 miles or 1 year (whichever comes sooner)	

The Vivaro-e is a battery electric vehicle requiring mains electricity for charging. Range data given has been determined according to WLTP test procedure methodology. The figures shown are intended for comparability purposes only and should only be compared to other cars tested to the same technical standard. The range you achieve under real world driving conditions will depend upon a number of factors, including but not limited to: the accessories fitted (pre and post registration); charging frequency; personal driving style; vehicle load and route characteristics; variations in weather; heating/air conditioning; pre-conditioning and battery condition. For more information, contact your local Vauxhall Retailer.

*Provisional data.

Vivaro-e Specifications*

Charging

Vivaro-e comes fitted with an 7.4kW on-board charger and mode 3 cable. An 11kW on-board charger is available as an extra cost option.

The charging flap's Padlock LED lights up when the cable is correctly plugged in and locked and then acts as a user interface to show the charging status via coloured LED lights:

- **White:** welcome light that helps to light up the area, especially useful in dark conditions
- **Flashing green:** charging in progress
- **Solid green:** charging complete
- **Solid blue:** delayed charging toggled; changes to flashing green when charging commences
- **Solid red:** malfunction

The driver may also choose from two settings:

- **Immediate charging (the standard setting):** Starts charging as soon as the vehicle is docked for charging
- **Delayed charging:** This is especially useful for when cheaper electric rates are desired, e.g. charging at night. Simply enter a charging start time

Please note, EV range assumes that vehicle has been pre-conditioned prior to journey. This function can be accessed either via MyVauxhall App (standard with all Vivaro-e models or with optional Navi Pro). For WLTP definitions see Glossary of Terms.

Charging			
Supply	Socket	Charge Time (0-100%)	
		50kWh battery	75kWh battery
AC current – Domestic 3 pin socket (2.3kW)	Type 2	21h 45m	32h 40m
AC current – Home wallbox or public charger (7kW)	Type 2	7h 30m	11h 20m
AC current – Public charger (11kW)**	Type 2	5h	7h
DC current – Rapid charger (100kW)	CCS	30m (0-80%)	45m (0-80%)

Battery	50kWh	75kWh
AC on-board charger speed (standard)	7.4kW	7.4kW
WLTP Range (Combined)	132-133 miles	185-196 miles
WLTP Range (City)	194-196 miles	246-267 miles
Energy consumption (Combined low/high)	25.8-26.0kWh/100km	26.8-28.4kWh/100km
Battery warranty	8 years/100,000 miles/70% capacity	



The Vivaro-e is a battery electric vehicle requiring mains electricity for charging. Range data given has been determined according to WLTP test procedure methodology. The figures shown are intended for comparability purposes only and should only be compared to other cars tested to the same technical standard. The range you achieve under real world driving conditions will depend upon a number of factors, including but not limited to: the accessories fitted (pre and post registration); charging frequency; personal driving style; vehicle load and route characteristics; variations in weather; heating/air conditioning; pre-conditioning and battery condition. For more information, contact your local Vauxhall Retailer.

*Provisional data. **Requires optional 11kW on board charger.

Specifications

Transmission

Six-speed manual gearbox:

- Front-wheel drive
- Transverse engine/gearbox

Eight-speed automatic transmission:

- Front-wheel drive
- Transverse engine/gearbox

By simply twisting the dial, the following modes can be selected:

- Park, for when the vehicle is stationary and the wheels are locked
- Drive, for automatic forward motion
- Neutral, for when the vehicle is stationary, wheels are free
- Reverse, for automatic backward motion

For an extra experience of dynamism, the shift paddles for automatic transmissions are located behind the steering wheel, offering drivers an extra level of control that is highly ergonomic and intuitive. The shift paddles function in the following way:

- To go up a gear, the driver must pull the right lever towards themselves
- To go down a gear, the driver must pull the left lever towards themselves – Please note: only consecutive gear changes are possible

Steering

- Hydraulic power-assisted rack and pinion system
- Energy absorbing steering column
- Turning circle (kerb-to-kerb): 12.4m (40.7ft.)

Brakes

Front ventilated disc brakes: 304mm x 28mm
Rear disc brakes: 290mm x 12mm

Fuel tank capacity

- 70 litres (15.4 gallons)

AdBlue® tank capacity

- 22.5 litres (4.95 gallons)

Start/Stop technology

Vivaro Start/Stop system, fitted as standard to all models offers real benefits by improving fuel economy and reducing CO₂ emissions, particularly in town. It does this by automatically stopping the engine when you come to a standstill, and then restarting as you prepare to move off.

Before automatically stopping the engine a number of system checks are carried out to ensure that it is both safe and practical to do so. To ensure safety, the driver must depress the clutch pedal, shift in to neutral, and then release the clutch pedal. System checks carried out before Auto Stop activates include:

- Start/Stop system is not manually deactivated via the facia button
- Sufficient brake vacuum is available to prevent the car rolling down an incline
- Battery is in good condition and charged
- Outside air temperature and engine temperature are above specified minima
- Electronic climate control (where fitted) is not in maximum heating or maximum cooling mode
- Self-cleaning function of the diesel particulate filter is not active

If all of these conditions are satisfied then the vehicle will Auto Stop.

When you are ready to pull away from standstill, Auto Restart is activated by depressing the clutch pedal.

Whilst at a standstill the vehicle is continually monitored.

If necessary, the engine will automatically be restarted.

Conditions that would initiate an Auto Restart include:

- Low battery level
- Brake vacuum below specified minimum
- Start/Stop system is manually deactivated
- Stationary for 5.5 minutes

Dimensions and Capacities

All measurements in mm (inches) unless stated otherwise. Heights shown unladen.

Loadspace Dimensions	L1	L2
Maximum length at load floor – Panel Van*	2512 (98.9)	2862 (112.7)
Mid-height load length – Panel Van	2185 (86.0)	2535 (99.8)
Maximum length with load-through facility maximum length to front footwell – Panel Van	3674 (144.6)	4024 (158.4)
Maximum length at load floor – Doublecab	–	2365 (93.1)
Mid-height load length behind rear seats – Doublecab	–	1700 (66.9)
Maximum width	1636 (64.4)	1636 (64.4)
Width between wheel arches	1258 (49.5)	1258 (49.5)
Maximum height	1397 (55.0)	1397 (55.0)
Loadspace Access		
Side door aperture height	1241 (48.8)	1241 (48.8)
Side door aperture width	935 (36.8)	935 (36.8)
Rear door aperture height	1220 (48.0)	1220 (48.0)
Rear door aperture width	1282 (50.5)	1282 (50.5)
Loading height – Maximum	613 (24.1)	633 (24.9)
Loading height – Minimum	544 (21.4)	600 (23.6)
Loadspace Volumes cu.m (cu.ft.)		
Panel Van	5.3 (187.2)	6.1 (215.4)
Panel Van with load-through facility	5.8 (204.8)	6.6 (233.1)
Doublecab	–	4.0 (141.3)

*Maximum load floor length along centre can be impacted by rear door locking mechanism – approximately 50mm.

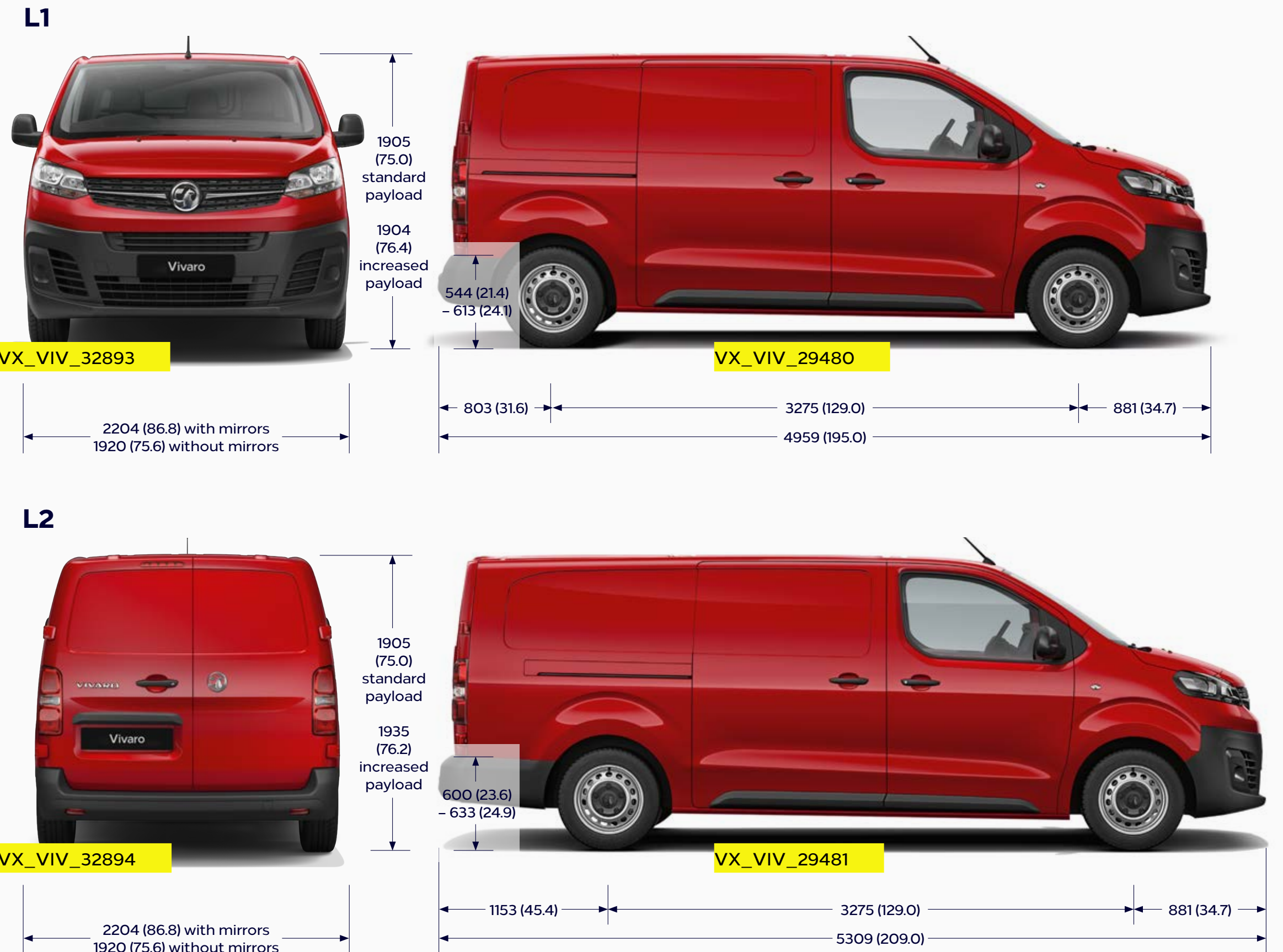

Vivaro-e is the same dimensions as Vivaro with following differences only:

- Ground clearance + 20 mm versus diesel models
- Loading sill height @ kerbweight is similar to diesel models
- Loading sill height @ GVW + 20 mm versus diesel models

Accessories

Safety	Total (exc. VAT)
Safety kit (first aid kit, hi-vis vest and warning triangle)	£13
Warning triangle	£8
First aid kit	£13
Hi-vis safety vest	
– Adult	£4
– Child 3-6 years (42cm)	£3
– Child 7-12 years (52cm)	£3
Emergency seat belt cutter and hammer	£16
Philips ADR620 dash cam	£91
Front parking sensors	£325
Rear parking sensors	£339
Front foglight kit	£460
Alarm system ¹	£381
Anti-lift module for alarm system	£120
VHF volumetric sensor for alarm system	£139
Fire extinguisher with strap	
– 1kg	£19
– 2kg	£27
Comfort	
Fragrance diffuser	£20
Fragrance cartridge	£15
Front wind deflectors	£69
Cup holder organisers	£7-8
Smokers pack	£44
USB Charger – 2 front and 2 rear ports	£23
Practical	
All weather rubber front floor mat	£71
Seat covers	
– Driver seat and single passenger seat	£146
Splash guards (set of 2) – Front	£53
Splash guards (set of 2) – Rear ²	£56
Rear bumper protector ²	£31

Interior protection	Total (exc. VAT)
Wooden floor protection – 2 sliding doors	
– L1	£288
– L2	£299
– L3	£322
Wooden interior side protection – 2 sliding doors	
– L1	£324
– L2	£369
– L3	£382
Wooden wheel arch protection	
– L1/L2/L3	£86
Premium wooden floor protection	
– 2 sliding doors	
– L1	£304
– L2	£333
– L3	£371
Premium wooden interior side protection	
– 2 sliding doors	
– L1	£376
– L2	£388
– L3	£452
Premium wooden wheel arch protection	
– L1/L2/L3	£98
Polypro floor protection – 2 sliding doors	
– L1	£362
– L2	£391
– L3	£429
Polypro Interior side protection – 2 sliding doors	
– L1	£376
– L2	£388
– L3	£452
Polypro wheel arch protection	
– L1/L2/L3	£98

Transport solutions	Total (exc. VAT)
Aluminium roof bar single (2 or 3 needed)	£125
Steel roof rack	
– L1	£1,078
– L2	£1,160
– L3	£1,244
Aluminium roof rack	
– L1	£1,522
– L2	£1,693
– L3	£1,792
Rear door aluminium ladder	£271
Roof carriers	
Thule ladder tilt 311	£511
Thule ladder holder 330	£119
Thule ladder roller 335	£55
Thule front load stop system (side profiles)	£130
Thule front load stop system 321 (front)	£83
Thule ratchet tie down strap	£14
Thule fold down load stop 315	£52
Thule square bar adapter	£18
Towing	
Tow bar with removable tow ball ³	£392
Tow bar with removable swan's neck tow ball ³	£276
Tow bar without tow ball ³	£276

Style	Total (exc. VAT)
5 speed gear lever knob	
– Black chrome/black leather	£63
– Chrome/black leather	£63
6 speed gear lever knob	
– Satin chrome	£58
Electric	
Mode 2 emergency charging cable (Type G – UK domestic plug)	£487
Mode 3 charging cable	
– 7.4kW	£276
– 11kW	£309
– 22kW	£365
Cable bag	£41
Mode 2 universal charger UK kit (22kW)	£1,296
Accessories for universal charger	
– Wall bracket	£88
– Bag	£54
– Safety lock	£17
– Adapter type 2	£265
– Adapter type 3c	£298
– Adapter (various)	£100

Please note: Prices shown are fully fitted and painted, where applicable and exclude VAT. Please check with your local Vauxhall Retailer for details. It is advisable to ensure your insurance policy is adequate to cover additional fitted accessories. Prices correct at time of publication.

¹Additional parts may be required for fitting alarm system dependent on model. Please consult your local Vauxhall Retailer for details. ²Excludes L1. ³Additional fixing kit required for Platform Cab vehicles.

Glossary of Terms

Plated weight

The maximum weight to which a vehicle or an axle may be loaded, determined either by the design of the components or by legislation. All commercial vehicles must carry a manufacturer's 'plate' showing the vehicle and axle gross 'plated weights'. It is an offence to drive a vehicle in a condition where any of these weights are exceeded.

Minimum Mass

Minimum Mass ('Mass in running order' on Certificate of Conformity and 'Mass in Service' on V5C form) is defined according to European Type Approval and include all fluids, tools and 90% fuel load. It is minimum mass for this variant and does not consider local specification/trim or deletable options (specific to Movano). Weights are also subject to manufacturing tolerances (EU Legislation allows 5% tolerance).

Gross Vehicle Weight (GVW)

The total permissible weight of a vehicle including payload and passengers, as shown on the manufacturer's plate.

Gross Combination Weight (GCW)

The maximum permissible weight of a vehicle, including payload and passengers, combined with the total weight of any trailer it is towing. The maximum GCW weight limit is quoted on the vehicle plate and must not be exceeded.

Payload

The total permissible weight that can be carried without exceeding the vehicle's plated weight. Payload do not include driver but do take into consideration specification/trim level:

Weights are also subject to manufacturing tolerances (EU Legislation allows 5% tolerance). Payload does not consider any additional options that a customer may order.

Roof loads

- Vivaro roof load should not exceed 170kg including the weight of the roof rack/carrier

Maximum towing weight

The maximum weight of any trailer and its load which may be towed within the limit of the vehicle's plated Gross Combination Weight (GCW). It is based on the ability of the vehicle – at full GCW – to restart on a 12% gradient, which is approximately 1 in 8.3, at sea level. At altitudes above 1500 metres, the engine output may drop with a corresponding reduction in towing capability. It is the operator's responsibility to ensure that the trailer noseweight does not cause the rear axle plated weight of the towing vehicle to be exceeded.

Always fit Vauxhall towing attachments and accessories available from your Vauxhall Commercial Vehicle Retailer. They are designed specifically for Vauxhall models and carry a 12-month warranty.

Conversions

A new conversion portal has been introduced. This significantly improves the transparency and response of all communication with body-builders, and converters: converters-and-groupe-psa.com

This website contains complete technical guidelines necessary to convert Vauxhall commercial vehicles – Combo (eK9/K9); Vivaro (eKO/KO); Movano (eX250/X250).

- Conversion Guidelines
- 2D Drawings
- 3D CAD
- WLTP Range/Emission Calculator
- Technical Questions
- Conversion Approval including LONO

Any converter of Vauxhall product should create an account on this portal including those using IVA as approval process. In fact WLTP will make this necessary.

Glossary of Terms

Commercial Vehicle Categories

Differences between M1/N1 and M2/N2 (Vehicles with GVW above 3500kg)

Category M: Passenger carriers

Category M1: Vehicles designed and constructed for the carriage of passengers and comprising no more than eight seats in addition to the driver's seat.

Category M2: Vehicles designed and constructed for the carriage of passengers, comprising more than eight seats in addition to the driver's seat, and having a maximum mass not exceeding 5 tonnes.

Category N: Goods vehicles

Category N1: Vehicles designed and constructed for the carriage of goods and having a maximum mass not exceeding 3.5 tonnes.

Category N2: Vehicles designed and constructed for the carriage of goods and having a maximum mass exceeding 3.5 tonnes but not exceeding 12 tonnes.

Specific differences, all M2/N2 require the following:

Speed limiter: All M2/N2 vehicles are legally required to be speed limited. M2 to 62mph and N2 to 56mph.

Driver licence: Commercial vehicles with GVW greater than 3.5 tonnes have different license requirements. For any new drivers C1 category is necessary. Under some circumstances (social purposes for a non-commercial body) it is possible to drive a minibus without a D1 entitlement (Minibus) however eligibility for this exemption should be confirmed with DVSA.

Driver CPC: Driver Certificate of Professional Competence mandates 35 hours of periodic training every 5 years to maintain licence (from September 2014).

Tachograph: It is a legal requirement to administer the activities of drivers subject to the EU or AETR drivers' hours rules, and also record the vehicle's speed, distance and time. A Smart Card is required for digital tachograph and these are available from the DVLA. The tachograph of a new vehicle must be calibrated within two weeks of first registration.

Operator's Licence: This may also be required to ensure that vehicles are kept safe and in good condition at all times. Specifically for M2, PSV (public service vehicle) operator's licence is required. Exemptions in some circumstances may be permitted but this should always be confirmed with DVSA.

MOT Testing: M2/N2 must be tested each year, and vehicle presented with a completed Certificate of Conformity (CoC). This is available from Vauxhall (regdata@gm.com) or from converter in case of second-stage conversion.

WLTP (Worldwide harmonized Light-duty vehicles Test Procedure)

The test consists of four cycles:

- Low – City centre driving (maximum speed 35mph)
- Medium – Suburban driving (maximum speed 50mph)
- High – Rural driving (maximum speed 60mph)
- Extra-High – Motorway driving (Maximum speed 81mph)

Combined range consists of all four cycles and City range is the first two cycles only (Low and Medium).

Further Information

Vauxhall on-the-road recommended retail prices (RRP)

To eliminate uncertainty about hidden costs incurred when buying a new commercial vehicle, Vauxhall publishes on-the-road prices and these are shown in the pricing tables within this price guide. The prices shown are manufacturer's recommended retail prices (RRP) unless otherwise stated, exclusive of VAT (currently at a rate of 20% which may be payable). These prices include the recommended cost of number plates, delivery to a Vauxhall Retailer of £583.33 (£700.00 including VAT), 12 months' Government Vehicle Excise Duty* and the DVLA new vehicle first registration fee of £55.00*.

Please note: The RRP does not include fuel supplied by the Retailer, motor insurance or any other goods or services supplied by agreement between the Retailer and customer.

Price protection

Order a new Vauxhall for build in the current model year (as confirmed by your Retailer) for delivery no more than three months in advance and the price you are quoted is the price you pay. This is irrespective of any subsequent price rises between placing your order and delivery of your new car, but you must take delivery as soon as the car is available.

Please note: Price protection does not apply to electric/hybrid models. Vauxhall Motors Limited is not liable for price adjustments caused by Government changes in the rate of VAT (currently 20%), Vehicle Excise Duty, DVLA new vehicle first registration fee or by any other applicable legislation or regulations.

In the event of an accident...

Vauxhall Accident Management helps keep you mobile following an accident. Benefits include vehicle recovery, Vauxhall-approved repairs and contacting your insurer. For more details, visit vauxhall.co.uk/AccidentManagement

Vehicle Excise Duty

The amount of Vehicle Excise Duty (road fund licence) payable on new commercial vehicles varies depending on gross vehicle weight (GVW) and European standard emissions compliance, as shown below*.

Up to 3500kg GVW	£275.00
Over 3500kg GVW	£165.00

*Correct at time of publication.

Customer Care Commitment

For added peace of mind, Vauxhall has an innovative Customer Care Commitment** that offers the following:

- Three-year vehicle warranty consisting of a one-year/unlimited mileage manufacturer's warranty and a second and third year manufacturer's warranty with a 100,000 miles limitation
- Vauxhall Assistance for 12 months from first registration
- Five years' body panel anti-perforation warranty

**Warranty is only on vehicles sourced from Vauxhall Motors Limited. Terms and conditions apply – please see your Vauxhall Retailer for details.

Vauxhall Assistance

Vauxhall Assistance is provided Automatically with every new Vauxhall Commercial Vehicle for 12 months from first registration and covers everything from accidents, mechanical breakdown to flat tyres. With Vauxhall Assistance help is literally just a free[†] phone call away, 24 hours a day, 365 days a year!

[†]Mobile phone users will be charged at their standard tariff.

Vauxhall Extended Warranty

For complete peace of mind Vauxhall offers an extended warranty that can be purchased on an annual basis following the expiry of the original new vehicle warranty. It covers most mechanical

and electrical components. Terms and conditions apply, for further details please contact your local Vauxhall Retailer.

Protecting the environment

Our products are increasingly winning environmental awards, both through the use of more recycled materials and by becoming cleaner and more efficient. For information on Vauxhall's efforts to achieve an environmentally sustainable future, including information on Design for Recycling, take-back of End-of-Life Vehicles (ELVs), and the recycling of ELVs, see vauxhall.co.uk/recycling

Van Business Centres

Keeping your van on the road. We know how important your van is to you, that's why we're geared up to minimise your downtime.

Our nationwide Van Business Centres provide fast, convenient value for money servicing, repairs and MOTs.

- All work is carried out by Vauxhall trained technicians using only genuine parts
- No appointments are required for diagnosis and we offer a 'while you wait' service

We have all the expertise required and will spare no effort to get you back in business as soon as possible.

Vauxhall Service Plan

Vauxhall Retailers offer a great service for owners of all Vauxhall vehicles. Value for money, regular offers and free check-ups, combined with the peace of mind that comes from using Vauxhall-trained technicians and genuine parts, help keep your vehicle in peak condition at all times. Every Vauxhall Retailer supports our customer promise:

We are Vauxhall experts

- Fully Vauxhall-trained technicians
- We use Vauxhall approved diagnostic equipment and specialist tools
- Full access to Vauxhall repair databases and technical centres

We are transparent

- Our invoicing will clearly set out the work at the price agreed with no hidden extras

We are never beaten on price

- We will match any written like for like service/repair quote from a local^{††} competitor using genuine repair methods and parts

We are convenient

- Flexible booking times to suit you
- 'One-stop shop' for every type of Vauxhall service
- While you wait facility on stocked tyres, batteries and exhausts
- Free courtesy vehicle or local collection with annual services and warranty work

We are thorough

- 25 point safety check with any workshop visit
- No obligation advice on essential and non-essential work
- Free check for safety enhancements and upgrades to your vehicle and software
- Free 'Wash and Vac' with every annual service
- Free fitting of wipers and external bulbs with annual services

^{††}A radius of five miles/20 minutes from your Vauxhall Retailer.

For more product information

For further information on the Vauxhall range or location of your nearest Vauxhall Retailer please call **0345 600 1500**. Alternatively, details can be found on our website at vauxhall.co.uk

For more information call **0345 600 1500**

Discover the full Vauxhall range at **[vauxhall.co.uk](https://www.vauxhall.co.uk)**

Join us online

The invoice price, including delivery to Retailer, factory-fitted options, accessories fitted by the Retailer and number plates, is subject to VAT. Some feature descriptions in this guide may refer to, and some illustrations may show, optional equipment not included in the standard delivery. The information contained in this guide was accurate at the time of publication. We reserve the right to make changes in design and equipment. Please note that Vauxhall Retailers are not the agents of Vauxhall Motors Limited and are not authorised to bind Vauxhall Motors Limited by any specific or implied undertaking or representation. It is advisable to ensure that your motor insurance policy provides adequate cover for additional fitted options and accessories. The colours in this guide are only approximate actual colours. Illustrated optional equipment is available at extra charge. Availability, technical features and equipment provided on our vehicles can vary by model. For precise information on the equipment provided on our vehicles, please contact your local Vauxhall Retailer.

VAUXHALL

Price and Specification Guide
17 December 2021 | Model Year 2022A



New Movano

Including Movano-e Range

Contents

To find the information you want use the links below to navigate around the guide:

[Choose Your Body Variant](#)

[Range Highlights](#)

[Models](#)

[Prices and Weights](#)

[Fuel Economy and Emissions](#)

[Options](#)

[Exterior Colours](#)

[Wheels and Tyres](#)

[Movano-e Specifications](#)

[Dimensions and Capacities](#)

[Glossary of Terms](#)

[Further Information](#)

Choose Your Body Variant

Panel Van – L2 models



VX_MOV_32228.psd

L2 H1 F3500



VX_MOV_32229.psd

L2 H2 F3500

Panel Van – L3 models



VX_MOV_32233.psd

L3 H2 F3500



VX_MOV_32233.psd

L3 H2 F3500/F3500 Heavy



VX_MOV_32231.psd

L3 H3 F3500

Glazed Panel Van



VX_MOV_33138.psd

L3 H2 F3500

Panel Van – L4 models



VX_MOV_32230.psd

L4 H2 F3500



VX_MOV_32230.psd

L4 H2 F3500 Heavy/F4000 Heavy



VX_MOV_32232.psd

L4 H3 F3500 Heavy

Glazed Panel Van



VX_MOV_33139.psd

L4 H2 F4000

Chassis Cab



VX_MOV_32234.psd

L2 H1 F3500



VX_MOV_32235.psd

L3 H1 F3500

Crew Cab



VX_MOV_32236.psd

L3 H1 F3500

New Movano Range Highlights

Edition

Standard features include:

- Radio
 - AM/FM/DAB digital radio
 - Bluetooth®
 - USB connection
 - Roof mounted aerial
- Vauxhall Connect
- 15-inch steel wheels with centre caps (3500 models)
- 16-inch steel wheels with centre caps (3500 Heavy/4000 models)
- Full-size spare wheel
- Side-repeat indicators
- Steering wheel mounted controls
- Steering column adjustable for reach
- Electronic cruise control with speed limiter
- Electrically adjustable/heated door mirrors with twin lenses
- Manually foldable door mirrors
- Electrically operated front windows
- Nearside sliding side-access door
- Twin unglazed rear doors
- Driver's airbag
- Electronic stability programme
- Remote control security alarm system
- Hill start assist
- Full-height steel bulkhead
- Daytime running lights
- Remote control central deadlocking
- Six-way adjustable driver's seat
- Dual passenger's bench seat
- Seatbelt unfastened warning
- Two cupholders/phone storage
- 12-volt accessory socket in cabin

New Movano-e Dynamic/Dynamic

Features over Edition models:

- Satellite Navigation system
 - 5-inch colour touchscreen
 - USB charger
- Air conditioning
- Rear parking distance sensors
- Glovebox including air-conditioning cooling functionality
- Document holder

Please note: Movano-e Dynamic models do not include Vauxhall Connect.

Edition Chassis/Chassis Crew Cab

Chassis Cab and Chassis Crew Cab models provide the perfect base for the forthcoming factory-backed conversions due to be announced in Q4: Tipper, Dropside, Luton Van and Curtainsider. They also provide an excellent base for a wide variety of specialist body conversions

Chassis Crew Cabs additionally feature:

- Four passenger rear bench seat with underseat storage

New Movano-e Dynamic



Dynamic OTR from £56,723.33*

Infotainment:

- Satellite Navigation system
 - 5-inch colour touchscreen
 - AM/FM/DAB digital radio
 - Bluetooth®
 - USB connection/charger
 - Roof mounted aerial

Interior convenience/styling:

- Air conditioning
- Six-way driver's seat with lumbar adjustment
- Driver's seat armrest
- Dual passenger's bench seat
- Glovebox including air-conditioning cooling functionality
- Document holder
- Electronic cruise control
- Speed limiter
- Steering wheel mounted controls
- Steering column adjustable for reach
- 12-volt accessory socket in cabin

Exterior convenience/styling:

- Rear parking distance sensors
- Electrically adjustable/heated door mirrors with twin lenses
- Manually foldable door mirrors
- Electrically operated front windows
- Nearside sliding side-access door
- Twin unglazed rear doors
- 16-inch steel wheels with centre caps
- Full-size spare wheel
- Side-repeat indicators

Safety/security:

- Remote control security alarm system
- Driver's airbag
- Electronic stability programme
- Hill start assist
- Full-height steel bulkhead
- Daytime running lights
- Remote control central deadlocking
- Seatbelt unfastened warning

Please note: Movano-e Dynamic models do not include Vauxhall Connect.

*Price shown is after allowing for PiVG (Plug-in Van Grant) and excludes VAT.

New Movano Edition



VX_MOV_32200.tif

Edition OTR from £31,633.33*

Infotainment:

- Radio
 - AM/FM/DAB digital radio
 - Bluetooth®
 - USB connection
 - Roof mounted aerial
- Vauxhall Connect

Interior convenience/styling:

- Six-way adjustable driver's seat
- Dual passenger's bench seat
- Electronic cruise control
- Steering wheel mounted controls
- Steering column adjustable for reach
- Two cupholders/phone storage
- 12-volt accessory sockets in cabin/load area

Exterior convenience/styling:

- Electrically adjustable/heated door mirrors with twin lenses
- Manually foldable door mirrors
- Electrically operated front windows
- Nearside sliding side-access door
- Twin unglazed rear doors
- 15-inch steel wheels with centre caps (3500 models)
- 16-inch steel wheels with centre caps (3500 Heavy/4000 models)
- Full-size spare wheel
- Side-repeat indicators

Safety/security:

- Remote control security alarm system
- Driver's airbag
- Electronic stability programme
- Hill start assist
- Full-height steel bulkhead
- Daytime running lights
- Remote control central deadlocking
- Seatbelt unfastened warning

Chassis Crew Cab OTR from £28,853.33*

Chassis Crew Cabs additionally feature:

- Four passenger rear bench seat with underseat storage

*OTR price excluding VAT.

New Movano Dynamic



VX_MOV_32197.tif

Dynamic OTR from £33,453.33*

Infotainment:

- Satellite Navigation system
 - 5-inch colour touchscreen
 - AM/FM/DAB digital radio
 - Bluetooth®
 - USB connection/charger
 - Roof mounted aerial
- Vauxhall Connect

Interior convenience/styling:

- Air conditioning
- Six-way driver's seat with lumbar adjustment
- Driver's seat armrest
- Dual passenger's bench seat
- Glovebox including air-conditioning cooling functionality
- Document holder
- Electronic cruise control
- Speed limiter
- Steering wheel mounted controls
- Steering column adjustable for reach
- Two cupholders/phone storage
- 12-volt accessory sockets in cabin/load area

Exterior convenience/styling:

- Rear parking distance sensors
- Electrically adjustable/heated door mirrors with twin lenses
- Manually foldable door mirrors
- Electrically operated front windows
- Nearside sliding side-access door
- Twin unglazed rear doors
- 15-inch steel wheels with centre caps (3500 models)
- 16-inch steel wheels with centre caps (3500 Heavy/4000 models)
- Full-size spare wheel
- Side-repeat indicators

Safety/security:

- Remote control security alarm system
- Driver's airbag
- Electronic stability programme
- Hill start assist
- Full-height steel bulkhead
- Daytime running lights
- Remote control central deadlocking
- Seatbelt unfastened warning

*OTR price excluding VAT.

New Movano-e Panel Van Prices/Weights (Provisional data)

	Model/ Pack Code	Orderable Option Code	Minimum Mass (kg)*	Maximum indicative payload (kg)*	Gross Vehicle Weights (GVW) (kg)	Plated weights (kg)		Price (£) exc. VAT	On-the-road RRP before PiVG (£) exc. VAT	On-the-road RRP after PiVG (£) exc. VAT
						Front axle	Rear axle			
L3 H2 Dynamic Panel Van										
3500 90kW (120PS) auto Heavy – 70kWh battery	XG05 9DQ1	IM5L G02	2760	710	3500	2100	2400	61,085.00	61,723.33	56,723.33
L4 H2 Dynamic Panel Van										
3500 90kW (120PS) auto Heavy – 70kWh battery	XG05 9DQ1	IM7K G02	2855	665	3500	2100	2400	61,985.00	62,623.33	57,623.33

Please note: On-the-road recommended retail prices (RRP) include number plates and delivery to Retailer of £583.33 exc. VAT (£700.00 inc. VAT) and new vehicle first registration fee of £55.00 (correct at time of publication). Excludes fuel and insurance. Price has been calculated using manufacturer estimates and includes an OZEV grant of up to £5,000.00 which has been deducted from the price of the vehicle (OZEV Grant not available in the Isle of Man). New Movano-e is expected to be a qualifying model for this grant subject to acceptance by OZEV. Please check with your Retailer for latest status. The grant is a government incentive and is subject to withdrawal prior to delivery of your vehicle. Retailers may be required to carry out more than one credit check during the course of the order process. You may be required to place a deposit when placing your order with your supplying Retailer. In the event of a price change, deposit refunds will be governed by your supplying Retailer's policy and as such must be discussed with the supplying Retailer.

*For definitions please refer to Glossary of Terms. Gross plated weights (including axle weights) quoted on the vehicle plate are to UK plated weight specification and must never be exceeded.

Movano-e is not covered by our Price Protection Guarantee. See 'Further Information' page for details.

New Movano Panel Van Prices/Weights (Provisional data)

	Model/ Pack Code	Orderable Option Code	Minimum Mass (kg)*	Maximum indicative payload (kg)*	Gross Vehicle Weights (GVW) (kg)	Plated weights (kg)		Towing weights (kg) Braked	Plated Gross Combination Weights (GCW) (kg)	Price (£) exc. VAT	On-the-road RRP (£) exc. VAT
						Front axle	Rear axle				
L2 H1 Edition Panel Van Euro 6D (6.3)											
3500 2.2 (140PS) Turbo D	XA05 PQ61	IM3F G01	2133	1570	3500	1870	2000	2500	6000	30,720.00	31,633.33
L2 H2 Edition Panel Van Euro 6D (6.3)											
3500 2.2 (140PS) Turbo D S/S	XA05 PQ61	IM3K G01	2138	1545	3500	1870	2000	2500	6000	31,500.00	32,413.33
L2 H2 Dynamic Panel Van Euro 6D (6.3)											
3500 2.2 (140PS) Turbo D S/S	XA05 PQ61	IM3K G02	2138	1545	3500	1870	2000	2500	6000	32,540.00	33,453.33
L3 H2 Edition Panel Van Euro 6D (6.3)											
3500 2.2 (140PS) Turbo D S/S	XA05 PQ61	IM5K G01	2188	1495	3500	1870	2000	2500	6000	32,280.00	33,193.33
3500 2.2 (140PS) Turbo D S/S Heavy	XA05 PQ61	IM5L G01	2228	1455	3500	2100	2400	3000	6500	32,575.00	33,488.33
L3 H2 Edition Glazed Panel Van Euro 6D (6.3)											
3500 2.2 (140PS) Turbo D S/S	XB05 PQ61	IM5W G01	2188	1495	3500	1870	2000	2500	6000	32,580.00	33,493.33
L3 H2 Dynamic Panel Van Euro 6D (6.3)											
3500 2.2 (140PS) Turbo D S/S	XA05 PQ61	IM5K G02	2188	1495	3500	1870	2000	2500	6000	33,320.00	34,233.33
3500 2.2 (140PS) Turbo D S/S Heavy	XA05 PQ61	IM5L G02	2228	1455	3500	2100	2400	3000	6500	33,615.00	34,528.33
3500 2.2 (165PS) Turbo D S/S	XA05 PR61	IM5K G02	2188	1495	3500	1870	2000	2500	6000	34,210.00	35,123.33
L3 H3 Edition Panel Van Euro 6D (6.3)											
3500 2.2 (140PS) Turbo D S/S	XA05 PQ61	IM5N G01	2213	1470	3500	1870	2000	2500	6000	33,060.00	33,973.33
L3 H3 Dynamic Panel Van Euro 6D (6.3)											
3500 2.2 (140PS) Turbo D S/S	XA05 PQ61	IM5N G02	2213	1470	3500	1870	2000	2500	6000	34,100.00	35,013.33
L4 H2 Edition Glazed Panel Van Euro 6D (6.3)											
4000 2.2 (140PS) Turbo D S/S Heavy	XB05 PQ61	IM7Y G02	2273	1910	4000	2100	2400	2500	6500	35,280.00	36,193.33
L4 H2 Dynamic Panel Van Euro 6D (6.3)											
3500 2.2 (140PS) Turbo D S/S Heavy	XA05 PQ61	IM7L G02	2273	1410	3500	2100	2400	3000	6500	34,395.00	35,308.33
4000 2.2 (140PS) Turbo D S/S Heavy	XA05 PQ61	IM7M G02	2273	1910	4000	2100	2400	2500	6500	35,725.00	36,638.33
L4 H3 Dynamic Panel Van Euro 6D (6.3)											
3500 2.2 (140PS) Turbo D S/S Heavy	XA05 PQ61	IM7o G02	2303	1380	3500	2100	2400	3000	6500	35,175.00	36,088.33

S/S = Start/Stop.

Please note: On-the-road recommended retail prices (RRP) include number plates and delivery to retailer of £583.33 (exc. VAT), 12 months' Vehicle Excise Duty and new vehicle first registration fee of £55.00. Excludes fuel and insurance.

*For definitions please refer to Glossary of Terms. Gross plated weights (including axle weights) quoted on the vehicle plate are to UK plated weight specification and must never be exceeded. Unbraked towing weight 750kg – all models.

New Movano Chassis/Crew Cab Prices/Weights (Provisional data)

	Model/ Pack Code	Orderable Option Code	Minimum Mass (kg)*	Maximum indicative payload (kg)*	Gross Vehicle Weights (GVW) (kg)	Plated weights (kg)		Towing weights (kg) Braked	Plated Gross Combination Weights (GCW) (kg)	Price (£) exc. VAT	On-the-road RRP (£) exc. VAT
						Front axle	Rear axle				
L2 H1 Edition Chassis Cab Euro 6D (6.3)											
3500 2.2 (140PS) Turbo D S/S	XA03 PQ61	IM4F G01	1710	1790	3500	1850	2000	2500	6000	27,940.00	28,853.33
3500 2.2 (140PS) Turbo D S/S Heavy	XA03 PQ61	IM4G G01	1750	1750	3500	2100	2400	3000	6500	28,235.00	29,148.33
L3 H1 Edition Chassis Cab Euro 6D (6.3)											
3500 2.2 (140PS) Turbo D S/S	XA03 PQ61	IM6F G01	1730	1770	3500	1850	2000	2500	6000	28,525.00	29,438.33
3500 2.2 (165PS) Turbo D S/S Heavy	XA03 PR61	IM6G G01	1770	1730	3500	2100	2400	3000	6500	29,730.00	30,643.33
L3 H1 Edition Crew Cab Euro 6D (6.3)											
3500 2.2 (140PS) Turbo D S/S	XA43 PQ61	IM6X G01	1945	1555	3500	1850	2000	2500	6000	29,750.00	30,663.33
3500 2.2 (140PS) Turbo D S/S Heavy	XA43 PQ61	IM6Y G01	1985	1515	3500	2100	2400	3000	6500	30,045.00	30,958.33

S/S = Start/Stop.

Please note: On-the-road recommended retail prices (RRP) include number plates and delivery to retailer of £583.33 (exc. VAT), 12 months' Vehicle Excise Duty and new vehicle first registration fee of £55.00. Excludes fuel and insurance.

*For definitions please refer to Glossary of Terms. Gross plated weights (including axle weights) quoted on the vehicle plate are to UK plated weight specification and must never be exceeded. Unbraked towing weight 750kg – all models.

Fuel Economy and Emissions (Provisional data)

	WLTP Fuel economy mpg (litres/100km) [#]		CO ₂ (g/km) [#]	
	Combined Low	Combined High	High	Low
L2 H1 Edition Panel Van Euro 6D (6.3)				
3500 2.2 (140PS) Turbo D	25.7 (11.0)	40.4 (7.0)	289	185
L2 H2 Edition Panel Van Euro 6D (6.3)				
3500 2.2 (140PS) Turbo D S/S	25.7 (11.0)	40.4 (7.0)	289	185
L2 H2 Dynamic Panel Van Euro 6D (6.3)				
3500 2.2 (140PS) Turbo D S/S	25.7 (11.0)	40.4 (7.0)	289	185
L3 H2 Edition Panel Van Euro 6D (6.3)				
3500 2.2 (140PS) Turbo D S/S	25.7 (11.0)	40.4 (7.0)	289	185
3500 2.2 (140PS) Turbo D S/S Heavy	25.7 (11.0)	40.4 (7.0)	289	185
L3 H2 Edition Glazed Panel Van Euro 6D (6.3)				
3500 2.2 (140PS) Turbo D S/S	25.7 (11.0)	40.4 (7.0)	289	185
L3 H2 Dynamic Panel Van Euro 6D (6.3)				
3500 2.2 (140PS) Turbo D S/S	25.7 (11.0)	40.4 (7.0)	289	185
3500 2.2 (140PS) Turbo D S/S Heavy	25.7 (11.0)	40.4 (7.0)	289	185
3500 2.2 (165PS) Turbo D S/S	25.4 (11.1)	40.4 (7.0)	292	185
L3 H3 Edition Panel Van Euro 6D (6.3)				
3500 2.2 (140PS) Turbo D S/S	25.7 (11.0)	40.4 (7.0)	289	185
L3 H3 Dynamic Panel Van Euro 6D (6.3)				
3500 2.2 (140PS) Turbo D S/S	25.7 (11.0)	40.4 (7.0)	289	185
L4 H2 Edition Glazed Panel Van Euro 6D (6.3)				
4000 2.2 (140PS) Turbo D S/S Heavy	25.7 (11.0)	40.4 (7.0)	289	185
L4 H2 Dynamic Panel Van Euro 6D (6.3)				
3500 2.2 (140PS) Turbo D S/S Heavy	25.7 (11.0)	40.4 (7.0)	289	185
4000 2.2 (140PS) Turbo D S/S Heavy	25.7 (11.0)	40.4 (7.0)	289	185
L4 H3 Dynamic Panel Van Euro 6D (6.3)				
3500 2.2 (140PS) Turbo D S/S Heavy	25.7 (11.0)	40.4 (7.0)	289	185

S/S = Start/Stop.

[#]Figures shown are for comparison purposes and should only be compared to the fuel consumption and CO₂ values of other vehicles tested to the same technical standard. The fuel consumption achieved, and CO₂ produced, in real world conditions will depend upon a number of factors including, but not limited to: the accessories fitted (pre and post registration); variations in weather; driving styles and vehicle load. The WLTP (Worldwide Harmonised Light Vehicles Test Procedure) is used to measure fuel consumption and CO₂ figures. The CO₂ figures display a range to reflect the highest value for the highest emitting version with all available options added, through to a minimum value to represent the lowest emitting version in standard specification.

Fuel Economy and Emissions (Provisional data)

	WLTP Fuel economy mpg (litres/100km) [#]		CO ₂ (g/km) [#]	
	Combined Low	Combined High	High	Low
L2 H1 Edition Chassis Cab Euro 6D (6.3)				
3500 2.2 (140PS) Turbo D S/S	20.2 (14.0)	39.4 (9.0)	366	237
3500 2.2 (140PS) Turbo D S/S Heavy	20.2 (14.0)	39.4 (9.0)	366	237
L3 H1 Edition Chassis Cab Euro 6D (6.3)				
3500 2.2 (140PS) Turbo D S/S	20.2 (14.0)	39.4 (9.0)	366	237
3500 2.2 (165PS) Turbo D S/S Heavy	20.2 (14.0)	39.4 (9.0)	366	237
L3 H1 Edition Crew Cab Euro 6D (6.3)				
3500 2.2 (140PS) Turbo D S/S	20.2 (14.0)	39.4 (9.0)	366	237
3500 2.2 (140PS) Turbo D S/S Heavy	20.2 (14.0)	39.4 (9.0)	366	237

S/S = Start/Stop.

[#]Figures shown are for comparison purposes and should only be compared to the fuel consumption and CO₂ values of other vehicles tested to the same technical standard. The fuel consumption achieved, and CO₂ produced, in real world conditions will depend upon a number of factors including, but not limited to: the accessories fitted (pre and post registration); variations in weather; driving styles and vehicle load. The WLTP (Worldwide Harmonised Light Vehicles Test Procedure) is used to measure fuel consumption and CO₂ figures. The CO₂ figures display a range to reflect the highest value for the highest emitting version with all available options added, through to a minimum value to represent the lowest emitting version in standard specification.

Options

Model Specific Features/Options

	Option code*	Electric model Dynamic	Edition	Dynamic
Option Packs				
Detection Pack – Blind spot detection/Rear traffic alert	UDQ	£200		£200
Safety Pack – Passenger airbag/Lane keep assist/Collision avoidance sensor/Brake assist (low speed)	XAIN	tbc		tbc
Road Assist Pack – Automatic emergency city braking/Lane keep assist/High beam assist/Traffic sign recognition	XAIP	£850		£850
Look Pack 1 (for vans shorter than 6m) – Front fog lights/15-inch and 16-inch wheel covers/Daytime running lights	XAIL	tbc		tbc
Look Pack 2 (for vans longer than 6m) – Front fog lights/15 and 16-inch wheel covers/Daytime running lights/Side signals	XAIM	tbc		tbc
Pack Premium Cabin – Automatic lighting and rain-sensitive wipers/Leather-covered steering wheel/Chrome instrument cluster surround	XAIO	tbc		tbc
Safety and Security				
Driver and passenger airbag – Double passenger airbag (120l) with bench seat/Single passenger airbag (60l) with single seat option	AK5	£180	£180	£180
Driver and front passengers' curtain and side-impact airbags	AJ7	£500		£500
Additional foldable key	ECB	tbc	tbc	tbc
Speed limiter (choice of three: 56mph (90km/h), 62mph (100km/h) or 76mph (120km/h)) – Factory fitted speed-limiters which cannot be adjusted by driver	KYJ/KYK/KYS		£70	£70
Tyre pressure monitoring system	UJN	tbc	tbc	tbc

*Optional at extra cost excluding VAT.

Options

Model Specific Features/Options

	Option code*	Electric model Dynamic	Edition	Dynamic
Facia, instruments and controls				
Electronic smart tachograph	TGF	£450		£450
Interior				
Air conditioning for cab area (including glovebox)	C60	●	£700	●
Automatic air conditioning	C61	tbc		tbc
Overhead storage compartment	BKP	£75		£75
Air suspended driver's seat with full headrest (not available with single passenger's seat)	A5Z	tbc		tbc
Single passenger's seat	TAXL	No-cost		No-cost
Infotainment				
Satellite navigation system: Touchscreen/Digital radio/CD/MP3 player/Bluetooth®	U1T	●		●
Mechanical				
CANbus interface box - Includes 220A generator	WRF	£140	£140	£140
Reinforced suspension system	FG1		tbc	tbc
Rear pneumatic air suspension	FK9			tbc
Grip control	H4H		tbc	tbc
Exterior				
Mudflaps - front and rear	Q8H	£80		£80
Rear parking distance sensors	UD7	●	£250	●
Rear parking distance sensors and rear-view camera	UCI	£350		£350
Outside electrically adjustable, heated and power folding rear-view mirror	D26	tbc		tbc
Mirror Extension - 2.35m	6M2	tbc	tbc	tbc
Mirror Extension - 2.20m	6R2	tbc	tbc	tbc

*Optional at extra cost excluding VAT.

Options

Model Specific Features/Options

	Option code*	Electric model Dynamic	Edition	Dynamic
Load area				
Sliding window for standard full-height steel bulkhead	AX9	£60	£60	£60
Offside sliding side-access door (right-hand side)	BSJ	£350	£350	£350
Glazing to nearside side-access sliding door (left-hand side)	BSB	£60	£60	£60
Glazed rear doors with heated rear windows and internal rear-view mirror	J1X	£250	£250	£250
Unglazed rear doors (270° opening)	EB2	£250	£250	£250
Sliding side windows – 2nd row	5B0		tbc	
Towing				
Fixed tow bar	8P1			tbc
Detachable tow bar	VQ9			tbc
Towing hook pre-installation	JNK	tbc		tbc
Rear harness extension	UNF	tbc		tbc

*Optional at extra cost excluding VAT.

Exterior Colours

Icy White (10U)*
Solid paint

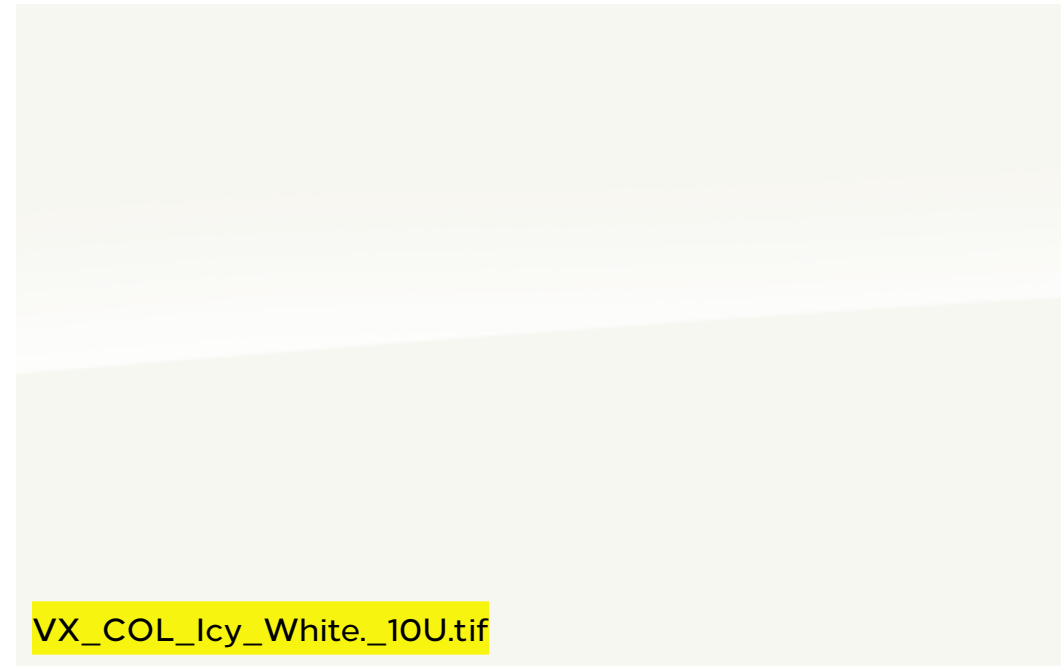

Thunder Grey (GJD)*
Solid paint



Metallic Black (GGL)**
Two-coat metallic paint **£700**

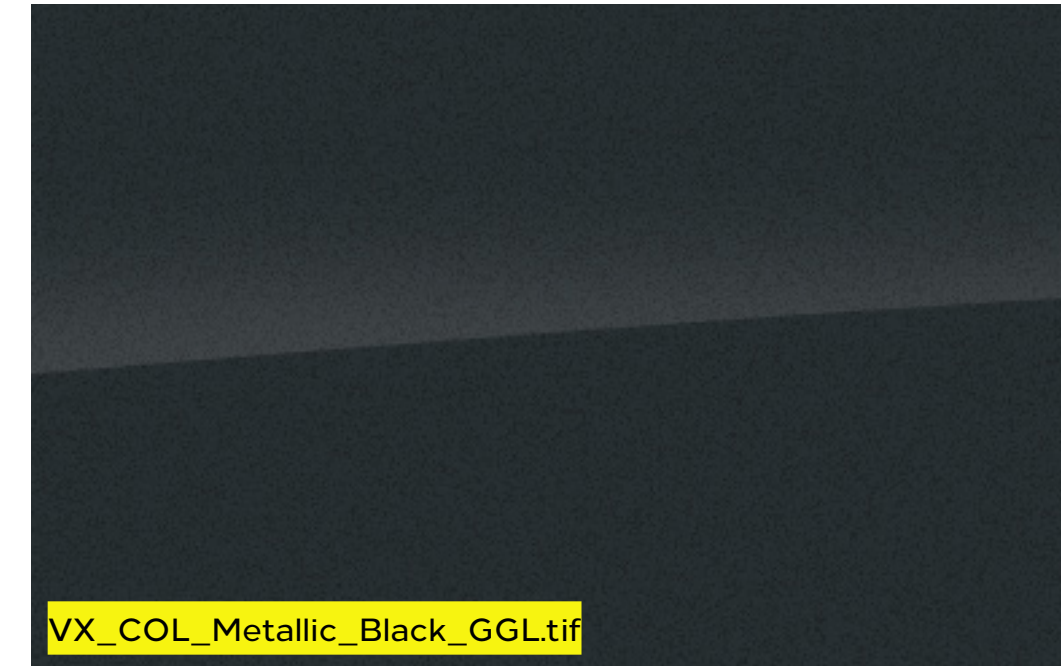

Quartz Silver (G4i)**
Two-coat metallic paint **£700**



Iron Grey (GYM)**
Two-coat metallic paint **£700**

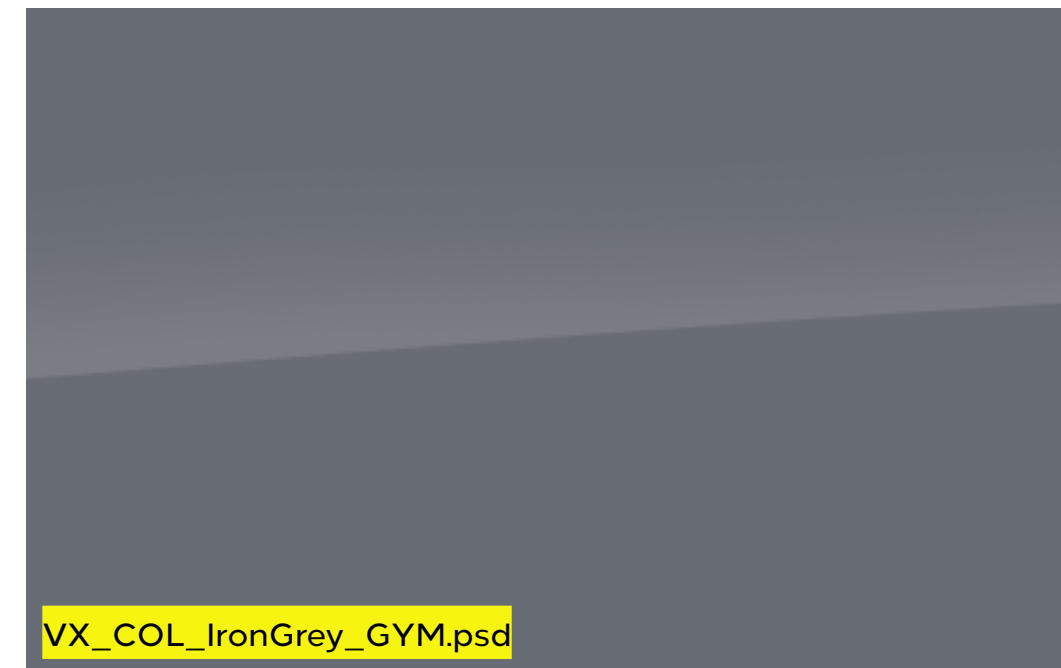

Aluminium Grey (10H)**
Two-coat metallic paint **£700**

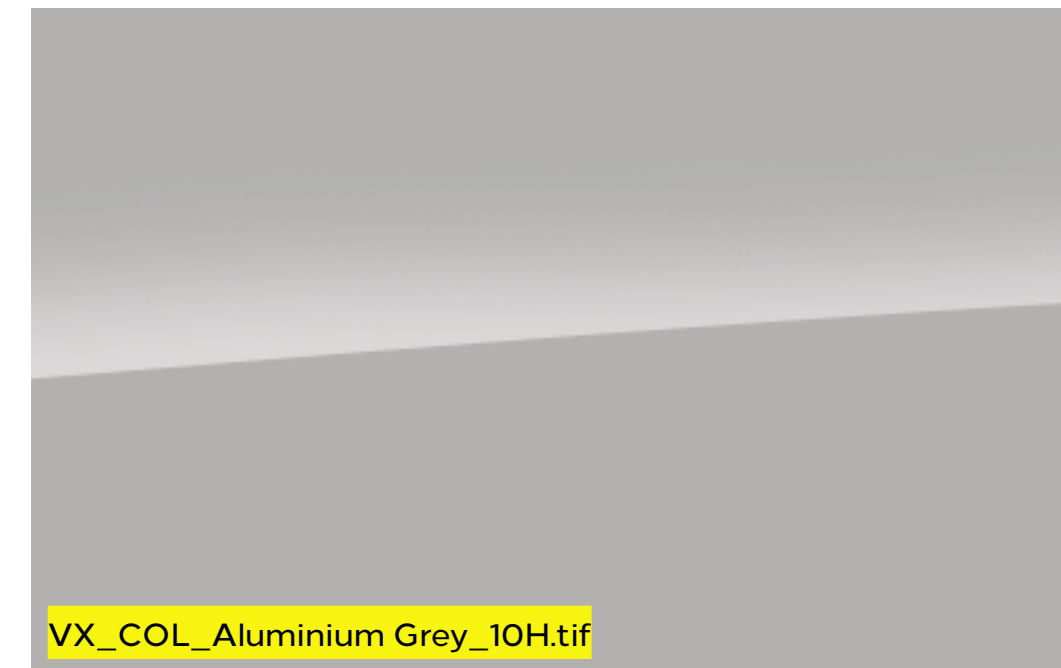

Special Colours

	Option code*	Electric model Dynamic	Edition	Dynamic
Sulphur Yellow (RAL 1016)	G6T	£700	£700	£700
Broom Yellow (RAL 1032)	GRT	£700	£700	£700
Rapeseed Yellow (RAL 1021)	GTH	£700	£700	£700
Golden Yellow (RAL 1004)	GRU	£700	£700	£700
Zinc Yellow (RAL 1018)	GCo	£700	£700	£700
Post Yellow (PTT or La Poste)	GV4	£700	£700	£700
Pullman Brown (UPS)	GWB	£700	£700	£700
Ultra Marine Blue (RAL 5002)	G1L	£700	£700	£700
Pure Orange (RAL 2004)	GTQ	£700	£700	£700
Deep Orange (RAL 2011)	GVS	£700	£700	£700
Flame Red (RAL 3000)	GRR	£700	£700	£700
Traffic Red (RAL 3020)	GBH	£700	£700	£700
Fire Red (AFNOR 1801)	GTT	£700	£700	£700
Blue (EDF)	GRP	£700	£700	£700
Fir Green (RAL 6009)	GTU	£700	£700	£700
Onyx Black	G7R	£700	£700	£700

Additional lead-time for special paint will be confirmed at order placement (event 25). Consult Retailer for details.

*Optional at extra cost excluding VAT.

Wheels and Tyres

	Option code	Electric model Dynamic	Edition	Dynamic
15-inch steel wheels with centre caps (3500 models) • 215/70 R 15 tyres • Full-size steel spare wheel			●	
16-inch steel wheels with centre caps (3500 Heavy models) • 215/75 R 16 tyres • Full-size steel spare wheel			●	
15-inch steel wheels with full-diameter wheel trims (3500 models) • 215/70 R 15 tyres • Full-size steel spare wheel				●
16-inch steel wheels with full-diameter wheel trims (3500 Heavy/4000 models) • 215/75 R 16 tyres • Full-size steel spare wheel		●		●
Emergency tyre inflation kit (in lieu of spare wheel)	WTC	No-cost	No-cost	No-cost

New Movano-e Specifications*

Single-speed electronic drive selector

As the motor is an all-electric single-speed drive unit, there is no need for multiple gears. Instead, the driver selects from the facia-mounted buttons the following:

- **D:** Drive • **N:** Neutral • **R:** Reverse

Digital display shown in rear-view mirror:

- Charge level of the drive battery in percentage
- The current (A), voltage (V) level on the drive battery
- 'Go green' on display screen at the start-up

Drivetrain	Movano-e
CO ₂ emissions	0g/km
Maximum power	90/120kW/PS
Maximum torque	350/258Nm/lb. ft.
Maximum speed	75mph
Transmission	Automatic electric drive with fixed gear ratio
Service interval	12,500 miles/1 year (whichever comes sooner)

Movano-e has been developed in partnership with specialist technology provider BEDEO. This has derived a different solution to Combo-e and Vivaro-e with following differences:

- Air Conditioning controls remain in the central console but heating controls have a separate digital switch
- Dials for RPM, Fuel and Engine Temperature remain but needles removed as these are not necessary for Movano-e
- Engine management warning lights related to the EV Motor will appear in Rear View Mirror
- Pre-conditioning and Connected Services are not available

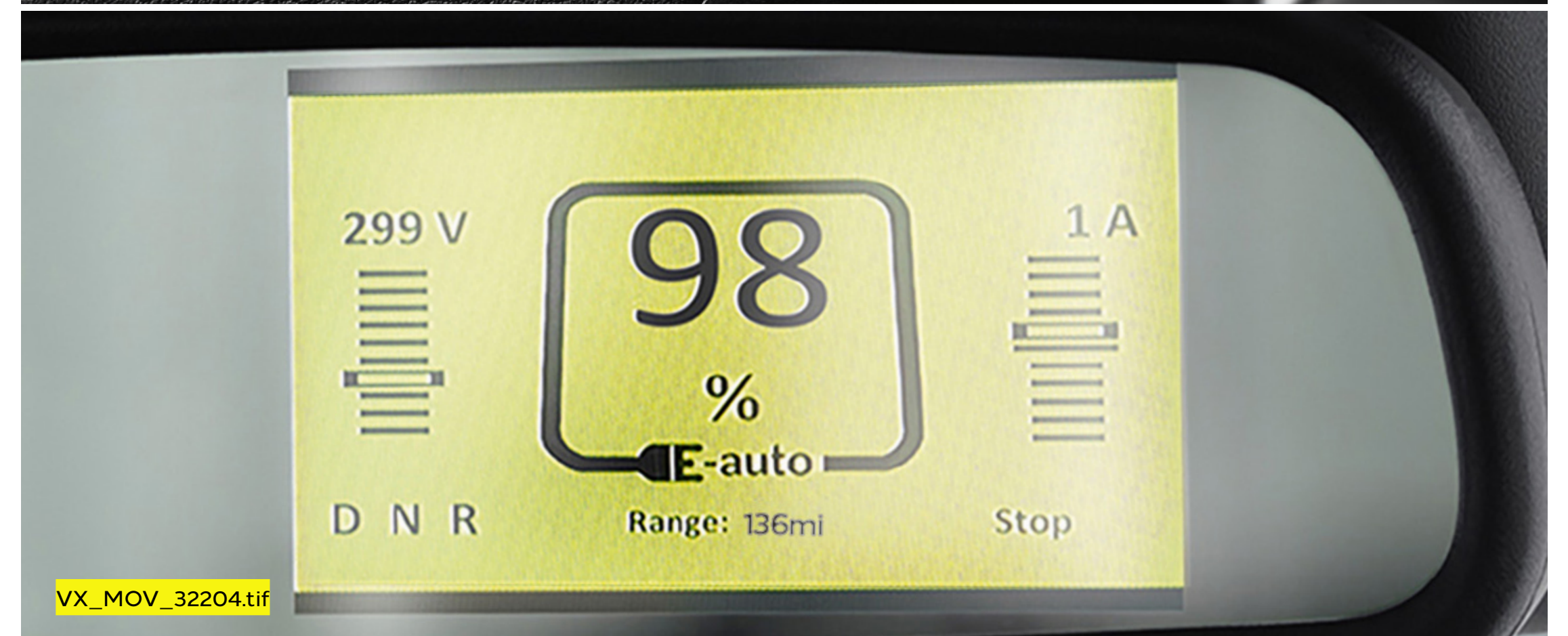

The Movano-e is a battery electric vehicle requiring mains electricity for charging. Range data given has been determined according to WLTP test procedure methodology. The figures shown are intended for comparability purposes only and should only be compared to other vehicles tested to the same technical standard. The range you achieve under real world driving conditions will depend upon a number of factors, including but not limited to: the accessories fitted (pre and post registration); charging frequency; personal driving style; vehicle load and route characteristics; variations in weather; heating/air conditioning and battery condition. For more information, contact your local Vauxhall Retailer.

*Provisional data.

New Movano-e Specifications*

Charging

The new Movano-e- is fitted as standard with a dual on-board charger (OBC, single-phase 7 kW and three-phase 22 kW), which can meet all customer uses and charging solutions. Movano-e is also equipped with a type 2 charging cable.

Charging		
Supply	Socket	Charge Time (0-100%)
AC current – Domestic 3 pin socket (2.3kW)	Type 2	30h 30m
AC current – Home wallbox or public charger (7kW)	Type 2	12h
AC current – Public charger (22kW)**	Type 2	3h 30m
DC current – Rapid charger (50kW)	CCS	1h (0-80%)

Battery	
Battery capacity	70kWh
AC on-board charger speed (standard)	7.4kW
WLTP Range (Combined)	up to 139 miles
WLTP Range (City)	up to 160 miles
Energy consumption (Combined low/high)	tbc
Battery warranty	8 years/100,000 miles/70% capacity



The Movano-e is a battery electric vehicle requiring mains electricity for charging. Range data given has been determined according to WLTP test procedure methodology. The figures shown are intended for comparability purposes only and should only be compared to other vehicles tested to the same technical standard. The range you achieve under real world driving conditions will depend upon a number of factors, including but not limited to: the accessories fitted (pre and post registration); charging frequency; personal driving style; vehicle load and route characteristics; variations in weather; heating/air conditioning and battery condition. For more information, contact your local Vauxhall Retailer.

*Provisional data. **Requires optional 22kW on board charger.

Dimensions and Capacities

All measurements in mm unless stated otherwise. Heights shown unladen.

Interior Dimensions	L2		L3		L4	
	H1	H2	H2	H3	H2	H3
Volume (m ³)	10	11.5	13	15	15	17
Load length at floor	3120	3120	3705	3705	4070	4070
Load length at mid-height with bulkhead	2914	2914	3555	3555	3920	3920
Load width (maximum)	1870	1870	1870	1870	1870	1870
Load width between wheel arches	1422	1422	1422	1422	1422	1422
Load height (maximum)	1662	1932	1932	2172	1932	2172
Side door width	1250	1250	1250	1250	1250	1250
Side door height	1485	1755	1755	1755	1755	1755
Rear doors width	1562	1562	1562	1562	1562	1562
Rear doors height	1520	1790	1790	2030	1790	2030
Load sill height	535-565	535-565	535-565	535-565	535-565	535-565

Panel Van

New_Movano_Panel_Van_2021.ai

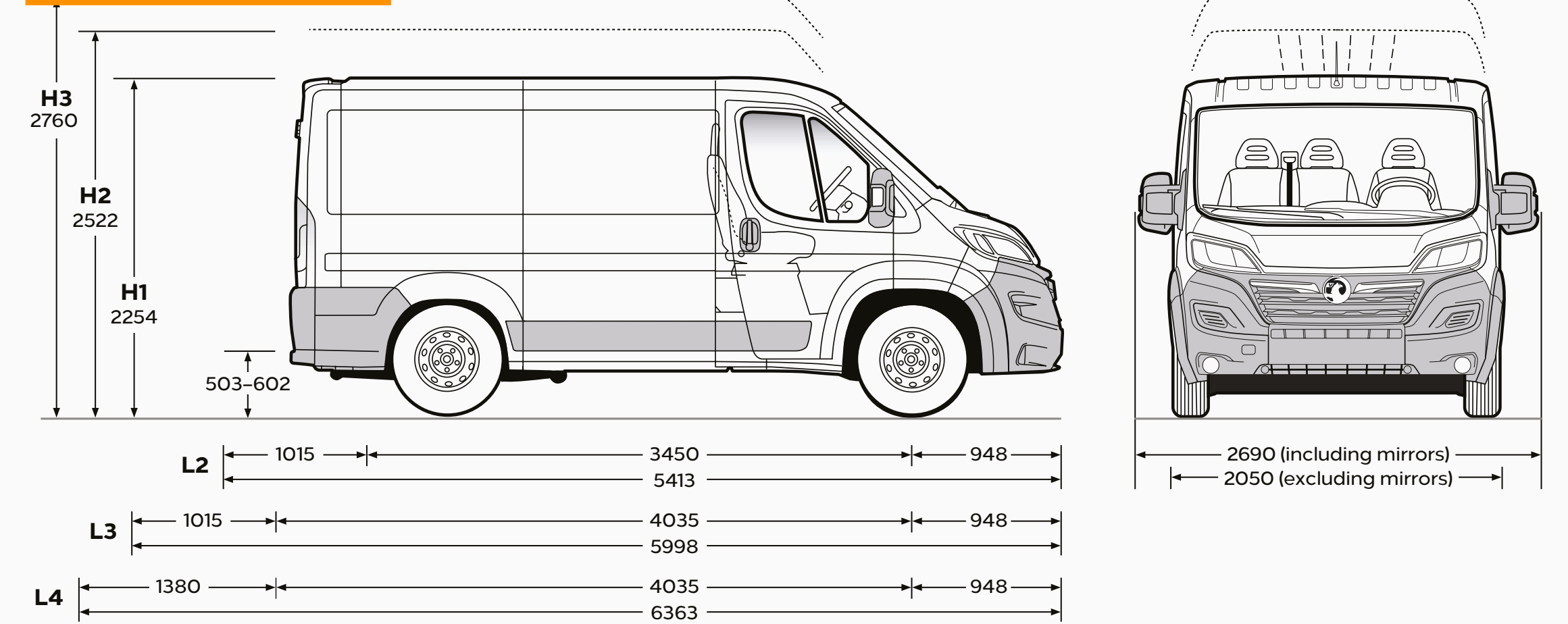

Chassis Cab

New_Movano_Chassis_Cab_2021.ai

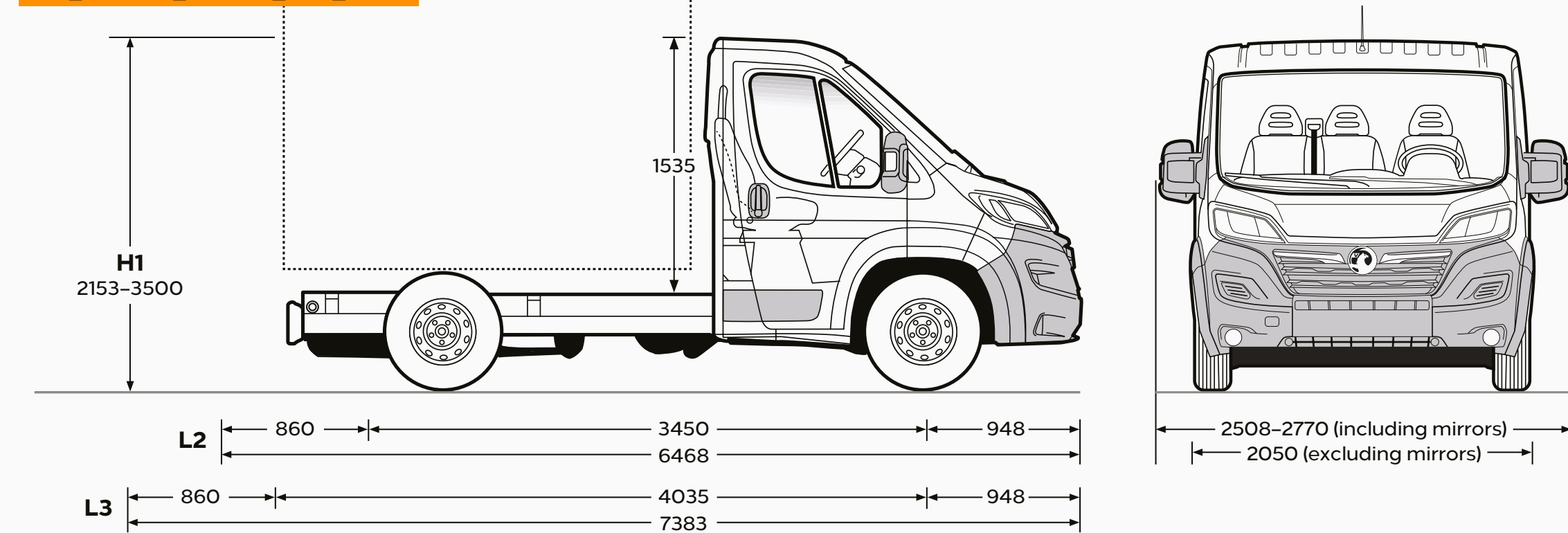

Chassis Crew Cab

New_Movano_Chassis_Crew_Cab_2021.ai

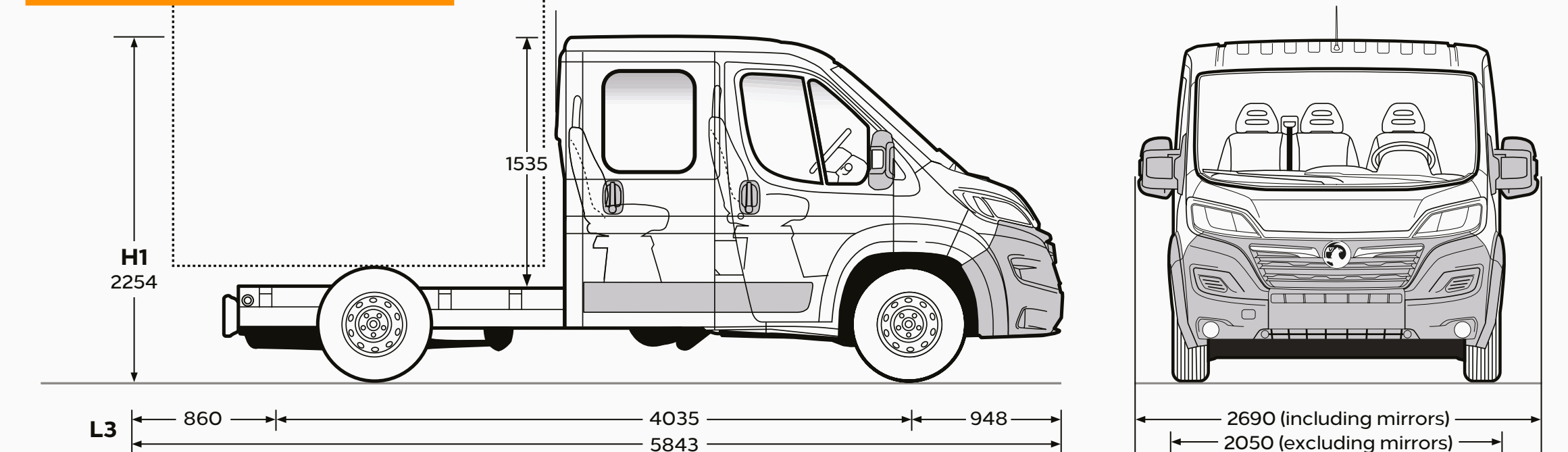

Glossary of Terms

Plated weight

The maximum weight to which a vehicle or an axle may be loaded, determined either by the design of the components or by legislation. All commercial vehicles must carry a manufacturer's 'plate' showing the vehicle and axle gross 'plated weights'. It is an offence to drive a vehicle in a condition where any of these weights are exceeded.

Minimum Mass

Minimum Mass ('Mass in running order' on Certificate of Conformity and 'Mass in Service' on V5C form) is defined according to European Type Approval and include all fluids, tools and 90% fuel load. It is minimum mass for this variant and does not consider local specification/trim or deletable options (specific to Movano). Weights are also subject to manufacturing tolerances (EU Legislation allows 5% tolerance).

Gross Vehicle Weight (GVW)

The total permissible weight of a vehicle including payload and passengers, as shown on the manufacturer's plate.

Gross Combination Weight (GCW)

The maximum permissible weight of a vehicle, including payload and passengers, combined with the total weight of any trailer it is towing. The maximum GCW weight limit is quoted on the vehicle plate and must not be exceeded.

Payload

The total permissible weight that can be carried without exceeding the vehicle's plated weight. Payload do not include driver but do take into consideration specification/trim level:

Weights are also subject to manufacturing tolerances (EU Legislation allows 5% tolerance). Payload does not consider any additional options that a customer may order.

Roof loads

Movano roof load should not exceed 100kg including the weight of the roof rack/carrier.

Maximum towing weight

The maximum weight of any trailer and its load which may be towed within the limit of the vehicle's plated Gross Combination Weight (GCW). It is based on the ability of the vehicle – at full GCW – to restart on a 12% gradient, which is approximately 1 in 8.3, at sea level. At altitudes above 1500 metres, the engine output may drop with a corresponding reduction in towing capability. It is the operator's responsibility to ensure that the trailer noseweight does not cause the rear axle plated weight of the towing vehicle to be exceeded.

Always fit Vauxhall towing attachments and accessories available from your Vauxhall Commercial Vehicle Retailer. They are designed specifically for Vauxhall models and carry a 12-month warranty.

Conversions

A new conversion portal has been introduced. This significantly improves the transparency and response of all communication with body-builders, and converters: converters-and-groupe-psa.com

This website contains complete technical guidelines necessary to convert Vauxhall commercial vehicles – Combo (eK9/K9); Vivaro (eKO/KO); Movano (eX250/X250).

- Conversion Guidelines
- 2D Drawings
- 3D CAD
- WLTP Range/Emission Calculator
- Technical Questions
- Conversion Approval including LONO

Any converter of Vauxhall product should create an account on this portal including those using IVA as approval process. In fact WLTP will make this necessary.

Glossary of Terms

Commercial Vehicle Categories **Differences between M1/N1 and M2/N2 (Vehicles with GVW above 3500kg)**

Category M: Passenger carriers

Category M1: Vehicles designed and constructed for the carriage of passengers and comprising no more than eight seats in addition to the driver's seat.

Category M2: Vehicles designed and constructed for the carriage of passengers, comprising more than eight seats in addition to the driver's seat, and having a maximum mass not exceeding 5 tonnes.

Category N: Goods vehicles

Category N1: Vehicles designed and constructed for the carriage of goods and having a maximum mass not exceeding 3.5 tonnes.

Category N2: Vehicles designed and constructed for the carriage of goods and having a maximum mass exceeding 3.5 tonnes but not exceeding 12 tonnes.

Specific differences, all M2/N2 require the following:

Speed limiter: All M2/N2 vehicles are legally required to be speed limited. M2 to 62mph and N2 to 56mph.

Driver licence: Commercial vehicles with GVW greater than 3.5 tonnes have different license requirements. For any new drivers C1 category is necessary. Under some circumstances (social purposes for a non-commercial body) it is possible to drive a minibus without a D1 entitlement (Minibus) however eligibility for this exemption should be confirmed with DVSA.

Driver CPC: Driver Certificate of Professional Competence mandates 35 hours of periodic training every 5 years to maintain licence (from September 2014).

Tachograph: It is a legal requirement to administer the activities of drivers subject to the EU or AETR drivers' hours rules, and also record the vehicle's speed, distance and time. A Smart Card is required for digital tachograph and these are available from the DVLA. The tachograph of a new vehicle must be calibrated within two weeks of first registration.

Operator's Licence: This may also be required to ensure that vehicles are kept safe and in good condition at all times. Specifically for M2, PSV (public service vehicle) operator's licence is required. Exemptions in some circumstances may be permitted but this should always be confirmed with DVSA.

MOT Testing: M2/N2 must be tested each year, and vehicle presented with a completed Certificate of Conformity (CoC). This is available from Vauxhall (regdata@gm.com) or from converter in case of second-stage conversion.

Further Information

Vauxhall on-the-road recommended retail prices (RRP)

To eliminate uncertainty about hidden costs incurred when buying a new commercial vehicle, Vauxhall publishes on-the-road prices and these are shown in the pricing tables within this price guide. The prices shown are manufacturer's recommended retail prices (RRP) unless otherwise stated, exclusive of VAT (currently at a rate of 20% which may be payable). These prices include the recommended cost of number plates, delivery to a Vauxhall Retailer of £583.33 (£700.00 including VAT), 12 months' Government Vehicle Excise Duty* and the DVLA new vehicle first registration fee of £55.00*.

Please note: The RRP does not include fuel supplied by the Retailer, motor insurance or any other goods or services supplied by agreement between the Retailer and customer.

Price protection

Order a new Vauxhall for build in the current model year (as confirmed by your Retailer) for delivery no more than three months in advance and the price you are quoted is the price you pay. This is irrespective of any subsequent price rises between placing your order and delivery of your new car, but you must take delivery as soon as the car is available.

Please note: Price protection does not apply to electric/hybrid models. Vauxhall Motors Limited is not liable for price adjustments caused by Government changes in the rate of VAT (currently 20%), Vehicle Excise Duty, DVLA new vehicle first registration fee or by any other applicable legislation or regulations.

In the event of an accident...

Vauxhall Accident Management helps keep you mobile following an accident. Benefits include vehicle recovery, Vauxhall-approved repairs and contacting your insurer. For more details, visit vauxhall.co.uk/AccidentManagement

Vehicle Excise Duty

The amount of Vehicle Excise Duty (road fund licence) payable on new commercial vehicles varies depending on gross vehicle weight (GVW) and European standard emissions compliance, as shown below*.

Up to 3500kg GVW	£275.00
Over 3500kg GVW	£165.00

*Correct at time of publication.

Customer Care Commitment

For added peace of mind, Vauxhall has an innovative Customer Care Commitment** that offers the following:

- Three-year vehicle warranty consisting of a one-year/unlimited mileage manufacturer's warranty and a second and third year manufacturer's warranty with a 100,000 miles limitation
- Vauxhall Assistance for 12 months from first registration
- Five years' body panel anti-perforation warranty

**Warranty is only on vehicles sourced from Vauxhall Motors Limited. Terms and conditions apply – please see your Vauxhall Retailer for details.

Vauxhall Assistance

Vauxhall Assistance is provided Automatically with every new Vauxhall Commercial Vehicle for 12 months from first registration and covers everything from accidents, mechanical breakdown to flat tyres. With Vauxhall Assistance help is literally just a free[†] phone call away, 24 hours a day, 365 days a year!

[†]Mobile phone users will be charged at their standard tariff.

Vauxhall Extended Warranty

For complete peace of mind Vauxhall offers an extended warranty that can be purchased on an annual basis following the expiry of the original new vehicle warranty. It covers most mechanical

and electrical components. Terms and conditions apply, for further details please contact your local Vauxhall Retailer.

Protecting the environment

Our products are increasingly winning environmental awards, both through the use of more recycled materials and by becoming cleaner and more efficient. For information on Vauxhall's efforts to achieve an environmentally sustainable future, including information on Design for Recycling, take-back of End-of-Life Vehicles (ELVs), and the recycling of ELVs, see vauxhall.co.uk/recycling

Van Business Centres

Keeping your van on the road. We know how important your van is to you, that's why we're geared up to minimise your downtime.

Our nationwide Van Business Centres provide fast, convenient value for money servicing, repairs and MOTs.

- All work is carried out by Vauxhall trained technicians using only genuine parts
- No appointments are required for diagnosis and we offer a 'while you wait' service

We have all the expertise required and will spare no effort to get you back in business as soon as possible.

Vauxhall Service Plan

Vauxhall Retailers offer a great service for owners of all Vauxhall vehicles. Value for money, regular offers and free check-ups, combined with the peace of mind that comes from using Vauxhall-trained technicians and genuine parts, help keep your vehicle in peak condition at all times. Every Vauxhall Retailer supports our customer promise:

We are Vauxhall experts

- Fully Vauxhall-trained technicians
- We use Vauxhall approved diagnostic equipment and specialist tools
- Full access to Vauxhall repair databases and technical centres

We are transparent

- Our invoicing will clearly set out the work at the price agreed with no hidden extras

We are never beaten on price

- We will match any written like for like service/repair quote from a local^{††} competitor using genuine repair methods and parts

We are convenient

- Flexible booking times to suit you
- 'One-stop shop' for every type of Vauxhall service
- While you wait facility on stocked tyres, batteries and exhausts
- Free courtesy vehicle or local collection with annual services and warranty work

We are thorough

- 25 point safety check with any workshop visit
- No obligation advice on essential and non-essential work
- Free check for safety enhancements and upgrades to your vehicle and software
- Free 'Wash and Vac' with every annual service
- Free fitting of wipers and external bulbs with annual services

^{††}A radius of five miles/20 minutes from your Vauxhall Retailer.

For more product information

For further information on the Vauxhall range or location of your nearest Vauxhall Retailer please call **0345 600 1500**. Alternatively, details can be found on our website at vauxhall.co.uk

For more information call **0345 600 1500**
Discover the full Vauxhall range at **[vauxhall.co.uk](https://www.vauxhall.co.uk)**

Join us online

The invoice price, including delivery to Retailer, factory-fitted options, accessories fitted by the Retailer and number plates, is subject to VAT. Some feature descriptions in this guide may refer to, and some illustrations may show, optional equipment not included in the standard delivery. The information contained in this guide was accurate at the time of publication. We reserve the right to make changes in design and equipment. Please note that Vauxhall Retailers are not the agents of Vauxhall Motors Limited and are not authorised to bind Vauxhall Motors Limited by any specific or implied undertaking or representation. It is advisable to ensure that your motor insurance policy provides adequate cover for additional fitted options and accessories. The colours in this guide are only approximate actual colours. Illustrated optional equipment is available at extra charge. Availability, technical features and equipment provided on our vehicles can vary by model. For precise information on the equipment provided on our vehicles, please contact your local Vauxhall Retailer.

VAUXHALL