

# Vauxhall Adam

Infotainment System





---

# Contents

IntelliLink .....	5
CD 3.0 BT / R 3.0 .....	61
FlexDock .....	103



---

# IntelliLink

Introduction .....	6
Radio .....	20
External devices .....	30
Speech recognition .....	42
Phone .....	44
Index .....	56

## Introduction

General information .....	6
Theft-deterrent feature .....	7
Control elements overview .....	8
Usage .....	10
Basic operation .....	13
Tone settings .....	16
Volume settings .....	17
System settings .....	18

## General information

The Infotainment system provides you with state-of-the-art in-car infotainment.

Using the FM, AM or DAB radio functions, you may register up to 35 stations on seven favourites pages.

For the AM, FM and DAB wavebands the radio is equipped with fifteen automatically assignable channel presets. Furthermore, 35 channels can be allocated manually (waveband-independent).

You can connect external data storage devices, e.g. iPod, USB devices, or other auxiliary devices to the Infotainment system as further audio sources; either via cable or via Bluetooth.

Using the controls and menus of the Infotainment system, you can operate approved smartphone applications, e.g. a navigation app.

In addition, the Infotainment system is equipped with a Phone portal that allows for comfortable and safe use of your mobile phone in the vehicle.

Optionally, the Infotainment system can be operated using the controls on the steering wheel, or via the speech recognition application 'Siri Eyes Free'.

The well-thought-out design of the control elements, the touch screen and the clear displays enable you to control the system easily and intuitively.

### Notice

This manual describes all options and features available for the various Infotainment systems. Certain descriptions, including those for display and menu functions, may not apply to your vehicle due to model variant, country specifications, special equipment or accessories.

## Important information on operation and traffic safety

### Warning

The Infotainment system must be used so that the vehicle can be driven safely at all times. If in doubt, stop the vehicle and operate the Infotainment system while the vehicle is stationary.

### Radio reception

Radio reception may be disrupted by static, noise, distortion or loss of reception due to:

- changes in distance from the transmitter,
- multipath reception due to reflection,
- shadowing.

### Theft-deterrent feature

The Infotainment system is equipped with an electronic security system for the purpose of theft deterrence.

The Infotainment system therefore functions only in your vehicle and is worthless to a thief.

## Control elements overview

### Control panel







1	Display / Touch screen .....	13
2	Home menu .....	13
	Screen buttons for access to:	
	🎵 <b>Audio</b> - audio functions	
	🖼️ <b>Gallery</b> - picture and movie functions	
	📞 <b>Phone</b> - mobile phone functions	
	📱 <b>Apps</b> - smartphone applications	
	⚙️ <b>Settings</b> - system settings	
3	Function indicators	
	If symbol highlighted:	
	TP - radio traffic service active .....	26
	📶 - external device connected to USB port .....	30
	🎧 - auxiliary device connected to AUX input .....	30
	📶 - Bluetooth device connected .....	30

	📱 - smartphone application active .....	30
	🔇 - volume muted .....	10
4	Time and date, outside temperature	
	Adjusting time and date, see Owner's Manual.	
5	🏠 button .....	13
	Press: open Home menu (see item 2)	
6	🔘 button .....	10
	Press: switch on/off Infotainment system	
7	⏮ VOL ⏭ buttons .....	10
	⏮ : reduce volume	
	⏭ : increase volume	

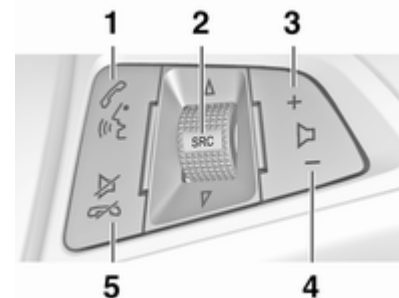
## Steering wheel audio controls



- 1 📞 button
- Short press: take phone call . 44  
or dial number in call list ..... 48  
or activate speech recognition ..... 42
- Long press: open call list ..... 48  
or switch handsfree mode on/off ..... 48
- 2 SRC (Source) ..... 10
- Press: select audio source .... 10

With radio active: turn upwards/downwards to select next/previous preset radio station .....	20	or deactivate speech recognition .....	42
With external device active: turn upwards/downwards to select next/previous track/chapter/picture .....	33	or activate/deactivate mute function .....	10
With Phone portal active and call list open (see item 1): turn upwards/downwards to select next/previous entry in call list .....	48		
With Phone portal active and calls waiting: turn upwards/downwards to switch between calls .....	48		
<b>3</b> Increase volume			
<b>4</b> Reduce volume			
<b>5</b>  button			
Press: end/decline call .....	48		
or close call list .....	48		

## Usage

### Control elements

The Infotainment system is operated via function buttons, a touch screen and menus that are shown on the display.

Inputs are made optionally via:

- the central control unit in the instrument panel
- audio controls on the steering wheel.

### Switching the Infotainment system on or off

Press the  button. After switching on, the last selected Infotainment source becomes active.

### Automatic switch-off

If the Infotainment system has been switched on using the  button while the ignition is switched off, it will switch off again automatically 10 minutes after the last user input.

## Setting the volume

Press one of the **VOL** buttons. The current setting is shown on the display.

Optionally, using the touch screen: move the volume slider with your finger to the left or right.

When the Infotainment system is switched on, the last selected volume is set, provided that volume is lower than the maximum start-up volume. For a detailed description ⇨ 17.

## Speed compensated volume

When the speed compensated volume is activated ⇨ 17, the volume is adapted automatically to make up for the road and wind noise as you drive.

## Volume of traffic announcements (TA)

The volume of traffic announcements can be set separately ⇨ 17.

## Mute

Press one of the **VOL** buttons and then tap on the **M** screen button in the volume menu displayed.

To cancel the mute function: press one of the **VOL** buttons. The last selected volume is set again.

## Volume limitation at high temperatures

At very high temperatures inside the vehicle, the Infotainment system limits the maximum adjustable volume. If necessary, the volume is decreased automatically.

## Modes of operation

Press the **Home** button to display the Home menu.

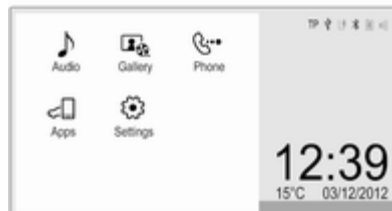

## Notice

For a detailed description of menu operation via touch screen ⇨ 13.

## Audio

Select the **Audio** screen button to open the main menu of the last selected audio mode.

Select the **Source** screen button in the top line of the menu to open a drop down list.



To change to another audio mode: tap on one of the list items.

For a detailed description of:

- Radio functions (**AM, FM, DAB**)  
⇨ 20
- External devices (**USB, AUX, Bluetooth**) ⇨ 33.

### Gallery

Select the **Gallery** screen button to open the main menu of the last selected picture or movie mode.

Tap on the **Source** screen button in the top line of the menu to open a drop down list.



To change to another picture or movie mode: tap on one of the list items.

For a detailed description of:

- Picture functions ⇨ 36
- Movie functions ⇨ 38.

### Phone

Select the **Phone** screen button to establish a Bluetooth connection between the Infotainment system and a mobile phone.

If a connection can be established, the main menu of the phone mode is displayed.



For a detailed description of mobile phone operation via the Infotainment system ⇨ 48.

If no connection can be established, a corresponding message is displayed. For a detailed description of preparing and establishing a Bluetooth connection between the Infotainment system and a mobile phone ⇨ 44.

### Apps

Select the **Apps** screen button to open a menu for selection and start of approved smartphone applications supported by the Infotainment system.



For a detailed description ⇨ 30 and ⇨ 40.

## Settings

Select the **Settings** screen button to open a menu for various system related settings.



**Time & date settings** and **Vehicle settings** are described in the Owner's Manual.

All other settings are described by theme in the respective chapters of this manual.

## Basic operation

### Controls for menu operation

#### Touch screen

The display of the Infotainment system has a touch-sensitive surface that allows direct interaction with the displayed menu controls.

For example, you can activate an on-screen button by tapping on it with your finger or you can change the position of an on-screen slider element by moving it with your finger.

#### Caution

Do not use pointed or hard items like ballpoint pens, pencils or similar for touch screen operation.

#### ☰ button

Press the ☰ button to access the Home menu.

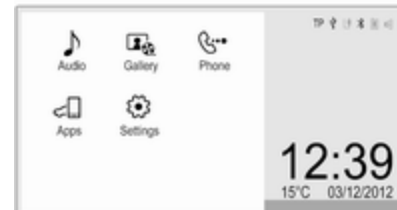

Using the touch screen, you may then access further menus and functions.

#### ☰ screen button



When operating the menus, press the  screen button in the respective submenu to return to the next higher menu level.

### Menu operation (examples)

#### Selecting and activating a screen button or menu item



Tap on a screen button or menu item. The corresponding system function is activated, a message is displayed, or a submenu with further options is displayed.

#### Notice

In subsequent chapters the operating steps for selecting and activating a screen button or menu item via the touch screen will be described as "...select the...screen button..." or "...select the...menu item...".

#### Messages

Before a system function is executed, you are sometimes prompted with a message. If requested, confirm the message or select one of the options.





The selection and activation of a screen button in a message function are the same as described for screen buttons in a menu.

#### Scrolling through a long list of menu items



If there are more menu items available than presentable on the screen, a scroll bar is displayed.

To scroll through the list of menu items:

- Tap on the  or  screen buttons of the scroll bar

or

- move the slider of the scroll bar with your finger up or down.

### Adjusting a setting

The different setting types available in the various settings menus are shown and described below.

#### Example: Display settings



Tap on the - or + screen buttons or move the slider beside a setting to adjust this setting. Confirm your choice by selecting the **OK** screen button.

### Notice

In subsequent chapters the operating steps for adjusting a setting via the touch screen will be described as "...adjust the...setting...".

#### Example: Radio settings



Tap on the < or > screen buttons beside a setting to choose one of the available options or to set a specific value.

### Notice

In subsequent chapters the operating steps for switching to another option via the touch screen will be described as "...set...to...'option name'/'value'...".

#### Example: RDS option

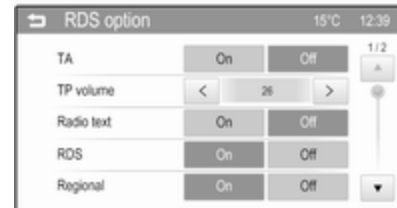

Tap on the **On** screen button or the **Off** screen button beside a setting to activate or deactivate this option.

### Notice

In subsequent chapters the operating steps for switching a setting to **On** or **Off** via the touch

screen will be described as "...set...to...**On**..." or "...set...to...**Off**..."

### Example: DAB category list



Tap on a list item to select or deselect the option. If a list item is selected, a checkmark appears within the box beside the item.

### Notice

In subsequent chapters the operating steps for choosing an option via the touch screen will be described as "...choose...'option name'..."

## Tone settings

In the tone settings menu, the tone characteristics can be set differently for each radio waveband and each external audio source. The menu may be accessed from each individual audio main menu.

To open the tone settings menu, select the **MENU** screen button in the bottom line of the respective main menu. If necessary, scroll through the list of menu items and select **Tone settings**. The respective menu is displayed.



## EQ mode

(EQ: Equaliser)

Use this setting to optimise the tone for the style of music, e.g. **Rock** or **Classical**.

Select the desired sound style. If you choose **Manual**, you can manually adjust the following settings.

### Bass

Use this setting to enhance or attenuate the deep frequencies of the audio sources.

Set **Bass** to a value between **-12** and **12**.

### Mid

Use this setting to enhance or attenuate the midrange frequencies of the audio source.

Set **Mid** to a value between **-12** and **12**.

### Treble

Use this setting to enhance or attenuate the high frequencies of the audio sources.



Set **Treble** to a value between -12 and 12.

### Setting balance and fader

Use the illustration at the right side of the menu to adjust balance and fader.

To define the point in the passenger compartment where the sound is at its highest level, tap on the corresponding point in the illustration. Alternatively, you can move the red marker with your finger to the desired point.

### Notice

The balance and fader settings are valid for all audio sources. They cannot be adjusted individually for each audio source.

### Resetting to factory defaults

Select the **Reset** screen button.

### Saving current settings

Select the **OK** screen button.

## Volume settings

### Adjusting the maximum startup volume

Press the  button and then select the **Settings** screen button.

Scroll through the list to the **Max startup volume** menu item.



Set **Max startup volume** to a value between **13** and **37**.

### Adjusting the speed compensated volume

Press the  button and then select the **Settings** screen button.

Select **Radio settings** to display the respective menu.



To adjust the degree of volume adaptation, set **Auto volume** to **Off**, **Low**, **Medium** or **High**.

**Off**: no enhancement of volume with increasing vehicle speed.

**High**: maximum enhancement of volume with increasing vehicle speed.

## Adjusting the volume of traffic announcements

The volume of traffic announcements can be preset separately to a level independent of the "normal" volume level.

Press the  button and then select the **Settings** screen button.

Select **Radio settings** and then **RDS option** to display the respective menu.

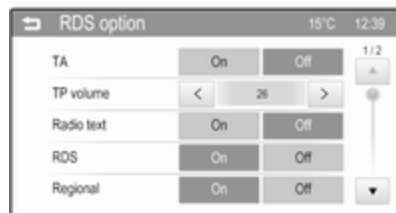

Set **TP volume** to a value between **0** and **63**.

## Adjusting the ring tone volume

Press the  button and then select the **Settings** screen button.

Select **Connection settings** to display the respective menu.



Set **Ringtone volume** to a value between **0** and **63**.

## Activating or deactivating the touch beep volume function

If the touch beep volume function is activated, each tap on a screen button or menu item is indicated by a beeping sound.

Press the  button and then select the **Settings** screen button.

Scroll through the list to the **Touch beep volume** menu item.



Set the function to **On** or **Off**.

## System settings

### Adjusting the language

Press the  button and then select the **Settings** screen button.

Select the **Language (language)** menu item to display the respective menu.



To adjust the language for the menu texts: tap on the desired language.

### Activating or deactivating the text scroll function

If long text is displayed on the screen, the text may either be scrolled continually or it may be scrolled once and displayed in truncated form.

Press the  button and then select the **Settings** screen button.

Scroll through the list to the **Text scroll** menu item.

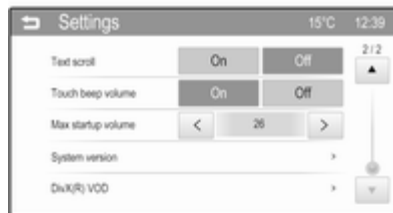

If you wish the text to be scrolled continually, set the function to **On**.

If you wish the text to be scrolled only once, set it to **Off**.

### Resetting to factory defaults

All settings, e.g. the volume and tone settings, the favourite lists, or the Bluetooth device list, can be reset to the factory defaults.

Press the  button and then select the **Settings** screen button.

Select **Radio settings** to display the respective menu.



To reset all settings: tap on the **Radio factory settings** menu item and confirm the messages that subsequently appear.

### Displaying the system version

Press the  button and then select the **Settings** screen button.

Scroll through the list and select the **System version** menu item.

## Radio

Usage .....	20
Station search .....	20
Autostore lists .....	21
Favourite lists .....	22
Waveband menus .....	22
Radio data system (RDS) .....	26
Digital audio broadcasting .....	27

## Usage

### Activating the radio

Press the  button and then select the **Audio** screen button. The audio main menu last selected is displayed.

Select the **Source** screen button to open a drop down list.



Select **AM**, **FM** or **DAB** radio.

The station last played in the selected waveband will be received.



### Notice

To display information on the currently active radio station: tap on the display.



## Station search

### Automatic station search



Briefly tap on one of the **SEEK**   screen buttons to play the previous or next station in the station memory.

### Manual station search

Tap on and hold one of the **SEEK**   screen buttons. Release the button when the required frequency has almost been reached.

A search is made for the next station that can be received and it is played automatically.

### Notice

**Manual station search:** If the radio does not find a station, it switches automatically to a more sensitive search level. If it still does not find a station, the frequency that was last active is set again.

### Notice

**FM waveband:** when the RDS function is activated, only RDS stations ↻ 26 are searched for, and when the radio traffic service (TP) is activated, only traffic service stations ↻ 26 are searched for.

## Station tuning

Tap on and hold or repeatedly tap on one of the ◀ **TUNE** ▶ screen buttons to adjust the frequency of the desired radio station.

If **Radio tune bar** in the **Radio settings** menu (see note below) is set to **On**, a tune bar is displayed when tapping on one of the ◀ **TUNE** ▶ screen buttons.



You may now manually tune or seek for radio stations.

### Notice

To open the **Radio settings** menu: press the ⚙ button, select the **Settings** screen button and then select the **Radio settings** menu item.

## Autostore lists

The stations received best in a waveband can be searched for and stored automatically via the autostore function.



Each waveband has 3 autostore lists (**AS 1/3**, **AS 2/3** and **AS 3/3**), in each of which 5 stations may be stored.

### Notice

If the **FAV** tab is currently shown in the foreground: tap on the **AS** tab to display the autostore lists.

### Notice

The currently received station is highlighted.

## Storing stations

If required, tap on the **AS** tab to display the autostore lists.

Tap on and hold the **AS** tab for a few seconds. A message is displayed and the stations received best in the active waveband are stored in the autostore lists.

### Notice

If there are no stations stored in the **AS** stations lists, the lists will be updated automatically when you first select the **AS** tab.

## Retrieving stations

If required, tap on the **AS** tab to display the autostore lists.

If required, tap on the < or > screen buttons to select another autostore list.

Select the preset screen button on which the desired radio station is stored.

## Favourite lists

Stations of all wavebands can be stored manually in the favourite lists.



Seven favourite lists are available, in each of which 5 stations may be stored.

### Notice

If the **AS** tab is currently shown in the foreground: tap on the **FAV** tab to display the favourite lists.

### Notice

The currently received station is highlighted.

## Storing a station

If required, tap on the **FAV** tab to display the favourite lists.

If required, tap on the < or > screen buttons to select another favourite list.

To store the currently active radio station to a preset screen button: tap on and hold the desired screen button for a few seconds. The corresponding frequency or station name is displayed on the screen button.

## Retrieving stations

If required, tap on the **FAV** tab to display the favourite lists.

If required, tap on the < or > screen buttons to select another favourite list.

Select the preset screen button on which the desired radio station is stored.

## Waveband menus

Alternative facilities for station selection are available via waveband specific menus.

Tap on the **MENU** screen button in the bottom line of the active radio main menu to open the corresponding waveband specific submenu.

### Notice

The following FM specific displays are shown as examples.



### Favorite list

Select **Favorite list** to display all stations currently stored in the favourites lists.



Select the desired station.

### Notice

The currently received radio station is indicated by the ► symbol next to the station name.

### Station lists

Depending on the waveband menu, select **FM station list**, **AM station list** or **DAB station list**. All receivable stations of the relevant waveband and in the current reception area are displayed.



Select the desired station.

### Notice

The currently received radio station is indicated by the ► symbol next to the station name.

### Category lists

Numerous RDS ⇄ 26 and DAB ⇄ 27 stations broadcast a PTY code, which specifies the type of programme transmitted (e.g. news). Some stations also change the PTY code depending on the content which is currently transmitted.

The Infotainment system stores these stations, sorted by programme type in the corresponding category list.

### Notice

The category list submenu item is only available for the FM and the DAB wavebands.

To search for a programme type determined by the stations, select the waveband specific category list option.



A list of programme types currently available is displayed.

### Notice

For the DAB waveband, only the selected categories ⇨ 27 are displayed in the category list.

Select the desired programme type. A list of stations is displayed transmitting a programme of the selected type.

Select the desired station.

### Notice

The currently received radio station is indicated by the ► symbol next to the station name.

## DAB announcements

Besides their music programmes, a lot of DAB stations also broadcast announcements of various categories. If you activate some or all categories, the currently received DAB service is interrupted when an announcement of these categories is made.

### Activating announcement categories

Select **DAB announcements** in the DAB waveband menu. A list of categories is displayed.



Activate all or just the desired announcement categories. Different announcement categories can be selected at the same time.

### Notice

DAB announcements can only be received if the DAB waveband is activated.

## Update station lists

If the stations stored in a waveband specific station list can no longer be received, select **Update FM station list**, **Update AM station list** or **Update DAB station list** depending on the waveband.



**Notice**

If a waveband specific station list is updated the corresponding category list (if available) is also updated.

A station search is started and a corresponding message is displayed. Once the search is finished, the respective station list is displayed.

**Notice**

The currently received radio station is indicated by the ► symbol next to the station name.

**EPG current program**

An electronic program guide (EPG) provides you with continuously updated information about current and upcoming programmes.

**Notice**

The submenu item is only available in the DAB waveband menu.

To display information on the currently active programme, select **EPG current program** in the DAB waveband menu.

**EPG station list**

The **EPG station list** contains the stations providing an electronic programme guide.

**Notice**

The submenu item is only available in the DAB waveband menu.

To display current and upcoming programmes of the respective station, select the **Info** screen button beside the station name.

**Intellitext**

The **Intellitext** function allows the reception of additional information such as announcements, financial information, sports, news etc.

**Notice**

The submenu item is only available in the DAB waveband menu.

Select one of the categories and choose a specific item to display detailed information.

**Info**

To display detailed information on the currently active DAB station, select the **Info** menu item.

**Notice**

The submenu item is only available in the DAB waveband menu.

**Tone settings**

For a detailed description of the **Tone settings** menu ⇨ 16.

## Radio data system (RDS)

RDS is a service of FM stations that considerably facilitates the finding of the desired station and its fault-free reception.

### Advantages of RDS

- On the display, the programme name of the station appears instead of its frequency.
- During a station search the Infotainment system tunes in to RDS stations only.
- The Infotainment system always tunes into the best receivable broadcasting frequency of the set station by means of AF (alternative frequency).
- Depending on the station that is received, the Infotainment system displays radio text that can contain e.g. information about the current programme.

### RDS option menu

To open the menu for the RDS configuration:

Press the  button and then select the **Settings** screen button.

Select **Radio settings** and then **RDS option** to display the respective menu.

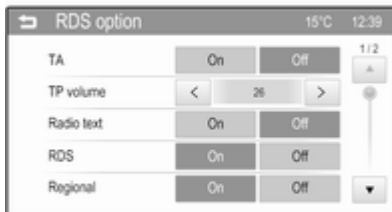

#### Notice

If **RDS** is set to **Off**, not all menu items shown above are displayed.

### Traffic announcements (TA)

Radio traffic service stations are RDS stations that broadcast traffic news. If the traffic service is switched on, the currently active function is interrupted for the duration of the traffic announcement.

### Switching the traffic announcements on and off

Set the **TA** menu item to **On** or **Off**.

If the radio traffic service is activated, **[TP]** is shown in the top line of all main menus. If the current station is not a radio traffic service station, TP is greyed out and a search is started automatically for the next radio traffic service station. As soon as a radio traffic service station is found, **TP** is highlighted. If no radio traffic service station is found, TP remains greyed out.

If a traffic announcement is broadcast on the respective station, a message is displayed.

To interrupt the announcement and return to the function previously activated: select the **Cancel** screen button in the message.

### TP volume

The volume of traffic announcements can be preset to a value between **0** and **63**.

## RDS configuration

Set RDS to **On** or **Off**.

### Radio text

If the RDS function is activated and a RDS station is currently received, information about the current programme and the music track currently playing are displayed below the programme name.

To show or hide the information, set **Radio text** to **On** or **Off**.

### Regionalisation

Sometimes RDS stations broadcast regionally different programmes on different frequencies.

Set **Regional** to **On** or **Off**.

If regionalisation is switched on, alternative frequencies with the same regional programmes are selected where necessary. If regionalisation is switched off, alternative frequencies of the stations are selected without regard to regional programmes.

### PSN scroll freeze

Some RDS stations do not only indicate the programme service name (PSN) on the display, but also show additional information about the current programme. If additional information is displayed, the programme name is hidden.

To prevent additional information from being displayed, set **PSN scroll freeze** to **On**.

## Digital audio broadcasting

Digital audio broadcasting (DAB) is an innovative and universal broadcasting system.

DAB stations are indicated by the programme name instead of the broadcasting frequency.

### General information

- With DAB, several radio programmes (services) can be broadcasted on a single frequency (ensemble).

- Besides high-quality digital audio services, DAB is also able to transmit programme-associated data and a multitude of other data services including travel and traffic information.
- As long as a given DAB receiver can pick up the signal sent out by a broadcasting station (even if the signal is very weak), sound reproduction is ensured.
- There is no fading (weakening of the sound that is typical of AM or FM reception). The DAB signal is reproduced at a constant volume. If the DAB signal is too weak to be picked up by the receiver, reception is interrupted completely. This incident can be avoided by activating **Service linking DAB** and/or **Service linking FM** in the DAB option menu (see below).
- Interference caused by stations that are on nearby frequencies (a phenomenon that is typical of AM and FM reception) does not occur with DAB.

- If the DAB signal is reflected by natural obstacles or buildings, the reception quality of DAB is improved, whereas AM or FM reception is considerably impaired in such cases.
- When DAB reception is enabled, the FM tuner of the Infotainment system remains active in the background and continually searches for the best receivable FM stations. If TP ↻ 26 is activated, traffic announcements of the FM station which is currently best receivable are issued. Deactivate TP, if DAB reception should not be interrupted by FM traffic announcements.

### DAB option menu

To open the menu for the DAB configuration:

Press the  button and then select the **Settings** screen button.

Select **Radio settings** and then **DAB option** to display the respective menu.

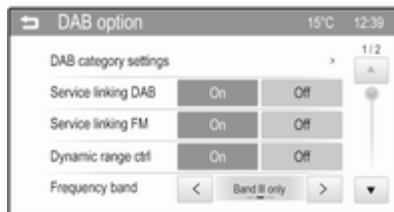

### DAB category settings

To choose which categories are displayed in the **DAB category list** in the **DAB menu** ↻ 22, select **DAB category settings**. The respective menu is displayed.



Select **All** or select and deselect only some categories from the available options.

Select the **OK** screen button to confirm your choice.

### DAB configuration

In the **DAB option** menu you can setup features concerning the DAB radio reception.

#### Service linking DAB

If this function is activated, the device switches over to the same service (programme) on another DAB

ensemble (frequency, if available) when the DAB signal is too weak to be picked up by the receiver.

Set **Service linking DAB** to **On** or **Off**.

### **Service linking FM**

If this function is activated, the device switches over to a corresponding FM station of the active DAB service (if available) when the DAB signal is too weak to be picked up by the receiver.

Set **Service linking FM** to **On** or **Off**.

### **Dynamic range compression**

If this function is activated, the dynamic range of the DAB signal is reduced. That means that the level of loud sounds is reduced and the level of quiet sounds is increased.

Therefore the volume of the Infotainment system can be raised to a point where the quiet sounds are audible, without the loud sounds being too loud.

Set **Dynamic range ctrl** to **On** or **Off**.

### **Selecting a frequency band**

With this function you may define which DAB wavebands are to be received by the Infotainment system.

Choose **L-Band only**

(1452 - 1492 MHz, earth and satellite radio) **Band III only** (174 - 240 MHz, earth radio) or **Both**.

### **Radio text**

If this function is activated, additional information about the programme currently received or the music track currently playing such as title, artist, music type, news or traffic updates are displayed.

To show or hide the information, set **Radio text** to **On** or **Off**.

### **Slide Show**

If this function is activated, additional information about the programme currently received or the music track currently playing are displayed in form of pictures, graphics or short video sequences.

To show or hide these pictures, graphics or videos sequences, set **Slide Show** to **On** or **Off**.

## External devices

General information .....	30
Playing audio .....	33
Displaying pictures .....	36
Playing movies .....	38
Using smartphone applications ...	40

### General information



In the centre console below the climate controls, there is an AUX socket and a USB socket for the connection of external audio data sources.

#### Caution

Do not charge USB accessory equipment at the USB socket. The heat generation may cause performance issues or damage the Infotainment system.

If configurable, change settings of the equipment, e.g. Smartphones, so that USB connection is only used for data transmission and not for charging.

#### Notice

The sockets must always be kept clean and dry.

### AUX input

It is possible to connect e.g. an iPod or another auxiliary device to the AUX input.

When connected to the AUX input, the audio signal of the auxiliary device is transmitted via the speakers of the Infotainment system.

The volume and the tone settings can be adjusted via the Infotainment system. All other control functions must be operated via the auxiliary device.

#### Connecting a device

To connect the auxiliary device to the AUX input socket of the Infotainment system, use one of the following cables:

3-pole for audio source, 4-pole for movie source.

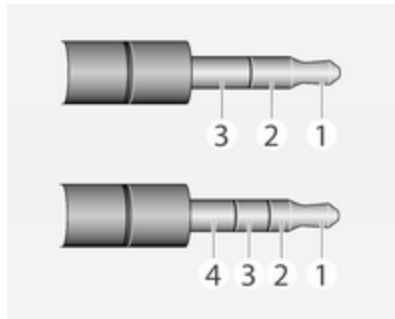

- 1 = Left audio signal
- 2 = Right audio signal
- 3 = Ground
- 4 = Video signal

### AUX audio function

The Infotainment system can play music files contained in auxiliary devices e.g. smartphones or iPod/iPhone products.

### AUX movie function

The Infotainment system can play movies contained in auxiliary devices e.g. smartphones or iPod/iPhone products.

#### Notice

To use the movie function with your iPod/iPhone, connect your device to the AUX port only. A constant connection cannot be established via the USB port.

### USB port

An MP3 player, USB drive, SD card (via USB connector/adaptor), iPod or Smartphone can be connected to the USB port.

When connected to the USB port, various functions of the devices mentioned above can be operated via the controls and menus of the Infotainment system.

#### Notice

Not all MP3 player, USB drive, SD card, iPod models or Smartphones are supported by the Infotainment system.

### Connecting/disconnecting a device

Connect the USB device or iPod to the USB port. For the iPod, use the appropriate connection cable. The music function starts automatically.

#### Notice

If a non-readable USB device or iPod is connected, a corresponding error message will appear and the Infotainment system will automatically switch to the previous function.

To disconnect the USB device or iPod, select another function and then remove the USB storage device.

### Caution

Avoid disconnecting the device during playback. This may damage the device or the Infotainment system.

### USB audio function

The Infotainment system can play music files contained in USB storage devices or iPod/iPhone products.

**USB picture function**

The Infotainment system can display pictures contained in USB storage devices.

**USB movie function**

The Infotainment system can play movies contained in USB storage devices.

**Notice**

To use the movie function with your iPod/iPhone, connect your device to the AUX port only. A constant connection cannot be established via the USB port.

**Bluetooth**

Bluetooth enabled audio sources (e.g. music mobile phones, MP3 players featuring Bluetooth, etc.), which support the Bluetooth music profiles A2DP and AVRCP can be connected wirelessly to the Infotainment system.

**Connecting a device**

For a detailed description on the Bluetooth connection ↪ 45.

**Bluetooth audio function**

The Infotainment system can play music files contained in Bluetooth devices e.g. smartphones or iPod/iPhone products.

**Support of smartphone applications**

The **Apps** function of the Infotainment system allows access to approved smartphone applications. The Infotainment system authorises application updates as they become available.

Before an approved application can be operated using the controls and menus of the Infotainment system, the respective application must be installed on the smartphone.

Follow the instructions on the smartphone when installing an approved smartphone application.

**File formats and folders**

The maximum capacity of a device supported by the Infotainment system amounts to 2500 music files, 2500 picture files, 250 movie files, 2500 folders and 10 stages of folder

structure. Only devices formatted in the FAT16/FAT32 file system are supported.

**Notice**

Some files may not be played properly. This might be due to a different recording format or the condition of the file.

Files from online shops to which digital rights management has been applied cannot be played.

The Infotainment system can play the following audio, picture and movie files stored on external devices.

**Audio files**

The playable audio file formats are .mp3, .wma, .ogg and .wav.

When playing a file with ID3 tag information, the Infotainment system can display information, e.g. on the track title and artist.

**Picture files**

The displayable picture file formats are .jpg, .bmp, .png and .gif.



.jpg files must have a size of 64 to 5000 pixels in width and 64 to 5000 pixels in height.

.bmp, .png and .gif files must have a size of 64 to 1024 pixels in width and 64 to 1024 pixels in height.

### Movie files

The playable movie file formats are .avi, .mpeg, .mp4, .divx, .xvid and .wmv.

The resolution of the files must be within a range of 720 pixels in width and 576 pixels in height. The frame rate must be less than 30 fps.

Usable codecs are divx, xvid, mpeg-1, mpeg-4 (mpg4, mp42, mp43) and wmv9 (wmv3).

The playable audio formats are .mp3, .ac3, .aac and .wma.

The displayable subtitle format is .smi.

## Playing audio

### Auxiliary device

#### Activating the AUX function

If the auxiliary device is not yet connected to the Infotainment system, connect the device ↻ 30. The AUX audio menu is displayed and playback of the audio tracks starts automatically.

#### In case the auxiliary device is already connected:

If required, press the 🏠 button and then select the **Audio** screen button to open the audio main menu last selected.

If required, select the **Source** screen button to open a drop down list and then select **AUX** to open the respective audio main menu.

Playback of the audio tracks starts automatically.



#### Changing the tone settings

Select the 🗨 **Tone settings** screen button to open the respective menu. For a detailed description ↻ 16.

#### Notice

The volume and the tone settings can be adjusted via the Infotainment system. All other functions must be performed via the auxiliary device.

## USB device and iPod

### Activating the USB device or iPod function

If the USB device or iPod is not yet connected to the Infotainment system, connect the device ⇨ 30. The respective audio main menu is displayed and playback of the audio tracks starts automatically.

### In case the USB device or iPod is already connected:

If required, press the  button and then select the **Audio** screen button to open the audio main menu last selected.

If required, select the **Source** screen button to open a drop down list and then select **USB** to open the respective audio main menu.

Playback of the audio tracks starts automatically.



### Notice

Album covers are displayed, if they are comprised in the audio file e.g. MP3 file.

### Interrupting and resuming playback

Tap on the **||** screen button to interrupt playback. The screen button changes to **▶**.

Tap on the **▶** screen button to resume playback.

### Playing the next or previous track

Tap on the **▶▶** screen button to play the next track.

Tap on the **◀◀** screen button within the first 2 seconds of the track playing to return to the previous track.

### Returning to the beginning of the current track

Tap on the **◀◀** screen button after 2 seconds of the track playing.

### Fast forwarding and rewinding

Hold down the **◀◀** or **▶▶** screen buttons. Release the respective button to return to the normal playback mode.

Alternatively, you can move the slider showing the current track position with your finger to the left or right.

### Playing tracks repeatedly

Repeatedly tap on the  screen button to choose one of the following options.

- **1**: the current track is played repeatedly.
- **ALL**: all tracks on the device are played repeatedly.
- **OFF**: normal playback mode.

### Playing tracks randomly

Repeatedly tap on the  screen button to activate or deactivate the function.

- **ON:** all tracks on the device are played in random order.
- **OFF:** normal playback mode.

### Viewing information

To display information on the track currently playing, tap on the screen. A message is displayed showing information, e.g. on the title, artist, or album, saved with the track.

### Using the music menu

Tap on the **MENU** screen button to open the respective music menu.

Different categories, in which the tracks are sorted, are displayed, e.g. **Folders**, **Artists**, or **Albums**.



Select the desired category, subcategory (if available) and then choose a track.

### Changing the tone settings

Select **Tone settings** to open the respective menu. For a detailed description ⇨ 16.

### Bluetooth music

#### Activating the Bluetooth music function

If the Bluetooth device is not yet connected to the Infotainment system, establish a Bluetooth connection ⇨ 45 and then continue as described below.

### In case the Bluetooth device is already connected:

If required, press the  button and then select the **Audio** screen button to open the audio main menu last selected.

If required, select the **Source** screen button to open a drop down list and then select **Bluetooth** to open the respective audio main menu.

Playback of the audio tracks starts automatically.



### Interrupting and resuming playback

Tap on the **II** screen button to interrupt playback. The screen button changes to **▶**.

Tap on the **▶** screen button to resume playback.

### Playing the next or previous track

Tap on the **▶▶** screen button to play the next track.

Tap on the **◀◀** screen button within the first 2 seconds of the track playing to return to the previous track.

### Returning to the beginning of the current track

Tap on the **◀◀** screen button after 2 seconds of the track playing.

### Fast forwarding and rewinding

Hold down the **◀◀** or **▶▶** screen buttons. Release the respective button to return to the normal playback mode.

### Playing a track or file repeatedly

Repeatedly tap on the **↺** screen button to choose one of the following options.

- **1**: the current track is played repeatedly.
- **ALL**: all tracks on the device are played repeatedly.
- **OFF**: normal playback mode.

### Playing a file randomly

Repeatedly tap on the **🎲** screen button to activate or deactivate the function.

- **ON**: all tracks on the device are played in random order.
- **OFF**: normal playback mode.

### Notice

Depending on the mobile phone some of these functions may not be available.

### Changing the tone settings

Select the **#** screen button to open the **Tone settings** menu. For a detailed description ⇨ 16.

### Displaying pictures

You can view pictures from a USB device.

### Notice

For your safety, some features are disabled while your vehicle is in motion.

### Viewing pictures

If the USB device is not yet connected to the Infotainment system, connect the device ⇨ 30 and then continue as described below.

### In case the USB device is already connected:

If required, press the **🏠** button and then select the **Gallery** screen button to open the picture or movie main menu last selected.

If required, select the **Source** screen button to open a drop down list and then select **USB (Picture)** to open the respective main menu.

A picture is automatically displayed.

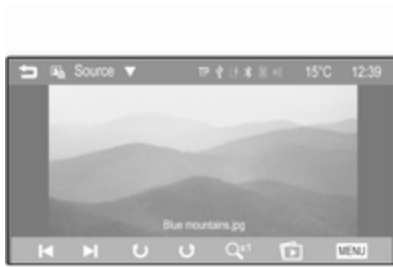

Tap on the screen to view the picture in full screen. Tap on the screen again to leave the full screen mode.

### Viewing the next or previous picture

Tap on the ► screen button to view the next picture.

Tap on the ◀ screen button to view the previous picture.

### Rotating a picture

Tap on the ↻ or ↺ screen buttons to rotate the picture clockwise or counterclockwise.

### Viewing a slide show

Tap on the 🖼️ screen button to view the pictures stored on the USB device in a slide show.

Tap on the screen to finish the slide show.

### Zoom in on a picture

Tap on the 🔍 screen button once or several times to zoom in on a picture or to return to its original size.

### Using the picture menu

Tap on the MENU screen button to open the **USB Picture menu**.

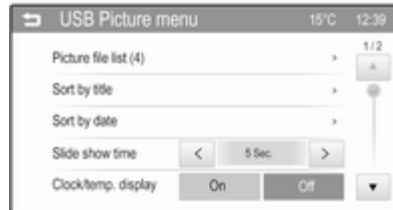

### Picture file list

All lists with picture files are displayed. Search for the picture you want to display and select it.



If you tap on the picture file name once, a small preview picture is displayed next to the file list. If you tap on it a second time or if you select the 🖼️ screen button under the preview picture, the picture is displayed in the main menu.

### Sort by title

A list with all picture files alphabetically ordered is displayed.

### Sort by date

A list with all picture files sorted by date and starting with the latest date is displayed.

### Slide show time

Adjust the time sequence in which one picture is shown in a slide show.

### Clock/temp. display

If you want the time and temperature to be displayed in full screen mode, set **Clock/temp. display** to **On**.

### Display settings

Adjust the brightness and contrast of the picture display.



Set **Brightness** to a value between **-9** and **9**.

Set **Contrast** to a value between **-15** and **15**.

## Playing movies

You can view movies from an auxiliary device connected to the AUX input or from a USB device connected to the USB port.

### Notice

To use the movie function with your iPod/iPhone, connect your device to the AUX port only. A constant connection cannot be established via the USB port.

### Notice

For your safety, the movie function is not available while driving.

## Auxiliary device

### Activating the AUX function

If the auxiliary device is not yet connected to the Infotainment system, connect the device ⇨ 30. The

AUX movie menu is displayed and playback of the movie files starts automatically.

### In case the auxiliary device is already connected:

If required, press the  button and then select the **Gallery** screen button to open the picture or movie main menu last selected.

If required, select the **Source** screen button to open a drop down list and then select **AUX (Movie)** to open the respective main menu.

Playback of the movie files starts automatically.

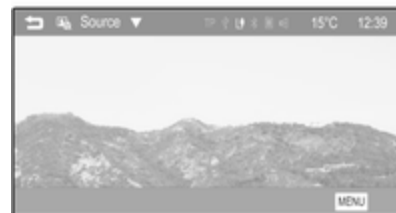

**Notice**

Apart from settings such as volume, tone and display, all functions need to be operated via the auxiliary device.

**Using the AUX movie menu**

Tap on the **MENU** screen button to open the **AUX Movie menu**.

For detailed information on the available settings, see the corresponding descriptions for USB devices below.

**USB device****Activating the USB device function**

If the USB device is not yet connected to the Infotainment system, connect the device ↗ 30 and then continue as described below.

**In case the USB device is already connected:**

If required, press the  button and then select the **Gallery** screen button to open the picture or movie main menu last selected.

If required, select the **Source** screen button to open a drop down list and then select **USB (Movie)** to open the respective main menu.

Playback of movie files starts automatically.

**Interrupting and resuming playback**

Tap on the **||** screen button to interrupt playback. The screen button changes to **▶**.

Tap on the **▶** screen button to resume playback.

**Playing the next or previous track**

Tap on the **▶|** screen button to play the next movie file.

Tap on the **◀|** screen button within the first 5 seconds of the movie playing to return to the previous movie file.

**Returning to the beginning of the current movie**

Tap on the **◀** screen button after 5 seconds of the movie playing.

**Fast forwarding and rewinding**

Hold down the **◀** or **▶** screen buttons. Release the respective button to return to the normal playback mode.

**Full screen**

Tap on the  screen button to switch to full screen mode. Tap on the screen again to leave full screen mode.

**Using the USB movie menu**

Tap on the **MENU** screen button to open the USB movie menu.



### Movie file list

All lists with movie files are displayed. Search for the movie you want to display and select it. The respective movie starts playing.

### Clock/temp. display

If you want the time and temperature to be displayed in full screen mode, set **Clock/temp. display** to **On**.

### Display settings

Adjust the brightness and contrast of the movie display.



Set **Brightness** to a value between **-9** and **9**.

Set **Contrast** to a value between **-15** and **15**.

### Tone settings

For a detailed description ⇨ 16.

### Activating or deactivating subtitle and audio language

If the movie has a subtitle and audio language, you can activate or deactivate these options.

Select the ◀ screen button on the right side of the screen.

To activate or deactivate the subtitle language, set the [A] function to **On** or **Off**.

To activate or deactivate the audio language, set the [A] function to **On** or **Off**.

## Using smartphone applications

Before an approved application can be operated using the controls and menus of the Infotainment system the respective application must be installed on the smartphone.

### Supported applications

Press the [A] button and then select the **Apps** screen button to open the respective menu.

The menu shows which Smartphone applications are currently supported by the Infotainment system, see "Displaying or hiding application icons" below.





Find a detailed description of the respective application on the website of the corresponding software producer.

### Starting an application

If not yet connected to the Infotainment system, connect the smartphone:

- **iPod/iPhone:** connect the device to the USB port ↪ 30
- **Android phone:** establish a Bluetooth connection ↪ 45.

If not installed, download the respective application to your Smartphone.

Press the  button and then select the **Apps** screen button to open the respective menu.

Tap on the screen button of the desired application. A connection to the respective application installed on the connected Smartphone is established.

The main menu of the application is shown on the display of the Infotainment system.

#### Notice

Ensure good GPS reception of the Smartphone when using a navigation application.

### Displaying or hiding application icons

You can define which of the approved applications supported by the Infotainment system are visible and selectable in the **Apps** menu.

Select the  **Settings** screen button in the bottom line of the **Apps** main menu to open the **App settings** menu.



Select or deselect the desired applications and then select the **OK** screen button.

## Speech recognition

General information .....	42
Usage .....	42

### General information

The Siri Eyes Free feature of the Infotainment system allows access to Siri, the speech interpretation and recognition interface on your iPhone or iPod. See the user guide of your iPhone or iPod to find out whether it supports Siri.

Siri Eyes Free works with most of the built-in apps on your iPhone or iPod. You can ask Siri, e.g. to call people, play music, hear and compose text messages, dictate emails, hear new notifications, get directions, or add reminders. For detailed information, see the user guide of your iPhone or iPod.

### Important notes

- In order to use Siri Eyes Free, your iPhone or iPod needs to be connected to the Infotainment system via USB cable ↷ 30 or via Bluetooth ↷ 45.

- Siri Eyes Free requires 3G or wifi internet access on your iPhone or iPod.
- Siri Eyes Free is not compatible with the approved smartphone apps ↷ 40 supported by the Infotainment system. That means you cannot control these apps via Siri Eyes Free.

## Usage

### Activating speech recognition

Press the  button on the right side of the steering wheel to start a speech recognition session. A voice command message is displayed on the screen.

As soon as a beep is heard, you can say a command. For information on the commands supported, see the user guide of your iPhone or iPod.

**Adjusting the volume of voice prompts**

Press the + / - buttons on the right side of the steering wheel to increase or decrease the volume of voice prompts.

**Interrupting a voice prompt**

As an experienced user, you can interrupt a voice prompt by selecting the cancel screen button in the voice command message.

A beep is heard immediately. You may now directly state a command without having to wait.

**Deactivating speech recognition**

Select the  button on the right side of the steering wheel. The voice command message disappears, the speech recognition session is ended.

## Phone

General information .....	44
Bluetooth connection .....	45
Emergency call .....	48
Operation .....	48
Mobile phones and CB radio equipment .....	53

### General information

The Phone portal provides you with the possibility of having mobile phone conversations via a vehicle microphone and the vehicle loudspeakers as well as operating the most important mobile phone functions via the Infotainment system in the vehicle. To be able to use the Phone portal, the mobile phone must be connected to the Infotainment system via Bluetooth.

Not all Phone functions are supported by every mobile phone. The usable phone functions depend on the relevant mobile phone and network provider. You will find further information on this in the operating instructions for your mobile phone, or you can enquire about them with your network provider.

### Important information for operation and traffic safety

#### Warning

Mobile phones have effects on your environment. For this reason safety regulations and directions have been prepared. You should be familiar with the related directions before you use the telephone function.

#### Warning

Use of the hands-free facility while driving can be dangerous because your concentration is reduced when telephoning. Park your vehicle before you use the hands-free facility. Follow the stipulations of the country in which you find yourself at present.

Do not forget to follow the special regulations that apply in specific areas and always switch off the mobile phone if the use of mobile

phones is prohibited, if interference is caused by the mobile phone or if dangerous situations can occur.

## Bluetooth

The Phone portal is certified by the Bluetooth Special Interest Group (SIG).

You will find further information about the specification on the Internet at <http://www.bluetooth.com>

## Bluetooth connection

Bluetooth is a radio standard for the wireless connection of e.g. mobile phones, iPod/iPhone models, or other devices.

To be able to set up a Bluetooth connection to the Infotainment system, the Bluetooth function of the Bluetooth device has to be activated. For further information, please consult the user guide of the Bluetooth device.

Via the **Bluetooth settings** menu, pairing (PIN code exchange between Bluetooth device and Infotainment system) and connecting of the Bluetooth devices to the Infotainment system are carried out.

### Bluetooth settings menu

Press the  button and then select the **Settings** screen button.

Select **Connection settings** and then **Bluetooth settings** to display the respective menu.

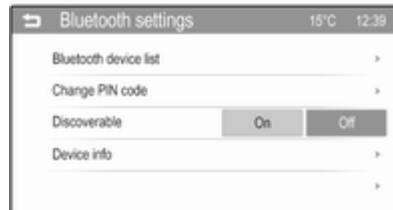

## Pairing a device

### Important information

- Up to five devices can be paired to the system.
- Only one paired device can be connected to the Infotainment system at a time.
- Pairing normally only needs to be carried out once, unless the device is deleted from the list of paired devices. If the device has been connected previously, the Infotainment system establishes the connection automatically.
- Bluetooth operation considerably drains the device's battery. Therefore, connect the device to the power outlet for charging.

### Pairing a new device via the Bluetooth settings menu

1. Press the  button and then select the **Settings** screen button. Select **Connection settings** and then **Bluetooth settings** to display the respective menu.

- On the Infotainment system: set the **Discoverable** function to **On** to make the Infotainment system visible to the Bluetooth device.

On the Bluetooth device: activate the Bluetooth function and the discoverability mode.

- On the Infotainment system: select **Bluetooth device list** to display the respective submenu.



- On the Infotainment system: tap on the **Search Bluetooth Device** screen button. All discoverable Bluetooth devices in the environment are displayed in a list.

- Tap on the Bluetooth device you wish to pair.

- If SSP (secure simple pairing) is supported:

Confirm the messages on the Infotainment system and the Bluetooth device.

If SSP (secure simple pairing) is not supported:



On the Infotainment system: an **Info** message is displayed asking you to enter a PIN code on your Bluetooth device.

On the Bluetooth device: enter the PIN code and confirm your input.

- The Infotainment system and the device are paired.



### Notice

If the Bluetooth device is successfully paired, the  symbol beside the Bluetooth device indicates that the phone function is enabled and the  symbol beside the Bluetooth device indicates that the Bluetooth music function is enabled.

### Notice

The connected device and the available options are highlighted.

### Notice

If the Bluetooth connection fails, a failure message is displayed on the screen of the Infotainment system.

8. The phone book is downloaded automatically to the Infotainment system. If this function is not supported by the Bluetooth device, a corresponding message is displayed.

### Pairing a new device via the Phone menu

Press the  button and then select the **Phone** screen button.

Confirm the **Info** message asking whether you wish to pair a Bluetooth device. The **Bluetooth device list** menu is displayed.

Proceed from step 4 as described above.

If the device has been successfully paired, the **Phone** main menu is displayed.



### Changing the Bluetooth PIN code

Press the  button and then select the **Settings** screen button.

Select **Connection settings, Bluetooth settings** and then **Change PIN code** to display the respective menu.

Enter the desired four-digit PIN code.

To delete an entered number, select the  screen button.

Confirm your input by selecting the **OK** screen button.

### Connecting a paired device

Press the  button and then select the **Settings** screen button.

Select **Connection settings, Bluetooth settings** and then **Bluetooth device list** to display the respective menu.

Select the Bluetooth device you wish to connect. The device is connected.

### Disconnecting a device

Press the  button and then select the **Settings** screen button.

Select **Connection settings, Bluetooth settings** and then **Bluetooth device list** to display the respective menu.

Select the Bluetooth device currently connected. You are prompted with a question.

Select the **Yes** screen button to disconnect the device.

### Deleting a device

Press the  button and then select the **Settings** screen button.

Select **Connection settings, Bluetooth settings** and then **Bluetooth device list** to display the respective menu.

Select the **Del** screen button beside the Bluetooth device. You are prompted with a question.

Select the **Yes** screen button to delete the device.

### Device info

Press the  button and then select the **Settings** screen button.

Select **Connection settings, Bluetooth settings** and then **Bluetooth device list** to display the respective menu.

The information displayed includes **Device name, Address, and PIN code**.

### Emergency call

#### Warning

Connection setup cannot be guaranteed in all situations. For this reason you should not rely exclusively on a mobile phone when a vitally important communication (e.g. a medical emergency) is concerned.

In some networks it may be necessary for a valid SIM card to be properly inserted in the mobile phone.

#### Warning

Bear in mind that you can make and receive calls with the mobile phone, if it is in a service area with a sufficiently strong signal. Under certain circumstances emergency calls cannot be made on all mobile phone networks; it is possible that they cannot be made when certain network services and/or telephone functions are active. You can enquire about this with the local network operators.

The emergency call number can differ depending on the region and country. Please enquire beforehand about the correct emergency call number for the relevant region.

### Making an emergency call

Dial the emergency call number (e.g. **112**).

The telephone connection to the emergency call centre is set up.

Answer when the service personnel questions you about the emergency.

#### Warning

Do not end the call until you are requested to do so by the emergency call centre.

### Operation

As soon as a connection via Bluetooth has been set up between your mobile phone and the Infotainment system, you can operate many functions of your mobile phone via the Infotainment system.

#### Notice

In the handsfree mode mobile phone operation continues to be possible, e.g. taking a call or adjusting the volume.



After the setup of a connection between the mobile phone and the Infotainment system, mobile phone data is transmitted to the Infotainment system. This can take some time depending on the mobile phone and the amount of data to be transferred. During this period, operation of the mobile phone via the Infotainment system is possible only to a limited extent.

#### Notice

Not every mobile phone supports all functions of the Phone portal. Therefore deviations from the range of functions described with these specific mobile phones are possible.

### Phone main menu

Press the  button and then select the **Phone** screen button to display the respective menu.



#### Notice

The **Phone** main menu is only available, if a mobile phone is connected to the Infotainment system via Bluetooth. For a detailed description ⇨ 45.

Many functions of the mobile phone can now be controlled via the **Phone** main menu (and associated submenus), and via the phone specific controls on the steering wheel.



## Initiating a phone call

### Entering a phone number

Press the  button and then select the **Phone** screen button to display the respective menu.

Enter a telephone number using the keypad in the **Phone** main menu.

To delete one or more entered characters, tap or long tap on the ⇐ screen button.

Tap on the  screen button or press the  button on the steering wheel to start dialling.

### Using the phone book

#### Notice

When pairing a mobile phone with the Infotainment system via Bluetooth, the phone book of the mobile phone is downloaded automatically.

If the phone book is not downloaded, consult the operating instructions for your mobile phone.

Press the  button and then select the **Phone** screen button to display the respective menu.

Select the **Phone Book** screen button.

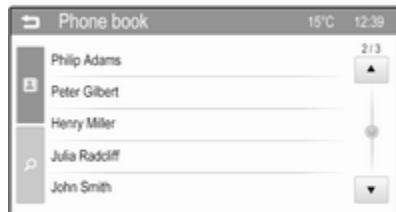

### Quick search

1. Scroll through the list of phone book entries.
2. Tap on the contact you wish to call. A menu with all phone numbers stored for the selected contact is displayed.



3. Select the desired phone number to initiate the call.

### Search menu

If the phone book contains a great number of entries, you can conveniently search for the desired contact via the search menu.

Select the  screen button in the **Phone book** menu to display the search tab.

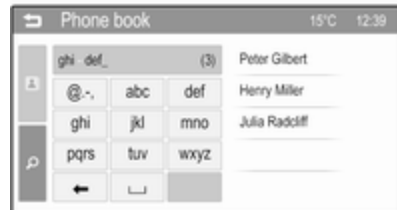

As on a telephone or mobile phone, the letters are organised in alphabetical groups on the screen buttons: **abc**, **def**, **ghi**, **jkl**, **mno**, **pqrs**, **tuv**, and **wxyz**.

Use the  screen button to delete an entered group of letters.

1. Select the button containing the first letter of the contact you wish to search for.

For example: If the contact you wish to search for starts with 'g' select the **ghi** screen button.

All contacts containing one of the letter on this button, in this case 'g', 'h', and 'i', are displayed.

2. Select the button containing the second letter of the contact you wish to search for.
3. Continue to enter more letters of the contact you wish to search for until the desired contact is displayed.
4. Tap on the contact you wish to call. A menu with all phone numbers stored for the selected contact is displayed.
5. Select the desired phone number to initiate the call. The following display is shown.





### Using the call history

All incoming, outgoing, or missed calls are registered.

Press the  button and then select the **Phone** screen button to display the respective menu.

Select the **Call History** screen button to display the respective menu.



Select the  screen button for outgoing calls, the  screen button for missed calls and the  screen button for incoming calls. The respective call list is displayed.



Select the desired entry to initiate a call.

### Redialling a number

The last dialled phone number can be redialled.

Press the ☎ button and then select the **Phone** screen button to display the respective menu.

Tap on the ☎ screen button for a few seconds. The number last dialled is redialled.

### Using speed dial numbers

Speed dial numbers that are stored on the mobile phone can also be dialled using the keypad of the **Phone** main menu.

Press the ☎ button and then select the **Phone** screen button to display the respective menu.

Enter the desired speed dial number:

If the speed dial number consists of one digit, a long tap on the respective digit initiates the call.

If the speed dial number consists of two digits, tap on the first digit and then long tap on the second digit to initiate the call.

### Incoming phone call

#### Taking a call

If an audio mode, e.g. the radio or USB mode, is active at the moment a call comes in, the audio source will be muted and stay muted until the call ends.

A message with the caller's phone number or name (if available) is displayed.

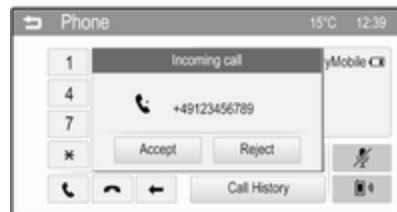

To answer the call, select the **Accept** screen button in the message or press the ☎ button on the steering wheel.

#### Rejecting a call

To reject the call, select the **Reject** screen button in the message or press the ☎ button on the steering wheel.

#### Changing the ring tone

Press the ☎ button and then select the **Settings** screen button.

Select **Connection settings** and then **Change ringtone** to display the respective menu. A list of ring tones is displayed.

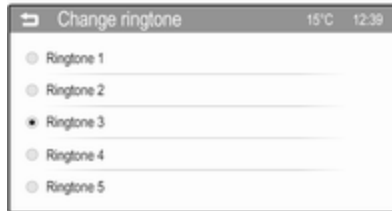

Select one of the ring tones.

For a detailed description on the **Ringtone volume** ⇨ 17.

### Functions during a call

During an ongoing phone call the **Phone** main menu will be displayed.



### Deactivating the handsfree mode temporarily

To continue the conversation via the mobile phone, select the  screen button.

To return to the handsfree mode, select the  screen button again.

#### Notice

If activated, the corresponding symbol is highlighted.

### Deactivating the microphone temporarily

To mute the microphone, select the  screen button.

To reactivate the microphone, select the  screen button again.

#### Notice

If activated, the corresponding symbol is highlighted.

### Ending a phone call

Select the  screen button to end the call.

## Mobile phones and CB radio equipment

### Installation instructions and operating guidelines

The vehicle specific installation instructions and the operating guidelines of the mobile phone and handsfree manufacturer must be observed when installing and operating a mobile telephone. Failure to do so could invalidate the vehicle type approval (EU directive 95/54/EC).

Recommendations for fault-free operation:

- Professionally installed exterior antenna to obtain the maximum range possible,
- Maximum transmission power 10 watts,
- Installation of the phone in a suitable spot, consider relevant Note in the Owner's Manual, chapter **Airbag system**.

Seek advice on predetermined installation points for the external antenna or equipment holder and ways of using devices with a transmission power exceeding 10 watts.

Use of a handsfree attachment without external antenna with mobile telephone standards GSM 900/1800/1900 and UMTS is only permitted if the maximum transmission power of the mobile telephone is 2 watts for GSM 900 or 1 watt for the other types.

For reasons of safety, do not use the phone while driving. Even use of a handsfree set can be a distraction while driving.

### Warning

Operation of radio equipment and mobile telephones which fail to meet above mentioned mobile telephone standards is only permitted using an antenna located outside of the vehicle.

### Caution

Mobile telephones and radio equipment may lead to malfunctions in the vehicle electronics when operated inside the vehicle with no exterior antenna, unless the above mentioned regulations are observed.



# Index

<b>A</b>	
Activating AUX audio.....	33
Activating AUX movie.....	38
Activating Bluetooth music.....	33
Activating iPod audio.....	33
Activating phone.....	48
Activating radio.....	20
Activating USB audio.....	33
Activating USB movie.....	38
Activating USB picture.....	36
Apps.....	30, 40
Audio files.....	30
Autostore lists.....	21
Retrieving stations.....	21
Storing stations.....	21
Auto volume.....	17
<b>AUX</b>	
AUX audio menu.....	33
AUX movie menu.....	38
Connecting device.....	30
General information.....	30
<b>B</b>	
Basic operation.....	13
<b>Bluetooth</b>	
Bluetooth connection.....	45
Bluetooth music menu.....	33
Connecting device.....	30
General information.....	30
Pairing.....	45
Phone.....	48
Bluetooth connection.....	45
<b>C</b>	
<b>Call</b>	
Functions during a call.....	48
Incoming call.....	48
Initiating a phone call.....	48
Ring tone.....	48
Call history.....	48
Category list.....	22
<b>Control elements</b>	
Infotainment system.....	8
Steering wheel.....	8
Control elements overview.....	8
<b>D</b>	
DAB.....	27
Date settings.....	10
Digital audio broadcasting.....	27
Displaying pictures.....	36
Display settings.....	36, 38
Dynamic range compression.....	27
<b>E</b>	
Emergency call.....	48
EPG.....	22



<b>F</b>			
Favourite lists.....	22	iPod	
Retrieving stations.....	22	Connecting device.....	30
Storing stations.....	22	General information.....	30
File formats		iPod audio menu.....	33
Audio files.....	30	<b>L</b>	
Movie files.....	30	Language.....	10
Picture files.....	30	<b>M</b>	
Frequency band.....	27	Maximum startup volume.....	17
<b>G</b>		Menu operation.....	13
General information.....	30, 42, 44	Mobile phones and CB radio	
Apps.....	30	equipment.....	53
AUX.....	30	Movie files.....	30
Bluetooth.....	30	Mute.....	10
DAB.....	27	<b>N</b>	
Infotainment system.....	6	Navigation.....	40
Phone.....	44	<b>O</b>	
Smartphone applications.....	30	Operation.....	48
USB.....	30	External devices.....	30
<b>H</b>		Menu.....	13
Home menu.....	13	Phone.....	48
<b>I</b>		Radio.....	20
Infotainment control panel.....	8	<b>P</b>	
Intellitext.....	22	Pairing.....	45
		Phone	
		Bluetooth.....	44
		Bluetooth connection.....	45
		Call history.....	48
		Emergency calls.....	48
		Entering a number.....	48
		Functions during a call.....	48
		General information.....	44
		Incoming call.....	48
		Phone book.....	48
		Phone main menu.....	48
		Selecting the ring tone.....	48
		Speed dial number.....	48
		Phone book.....	48
		Picture files.....	30
		Playing audio.....	33
		Playing movies.....	38
		<b>R</b>	
		Radio	
		Activating.....	20
		Autostore lists.....	21
		Category list.....	22
		Configuring DAB.....	27
		Configuring RDS.....	26
		DAB announcements.....	22
		Digital audio broadcasting	
		(DAB).....	27
		Dynamic range compression.....	27
		EPG current program.....	22
		EPG station list.....	22
		Favourite lists.....	22
		Frequency band.....	27

Intellitext.....	22	Station lists.....	22	Menu.....	13
Radio data system (RDS).....	26	Station search.....	20	Phone.....	48
Regional.....	26	Steering wheel audio controls.....	8	Radio.....	20
Regionalisation.....	26	Storing stations.....	21, 22	USB.....	30
Retrieving stations.....	21, 22	Switching the Infotainment system on.....	10	USB	
Selecting the waveband.....	20	System settings.....	18	Connecting device.....	30
Station lists.....	22	Language.....	10	General information.....	30
Station search.....	20	Radio factory settings.....	10	USB audio menu.....	33
Station tuning.....	20	Text scroll.....	10	USB movie menu.....	38
Storing stations.....	21, 22	Time and date.....	10	USB picture menu.....	36
TP volume.....	26	Vehicle settings.....	10	Using smartphone applications....	40
Traffic announcements.....	26			<b>V</b>	
Updating station lists.....	22	<b>T</b>		Vehicle settings.....	10
Usage.....	20	Text scroll.....	10	Voice recognition.....	42
Waveband menus.....	22	Theft-deterrent feature .....	7	Volume	
Radio data system (RDS) .....	26	Time settings.....	10	Auto volume.....	17
Radio factory settings.....	10	Tone settings.....	16	Maximum startup volume.....	17
RDS.....	26	Touch beep volume.....	17	Mute function.....	10
Regional.....	26	TP volume.....	17	Ring tone volume.....	17
Regionalisation.....	26	Traffic announcements		Setting the volume.....	10
Retrieving stations.....	21, 22	Activating.....	26	Speed compensated volume....	17
Ring tone		TP volume.....	26	Touch beep volume.....	17
Changing the ring tone.....	48	<b>U</b>		TP volume.....	17
Ring tone volume.....	17	Updating station lists.....	22	Volume limitation at high temperatures.....	10
<b>S</b>		Usage.....	10, 20, 42	Volume settings.....	17
Siri Eyes Free.....	42	AUX.....	30		
Smartphone.....	30, 40	Bluetooth.....	30		
Speech recognition.....	42	iPod.....	30		
Speed dial numbers.....	48				

---

**W**

Waveband menus.....	22
Waveband selection.....	20



---

## CD 3.0 BT / R 3.0

Introduction .....	62
Radio .....	74
CD Player .....	82
AUX input .....	85
USB port .....	86
Bluetooth music .....	89
Phone .....	91
Index .....	100

## Introduction

General information .....	62
Theft-deterrent feature .....	63
Control elements overview .....	64
Usage .....	68
Basic operation .....	70
Tone settings .....	72
Volume settings .....	73

## General information

The Infotainment system provides you with state-of-the-art in-car infotainment.

Using the FM, AM or DAB radio functions, you may register up to 36 stations on six favourites pages.

The integrated audio player will entertain you with audio CDs and MP3/WMA CDs.

You can connect external data storage devices, e.g. iPod, MP3 player, USB stick, or a portable CD player to the Infotainment system as further audio sources; either via cable or via Bluetooth.

In addition, the Infotainment system is equipped with a Phone portal that allows for comfortable and safe use of your mobile phone in the vehicle.

Optionally, the Infotainment system can be operated using controls on the steering wheel.

The well-thought-out design of the control elements and the clear displays enable you to control the system easily and intuitively.

## Notice

This manual describes all options and features available for the various Infotainment systems. Certain descriptions, including those for display and menu functions, may not apply to your vehicle due to model variant, country specifications, special equipment or accessories.

## Important information on operation and traffic safety

### Warning

The Infotainment system must be used so that the vehicle can be driven safely at all times. If in doubt, stop the vehicle and operate the Infotainment system while the vehicle is stationary.

## Radio reception

Radio reception may be disrupted by static, noise, distortion or loss of reception due to:

- changes in distance from the transmitter,
- multipath reception due to reflection,
- shadowing.

## Theft-deterrent feature

The Infotainment system is equipped with an electronic security system for the purpose of theft deterrence.









The Infotainment system therefore functions only in your vehicle and is worthless to a thief.

## Control elements overview

### Control panel CD 3.0 BT





- |   |  |  |
|---|--|--|
| <p><b>1</b>  VOL knob</p> <p>Press: switch on/off<br/>Infotainment system ..... 68</p> <p>Turn: adjust volume ..... 68</p>   | <p><b>8</b> FAV 1-2-3 button</p> <p>Radio favourites and<br/>autostore lists ..... 76</p> <p><b>9</b> MEDIA button</p> <p>Activate media or change<br/>audio source ..... 68</p> <p><b>10</b> TP button</p> <p>Activate or deactivate<br/>radio traffic service ..... 78</p> <p><b>11</b> RADIO button</p> <p>Activate radio or change<br/>waveband ..... 74</p> <p><b>12</b> TONE button</p> <p>Tone settings ..... 72</p> <p><b>13</b>   button</p> <p>Radio: search backwards ..... 74</p> <p>CD/MP3/WMA: skip track<br/>backwards ..... 83</p> | <p><b>14</b> INFO button</p> <p>Radio: Information about<br/>the current station</p> <p>CD/MP3/WMA:<br/>Information about the<br/>current track</p> <p><b>15</b>  /  button</p> <p>Open telephone main menu . 91</p> <p>or activate/deactivate<br/>mute function ..... 68</p> <p><b>16</b> Disc slot</p> <p><b>17</b>  button</p> <p>Eject disc ..... 83</p> <p><b>18</b> Radio station buttons 1 - 6</p> <p>Long press: save station ..... 76</p> <p>Short press: select station .... 76</p> |
| <p><b>2</b> Display</p> <p><b>3</b> MENU-TUNE knob</p> <p>Central control for<br/>selection and navigation in<br/>menus ..... 70</p> <p><b>4</b> AUX input ..... 85</p> <p><b>5</b>  BACK button</p> <p>Menu: one level back ..... 70</p> <p>Input: delete last character<br/>or entire entry ..... 70</p> <p><b>6</b> CONFIG button</p> <p>System settings ..... 68</p> <p><b>7</b>   button</p> <p>Radio: search forwards ..... 74</p> <p>CD/MP3/WMA: skip track<br/>forwards ..... 83</p> |  |  |

## Control panel R 3.0

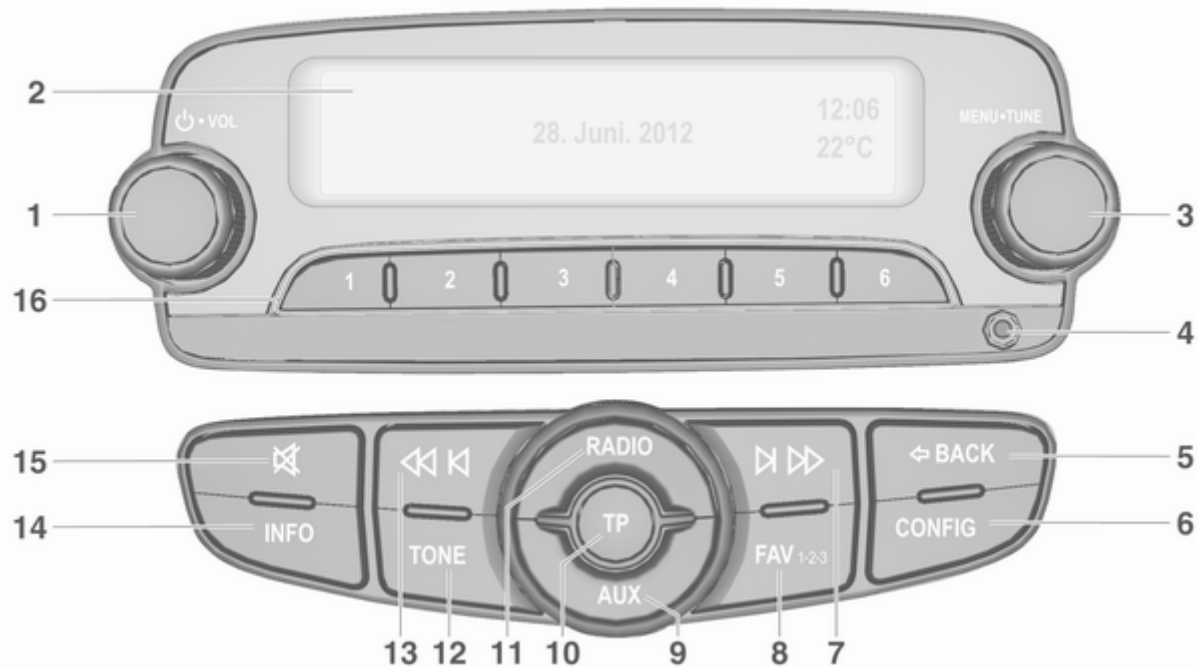

- |  |   |
|--|---|
| <p><b>1</b>  VOL knob<br/>Press: switch on/off<br/>Infotainment system ..... 68<br/>Turn: adjust volume ..... 68</p> <p><b>2</b> Display</p> <p><b>3</b> MENU-TUNE knob<br/>Central control for<br/>selection and navigation in<br/>menus ..... 70</p> <p><b>4</b> AUX input ..... 85</p> <p><b>5</b>  BACK button<br/>Menu: one level back ..... 70<br/>Input: delete last character<br/>or entire entry ..... 70</p> <p><b>6</b> CONFIG button<br/>System settings ..... 68</p> <p><b>7</b>   button<br/>Search forwards ..... 74</p> <p><b>8</b> FAV 1-2-3 button<br/>Radio favourites and<br/>autostore lists ..... 76</p> | <p><b>9</b> AUX button<br/>Activate auxiliary device ..... 68</p> <p><b>10</b> TP button<br/>Activate or deactivate<br/>radio traffic service ..... 78</p> <p><b>11</b> RADIO button<br/>Activate radio or change<br/>waveband ..... 74</p> <p><b>12</b> TONE button<br/>Tone settings ..... 72</p> <p><b>13</b>   button<br/>Search backwards ..... 74</p> <p><b>14</b> INFO button<br/>Information about the<br/>current radio station</p> <p><b>15</b>  button<br/>Activate/deactivate mute<br/>function ..... 68</p> <p><b>16</b> Radio station buttons 1 - 6<br/>Long press: save station ..... 76<br/>Short press: select station .... 76</p> |
|--|---|

## Steering wheel audio controls

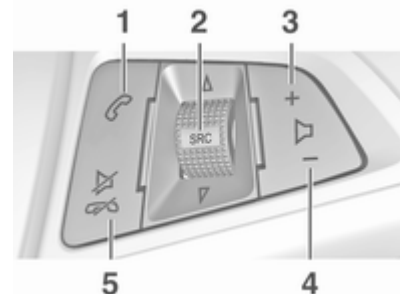

- 1** button  
Short press: take phone call . 91  
or activate redial function ..... 95  
or dial number in call list ..... 95  
Long press: open call list ..... 95  
or switch handsfree mode  
on/off ..... 95
- 2** SRC (Source) ..... 68  
Press: select audio source .... 68

With radio active: turn upwards/downwards to select next/previous preset radio station .....	74
With CD player active: turn upwards/downwards to select next/previous CD/MP3/WMA track .....	83
With Phone portal active and call list open (see item 1): turn upwards/downwards to select next/previous entry in call list .....	95
With Phone portal active and calls waiting: turn upwards/downwards to switch between calls .....	95
<b>3</b> Increase volume	
<b>4</b> Reduce volume	
<b>5</b>  button	
Press: end/decline call .....	95
or close call list .....	95
or activate/deactivate mute function .....	68

## Usage

### Control elements

The Infotainment system is operated via function buttons, a **MENU-TUNE** knob and menus that are shown on the display.

Inputs are made optionally via:

- the control panel on the Infotainment system ⇨ 64
- audio controls on the steering wheel ⇨ 64.

### Switching the Infotainment system on or off

Press the  **VOL** knob briefly. After switching on, the last selected Infotainment source becomes active.

Press the  **VOL** knob again to turn the system off.

### Automatic switch-off

If the Infotainment system is switched on using the  **VOL** knob while the ignition is turned off, it will switch off again automatically 10 minutes after the last user input.

## Setting the volume

Turn the  **VOL** knob. The current setting is shown on the display.

When the Infotainment system is switched on, the last selected volume is set, provided this setting is lower than the maximum startup volume (see below).



The following inputs can be made separately:

- the maximum startup volume ⇨ 73
- the volume of traffic announcements ⇨ 73.

### Speed compensated volume

When speed compensated volume is activated ⇨ 73, the volume is adapted automatically to make up for the road and wind noises as you drive.

### Mute function

Press the  /  button or the  button (if Phone portal available: press for a few seconds) to mute the audio sources.

To cancel the mute function: turn the **VOL** knob or press the **🔇 / 🔊** button (if Phone portal available: press for a few seconds) or press the **🔇** button again.

### Volume limitation at high temperatures

At very high temperatures inside the vehicle the Infotainment system limits the maximum adjustable volume. If necessary, the volume is decreased automatically.

### Modes of operation

#### Radio

Press the **RADIO** button to open the radio main menu or to change between the different wavebands.

Press the **MENU-TUNE** knob to open the waveband menus with options for the station selection.

For a detailed description of the radio functions ⇨ 74.

#### Audio players

CD 3.0 BT: Press the **MEDIA** button once or several times to open the CD, USB, iPod or AUX main menu (if available) or to switch between these menus.

R 3.0: Press the **AUX** button to open the AUX main menu.

Press the **MENU-TUNE** knob to open the relevant menus with options for the track selection.

For a detailed description of:

- CD player functions ⇨ 82
- AUX functions ⇨ 85
- USB port functions ⇨ 86
- Bluetooth music functions ⇨ 89.

#### Phone

Press the **📞 / 🔇** button briefly to open the telephone menu.

Press the **MENU-TUNE** knob to open the phone menu with options for the input and selection of numbers.

For a detailed description of the Phone portal ⇨ 91.

### System settings

#### Adjusting the language

The menu texts on the Infotainment system's display can be displayed in various languages.

Press the **CONFIG** button to open the **Settings** menu.

Select the **Languages** menu item in the **Settings** menu to display the respective menu.

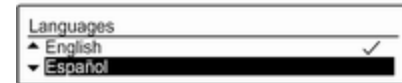

Choose the desired language for the menu texts.

#### Notice

Find a detailed description for the menu operation ⇨ 70.

#### Time and date settings

Find a detailed description in your Owner's Manual.

### Vehicle settings

Find a detailed description in your Owner's Manual.

### Other settings

Find a detailed description for all other settings in the relevant chapters.

### Restore factory settings

All settings, e.g. the volume and tone settings, the favourite lists, or the Bluetooth device list, can be reset to the factory defaults.

Press the **CONFIG** button to open the **Settings** menu. Select **Vehicle settings** and then **Restore factory settings**.

The submenu prompts you with a question. To reset all values to the factory defaults, select **Yes**.

## Basic operation

### MENU-TUNE knob

The **MENU-TUNE** knob is the central control element for the menus.

Turn the **MENU-TUNE** knob:

- to mark a menu option
- to set a numeric value.

Press the **MENU-TUNE** knob:

- to select or activate the marked option
- to confirm a set value
- to switch a system function on/off.

### ⇐ BACK button

Press the ⇐ **BACK** button briefly to:

- exit a menu
- return from a submenu to the next higher menu level
- delete the last character in a character sequence.

Press and hold the ⇐ **BACK** button for a few seconds to delete the entire entry.

## Examples of menu operation

### Selecting an option



Turn the **MENU-TUNE** knob to move the cursor (= coloured background) to the desired option.

Press the **MENU-TUNE** knob to select the marked option.

### Submenus

An arrow on the right-hand edge of the menu indicates that after selection of the option a submenu with further options will be opened.

## Activating a setting

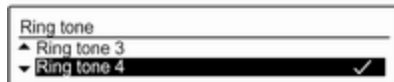

Turn the **MENU-TUNE** knob to mark the desired setting.

Press the **MENU-TUNE** knob to activate the setting.

## Setting a value



Turn the **MENU-TUNE** knob to change the current value of the setting.

Press the **MENU-TUNE** knob to confirm the set value.

The cursor then switches to the next value. If all values are set, you are automatically returned to the next higher menu level.

## Adjusting a setting

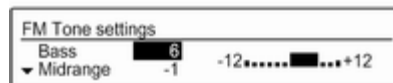

Turn the **MENU-TUNE** knob to adjust the setting.

Press the **MENU-TUNE** knob to confirm the setting.

## Switching a function on or off



Turn the **MENU-TUNE** knob to mark the function to be switched on or off.

Press the **MENU-TUNE** knob to switch between the settings **On** and **Off**.

## Entering a character sequence



To enter character sequences, e.g. PIN codes or telephone numbers:

Turn the **MENU-TUNE** knob to mark the desired character.

Press the **MENU-TUNE** knob to confirm the marked character.

The last character in the character sequence can be deleted by selecting **⊗** on the display or pressing the **↶** **BACK** button. Pressing and holding the **↶** **BACK** button deletes the entire entry.

To change the position of the cursor in the character sequence already entered, select **◀** or **▶** on the display.

## Tone settings

In the tone settings menu the tone characteristics can be set differently for each radio waveband and each audio player source.



Press the **TONE** button to open the tone settings menu.

## Setting bass, midrange, and treble

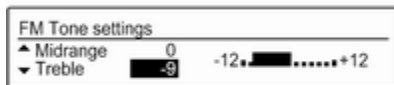

Scroll through the list and select **Bass**, **Midrange** or **Treble**.

Set the desired value for the selected option.

## Setting the volume distribution between front and rear

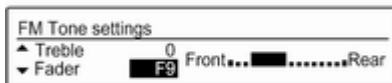

Scroll through the list and select **Fader**.

Set the desired value.

## Setting the volume distribution between right and left



Scroll through the list and select **Balance**.

Set the desired value.

## Selecting a tone style

Scroll through the list and select **EQ** (Equaliser). The **EQ presets** menu is displayed.



The displayed options offer optimised bass, middle, and treble presets for the relevant style of music.

Select the desired option.

## Setting an individual setting to "0"

Select the desired option and press the **MENU-TUNE** knob for a few seconds.

The value is reset to "0".

## Setting all settings to "0" or "OFF"

Press the **TONE** button for a few seconds.



All values are reset to "0", the EQ preset is set to "OFF".

## Volume settings

### Adjusting the speed compensated volume

Press the **CONFIG** button to open the **Settings** menu.

Select **Radio settings** and then **Auto volume control**.

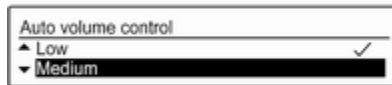

The **Auto volume control** function can be deactivated or the degree of the volume adaptation can be selected in the menu displayed.

Select the desired option.

### Adjusting the maximum startup volume

Press the **CONFIG** button to open the **Settings** menu.

Select **Radio settings** and then **Maximum startup volume**.

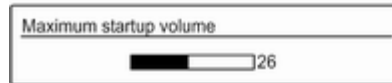

Set the desired value.

### Adjusting the volume of traffic announcements

The volume of traffic announcements can be preset to increase or decrease in proportion to the normal audio volume.

Press the **CONFIG** button to open the **Settings** menu.

Select **Radio settings**, **RDS options** and then **TA volume**.

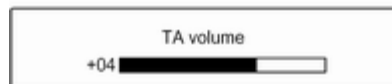

Set the desired value.

### Adjusting the volume of the ring tone

Press the **CONFIG** button to open the **Settings** menu.

Select **Phone settings**, **Sound & Signals** and then **Ring Volume**.

Set the desired value.

## Radio

Usage .....	74
Station search .....	74
Autostore lists .....	75
Favourite lists .....	76
Waveband menus .....	76
Radio data system (RDS) .....	78
Digital audio broadcasting .....	80

## Usage

### Activating the radio

Press the **RADIO** button to open the radio main menu.



The station last played will be received.

### Selecting the waveband

Press the **RADIO** button once or several times to select the desired waveband.

The station last played in that waveband will be received.

## Station search

### Automatic station search

Briefly press the buttons **<< K** or **K >>** to play the next station in the station memory.

## Manual station search

Press and hold the buttons **<< K** or **K >>**. Release the respective button when the required frequency has almost been reached on the frequency display.

A search is made for the next station that can be received and it is played automatically.

### Notice

**Manual station search:** If the radio does not find a station, it switches automatically to a more sensitive search level. If it still does not find a station, the frequency that was last active is set again.

### Notice

**FM waveband:** when the RDS function is activated, only RDS stations **↔ 78** are searched for, and when the radio traffic service (TP) is activated, only traffic service stations **↔ 78** are searched for.

## Manual station tuning

In the radio main menu, press the **MENU-TUNE** knob to open the respective waveband menu and select **FM manual tuning**, **AM manual tuning** or **DAB manual tuning**.

On the popup frequency display, turn the **MENU-TUNE** knob and set the optimal reception frequency.

## Autostore lists

The stations received best in a waveband can be searched for and stored automatically via the autostore function.

Each waveband has 2 autostore lists (**AS-Stations 1**, **AS-Stations 2**), in each of which 6 stations can be stored.

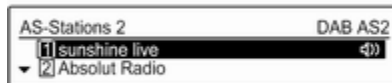

### Notice

The currently received station is marked by .

## Automatic station storing

Keep the **FAV 1-2-3** button pressed until an autostore message is displayed. The 12 strongest stations in the current waveband will be stored in the 2 autostore lists.

To cancel the autostore procedure, press the **MENU-TUNE** knob.

## Storing stations manually

Stations can also be stored manually in the autostore lists.

Set the station to be stored.

Briefly press the **FAV 1-2-3** button once or several times to switch to the desired list.

To store the station in a list position: press the corresponding station button **1...6** until a confirmation message is displayed.

### Notice

Manually stored stations are overwritten in an automatic station storing process.

### Notice

To operate this function, the **AS-Stations** function must be activated (see below).

## Retrieving a station

Briefly press the **FAV 1-2-3** button once or several times to switch to the desired list.

Briefly press one of the station buttons **1...6** to open the station at the corresponding list position.

### Notice

To operate this function, the **AS-Stations** function must be activated (see below).

## Activating the autostore stations function

Press the **CONFIG** button to open the **Settings** menu.

Select **Radio settings** and then **AS-Stations** to open the respective menu.

Set the autostore stations for the FM, AM or DAB waveband to **On**.

## Favourite lists

Stations of all wavebands can be stored manually in the favourite lists.

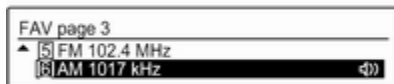

6 stations can be stored in each favourite list. The number of available favourite lists can be set (see below).

### Notice

The currently received station is marked by 📻.

## Storing a station

Set the station to be stored.

Briefly press the **FAV 1-2-3** button once or several times to switch to the desired list.

To store the station in a list position: press the corresponding station button **1...6** until a confirmation message is displayed.

## Retrieving a station

Briefly press the **FAV 1-2-3** button once or several times to switch to the desired list.

Briefly press one of the station buttons **1...6** to open the station at the corresponding list position.

## Defining the number of available favourite lists

Press the **CONFIG** button to open the **Settings** menu.

Select **Radio settings** and then **Radio favourites** to open the menu **Max. number of favourites pages**.

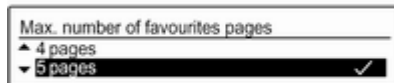

Select the desired number of available favourite lists.

## Waveband menus

Alternative facilities for station selection are available via waveband specific menus.

### Notice

The following displays are shown as examples.

## Stations lists

When in a radio main menu, turn the **MENU-TUNE** knob to open the stations list of the respective waveband.

All receivable FM, AM or DAB stations in the current reception area are displayed.



### Notice

If no station list has been created beforehand, the Infotainment system performs an automatic station search.

Select the desired station.

### Notice

The currently received station is marked by .

## Updating the stations lists

When in a radio main menu, press the **MENU-TUNE** knob to open the relevant waveband menu.

If the stations stored in the waveband-specific station list can no longer be received:

Select the menu item **Update FM stations list**, **Update AM stations list** or **Update DAB stations list** in the respective waveband menu.

A station search is started. Once the search is completed, the station last received will be played.

To cancel the station search: press the **MENU-TUNE** knob.

### Notice

If the Infotainment system features a dual tuner, the stations lists are continuously updated in the background. No manual update is required.

### Notice

If a waveband specific station list is updated the corresponding category list (if available) is also updated.

## Favourites list

Being in a radio main menu, press the **MENU-TUNE** knob to open the relevant waveband menu.

Select **Favourites list**. All stations saved in the favourite lists are displayed.





Select the desired station.

### Notice

The currently received station is marked by .

## Category lists

Numerous RDS  78 and DAB  80 stations broadcast a PTY code, which specifies the type of programme transmitted (e.g. news).

Some stations also change the PTY code depending on the content currently being transmitted.

The Infotainment system stores these stations, sorted by programme type, in the corresponding category list.

To search for a programme type determined by station: select the waveband specific category list option.

A list of programme types currently available is displayed.



Select the desired programme type.

A list of stations is displayed that transmit a programme of the selected type.



Select the desired station.

The category list is updated, too, when the corresponding waveband specific station list is updated.

#### Notice

The currently received station is marked by .

### DAB announcements

Besides their music programmes, numerous DAB stations ⇨ 80 broadcast various announcement categories.

The currently received DAB service (programme) is interrupted when any announcement of previously activated categories is pending.

#### Activating announcement categories

Being in the **DAB menu**, select **DAB announcements** to display the respective menu.

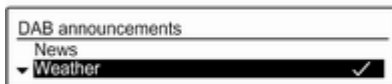

Activate the desired announcement categories.

Several announcement categories can be selected at the same time.

#### Notice

DAB announcements can only be received if the DAB waveband is activated.

### Radio data system (RDS)

RDS is a service of FM stations that considerably facilitates the finding of the desired station and its fault-free reception.

### Advantages of RDS

- On the display, the programme name of the set station appears instead of its frequency.
- During a station search, the Infotainment system tunes in to RDS stations only.
- The Infotainment system always tunes into the best receivable broadcasting frequency of the set station by means of AF (Alternative Frequency).
- Depending on the station that is received, the Infotainment system displays radio text that can contain e.g. information about the current programme.

### Configuring RDS

Press the **CONFIG** button to open the **Settings** menu.

Select **Radio settings** and then **RDS options**.



Set the option **RDS** to **On** or **Off**.

#### Notice

If RDS is switched off, it will be automatically switched on again when a radio station is changed (by search function or preset button).

#### Notice

The following options are only available, if **RDS** is set to **On**.

## RDS options

### Switching regionalisation on and off

At certain times some RDS stations broadcast regionally different programmes on different frequencies.

Set the option **Regional** to **On** or **Off**.

If regionalisation is switched on, only alternative frequencies (AF) with the same regional programmes are selected.

If regionalisation is switched off, alternative frequencies of the stations are selected without regard to regional programmes.

### RDS scrolling text

Some RDS stations hide the programme name in the display line in order to display additional information.

To prevent additional information being displayed:

Set **Text scroll freeze** to **On**.

### TA volume

The volume of traffic announcements (TA) can be preset. For a detailed description ⇨ 73.

### Radio traffic service

(TP = Traffic Programme)

Radio traffic service stations are RDS stations that broadcast traffic news.

### Switching the radio traffic service on and off

To switch the traffic announcement standby facility of the Infotainment system on and off:

Press the **TP** button.

- If the radio traffic service is switched on, [ ] is displayed in the radio main menu.
- Only radio traffic service stations are received.
- If the current station is not a radio traffic service station, a search is started automatically for the next radio traffic service station.
- If a radio traffic service station has been found, [TP] is displayed in the radio main menu.
- Traffic announcements are played at the preset TA volume ⇨ 73.
- If the radio traffic service is switched on, CD/MP3 replay is interrupted for the duration of the traffic announcement.

### Listening to traffic announcements only

Switch on the radio traffic service and completely turn down the volume of the Infotainment system.

### Blocking out traffic announcements

To block out a traffic announcement, e.g. during CD/MP3 replay:

Press the **TP** button or the **MENU-TUNE** knob to confirm the cancelling message on the display.

The traffic announcement is cancelled, but the radio traffic service remains switched on.

### Digital audio broadcasting

Digital audio broadcasting (DAB) is an innovative and universal broadcast system.

DAB stations are indicated by the programme name instead of the broadcasting frequency.



### General information

- With DAB, several radio programmes (services) can be broadcasted on a single frequency (ensemble).
- Besides high-quality digital audio services, DAB is also able to transmit programme-associated data and a multitude of other data services including travel and traffic information.
- As long as a given DAB receiver can pick up the signal sent out by a broadcasting station (even if the signal is very weak), sound reproduction is ensured.
- There is no fading (weakening of the sound that is typical of AM or FM reception). The DAB signal is reproduced at a constant volume.
- If the DAB signal is too weak to be picked up by the receiver, reception is interrupted completely. This incident can be avoided by activating **Auto ensemble linking** and/or **Auto linking DAB-FM** in the DAB settings menu.
- Interference caused by stations that are on nearby frequencies (a phenomenon that is typical of AM and FM reception) does not occur with DAB.
- If the DAB signal is reflected by natural obstacles or buildings, the reception quality of DAB is improved, whereas AM or FM reception is considerably impaired in such cases.
- When DAB reception is enabled, the FM tuner of the Infotainment system remains active in the background and continually searches for the best receivable FM stations. If TP ⇨ 78 is activated, traffic announcements of the FM station which is currently best receivable are issued. Deactivate TP, if DAB reception should not be interrupted by FM traffic announcements.

### Configuring DAB

Press the **CONFIG** button.

Select **Radio settings** and then **DAB settings**.





The following options are available in the configuration menu:

#### **Auto ensemble linking**

With this function activated, the device switches over to the same service (programme) on another DAB ensemble (frequency) when the DAB signal is too weak to be picked up by the receiver.

Set the function to **On** or **Off**.

#### **Auto linking DAB-FM**

With this function activated, the device switches over to a corresponding FM station of the active DAB service when the DAB signal is too weak to be picked up by the receiver.

Set the function to **On** or **Off**.

#### **Dynamic audio adaption**

With this function activated, the dynamic range of the DAB signal is reduced. That means the level of the loud sounds is reduced and the level of the quiet sounds is increased. Therefore, the volume of the Infotainment system can be raised to a point where the quiet sounds are audible, without the loud sounds being too loud.

Set the function to **On** or **Off**.

#### **Band selection**

Select the menu item **Band selection** to display the respective menu.

To define which DAB wavebands are to be received by the Infotainment system, activate one of the options:

**L-Band:** 1452 - 1492 MHz, earth and satellite radio

**Band III:** 174 - 240 MHz, earth radio

**Both**

## CD Player

General information .....	82
Usage .....	83

### General information

The Infotainment system's CD player can play audio CDs and MP3/WMA CDs.

### Important information

#### Caution

Under no circumstances place single-CDs with a diameter of 8 cm or shaped CDs in the audio player.

You must not put any stickers on CDs. These discs can get jammed in the CD drive and ruin the player. Replacement of the device will then be necessary.

- The following CD formats can be used:  
CD-ROM Mode 1 and Mode 2.  
CD-ROM XA Mode 2, Form 1 and Form 2.
- The following file formats can be used:  
ISO 9660 Level 1, Level 2 (Romeo, Joliet).

MP3 and WMA files written in any format other than listed above may not play correctly and their file names and folder names may not be displayed correctly.

- Audio CDs with copy protection, which are not in compliance with the audio CD standard, may not play correctly or not at all.
- Self-recorded CD-Rs and CD-RWs are more vulnerable to mishandling than prerecorded CDs. Correct handling, especially in the case of self-recorded CD-Rs and CD-RWs, must be ensured (see below).
- Self-recorded CD-Rs and CD-RWs may not play correctly or not at all. In such cases it is not the equipment that is at fault.
- On mixed mode CDs (audio tracks and compressed files, e.g. MP3, are stored), the audio tracks part and the compressed files part can be played separately.
- Avoid leaving fingerprints when you change CDs.

- Put CDs back in their sleeves immediately after removing them from the CD player in order to protect them from damage and dirt.
- Dirt and liquids on CDs can smear the lens of the CD player inside the device and cause faults.
- Protect CDs from heat and direct sunlight.
- The following restrictions apply to MP3/WMA CDs:  
Bit rate: 8 kbit/s - 320 kbit/s.  
Sampling frequency: 48 kHz, 44.1 kHz, 32 kHz (for MPEG-1) and 24 kHz, 22.05 kHz, 16kHz (for MPEG-2).
- The following restrictions apply to the data stored on an MP3/WMA CD:  
Number of tracks: max. 999.  
Number of tracks per folder level: max. 512.  
Folder structure depth: max. 10 levels.

### Notice

This chapter deals only with playing MP3 files since the operation for MP3 and WMA files is identical. When a CD with WMA files is loaded MP3 related menus are displayed.

## Usage

### Starting CD replay

Press the **MEDIA** button once or several times to open the CD or MP3 main menu.



If there is a CD in the CD player, CD replay is started.

Depending on the data stored on the audio CD or MP3 CD, differing information about the CD and the current music track will be shown on the display.

### Inserting a CD

Insert a CD with the printed side facing up into the CD slot until it is drawn in.

### Notice

If a CD is inserted, ● is shown on the display.

### Skipping to the next or previous track

Briefly press the buttons ◀◀ ⏮ or ⏭ ▶▶.

### Fast forward or rewind

Press the buttons ◀◀ ⏮ or ⏭ ▶▶ and hold them down to fast forward or fast rewind the current track.

### Selecting tracks using the audio CD menu

Press the **MENU-TUNE** knob to open the CD menu.



### Shuffle songs

To play all tracks in a random order: set this function to **On**.

#### Notice

If this function is activated,  is shown in the respective main menu.

### Repeat

To repeatedly listen to a track: set this function to **On**.

#### Notice

If this function is activated,  is shown in the respective main menu.

### Track list

To select a track on the CD: select **Track list** and then select the desired track.

### Folders

To select a track from a folder: select **Folders**. A list of the folders stored on the CD is displayed.

Select one of the folders and then select the desired track.

#### Notice

This menu item is only available, if an MP3 CD is inserted.

### Search...

To open a menu for track search and selection: select **Search....**

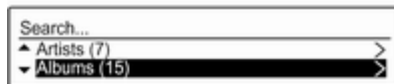

Select one of the categories and then select the desired track.

#### Notice

This menu item is only available, if an MP3 CD is inserted.

### Removing a CD

Press the  button.

The CD is pushed out of the CD slot.

If the CD is not removed after ejection, it will be drawn back in again automatically after a few seconds.

## AUX input

General information .....	85
Usage .....	85

### General information

On the control panel of the Infotainment system ↗ 64, there is an AUX input for the connection of external audio sources.

It is possible, for example, to connect a portable CD player with a 3.5 mm jack plug to the AUX input.

#### Notice

The socket must always be kept clean and dry.

### Usage

CD 3.0 BT: Press the **MEDIA** button once or several times to activate the AUX mode.

R 3.0: Press the **AUX** button to activate the AUX mode.



Turn the **VOL** knob of the Infotainment system to adjust the volume.

All other functions can be operated only via the control elements of the audio source.

## USB port

General information .....	86
Playing saved audio files .....	87

### General information

In the centre console below the climate controls there is an USB socket for the connection of external audio data sources.

#### Notice

The socket must always be kept clean and dry.

An MP3 player, USB drive, SD card (via USB connector/adaptor), or iPod can be connected to the USB port.

When connected to the USB port, various functions of the above devices can be operated via the controls and menus of the Infotainment system.

#### Notice

Not all MP3 player, USB drive, SD card or iPod models are supported by the Infotainment system.

### Important information

- The external devices connected to the USB port must comply with the USB Mass Storage Class specification (USB MSC).

- Devices connected via USB are supported according to USB Specification V 2.0. Maximum supported speed: 12 Mbit/s.
- Only devices with a FAT16/FAT32 file system are supported.
- Hard disk drives (HDD) are not supported.
- USB hubs are not supported.
- The following file formats can be used:
  - ISO9660 Level 1, Level 2 (Romeo, Joliet).
  - MP3 and WMA files written in another format than listed above may not play correctly, and their file names and folder names may not be displayed correctly.
- The following restrictions apply to the files stored on the external device:
  - Bit rate: 8 kbit/s - 320 kbit/s.
  - Sampling frequency: 48 kHz, 44.1 kHz, 32 kHz (for MPEG-1) and

24 kHz, 22.05 kHz, 16kHz (for MPEG-2).

- The following restrictions apply to the data stored on external devices connected to the USB port:

Number of tracks: max. 999.

Number of tracks per folder level: max. 512.

Folder structure depth: max. 10 levels.

WMA files with Digital Rights Management (DRM) from online music shops cannot be played.

WMA files can only be played safely, if they were created with Windows Media Player version 9 or later.

Applicable playlist extensions: .m3u, .pls, .wpl.

Playlist entries must be in the form of relative paths.

The system attribute for folders/files that contain audio data must not be set.

## Playing saved audio files

Press the **MEDIA** button once or several times to activate the MP3 or iPod mode.

Replay of the audio data stored on the device is started automatically.

### MP3:



### iPod:

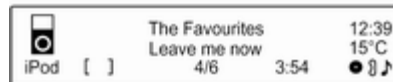

## Using the device-specific menu

Press the **MENU-TUNE** knob to open the menu of the device currently connected.

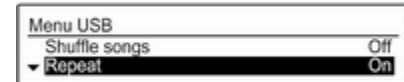

### Shuffle songs

To play all tracks in a random order: set this function to **On**.

#### Notice

If this function is activated,  is shown in the respective main menu.

### Repeat

To repeatedly listen to a track: set this function to **On**.

#### Notice

If this function is activated,  is shown in the respective main menu.

### Folders

To select a track from a folder: select **Folders**. A list of the folders stored on the device is displayed.

Select one of the folders and then select the desired track.

**Notice**

This menu item is not available, if an iPod is connected.

**Search...**

To open a menu for track search and selection: select **Search...**

Select one of the categories and then select the desired track.

**Removing the device**

To safely remove the device, select **Remove USB** or **Eject iPod** and then disconnect the device.



## Bluetooth music

General information .....	89
Operation .....	89

### General information

Bluetooth enabled audio sources (e.g. music mobile phones, MP3 players featuring Bluetooth, etc.) which support the Bluetooth music protocol A2DP can be connected wirelessly to the Infotainment system.

### Important information

- The Infotainment system only connects to Bluetooth devices that support A2DP (Advanced Audio Distribution Profile) version 1.2 or higher.
- The Bluetooth device must support AVRCP (Audio Video Remote Control Profile) version 1.0 or higher. If the device does not support AVRCP, only the volume can be controlled via the Infotainment system.
- Before connecting the Bluetooth device to the Infotainment system, become acquainted with its user guide for Bluetooth functions.

### Operation

#### Prerequisites

The following prerequisites must be met in order to use the Bluetooth music mode of the Infotainment system:

- The Bluetooth function of the Infotainment system must be activated ⇨ 92.
- The Bluetooth function of the external Bluetooth audio source must be activated (see user guide of the device).
- Depending on the external Bluetooth audio source, it may be required to set the device to "visible" (see user guide of the device).
- The external Bluetooth audio source must be paired and connected to the Infotainment system ⇨ 92.

## Activating the Bluetooth music mode

Press the **MEDIA** button once or several times to activate the Bluetooth music mode.



Bluetooth music playback has to be started and paused/stopped via the Bluetooth device.

## Operation via Infotainment system

### Adjusting the volume

The volume can be adjusted via the Infotainment system ↪ 68.

### Skipping to next or previous track

Briefly press the buttons ⏪ ⏩ or ⏮ ⏭ on the control panel of the Infotainment system.

## Phone

General information .....	91
Bluetooth connection .....	92
Emergency call .....	94
Operation .....	95
Mobile phones and CB radio equipment .....	98

### General information

The Phone portal provides you with the possibility of having mobile phone conversations via a vehicle microphone and the vehicle loudspeakers as well as operating the most important mobile phone functions via the Infotainment system in the vehicle. To be able to use the Phone portal, the mobile phone must be connected to the Infotainment system via Bluetooth.

Not all Phone portal functions are supported by every mobile phone. The possible phone functions depend on the relevant mobile phone and network provider. You will find further information on this in the operating instructions for your mobile phone or you can enquire about them with your network provider.

### Important information for operation and traffic safety

#### Warning

Mobile phones have effects on your environment. For this reason safety regulations and directions have been prepared. You should be familiar with the related directions before you use the telephone function.

#### Warning

Use of the hands-free facility while driving can be dangerous because your concentration is reduced when telephoning. Park your vehicle before you use the hands-free facility. Follow the stipulations of the country in which you find yourself at present.

Do not forget to follow the special regulations that apply in specific areas and always switch off the mobile phone if the use of mobile

phones is prohibited, if interference is caused by the mobile phone or if dangerous situations can occur.

## Bluetooth

The Phone portal is certified by the Bluetooth Special Interest Group (SIG).

You will find further information about the specification on the Internet at <http://www.bluetooth.com>

## Control elements

The most important telephone specific control elements are the following:

📞 / 📵 button: opens the telephone main menu.

Controls on steering wheel:

📞: take call.

📵: end/reject call.

## Bluetooth connection

Bluetooth is a radio standard for the wireless connection of e.g. a telephone with other devices. Data such as a telephone book, call lists, the network operator's name, and field strength can be transferred. The functionality can be restricted depending on the telephone type.

To be able to set up a Bluetooth connection with the Phone portal, the Bluetooth function of the mobile phone has to be activated and the mobile phone has to be set to "visible". Find a detailed description in the operating instructions for the mobile phone.

## Activating Bluetooth

Press the **CONFIG** button to open the **Settings** menu.

Select **Phone settings** and then **Bluetooth**. The submenu prompts you with a question.

Set Bluetooth on?

Yes  
No

Set **Bluetooth** to **On** by answering the question with **Yes** or **No**, as required.

## Pairing a Bluetooth device

Press the **CONFIG** button to open the **Settings** menu. Select **Phone settings** and then **Pair device**.

You may optionally press the 📞 / 📵 button twice.

The following display is shown.

Waiting for pairing

Code : 0000

Cancel

As soon as the Phone portal of the Infotainment system is detected, it appears in the device list of your Bluetooth device. Select the Phone portal.

Upon request, enter the PIN code on your Bluetooth device. The devices are paired and connected.

### Notice

Your mobile phone book will be downloaded automatically. The presentation and order of the telephone book entries may be different on the Infotainment system's display and the mobile phone's display.

If the Bluetooth connection has been successfully performed: in case another Bluetooth device had been connected to the Infotainment system, this device is now disconnected from the system.

If the Bluetooth connection failed: start the procedure described above again or consult the user guide of the Bluetooth device.

### Notice

A maximum of 5 devices can be paired with the Infotainment system.

## Changing the Bluetooth code

Press the **CONFIG** button to open the **Settings** menu.

Select **Phone settings** and then **Change Bluetooth code**. The following display is shown.

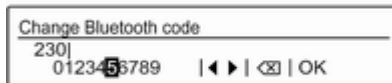

Enter the desired four-digit PIN code and confirm your input with **OK**.

## Connecting another paired device

Press the **CONFIG** button to open the **Settings** menu.

Select **Phone settings** and then **Device list**. A list of all Bluetooth devices currently paired to the Infotainment system is displayed.

### Notice

The Bluetooth device currently connected to the Infotainment system is indicated by **✓**.



Select the desired device. A submenu is displayed.

Select the submenu item **Select** to establish the connection.

## Disconnecting a device

Press the **CONFIG** button to open the **Settings** menu.

Select **Phone settings** and then **Device list**. A list of all Bluetooth devices currently paired to the Infotainment system is displayed.

### Notice

The Bluetooth device currently connected to the Infotainment system is indicated by **✓**.

Select the paired device. A submenu is displayed.

Select the submenu item **Disconnect** to disconnect the device.

## Removing a paired device

Press the **CONFIG** button to open the **Settings** menu.

Select **Phone settings** and then **Device list**. A list of all Bluetooth devices currently paired to the Infotainment system is displayed.

### Notice

The Bluetooth device currently connected to the Infotainment system is indicated by **✓**.

Select the desired device. A submenu is displayed.

If the device is connected, it has to be disconnected first (see above).

Select the submenu item **Delete** to remove the device.

## Restoring the factory defaults

The phone settings, e.g. the device list, the Bluetooth code, and the ring tone, can be reset to the factory defaults.

Press the **CONFIG** button to open the **Settings** menu. Select **Phone settings** and then **Restore factory settings**.

The submenu prompts you with a question. To reset all values to the factory defaults, select **Yes**.

## Emergency call

### ⚠ Warning

Connection setup cannot be guaranteed in all situations. For this reason you should not rely exclusively on a mobile phone when a vitally important communication (e.g. a medical emergency) is concerned.

In some networks it may be necessary for a valid SIM card to be properly inserted in the mobile phone.

### ⚠ Warning

Bear in mind that you can make and receive calls with the mobile phone, if it is in a service area with a sufficiently strong signal. Under certain circumstances emergency

calls cannot be made on all mobile phone networks; it is possible that they cannot be made when certain network services and/or telephone functions are active. You can enquire about this with the local network operators.

The emergency call number can differ depending on the region and country. Please enquire beforehand about the correct emergency call number for the relevant region.

## Making an emergency call

Dial the emergency call number (e.g. **112**).

The telephone connection to the emergency call centre is set up.

Answer when the service personnel questions you about the emergency.

### ⚠ Warning

Do not end the call until you are requested to do so by the emergency call centre.

## Operation

As soon as a Bluetooth connection has been set up between your mobile phone and the Infotainment system, you can also operate many functions of your mobile phone via the Infotainment system.

Via the Infotainment system, you can, e.g., set up a connection to the telephone numbers stored in your mobile phone or change the telephone numbers.

### Notice

In the handsfree mode, mobile phone operation is still possible, e.g. taking a call or adjusting the volume.

After the setup of a connection between the mobile phone and the Infotainment system, mobile phone data is transmitted to the Infotainment system. This can take several minutes depending on the phone model. During this period, operation of the mobile phone is possible via the Infotainment system only to a limited extent.

### Notice



Not every mobile phone supports all functions of the Phone portal. Therefore deviations from the range of functions described with these specific mobile phones are possible.

### Prerequisites

The following prerequisites must be met in order to use the handsfree mode of the Infotainment system:

- The Bluetooth function of the Infotainment system must be activated ↷ 92.
- The Bluetooth function of the mobile phone must be activated (see user guide of the device).
- The mobile phone must be set to "visible" (see user guide of the device).
- The mobile phone must be paired to the Infotainment system ↷ 92.

### Activating the handsfree mode

Press the  /  button on the control panel of the Infotainment system. The phone main menu is displayed.

### Notice

If there is no mobile phone connected to the Infotainment system, **No phone available** is displayed. For a detailed description of how to establish a Bluetooth connection ↷ 92.



Many functions of the mobile phone can now be controlled via the phone main menu (and associated submenus) and via the phone-specific controls on the steering wheel.

### Initiating a phone call

#### Entering a number manually

Being in the phone main menu, press the **MENU-TUNE** knob to open the **Phone Menu**.

Select the submenu item **Enter number**. The following screen is displayed.



Enter the desired number and select  on the display to start dialling.

#### Notice

To open the **Search** screen of the phone book, select .

#### Using the phone book

The phone book contains contact names and numbers.

Being in the phone main menu, press the **MENU-TUNE** knob to open the **Phone Menu**.

Select the submenu item **Phone book**. The following screen is displayed.



As on a telephone or mobile phone, the letters are organised in alphabetical groups on the display: **abc, def, ghi, jkl, mno, pqrs, tuv, and wxyz**.

Select the desired group of letters. The phone book is displayed showing the entries starting with one of the letters in the letter group.

Scroll through the list and select the desired entry name.

Scroll through the list of phone numbers and select the desired number. The corresponding phone number is dialled.

#### Adjusting the sorting order of the phone book

After pairing and connecting a mobile phone to the Infotainment system, your mobile phone book with phone

numbers and names will be automatically downloaded to the Infotainment system.

The phone book on the Infotainment system may be sorted by **First Name** or **Last Name**.

Press the **CONFIG** button to open the **Settings** menu.



Select **Phone settings** and then **Phone book sorting**.

Select the desired option.

#### Using the call lists

All incoming, outgoing, or missed calls are registered in corresponding call lists.

Being in the phone main menu, press the **MENU-TUNE** knob to open the **Phone Menu**. Select the submenu item **Call lists**.

You may optionally press the  /  button.

The following screen is displayed.





Select the desired call list, e.g. **Missed calls**. A menu with the corresponding call list is displayed.

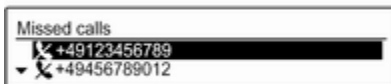



To initiate a phone call: select the desired list entry. The corresponding phone number is dialled.

### Redialling a phone number

The last dialled phone number can be redialled.

Press the  button on the steering wheel to open the **Redial** menu.

Press the  button again to start dialling.

Press the  button on the steering wheel to exit the **Redial** menu. You may optionally use the **MENU-TUNE** knob to select **No** on the display.

### Incoming phone call

If an audio mode, e.g. the radio or CD mode, is active at the time of an incoming call, the relating audio source will be muted and stay muted until the call ends.

To answer the call: select **Answer** on the display.

To reject the call: select **Decline** on the display.

### Second incoming phone call

If a second phone call comes in during an ongoing call, a message is displayed.

To answer the second call and end the ongoing call: select **Answer** on the display.

To reject the second call and continue the ongoing call: select **Decline** on the display.

### Changing the ring tone

Press the **CONFIG** button to open the **Settings** menu.

Select **Phone settings, Sound & Signals** and then **Ring tone**. A list of all ring tones available is displayed.

Select the desired ring tone.

For a detailed description on the ring tone volume  73.

### Functions during a phone call

During an ongoing phone call, the phone main menu will be displayed as follows.

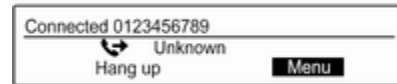

Select **Menu** on the display to open the menu **Connected**.

Select **Hang up** on the display to end the call.

### Activating the private mode

In the **Connected** menu, select the submenu item **Private call** to switch the call to the mobile phone. The following display is shown.



To switch the call back to the Infotainment system, select **Menu** on the display and then **Transfer call**.

### Deactivating/activating the microphone

In the **Connected** menu, set the submenu item **Mute Mic** to **On**. The caller cannot hear you any more.

To reactivate the microphone: set the submenu item **Mute Mic** to **Off** again.

## Mobile phones and CB radio equipment

### Installation instructions and operating guidelines

The vehicle specific installation instructions and the operating guidelines of the mobile phone and handsfree manufacturer must be observed when installing and operating a mobile telephone. Failure to do so could invalidate the vehicle type approval (EU directive 95/54/EC).

Recommendations for fault-free operation:

- Professionally installed exterior antenna to obtain the maximum range possible,
- Maximum transmission power 10 watts,
- Installation of the phone in a suitable spot, consider relevant Note in the Owner's Manual, chapter **Airbag system**.

Seek advice on predetermined installation points for the external antenna or equipment holder and ways of using devices with a transmission power exceeding 10 watts.

Use of a handsfree attachment without external antenna with mobile telephone standards GSM 900/1800/1900 and UMTS is only permitted if the maximum transmission power of the mobile telephone is 2 watts for GSM 900 or 1 watt for the other types.

For reasons of safety, do not use the phone while driving. Even use of a handsfree set can be a distraction while driving.

### Warning

Operation of radio equipment and mobile telephones which fail to meet above mentioned mobile telephone standards is only permitted using an antenna located outside of the vehicle.

**Caution**

Mobile telephones and radio equipment may lead to malfunctions in the vehicle electronics when operated inside the vehicle with no exterior antenna, unless the above mentioned regulations are observed.

# Index

<b>A</b>		Bluetooth music
Activating Bluetooth music.....	89	Activating.....
Activating CD player.....	83	General information.....
Activating the AUX function.....	85	Operation.....
Activating the handsfree Phone		Prerequisites.....
mode.....	95	
Activating the radio.....	74	<b>C</b>
Activating the USB function.....	87	Call
Autostore lists.....	75	Functions during a call.....
Retrieving stations.....	75	Incoming call.....
Storing stations.....	75	Initiating a phone call.....
Auto volume control.....	73	Ring tone.....
AUX input		Call lists.....
Activating.....	85	Category list.....
Adjusting the volume.....	85	CD menu.....
General information.....	85	CD player
Operation.....	85	Activating.....
		CD menu.....
<b>B</b>		General information.....
Basic operation.....	70	Inserting a CD.....
Blocking out traffic		Removing a CD.....
announcements.....	78	Starting CD replay.....
Bluetooth		Usage.....
Bluetooth connection.....	92	Control elements
Bluetooth music.....	89	Infotainment system.....
Phone.....	95	Phone.....
Bluetooth connection.....	92	Steering wheel.....
		Control elements overview.....

<b>D</b>		<b>M</b>		Incoming call.....	95
DAB.....	80	Maximum startup volume.....	73	Phone book.....	95
Date settings.....	68	Menu operation.....	70	Prerequisites.....	95
Digital audio broadcasting.....	80	MENU-TUNE knob.....	70	Redialling a phone number.....	95
Dynamic audio adaption.....	80	Mobile phones and CB radio equipment .....	98	Selecting the ring tone.....	95
<b>E</b>		Mute.....	68	Phone book.....	95
Emergency call.....	94	<b>O</b>		Playing saved audio files.....	87
<b>F</b>		Operation.....	89, 95	<b>R</b>	
Favourite lists.....	76	AUX input.....	85	Radio	
Retrieving stations.....	76	Bluetooth music.....	89	Activating.....	74
Storing stations.....	76	CD player.....	83	Autostore lists.....	75
<b>G</b>		Menu.....	70	Band selection.....	80
General information 82, 85, 86, 89, 91		Phone.....	95	Category list.....	76
AUX input.....	85	Radio.....	74	Configuring DAB.....	80
Bluetooth music.....	89	USB port.....	87	Configuring RDS.....	78
CD player.....	82	<b>P</b>		DAB announcements.....	76
Infotainment system.....	62	Phone		Digital audio broadcasting (DAB).....	80
Phone.....	91	Activating.....	95	Dynamic audio adaption.....	80
USB port.....	86	Bluetooth.....	91	Favourite lists.....	76
<b>I</b>		Bluetooth connection.....	92	Radio data system (RDS).....	78
Infotainment control panel.....	64	Call lists.....	95	Radio traffic service.....	78
<b>L</b>		Control elements.....	91	Regionalisation.....	78
Language settings.....	68	Dialling a number.....	95	Retrieving stations.....	75, 76
		Emergency calls.....	94	Selecting the waveband.....	74
		Functions during a call.....	95	Station lists.....	76
		General information.....	91	Station search.....	74
		Important information.....	91	Station tuning.....	74
				Storing stations.....	75, 76

Traffic announcements.....	78
Updating station lists.....	76
Usage.....	74
Waveband menus.....	76
Radio data system (RDS) .....	78
Radio traffic service.....	78
RDS.....	78
Redial function.....	95
Regionalisation.....	78
Retrieving stations.....	75, 76
Ring tone	
Ring tone volume.....	73
Selecting the ring tone.....	95
<b>S</b>	
Selecting the waveband.....	74
Starting CD replay.....	83
Station lists.....	76
Station search.....	74
Steering wheel audio controls.....	64
Storing stations.....	75, 76
Switching the Infotainment system on.....	68
Switching the radio on.....	74
System settings	
Language.....	68
Restore factory settings.....	68
Time and date.....	68
Vehicle settings.....	68

<b>T</b>	
TA volume.....	73
Theft-deterrent feature .....	63
Time settings.....	68
Tone settings.....	72
Traffic announcements.....	78
<b>U</b>	
Updating station lists.....	76
Usage.....	68, 74, 83, 85
AUX input.....	85
Bluetooth music.....	89
CD player.....	83
Menu.....	70
Phone.....	95
Radio.....	74
USB port.....	87
USB menu.....	87
USB port	
Activation.....	87
Connecting the USB device.....	86
General information.....	86
Important information.....	86
Operation.....	87
Removing the USB device.....	87
USB menu.....	87

<b>V</b>	
Volume	
Auto volume control.....	73
Maximum startup volume.....	73
Mute function.....	68
Ring tone volume.....	73
Setting the volume.....	68
Speed compensated volume....	73
TA volume.....	73
Volume limitation at high temperatures.....	68
Volume settings.....	73
<b>W</b>	
Waveband menus.....	76

---

# FlexDock

FlexDock .....	104
Index .....	106

## FlexDock

General information .....	104
Usage .....	104

### General information

FlexDock consists of a built-in base plate and different types of cradles which can be attached to the base plate. By inserting an iPhone or a different smartphone to the cradle, the smartphone can be controlled via the Infotainment system, steering wheel control or touch screen.

Detailed cradle usage information can be found in the cradle manual supplied with each cradle.

#### **⚠ Warning**

Devices attached to the FlexDock must be used in a way that driver distraction is avoided and the vehicle can be driven safely at all times. You must always comply with the respective laws and regulations of the country where you are driving. These laws may differ from the information in this manual. If in doubt, stop your vehicle and operate devices while the vehicle is stationary.

### Notice

Do not operate a further audio source via the USB socket at the same time due to superimpositions of both audio sources.

#### **Caution**

To avoid theft, do not leave the mobile phone in the FlexDock when leaving the vehicle.

### Usage

#### Attaching the cradle to the base plate





1. Remove the cover from the base plate.
2. Push the cradle in the base plate and fold down.

## Connecting the smartphone to the Infotainment system

### Universal smartphone

Connect the smartphone to the cradle by using the connecting cable.

### iPhone

The iPhone is connected automatically when it is inserted into the cradle.

Depending on the status of the software and hardware equipment, the functionality of the iPhone can be restricted.

### Operating the smartphone

When the smartphone is connected via FlexDock, it has the same functionality as if it is connected via the USB socket. See the corresponding instructions in this manual for detailed information.

To use the phone function or the Bluetooth Music function, a Bluetooth connection must be established. See the corresponding instructions in this manual and the operating instructions for the smartphone for detailed information.

## Removing the cradle from the base plate

1. Push the release button and remove the cradle.



2. Attach the cover to the base plate.

---

## Index

<b>B</b>	
Base plate.....	104
<b>C</b>	
Cradle.....	104
<b>F</b>	
FlexDock.....	104
<b>G</b>	
General information.....	104
<b>U</b>	
Usage.....	104

Copyright by General Motors UK Ltd.

The information contained in this publication is effective as of the date indicated below. General Motors UK Ltd. reserves the right to make changes to the technical specifications, features and design of the vehicles relative to the information contained in this publication, as well as changes to the publication itself.

Edition: May 2014, General Motors UK Ltd.

Printed on chlorine-free bleached paper.

KTA-2745/3-VX-en

05/2014

