

Vauxhall Movano / Vivaro

Infotainment System



Contents

Introduction	4
Radio	48
CD Player	57
AUX input	61
USB port	63
Bluetooth music	67
External devices	73
Navigation	75
Voice recognition	104
Phone	107
Index	124

Introduction

General information	4
Control elements overview	6
Theft-deterrent feature	29
Usage	30
Touch operation overview	39
Tone settings	40
Volume settings	42
System settings	43

General information

The Infotainment system provides state-of-the-art in-car information and entertainment.

The radio is equipped with assignable channel presets for FM, AM and also DAB wavebands (depending on version).

The audio player can play audio CDs, MP3 CDs and also WMA CDs (depending on version).

External data storage devices, e.g. iPod, MP3 player or USB stick, or a portable player can be connected to the Infotainment system. External audio sources can also be connected via Bluetooth.

The digital sound processor provides several preset equalizer modes for sound optimisation.

The navigation system's dynamic route planning will reliably guide you to your destination and can help avoid traffic jams and other traffic problems.

Optionally, the Infotainment system can be operated using controls on the steering column or via the voice recognition system.

In addition, the Infotainment system can be equipped with a handsfree phone system.

The well-thought-out design of the controls and the clear displays enable you to control the system easily and intuitively.

Notice

This manual describes all options and features available for the various Infotainment systems. Certain descriptions, including those for display and menu functions, may not apply to your vehicle due to model variant, country specifications, special equipment or accessories.

Important information on operation and traffic safety

Warning

Drive safely at all times when using the Infotainment system.

If in doubt, stop the vehicle before operating the Infotainment system.

Radio reception

Radio reception may be disrupted by static, noise, distortion or loss of reception due to:

- changes in distance from the transmitter
- multi-path reception due to reflection
- shadowing

In case of poor radio reception the volume will automatically drop as to minimize the disturbance effect.

Using this manual

- This manual describes features that may or may not be on your specific vehicle, either because they are optional or due to changes subsequent to the printing of this manual. Please refer to the purchase documentation to confirm each of the features found on the vehicle.
- Certain controls and descriptions, including symbols, displays and menu functions may not apply to your vehicle due to

model variant, country specifications, special equipment or accessories.

- The table of contents at the beginning of this manual and within each section shows where the information is located.
- The index will enable you to search for specific information.
- The vehicle display screens may not support your specific language.
- Display messages and interior labelling are written in **bold** letters.
- The operations given within this manual refer to Infotainment system controls. For equivalent steering column controls, refer to the control elements overview ⇨ 6.

Warnings and cautions

Warning

Text marked  **Warning** provides information on risk of accident or injury. Disregarding this information may lead to injury.

Caution

Text marked **Caution** provides information on possible damage to the vehicle. Disregarding this information may lead to vehicle damage.





Symbols

Page references are indicated with ⇨.
⇨ means "see page".

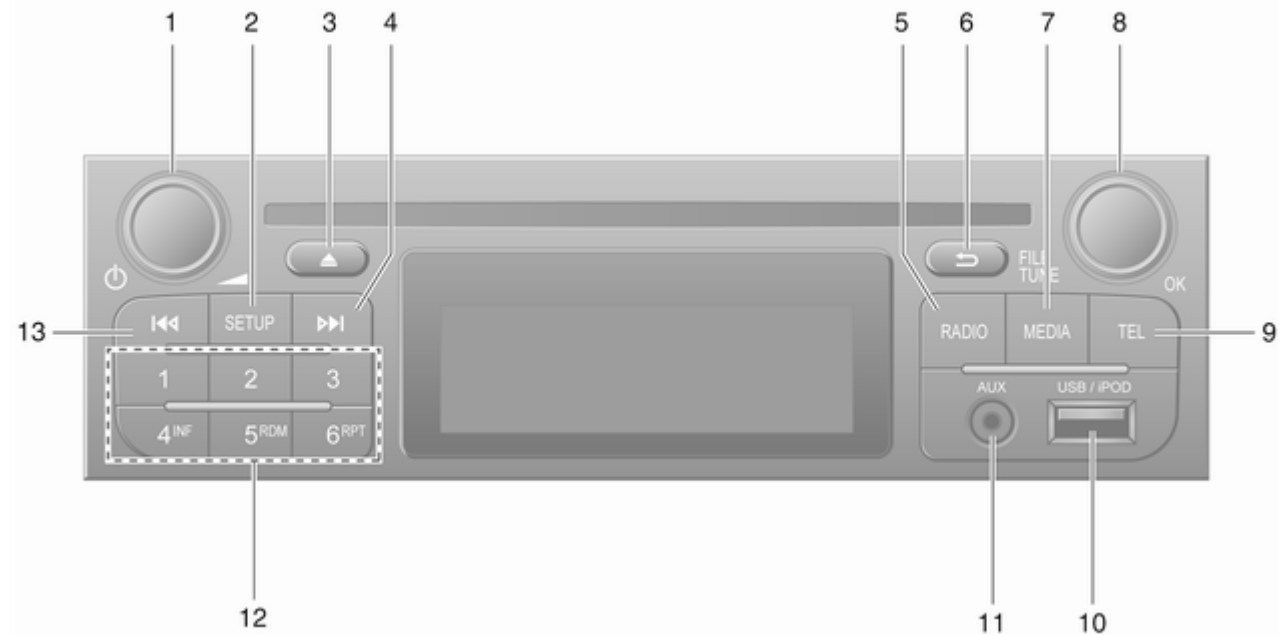
Control elements overview

R15 BT USB



- | | |
|--|---|
| <p>1  - Press: Switch on/off 30</p> <p>Press: Mute/unmute 30</p> <p>Turn: Adjust volume 30</p> <p>2 SETUP - Short press:</p> <p>Settings menu 30</p> <p>Display radio text information 53</p> <p>Long press: Automatic station storing 52</p> <p>3 Mute/unmute 30</p> <p>4  - Radio, Short press:</p> <p>Search for next radio frequency 50</p> <p>Long press: Automatic station search 50</p> <p>5 RADIO - Change audio source, waveband 48</p> <p>6  - Return to previous menu, cancel an action 30</p> <p>7 MEDIA - Change audio source 58</p> <p>8 OK rotary knob 30</p> <p>Press: Confirm an action 30</p> | <p>Turn: Access display menu options 30</p> <p>Turn: Change radio frequency 50</p> <p>9 TEL - Telephone menu 107</p> <p>10  USB port 63</p> <p>11 AUX input 61</p> <p>12 Station buttons 1..6 50</p> <p>Short press: Select station 50</p> <p>Long press: Save station 50</p> <p>13  - Radio, Short press:</p> <p>Search for previous radio frequency 50</p> <p>Long press: Automatic station search 50</p> |
|--|---|

R16 BT USB

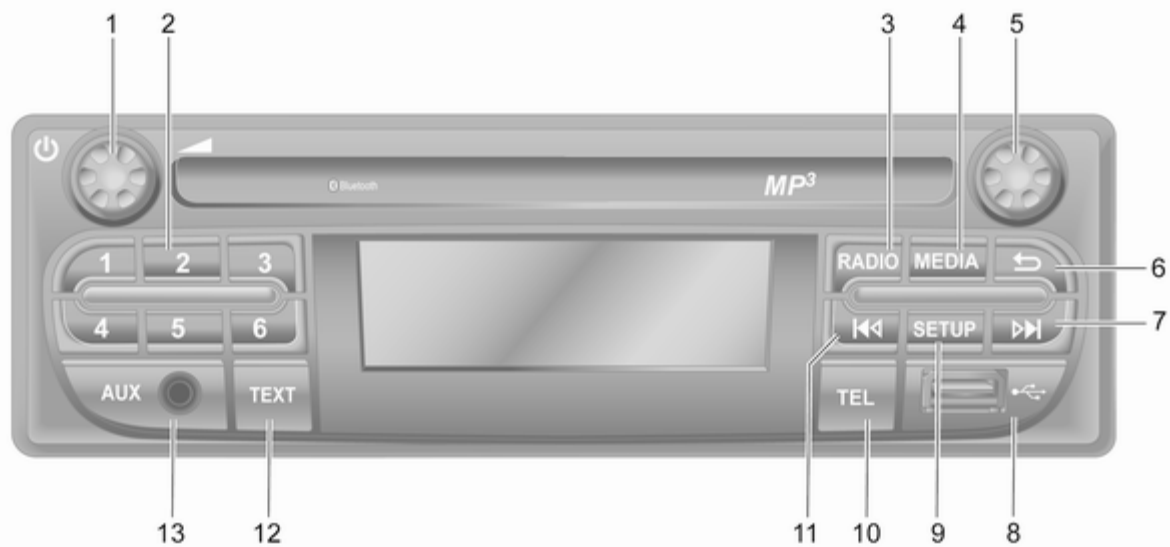

- | | | |
|---|---|--|
| 1 | ⏻ - Press: Switch on/off 30
Turn: Adjust volume 30 | Audio/MP3/WMA CD,
Short press: Skip track
forwards 58 |
| 2 | Station buttons 1...6 50
Short press: Select station 50
Long press: Save station 50 | Long press: Fast forward 58 |
| 3 | RADIO - Change audio
source, waveband 48 | 8 ⚡ USB port 63 |
| 4 | MEDIA - Change audio
source 58 | 9 SETUP - Short press:
Settings menu 30 |
| 5 | Rotary knob 30

Short press: Confirm an
action 30





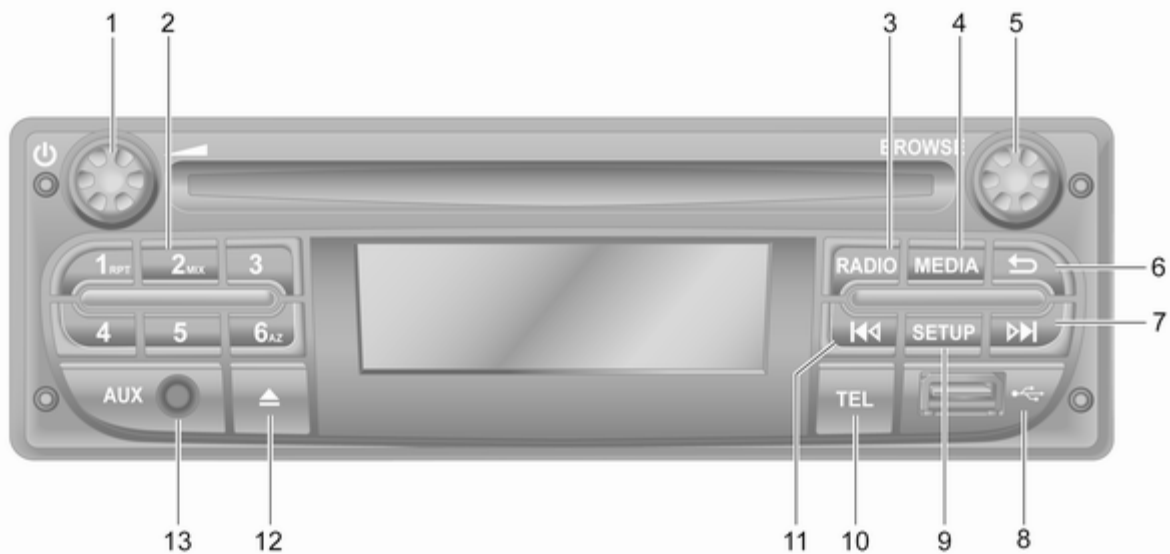

Turn: Access display
menu options 30 | 10 TEL - Telephone menu 107 |
| 6 | ↩ - Return to previous
menu, cancel an action 30 | 11 ⏮ - Radio, Short press:
Search for previous radio
frequency 50

Long press: Automatic
station search 50 |
| 7 | ⏭ - Radio, Short press:
Search for next radio
frequency 50

Long press: Automatic
station search 50 | 12 TEXT - Display radio text
information 53 |
| | | 13 AUX input 61 |

CD16 BT USB



- | | |
|---|--|
| <p>1  - Press: Switch on/off 30</p> <p style="padding-left: 20px;">Turn: Adjust volume 30</p> <p>2 Station buttons 1...6 50</p> <p style="padding-left: 20px;">Short press: Select station 50</p> <p style="padding-left: 20px;">Long press: Save station 50</p> <p style="padding-left: 20px;">RPT: Repeat a track 58</p> <p style="padding-left: 20px;">MIX: Random playback 58</p> <p>3 RADIO - Change audio source, waveband 48</p> <p>4 MEDIA - Change audio source 58</p> <p>5 Rotary knob 30</p> <p style="padding-left: 20px;">Short press: Confirm an action 30</p> <p style="padding-left: 20px;">Turn: Access display menu options 30</p> <p>6  - Return to previous menu, cancel an action 30</p> <p>7  - Radio, Short press: Search for next radio frequency 50</p> <p style="padding-left: 20px;">Long press: Automatic station search 50</p> | <p style="padding-left: 20px;">Audio/MP3/WMA CD, Short press: Skip track forwards 58</p> <p style="padding-left: 20px;">Long press: Fast forward 58</p> <p>8  USB port 63</p> <p>9 SETUP - Short press: Settings menu 30</p> <p>10 TEL - Telephone menu 107</p> <p>11  - Radio, Short press: Search for previous radio frequency 50</p> <p style="padding-left: 20px;">Long press: Automatic station search 50</p> <p style="padding-left: 20px;">Audio/MP3/WMA CD, Short press: Skip track backwards 58</p> <p style="padding-left: 20px;">Long press: Fast rewind 58</p> <p>12  - CD ejection 58</p> <p>13 AUX input 61</p> |
|---|--|

CD18 BT USB



- | | | | |
|---|---|----|---|
| 1 | <ul style="list-style-type: none"> ⏻ - Press: Switch on/off 30 Turn: Adjust volume 30 | | <ul style="list-style-type: none"> Audio/MP3/WMA CD,
Short press: Skip track
forwards 58 Long press: Fast forward 58 |
| 2 | <ul style="list-style-type: none"> OK rotary knob 30 Short press: Confirm an
action 30 Turn: Access display
menu options 30 | 9 | <ul style="list-style-type: none"> SETUP - Short press:
Settings menu 30 |
| 3 | <ul style="list-style-type: none"> ↩ - Return to previous
menu, cancel an action 30 | 10 | <ul style="list-style-type: none"> ⏮ - Radio, Short press:
Search for previous radio
frequency 50 Long press: Automatic
station search 50 Audio/MP3/WMA CD,
Short press: Skip track
backwards 58 Long press: Fast rewind 58 |
| 4 | <ul style="list-style-type: none"> TEXT - Display radio text
information 53 | 11 | <ul style="list-style-type: none"> AUX input 61 |
| 5 | <ul style="list-style-type: none"> ⏏ - CD ejection 58 | 12 | <ul style="list-style-type: none"> TEL - Telephone menu 107 |
| 6 | <ul style="list-style-type: none"> 🔌 USB port 63 | 13 | <ul style="list-style-type: none"> MEDIA - Change audio
source 58 |
| 7 | <ul style="list-style-type: none"> Station buttons 1...6 50 Short press: Select station 50 Long press: Save station 50 RPT: Repeat a track 58 MIX: Random playback 58 | 14 | <ul style="list-style-type: none"> RADIO - Change audio
source, waveband 48 |
| 8 | <ul style="list-style-type: none"> ⏭ - Radio, Short press:
Search for next radio
frequency 50 Long press: Automatic
station search 50 | | |

NAVI 50 IntelliLink (Type A)

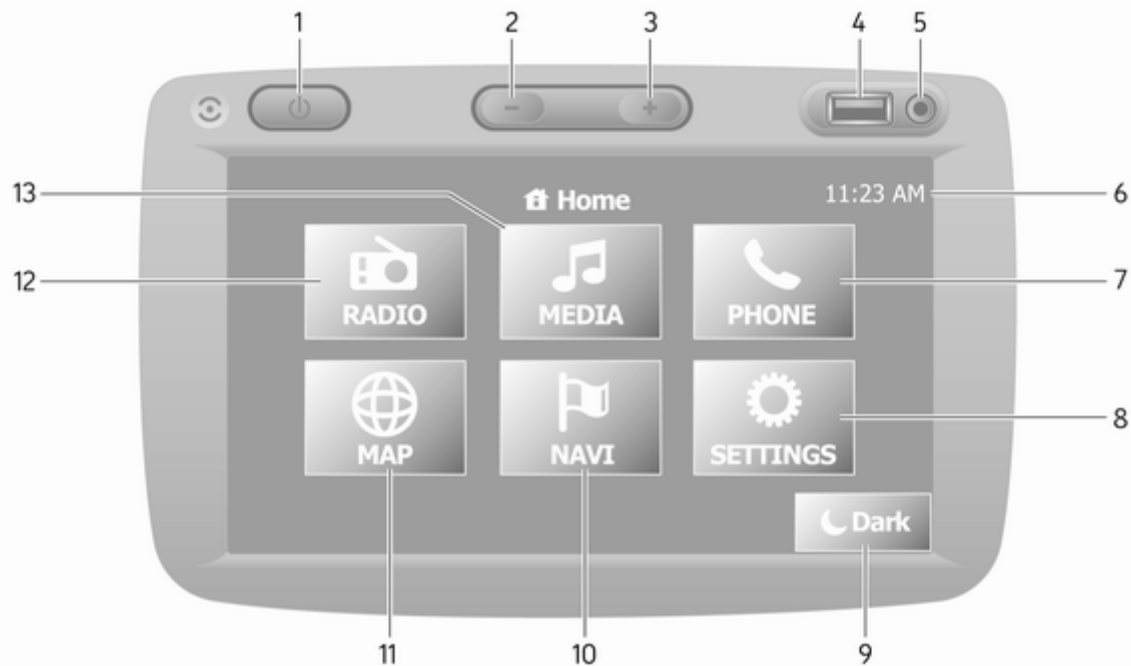

-
- | | | | | | |
|----|---|-----|----|--|----|
| 1 | ⏻: Switch on/off | 30 | 13 | 🎵 MEDIA : Change audio source - USB, iPod | 63 |
| 2 | ⏮: Decrease volume | 30 | | BT (Bluetooth) | 67 |
| 3 | ⏭: Increase volume | 30 | | AUX | 61 |
| 4 | 🔌 USB port | 63 | | | |
| 5 | AUX input | 61 | | | |
| 6 | Clock | 30 | | | |
| 7 | ☎ PHONE : Telephone menu | 107 | | | |
| 8 | ⚙ SETTINGS : Audio settings, e.g. "Tone settings" | 40 | | | |
| | "Volume settings" | 42 | | | |
| | Bluetooth settings | 30 | | | |
| | Display settings | 30 | | | |
| | System settings | 43 | | | |
| 9 | 🌑 Dark : Darken screen (only clock and audio system information are displayed) | 30 | | | |
| 10 | 🗺 NAVI : Navigation menu | 75 | | | |
| 11 | 🌐 MAP : View map | 75 | | | |
| 12 | 📻 RADIO : Change audio source to radio | 48 | | | |

NAVI 50 IntelliLink (Type B)

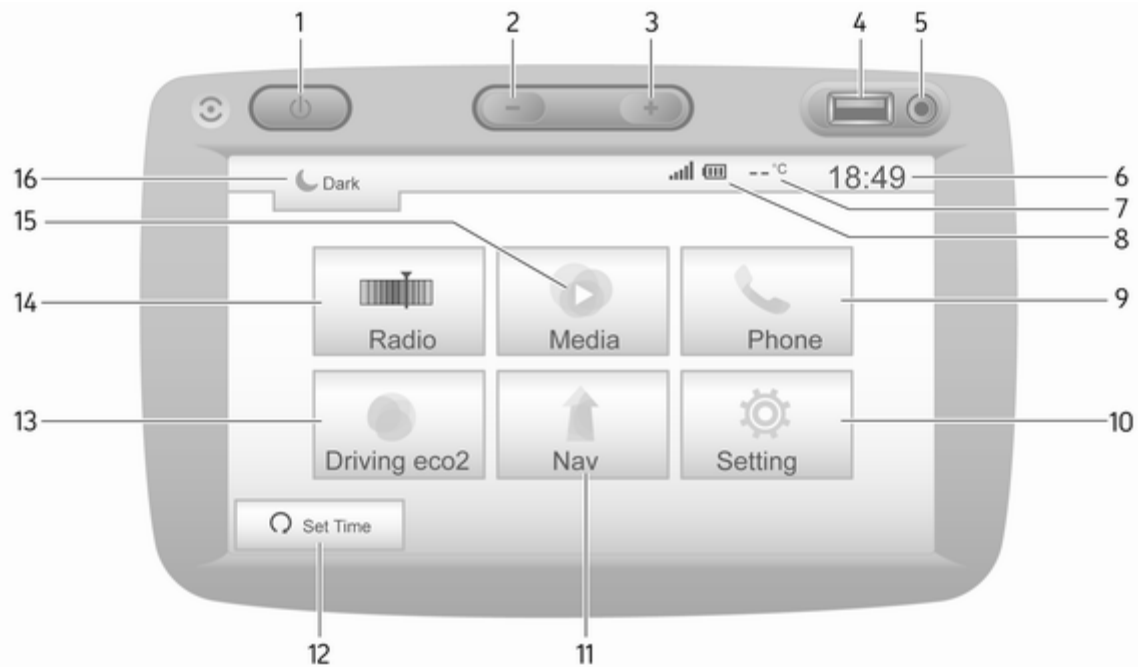

- | | | | |
|----|---|----|--|
| 1 | ⏻: Switch on/off 30 | 14 | 🎵 Media : Change audio source - USB, iPod 63 |
| 2 | ⏪: Decrease volume 30 | | BT (Bluetooth) 67 |
| 3 | ⏩: Increase volume 30 | | AUX 61 |
| 4 | 🔌 USB port 63 | | Aha® application 30 |
| 5 | AUX input 61 | 15 | 🌑: Darken screen (only clock and audio system information are displayed) 30 |
| 6 | Clock 30 | | |
| 7 | Outside temperature (depending on version) 30 | | |
| 8 | 📶: Phone reception (when connected) 107 | | |
| | 🔋: Phone battery life (when connected) 107 | | |
| 9 | 📞 Phone : Telephone menu . 107 | | |
| 10 | ⚙️ Setting : Audio settings, e.g. "Tone settings" 40 | | |
| | "Volume settings" 42 | | |
| | Bluetooth settings 30 | | |
| | Display settings 30 | | |
| | System settings 43 | | |
| 11 | 📍 Nav : Navigation menu 75 | | |
| 12 | 🗺️ MAP : View map 75 | | |
| 13 | 📻 Radio : Change audio source to radio 48 | | |

NAVI 80 IntelliLink (Type A)

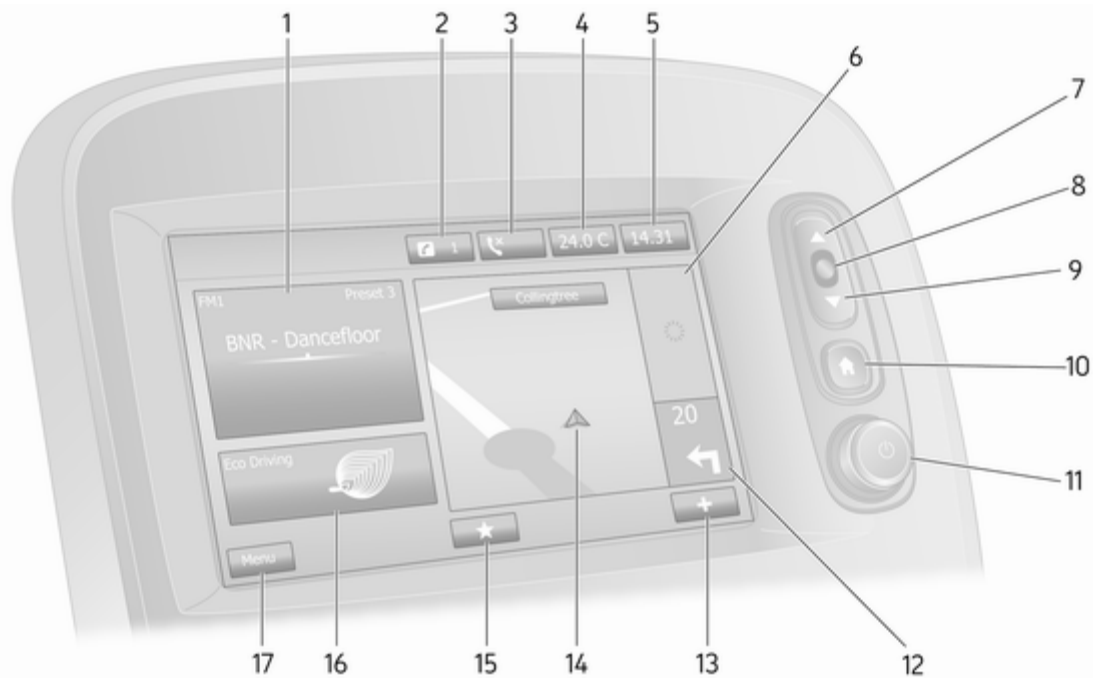

- | | |
|--|---|
| <p>1 Audio information, e.g.
Radio 48</p> <p>Auxiliary devices 61</p> <p>ψ USB devices 63</p> <p>Bluetooth music 67</p> <p>2 ⚙: System notifications (if
equipped) 30</p> <p>3 ☎: Telephone status 107</p> <p>Call log 115</p> <p>4 Outside temperature 30</p> <p>5 Clock 30</p> <p>6 Traffic information (if
applicable) 96</p> <p>7 ▲: Display lists - Scroll up 30</p> <p>Map: Change scale 96</p> <p>8 Enter menus, confirm
actions 30</p> <p>9 ▼: Display lists - Scroll
down 30</p> <p>Map: Change scale 96</p> <p>10 🏠: Home page 30</p> | <p>11 ⏻ - Press: Switch on/off 30</p> <p>Turn: Change volume 30</p> <p>12 Navigation: Direction and
distance to next change of
direction 75</p> <p>13 +: Pop-up menu 30</p> <p>14 Navigation display 75</p> <p>Map 96</p> <p>15 ★: Favourites, e.g. for
Navigation ↑ 75</p> <p>Media 🎵 (e.g. Radio) 48</p> <p>Phone ☎ 107</p> <p>Services 📁 78</p> <p>16 Driving economy (Eco
Driving) 30</p> <p>17 Menu: Access Main menu 30</p> |
|--|---|

NAVI 80 IntelliLink (Type B)

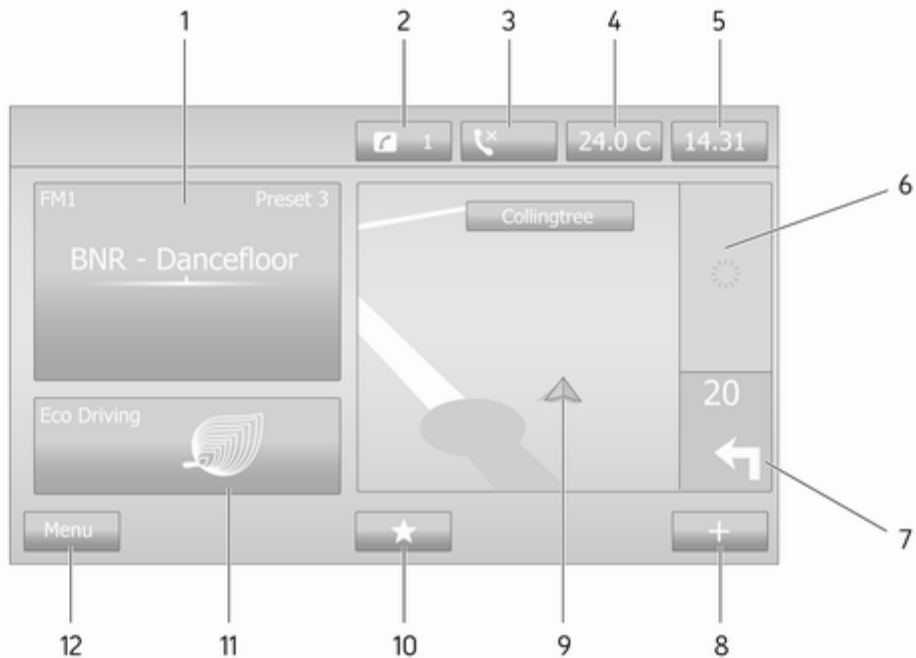

1	Audio information, e.g. Radio	48	Phone ☎	107
	Auxiliary devices	61	Services ☞	78
	‡ USB devices	63	11 Driving economy (Eco Driving)	30
	Bluetooth music	67	12 Menu: Access Main menu	30
2	⚡: System notifications (if equipped)	30		
3	☎: Telephone status	107		
	Call log	115		
4	Outside temperature	30		
5	Clock	30		
6	Traffic information (if applicable)	96		
7	Navigation: Direction and distance to next change of direction	75		
8	⊕: Pop-up menu	30		
9	Navigation display	75		
	Map	96		
10	★: Favourites, e.g. for Navigation ⬆	75		
	Media 🎵 (e.g. Radio)	48		

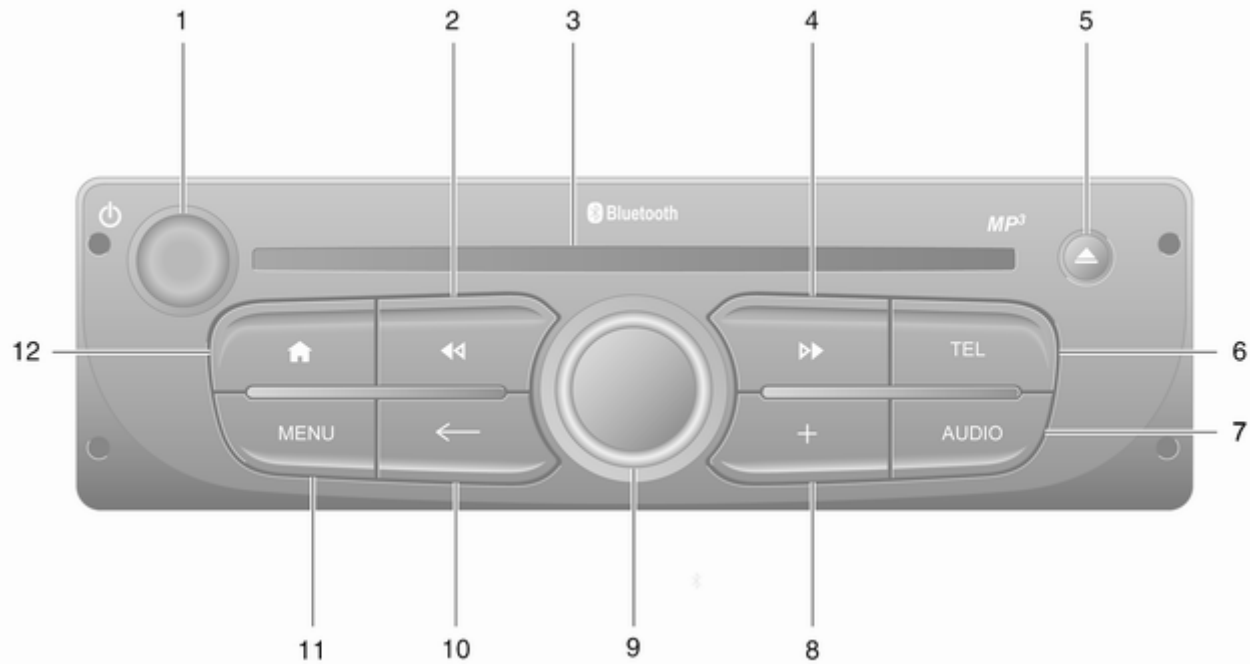

- | | |
|---|--|
| <p>1 - Press: Switch on/off 30
Turn: Change volume 30</p> <p>2 - Radio, Short press:
Search for previous radio
frequency 50

Long press: Automatic
station search 50

Audio/MP3/WMA CD,
Short press: Skip track
backwards 58

Long press: Fast rewind 58</p> <p>3 CD slot 58</p> <p>4 - Radio, Short press:
Search for next radio
frequency 50

Long press: Automatic
station search 50

Audio/MP3 CD, Short
press: Skip track forwards 58

Long press: Fast forward 58</p> <p>5 - CD ejection 58</p> <p>6 TEL - Telephone menu 107</p> <p>7 AUDIO - Change audio
source 58</p> | <p>8 : Pop-up menu 30</p> <p>9 Central rotary knob 30

Press: Confirm an action 30

Turn: Access display
menu options 30

Turn: Access the stored
radio station list 48

Turn: Select next/previous
station 50

Turn: Change CD/MP3
track 58</p> <p>10 - Return to previous
menu, cancel an action 30</p> <p>11 MENU: Access Main menu ... 30</p> <p>12 : Go to Home page 30</p> |
|---|--|

NAVI 80 IntelliLink (Type C)

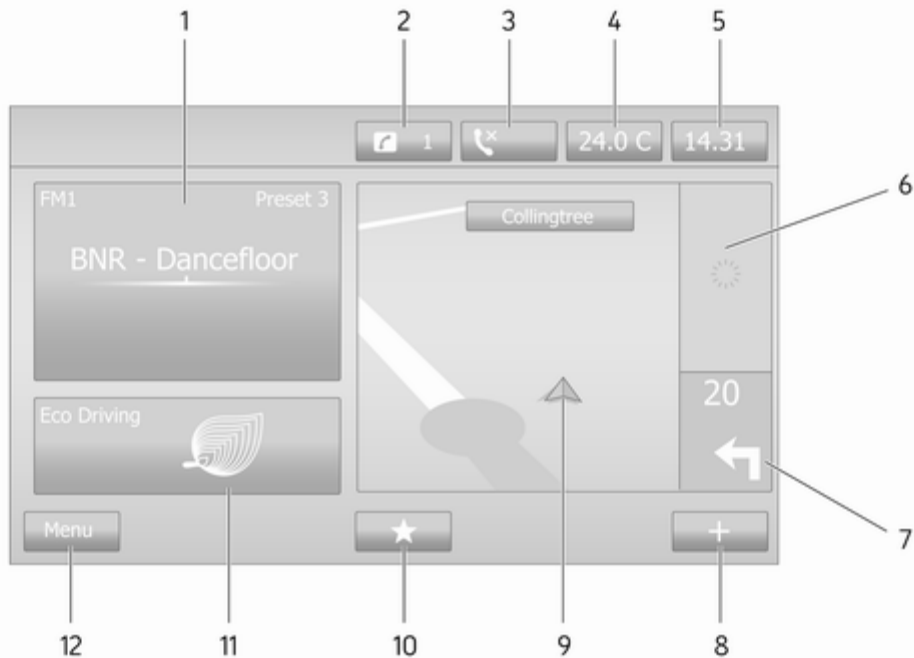

1	Audio information, e.g. Radio	48	Phone ☎	107
	Auxiliary devices	61	Services ☞	78
	ψ USB devices	63	11 Driving economy (Eco Driving)	30
	Bluetooth music	67	12 Menu: Access Main menu	30
2	⚡: System notifications (if equipped)	30		
3	☎: Telephone status	107		
	Call log	115		
4	Outside temperature	30		
5	Clock	30		
6	Traffic information (if applicable)	96		
7	Navigation: Direction and distance to next change of direction	75		
8	⊕: Pop-up menu	30		
9	Navigation display	75		
	Map	96		
10	★: Favourites, e.g. for Navigation ↑	75		
	Media 🎵 (e.g. Radio)	48		

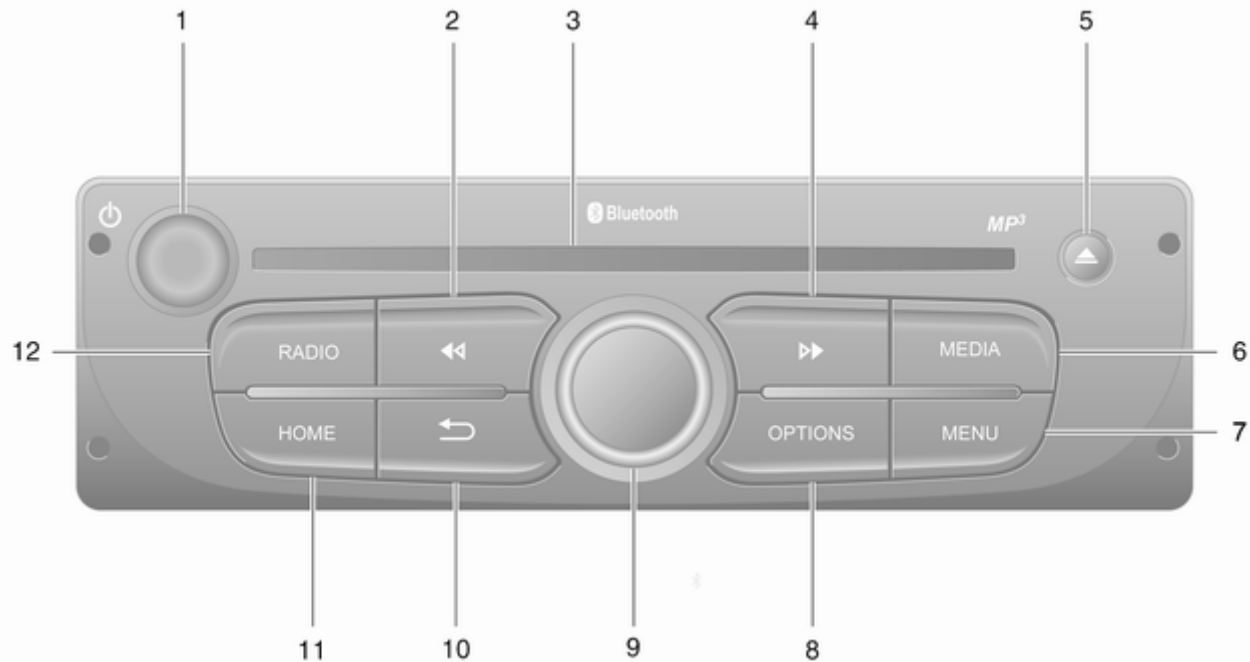

- 1 **⏻** - Press: Switch on/off 30
Turn: Change volume 30
- 2 **⏮** - Radio, Short press:
Search for previous radio
frequency 50

Long press: Automatic
station search 50

Audio/MP3/WMA CD,
Short press: Skip track
backwards 58

Long press: Fast rewind 58
- 3 CD slot 58
- 4 **⏭** - Radio, Short press:
Search for next radio
frequency 50

Long press: Automatic
station search 50

Audio/MP3 CD, Short
press: Skip track forwards 58

Long press: Fast forward 58
- 5 **⏏** - CD ejection 58
- 6 **MEDIA** - Change audio
source 58
- 7 **MENU**: Access Main menu ... 30

- 8 **OPTIONS**: Pop-up menu 30
- 9 Central rotary knob 30

Press: Confirm an action 30

Turn: Access display
menu options 30

Turn: Access the stored
radio station list 48

Turn: Select next/previous
station 50

Turn: Change CD/MP3
track 58
- 10 **↩** - Return to previous
menu, cancel an action 30
- 11 **HOME**: Access Main menu ... 30
- 12 **RADIO** - Change audio
source, waveband 48

Steering column controls - Type A

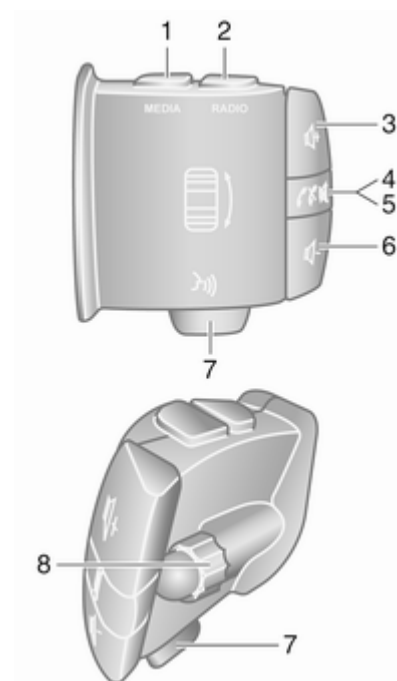

1	MEDIA - Change audio source	30
2	RADIO - Change radio waveband	48
3	🔊 - Increase volume	30
4	🔇 - Mute/unmute	30
5	☎️ - Take/end phone call ..	115
6	🔊 - Decrease volume	30
7	🗣️ - Voice recognition	106
8	Turn: Move up/down in display menus, select next/previous radio preset / radio frequency / audio track	50
	Press: Confirm actions	48

Steering column controls - Type B

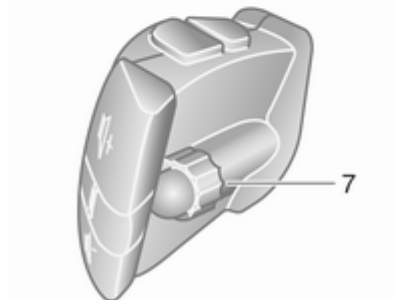
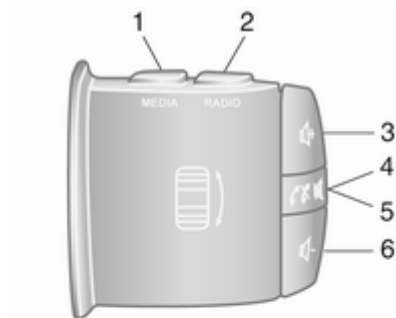

1	MEDIA - Change audio source	30
2	RADIO - Change radio waveband	48
3	🔊 - Increase volume	30
4	🔇 - Mute/unmute	30
5	☎️ - Take/end phone call ..	115
6	🔊 - Decrease volume	30
7	Turn: Move up/down in display menus, select next/previous radio preset / radio frequency / audio track	50
	Press: Confirm actions	48

Steering column controls - Type C

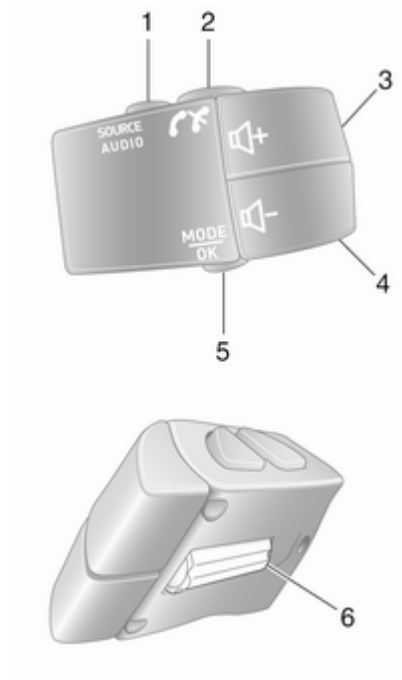

- | | | |
|---|--|-----|
| 1 | SOURCE/AUDIO -
Change audio source | 30 |
| 2 | | 107 |
| | Take/end phone call | 115 |
| | - Mute/unmute | 30 |
| 3 | - Increase volume,
mute/unmute | 30 |
| 4 | - Decrease volume,
mute/unmute | 30 |
| 5 | MODE/OK - Confirm
actions, change audio
mode | 48 |
| | Take/end phone call | 115 |
| 6 | Turn: Access display
menu options, next/
previous radio preset /
radio frequency / audio
track | 48 |

Notice

If equipped, the voice recognition button may be located on the steering wheel or on the steering column controls.

Theft-deterrent feature

Depending on Infotainment system, an electronic security system is included for the purpose of theft deterrence. The Infotainment system functions only in your vehicle and is therefore worthless to a thief.

The security code (supplied separately) must be entered upon first use of the system and after prolonged interruptions to the power supply.

Notice

The security code is not required for R16 BT USB, CD18 BT USB.

Entering the security code

When first switching on the Infotainment system, an enter security code message, e.g. **Radio code** followed by **0000** appears on the

display screen. Depending on Infotainment system, the message may only appear after a brief delay.

To enter first digit of security code, press numbered button **1** on the unit repeatedly until desired number is displayed. Enter second, third and fourth digits using buttons **2**, **3** and **4** in the same way.

When the full code is displayed, press and hold button **6** until an audible signal sounds. The system is unlocked when the correct code has been entered.

NAVI 50 IntelliLink,

NAVI 80 IntelliLink: Enter the security code using numbered buttons **0** to **9** on the touchscreen display. The system is unlocked when the correct code has been entered.

Incorrect code entered

Depending on Infotainment system, when the security code has been entered incorrectly, an incorrect code message, e.g. **Error code** followed by a countdown value, e.g. **Wait 100** is displayed.

Wait until the countdown has expired, then enter the correct code. Each time the code is entered incorrectly, the countdown time may be doubled, depending on Infotainment system.

Changing the geographical area

When the security code is entered, depending on Infotainment system you may be prompted to choose a geographical area, for example:

- Europe
- Asia
- Arabia
- America

Switch off the Infotainment system, then simultaneously press button **1** and **5** and \odot . Then press \blacktriangleleft or \blacktriangleright until desired area is highlighted on the display screen and set with button **6**.

Usage

Infotainment controls

The Infotainment system is operated via buttons, rotary knobs and/or display menus.

Inputs are made via:

- the central control unit in the instrument panel \curvearrowright 6, or
- the controls on the steering column \curvearrowright 6
- the voice recognition system (if available) \curvearrowright 104
- the touchscreen (NAVI 50 IntelliLink, NAVI 80 IntelliLink) \curvearrowright 39

Notice

Only the most direct ways for menu operation are described in the subsequent chapters. In some cases, there may be other options.

Switching the Infotainment system on or off

Press \odot to switch the Infotainment system on.

The previously used audio source is active.

Press \odot (or, depending on Infotainment system, press and hold) to switch the Infotainment system off.

Notice

The clock and/or outside temperature may be displayed when the Infotainment system is switched off (depending on version).

NAVI 50 IntelliLink:

The Infotainment system automatically switches on/off when the ignition is switched on/off. Press \odot instead, if required.

NAVI 80 IntelliLink:

The Infotainment system switches on automatically when the ignition is switched on (depending on version). Press \odot instead, if required.

The following options may be displayed (depending on version):

- **Change settings** (to authorise or reject data sharing)

Notice

When data sharing is switched off, certain features may not operate correctly.

- **Language** (to change the system language)
- **Done** (to continue to the Home page)

The Infotainment system automatically switches off when the ignition is switched off and the driver's door is opened. Press \odot instead, if required.

Automatic switch-off

With the ignition off, if the Infotainment system is switched on with \odot , it will switch-off automatically a short period after the last user input. Depending on Infotainment system, automatic switch-off occurs after approx. 5 to 20 minutes.

Pressing \odot again will allow the Infotainment system to remain on for a further 5 to 20 minutes, depending on Infotainment system.

Setting the volume

Turn \odot /volume rotary knob, or press $+$ or $-$.

Alternatively (with the steering column controls), press \leftarrow or \rightarrow .

NAVI 50 IntelliLink:

Depending on version, it is possible to set various volume levels individually (including audio players, traffic

announcements, navigation instructions, phone calls and ringtone).

From the Home page, touch \otimes **Setting(s)** then **Audio** followed by **Sound**.

Refer to (NAVI 50 IntelliLink) "Volume settings" \rightarrow 42.

NAVI 80 IntelliLink:

To set various volume levels individually (e.g. navigation instructions, traffic announcements, phone calls) from the Home page, touch **MENU** then **System** followed by **Sound**.

Refer to (NAVI 80 IntelliLink) "System settings" \rightarrow 43.

Stored volume





When the Infotainment system is switched off, the current volume is stored.

Speed dependent volume

When speed dependent volume (\rightarrow 43) is activated, the volume is adapted automatically to compensate for road and wind noise.



Mute

To mute the current audio source (depending on Infotainment system), press  briefly or turn knob fully anticlockwise.

Alternatively (with the steering column controls), press  or  or press  and  simultaneously.

Unmute

To unmute (depending on Infotainment system), briefly press  again or turn clockwise.

Alternatively (with the steering column controls): Press  again or press  and  simultaneously again.

Notice

When a traffic announcement is broadcast, the system is automatically unmuted.











For further information, refer to "Radio data system" .

Display screen operation**R15 BT USB, R16 BT USB, CD16 BT USB, CD18 BT USB - Display screen operation**

- To move up/down in the display: Turn **OK**.
- To confirm actions: Press **OK**.
- To cancel actions (and return to previous menu): Press .

NAVI 50 IntelliLink - Display screen operation



Use the touchscreen for the following displayed menus as described in each section:

-  /  **RADIO**
Refer to "Radio" section .
-  /  **MEDIA**
Refer to "USB port" section .
-  **PHONE**
Refer to "Phone" section .
-  **MAP** /  **Map**
Refer to "Navigation" section .

-  **NAVI** /  **Nav**



Refer to "Navigation" section .

-  **SETTING(S)**

Refer to (NAVI 50 IntelliLink) "Tone settings" , "Volume settings"  and "System settings" .

Notice

Depending on software version, the menus available on the display screen may differ from those listed above.

When the Home page  is displayed, it is possible to hide these menus from the display (only clock and audio system information may be shown) by touching . Touch anywhere on the screen to display these menus again.

NAVI 80 IntelliLink - Display screen operation

Use the touchscreen for the following displayed menus as described in each section.

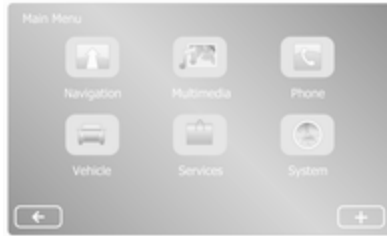

On the Home page, touch **MENU** to access the Main menu. The following menus and controls are displayed:

- **Navigation**
Refer to "Navigation" ⇨ 75.
- **Multimedia:**
 - **Radio:** Refer to "Radio" ⇨ 48.
 - **Media:**
CD (only available with Type B and C): Refer to "CD player" ⇨ 58.
USB: Refer to "USB port" ⇨ 63.

SD: Operation is similar to those for the CD player ⇨ 58.

Auxiliary: Refer to "AUX input" ⇨ 61.

Bluetooth: Refer to "Bluetooth music" ⇨ 67.

- **Pictures:** Refer to "Displaying pictures" in the "External devices" section ⇨ 73.
- **Video:** Refer to "Playing movies" in the "External devices" section ⇨ 73.
- **Settings:** Refer to "Multimedia settings" in the (NAVI 80 IntelliLink) "System settings" section ⇨ 43
- **Phone**
Refer to "Phone" ⇨ 107.
- **Vehicle**
Touch to open Eco Driving, Onboard computer and Settings menus.
Refer to (NAVI 80 IntelliLink) "Modes of operation" below.

- **Services**

Touch to open Navigation services and Settings menus.
Refer to (NAVI 80 IntelliLink) "Modes of operation" below.

- **System**

Refer to (NAVI 80 IntelliLink) "System settings" ⇨ 43.

Notice

Depending on software version, the menus on the display screen may differ from the illustrations shown.

- □/←: Move to previous page
- >/→: Move to next page
- ↑: Display lists; Scroll up
- ↓: Display lists; Scroll down
- ⊕: Open pop-up menu
- ←: Return to previous menu

The display screen can also be operated using the controls on the Infotainment system fascia.

Notice

Depending on version, some controls available on the Infotainment system fascia do not operate the features on the display screen.



Notice

Depending on vehicle, operation of the touchscreen may be restricted during driving.

Modes of operation**Radio**

To change the audio source to radio: Depending on Infotainment system, press **RADIO**, **RADIO/CD** or **AUDIO/SOURCE**.

NAVI 50 IntelliLink:

To access the radio menu at any time, touch  followed by  **Radio**.

NAVI 80 IntelliLink:

To access the radio menu from the Home page, touch **MENU** then **Multimedia** followed by **Radio**.

Detailed description of the radio functions ⇨ 48.

Audio players

To change the audio source to **CD**, **USB**, **AUX**, Bluetooth or iPod (where applicable): Depending on Infotainment system, touch **MEDIA**, **RADIO/CD** or **AUDIO/SOURCE**.

NAVI 50 IntelliLink: To access the menu for connected auxiliary devices (**USB**, **iPod**, **BT** (Bluetooth) or **AUX**) at any time, touch  followed by  **Media**. Touch  in top left corner and select auxiliary source.

For **Aha®** application (available depending on version), refer to "Additional features (NAVI 50 IntelliLink)" below.

NAVI 80 IntelliLink: To access the menu for auxiliary devices (e.g. Audio CD, USB, SD card, AUX input, Bluetooth) from the Home page, touch **MENU** then **Multimedia** followed by **Media**. Select auxiliary source from the display list.

R15 BT USB, R16 BT USB

Detailed descriptions of:

- AUX input functions ⇨ 61
- USB port functions ⇨ 63
- Bluetooth music operation ⇨ 67

CD16 BT USB, CD18 BT USB

Detailed descriptions of:

- CD player functions ⇨ 58
- AUX input functions ⇨ 61
- USB port functions ⇨ 63
- Bluetooth music operation ⇨ 67

NAVI 50 IntelliLink

Detailed descriptions of:

- AUX input functions ⇨ 61
- USB port (including iPod) functions ⇨ 63
- Bluetooth music operation ⇨ 67

NAVI 80 IntelliLink

Detailed descriptions of:

- CD functions (Type B and C only) ⇨ 58
- AUX input functions ⇨ 61

- USB port functions ⇨ 63
- Bluetooth music operation ⇨ 67

Navigation, Map (NAVI 50 IntelliLink, NAVI 80 IntelliLink)

Detailed description of the Navigation system ⇨ 75, Browse map ⇨ 96.

Phone

Use the display options in the following menus to connect mobile phones, make telephone calls, create contacts lists and adjust various settings.

Detailed description of the handsfree phone system functions ⇨ 107.

R15 BT USB, R16 BT USB, CD16 BT USB, CD18 BT USB - Phone

To access the **Phone** menu: Press  or **TEL**.

To access the phone settings menu: Press **TEL** and select **Phone settings**.

NAVI 50 IntelliLink - Phone

To access the Phone menu at any time: Touch  followed by  **Phone**.

NAVI 80 IntelliLink - Phone

To access the Phone menu from the Home page, touch **MENU** followed by **Phone**.

Vehicle information (NAVI 80 IntelliLink)

To access the Vehicle menu from the Home page, touch **MENU** followed by **Vehicle**.

Depending on vehicle, the following menus are displayed:

- **Eco Driving**
- **Onboard computer**
- **Settings**

Eco Driving

The following features are available:

- **Trip report**

Displays the following data from the last journey:

Average fuel consumption, average speed, total fuel consumption, total distance.

Within the trip report, **Eco scoring** provides an overall score out of 100 for driving economy. Higher figures indicate better driving economy. Ratings are

also given for average environmental driving performance (Acceleration), gearchanging efficiency (Gearbox) and brake control (Anticipation).

To save journey data: Touch 'Save' then select the journey type from the following list:

Home/work, holiday/vacation, weekend, trip/tour, personal.

To reset journey data: Touch 'Reset'. Confirm or cancel with 'Yes' or 'No'.

Touch  to open pop-up menu where trip reports can be compared or to show/hide reports after the completion of a journey.

- **My preferred trips**

Displays changes in your driving style (when journey data has been saved).

The 'Summary' tab for each journey type (e.g. Home/work) displays the following: Total route distance, distance covered, date of information update and

average driving economy rating out of 100.

The 'Detailed report'/'Details' tab displays journey record information.

- **Eco-coaching**

Displays advice for reducing fuel consumption.

Scroll through the pages and familiarise yourself with the advice.

Onboard computer

Displays the following information since the last reset:

- start date of calculation
- total distance
- average speed
- average fuel consumption
- total fuel consumption

To reset onboard computer and instrument panel trip computer information, touch **Reset** then **Yes** to confirm.

For further information, refer to "Trip computer" in the Owner's Manual.

Settings

The following settings can be changed:

- **Park Assist**

- Depending on vehicle, touch **Front park assist** or **Rear park assist** to switch on/off (box is checked/unchecked). Touch **Done/Confirm** to save changes.

- **Volume:**

Touch **+** or **-** alongside the volume bar to change volume of the ultrasonic parking assist system. For further information, refer to "Parking assist" in the Owner's Manual.

- **Rear camera view settings** (available depending on version):

Select to switch rear view camera on/off, change guidelines (static/dynamic) and adjust image settings (e.g. brightness, saturation and contrast).

Touch **Done** to save changes. For further information, refer to "Rear view camera" in the Owner's Manual.

- **+** (pop-up menu):

Touch **+** in the **Park Assist** menu or submenus followed by **Reset to the default values** to restore default factory settings for all or current Park Assist options.

- **Image settings** (available depending on version)

To adjust e.g., brightness, saturation and contrast.

- The following options (depending on vehicle) can also be adjusted:
 - Automatically fold in the exterior mirrors to the parking position upon locking the vehicle (switch on/off).
 - Door lock while driving (switch on/off).
 - Activate rear window wiper when selecting reverse gear (switch on/off).

- Daytime running lights (switch on/off).
- Unlock the driver's door only when opening the door (switch on/off).
- Easy access (switch on/off).
- Driving style indicator (fuel economy gauge) (switch on/off).
- Eco score (switch on/off).
- Show report after trip (switch on/off).

After the settings are changed, touch **Done** to confirm.

Services (NAVI 80 IntelliLink)

To access the Services menu from the Home page, touch **MENU** followed by **Services**.

The following menus are displayed:

- **Navigation services**
- **Settings**

Navigation services

In addition to the free navigation services (e.g. traffic information, fixed speed cameras), extra features can be added by subscribing to paid LIVE services.

Refer to (NAVI 80 IntelliLink) "LIVE services" in the "Navigation" section ⇨ 78.

Settings

The following menus are displayed:

- **Applications manager**
Select to manage Bluetooth auxiliary devices.
- **Navigation services**
Select to access navigation related features, e.g. traffic, speed cameras, local search, My TomTom LIVE, weather.
Refer to (NAVI 80 IntelliLink) "LIVE services" in the "Navigation" section ⇨ 78.

Notice

A compatible SD card must be inserted to access LIVE services.

Update applications

Select to update current applications.

Data sharing settings

Select to switch data sharing on/off.

Notice

When data sharing is switched off, certain features may not operate correctly.

Favourites (NAVI 80 IntelliLink)

When the Home page is displayed, touch ★ to view, add or delete favourites for the following features:

- ↑ **Navigation** ⇨ 75.
- 📻 **Multimedia** - refer to "Radio" ⇨ 48.
- 📞 **Phone** ⇨ 107.
- 📱 **Services** ⇨ 78.

Navigation favourites

Select an empty slot in the display or touch + (to open a pop-up menu), then select **Add Favourite**.

Choose from the displayed list to add a saved destination to the favourites.

For further information, refer to (NAVI 80 IntelliLink) "Destination input" in the "Navigation" section ⇨ 90.

Multimedia favourites

Select an empty slot in the display or touch **+** (to open a pop-up menu), then **Add Favourite**.

Choose from the displayed list to add a preset FM radio station to the favourites.

Phone favourites

Select an empty slot in the display or touch **+** (to open a pop-up menu), then **Add Favourite**.

Choose from the displayed list to add a phone contact to the favourites.

For further information, refer to (NAVI 80 IntelliLink) "Phonebook" in the "Phone" section ⇨ 115.

Services favourites

Select an empty slot in the display or touch **+** (to open a pop-up menu), then **Add Favourite**.

Choose from the displayed list to add a service item to the favourites.

Delete favourites

Touch **+** and select **Remove all Favourites** or **Remove a Favourite**.

Then select a favourite from the displayed list. A confirmation message is displayed. Touch **Delete** and confirm if prompted.

Additional features (NAVI 50 IntelliLink)

Depending on version, the following additional features are available:

- Rear camera view settings.
- Aha® application (for smartphones).

Rear camera view settings

When the rear camera view is shown on the display, touch **⚙️ Setting(s)** to open the settings menu.

The following settings can be updated:

- Switch the rear camera view display **Off/On**.
- Colours

Touch **—/+** to adjust level.

- Brightness
Touch **—/+** to adjust level.
- Contrast
Touch **—/+** to adjust level.

For further information, refer to "Rear view camera" section in the vehicle Owner's Manual.

Aha® application

The Aha® app enables you to organise favourite smartphone internet content (e.g. podcasts, audio books, internet radio, social network sites etc.) and access favourites instantly. Aha® can also be used during navigation, to suggest e.g. hotels and restaurants in the vicinity, and provide weather information and current GPS position.

Aha® must first be downloaded onto your smartphone. Launch the app on your smartphone and create a user account to enable use via the Infotainment system.

To connect to Aha® via the Infotainment system, a bluetooth connection must be set up between

the smartphone and the Infotainment system, i.e. the device must be paired to the vehicle before using it. Refer to "Bluetooth connection" in the "Phone" section ⇨ 111 for further information.

Notice

Data sharing and location services must be enabled on the smartphone to use the Aha® app. During use, data transfer may incur additional costs not included in the contract with your network provider.

When a bluetooth connection is active, Aha® can be accessed via the Infotainment system. From the Home page, touch  **Media**. Touch ▼ in top left corner to display the list of auxiliary sources, then select **aha**.

The following menus are displayed:

- **Player**
- **List**
- **Presets**
- **Nearby**

To access your Aha® favourites, select **Presets**.

While using the navigation system ⇨ 75, to find a nearby point of interest (POI) with Aha® touch **Nearby** and select a group (e.g. hotel, restaurant). A range of POIs in the vicinity are displayed; select the required POI. The POI can be set as either a destination or a waypoint by touching .

Depending on POI type, contact details and further information may be displayed. When phone numbers are provided for POIs, they can also be dialled using the handsfree phone system by touching .

For further information, refer to "Operation" in the "Phone" section ⇨ 115.

Touch operation overview

The Infotainment system display (NAVI 50, NAVI 80 IntelliLink) has a touch-sensitive surface that allows direct interaction with the displayed menu controls.

Caution

Do not use pointed or hard items like ballpoint pens, pencils or similar for touchscreen operation.

Selecting or activating a screen button or menu item

Touch a screen button or menu item.

- A short touch activates the selected item.
- Touch and hold to save a selected item.

The corresponding system function is activated, a message is shown, or a submenu with further options is displayed.

Notice

In subsequent chapters, the operating steps for selecting and activating a screen button or menu item via the touch screen will be described as "...select <button name>/<item name>".

Scrolling lists

If there are more items available than presentable on the screen, the list must be scrolled.

To scroll through a list of menu items, touch ▼ or ▲ at the top and at the bottom of the scroll bar.

Touch and hold ▼ or ▲ to fast scroll through a list.

Notice

In subsequent chapters, the operating steps for scrolling to a list item via the touch screen will be described as "...scroll to <item name>".

Scrolling within a map

Touch anywhere on the map. The cursor indicates the current position. To scroll within the map, drag the map in the required direction.

Notice

Constant pressure must be applied and the finger must be moved at constant speed.

Pop-up menus

To open pop-up menus with additional options, touch +.

To exit a pop-up menu without accessing any options or making any changes, touch any part of the screen outside the pop-up menu.

Tone settings

R15 BT USB, R16 BT USB, CD16 BT USB, CD18 BT USB - Tone settings

In the audio settings menu, the tone characteristics can be set.

Press **SETUP** to access the settings menu.

Select **Audio settings**, then **Sound** and turn **OK** until the desired setting is selected from:

- BASS (bass)
- TREBLE (treble)
- FADER (front/rear balance)
- BALANCE (left/right balance)

The display indicates the type of setting followed by the adjustment value.

Set the desired value by turning **OK** and press the knob to confirm selections.

To exit the audio settings menu, press →.

Notice

If there is no activity, the system will exit the audio settings menu automatically.

Setting bass and treble

Select **Bass** or **Treble**.

Set the desired value by turning **OK** and press the knob to confirm setting.

Depending on version, **BASS BOOST** setting is also available.

Setting the volume distribution between right - left

Select **Balance**.



Set the desired value by turning **OK** and press the knob to confirm setting.

Setting the volume distribution between front - rear

Available depending on version.
Select **Fader**.

Set the desired value by turning **OK** and press the knob to confirm setting.

NAVI 50 IntelliLink - Tone settings





To access the settings menu at any time, touch  followed by  **Setting(s)**.

The following settings submenus are displayed at the bottom of the screen:



- **Audio**
See "Audio settings" below.
- **Display**
Refer to (NAVI 50 IntelliLink) "System settings" ⇨ 43.
- **Bluetooth**
Refer to (NAVI 50 IntelliLink) "System settings" ⇨ 43.
- **System**
Refer to (NAVI 50 IntelliLink) "System settings" ⇨ 43.

Audio settings

Select **Audio** to display the following options:

- **Vol/Speed** (Off/1/2/3/4/5)
Speed dependent volume control - refer to (NAVI 50 IntelliLink) "Volume settings" ⇨ 42.
- **Loudness** (On/Off)
Switch loudness on to increase bass and treble levels.
- **BAL/FAD**
Depending on version, touch  to open the volume distribution balance and tone settings submenu.
On the left side of the display, adjust the right/left balance with  and the front/rear balance with  (if available).
On the right side of the display, adjust the **Bass**, **Mid** and **Treble** tone characteristics (between -5 to +5) with .
Touch **OK** to confirm changes.
- **Sound**
Depending on version, touch  to open the volume distribution

balance and tone settings submenu.

On the left side of the display, adjust the right/left balance with  and the front/rear balance with  (if available).

On the right side of the display, adjust the **Bass**, **Mid** and **Treble** tone characteristics (between -5 to +5) with .

Touch **OK** to confirm changes.

For other versions of the sound submenu (where volumes can be set individually for a list of audio types), refer to (NAVI 50 IntelliLink) "Volume settings" ⇨ 42.

NAVI 80 IntelliLink - Tone settings

Refer to (NAVI 80 IntelliLink) "System settings" ⇨ 43.



Volume settings

R15 BT USB, R16 BT USB, CD16 BT USB, CD18 BT USB - Volume settings

Press **SETUP** to access the settings menu.

Select **Audio settings**, then **Speed vol.** and turn **OK** until the desired setting is selected.

NAVI 50 IntelliLink - Volume settings

To access the settings menu at any time, touch  followed by  **Setting(s)**.

The following settings submenus are displayed:



- **Audio**
See "Audio settings" below.
- **Display**
Refer to (NAVI 50 IntelliLink) "System settings" ⇨ 43.

- **Bluetooth**
Refer to (NAVI 50 IntelliLink) "System settings" ⇨ 43.
- **System**
Refer to (NAVI 50 IntelliLink) "System settings" ⇨ 43.

Audio settings

Select **Audio** to display the following options:

- **Vol/Speed** (Off/1/2/3/4/5)
The volume increases when vehicle speed increases, to compensate for wind and road noise.
Speed compensated volume can be switched off or the degree of volume adaptation can be set.
- **Loudness** (On/Off)
Switch loudness on to increase bass and treble levels.
- **BAL/FAD**
Refer to (NAVI 50 IntelliLink) "Tone settings" ⇨ 40.
- **Sound**
Touch  to open the audio preferences submenu.

Depending on version, the volume of different audio types can be set independently, e.g. audio, traffic announcements (TA), navigation instructions, handsfree phone system and ringtone levels. Touch   to adjust volume of each audio type.

If required, touch **Reset to defaults** to return all volumes to the factory settings.

For other versions of the sound submenu, refer to (NAVI 50 IntelliLink) "Tone settings" ⇨ 40.

NAVI 80 IntelliLink - Volume settings

Refer to (NAVI 80 IntelliLink) "System settings" ⇨ 43.

System settings

R15 BT USB, R16 BT USB, CD16 BT USB, CD18 BT USB - System settings

Press **SETUP** and access the settings menu by turning and pressing **OK**.

When system setting adjustments have been made, press **SETUP** to exit the menu and save changes. The system also saves and exits automatically after a delay.

Set clock

To set the system clock and the time display format, select **Clock**. Select the required setting by turning and pressing **OK**.

Change system language

Change the display language by accessing the **Language** menu. Select a language from the list by turning and pressing **OK**.

Restore default system settings

To restore system settings to their default values, select **Default settings** by turning and pressing **OK**. Confirm modification when prompted by pressing **OK** again.

NAVI 50 IntelliLink - System settings

To access the settings menu at any time, touch  followed by **Setting(s)**.

The following settings submenus are displayed at the bottom of the screen:

- **Audio:**
Refer to (NAVI 50 IntelliLink) "Tone settings" ⇨ 40 and "Volume settings" ⇨ 42.
- **Display:** See below.
- **Bluetooth:** See below.
- **System:** See below.

Display

Select **Display** to display the following options:

- **Brightness** (Low/Mid/High)
- **Map mode** (Auto/Day/Night)
 - **Auto:** Day and night mode are changed automatically.
 - **Day:** The map screen is always displayed with bright colours.
 - **Night:** The map screen is always displayed with dark colours.
- **Background** (Dark/Light)
Available depending on version. Switch between a dark or light display mode (available depending on vehicle).

Bluetooth

Select **Bluetooth** to display the following options:

- **View Bluetooth device list**
- **Search for Bluetooth device**
- **External device authorisation**

- **Change passkey** (for pairing of Bluetooth devices with the Infotainment system)
- **Smartphone**
Available depending on version.
For help with activating and operating voice controls - refer to "Voice recognition" ⇨ 104.

For further information on Bluetooth settings, refer to (NAVI 50 IntelliLink) "Bluetooth music" ⇨ 67 and "Bluetooth connection" in the "Phone" section ⇨ 111.

System

Select **System** to display the following options:

- **Language**
Change display language and voice instruction language for Navigation system. Press **OK** to confirm selection.
- **Clock/units**
The following settings can be changed:

- **Time Format** (12h/24h)
- **Units/Nav Units** (km/mls)
- **Time Setting**
Press ► to open the **Time set** submenu containing the following options:

Auto/Manual

If Auto time setting is selected, the time is set automatically by GPS.

If Manual time setting is selected, adjust as appropriate.

Notice

Navigation maps for the current country must be installed on the system to ensure the local time is correct.

- **Factory settings**
The following settings can be reset to the factory default:
 - **All**
 - **Phone**
 - **Navigation**
 - **Audio-Media-Radio-System**

- **Navigation** (On/Off)
- **System version** (displays Infotainment system software version number)

When system setting adjustments have been made, touch  (and select another menu on the display) to exit the settings menu and save changes. The system also saves and exits automatically after a delay.

NAVI 80 IntelliLink - System settings

To access the system settings menu from the Home page, touch **MENU** followed by **System**.

The following settings submenus are displayed:

- **Language**
- **Display**
- **Sound**
- **Clock**
- **Safety warnings**
- **Home screen**
- **Keyboards**
- **Set units**

- **Status & Information**
- **Remove SD-card**
- **Restore factory settings**

After system settings are changed, touch **Done** to confirm.

Language

To change Infotainment system language then voice type (depending on version).

Display

The following settings are displayed:

- **Daytime brightness:** Change screen brightness to suit external light levels (daylight).
During low external light levels, the display screen is easier to view when the display is not too bright.
- **Nighttime brightness/Night brightness:** Change screen brightness to suit external light levels (night light).
During low external light levels, the display screen is easier to view when the display is not too bright.

- **Automatic day/night mode/ Switch to night mode at night:** To activate automatic switching between daytime/night brightness.

Night mode is activated during low external light levels and when the headlights are switched on.

- **Force night mode/Use night mode:** To activate night mode.

Sound

The following settings submenus are displayed:

- **Sound levels:** To change volume and sounds for the main volume, handsfree phone system, phone ringtone, navigation instructions, system/computer voice, traffic information, and park assist (depending on version).
- **Alerts:** To adjust alert volume, and switch on/off alerts when display screen is switched off.
- **Speed sensitivity volume:** To set volume adjustment based on vehicle speed.

- **Voice output settings:** Adjust types of information to be given by the Infotainment system voice (e.g. "Read aloud motorway lane instructions").
- **Voice:** Change the voice used by the Infotainment system (if available).

Clock

To set the system clock and the time display format.

Keeping the automatic time adjustment setting switched on is recommended.

Safety warnings

To switch on/off various alerts provided by the Infotainment system (e.g. "Warn when driving faster than allowed"). Check appropriate boxes to switch on.

Home screen

To change the home page configuration.

Select from list of options to see a preview of each home page layout.

Keyboards

To change first the alphabet type (e.g. Latin, Greek) then the keyboard type (e.g. Qwerty, ABCD).

Set units

To change the units of measurement, for e.g. distance (km/miles), co-ordinates (degrees, minutes, seconds), temperature (°C, °F) and barometric units (if available).

Status & Information

To display system information, e.g. version, GPS status, network status, licences and copyright information.

Remove SD-card

To eject the SD card safely.

Restore factory settings

To delete all Infotainment system information. Follow the instructions on the display.

Notice

Afterwards, the Infotainment system will restart in English by default. If necessary, select **Language** in the **System** menu to change language.

Multimedia settings

To access the Multimedia settings menu from the Home page, touch **MENU** then **Multimedia**, followed by **Settings**.

The following settings submenus are displayed:

- **Sound**
- **Radio**
- **Media**
- **Pictures**
- **Video**

After settings have been changed, touch **Done** to confirm.

Sound

The following sound settings can be updated:

- 'Balance':
Set the sound distribution in the vehicle.
- 'Bass Treble':
Set the sound option, e.g. 'Neutral' or 'Pop-rock', 'Classical', 'Jazz' (if available). Select 'Manual' to manually set the treble and bass levels.

Press **Done** to save changes.

- 'Demo arkamys' (if available):
Select to trial Arkamys mode.
- 'Bass Boost Arkamys':
Switch bass amplification on/off.

Radio

The following radio settings can be updated:

- switch searching for Alternative Frequencies (AF) on/off
- switch i-traffic (Traffic program information) on/off
- switch programme type (PtY) on/off
- switch Simulcast on/off
- display i-announcement information (e.g. Area weather information, Event information)
- update list of saved radio stations

For further information, refer to (NAVI 80 IntelliLink) "Radio" ⇨ 48.

Media

The following media settings can be updated:

- switch Repeat (a track) on/off
- switch Shuffle on/off
- switch Display album cover on/off
- configure Manage Bluetooth devices

For further information, refer to (NAVI 80 IntelliLink) "Bluetooth music" ⇨ 67.

Pictures

The following photo settings can be updated:

- set display time for photos during a slideshow ("Slide show delay")
- switch from normal to full screen display ("Default view")

For further information, refer to "Displaying pictures" ⇨ 73.

Video

The following video settings can be updated:

- set display type for videos (if available)
- switch from normal to full screen display

For further information, refer to "Playing movies" ⇨ 73.

Radio

Usage	48
Station search	50
Autostore lists	52
Radio data system (RDS)	53
Digital audio broadcasting	55

Usage

Radio reception

Radio reception may be disrupted by static, noise, distortion or loss of reception due to:

- changes in distance from the transmitter
- multi-path reception due to reflection
- shadowing

R15 BT USB, R16 BT USB, CD16 BT USB, CD18 BT USB - Controls

The most important buttons for control of the radio are:

- **RADIO**: Activate radio, change waveband
- **◀▶**: Station search
- **OK**: Change frequency
- Station buttons 1...6: Preset station buttons

- **SETUP**: System settings, automatic station storing
- **TEXT**: Display radio text information

Activating the radio

Press **RADIO** to switch the audio source to radio.

The station previously selected will be received.

Selecting the waveband

Press **RADIO** repeatedly to switch between the available wavebands (e.g. FM1, FM2, AM).

The station previously selected in that waveband will be received.

NAVI 50 IntelliLink - Controls



Use the touchscreen to operate the radio.

The main controls are:

- **FM/AM/DAB** (depending on version): Switch between FM and AM wavebands.
- **◀▶**: Start automatic search for next/previous radio station.

- ◀/▶: Change to next/previous frequency in increments of 0.5.
- ▲/▼: Scroll through a list of stations.

Activating the radio

To activate the radio at any time, touch  followed by  **Radio**. The station previously selected will be received.

The following submenus are displayed at the bottom of the screen:

- **Main:** Radio station/frequency is displayed.
- **List:** Displays an alphabetical list of available radio stations (maximum 50 stations).

Notice

Radio stations without RDS: Only the frequency is displayed. These stations appear at the end of the list.

- **Presets:** Displays stored favourite radio stations.
- **Options:**
The following settings can be changed, depending on selected waveband:

- **RDS** (On/Off)
- **TA** (On/Off)
- **Region** (On/Off)
- **News** (On/Off)
- **AM** (On/Off)
- **Update list** (Start)

For further information, refer to (NAVI 50 IntelliLink) "Radio data system (RDS)" ⇨ 53.

Selecting the waveband

Touch ▼ alongside **FM/AM/DAB** (if available) in the top left corner of the display and select FM, AM or DAB waveband.

The station previously selected in that waveband will be received.

Notice

AM waveband can be switched off via the **Options** menu.

Refer to "Digital audio broadcasting" ⇨ 55.

NAVI 80 IntelliLink - Controls

Use the touchscreen to operate the radio.

The main controls are:

- **FM/AM/DR:** Switch between FM, AM and DR (digital radio) wavebands.
- ◀/▶: Start automatic search for next/previous radio station.
- </>: Change to next/previous frequency in increments.
- ↑/↓: Scroll through a list of stations.

Activating the radio

To access the Radio from the Home page, touch **MENU** then **Multimedia**, followed by **Radio**.

The following modes are available:

- **Preset:**
Displays stored favourite radio stations.
- **List:**
Displays an alphabetical list of available radio stations (maximum 50 stations).

Notice

Radio stations without RDS: Only the frequency is displayed. These stations appear at the end of the list.

- **Frequency:**

Search manually or automatically by scanning the selected range of frequencies.

Selecting the waveband

Touch **FM/AM/DR** tab in top left corner of the display to switch between wavebands.

The station previously selected in that waveband will be received.

Station search**Automatic station search**

R15 BT USB, R16 BT USB, CD16 BT USB, CD18 BT USB - Automatic station search

Briefly press **◀◀** or **▶▶** to search for the next receivable station in the current waveband.

If no station is found, automatic searching continues until **◀◀** or **▶▶** is pressed again.

NAVI 50 IntelliLink - Automatic station search

Touch **◀◀** or **▶▶** to search for the next receivable station in the current waveband.

If no station is found, automatic searching continues until **◀◀** or **▶▶** is touched again.

NAVI 80 IntelliLink - Automatic station search

Touch **◀** or **▶** to search for the next receivable station in the current waveband.

If no station is found, automatic searching continues until **◀** or **▶** is touched again.

Manual station search

R15 BT USB, R16 BT USB, CD16 BT USB, CD18 BT USB - Manual station search

Select the desired waveband then press and hold **◀◀** or **▶▶** to scan the selected waveband.

Release the button when close to the required frequency. An automatic search is then made for the next receivable station and it is played automatically.

Turn **OK** to change the frequency in increments.

Stored station search

This allows you to recall radio stations that you have previously stored.

To store a station, select the desired waveband and station then press station button 1...6 until an audible signal sounds, confirming that the station has been stored to the appropriate station button. Six stations per waveband can be stored.

Recalling a stored station

To recall a station, select the desired waveband then briefly press station button 1...6.

Search radio station name (FM only)

Select the FM waveband then highlight the station name in the display using **◀** or **▶**.

Press ∇ or \blacktriangle repeatedly to manually search for the required station name. The frequency may be displayed instead if the station name is unavailable.

The alphabetical list contains up to 60 FM radio stations with the best reception. This list can be updated at any time. Autostore lists \rightarrow 52.

NAVI 50 IntelliLink - Manual station search

Select the desired waveband then touch \blacktriangleleft or \blacktriangleright to change to next/previous frequency in increments of 0.5.

Stored station search

This allows you to recall radio stations that you have previously stored.

To store a station, select the desired waveband and station then touch **Presets** to display the stored favourites.

Touch and hold on the desired location. The frequency or name of the radio station appears on the favourite location, confirming that the station has been stored (\blacklozenge indicates the currently received station).

Notice

12 stations per waveband can be stored.

Recalling a stored station

To recall a station, select the desired waveband then touch **Presets** to display the stored favourites, then select the desired favourite radio station.

Touch $\blacktriangleleft/\blacktriangleright$ to move to the previous/next page of favourites.

Search radio station name (FM and DAB only)

Select waveband FM or DAB (if available) then touch **List** to display an alphabetical list of available radio stations.

Touch \blacktriangledown or \blacktriangle to manually search for the required station name. The frequency may be displayed instead if the station name is unavailable. Select a list item to receive the selected station (\blacklozenge indicates the currently received station).

The alphabetical list contains up to 50 radio stations with the best reception. This list can be updated at any time, refer to "Autostore lists" \rightarrow 52.

NAVI 80 IntelliLink - Manual station search

Select the desired waveband then touch \blacktriangleleft or \blacktriangleright to change to next/previous frequency in increments.

Stored station search

This allows you to recall radio stations that you have previously stored.

To store a station, select the desired waveband and station then touch **Preset** to display the stored favourites.

Touch and hold on the desired location until a beep is heard. The frequency or name of the radio station appears on the favourite location, confirming that the station has been stored. 6 stations per waveband can be stored.

Alternatively, select the desired waveband and station, then select **Frequency** or **List**. Touch \blackplus to open a pop-up menu, then select **Save as preset**. Touch and hold on the desired location until a beep is heard.

Recalling a stored station

To recall a station, select the desired waveband then touch **Preset** to display the stored favourites, then select the desired favourite radio station.

Search radio station name (FM only)

Select the FM waveband then touch **List** to display an alphabetical list of available radio stations.

Touch \uparrow or \downarrow to manually search for the required station name. The frequency may be displayed instead if the station name is unavailable.

The alphabetical list contains up to 50 radio stations with the best reception. This list can be updated at any time, refer to "Autostore lists" \hookrightarrow 52.

Autostore lists

The stations with the best reception in a waveband can be searched for and stored automatically via the autostore function.

Automatic station storing

R15 BT USB, R16 BT USB, CD16 BT USB, CD18 BT USB - Automatic station storing

The FM waveband has an autostore list (AST), on which six stations can be stored.

While listening to the radio, press and hold **RADIO**: The six stations with the strongest reception will be automatically stored on AST.

Notice

Due to signal strength, it is possible that less than six stations will be stored.

Recalling a station

R15 BT USB, R16 BT USB, CD16 BT USB, CD18 BT USB - Recalling a station

Select the desired waveband, then briefly press station button 1...6 to recall a stored station.

To recall a station on the autostore list (AST), while listening to the radio briefly press **SETUP** to activate AST mode. The station previously selected will be received. Briefly

press station button 1...6 to recall another stored station on the autostore list.

Updating stations list manually

Stations can also be stored manually in the autostore list.

Notice

Only available with NAVI 50 IntelliLink, NAVI 80 IntelliLink.

To update the list of stations and obtain the most recent ones, activate the system update manually. Depending on Infotainment system, the sound may be muted during a manual update.

NAVI 50 IntelliLink - Updating stations list manually

Touch **Options**, scroll down to **Update List** then select **Start; Updating ...** appears on the display until the update is complete.

Notice

If DAB is available, it is recommended to update the DAB stations list manually when the system is switched on.

NAVI 80 IntelliLink - Updating stations list manually

From the Home page, touch **MENU** then **Multimedia**, followed by **Settings**. Select **Radio** and scroll down to **Update radio list**.

Alternatively (depending on version), select **Multimedia** followed by **Radio**, and choose any the following modes:

- **Preset**
- **List**
- **Frequency**

Then touch **+** to open a pop-up menu, and select **Update radio list**.

Radio data system (RDS)

RDS is an FM station service that helps you find the desired station and ensures its fault-free reception.

Advantages of RDS

- The programme name of the chosen station appears on the display screen instead of its frequency.
- During an automatic station search, the Infotainment system tunes into RDS stations only.
- The Infotainment system always tunes into the best receivable broadcasting frequency of the chosen station, by means of AF (Alternative Frequency).

R15 BT USB, R16 BT USB, CD16 BT USB, CD18 BT USB - RDS functions

Configuring RDS

Press **SETUP** and turn **OK** to access the **RDS** menu. Press knob to select.

Turn the rotary knob to select **RDS SETUP**.

Switching RDS on and off

Press **Options** on the display screen. The following settings can be changed:

Switch on/off **RDS-AF** by pressing **OK**. **AF** is shown on the display screen when RDS is active.

Text information (Radio text)

Certain FM radio stations issue text information relating to the broadcast program (e.g. song name).

Press **SETUP** and turn **OK** to access the **Radio texts** menu.

Turn the rotary knob to select **Radio** and press the knob to see this information.

NAVI 50 IntelliLink - RDS functions

Configuring RDS

Select **Options**. The following settings can be changed:

- **RDS** (On/Off)
Switch off if not required.
- **TA** (On/Off)
See below.
- **Region/AF** (On/Off)
See below.

- **News** (On/Off)
See below.
- **AM** (On/Off)
Switch off if not required.
- **Update list** (Start)
Refer to (NAVI 50 IntelliLink)
"Autostore lists" ⇨ 52.

TA (Traffic announcements)

If **TA** is switched on:

- Traffic announcements from certain FM radio stations (and DAB stations, if available) are broadcast automatically.
- Radio and auxiliary audio source playback is interrupted for the duration of the traffic announcement.

Notice

Automatic broadcasting of traffic announcements is deactivated if waveband is set to **AM**.

Region/AF

If the RDS function is activated and **Region/AF** is switched on:

The frequency of certain FM radio stations may change depending on the geographical area.

Poor reception can sometimes cause erratic and unwelcome changes in frequency. Switch off **Region/AF** if necessary.

News

If **News** is switched on:

- News announcements from certain FM radio stations (and DAB stations, if available) are broadcast automatically.
- Radio and auxiliary audio source playback is interrupted for the duration of the traffic announcement.

Text information (Radio text)

Certain FM radio stations (and DAB stations, if available) issue text information relating to the broadcast program (e.g. song name).

NAVI 80 IntelliLink - RDS functions

Configuring RDS

To access the Radio settings menu from the Home page, select **MENU** then **Multimedia**, followed by **Settings** then **Radio**.

Depending on version, touch **+** to open a pop-up menu, and access the 'Radio settings' option.

The following radio settings can be updated:

- switch searching for Alternative Frequencies (AF) on/off
- switch i-traffic (Traffic program information) on/off
- switch programme type (PtY) on/off
- switch Simulcast on/off
- display i-announcement information (e.g. Area weather information, Event information)
- update list of saved radio stations

Alternative Frequency (AF)

Switch on the RDS-AF function to always tune into the best receivable broadcasting frequency of the chosen station

Poor reception can sometimes cause erratic and unwelcome changes in frequency. Switch off RDS-AF function if necessary.

i-traffic (Traffic program information)

Radio traffic service stations are FM RDS stations that broadcast traffic news.

Switch on I-Traffic to automatically receive traffic bulletins when they are broadcast.

Programme type search (PtY)

Switch on PtY to display the type of programme (e.g. news, sport) currently being broadcast

Update radio list

Refer to (NAVI 80 IntelliLink)
"Autostore lists" ⇨ 52.

Simulcast

Switch on the Simulcast function to automatically change from a DR (digital radio) station to the same station on the FM waveband in the event of a loss of reception.

i-announcement

Select to display information such as weather or events in the vicinity.

Text information (Radio text)

Certain FM radio stations issue text information relating to the broadcast program (e.g. song name).

To check for text information, from any radio mode (e.g. **Preset**, **List**, **Frequency**) touch **+** to open a pop-up menu, and access the text information option, by selecting e.g. "Show radio text".

Digital audio broadcasting

Digital audio broadcasting (DAB) is an innovative and universal broadcast system.

General information

- DAB stations are indicated by the programme name instead of the broadcasting frequency.
- With DAB, several radio programmes (services) can be broadcast on a single frequency (ensemble).
- Besides high-quality digital audio services, DAB is also able to transmit programme-associated data and a multitude of other data services including travel and traffic information.
- As long as a given DAB receiver can pick up the signal sent out by a broadcasting station (even if the signal is very weak), sound reproduction is ensured.
- There is no fading (weakening of the sound) that is typical of AM or FM reception. The DAB signal is reproduced at a constant volume.
- Interference caused by stations that are on nearby frequencies (a phenomenon that is typical of AM and FM reception) does not occur with DAB.

If the DAB signal is too weak to be picked up by the receiver, the system switches over to the same programme on another DAB or FM station.

- If the DAB signal is reflected by natural obstacles or buildings, the reception quality of DAB is improved, whereas AM or FM reception is considerably impaired in such cases.
- When DAB reception is enabled, the FM tuner of the Infotainment system remains active in the background and continually searches for the best receivable FM stations.

CD Player

General information	57
Usage	58

General information

The Infotainment system's CD player can playback audio CDs, MP3 CDs and also WMA CDs (depending on version).

CD16 BT, CD18 BT: AAC and WAV formats can also be played.

Important information about audio CDs and MP3/WMA CDs

Caution

Under no circumstances place DVDs, single-CDs with a diameter of 8 cm or shaped CDs in the audio player.

You must not put any stickers on CDs. These discs can get jammed in the CD drive and ruin the drive. An expensive replacement of the device will then be necessary.

- Audio CDs with copy protection, which are not in compliance with the audio CD standard, may not play correctly or not at all.

- Self-recorded CD-Rs and CD-RWs and WMA files with Digital Rights Management (DRM) from online music shops may not play correctly or not at all.
- On mixed mode CDs (combinations of audio and data, e.g. MP3), only the audio tracks will be detected and played.
- Self-recorded CD-Rs and CD-RWs are more vulnerable to mishandling than prerecorded CDs. Correct handling, especially in the case of self-recorded CD-Rs and CD-RWs, must be ensured; see below.
- Avoid leaving fingerprints when you change CDs.
- Put CDs back in their sleeves immediately after removing them from the CD player, in order to protect them from dirt and damage.
- Dirt and liquids on CDs can smear the lens of the audio player inside the device and cause faults.

- Protect CDs from heat and direct sunlight.
- The following restrictions apply for MP3/WMA CDs:
 - Only MP3 files and WMA files can be read.
 - Maximum folder structure depth: 11 levels.
 - Maximum number of MP3 and/or WMA files that can be saved: 1000 files.
 - Applicable playlist extensions: .m3u, .pls.
 - Playlist entries must be in the form of relative paths.
- The operation of MP3 and WMA files is identical. When a CD with WMA files is loaded, MP3-related menus are displayed.

Usage

CD16 BT USB, CD18 BT USB - CD player usage

Starting CD playback

Switch on the Infotainment system (by pressing \odot) and push the CD with the printed side up into the CD slot until it is pulled in: CD playback starts automatically.

If there is already a CD in the unit, press **MEDIA** repeatedly to select the desired audio source: CD playback is started.

Notice

Depending on the data stored on the audio CD or MP3 CD, differing information about the CD and the current music track will be shown on the display.

Selecting an album or track

Turn **BROWSE** to select an album or track from the list.

Press the knob to select.

Skipping to the next track or previous track

Briefly press \lll or \ggg once or several times.

Fast forward or rewind

Press and hold \lll or \ggg to fast forward or rewind the current track.

Repeat

During CD playback, press and hold the numbered button **1** (from the Station buttons 1...6) to repeat the current track.

RPT appears on the display when repeat is active.

Press and hold the numbered button **1** again to deactivate.

RPT disappears from the display.

Random playback

During CD playback, press and hold the numbered button **2** (from the Station buttons 1...6) to activate random playback.

MIX appears on the display when random playback is active.

Notice

On an MP3 CD, the random playback function applies only to the current album.

Press and hold the numbered button **2** again to deactivate.

MIX disappears from the display.

Random playback can also be deactivated by ejecting the CD.

Notice

Random playback is not deactivated when the audio system is switched off or the source changed.

Pause

Briefly press **⏻**, **⏸** or both **⏻** and **⏸** simultaneously to interrupt CD/MP3 CD playback. Press again to resume playback.

The pause function is deactivated automatically when the volume is adjusted, the audio source is changed or automatic information messages are issued.

Displaying additional text information (CD-Text or ID3 tag)

After selecting a track or album, briefly press **TEXT** to access the text information available on the CD (e.g. artist name, album name or song name).

To display all text information at once, press and hold **TEXT**.

To exit the display, press **→**.

Removing a CD

Press **⏻**: The CD is pushed out of the CD slot.

If the CD is not removed after ejection, it will be drawn back in again automatically after a few seconds.

NAVI 80 IntelliLink (Type B and C) - CD player usage

When CD player is selected, the display includes the following options:

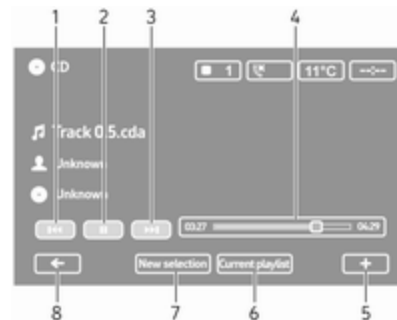

1. **⏮**: Move to previous track.
2. **⏸**: Pause track.
3. **⏭**: Move to next track.
4. Scroll bar for time elapsed: Scroll through tracks.
5. **+**: Open pop-up menu; To change the audio source or access the track settings (e.g. switch on/off shuffle or repeat, show current track details, and access sound settings).
6. **Current playlist**: Access the current playback list.

7. **New selection:** Choose another track from the connected audio source.
8. **←:** Return to previous screen.

Starting CD playback

Switch on the Infotainment system (by pressing **⏻**) and push the CD with the printed side up into the CD slot until it is pulled in: CD playback starts automatically.

If there is already a CD in the unit, touch **▼** in top left corner and select **CD**, or press **MEDIA** or **AUDIO** repeatedly to select the desired audio source: CD playback is started.

Notice

Depending on the data stored on the audio CD or MP3 CD, differing information about the CD and the current music track will be shown on the display.

Selecting an album or track

Touch **New selection** or **Current playlist**, or turn the central rotary knob to select an album or track from the list.

Skipping to the next track or previous track

Briefly touch **⏮** or **⏭** once or several times.

Fast forward or rewind

Touch and hold **⏮** or **⏭** to fast forward or rewind the current track.

Repeat

Touch **+**, or press **Options** on the central control unit to access the settings menu, then select **Repeat** to activate.

Random playback

Touch **+**, or press **Options** on the central control unit to access the settings menu, then select **Shuffle** to activate.

Notice

On a CD MP3/WMA, the random playback function applies to the current album, then moves on to the next album.

Pause

Briefly touch **⏸**, or press the volume rotary knob, **⏸** or both **⏮** and **⏭** simultaneously to interrupt CD/MP3 CD playback. Press again to resume playback.

The pause function is deactivated automatically when the volume is adjusted, the audio source is changed or automatic information messages are issued.

Displaying additional text information (CD-Text or ID3 tag)

Touch **+** and then select **Track details** to access the text information available on the CD (e.g. artist name, album name or song name).

Removing a CD

Touch **+** and then select **Eject**, or press **⏏**: The CD is pushed out of the CD slot.

If the CD is not removed after ejection, it will be drawn back in again automatically after a few seconds.

AUX input

General information	61
Usage	61

General information



Depending on version, in the Infotainment unit (or on the instrument panel) there is an AUX socket for the connection of external audio sources.

Notice

The socket must always be kept clean and dry.

It is possible, for example, to connect a portable CD player with a 3.5 mm jack plug to the AUX input.

Usage

An audio source that is connected to the AUX input can only be operated via the controls on the audio source, i.e. not via the Infotainment system. Only select a track directly on the audio source when the vehicle is stationary.

Caution

Before connecting or disconnecting an auxiliary device, e.g. a portable CD player, switch off the player and the Infotainment system, to avoid sound quality issues and possible damage to the equipment.

Upon connection via the jack plug, the system detects the audio source automatically. Depending on the recording volume, there may be a delay before the audio source is heard.

The artist or track name are not shown on the display screen.

Notice

Ensure the auxiliary device is securely stowed during driving. Vehicle occupants could be injured by objects being thrown around in the event of hard braking, a sudden change in direction or an accident.

R15 BT USB, R16 BT USB, CD16 BT USB, CD18 BT USB- AUX input usage

Press **MEDIA** or **AUDIO/SOURCE** to change the audio source to AUX mode, then switch on the auxiliary device. AUX appears on the display screen.



AUX settings

Press **SETUP** to access the settings menu.

Select AUX IN and turn **OK** until the desired setting is selected from:

- HI (300 mV)
- MID (600 mV)
- LO (1200 mV)

NAVI 50 IntelliLink - AUX input usage

To access the media menu at any time, touch  followed by  /  **MEDIA**.

To switch between auxiliary sources, touch  in top left corner. The following options are available:

- **USB:** Refer to (NAVI 50 IntelliLink) "USB port" ⇨ 63.
- **iPod:** Refer to (NAVI 50 IntelliLink) "USB port" ⇨ 63.
- **BT:** Refer to (NAVI 50 IntelliLink) "Bluetooth music" ⇨ 67.
- **Aha:** Aha® application for smartphones (available depending on version). Refer to "Usage", Additional features (NAVI 50 IntelliLink) in the "Introduction" section ⇨ 30.
- **AUX:** Select to change the audio source to AUX mode, then switch on the auxiliary device.

NAVI 80 IntelliLink - AUX input usage

Change the audio source to AUX mode to playback content from a connected auxiliary device.

To access the media menu from the Home page, touch **MENU** then **Multimedia**, followed by **Media**.

Touch  to open a pop-up menu (depending on version). The following options are available:

- **Auxiliary socket:** Change the audio source to AUX mode, then switch on the auxiliary device.
- **USB:** Refer to (NAVI 80 IntelliLink) "USB port" ⇨ 63.
- **Bluetooth connection:** Refer to (NAVI 80 IntelliLink) "Bluetooth music" ⇨ 67
- **CD player:** Refer to (NAVI 80 IntelliLink) "CD player usage" ⇨ 58.
- **SD card:** Operation is similar to those for the CD player ⇨ 58.

USB port

General information	63
Playing saved audio files	64

General information



Depending on version, in the Infotainment unit (or on the instrument panel) there is a USB socket † for the connection of external audio sources.

Notice

The socket must always be kept clean and dry.

An MP3 player, USB drive or an iPod can be connected to the USB port.

These devices are operated via the controls and menus of the Infotainment system.

Important information

MP3 player and USB drives

- The MP3 players and USB drives connected must comply with the USB Mass Storage Class specification (USB MSC).
- Only MP3 players and USB drives with a sector size of 512 Bytes and a cluster size smaller or equal to 32 kBytes in the FAT32 file system are supported.
- Hard disk drives (HDD) are not supported.
- The following restrictions apply for the data stored on an MP3 Player or USB device:

Only MP3 files, WMA and (depending on Infotainment system) ACC files can be read. WAV files and all other compressed files cannot be played.

Maximum folder structure depth: 11 levels.

Maximum number of files that can be saved: 1000 files.

NAVI 50 IntelliLink: Minimum recommended storage capacity of USB drive is 4 GB.

Recommended maximum storage capacity is 32 GB.

WMA files with Digital Rights Management (DRM) from online music shops may not play correctly or not at all.

Applicable playlist extensions: .m3u, .pls.

Playlist entries must be in the form of relative paths.

Playing saved audio files

Once connected, it is only possible to use the controls and menus of the Infotainment system to operate the audio device.

R15 BT USB, R16 BT USB, CD16 BT USB, CD18 BT USB - Playing music via USB socket

MP3 player / iPod / USB drives

The system detects the audio device when a USB device is connected and the current track is displayed automatically.

When a new audio device is connected, the first track in the first folder is played automatically. When reconnecting the device, the previously played track is resumed.

Depending on the audio device connected, select a folder (MP3 player, USB drive) or a playlist (portable digital music player).

The operation of data sources connected via USB is generally the same as for an audio/MP3/WMA CD ↷ 58.

Selecting a track

To select tracks directly (and change folders), first access the audio device menu structure by pressing OK during playback. Select tracks and change folders by turning and pressing the knob.

NAVI 50 IntelliLink - Playing music via USB socket

MP3 player / USB drives / iPod

The system detects the audio device when a USB device is connected and the current track is displayed automatically. The device type (MP3

player/USB drive or iPod) is also recognised and the relevant audio source mode (USB or iPod) is selected automatically.

When the  **MEDIA** menu is active, the following submenus are available:

- **Main/Player**
- **List**
- **Options**

To switch between audio sources, touch ▼ in top left corner. The following options are available:

- **USB:** Select to change the audio source to USB mode.

Notice

During use, the battery of a connected USB device is charged or maintained.

- **iPod:** Select to change the audio source to iPod mode.
- **BT:** Refer to (NAVI 50 IntelliLink) "Playing music via Bluetooth" - ↷ 67.
- **Aha:** Aha® application for smartphones (available depending on version).

Refer to "Usage", Additional features (NAVI 50 IntelliLink) in the "Introduction" section ↷ 30.

- **AUX:** Refer to (NAVI 50 IntelliLink) "Aux input usage" ↷ 61.

Main/Player

Select to display the current track. In this display screen, the following options are available:

- ◀◀ (skip to previous track, press and hold to fast rewind)
- ||/▶ (pause/play)
- ▶▶ (skip to next track, press and hold to fast forward)

List

Displays a list of the tracks in the current album/folder. Select a particular track to play it directly.

Notice

By default, albums are listed in alphabetical order.

If a USB drive is connected, all the folders will be at the same level on the tree structure.

To return to the previous level on the folder tree structure, touch ↶.

Options

Select to display the following options:

- **Repeat** (Off/Track/Folder/All)
- **Shuffle** (On/Off)

NAVI 80 IntelliLink - Playing music via USB socket

MP3 player / USB drives

Change the audio source to USB mode to playback files from a connected USB device.

To access the media menu from the Home page, select **MENU** then **Multimedia**, followed by **Media**.

Touch + to open a pop-up menu (depending on version). The following options are available:

- **USB:** Change the audio source to USB mode.
- **Auxiliary socket:** Refer to (NAVI 80 IntelliLink) "AUX input" ↷ 61.
- **Bluetooth connection:** Refer to (NAVI 80 IntelliLink) "Playing music via Bluetooth" ↷ 67.

- **SD card**
- **CD player:** Refer to (NAVI 80 IntelliLink) "CD player usage" ↷ 58.

When USB mode is selected, the display includes the following options:

- ◀◀ or ▶▶: Move to previous/next track.
- ||: Pause track.
- Scroll bar for time elapsed: Scroll through tracks.
- **New selection:** Choose another track from the connected audio source.
- **Current playlist:** Access the current playback list.
- ◀: Return to previous screen.
- +: Open pop-up menu; To change the audio source or access the track settings (e.g. switch on/off shuffle or repeat, show current track details, and access sound settings).

Disconnecting from USB socket

Playback is stopped immediately when the audio device is withdrawn from the USB socket.

Bluetooth music

General information	67
Operation	67

General information

Bluetooth-enabled auxiliary audio sources (e.g. music mobile phones, MP3 players etc.), which support Bluetooth music protocol A2DP, can be connected wirelessly to the Infotainment system.

Important information

- The Infotainment system only connects to Bluetooth devices that support A2DP (Advanced Audio Distribution Profile). Connection issues may arise with early versions.
- The Bluetooth device must support AVRCP (Audio Video Remote Control Profile) version 1.0 or higher. If the device does not support AVRCP, only the volume can be controlled via the Infotainment system.
- Before connecting the Bluetooth device to the Infotainment system, become acquainted with its operating instructions for Bluetooth functions.

Operation

Prerequisites

The following prerequisites must be met, in order to control a Bluetooth-enabled audio device via the Infotainment system:

- The Bluetooth function of the Infotainment system must be activated.
Refer to "Bluetooth connection" in the "Phone" section ↻ 111.
- The Bluetooth function of the Bluetooth-enabled auxiliary audio source must be activated (see audio device operating instructions).
- Dependent upon the audio source, it may be required to set that device to "visible" (see audio device operating instructions).
- The audio source must be paired and connected to the Infotainment system.

R15 BT USB, R16 BT USB, CD16 BT USB, CD18 BT USB - Playing music via Bluetooth

Bluetooth connection

A connection must be set up between the audio device and the Infotainment system via Bluetooth, i.e. the device must be paired to the vehicle before using it.

Refer to "Bluetooth connection" in the "Phone" section ↷ 111.

- A maximum of five audio devices can be paired and saved in the device list, but only one can be connected at a time.
- If the device has both audio player and telephone functions, both functions will be paired. Pairing a mobile phone ↷ 109.
- Phone functions will remain active while the audio player is in use, and audio playback will be suspended during phone use.

Pairing an auxiliary audio device to the Infotainment system

To pair the audio device, press **TEL** and select **Pair device** by turning and pressing **OK**. The **Ready to Pair** screen is displayed.

Then, on the audio device, search for Bluetooth equipment in the vicinity of the device.

Select **My Radio** (i.e. the name of the system) from the list on the audio device, then, if applicable, on the audio device keypad enter the pairing code shown on the Infotainment system display screen.

Notice

If the audio device does not have a screen, enter the default pairing code on the device, then on the Infotainment system. Refer to the operating instructions for this default audio device pairing code, usually **0000**. Depending on the device, the pairing code may need to be entered in reverse order, i.e. on the Infotainment system first.

If pairing fails, the system returns to the previous menu and a corresponding message is displayed. Repeat procedure if necessary.

When pairing is completed, a confirmation message followed by the name of the paired audio device is shown on the Infotainment system display screen.

Notice

When a Bluetooth connection is active, controlling the audio device via the Infotainment system will discharge the audio device battery more rapidly.

Connecting an audio device

Audio devices are automatically connected to the Infotainment system after the pairing procedure is completed.

To connect any audio device that has been paired, or to connect to a different paired audio device than the current one, press **TEL** and select the **Select Device** menu. The device list shows the audio devices already paired.

Select the desired device from the list and confirm by pressing **OK**. A display message confirms connection.

Disconnecting an audio device

To disconnect an audio device from the Infotainment system, press **TEL** (or **SETUP**) and select **Bluetooth connection**. Select the desired device from the device list then select **Disconnect the device** by turning and pressing **OK**. A display message confirms disconnection.

Switching off the audio device or deactivating the Bluetooth function on the audio device also disconnects the device from the Infotainment system.

Unpairing an auxiliary audio device from the Infotainment system

If the list of paired audio devices is full, a new device can only be paired if an existing device is unpaired.

To unpair, i.e. to delete an audio device from the system memory, press **TEL** and select **Delete device**. Select the desired audio device from the list and press **OK** to confirm deletion when prompted.

Operation via Infotainment system

When paired and connected wirelessly, audio playback begins automatically.

The audio device can then be operated via the Infotainment system function buttons, rotary knobs and display menus.

The range of accessible functions that can be operated via the Infotainment system depends on the type of audio player.

The operation of the audio device when connected wirelessly is similar to the operations for the CD player ↷ 58.

NAVI 50 IntelliLink - Playing music via Bluetooth

Bluetooth connection

A connection must be set up between the audio device and the Infotainment system via Bluetooth, i.e. the device must be paired to the vehicle before using it.

Refer to (NAVI 50 IntelliLink) "Bluetooth connection" in the "Phone" section ↷ 111.

- A maximum of five audio devices can be paired and saved in the device list, but only one can be connected at a time (depending on version, up to eight audio devices may be paired).
- If the device has both audio player and telephone functions, both functions will be paired. Pairing a mobile phone ↷ 109.
- Phone functions will remain active while the audio player is in use, and audio playback will be suspended during phone use.

Pairing an auxiliary audio device to the Infotainment system

To pair the audio device, touch  followed by  **SETTING(S)**.

Select **Bluetooth** then either **Search for Bluetooth device** or **External device authorisation**.

On the audio device, search for Bluetooth equipment in the vicinity of the device.

Select the name of the Infotainment system (e.g. **MEDIA-NAV**) from the list on the audio device, then (if required), on the audio device

keypad, enter the pairing code shown on the Infotainment system display screen.

The default pairing code is **0000**. To change this pairing code before the pairing procedure is started, select **Change passkey** to update.

Notice

If the audio device does not have a screen, enter the default pairing code on the device, then on the Infotainment system. Refer to the operating instructions for this default audio device pairing code, usually **0000**. Depending on the device, the pairing code may need to be entered in reverse order, i.e. on the Infotainment system first.

If pairing fails, repeat procedure if necessary.

Notice

When a Bluetooth connection is active, controlling the audio device via the Infotainment system will discharge the audio device battery more rapidly.

Connecting an audio device

Audio devices are automatically connected to the Infotainment system after the pairing procedure is completed.

To change the audio device connected, touch  followed by **SETTING(S)**.

Then select **Bluetooth** followed by **View Bluetooth device list**. The device list shows the audio devices already paired.

Select the desired audio device from the list and confirm by touching **OK**.

Disconnecting an audio device

Switching off the audio device or deactivating the Bluetooth function on the audio device disconnects the device from the Infotainment system.

Unpairing an auxiliary audio device from the Infotainment system

If the list of paired audio devices is full, a new device can only be paired if an existing device is unpaired.

To unpair, i.e. to delete an audio device from the system memory, touch  followed by **SETTING(S)**.

Select **Bluetooth** then **View Bluetooth device list**.

Select the desired audio device from the list, then touch  to delete the device. If required, delete all devices in the list by selecting **Options** followed by **Delete all**. Confirm with **OK**.

Operation via Infotainment system

When paired and connected wirelessly, audio playback begins automatically.

The audio device can then be operated via the Infotainment system display options.

The range of accessible functions that can be operated via the Infotainment system depends on the type of audio player.

The operation of the audio device when connected wirelessly is similar to the operations for playing saved audio files via the USB socket. Refer to (NAVI 50 IntelliLink) "Playing music via USB socket" in the "USB port" section ⇨ 64.

NAVI 80 IntelliLink - Playing music via Bluetooth

Bluetooth connection

A connection must be set up between the audio device and the Infotainment system via Bluetooth, i.e. the device must be paired to the vehicle before using it.

- There is a maximum number of audio devices that can be paired and saved in the device list, but only one can be connected at a time.
- If the device has both audio player and telephone functions, both functions will be paired. Pairing a mobile phone ⇨ 109.
- Phone functions will remain active while the audio player is in use, and audio playback will be suspended during phone use.

Pairing an auxiliary audio device to the Infotainment system

From the Home page, touch **MENU** then **Multimedia**, followed by **Settings**.

Select **Media** to access the media settings menu, then select the "Manage Bluetooth devices"/"Configure Bluetooth connection" option.

The pairing procedure is similar to pairing a mobile phone. Refer to (NAVI 80 IntelliLink) "Bluetooth connection" in the "Phone" section ⇨ 111.

Connecting an audio device

Audio devices are automatically connected to the Infotainment system after the pairing procedure is completed.

At any time, change the audio source to Bluetooth mode to playback files from a connected Bluetooth device.

From the Home page, select **MENU** then **Multimedia**, followed by **Media**.

Depending on version, touch **+** (to open a pop-up menu). Select **Bluetooth/Bluetooth connection** to change the audio source to Bluetooth.

Disconnecting an audio device

Switching off the audio device or deactivating the Bluetooth function on the audio device disconnects the device from the Infotainment system.

Unpairing an auxiliary audio device from the Infotainment system

To unpair, i.e. to delete a device from the system memory:

From the Home page, touch **MENU** then **Multimedia**, followed by **Settings**.

Select **Media** to access the media settings menu, then select the "Manage Bluetooth devices"/"Configure Bluetooth connection" option.

Press **+** to open a pop-up menu. The following options are available:

- **Disable Bluetooth:** Select to deactivate the Bluetooth function on the Infotainment system.
- **Set TomTom visible:** Select to make the Infotainment system "visible" to other Bluetooth devices, allowing them to be paired to the system.

- **Disconnect all devices:** Select to disconnect all currently connected devices from the Infotainment system without deleting/unpairing them.
- **Delete device(s):** Select to unpair a device from the Infotainment system.

The unpairing procedure is similar to unpairing a mobile phone. Refer to (NAVI 80 IntelliLink) "Bluetooth connection" in the "Phone" section ⇨ 111.

Operation via Infotainment system

When paired and connected wirelessly, audio playback may begin automatically.

The audio device can then be operated via the Infotainment system display options.

The range of accessible functions that can be operated via the Infotainment system depends on the type of audio player.

The operation of the audio device when connected wirelessly is similar to the operations for playing saved audio files via the USB socket. Refer

to (NAVI 80 IntelliLink) "Playing music via USB socket" in the "USB port" section ⇨ 64.

External devices

Displaying pictures	73
Playing movies	73

Displaying pictures

NAVI 80 IntelliLink - Displaying pictures

To access the "Pictures" menu from the Home page, touch **MENU** then **Multimedia**, followed by **Pictures**.

Notice

Playback is only possible when the vehicle is stationary.

Select the connected source device (e.g. SD card, USB) to access individual photos or present a slideshow of all compatible photos on the device.

The display includes the following options:

- < or >: Move to previous/next photo.
- **Thumbnails**: Switch between full screen and minimised view.
- **New selection**: Choose another photo from the connected source device.
- **+**: Open pop-up menu; To change the source device or access the photo settings.

When viewing a photo/ slideshow, the pop-up menu also allows you to set zoom level and display all photos in thumbnail form.

Photo settings - refer to (NAVI 80 IntelliLink) "System settings" ⇨ 43.

Playing movies

NAVI 80 IntelliLink - Playing movies

To access the "Videos" menu from the Home page, touch **MENU** then **Multimedia**, followed by **Video**.

Notice

Playback is only possible when the vehicle is stationary.

Select the connected source device (e.g. SD card, USB) to access individual or all compatible videos on the device.

The display includes the following options:

- **◀◀** or **▶▶**: Move to previous/next video.
- **⏸**: Pause video.
- Scroll bar for time elapsed: Scroll through videos.
- **New selection**: Choose another photo from the connected source device.
- **Full screen**: Switch to full screen display.
- **←**: Return to previous screen.
- **+**: Open pop-up menu; To change the source device or access the video settings.

During video playback, the pop-up menu also allows you to return to the list of videos.

Video settings - refer to (NAVI 80 IntelliLink) "System settings" ⇨ 43.

Navigation

General information	75
Usage	78
Destination input	90
Guidance	96
Symbols overview	103

General information

Warning

The navigation system is an aid to your navigational abilities and does not replace them. Drive with due care and attention and adopt a safe, vigilant attitude.

If a navigation system instruction contradicts traffic regulations, the traffic regulations always apply.

The Navigation system will reliably guide you to your chosen destination without the need for physical road maps.

If the **Traffic info** service is available in your country or region, the current traffic situation is also considered in route calculations. The system receives traffic messages in the current reception area.

To receive the most up-to-date, real-time traffic information possible, subscribe to the Live services facility.

Notice

Only available with
NAVI 80 IntelliLink.

Functioning of the Navigation system

The position and movement of the vehicle are detected by the Navigation system using sensors.

The distance travelled is determined by the vehicle's speedometer signal, and turning movements on bends are determined by a gyro sensor. The position is determined by GPS (Global Positioning System) satellites.

By comparing these sensor signals with the digital maps on the Navigation system, it is possible to accurately determine the position of the vehicle.

When using the vehicle for the first time, or after a ferry trip, etc., the system will self-calibrate. It is, therefore, normal if it does not provide an exact location until the vehicle has travelled for some distance.

After the entry of the destination address or point of interest (nearest petrol station, hotel, etc.) the route is calculated from the current location to the selected destination.

Route guidance is provided by voice output and the display screen.

Warning

Areas such as one-way streets and pedestrian zones are not marked on the navigation system map. In such areas, the system may issue a warning that must be accepted. Therefore, pay particular attention to one-way streets and other roads and entrances that must not be driven into.

Notice

Depending on Infotainment system, radio reception may be interrupted during voice guidance and before each change of direction.

USB memory stick (NAVI 50 IntelliLink)

A USB memory stick is required for the Navigation system, to contain, among other things, a digital map of the towns and roads in your country.

Notice

Use a USB memory stick, formatted to FAT32 format, with a minimum 4 GB and maximum 32 GB of storage capacity.

After delivery of a new vehicle, there is a maximum of 90 days in which to update the digital map for free. After this time has elapsed, a fee is charged for map updates.

Notice

To avoid possible technical issues, only use a compatible USB memory stick for operating and updating the Navigation system. Do not insert USB memory stick in any other device (e.g. digital camera, mobile phone, etc.), or in another vehicle.

Software installation

To update the digital maps and to benefit from exclusive downloadable services, an account must be created on the vauxhall.naviextras.com website and the free software must be installed.

Creating an account

Create your internet account via the vauxhall.naviextras.com website. Select e.g., the "Register" option on the web page and enter the appropriate details.



Installing the software

Install the software on your computer by downloading from vauxhall.naviextras.com.

Follow the on-screen instructions to install the software and launch the online application.

Registering the Navigation system

The Navigation system must be registered with your new internet account.

Insert an empty USB memory stick in the Navigation system's USB slot. Touch  then select  NAVI /  Nav, followed by **Options** then **Map update**.

To ensure all content is saved in the Navigation system's memory, select **Options** then **Update**. Wait for the update to complete before ejecting the USB memory stick.

Then insert the USB memory stick in your computer's USB slot while connected to the Internet. When the online application is launched and the USB memory stick is recognised, the system (or software) name appears in the application window. The Navigation system is registered into your user profile.

After the initial set-up, the USB memory stick is automatically recognised by the Navigation system and by the online application.

Updating the USB memory stick and Navigation system

Updates are issued regularly, e.g. for map and safety camera revisions.

Notice

In certain countries it is illegal to download and activate the camera warning option and this could lead to prosecution.

These updates are only available via the online application catalogue, which is accessed via the USB memory stick.

Using the online application, it is possible to:

- update the Navigation system (maps, safety cameras etc.)
- upgrade to premium POI content
- add or delete data
- customise the system

The online application menus guide you through these operations.

System update

To get the best from the Navigation system, update it as often as possible.

Insert the USB memory stick in the Navigation system's USB slot. Available updates on the USB memory stick are recognised by the Navigation system and the 'Update' screen is displayed automatically.

Select **Update** to begin installing the updates to the Navigation system.

Notice

The Navigation system may restart automatically during the update process.

Notice

Touch ← to go back to the previous screen.

Alternatively, touch 🏠 followed by **NAVI / Nav**, **Options** then **Map update**. Then select **Options** followed by **Update** to install updates to the Navigation system.

Wait for the update to complete before performing any other operation or ejecting the USB memory stick.

SD card (NAVI 80 IntelliLink)

An SD card is supplied with the Navigation system and contains, among other things, a digital map of the towns and roads in your country.

After delivery of a new vehicle, there is a defined period in which to update the digital map for free. After this time has elapsed, a fee is charged for map

updates. Consult a workshop to purchase a new SD card with updated digital map.

Notice

To avoid possible technical issues, only use a compatible SD card for operating the Navigation system. Do not insert SD card in any other device (e.g. digital camera, mobile phone, etc.), or in another vehicle.

Usage

USB memory stick

NAVI 50 IntelliLink

Inserting the USB memory stick

Switch off the Navigation system and insert the USB memory stick in the USB slot on the Infotainment system fascia. The USB memory stick is fragile; treat it with care.

Removing the USB memory stick

Switch off the Navigation system and remove the USB memory stick from the USB slot on the Infotainment system fascia.

SD card

NAVI 80 IntelliLink

Inserting the SD card



Switch off the Infotainment system and insert the SD card in its slot located on the instrument panel. The SD card is fragile; do not bend it.

Ensure the SD card is inserted the correct way. The orientation may differ, depending on location of the SD card slot in the vehicle.

Removing the SD card

To remove SD card from the Infotainment system, on the Home page touch **MENU**, then **System**

followed by **Remove SD card**; The SD card can now be ejected safely from its slot located on the instrument panel.

To remove the SD card from its slot, press on the card then release it. The card is released slightly to enable it to be withdrawn.

Notice

To avoid possible technical issues, only use a compatible SD card for operating and updating the Navigation system. Do not insert SD card in any other device (e.g. digital camera, mobile phone, etc.), or in another vehicle.

Activating the Navigation system

Switching on

The Navigation system switches on automatically when the ignition is switched on. In other cases, press \odot .

With the ignition off, the Navigation system can be used for upto 20 minutes. Press \odot to switch on the Navigation system again. The system will automatically switch off upto 20 minutes after the last user input.



Switching off

With the ignition off, the Navigation system switches off automatically when the driver's door is opened.

With the ignition on, press  to switch off the Navigation system.

Switching between Navigation system and Infotainment system menus

NAVI 50 IntelliLink

With the Navigation system active, touch  or touch and hold / to return to the Infotainment system Home page.

NAVI 80 IntelliLink

With the Navigation system active, touch  (one or more times) to return to the Infotainment system Home page.

Information on the display

NAVI 50 IntelliLink (Type A) - Information on the display Menu screen

To access the Navigation menu screen, touch  followed by .



The Navigation menu screen contains the following menus and submenus:

- **Destination**

Refer to (NAVI 50 IntelliLink) "Destination input"  90.

- **Address**
- **Points of Interest**
- **History**
- **Favourites**
- **Find on Map**
- **Coordinate**

- **Route**

Refer to (NAVI 50 IntelliLink) "Route information" and "Edit



Itinerary" in the "Guidance" section  96.

- **Create Route/Edit Route**
- **Avoidances**
- **Overview**
- **Cancel Route**
- **Alternative Routes**
- **Itinerary**
- **Options**



Refer to (NAVI 50 IntelliLink) "Setting up the navigation system" below.

- **Warnings**
- **Route settings**
- **Map settings**
- **Voice settings**
- **Coordinate format**
- **GPS**
- **Map update**

Map screen





To access the map screen without route guidance, touch  followed by  **MAP**. Refer to (NAVI 50 IntelliLink) "Browse map" in the "Guidance" section  96.

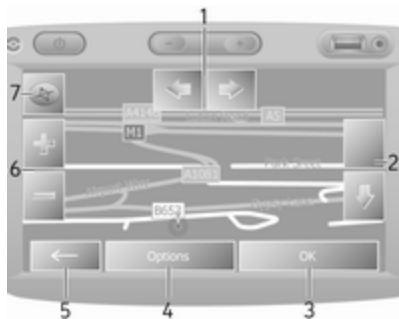

Touch anywhere on the map. The cursor indicates the current selected position. To scroll within the map, drag the cursor in the required direction.

To access the map screen with route guidance, touch  followed by  and enter a destination. Refer to (NAVI 50 IntelliLink) "Destination input"  90.

The map screen (with or without route guidance) contains the following controls and information:





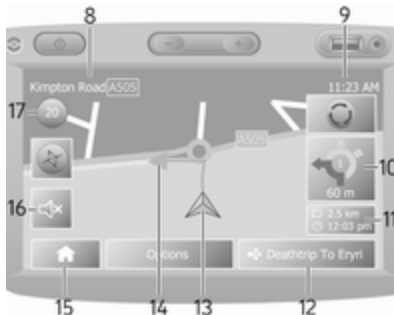

1.  : Rotate map left/right
2.  : Viewpoint (low/high view)

3. **OK** (with countdown timer): Confirm actions
4. **Options** menu
5. : Return to previous screen
6.  : Change scale (zoom in/out)
7. Compass (touch to switch between 2D/3D map modes)



8. Name of the next major road or road sign information, if applicable
9. Current time
10. Direction and distance to next change of direction

11. Journey information, e.g. estimated arrival time, total remaining distance
12. Audio system information
13. : Current location
14. Route calculated and direction changes
15. Home page
16.   : Voice guidance on/off
17. Speed limit

Intersection view

During route guidance, before each change of direction a close-up view of the intersection is automatically displayed. The normal view is resumed after passing the intersection.

Motorway view

During route guidance, before each motorway junction a 3D view of the junction is automatically displayed. The normal view is resumed after passing the junction.

Notice

For some motorway junctions, only a small turn arrow may appear on the map.

NAVI 50 IntelliLink (Type B) - Information on the display Menu screen

To access the Navigation menu screen, touch  followed by  Nav.

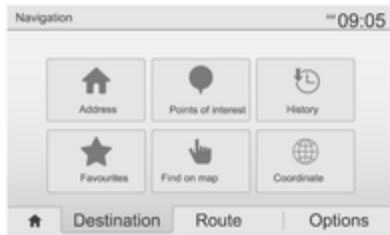



The Navigation menu screen contains the following menus and submenus:

- **Destination**
Refer to (NAVI 50 IntelliLink) "Destination input" ⇨ 90.
 - **Address**
 - **Points of interest**
 - **History**
 - **Favourites**



- **Find on map**
- **Coordinate**
- **Route**
Refer to (NAVI 50 IntelliLink) "Route information" and "Edit Itinerary" in the "Guidance" section ⇨ 96.
 - **Create Route/Edit Route**
 - **Avoidances**
 - **Overview**
 - **Cancel Route**
 - **Alternative routes**
 - **Route**
- **Options**
Refer to (NAVI 50 IntelliLink) "Setting up the navigation system" below.
 - **Warnings**
 - **Route settings**
 - **Map settings**
 - **Voice settings**
 - **Coordinate format**
 - **GPS**

- **Map Update**
- **Traffic**

Map screen

To access the map screen without route guidance, touch  followed by  Map (if available). Refer to (NAVI 50 IntelliLink) "Browse map" in the "Guidance" section ⇨ 96.

Touch anywhere on the map. The cursor indicates the current position. To scroll within the map, drag the map in the required direction. To return the cursor to the current vehicle position at any time, touch .

To access the map screen with route guidance, touch  followed by  Nav and enter a destination. Refer to (NAVI 50 IntelliLink) "Destination input" ⇨ 90.

Touch anywhere on the map. The cursor indicates the current position. To scroll within the map, drag the map in the required direction.

The map screen (with or without route guidance) contains the following controls and information:

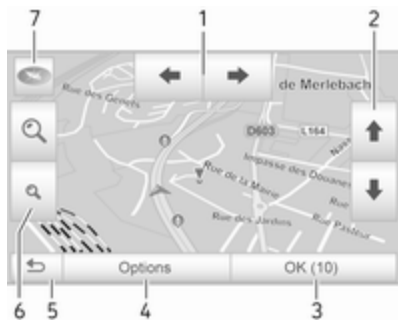

1. ←/→: Rotate map left/right
2. ↑/↓: Viewpoint (low/high view)
3. OK (with countdown timer): Confirm actions
4. **Options** menu (for route and map settings)
5. ↶: Return to previous screen
6. 🔍: Change scale (zoom in/out)
7. 🧭: Compass (touch to switch between '2D', '3D' and '2D North' map modes)



8. Name of the next major road or road sign information, if applicable
9. Current time
10. Direction and distance to next change of direction
11. Journey information, e.g. estimated arrival time, total remaining distance
12. Audio system information (touch to access audio source)
13. Route calculated and direction changes
14. ▲: Current location
15. Home page

16. 📡: Traffic information (TMC - Traffic Message Channel)

17. Speed limit



18. ⚙️: Settings pop-up menu (see items below)

19. 🔊/🔇: Voice guidance on/off

20. 🔍/🔍/🔍: Change scale (zoom in/out)

21. 🧭: Switch between '2D', '3D' and '2D North' map modes

Intersection view

During route guidance, before each change of direction a close-up view of the intersection is automatically

displayed. The normal view is resumed after passing the intersection.

Motorway view

During route guidance, before each motorway junction a 3D view of the junction is automatically displayed. The normal view is resumed after passing the junction.

Notice

For some motorway junctions, only a small turn arrow may appear on the map.

NAVI 80 IntelliLink - Information on the display Menu screen

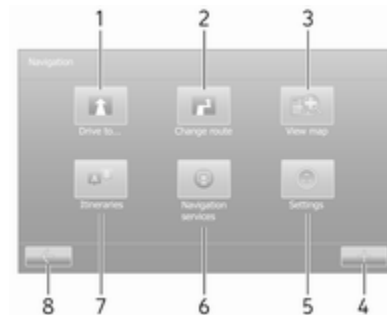

On the Home page, touch **MENU** followed by **Navigation** to access the Navigation menu.

The Navigation menu screen contains the following menus, submenus and controls:

1. DRIVE TO ...

Refer to (NAVI 80 IntelliLink) "Destination input" ⇨ 90.

- Home
- Saved locations
- Address
- Recent destinations
- Local search/TomTom places
- Point of Interest
- Point on map
- Latitude Longitude

2. CHANGE ROUTE

Refer to (NAVI 80 IntelliLink) "Edit Itinerary" in the "Guidance" section ⇨ 96.

- Calculate alternative
- Cancel route
- Travel via

- Avoid roadblock
- Avoid part of route
- Minimise delays

3. VIEW MAP

Refer to (NAVI 80 IntelliLink) "Browse map" in the "Guidance" section ⇨ 96.

- Use this location to...
- Find
- Change the map details
- Add to saved locations

4. +: Pop-up menu

5. SETTINGS

Refer to (NAVI 80 IntelliLink) "Setting up the navigation system" below.

- Turn off voice guidance
- Route planning
- Show POI on map
- Manage POIs
- Voice
- Set home location
- Manage saved locations
- Switch map

- Change map colours
- Car symbol
- Advanced

6. NAVIGATION SERVICES

Refer to (NAVI 80 IntelliLink) "LIVE services" below.

- Traffic
- Speed Cameras
- Local search/TomTom places
- My TomTom live
- Weather

7. ITINERARIES

Refer to (NAVI 80 IntelliLink) "Edit Itinerary" in the "Guidance" section ⇨ 96.

- 8. ←: Return to previous screen

Map screen

To access the map screen without navigation, on the Home page touch **MENU**, then **Navigation** followed by **View Map**.

Touch anywhere on the map. The cursor indicates the current selected position. To scroll within the map, drag the cursor in the required direction.

To access the map screen with navigation, on the Home page touch **MENU** followed by **Navigation** and enter a destination. Refer to (NAVI 80 IntelliLink) "Destination input" ⇨ 90.

The map screen (with or without route guidance) contains the following controls and information:

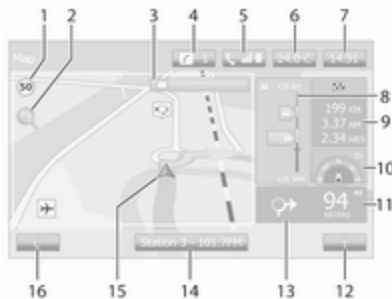

1. Speed limit (illuminates red and flashes if speed limit is exceeded)
2. ⌵: Change scale (zoom in/out)
3. Name of the next major road or road sign information, if applicable
4. ⚠: System notifications (if equipped)
5. 📞: Phone information
6. Outside temperature
7. Clock
8. Live services: Traffic information (if applicable), e.g. route incidents, reception indicator, traffic map, speed camera locations (if available) and weather at destination.
9. Journey information, e.g. estimated arrival time, total remaining distance, journey status (green flag/red flag)
Route summary
10. Compass (touch to switch between 2D/3D map modes)
11. Change volume of guidance instructions

12. **+**: Pop-up menu
13. Direction and distance to next change of direction
14. Audio system information
15. **A**: Current location (cursor)
Route calculated and direction changes
16. **←**: Return to previous screen

Lane images

During route guidance, before each major road change, a 3D view of the junction (with a turn arrow and road signs) is automatically displayed. The normal view is resumed after passing the junction.

To switch off the lane images view, refer to (NAVI 80 IntelliLink) "Advanced Settings" in "Setting up the navigation system" below.

Automatic zoom

During route guidance, before each change of direction a close-up view of the junction is automatically displayed. The normal view is resumed after passing the junction.

To switch off the automatic zoom feature, refer to (NAVI 80 IntelliLink) "Advanced Settings" in "Setting up the navigation system" below.

Operating keyboards in the display

NAVI 50 IntelliLink - Operating keyboards in the display

To move within and to enter characters in both the alphabetical and numerical keyboards, make the appropriate selection by touching the display screen.

- Select **Options** to change the keyboard type (e.g. Qwerty, ABC).
- Select **1^&** to switch to numbers and symbols.
- Select the drop down menu icon  to display a list of results for the current operation (e.g. destination input).

- Entries can be corrected during input with the  keyboard character.
- Touch **←** to stop using the keyboard and return to the previous screen.

Notice

When making an entry, certain letters and numbers are unavailable for selection (greyed-out) based on the information stored in the Navigation system.

For further information, refer to "Touchscreen operation" ⇨ 39.

NAVI 80 IntelliLink - Operating keyboards in the display

To move within and to enter characters in both the alphabetical and numerical keyboards, make the appropriate selection by touching the display screen.

- Entries can be corrected during input with the  keyboard character.
- Touch **←** to stop using the keyboard and return to the previous screen.

For further information, refer to "Touchscreen operation" ⇨ 39.

Live services

NAVI 80 IntelliLink - Live services

In addition to the free navigation services (e.g. traffic information, fixed speed cameras), extra features can be added by subscribing to paid LIVE services.

LIVE services include up-to-date traffic information with "HD Traffic™", updates and locations of fixed and mobile speed cameras, local search, weather forecast and the "My TomTom LIVE" subscription status.

Notice

LIVE services are not available in some countries or regions.

From the Home page, touch **MENU** then **Navigation**, followed by **Navigation Services**.

The following menus are displayed:

- **Traffic/HD Traffic**

Select to receive up-to-date, real-time traffic information.

Notice

The **HD Traffic** service is named **Traffic** if a subscription has not been activated.

- **Speed cameras**

Displays alerts and location of mobile speed cameras in real-time, fixed speed cameras and accident blackspots.

Switch function off via the "Speed Cameras" menu in "LIVE services", if required.

Report speed camera location, fixed or mobile.

Notice

In certain countries it is illegal to download and activate the camera warning option and this could lead to prosecution.

- **Local search/TomTom places**

This service allows you to use a keyword to quickly find any Point of Interest (POI) and set it as a destination.

- **My TomTom LIVE**



Displays expiry date of subscribed services.

- **Weather**

The weather forecast service provides up to five days of weather reports for your current location and your chosen destination.

Setting up the navigation system

NAVI 50 IntelliLink - Setting up the navigation system

Touch  followed by  **NAVI** /  **Nav** then **Options**. This menu screen allows you to check and update the following map and navigation settings:

- **Warnings**
- **Route settings**
- **Map settings**
- **Voice settings**
- **Coordinate format**
- **GPS**
- **Map update**
- **Traffic** (depending on version)

Warnings

Select **Warnings** to access the following settings (switch off if not required):

- **Warn when speeding** (On/Off)
- **Speed limit always visible** (On/Off)
- **Alert point warnings** (On/Off)
- **Pre-alert distance** (0 m/200 m/500 m)

Available depending on version.

Warn when speeding: The digital map contains speed limits for certain roads. Audio and/or visual warnings are given when the vehicle exceeds the speed limit.

Speed limit always visible: The speed limit for certain roads is always visible on the screen.

Alert point warnings: When the vehicle passes an alert point (permanent or temporary) - i.e. when entering a hazardous section of road requiring extra caution, or nearing a speed camera location (depending on country) - audio and visual warnings are given.

Pre-alert distance: Select a distance from which notifications of alert point warnings should be given.

Notice

Warnings may not be available for some roads and regions.

Route settings

Select **Route settings** to update the following settings for route calculation:

- **Route planning method** (Fast/Short/ECO)
- **Motorways** (On/Off)
- **Period charge** (On/Off)
- **Per-use toll** (On/Off)
- **Ferries** (On/Off)
- **Carpool/HOV** (On/Off)
- **Unpaved roads** (On/Off)
- **Permits needed** (On/Off) (depending on version)

If necessary, touch **Options** then **Reset to defaults** to set each of these options back to the factory default settings.

Alternatively, when the map is displayed (no route guidance is active), the **Route settings** menu can be accessed by touching **Options**.

Refer to (NAVI 50 IntelliLink) "Information on the display", "Map screen" above for further information.

Route planning method: Select **Fast** to set the fastest route to the destination entered. This method assumes the vehicle travels at or near the speed limit on all roads.

Select **Short** to set the shortest route and minimise the total distance to travel to the destination entered.

Select **Eco** to set a compromise between the fastest and the shortest route planning methods. The route provided may be shorter than the fastest method, but not significantly slower.

Motorways: To include or exclude motorways from the route plan.

Turn off, e.g. when towing a vehicle, or when motorway driving is not permitted.

Notice

Follow the regulations of the country in which you are driving.

Period charge: To include or exclude roads which require a special license to be purchased for certain periods.

Per-use toll: To include or exclude roads for which a toll must be paid to use the road once only.

Ferries: To include or exclude the use of ferries, ships and trains.

Carpool/HOV: To include or exclude carpool lanes and high-occupancy vehicle (HOV) lanes.

Unpaved roads: To include or exclude the use of unpaved roads, e.g. dirt, gravel roads.

Map settings

Select **Map settings** to access the following:

- **View mode** (3D/2D/2D North)
2D North is available depending on version.
- **Viewpoint** (Low/Normal/High)
- **Motorway view** (On/Off)
- **POI markers**



Alternatively, when the map is displayed (no route guidance is active), the **Map settings** menu can be accessed by touching **Options**.

Refer to (NAVI 50 IntelliLink "Information on the display", "Map screen" above for further information.

View mode: Select **View mode** to change the default map mode between a 2D top-down view, a 3D perspective view and a 2D view with North always facing upwards.

Alternatively, touch the Compass on the map to switch between map view modes.

Viewpoint: Select **Viewpoint** to raise or lower the map view.

Alternatively, when the map is displayed (no route guidance is active), touch / to raise or lower the map view. They are greyed-out when the maximum position is reached.

Motorway view: Select **Motorway view** to switch on/off the motorway junction view for route guidance.

Refer to (NAVI 50 IntelliLink "Information on the display", "Map screen" above for further information.

POI markers: Select  alongside **POI markers** to display a list of Points of Interest (POI) types.

Use this screen to switch on/off (show or hide on map) certain POI type markers on the map, e.g. accommodation, airport, café or bar.



Select a POI type to open a list of its subcategories and switch on/off (show or hide) individual subcategories.

Notice

POIs are only visible on the map depending on the zoom level.

Voice settings

Select **Voice Settings** to change voice guidance language.

Scroll the list of languages by touching / then select a language and touch **OK** to confirm selection.

Coordinate format

Select **Coordinate format** to change the format of co-ordinate entries to one of the following options:

- DD.DDDDD
- DD MM.MMM
- DD MM SS.S

GPS

Select **GPS** to view the GPS information, e.g. available satellites, their location and signal strength.

Map update

Select **Map update** to display the following digital map content and latest update information:

- **Alert Points**
- **Junction View**
- **Maps**
- **Places**
- **Traffic Service**
- **Address Points**

Specific content or all map content can be updated. Select one of the options first or touch **Options** then **Update**. Wait for the update to complete.

Refer to "USB memory stick" (NAVI 50 IntelliLink), "Updating the USB memory stick and Navigation system" in the "General information" section ⇨ 75.

Traffic

Select **Traffic** to change the following traffic information settings:

- **Traffic info** (On/Off)
- **Detour**
- **Event types**

Traffic info: Warnings are given for incidents that occur along the route.

Detour: Save time by using an alternative route when a traffic jam or an incident occurs along the current route. Select 'On'/'Off' alongside "Confirm offered route?" as required.

If necessary, update the time value for the option "Offer detour if the calculated route saves more than:" (e.g. five minutes) by touching ◀/▶.

Event types: Select the type of events to be displayed during route guidance, e.g. all events, traffic flow events, closures and blockages, accidents.

NAVI 80 IntelliLink - Setting up the navigation system

To access the Navigation settings menu from the Home page, touch **MENU** then **Navigation**, followed by **Settings**. The following settings submenus are displayed:

- **Turn off voice guidance:**
Switch on/off voice guidance during navigation.
- **Route planning:**
Settings for route type, toll roads, ferries, route summary, carpool lanes and unpaved roads.
Select a planning preference type; "Fastest route" is recommended. The eco-route is designed to save the most fuel.
Then switch on/off "iQ routes™" as required. iQ routes™ enables routes to be calculated according to average traffic levels during a particular day and time, and also the best route according to actual traffic speeds.
- **Show POI on map:**
Show or hide categories of POI markers on the map.

- **Manage POIs:**

Add, change or delete POIs or POI categories.

- **Voice** (depending on version):

Select synthesised voice or a male or female human voice (for the voice instructions) from the available list.

Human voices provide more simplified voice guidance instructions and are not available when using the Voice recognition function ⇨ 104.

- **Set home location:**

Change the home or most used destination address.

- **Manage saved locations:**

Delete or rename saved destination addresses.

To rename, select an address from the displayed list, select **Rename** then enter a new name. Touch **Done** to confirm. To delete a selected address, touch **Delete** and confirm when prompted.

- **Switch map:**

If more than one map is installed on the SD card, use this option to switch between the saved maps. Select "Change map" then choose the desired map from the options available.

- **Change map colours:**

Change day and night colours used on Navigation map

For downloaded new colours; choose a new colour, select additional colour scheme, then choose the desired colour from the options available.

- **Car symbol:**

Change the vehicle icon used on the 3D navigation map.

- **Advanced:**

Select from the following advanced options:

- **Map information:**

Show/hide information displayed on the map, e.g. address number before street name, street names/

current street name, name of street after current street.

- **Map behaviour:**

Change how the map operates with the following options:

Show lane images (e.g. at motorway junctions), rotate map with vehicle direction (2D mode only), switch to 3D mode automatically during guidance, zoom automatically (2D mode, 3D mode).



- **Traffic source:**

Choose a traffic information source from the available list.

Destination input

NAVI 50 IntelliLink - Destination input

Select a destination

Touch  followed by  **NAVI** /  **Nav** then **Destination**.

The following menu options are available for entering a destination:

- **Address**
Enter an address using the keyboard.
- **Points of Interest**
Select Points of Interest (POI), e.g. petrol station, restaurant, parking.
- **History**
Select from a list of previous destinations.
- **Favourites**
Select from a saved list of favourite destinations.
- **Find on map**
Select a destination by using the digital map.
- **Coordinate**
Enter the co-ordinates of the destination.

After a destination has been entered, wait for the ten second countdown to expire or touch **OK** to begin route guidance immediately.

Enter an address

Select **Address** and enter part or all of an address, e.g.:

- **Country**
- **Town or Postcode**
- **Street**
- **Number**
- **Intersecting street**

Notice

Full addresses can only be entered if they are recognised by the Navigation system.

When entering an address for the first time, touch **Country**, then use the keyboard to enter the name of the country required. Alternatively, use the drop down menu icon  and select from a list of suggested countries.

Notice

When entering an address, certain letters and numbers are unavailable for selection (greyed-out) based on the addresses recognised by the Navigation system.

Proceed in the same way to enter details for **Town or Postcode**, **Street**, **Number** and **Intersecting street**.

Notice

When entering a **Postcode**, insert a space after the first part of the postcode.

The address is automatically stored in the memory, available for future selection.

For keyboard operation, refer to (NAVI 50 IntelliLink) "Operating keyboards in the display" in the "Usage" section ↻ 78.

Notice

Number and **Intersecting Street** are only available after a **Street** has been entered.

When entering a **Street**, it is not necessary to specify the type of road (street, avenue, boulevard etc.).

Select Points of Interest (POI)

POIs can be selected as a destination using the following search options:

- preset POI list
- POI categories
- quick search for POIs via the map

Preset POI list

Select **Points of Interest** to choose from the frequently-used preset categories list (e.g. petrol station, parking, restaurant).

POI categories

Select **Points of Interest** followed by **Custom Search** to select from the list of categories and subcategories.

The search for POIs differs depending on the current situation:

- If route guidance is active, **Petrol station** and **Restaurant** POIs are searched for along the route, and **Parking** POIs are searched for around the destination.
- If there is no active route guidance, POIs are searched for around the current position.
- If the current position is not available (i.e. no GPS signal), POIs are searched for around the last known position.

The following options are available:

- **In a Town**

To search for a POI within a selected town (the resulting list is

ordered by distance from the town centre).

- **Along Route**

To search for a POI along the current route (the resulting list is ordered by length of the required detour).

- **Around My Position**

To search for a POI around the current position (the resulting list is ordered by distance from this position).

- **Around Destination**

To search for a POI around the destination of the current route (the resulting list is ordered by distance from the destination).

When a list of POIs is displayed, they can be sorted or displayed on the map. Touch **Options** to display the following:

- **Sort by name**
- **Sort by distance**
- **Sort by detour** (if route guidance is active)
- **Show all on map**

Quick search for POIs

Touch anywhere on the map. The cursor indicates the current selected position. To scroll within the map, drag the cursor in the required direction.

Touch **Options** followed by **Points of Interest Around Cursor** to show nearby POI names and their distance from the selected position on the map.

Alternatively, touch **Find** and use the keyboard to search for a destination by name.

Select from previous destinations list

Select **History** to access a list of previously entered destinations.

To sort the list, touch **Options** to display the following:

- **Sort by name**
- **Sort by distance**
- **Delete all**

Alternatively, touch **Find** and use the keyboard to search for a destination by name.

Select from Favourites list

Select **Favourites** to access a list of saved favourite destinations.

When the list of favourites is displayed, they can be sorted or displayed on the map. Touch **Options** to display the following:

- **Sort by name**
- **Sort by distance**
- **Show all on map**
- **Delete all**

Alternatively, touch **Find** and use the keyboard to search for a favourite by name.

Select a destination by using the map

Select **Find on Map** to begin a search for a destination by scrolling the map.

Touch anywhere on the map. The cursor indicates the current selected position. To scroll within the map, drag the cursor in the required direction.

Touch **OK** to select the position as a destination.

Enter the co-ordinates of the destination

Select **Coordinate** to begin a search for a destination by entering its co-ordinates.

To change the format of the co-ordinates, touch **Options** and select from the following:

- **Latitude/Longitude**

Values can be entered in any of the following formats:

- decimal degrees
- degrees and decimal minutes
- degrees, minutes and decimal seconds
- **UTM** (Universal Transverse Mercator)

Confirm the destination

When a destination has been selected, the route appears on the map. Touch **OK** and set as a **New route**.

If route guidance is active, the destination can be set as a **Waypoint** along the route.

Add and save a favourite

When a destination has been selected, touch **Options** to display the following:

- **Add to Favourites:** Save the destination in the favourites list.
- **Current traffic:** Provides information on traffic incidents (depending on version).
Refer to (NAVI 50 IntelliLink) "Traffic information" in the "Guidance" section ↻ 96.
- **Info/News:** Displays information (e.g. address) for the selected POI.
Shows the location (address) of the position selected, provides the GPS coordinates (latitude/longitude) and also, if applicable, displays the phone number of a selected POI.
- **Back to car:** Return to current vehicle location.

Before saving a favourite, the name of the favourite can be changed by using the keyboard.

For keyboard operation, refer to (NAVI 50 IntelliLink) "Operating keyboards in the display" in the "Usage" section ↷ 78.

Delete a favourite

When a favourite has been selected, touch **Options** before starting route guidance followed by **Delete Favourite** and confirm deletion.

To delete all favourite destinations, select the menu **Destination Favourites** followed by **Options** then **Delete all** and confirm deletion.

NAVI 80 IntelliLink - Destination input

Select a destination

From the Home page, touch **MENU** then **Navigation** followed by **Drive to....**

Select a destination from the following options on the display:

- Home
- Saved locations
- Address
- Recent destinations

- Local search/TomTom places
- Point of Interest
- Point on Map
- Latitude Longitude

Home

Guides you to your home address.

To store the address of your home location, from the Home page, touch **MENU** then **Navigation**, followed by **Settings**.

Select **Set home location** and enter an address.

Refer to (NAVI 80 IntelliLink) "Setting up the navigation system" in the "Usage" section ↷ 78.

Saved locations

Select from a list of previously saved destinations.

To delete or rename saved destinations, from the Home page, touch **MENU** then **Navigation**, followed by **Settings**.

Then select **Manage saved locations** and update the selected destination as required.

Refer to (NAVI 80 IntelliLink) "Setting up the navigation system" in the "Usage" section ↷ 78.

Address

Enter part or all of an address using the keyboard, e.g.:

- Country
- Postcode
- Town/City
- Street
- House number

Notice

Full addresses can only be entered if they are recognised by the Navigation system.

When entering an address for the first time, the country of the destination will be requested. Use the keyboard to enter the name of the country required.

Suggestions may be shown on the display during input. Touch to select a destination shown in the display, or touch **List** to access the full list for the current part of the address.

Notice

When entering an address, certain letters and numbers are unavailable for selection (greyed-out) based on the addresses recognised by the Navigation system.

Proceed in the same way to enter a **Postcode** or enter details for **Town/City, Street and Number**.

Notice

When entering a **Postcode**, insert a space after the first part of the postcode.

The address is automatically stored in the memory, available for future selection.

For keyboard operation, refer to (NAVI 80 IntelliLink) "Operating keyboards in the display" in the "Usage" section ⇨ 78.

Recent destinations

Select from a list of previous destinations that have been automatically stored.

Local search/TomTom places

Select a nearby Point of Interest (POI) by entering key words using the keyboard.

Notice

This feature is only available by subscribing to paid LIVE services.

For further information, refer to (NAVI 80 IntelliLink) "LIVE services" in the "Usage" section ⇨ 78.

Point of Interest

POIs can be selected as a destination using the following search options:

- **POI categories:**
Select a POI category type (e.g. petrol station, restaurant, parking), then select a search area (e.g. **POI nearby, POI in town, POI at home**).
Enter a town/city name and touch **Done** to confirm selection.
- **POI names:**
Enter name of a POI and select to begin a search.

Point on Map

Select a destination by using the digital map.

To scroll within the map, drag the cursor in the required direction, then confirm the position as a destination.

Latitude Longitude

Enter the co-ordinates of the destination.

Confirm the destination

When a destination has been selected, the route appears on the map and a route summary is provided in the  tab.

Select the LIVE tab to view real-time traffic information. For further information, refer to (NAVI 80 IntelliLink) "LIVE services" in the "Usage" section ⇨ 78.

Touch **Done** to confirm the route.

Add and save a favourite**Add to saved locations**

From the Home page, touch **MENU** then **Navigation** followed by **Drive to...**

Select **Recent destinations** and choose a destination from the displayed list.

Touch **+** (to open a pop-up menu) then **Add to saved locations**, give a name to the destination using the keyboard, then touch **Next**.

A message is displayed asking if the saved address should be set as the Home address. Select **Yes** or **No**. A message is displayed confirming that the address has been saved.

Add Favourite

On the Home page, touch ★ to open the favourites menu and select **Navigation**.

To set a saved destination as a favourite, touch + (to open a pop-up menu), then **Add Favourite**.

Choose from the displayed list to add a saved destination to the favourites.

For further information, refer to (NAVI 80 IntelliLink) "Favourites" in the "Introduction" section ⇨ 30.

Delete a favourite

On the Home page, touch ★ to open the favourites menu and select **Navigation**.

Touch + and select **Remove all Favourites** or select a favourite from the displayed list then select **Remove a Favourite**. A confirmation message is displayed. Touch **Delete** to confirm.

For further information, refer to (NAVI 80 IntelliLink) "Favourites" in the "Introduction" section ⇨ 30.

Guidance

Route information

NAVI 50 IntelliLink - Route information

To view the route before guidance begins, touch 🏠 followed by **NAVI / ↑Nav** then **Route** after a destination has been entered.

For the various methods of entering a destination, refer to (NAVI 50 IntelliLink) "Destination input" ⇨ 90.

The following options are available:

- **Create Route/Edit Route**
Refer to (NAVI 50 IntelliLink) "Edit Itinerary" below.
- **Avoidances**
Refer to (NAVI 50 IntelliLink) "Edit Itinerary" below.
- **Overview**
See below.

- **Cancel Route**

Refer to (NAVI 50 IntelliLink) "Deactivating guidance" below.

- **Alternative Routes**

Refer to (NAVI 50 IntelliLink) "Edit Itinerary" below.

- **Itinerary**

Refer to (NAVI 50 IntelliLink) "Edit Itinerary" below.

Overview

When the **Route** screen is displayed, touch **Overview** to get a detailed plan for the current route and a bird's eye view of the route on the map.

This menu option contains the following information:

- name and/or address of the destination
- total time of the route
- total distance of the route
- special points and sections of the route (e.g. toll roads, motorways, etc.)
- alternative routes (e.g. Short, Fast, Economical)

When the **Overview** screen is displayed, touch **Options** to access the following submenus:

- **Alternative routes**

Refer to (NAVI 50 IntelliLink) "Edit Itinerary" below.

- **Itinerary**

Refer to (NAVI 50 IntelliLink) "Edit Itinerary" below.

- **Route settings**

Refer to (NAVI 50 IntelliLink) "Setting up the Navigation system" ⇨ 78.

- **Simulate navigation**

See below.

Notice

These options can also be accessed during route guidance by touching on the 'Journey information' (e.g. estimated arrival time, total remaining distance) area of the display screen.

Refer to (NAVI 50 IntelliLink) "Information on the display" in the "Usage" section ⇨ 78.

Simulate navigation

This function enables you to see a rapid view of the suggested route.

The following options are available:

- ▶/|| : Start or pause the route simulation
- ⏪ : Move to previous manoeuvre
- ⏩ : Move to next manoeuvre
- 1x / 4x / 8x : Increase the speed of the route simulation
- ←/↶ : Return to previous screen

NAVI 80 IntelliLink - Route information

To view the route before guidance begins, touch **+** (to open a pop-up menu), then select **Route details** after a destination has been entered.

The following options are available:

- **Display instructions:**

Displays the route plan.

The following details are shown:

- direction change arrows
- road types

- road names
 - distance before a fork in the road (km/miles)
- **Display route map:**
View a map of the route.
 - **Display route demo:**
View a demonstration of the route.
 - **Route summary:**
Return to the previous screen.
The details of the journey time, distance and the type of journey are displayed. Refer to (NAVI 80 IntelliLink) "IQ routes™" in the "Destination input" section ⇨ 90.
 - **Display destination:**
View changes in direction as images.
 - **Display traffic on route:**
Displays an overview of all traffic incidents affecting the current journey, with a detailed incident by incident view.
With a subscription to LIVE services, the "Live" tab provides

a more detailed overview of the journey (e.g. traffic delays, fixed and mobile speed cameras).

For further information, refer to (NAVI 80 IntelliLink) "LIVE services" in the "Usage" section ⇨ 78.

Edit itinerary

NAVI 50 IntelliLink - Edit Itinerary

This function makes it possible to view and change the route plan to the destination entered.

To access at any time, touch  followed by  **NAVI** /  **Nav** then **Route**. Select **Itinerary**.

The following information will appear:

- direction change arrows
- road number
- distance before a direction change

Touch **Options** to change and sort the details of the route.

The following options are available:

- **Summary**

Shows each waypoint and the destination, including the waypoint distance, time left to next waypoint and arrival time.

- **Normal**

Shows each manoeuvre, with street or place names, distance, and route section numbers.

This option also shows signpost information, access and manoeuvre restrictions, warnings and system preference information.

- **Road list**

Shows only the main sections of the route using road names/ numbers.



This option also shows the length of each section, time left to next section, arrival time and average direction.

Alternatively, these itinerary/route options can be changed by touching the "Direction and distance to next change of direction" tab on the display





during route guidance. Select **Options** to change and sort the details of the route.

Refer to (NAVI 50 IntelliLink) "Information on the display", "Map screen" in the Usage section ⇨ 78.

Edit route

To edit the route by modifying the list of waypoints, touch  followed by  **NAVI** /  **Nav**, **Route** then **Edit Route** on the display screen.



The following options are available:

- Top  : Add waypoint
- Bottom  : Add new destination
-  : Delete destination
-  : Change the route departure address (available depending on version)

To change the order of the waypoints in the list, touch **Options** followed by **Re-order** then move the waypoints up/down.

For the various methods of entering a destination, refer to (NAVI 50 IntelliLink) "Destination input" ⇨ 90.

Avoidances

To edit the route by avoiding particular sections, touch  followed by  **NAVI** /  **Nav, Route** then

Avoidances.

Select a section from the list on the display screen to be avoided. The avoided section is highlighted in red.

Confirm the new route by touching **OK**.

Alternative routes

To change the route planning method, touch  followed by  **NAVI** /  **Nav, Route** then **Alternative routes**.

The following options are available, each with a distance and estimated time:

- fast
- short
- eco

Select one of the options and confirm the new route by touching .

For further information, refer to (NAVI 50 IntelliLink) "Setting up the navigation system" in the "Usage" section ⇨ 78.

NAVI 80 IntelliLink - Edit Itinerary

Journeys can be planned in advance by selecting both the starting point and the destination.

From the Home page, touch **MENU** then **Navigation**, followed by **Itineraries**.

Select a point of departure in the same way as entering a destination. Refer to (NAVI 80 IntelliLink) "Destination input" ⇨ 90. Then select a destination, choose the type of route and confirm.

The system plans the route and allows you to view the details.

Change route

To change the route during active route guidance, from the Home page, touch **MENU** then **Navigation**, followed by **Change route**.

The following options are available:

- **Calculate alternative**
- **Cancel route**
- **Travel via**
- **Avoid roadblock**
- **Avoid part of route**
- **Minimise delays**

Calculate alternative

Select to calculate an alternative route to the destination.

Cancel route

Select to stop the current route guidance.

To restart guidance, touch **Drive to...** followed by **Recent destinations** and select the route again.

Travel via (waypoints)

Select to change the calculated route to your destination so that it includes a particular location (waypoint).

The location to be included is entered the same way as entering a destination.

Select from the same list of options, e.g. "Address", "Saved locations", "Point of Interest", "Point on map".

Refer to (NAVI 80 IntelliLink) "Destination input" ⇨ 90.

Avoid roadblock

Select this option in the event a roadblock is not currently indicated by the Traffic information service.

Refer to (NAVI 80 IntelliLink) "Traffic information" below.

Choose the distance (in metres) of the route ahead to be avoided, e.g. "100m", "500m", "2000m", "5000m".

The route is recalculated to avoid a section of the route for the distance selected.

Avoid part of route



Select to avoid a part of the route. Choose the road to be avoided from the list of roads along the route.

Minimise delays

Select to plan the route based on the latest traffic information.

Deactivating guidance

NAVI 50 IntelliLink - Deactivating guidance

To stop route guidance when in progress, touch  followed by  **NAVI** /  **Nav, Route** then **Cancel Route**.

NAVI 80 IntelliLink - Deactivating guidance

To stop guidance when in progress, touch  followed by **Delete route**.

Browse map

NAVI 50 IntelliLink - Browse map

To access the map screen at any time, touch  followed by  **MAP**.

Touch anywhere on the map. The cursor indicates the current selected position. To scroll within the map, drag the cursor in the required direction.

For further control operations, refer to (NAVI 50 IntelliLink) "Map screen" in the "Usage" section ⇨ 78.

Options menu

When the map screen is displayed, touch **Options** to display the following:

- **Route settings:**

Refer to (NAVI 50 IntelliLink) "Setting up the navigation system" in the "Usage" section ⇨ 78.

- **Map settings:**

Refer to (NAVI 50 IntelliLink) "Setting up the navigation

system" in the "Usage" section ⇨ 78.

- **Where am I?:**

Refer to (NAVI 50 IntelliLink) "HELP!" below.

NAVI 80 IntelliLink - Browse map

To access the map screen without navigation, on the Home page touch **MENU**, then **Navigation** followed by **View Map**.

Touch anywhere on the map. The cursor indicates the current selected position. To scroll within the map, drag the cursor in the required direction.

When the map screen is displayed, touch  to open a pop-up menu containing the following options:

- **Use this location to...**
- **Find**
- **Change the map details**
- **Add to saved locations**

Use this location to...

Select this option to perform any of the following actions:

- centre the map on the vehicle's location
- navigate to a point on the map
- search for a point on the map
- add a point on the map to the favourites
- add a point on the map to the POI list
- correct the position of your vehicle

Find

Select this option to centre the map on:

- your home
- a saved address
- an address
- a recent destination
- a local search
- a point of interest
- current vehicle position
- a co-ordinate (latitude/longitude)

Change the map details

Select this option to switch on/off the following map settings:

- traffic
- names
- points of interest (POI)
- satellite image map background
- GPS co-ordinates

Add to saved locations

Select this option to add the current position on the map as a saved destination. Use the keyboard to enter a name or confirm the suggested name.

For keyboard operation, refer to (NAVI 80 IntelliLink) "**Operating keyboards in the display**" in the "**Usage**" section ⇨ 78.

Help!**NAVI 50 IntelliLink - Help!**

When the map screen is displayed, touch **Options** followed by **Where am I?** to check helpful information about the current location and to search for Points of Interest (POI) nearby.

To access the map screen at any time, touch  followed by  **MAP**.

Where am I?

This menu option contains the following information:

- current location (address)
- latitude
- longitude
- altitude
- GPS status

Touch **Options** to display the following options:

- **Add to favourites**

Refer to (NAVI 50 IntelliLink) "Destination input", "Add and save a favourite" for further information ⇨ 90.

- **Country information:** Refer to "Country information" below.

Country information

This function allows you to check country information and legislation for the current location.

When the **Where am I?** screen is displayed, touch **Options** followed by **Country information**.

This menu option contains the following information:

- speed limits
- phone country code (International dialling code, e.g. +49)
- emergency number (e.g. 112)
- legal restrictions, e.g.:
 - vehicle equipment requirements, e.g. warning triangle, first aid kit, fire extinguisher, spare bulbs, high-visibility jacket etc.
 - headlights legislation
 - maximum blood alcohol level
 - snow chains legislation
 - winter tyres legislation

Help Nearby

This function allows you to search for assistance near your current location.

When the **Where am I?** screen is displayed, touch **Help Nearby**.

This menu option contains the following information:

- **Car repair around here** (Vehicle repair services)
- **Health around here** (Medical and emergency services)
- **Police around here** (Police stations)
- **Petrol station around here** (Fuel stations)

Select the appropriate option to access a list of local Points of Interest (POI).

For information on Points of Interest (POI), refer to (NAVI 50 IntelliLink) "Destination input" ⇨ 90.

Traffic information





NAVI 50 IntelliLink - Traffic information

Available depending on version, up-to-date traffic information from local sources can be received. Information is provided for the current route or for the current vehicle location.

During route guidance, touch **Options** then select **Current traffic**, or touch the traffic icon  on the map screen. Traffic incidents along the route and estimated delay times are displayed.

The following options are available:

- **Event list:** Select to change event display settings.
- **Offer detour:** Create an alternative route to the selected destination.
- **Options:** Access traffic options.

To access these traffic options at any time, touch  followed by  **NAVI** /  **Nav** then **Options**. Then select  **Traffic**.

Touch  to return to route guidance.

NAVI 80 IntelliLink - Traffic information

Allows up-to-date traffic information from local sources to be received.

From the Home page, touch **MENU** then **Navigation**, followed by **Navigation Services**. Then select **Traffic/HD Traffic**.

The navigation system indicates traffic incidents with voice messages, the traffic information bar and also by displaying symbols on the map.

Refer to "Symbols overview" ⇨ 103.

The system receives updates approx. every 15 minutes and traffic incidents are shown for major roads only.

The **Traffic** service is named **HD Traffic** if a subscription to LIVE services has been activated. With **HD Traffic**, updates are received approx. every three minutes and traffic incidents are shown for minor roads also.

For further information, refer to (NAVI 80 IntelliLink) "LIVE services" in the "Usage" section ⇨ 78.

Depending on the current traffic situation, the traffic information bar can include the following information:

- heavy delays on the route (given in minutes)
- unknown or indeterminate situation (grey)
- slow traffic (orange)
- traffic jam (red)

- stationary traffic or road closed (dark red)
- distance before next incident (in km/miles)











To manage the Traffic information service, select from the following options:

- **Minimise delays**
Alter journey based on the latest traffic information.
- **Show traffic on route**
Displays an overview of all traffic incidents on the current route. Touch incident icons for more detailed information.
- **View map**
Select to explore the map and stay up-to-date with the traffic situation in the area.
The map displays the last searched location. Touch incident icons for more detailed information.
- **Read aloud traffic info**
Activates voice guidance for traffic information.

Traffic service settings

Select **Traffic Settings** and tick the box alongside the required preferences (e.g. automatically minimise delays after every traffic update) and select **Done** to confirm.

Symbols overview

-  : Accident
-  : Traffic jam
-  : One or more lanes closed
-  : Road closed
-  : Traffic incident
-  : Road works
-  : Heavy rain
-  : Snow
-  : Strong wind, storm
-  : Fog
-  : Ice

Voice recognition

General information 104
Navigation control 105
Phone control 106

General information

The voice recognition function allows you to operate certain functions via voice input.



To ensure that conversations held inside the vehicle do not start unintentional calls to a saved contact, the voice recognition function must first be activated via  on the steering wheel/column controls.

Control elements overview ⇨ 6.

NAVI 50 IntelliLink

Available depending on version, the voice recognition function of the handsfree phone system allows you to operate certain functions of a compatible smartphone via voice input.

Refer to "Phone control" in this section ⇨ 106.

To confirm that a paired and connected smartphone is compatible with the voice recognition function, touch  followed by  **Setting(s)**.

Then select **Bluetooth** followed by **View Bluetooth device list**. The list shows the paired devices and  appears alongside the name of the smartphone to indicate compatibility.

Notice

If supported, the language set on your smartphone will automatically be used by the Infotainment system for voice recognition.

The navigation system can also be operated using voice controls. Refer to "Navigation control" in this section ⇨ 105.

Prerequisites



The following prerequisites must be met:



- The Bluetooth function of the Infotainment system must be activated.
Refer to "Bluetooth connection" in the "Phone" section ⇨ 111.
- The Bluetooth function of the Bluetooth-enabled smartphone must be activated and the smartphone must have a 3G, 4G

or wi-fi connection (see smartphone operating instructions).

- Dependent upon the smartphone, it may be required to set the device to "visible" (see smartphone operating instructions).
- The smartphone must be paired and connected to the Infotainment system.

Help

For information and help with activating and operating voice controls, touch  followed by  **Setting(s)** then **Bluetooth**.

Select **Smartphone** from the list (use / to search list), then select  to access help.

A series of screens are displayed, explaining how to use the voice recognition function and information on the following:

- switching on/off with steering wheel/column controls
- compatible phones
- operation methods

- available functions and descriptions
- conditions of use

NAVI 80 IntelliLink

The voice recognition function allows you to operate certain functions via voice input, including:

- **Navigation**
Refer to "Navigation control" in this section ⇨ 105.
- **Phone**
Refer to "Phone control" in this section ⇨ 106.

Press  on the steering wheel/column controls to open the **Voice control** main menu. After the tone, say the name of the menu you wish to access.

When activated, the **Voice control** main menu is displayed and the voice recognition indicator in the top right corner indicates system status and optimisation levels:

Green : optimal voice recognition
Orange : good voice recognition
Red : average voice recognition

Microphone  : System is ready to receive a voice command

Loudspeaker  : Voice instructions are currently being given by the system



Loading icon  : Data currently loading

Navigation control

NAVI 50 IntelliLink

Activating voice recognition

To activate the voice recognition function during navigation:

Press  on the steering wheel/column controls;  appears, alongside the audio system information, in the bottom right corner of the display.

Notice

During use of the voice recognition function, audio source playback is interrupted.

For a guide to using voice commands, refer to (NAVI 50 IntelliLink) "Help" in the "General information" section ⇨ 104.

NAVI 80 IntelliLink

Activating voice recognition

To activate the voice recognition function:

Press **3** on the steering wheel/column controls to open the **Voice control** main menu.

After the tone, say "**Destination**" to enter a new address. Say "**Address**" then say the full destination of a new address (number, street name, destination town/city).

The address recognised by the system is displayed. Confirm destination when prompted to begin guidance.

Alternatively, after the tone say "**Recent destinations**" to access a list of the most recent destinations entered and select the desired destination.

Notice

A compatible SD card must be inserted for the Voice recognition to operate the Navigation system.

For further information, refer to (NAVI 80 IntelliLink) "Destination input" in the "Navigation" section ⇨ 90.

Phone control

NAVI 50 IntelliLink

Activating voice recognition

To activate the voice recognition function:

Press **3** on the steering wheel/column controls to open the **Smartphone** menu; a beep sounds and **3** appears on the display, indicating activation.

To use voice recognition, touch **3** on the display (or press **3**).

Notice

During operation of the voice recognition function, **Radio** and **Media** functions are not available for use.

To deactivate, touch and hold **3** on the display (or press **3**).

For a guide to using voice commands, refer to (NAVI 50 IntelliLink) "Help" in the "General information" section ⇨ 104.

NAVI 80 IntelliLink

Activating voice recognition

To activate the voice recognition function:

Press **3** on the steering wheel/column controls to open the **Voice control** main menu.

After the tone, say "**Phone**" to access the Phone menu. Say the name of a saved contact or a telephone number. The desired contact appears in the display when registered by the system.

Say "**Call**" to start the dialling process.

Say "**Delete**" to cancel input and retry.

Alternatively, to initiate a call directly from the **Voice control** main menu, touch **3** and say the name of a saved contact or a telephone number.

Phone

General information	107
Connection	109
Bluetooth connection	111
Emergency call	114
Operation	115
Mobile phones and CB radio equipment	122

General information

The handsfree phone system provides you with the possibility of having mobile phone conversations via the vehicle's microphone and loudspeakers, as well as operating the most important mobile phone functions via the Infotainment system.

To be able to use the handsfree phone system, the mobile phone must be connected with it via **Bluetooth**.

Not all handsfree phone system functions are supported by every mobile phone. The possible phone functions depend on the relevant mobile phone and network provider. Refer to the operating instructions for your mobile phone or consult your network provider.

Important information for operation and traffic safety

Warning

Use of the handsfree phone system while driving can be dangerous as your concentration is reduced when telephoning. Park the vehicle before using the handsfree phone system.

Follow the regulations of the country in which you are driving.

Also follow the special regulations that apply in specific areas and always switch off the mobile phone if the use of mobile phones is prohibited, if interference is caused by the mobile phone or if dangerous situations can occur.

Warning

Mobile phones have effects on your environment. For this reason, safety regulations have been

prepared which you should make yourself familiar with before you use the telephone.





Bluetooth

The Phone portal is certified by the Bluetooth Special Interest Group (SIG).



You will find further information about the specification on the Internet at <http://www.bluetooth.com>

Phone controls

Controls on Infotainment system or steering column:

-  **TEL**
- or -
- **TEL**
- or -
-  **PHONE** on the  Home page screen (NAVI 50 IntelliLink)
- or -
•  **PHONE** in the Main menu screen (NAVI 80 IntelliLink)
Select **Phone** to open the menu.

Controls on steering column:

- , : Take call, end/reject call.
- or -
- **MODE/OK**: Take call, end/reject call, confirm an action.
- : Activate/deactivate voice recognition.

Depending on Infotainment system, some features of the handsfree phone system can also be operated via voice recognition ⇨ 106.

Display screen operation

R15 BT USB, R16 BT USB, CD16 BT USB, CD18 BT USB - Display screen operation

- To move up/down in the display: Turn **OK**.
- To confirm actions: Press **OK**.
- To cancel actions (and return to previous menu): Press .





NAVI 50 IntelliLink - Display screen operation

To access the Phone menu screen, select  followed by  **Phone**.

The following submenus are available:

- **Phone book**
- **Calling Lists**
- **Dial**

To switch between submenus, touch  in top left corner.

- To move up/down in the display: Touch  or .
- To confirm actions: Select **OK**.
- To cancel actions (and return to previous menu/Home page): Touch /.

For further information, refer to "Touchscreen operation" ⇨ 39.

NAVI 80 IntelliLink - Display screen operation

To access the "Phone" menu from the Home page, select **MENU** followed by  **Phone**.

The following submenus are available:

- **Phonebook**
- **Call logs**
- **Dial a number**

- **Voice mail**
- **Settings**
- To move up/down in the display: Touch ↑ or ↓.
- To cancel actions (and/or return to previous menu): Touch ←.
- To open a pop-up menu (e.g. to add contacts to a list of favourites): Touch +.

Notice

Favourites can be accessed at any time by pressing ★ on the Home page.

For further information, refer to "Touchscreen operation" ⇨ 39.

Operating keyboards in the display

R15 BT USB, R16 BT USB, CD16 BT USB, CD18 BT USB - Operating keyboards in the display

To move within and to enter characters in the numerical keyboard shown on the display screen: Turn and press **OK**.

Entries can be corrected during input with the ← keyboard character.

Press → to stop using the keyboard and return to the previous screen.

NAVI 50 IntelliLink, NAVI 80 IntelliLink - Operating keyboards in the display

To move within and to enter characters in the numerical keyboard, make the appropriate selection by touching the display screen.

Entries can be corrected during input with the ✕ keyboard character.

Touch ← to stop using the keyboard and return to the previous screen.

For further information, refer to "Touchscreen operation" ⇨ 39.

Connection

A mobile phone must be connected to the handsfree phone system in order to control its functions via the Infotainment system.

No phone can be connected to the system unless it has first been paired. Refer to the **Bluetooth connection** section (⇨ 111) for pairing a mobile phone to the handsfree phone system via Bluetooth.

When the ignition is switched on, the handsfree phone system searches for paired phones in the vicinity.

Bluetooth must be activated on the mobile phone for the phone to be recognised by the handsfree phone system. Searching continues until a paired phone is found. A display message indicates that the phone is connected.

Notice

When a Bluetooth connection is active, using the handsfree phone system will discharge the mobile phone battery more rapidly.

Automatic connection

For your phone to connect automatically when the system is switched on, it may be necessary to activate the automatic **Bluetooth** connection function on your mobile phone; refer to the mobile phone operating instructions.

Notice

Depending on Infotainment system, when reconnecting to a paired phone, or when two paired phones are within range of the handsfree

phone system, either the priority phone (if defined) or the last connected phone is connected automatically, even if this phone is outside the vehicle but still within range of the handsfree phone system.

During automatic connection, if a call is already in progress, the conversation will automatically switch to the vehicle's microphone and loudspeakers.

If connection fails:

- check the phone is switched on
- check the phone battery is not flat
- check if the phone has already been paired

The Bluetooth function on the mobile phone and on the handsfree phone system must be active and the mobile phone must be configured to accept the system connection request.

Manual connection

R15 BT USB, R16 BT USB, CD16 BT USB, CD18 BT USB - Manual connection

To change the phone connected to the handsfree phone system, press **TEL** and select the **Select Device** menu. The device list shows the phones already paired.

Select the desired phone from the list and confirm by pressing **OK**. A display message confirms phone connection.

NAVI 50 IntelliLink - Manual connection

To change the phone connected to the handsfree phone system, touch **☰** followed by **⚙️SETTING(S)** then **Bluetooth** (or select **Phone** from the Home page).

Then select **View Bluetooth device list**. The device list shows the phones already paired.

Select the desired phone from the list and confirm by touching **OK**. Depending on version, appears alongside the selected phone, to indicate connection.

NAVI 80 IntelliLink - Manual connection

To change the phone connected to the handsfree phone system, from the Home page, touch **MENU** then **☰Phone** followed by **Settings**.

Then select **Manage devices**. The device list shows the phones already paired. Select the desired phone from the list.

Disconnecting a phone

If the mobile phone is switched off, the phone is automatically disconnected from the handsfree phone system.

During disconnection, if a call is already in progress, the conversation will automatically switch to the mobile phone.

R15 BT USB, R16 BT USB, CD16 BT USB, CD18 BT USB - Disconnecting a phone

To disconnect a phone from the Infotainment system, press **TEL** (or the **SETUP**) and select **Bluetooth connection**. Select the desired device from the device list then select **Disconnect the device** by turning and pressing **OK**. A display message confirms phone disconnection.

NAVI 50 IntelliLink - Disconnecting a phone

Depending on version, to disconnect a phone from the Infotainment system, touch  followed by **⚙️SETTING(S)** then **Bluetooth** (or select **Phone** from the Home page). Then select **View Bluetooth device list**. Select the connected phone shown in the displayed list to disconnect; appears alongside the phone, to indicate disconnection.

NAVI 80 IntelliLink - Disconnecting a phone

To disconnect a phone from the Infotainment system, from the Home page, touch **MENU** then **Phone** followed by **Settings**.

Then select **Manage devices**. Select the connected phone in the displayed list to disconnect.

Defining the priority phone

R15 BT USB, R16 BT USB, CD16 BT USB, CD18 BT USB - Defining the priority phone

The priority phone is the last connected phone.

When the ignition is switched on, the handsfree phone system searches first for the priority paired phone. Searching continues until a paired phone is found.

Bluetooth connection

Bluetooth is a radio standard for the wireless connection of, e.g., a telephone with other devices.

Information such as a mobile phone contact list and call lists can be transferred. The functionality can be restricted depending on the phone model.

Prerequisites

The following prerequisites must be met, in order to control a Bluetooth-enabled mobile phone via the Infotainment system:

- The Bluetooth function of the Infotainment system must be activated.
- The Bluetooth function of the Bluetooth-enabled mobile phone must be activated (see mobile phone operating instructions).
- Dependent upon the mobile phone, it may be required to set the device to "visible" (see mobile phone operating instructions).
- The mobile phone must be paired and connected to the Infotainment system.

Activating Bluetooth function of the Infotainment system

R15 BT USB, R16 BT USB, CD16 BT USB, CD18 BT USB - Activating Bluetooth

To enable the Infotainment system to recognise and operate a Bluetooth-enabled mobile phone, the Bluetooth function must first be activated. Deactivate the function if not required.

Press **TEL** and select **Bluetooth** by turning and pressing **OK**.

Select **ON** or **OFF** and confirm by pressing the knob.

NAVI 50 IntelliLink - Activating Bluetooth

Touch **☰** followed by **⚙️SETTING(S)**.

Select **Bluetooth** to display the following options:

- **View Bluetooth device list**
- **Search for Bluetooth device**
- **External device authorisation**

- **Change passkey**
- **Smartphone**

Available depending on version. For help with activating and operating voice controls - refer to "Voice recognition" ⇨ 104).

When the **Bluetooth** screen is displayed, Bluetooth-enabled devices can be paired to the Infotainment system.

NAVI 80 IntelliLink - Activating Bluetooth

To access the Phone settings menu from the Home page, touch **MENU** then **☰Phone** followed by **Settings**.

The following options are displayed:

- **Manage devices**
- **Sound levels**
- **Voice mail**
- **Activate Bluetooth**
- **Automatically download phone data** (on/off)

Select **Turn Bluetooth on** to tick the box alongside it. Bluetooth-enabled devices can now be paired to the Infotainment system.

Refer to (NAVI 80 IntelliLink) "Phone settings" in the "Operation" section for further information ⇨ 115.

Pairing a mobile phone to the handsfree phone system

In order to use your handsfree phone system, a connection must be set up between the mobile phone and the system via **Bluetooth**, i.e. the mobile phone must be paired to the vehicle before using it. For this purpose, the mobile phone must support Bluetooth. Refer to the operating instructions for your mobile phone.

To set up a Bluetooth connection, the handsfree phone system must be switched on and Bluetooth must be activated on the mobile phone.

Notice

If another phone is automatically connected during a new pairing procedure, it will automatically be disconnected, to allow the new pairing procedure to continue.

Pairing enables the handsfree phone system to recognise and store a mobile phone in the device list. A

maximum of 5 mobile phones can be paired and stored in the device list, but only one can be connected at a time.

Notice

Depending on version of NAVI 50 IntelliLink, a maximum of eight mobile phones can be paired.

When pairing is completed, a message with the name of the paired phone is shown on the Infotainment system display screen and the phone is automatically connected to the handsfree phone system. The mobile phone can then be operated via the Infotainment system controls.

Notice

When a Bluetooth connection is active, using the handsfree phone system will discharge the mobile phone battery more rapidly.

R15 BT USB, R16 BT USB, CD16 BT USB, CD18 BT USB - Pairing a mobile phone

To pair a phone to the handsfree phone system, press **TEL** and select **Pair device** by turning and pressing **OK**. The **Ready to Pair** screen is displayed.

On the mobile phone, search for Bluetooth equipment in the vicinity of the device.

Select **My Radio** (i.e. the name of the handsfree phone system) from the list on the mobile phone, then, on the mobile phone keypad, enter the pairing code shown on the Infotainment system display screen.

If pairing fails, the system returns to the previous menu and a corresponding message is displayed. Repeat procedure if necessary.

NAVI 50 IntelliLink - Pairing a mobile phone

Touch **☰** followed by **⚙️SETTING(S)**.

Select **Bluetooth** then either **Search for Bluetooth device** or **External device authorisation**.

Alternatively, when in the **Phone** menu screen, touch **☰**.

On the mobile phone, search for Bluetooth equipment in the vicinity of the device.

Select the name of the handsfree phone system (e.g. **MEDIA-NAV**) from the list on the mobile phone, then (if required), on the mobile phone keypad, enter the pairing code shown on the Infotainment system display screen.

Notice

The pairing code may only be shown on the Infotainment system display for a limited time.

The default pairing code is **0000**. To change this pairing code before the pairing procedure is started, select **Change passkey** to update.

If pairing fails, repeat procedure if necessary.

NAVI 80 IntelliLink - Pairing a mobile phone

To access the Phone settings menu from the Home page, touch **MENU** then **☰Phone** followed by **Settings**.

Select **Manage devices** from the list of options. A message appears on the display asking if you wish to set up a Bluetooth connection between your device and the Infotainment system. Select **Yes** to continue. The Infotainment system begins a search for Bluetooth equipment in the vicinity and displays a list of devices.

Select your device from the displayed list. Depending on phone model, confirm the pairing request or enter the pairing code on the mobile phone keypad to pair it to the Infotainment system.

To pair further devices, from the **Manage devices** screen, touch **+** to open a pop-up menu and select **Add** to pair additional devices in the same way.

If pairing fails, repeat procedure if necessary.

Unpairing a mobile phone from the handsfree phone system

If the list of paired phones is full, a new phone can only be paired if an existing phone is unpaired.

Notice

Unpairing a phone erases all of its downloaded contacts and its call history from the handsfree phone system phonebook.

R15 BT USB, R16 BT USB, CD16 BT USB, CD18 BT USB - Unpairing a mobile phone

To unpair, i.e. to delete a phone from the handsfree phone system memory, press **TEL** and select **Delete device**.

Select the desired phone from the device list and press **OK** to confirm deletion when prompted.

NAVI 50 IntelliLink - Unpairing a mobile phone

To unpair, i.e. to delete a phone from the handsfree phone system memory, touch **⌘** followed by **⚙️SETTING(S)**.

Select **Bluetooth** then **View Bluetooth device list**.

Select the desired phone from the device list, then touch **🗑️** to delete the device. If required, delete all devices

in the list by selecting **Options** followed by **Delete all**. Confirm by touching **OK**.

NAVI 80 IntelliLink - Unpairing a mobile phone

To unpair, i.e. to delete a phone from the handsfree phone system memory, access the **Manage devices** screen.

From the Home page, touch **MENU** then **📞Phone** followed by **Settings**.

Select **Manage devices**, then touch **+** to open a pop-up menu, select **Delete** and remove the selected device from the list.

Emergency call

⚠️ Warning

Connection setup cannot be guaranteed in all situations. For this reason, do not rely exclusively

on a mobile phone when a vitally important communication (e.g. a medical emergency) is concerned.

On some networks, it may be necessary for a valid SIM card to be properly inserted in the mobile phone.

Warning

Bear in mind that you can only make and receive calls with the mobile phone if it is in a service area with a sufficiently strong signal.

Under certain circumstances, emergency calls cannot be made on all mobile phone networks; it is also possible that emergency calls cannot be made when certain network services and/or telephone functions are active. Consult your network provider for more information.

The emergency call number differs depending on country or region. Please enquire

beforehand about the correct emergency call number for the relevant country or region.



Dial the emergency call number (refer to "Operation" ⇨ 115); A telephone connection to the emergency call centre is set up.

Answer when the service personnel questions you about the emergency.

Warning

Do not end the call until you are requested to do so by the emergency call centre.

NAVI 50 IntelliLink

To view the emergency number for the current location, touch  followed by  **MAP** (available depending on version).

Select **Options** then **Where am I?**

When the **Where am I?** screen is displayed, touch **Options** followed by **Country information**: Emergency number (e.g. 112) is shown on the display.

Operation

Introduction

When a Bluetooth connection has been set up between your mobile phone and the handsfree phone system, certain functions of your mobile phone can be operated via the Infotainment system controls or display.

It is then possible, e.g., to import the contacts and telephone numbers stored in your mobile phone into the handsfree phone system.

Notice

The Infotainment system memory is restricted and some the contacts may not be downloaded from your mobile phone.

The contacts saved on the SIM card in your mobile phone are not visible. Only contacts saved on the phone are visible.

After connection, the mobile phone data is transmitted to the handsfree phone system. This can take some time, depending on phone model. During this period, operation of the





mobile phone is possible via the Infotainment system only to a limited extent.

Notice

Not every mobile phone supports the functions of the handsfree phone system. Therefore, deviations from the range of functions described are possible.



Phone menu

To display the **Phone** menu:



- press  **TEL**
 - or -
- press **TEL**
 - or -
- touch  followed by  **Phone** (NAVI 50 IntelliLink)
from the Home page, touch **MENU** followed by  **Phone** (NAVI 80 IntelliLink)



Volume control

R15 BT, R16 BT USB, CD16 BT, CD18 BT USB - Volume control

During a call, turn  or press  or  (on the steering column controls) to change the call volume.



NAVI 50 IntelliLink - Volume control

During a call, press  or  on the Infotainment unit to change the call volume.

Alternatively (with the steering column controls), press  or .

NAVI 80 IntelliLink - Volume control

During a call, turn  on the Infotainment unit to change the call volume.

Alternatively (with the steering column controls), press  or .



Dialling a telephone number

Several options are available for dialling telephone numbers, including calling a contact from the phonebook or from a call log. Numbers can also be dialled manually.

Entering a number manually



R15 BT USB, R16 BT USB, CD16 BT USB, CD18 BT USB - Entering a number manually

With the **Phone** menu displayed, select **Dial** from the list.

Enter the desired number using the numerical keyboard ( 107) and select  to start dialling.

To redial the last number, press and hold **TEL**.

NAVI 50 IntelliLink - Entering a number manually

With the  **Phone** menu displayed, touch  in top left corner and select **Dial** from the list.

Enter the desired number using the numerical keyboard and select  to start dialling.

Refer to (NAVI 50 IntelliLink) "Operating keyboards in the display" in the "General information" section  107.

Entries can be corrected during input with the ✕ keyboard character. Touch and hold ✕ to delete all numbers at once.

NAVI 80 IntelliLink - Entering a number manually

From the Home page, select **MENU** then **Phone** followed by **Dial a number**.

Enter the desired number using the numerical keyboard and touch **Call** to start dialling.

Entries can be corrected during input with the ✕ keyboard character.

Phonebook

The phonebook contains contact lists available only to the current vehicle user. For reasons of confidentiality, each downloaded contacts list can only be viewed when the corresponding phone is connected.

R15 BT USB, R16 BT USB, CD16 BT USB, CD18 BT USB - Phonebook

After pairing the mobile phone to the Infotainment system, the contact list in the mobile phone is downloaded to the handsfree phone system.

To dial a number from the phonebook, with the **Phone** menu displayed, select **Phonebook** and select the desired contact from the alphabetical list. Press **OK** to start the dialling process.

NAVI 50 IntelliLink - Phonebook

After pairing the mobile phone to the Infotainment system, the contact list in the mobile phone is downloaded to the handsfree phone system.

With the **Phone** menu displayed, touch ▼ in top left corner and select **Phone book** from the list.

To dial a number from the phonebook, select the desired contact from the list.

Alternatively, select **Search by Name**, then enter the name of the desired contact using the keyboard.

Refer to (NAVI 50 IntelliLink) "Operating keyboards in the display" in the "General information" section ⇨ 107.

NAVI 80 IntelliLink - Phonebook

After pairing the mobile phone to the Infotainment system, the contact list in the mobile phone is downloaded to the handsfree phone system.

Notice

Data sharing must be authorised on your phone. Refer to the operating instructions for your mobile phone or consult your network provider.

The feature "Automatically download phone data" must also be switched on in the Infotainment phone settings menu. Refer to (NAVI 80 IntelliLink) "Phone settings" below.

From the Home page, touch **MENU** then **Phone** followed by **Phone book**.

To dial a number from the phonebook, select the desired contact from the list. If a contact has more than one saved number, select

the appropriate number when prompted. The call will be started automatically after the contact number is selected.

Alternatively, select **Find**, then enter the name of the desired contact using the keyboard.

After the initial pairing of the phone with the Infotainment system, the system can be updated with the latest contacts on your mobile phone.

Touch **+** to open a pop-up menu and select **Update telephone data**. If necessary, select **Help** from the pop-up menu for assistance.

To add a contact to your list of favourites, press **+** and select **Add a contact to the Favourites page**.

Notice

Favourites can be accessed at any time by pressing **★** on the Home page.

For further information, refer to (NAVI 80 IntelliLink) "Favourites" in the "Introduction" section ⇨ 30.

Call lists

R15 BT USB, R16 BT USB, CD16 BT USB, CD18 BT USB - Call lists

To dial a number from the call history lists (e.g. dialled numbers, received calls, missed calls), select the relevant option, e.g. **Dialled numbers** from the **Call list** menu. Select the desired contact and press **OK** to start the dialling process.

NAVI 50 IntelliLink - Call lists

After connecting the mobile phone to the Infotainment system, the list of dialled numbers, received calls and missed calls in the mobile phone are transferred automatically to the handsfree phone system.

With the **☎Phone** menu displayed, touch **▼** in top left corner and select **Calling Lists** from the list.

To dial a number from the call history lists, select from the following options on the display:

- **☎All**: Displays list of all calls in the below lists.
- **☎**: Dialled numbers.

- **☎**: Received calls.
- **☎**: Missed calls.

Notice

The number of missed calls is shown alongside the symbol.

The most recent calls are displayed at the top. Select the desired contact from the chosen list to start the dialling process.

NAVI 80 IntelliLink - Call lists

After connecting the mobile phone to the Infotainment system, the list of dialled numbers, received calls and missed calls in the mobile phone are transferred automatically to the handsfree phone system.



Notice

Data sharing must be authorised on your phone. Refer to the operating instructions for your mobile phone or consult your network provider.

The feature "Automatically download phone data" must also be switched on in the Infotainment phone settings menu. Refer to (NAVI 80 IntelliLink) "Phone settings" below.

From the Home page, touch **MENU** then **Phone** followed by **Call logs**.

To dial a number from the call history lists, select from the following options on the display:

- **All**: Displays list of all calls in the below lists.
- : Received calls.
- : Missed calls.
- : Dialed numbers.

The most recent calls are displayed at the top. Alternatively, touch \uparrow or \downarrow to move up/down in the display.

Select the desired contact from the chosen call list to start the dialling process.

Notice

If necessary, touch **+** (to open a pop-up menu) and select **Update telephone data** to update the call lists.

Voicemail box

R15 BT USB, R16 BT USB, CD16 BT USB, CD18 BT USB - Voicemail box

To listen to mobile phone voicemail messages via the Infotainment system while the phone is connected, select the **Voicemail box** menu.

NAVI 80 IntelliLink - Voicemail box



To listen to mobile phone voicemail messages via the Infotainment system while the phone is connected, from the Home page, select **MENU** then **Phone** followed by **Voice mail**. The system will call the configured voicemail box.

The configuration screen will be displayed if the voicemail box is not configured. Enter number on the numerical keyboard and confirm.



Receiving calls

R15 BT USB, R16 BT USB, CD16 BT USB, CD18 BT USB - Receiving calls

To accept the call, depending on vehicle configuration:

- Briefly press  (on the steering column controls).
- Select the  icon in the display (by turning and pressing **OK**).

To reject the call, depending on vehicle configuration:

- Press and hold  (on the steering column controls).
- Select the  icon in the display (by turning and pressing **OK**).

When receiving a call, the caller number may be shown on the Infotainment system display screen. If the number is stored in the system memory, the name is displayed instead. If the number cannot be displayed, the message **Private number** is shown.

NAVI 50 IntelliLink - Receiving calls

To accept the call:

- Touch **Accept/Agree**.
- Briefly press  (on the steering column controls).

To reject the call:

- Touch **Refuse/Reject**.
- Press and hold  (on the steering column controls).

When receiving a call, the caller number may be shown on the Infotainment system display screen. If the number is stored in the system memory, the name is displayed instead. If the number cannot be displayed, the message **Unknown/Unknown number** is shown.

NAVI 80 IntelliLink - Receiving calls

To accept the call:

- Touch **Pick up**.
- Briefly press  (on the steering column controls).

To reject the call:

- Touch **Reject**.
- Press and hold  (on the steering column controls).

When receiving a call, the caller number may be shown on the Infotainment system display screen. If the number is stored in the system memory, the name is displayed instead. If the number cannot be displayed, the message **No Caller ID** is shown.

Functions during a telephone call**R15 BT USB, R16 BT USB, CD16 BT USB, CD18 BT USB - Functions during a telephone call**

In addition to volume control, various functions are available during a call, including:

- Switch the call to the mobile phone.
- Access the keyboard.
- End call.



Turn and press **OK** to select and confirm.

Switch the call from the handsfree phone system to the mobile phone by selecting the mobile phone display item. Some mobile phones may

become disconnected from the handsfree phone system during the switch to this mode.





A number can also be entered on the numerical keyboard ( 107) e.g. to control a voice server such as the voicemail box. Select the **#123** display item to access the numerical keyboard. Refer to "**Voicemail box**" for further information.

To end the call, depending on vehicle configuration:

- Briefly press .
- Press **TEL**.
- Select the  icon in the display.

NAVI 50 IntelliLink - Functions during a telephone call

In addition to volume control, various functions are available during a call, including:

- : End call.
- : Switch vehicle microphone off.
- : Switch vehicle microphone on.
- : Transfer conversation to mobile phone.

- : Transfer conversation to vehicle's microphone and loudspeakers.
- : Return to previous screen (e.g. Navigation or Home page).

NAVI 80 IntelliLink - Functions during a telephone call

In addition to volume control, various functions are available during a call, including:

- Place call on hold: Touch **+** (to open pop-up menu) then select **On hold**. Touch **Continue** to resume the call.
- Transfer conversation to mobile phone: Touch **+** (to open pop-up menu) then select **Handset**.
In some cases, the phone may be disconnect from the Infotainment system during a call transfer.
- End call: Touch **End call**.
- Return to previous menu: Touch **←**.

Phone settings

NAVI 50 IntelliLink - Phone settings Restore default phone settings

To access the settings menu at any time, touch followed by **SETTING(S)**.

Select **System** followed by **Factory settings** then **Phone** to restore phone settings to their default values. Confirm by touching **OK**.

Display software version

To access the settings menu at any time, touch followed by **SETTING(S)**.

Select **System** followed by **System version** to display the software version.

NAVI 80 IntelliLink - Phone settings

From the Home page, touch **MENU** then **Phone** followed by **Settings**.

Select from the following options:

- **Manage devices:**
Refer to (NAVI 80 IntelliLink) "Pairing a mobile phone" in the "Bluetooth connection" section 111.

- **Sound levels:**

To set the handsfree phone system call volume and the ringtone.

- **Voice mail:**

Refer to (NAVI 80 IntelliLink) "Voicemail box" above.

- **Activate Bluetooth:**

Refer to (NAVI 80 IntelliLink) "Activating Bluetooth" in the "Bluetooth connection" section 111.

- **Automatically download phone data:**

Select this option to tick the box alongside it.

When pairing and/or connecting the mobile phone to the Infotainment system, the contact list and call lists in the mobile phone can now be downloaded to the handsfree phone system.

Data sharing must also be authorised on your phone. Refer to the operating instructions for your mobile phone or consult your network provider.

Mobile phones and CB radio equipment

Installation instructions and operating guidelines

The vehicle specific installation instructions and the operating guidelines of the mobile phone and handsfree manufacturer must be observed when installing and operating a mobile telephone. Failure to do so could invalidate the vehicle type approval (EU directive 95/54/EC).

Recommendations for fault-free operation:

- professionally installed exterior antenna to obtain the maximum range possible
- maximum transmission power ten watts
- installation of the phone in a suitable spot, consider relevant Note in the Owner's Manual section **Airbag system**

Seek advice on predetermined installation points for the external antenna or equipment holder and

ways of using devices with a transmission power exceeding ten watts.

Use of a handsfree attachment without external antenna with mobile telephone standards GSM 900/1800/1900 and UMTS is only permitted if the maximum transmission power of the mobile telephone is two watts for GSM 900 or one watt for the other types.

For reasons of safety, do not use the phone while driving. Even use of a handsfree set can be a distraction while driving.

Warning

Operation of radio equipment and mobile telephones which fail to meet above mentioned mobile telephone standards is only permitted using an antenna located outside of the vehicle.

Caution

Mobile telephones and radio equipment may lead to malfunctions in the vehicle electronics when operated inside the vehicle with no exterior antenna, unless the above mentioned regulations are observed.

Index

A

AAC files.....	57
ACC files.....	63
Activating Bluetooth function.....	111
Activating the navigation system. .	78
Activating voice recognition.....	105
Adaptation volume km/h.....	42
Add a favourite destination.....	90
Add contacts to the phonebook.....	115
AF (Alternative Frequency).....	53
AGC Activated.....	40
Aha® application.....	30
AST (Autostore list).....	52
Audio CDs.....	57
Audio players.....	30
Audio settings.....	40, 58
Automatic call waiting.....	115
Automatic Gain Control (AGC).....	40
Automatic phone connection.....	109
Automatic station search.....	50
Automatic station storing.....	52
Automatic switch-off.....	30
Automatic zoom.....	78
Autostore lists.....	52
AUX input.....	61
AUX input usage.....	61
Avoid part of route.....	96

B

Balance.....	40
Bass.....	40
Battery replacement.....	78
Bluetooth.....	107
Bluetooth connection.....	67, 111
Bluetooth device list.....	111
Bluetooth music.....	67
Browse map.....	96

C

Call lists.....	115
Call waiting.....	115
CD display.....	58
CD playback.....	58
CD player.....	57, 58
CD-Text.....	58
Change Home location.....	78
Change passkey for Bluetooth connection.....	111
Change system language.....	30, 43
Clock.....	30, 43, 78
Compass.....	78
Connecting an audio device.....	67
Connection.....	109
Control elements overview.....	6
Co-ordinates.....	78, 90
Country information.....	96, 114

- D**
- DAB..... 55
 - Data sharing settings..... 30
 - Daytime running lights setting..... 30
 - Deactivating Bluetooth function.. 111
 - Deactivating guidance..... 96
 - Defining the priority phone..... 109
 - Delete a favourite destination..... 90
 - Delete device from Bluetooth device list..... 111
 - Destination..... 78
 - Destination input 90
 - Dialling a telephone number..... 115
 - Digital audio broadcasting..... 55
 - Disconnecting an audio device..... 67
 - Disconnecting a phone..... 109
 - Display..... 30
 - Display information..... 58
 - Displaying pictures..... 73
 - Display screen operation..... 30, 107
 - Driving style indicator
 - Fuel economy gauge..... 30
- E**
- Easy access..... 30
 - Eco-coaching..... 30
 - Eco Driving..... 30
 - Edit Itinerary..... 96
 - Emergency call..... 114
 - Emergency number..... 114
- Enter an address..... 90**
- Entering a number manually..... 115**
- External device authorisation..... 111**
- F**
- Fader..... 40
 - Fast forward..... 58
 - Fast rewind..... 58
 - Favourite destinations..... 90
 - Favourites..... 30
 - Media..... 30
 - Navigation..... 30
 - Phone..... 30
 - Services..... 30
 - FM station list..... 52
 - Folding mirrors setting..... 30
 - Fuel economy gauge
 - Driving style indicator..... 30
 - Functions during a telephone call 115
- G**
- General information... 4, 57, 61, 63, 67, 75, 104, 107
 - GPS (Global Positioning System). 75
 - Guidance 96
 - Guided tours..... 78
- H**
- Handsfree phone system..... 115
 - HD Traffic..... 78
 - Help!..... 96, 104
- Home address..... 90**
- Home location..... 78**
- I**
- i-Announcement..... 53
 - ID3 tags..... 58
 - Image settings..... 30
 - Image viewer..... 78
 - i-News service..... 53
 - Information on the display..... 39, 78
 - Infotainment controls..... 30
 - Infotainment system
 - Switching on/off..... 30
 - Instrument panel controls..... 6
 - Intersection view..... 78
 - iPod..... 63, 64
 - i-Traffic service..... 53
- J**
- Jack plug..... 61
- K**
- Keyboards in the display..... 78, 107
- L**
- Lane images..... 78
 - Language..... 30
 - Latitude, Longitude..... 90
 - Live services..... 78
 - Local search..... 90

Loudness.....	40
Low volume sound enhancement.....	40

M

Mailbox.....	115
Manual phone connection.....	109
Manual station search.....	50
Manual station storing.....	52
Maps.....	75
Map screen.....	78
Menu screen.....	39, 78
MIX.....	58
Mobile phones and CB radio equipment	122
Modes of operation.....	30
Motorway view.....	78
MP3 CDs.....	57
MP3 files.....	63
MP3 player.....	64
MP3 players.....	63
Multimedia.....	73
Multimedia settings.....	43
Musical atmosphere.....	40
Mute.....	30, 58
My TomTom LIVE.....	78

N

Navigation control.....	105
Navigation services.....	30

Navigation system	
Creating an account.....	75
GPS (Global Positioning System).....	75
Installing the software.....	75
Maps.....	75
Registering the Navigation system.....	75
SD card.....	75
Software installation.....	75
Traffic info service.....	75
USB memory stick.....	75
Navigation system preferences.....	78
Navigation volume.....	78
Navigation warnings.....	78
News.....	53

O

Onboard computer.....	30
Operation.....	67, 115

P

Pairing a mobile phone.....	111
Pairing an audio device.....	67
Park Assist.....	30
Pause.....	58
Phone.....	107
Phonebook.....	115
Phone connection.....	109
Phone control.....	106
Phone controls.....	107

Phone installation instructions....	122
Phone menu.....	115
Phone operating guidelines.....	122
Phone settings.....	115
Photos.....	73
Pictures.....	73
Planning preferences.....	78
Playing movies.....	73
Playing music via Bluetooth.....	67
Playing saved audio files.....	64
POI categories.....	90
Points of interest.....	30
Points of Interest (POI).....	90
POIs.....	30, 90
Portable CD players.....	61
Prepare route in advance.....	90
PTY (Program type).....	53

Q

Quick menu.....	78
-----------------	----

R

Radio.....	48
DAB.....	55
Digital Audio Broadcasting.....	55
Radio controls.....	48
Radio data system (RDS)	53
Radio functions.....	52, 53
Radio reception.....	48
Radio station name search.....	50
Radio text.....	53

Random playback.....	58
RDS.....	53
Rear camera.....	30
Rear camera view settings.....	30
Rear OFF.....	40
Rear window wiper setting.....	30
Recalling a station.....	52
Recalling a stored station.....	50
Receiving calls.....	115
Recent destinations.....	90
Region.....	53
Removing a CD.....	58
Restore default settings.....	30
Restore factory settings.....	43
Route.....	78
Route information.....	96
Route planning method.....	78
Route settings.....	78

S

Safety alerts.....	78
Save a favourite destination.....	90
Saved locations.....	90
SD card.....	75, 78
Search for Bluetooth device.....	111
Search radio station name.....	50
Security code.....	29
Select a destination.....	90
Selecting an album.....	58
Selecting a track.....	58

Selecting the waveband.....	48
Services.....	30
Settings.....	30
Setting the time.....	30
Setting the volume.....	30
Setting up the navigation system.....	78
Simulcast.....	53
Slideshow.....	78
Software version.....	115
Sound optimisation.....	40
Speed cameras.....	78
Speed dependent volume.....	42
Station search.....	50
Station storing.....	52
Steering column controls.....	6
Stored stations.....	50
Switching on/off.....	30
Symbols overview.....	103
System settings.....	43

T

Text information (CD-Text or ID3 tag).....	58
Text information (Radio text).....	53
Theft-deterrent feature.....	29
Thumbnails.....	73
Time.....	30
Tone settings.....	40
Touch operation overview.....	39
Traffic announcements (TA).....	53

Traffic announcement volume.....	42
Traffic information.....	96
Traffic info service.....	75
Traffic safety.....	4, 107
Treble.....	40
Trip computer.....	30
Trip report.....	30

U

Unpairing a mobile phone.....	111
Update FM list.....	52
Updating stations list.....	52
Usage.....	30, 48, 58, 61, 78
USB drive.....	63
USB drives.....	64
USB memory stick.....	75, 78
USB port.....	63
USB socket.....	64
Using the CD player.....	58
Using the display screen.....	30
Using the Infotainment system.....	30
Using this manual.....	4

V

Vehicle information.....	30
Videos.....	73
Voice control.....	105
Voice mail box.....	115
Voice preferences.....	78
Voice recognition.....	104, 106
Voice tags.....	106

Volume.....	106
Adaptation volume km/h.....	42
Automatic Gain Control (AGC)..	40
Low volume sound enhancement.....	40
Rear OFF.....	40
Speed dependent volume... 30,	42
Traffic announcement volume...	42
Volume distribution.....	40
Volume control.....	115
Volume settings.....	42

W

Waveband selection.....	48
WAV files.....	57
Waypoints.....	90, 96
Weather.....	78
Where am I?.....	96, 114
WMA CDs.....	57
WMA files.....	63

Copyright by General Motors UK Ltd.

The information contained in this publication is effective as of the date indicated below. General Motors UK Ltd. reserves the right to make changes to the technical specifications, features and design of the vehicles relative to the information contained in this publication, as well as changes to the publication itself.

Edition: February 2017, General Motors UK Ltd.

Printed on chlorine-free bleached paper.

ID-VLCVIRIE1702-en

