

ASTRA PRICE/SPECIFICATION GUIDE

3 January 2017 | Model Year 2017.5



**PROUD SPONSOR OF OUR
NATIONAL FOOTBALL TEAMS**



ASTRA CUSTOMER OFFERS

At Vauxhall we know that customers appreciate flexibility. Not only do we have an extensive range of Astra models to choose from, but we have a range of ways to purchase too. Here's an example of our personal contract purchase offer:



£2,000

Vauxhall Deposit Contribution

3.7% APR

Representative Flexible PCP*

For even more great deals contact your local Retailer or call 0345 600 1500 or visit www.vauxhall.co.uk/offers

TERMS AND CONDITIONS: *Offer subject to availability at participating Retailers only. Personal Contract Purchase. Finance subject to status, terms and conditions apply. Applicants must be 18+. Finance by Vauxhall Finance, PO Box 6666, CF15 7YT. Vauxhall Deposit Contribution only available when vehicle financed through Vauxhall Finance. At the end of the agreement there are three options: i) Retain the vehicle: Pay the optional final payment to own the vehicle, ii) Return the vehicle, or iii) Replace: Part Exchange the vehicle, where equity is available. Offer applies to private individuals, Vauxhall Partners and small businesses 1-24 units (purchase only excluding B2B supported units). All other customers are excluded. Offer available on orders or registrations between 19 December 2016 and 3 April 2017.

ASTRA RANGE HIGHLIGHTS



DESIGN OTR from £15,915

Standard features include:

Exterior convenience / styling:

- 16-inch alloy wheels
- Chrome-effect upper window trim
- Automatic lighting control
- Electrically operated front / rear windows
- Remote control central locking
- Electrically adjustable / heated door mirrors
- Black roof rails (Sports Tourer)

Interior convenience / styling:

- Air conditioning
- Multi-function trip computer
- Cruise control with speed limiter
- Steering wheel audio / phone / cruise controls
- Steering column adjustable for reach / rake

Infotainment:

- IntelliLink audio system
 - 7-inch colour touchscreen
 - AM/FM/DAB digital radio
 - Bluetooth® audio streaming
 - Bluetooth® mobile phone portal
 - Apple CarPlay™ / Android Auto™
 - USB audio connection
- Four speakers (front)

Safety / security:

- Electronic Stability Programme (ESP)
- Anti-lock Braking System (ABS)
- Six airbags
- Hill start assist
- ISOFIX child seat mounting points on outer rear seats
- Seatbelt pretensioners for front / outer rear seats
- Tyre pressure monitoring system
- Door-to-door illumination
- LED daytime running lights
- Electronic engine deadlock immobiliser



TECH LINE OTR from £16,615

Features over Design:

Interior convenience / styling:

- Leather-covered steering wheel
- Adjustable front armrest

Infotainment:

- Navi 900 IntelliLink system
 - Fully integrated European sat nav system
 - 8-inch colour touchscreen
- Six speakers (four front, two rear)



ENERGY OTR from £17,915

Features over Design:

Interior convenience / styling:

- Heated three-spoke leather-covered steering wheel
- Heated front seats



Exterior convenience / styling:



- 17-inch 10-spoke alloy wheels





ASTRA RANGE HIGHLIGHTS



SRi	OTR from £18,515
<i>Features over Design:</i>	
Exterior convenience / styling:	
<ul style="list-style-type: none"> • 17-inch 5 twin-spoke alloy wheels • Rain-sensitive windscreen wipers • Automatic lighting with tunnel detection • Automatic anti-dazzle rear-view mirror • Front fog lights • Silver-effect roof rails (Sports Tourer) 	
Interior convenience / styling:	
<ul style="list-style-type: none"> • Leather-covered steering wheel • Sports-style front seats • Front centre armrest • Storage pockets on front seat backs • Sport switch (not available on 1.4i (100PS) models) 	
Infotainment:	
<ul style="list-style-type: none"> • Six speakers (four front, two rear) 	
Safety / security:	
<ul style="list-style-type: none"> • Vauxhall OnStar • Driving Assistance Pack One featuring intelligent forward camera system • Remote control alarm system (optional at extra cost on 1.4i (100PS) models) 	
SRi Nav models additionally feature	
<ul style="list-style-type: none"> • Navi 900 IntelliLink system <ul style="list-style-type: none"> – Fully integrated European sat nav system – 8-inch colour touchscreen 	
	
	







SRi VX-LINE	OTR from £20,715
<i>Features over Design:</i>	
Exterior convenience / styling:	
<ul style="list-style-type: none"> • 18-inch 5 twin-spoke alloy wheels • Sports-style front and rear bumper / side sills • Rain-sensitive windscreen wipers • Automatic lighting with tunnel detection • Automatic anti-dazzle rear-view mirror 	
Interior convenience / styling:	
<ul style="list-style-type: none"> • Leather-covered steering wheel • Sports-style front seats • Front centre armrest • Storage pockets on front seat backs • Sport switch 	
Infotainment:	
<ul style="list-style-type: none"> • Six speakers (four front, two rear) 	
Safety / security:	
<ul style="list-style-type: none"> • Vauxhall OnStar • Driving Assistance Pack One featuring intelligent forward camera system • Remote control alarm system 	
SRi VX-LINE Nav models additionally feature	
<ul style="list-style-type: none"> • Navi 900 IntelliLink system <ul style="list-style-type: none"> – Fully integrated European sat nav system – 8-inch colour touchscreen 	
	
	

ELITE	OTR from £19,235
<i>Features over Design:</i>	
Exterior convenience / styling:	
<ul style="list-style-type: none"> • 17-inch multi-spoke alloy wheels • Rain-sensitive windscreen wipers • Automatic lighting control with tunnel detection • Automatic anti-dazzle rear-view mirror • Front fog lights • Electrically folding door mirrors • Silver-effect roof rails (Sports Tourer) 	
Interior convenience / styling:	
<ul style="list-style-type: none"> • Leather seat trim • Electronic dual-zone climate control • Heated leather-covered steering wheel • Heated front / outer rear seats • Sports-style front seats • Four-way electrical lumbar adjustment • Front centre armrest • Centre rear armrest • Storage pockets on front seat backs • Electric parking brake • Two rear USB charging points • Front door sill covers 	
Infotainment:	
<ul style="list-style-type: none"> • Six speakers (four front, two rear) 	
Safety / security:	
<ul style="list-style-type: none"> • Vauxhall OnStar • Remote control alarm system 	
Elite Nav models additionally feature	
<ul style="list-style-type: none"> • Navi 900 IntelliLink system <ul style="list-style-type: none"> – Fully integrated European sat nav system – 8-inch colour touchscreen 	
	
	

ASTRA DESIGN

		Hatchback		Sports Tourer	
		OTR RRP	CO ₂ (g/km)	OTR RRP	CO ₂ (g/km)
ASTRA DESIGN – ON-THE-ROAD PRICES					
Petrol	1.4i (100PS)	£15,915	124	£17,205	127
	1.0i Turbo (105PS) S/S ecoFLEX	£16,615	102	£17,905	103
	1.0i Turbo (105PS) S/S ecoFLEX Easytronic	£17,015	102	-	-
	1.4i Turbo (125PS)	£16,665	124	£17,955	127
	1.4i Turbo (150PS) S/S auto	£18,315	124	-	-
Diesel	1.6CDTi (110PS)	£17,615	95	£18,905	96
	1.6CDTi (110PS) S/S ecoFLEX	£18,115	88	£19,405	89
	1.6CDTi (136PS) S/S	£18,800	99	£20,090	101
	1.6CDTi (136PS) auto	£20,120	115	£21,410	119

Please note: On-the-road recommended retail prices (RRP) include VAT at 20%, number plates and delivery to Retailer of £700.00 (inc. £116.67 VAT), 12 months' Vehicle Excise Duty and new vehicle first registration fee of £55.00. Excludes fuel and insurance. S/S = Start/Stop.

ASTRA DESIGN – KEY OPTIONS		Total inc. VAT
 Looking good:	Brilliant paint	£285
	Metallic / pearlescent paint	£555
	17-inch 10-spoke alloy wheels	£405
 Easier parking:	Front and rear parking distance sensors	£460
 Sitting comfortably:	Ergonomic driver's sport-style seat	£260
 Fresh air:	Power tilt and slide sunroof	£510
 Driving assistance:	Driving Assistance Pack One <i>Forward collision alert with automatic city emergency braking / traffic sign recognition / following distance indicator / lane departure warning with lane assist</i>	£805
 Practicality:	Vauxhall OnStar – your personal on board assistant	£405
	Steel emergency spare wheel (in lieu of emergency tyre inflation kit)	£110
	Full-size 16-inch steel spare wheel (in lieu of emergency tyre inflation kit) (Sports Tourer only)	£110
	Remote control ultrasonic security alarm system	£260
	PowerFlex bar	£55
	Smartphone holder	£50
	Air Wellness fragrance diffuser	£50
	Fixing points for vertical load-restraining net (Sports Tourer only)	£65
	Vertical load-restraining net (Sports Tourer only)	£135
	FlexOrganiser® Pack (Sports Tourer only)	£105
Towing Pack	£535	

For details of these and other options please see Features/Options pages.



ASTRA DESIGN – FEATURES

Infotainment:

- IntelliLink audio system
 - 7-inch colour touchscreen
 - AM/FM/DAB digital radio
 - Bluetooth® audio streaming
 - Bluetooth® mobile phone portal
 - Apple CarPlay™ / Android Auto™
 - USB audio connection
- Four speakers (front)

Interior convenience / styling:

- Air conditioning
- Multi-function trip computer
- Cruise control with speed limiter
- Steering wheel audio / phone / cruise controls
- Steering column adjustable for reach / rake

Exterior convenience / styling:

- 16-inch alloy wheels
- Chrome-effect upper window trim
- Automatic lighting control
- Electrically operated front / rear windows
- Remote control central locking
- Electrically adjustable / heated door mirrors
- Black roof rails (Sports Tourer)

Safety / security:

- Electronic Stability Programme (ESP)
- Anti-lock Braking System (ABS)
- Six airbags
- Hill start assist
- ISOFIX child seat mounting points on outer rear seats
- Seatbelt pretensioners for front / outer rear seats
- Tyre pressure monitoring system
- Door-to-door illumination
- LED daytime running lights
- Electronic engine deadlock immobiliser

CUSTOMER OFFERS*

Please consult your Retailer for details.

-  **Flexible Personal Lease**

* = Terms and conditions apply.

COMPANY CAR INFORMATION

Please see www.vauxhall.co.uk/fleet for details.







-  **P11D price starting at £15,860**
-  **From 16% tax band** / £45 monthly BiK tax****
-  **CO₂ emissions from 88g/km**

** = 2016/17 tax year.

ASTRA TECH LINE

		Hatchback		Sports Tourer	
		OTR RRP	CO ₂ (g/km)	OTR RRP	CO ₂ (g/km)
ASTRA TECH LINE – ON-THE-ROAD PRICES					
<i>Petrol</i>	1.4i (100PS)	£16,615	124	£17,905	127
	1.0i Turbo (105PS) S/S ecoFLEX	£17,315	102	£18,605	103
	1.4i Turbo (125PS)	£17,365	124	£18,655	127
	1.4i Turbo (150PS) S/S auto	£19,015	124	-	-
<i>Diesel</i>	1.6CDTi (110PS)	£18,315	95	£19,605	96
	1.6CDTi (110PS) S/S ecoFLEX	£18,815	88	£20,105	89
	1.6CDTi (136PS) S/S	£19,500	99	£20,790	101
	1.6CDTi (136PS) auto	£20,820	115	£22,110	119

Please note: On-the-road recommended retail prices (RRP) include VAT at 20%, number plates and delivery to Retailer of £700.00 (inc. £116.67 VAT), 12 months' Vehicle Excise Duty and new vehicle first registration fee of £55.00. Excludes fuel and insurance. S/S = Start/Stop.

ASTRA TECH LINE – KEY OPTIONS		Total inc. VAT
 Looking good:	Brilliant paint	£285
	Metallic / pearlescent paint	£555
	17-inch 10-spoke alloy wheels	£405
 Easier parking:	Front and rear parking distance sensors	£460
 Sitting comfortably:	Ergonomic driver's sport-style seat	£260
 Fresh air:	Power tilt and slide sunroof	£510
 Driving assistance:	Driving Assistance Pack One <i>Forward collision alert with automatic city emergency braking / traffic sign recognition / following distance indicator / lane departure warning with lane assist</i>	£805
 Practicality:	Vauxhall OnStar – your personal on board assistant	£405
	Steel emergency spare wheel (in lieu of emergency tyre inflation kit)	£110
	Full-size 16-inch steel spare wheel (in lieu of emergency tyre inflation kit) (Sports Tourer only)	£110
	Remote control ultrasonic security alarm system	£260
	PowerFlex bar	£55
	Smartphone holder	£50
	Air Wellness fragrance diffuser	£50
	Fixing points for vertical load-restraining net (Sports Tourer only)	£65
	Vertical load-restraining net (Sports Tourer only)	£135
	FlexOrganiser® Pack (Sports Tourer only)	£105
CD drive	£135	
Towing Pack	£535	

For details of these and other options please see Features/Options pages.



ASTRA TECH LINE – FEATURES

Infotainment:

- Navi 900 IntelliLink system
 - Fully integrated European sat nav system
 - 8-inch colour touchscreen
 - AM/FM/DAB digital radio
 - Bluetooth® audio streaming
 - Bluetooth® mobile phone portal
 - Apple CarPlay™ / Android Auto™
 - USB audio connection
- Six speakers (four front, two rear)

Interior convenience / styling:

- Air conditioning
- Multi-function trip computer
- Cruise control with speed limiter
- Leather-covered steering wheel
- Front centre armrest
- Steering wheel audio / phone / cruise controls
- Steering column adjustable for reach / rake

Exterior convenience / styling:

- 16-inch alloy wheels
- Chrome-effect upper window trim
- Automatic lighting control
- Electrically operated front / rear windows
- Remote control central locking
- Electrically adjustable / heated door mirrors
- Black roof rails (Sports Tourer)

Safety / security:

- Electronic Stability Programme (ESP)
- Anti-lock Braking System (ABS)
- Six airbags
- Hill start assist
- ISOFIX child seat mounting points on outer rear seats
- Seatbelt pretensioners for front / outer rear seats
- Tyre pressure monitoring system
- Door-to-door illumination
- LED daytime running lights
- Electronic engine deadlock immobiliser

CUSTOMER OFFERS*

Please consult your Retailer for details.

-  **Flexible Personal Lease**

* = Terms and conditions apply.

COMPANY CAR INFORMATION

Please see www.vauxhall.co.uk/fleet for details.

-  **P11D price starting at £16,560**

-  **From 16% tax band** / £47 monthly BiK tax****





-  **CO₂ emissions from 88g/km**

** = 2016/17 tax year.

ASTRA ENERGY

	Hatchback		Sports Tourer	
	OTR RRP	CO ₂ (g/km)	OTR RRP	CO ₂ (g/km)
ASTRA ENERGY – ON-THE-ROAD PRICES				
<i>Petrol</i>	1.4i (100PS)	£17,915	128	-
	1.0i Turbo (105PS) S/S ecoFLEX	£18,615	104	-
	1.4i Turbo (125PS)	£18,665	128	-
<i>Diesel</i>	1.6CDTi (110PS)	£19,615	97	-

Please note: On-the-road recommended retail prices (RRP) include VAT at 20%, number plates and delivery to Retailer of £700.00 (inc. £116.67 VAT), 12 months' Vehicle Excise Duty and new vehicle first registration fee of £55.00. Excludes fuel and insurance. S/S = Start/Stop.

ASTRA ENERGY – KEY OPTIONS		Total inc. VAT
 Looking good:	Brilliant paint	£285
	Metallic / pearlescent paint	£555
 Easier parking:	Front and rear parking distance sensors	£460
 Fresh air:	Power tilt and slide sunroof	£510
 Driving assistance:	Driving Assistance Pack One <i>Forward collision alert with automatic city emergency braking / traffic sign recognition / following distance indicator / lane departure warning with lane assist</i>	£805
 Practicality:	Vauxhall OnStar – your personal on board assistant	£405
	Steel emergency spare wheel (in lieu of emergency tyre inflation kit)	£110
	Remote control ultrasonic security alarm system	£260
	PowerFlex bar	£55
	Smartphone holder	£50
	Air Wellness fragrance diffuser	£50
	CD drive (only available in conjunction with Navi 900 IntelliLink)	£135
	Navi 900 IntelliLink touchscreen navigation and infotainment system	£710
Towing Pack	£535	

For details of these and other options please see Features/Options pages.



ASTRA ENERGY – FEATURES

Infotainment:

- IntelliLink audio system
 - 7-inch colour touchscreen
 - AM/FM/DAB digital radio
 - Bluetooth® audio streaming
 - Bluetooth® mobile phone portal
 - Apple CarPlay™ / Android Auto™
 - USB audio connection
- Four speakers (front)

Interior convenience / styling:

- Air conditioning
- Multi-function trip computer
- Cruise control with speed limiter
- Steering wheel audio / phone / cruise controls
- Heated three-spoke leather-covered steering wheel
- Heated front seats
- Steering column adjustable for reach / rake

Exterior convenience / styling:



- 17-inch 10-spoke alloy wheels
- Chrome-effect upper window trim
- Automatic lighting control
- Electrically operated front / rear windows
- Remote control central locking
- Electrically adjustable / heated door mirrors

Safety / security:

- Electronic Stability Programme (ESP)
- Anti-lock Braking System (ABS)
- Six airbags
- Hill start assist
- ISOFIX child seat mounting points on outer rear seats
- Seatbelt pretensioners for front / outer rear seats
- Tyre pressure monitoring system
- Door-to-door illumination
- LED daytime running lights
- Electronic engine deadlock immobiliser

CUSTOMER OFFERS*

Please consult your Retailer for details.

-  **0% Flexible Finance**
-  **Flexible PCP (3.7% APR) with £2000 Vauxhall Deposit Contribution**
-  **Flexible Personal Lease**

* = Terms and conditions apply.

COMPANY CAR INFORMATION

Please see www.vauxhall.co.uk/fleet for details.

-  **P11D price starting at £17,860**
-  **From 17% tax band** / £53 monthly BiK tax****
-  **CO₂ emissions from 97g/km**



** = 2016/17 tax year.

ASTRA SRi

		Hatchback		Sports Tourer	
		OTR RRP	CO ₂ (g/km)	OTR RRP	CO ₂ (g/km)
ASTRA SRi – ON-THE-ROAD PRICES					
<i>Petrol</i>	1.4i (100PS)	£18,515	128	£19,935	131
	1.0i Turbo (105PS) S/S ecoFLEX	£19,215	104	–	–
	1.4i Turbo (125PS)	–	–	£20,555	130
	1.4i Turbo (150PS)	£19,515	128	£20,805	130
	1.4i Turbo (150PS) S/S auto	£20,915	127	£22,205	128
	1.6i Turbo (200PS) S/S	£21,055	141	£22,345	142
<i>Diesel</i>	1.6CDTi (110PS)	£20,215	97	£21,505	99
	1.6CDTi (110PS) S/S ecoFLEX	£20,715	91	£22,005	92
	1.6CDTi (136PS) S/S	£21,400	103	£22,690	104
	1.6CDTi (136PS) auto	£22,720	119	£24,010	122
	1.6CDTi BiTurbo (160PS) S/S	£22,015	109	£23,305	109

		Hatchback		Sports Tourer	
		OTR RRP	CO ₂ (g/km)	OTR RRP	CO ₂ (g/km)
ASTRA SRi NAV – ON-THE-ROAD PRICES					
<i>Petrol</i>	1.4i (100PS)	£19,215	128	£20,635	131
	1.0i Turbo (105PS) S/S ecoFLEX	£19,915	104	–	–
	1.4i Turbo (125PS)	–	–	£21,255	130
	1.4i Turbo (150PS)	£20,215	128	£21,505	130
	1.4i Turbo (150PS) S/S auto	£21,615	127	£22,905	128
	1.6i Turbo (200PS) S/S	£21,755	141	£23,045	142
<i>Diesel</i>	1.6CDTi (110PS)	£20,915	97	£22,205	99
	1.6CDTi (110PS) S/S ecoFLEX	£21,415	91	£22,705	92
	1.6CDTi (136PS) S/S	£22,100	103	£23,390	104
	1.6CDTi (136PS) auto	£23,420	119	£24,710	122
	1.6CDTi BiTurbo (160PS) S/S	£22,715	109	£24,005	109

Please note: On-the-road recommended retail prices (RRP) include VAT at 20%, number plates and delivery to Retailer of £700.00 (inc. £116.67 VAT), 12 months' Vehicle Excise Duty and new vehicle first registration fee of £55.00. Excludes fuel and insurance. S/S = Start/Stop.

ASTRA SRi – KEY OPTIONS		Total inc. VAT
	Looking good:	
	Brilliant paint	£285
	Metallic / pearlescent paint	£555
	18-inch bi-colour alloy wheels	£405
	18-inch five twin-spoke alloy wheels	£480
	Easier parking:	
	Parking Pack	
	Front and rear parking distance sensors / advance park assist / side blind spot alert / rear-view camera	£615
	Front and rear parking distance sensors	£460
	Sitting comfortably:	
	Ergonomic driver's sport-style seat	£260
	Winter Pack	
	Heated leather-covered steering wheel / heated front seats	£355
	Fresh air:	
	Power tilt and slide sunroof	£510
	Electronic climate control	£405
	Driving assistance:	
	IntelliLux LED Matrix headlights	£1250
	LED tail lights (standard with IntelliLux LED Matrix headlights)	£205

For details of these and other options please see Features/Options pages.



ASTRA SRi – FEATURES

Vauxhall OnStar:

- Automatic crash response / Wi-Fi hotspot / smartphone app / stolen vehicle assistance / vehicle diagnostics

Infotainment:

- IntelliLink audio system
 - 7-inch colour touchscreen
 - AM/FM/DAB digital radio
 - Bluetooth® audio streaming
 - Bluetooth® mobile phone portal
 - Apple CarPlay™ / Android Auto™
 - USB audio connection
- Six speakers (four front, two rear)

Interior convenience / styling:

- Air conditioning
- Multi-function trip computer
- Sports-style front seats
- Front centre armrest
- Storage pockets on front seat backs
- Cruise control with speed limiter
- Steering wheel audio / phone / cruise controls
- Sport switch (not available on 1.4i (100PS) models)
- Steering column adjustable for reach / rake

Exterior convenience / styling:

- 17-inch five twin-spoke alloy wheels
- Chrome-effect upper window trim
- Rain-sensitive windscreen wipers
- Automatic lighting with tunnel detection
- Automatic anti-dazzle rear-view mirror
- Front fog lights
- Remote control central locking
- Electrically operated front / rear windows
- Electrically adjustable/heated door mirrors
- Silver-effect roof rails (Sports Tourer)

Safety / security:



- Driving Assistance Pack One featuring intelligent forward camera system
- Electronic Stability Programme (ESP)
- Anti-lock Braking System (ABS)
- Six airbags
- Hill start assist
- ISOFIX child seat mounting points
- Seatbelt pretensioners for front / outer rear seats
- Tyre pressure monitoring system
- LED daytime running lights
- Remote control alarm system (optional at extra cost on 1.4i (100PS) models)
- Electronic engine deadlock immobiliser

SRi Nav models additional feature:

- Navi 900 IntelliLink system
 - Fully integrated European sat nav system
 - 8-inch colour touchscreen

CUSTOMER OFFERS*

Please consult your Retailer for details.

-  **0% Flexible Finance**
-  **Flexible PCP (3.7% APR) with £2000 Vauxhall Deposit Contribution**
-  **Flexible Personal Lease**

COMPANY CAR INFORMATION

Please see www.vauxhall.co.uk/feet for details.

-  **P11D price starting at £18,460**
-  **From 17% tax band** / £55 monthly BiK tax****
-  **CO₂ emissions from 91g/km**

* = Terms and conditions apply.





** = 2016/17 tax year.

ASTRA SRi VX-LINE

		Hatchback		Sports Tourer	
		OTR RRP	CO ₂ (g/km)	OTR RRP	CO ₂ (g/km)
ASTRA SRi VX-LINE – ON-THE-ROAD PRICES					
Petrol	1.4i Turbo (150PS)	£20,715	128	-	-
	1.4i Turbo (150PS) S/S auto	£22,115	127	-	-
	1.6i Turbo (200PS) S/S	£22,255	141	-	-
Diesel	1.6CDTi (110PS)	£21,415	97	-	-
	1.6CDTi (136PS) S/S	£22,600	103	-	-
	1.6CDTi (136PS) auto	£23,920	119	-	-
	1.6CDTi BiTurbo (160PS) S/S	£23,215	109	-	-

ASTRA SRi VX-LINE NAV – ON-THE-ROAD PRICES					
Petrol	1.4i Turbo (150PS)	£21,415	128	-	-
	1.4i Turbo (150PS) S/S auto	£22,815	127	-	-
	1.6i Turbo (200PS) S/S	£22,955	141	-	-
Diesel	1.6CDTi (110PS)	£22,115	97	-	-
	1.6CDTi (136PS) S/S	£23,300	103	-	-
	1.6CDTi (136PS) auto	£24,620	119	-	-
	1.6CDTi BiTurbo (160PS) S/S	£23,915	109	-	-

Please note: On-the-road recommended retail prices (RRP) include VAT at 20%, number plates and delivery to Retailer of £700.00 (inc. £116.67 VAT), 12 months' Vehicle Excise Duty and new vehicle first registration fee of £55.00. Excludes fuel and insurance. S/S = Start/Stop.

ASTRA SRi VX-LINE – KEY OPTIONS			Total inc. VAT
	Looking good:	Brilliant paint	£285
		Metallic / pearlescent paint	£555
	Easier parking:	Parking Pack <i>Front and rear parking distance sensors / advance park assist / side blind spot alert / rear-view camera</i>	£615
		Front and rear parking distance sensors	£460
	Sitting comfortably:	Ergonomic driver's sport-style seat	£260
		Winter Pack Heated leather-covered steering wheel / heated front seats	£355
	Fresh air:	Power tilt and slide sunroof	£510
		Electronic climate control	£405
	Driving assistance:	IntelliLux LED Matrix headlights	£1250
		LED tail lights (standard with IntelliLux LED Matrix headlights)	£205

For details of these and other options please see Features/Options pages.



ASTRA SRi VX-LINE – FEATURES

Vauxhall OnStar:

- Automatic crash response / Wi-Fi hotspot / smartphone app / stolen vehicle assistance / vehicle diagnostics

Infotainment:

- IntelliLink audio system
 - 7-inch colour touchscreen
 - AM/FM/DAB digital radio
 - Bluetooth® audio streaming
 - Bluetooth® mobile phone portal
 - Apple CarPlay™ / Android Auto™
 - USB audio connection

- Six speakers (four front, two rear)

Interior convenience / styling:

- Air conditioning
- Multi-function trip computer
- Sports-style front seats
- Front centre armrest
- Storage pockets on front seat backs
- Cruise control with speed limiter
- Steering wheel audio / phone / cruise controls
- Sport switch
- Steering column adjustable for reach / rake

Exterior convenience / styling:

- 18-inch five twin-spoke alloy wheels
- Body-colour front lower spoiler / side sills / rear lower skirt
- Chrome-effect upper window trim
- Rain-sensitive windscreen wipers
- Automatic lighting with tunnel detection
- Automatic anti-dazzle rear-view mirror
- Remote control central locking
- Electrically operated front and rear windows
- Electrically adjustable/heated door mirrors

Safety / security:



- Driving Assistance Pack One featuring intelligent forward camera system
- Electronic Stability Programme (ESP)
- Anti-lock Braking System (ABS)
- Six airbags
- Hill start assist
- ISOFIX child seat mounting points
- Seatbelt pretensioners for front / outer rear seats
- Tyre pressure monitoring system
- LED daytime running lights
- Remote control alarm system
- Electronic engine deadlock immobiliser

SRi VX-Line Nav models additional feature:

- Navi 900 IntelliLink system
 - Fully integrated European sat nav system
 - 8-inch colour touchscreen

CUSTOMER OFFERS*



Please consult your Retailer for details.

-  **0% Flexible Finance**
-  **Flexible PCP (3.7% APR) with £2000 Vauxhall Deposit Contribution**
-  **Flexible Personal Lease**

* = Terms and conditions apply.

COMPANY CAR INFORMATION

Please see www.vauxhall.co.uk/fleet for details.

-  **P11D price starting at £20,660**
-  **From 19% tax band** / £68 monthly BiK tax****
-  **CO₂ emissions from 97g/km**

** = 2016/17 tax year.

ASTRA ELITE

		Hatchback		Sports Tourer	
		OTR RRP	CO ₂ (g/km)	OTR RRP	CO ₂ (g/km)
ASTRA ELITE – ON-THE-ROAD PRICES					
<i>Petrol</i>	1.4i (100PS)	£19,235	128	£20,655	131
	1.0i Turbo (105PS) S/S ecoFLEX	£19,935	104	–	–
	1.4i Turbo (125PS)	–	–	£21,275	130
	1.4i Turbo (150PS)	£20,235	128	£21,525	130
	1.4i Turbo (150PS) S/S auto	£21,635	127	£22,925	128
	1.6i Turbo (200PS) S/S	£21,775	141	£23,065	142
<i>Diesel</i>	1.6CDTi (110PS)	£20,935	97	£22,225	99
	1.6CDTi (110PS) S/S ecoFLEX	£21,435	91	£22,725	92
	1.6CDTi (136PS) S/S	£22,120	103	£23,410	104
	1.6CDTi (136PS) auto	£23,440	119	£24,730	122
	1.6CDTi BiTurbo (160PS) S/S	£22,735	109	£24,025	109

		Hatchback		Sports Tourer	
		OTR RRP	CO ₂ (g/km)	OTR RRP	CO ₂ (g/km)
ASTRA ELITE NAV – ON-THE-ROAD PRICES					
<i>Petrol</i>	1.4i (100PS)	£19,935	128	£21,355	131
	1.0i Turbo (105PS) S/S ecoFLEX	£20,635	104	–	–
	1.4i Turbo (125PS)	–	–	£21,975	130
	1.4i Turbo (150PS)	£20,935	128	£22,225	130
	1.4i Turbo (150PS) S/S auto	£22,335	127	£23,625	128
	1.6i Turbo (200PS) S/S	£22,475	141	£23,765	142
<i>Diesel</i>	1.6CDTi (110PS)	£21,635	97	£22,925	99
	1.6CDTi (110PS) S/S ecoFLEX	£22,135	91	£23,425	92
	1.6CDTi (136PS) S/S	£22,820	103	£24,110	104
	1.6CDTi (136PS) auto	£24,140	119	£25,430	122
	1.6CDTi BiTurbo (160PS) S/S	£23,435	109	£24,725	109

Please note: On-the-road recommended retail prices (RRP) include VAT at 20%, number plates and delivery to Retailer of £700.00 (inc. £116.67 VAT), 12 months' Vehicle Excise Duty and new vehicle first registration fee of £55.00. Excludes fuel and insurance. S/S = Start/Stop.

ASTRA ELITE – KEY OPTIONS		Total inc. VAT
	Brilliant paint	£285
	Metallic / pearlescent paint	£555
	18-inch bi-colour alloy wheels	£405
	Parking Pack	
	Front and rear parking distance sensors / advance park assist / side blind spot alert / rear-view camera	£615
	Ergonomic sports-style front seats	£305
	Power tilt and slide sunroof	£510
	Driving Assistance Pack One	
	Forward collision alert with automatic city emergency braking / traffic sign recognition / following distance indicator / lane departure warning with lane assist	£575
	IntelliLux LED Matrix headlights	£1815

For details of these and other options please see Features/Options pages.



ASTRA ELITE – FEATURES

Vauxhall OnStar:

- Automatic crash response / Wi-Fi hotspot / smartphone app / stolen vehicle assistance / vehicle diagnostics

Infotainment:

- IntelliLink audio system
 - 7-inch colour touchscreen
 - AM/FM/DAB digital radio
 - Bluetooth® audio streaming
 - Bluetooth® mobile phone portal
 - Apple CarPlay™ / Android Auto™
 - USB audio connection
- Six speakers (four front, two rear)

Interior convenience / styling:

- Leather seat trim
- Electronic dual-zone climate control
- Heated leather-covered steering wheel
- Heated front / outer rear seats
- Sports-style front seats
- Four-way electrical lumbar adjustment
- Adjustable front armrest
- Front centre armrest
- Multi-function trip computer
- Steering wheel audio / phone / cruise controls
- Electric parking brake
- Cruise control with speed limiter
- Two rear USB charging points

Exterior convenience / styling:

- 17-inch multi-spoke alloy wheels
- Chrome-effect upper window trim
- Rain-sensitive windscreen wipers
- Automatic lighting control with tunnel detection
- Automatic anti-dazzle rear-view mirror
- Front fog lights
- Remote control central locking
- Electrically operated front / rear windows
- Electrically adjustable / heated / folding door mirrors
- Silver-effect roof rails (Sports Tourer)

Safety / security:

- Electronic Stability Programme (ESP)
- Anti-lock Braking System (ABS)
- Six airbags
- Remote control alarm system
- Hill start assist
- ISOFIX child seat mounting points on outer rear seats
- Seatbelt pretensioners for front / outer rear seats
- Electronic engine deadlock immobiliser
- Tyre pressure monitoring system
- Door-to-door illumination
- LED daytime running lights

Elite Nav models additional feature:

- Navi 900 IntelliLink system
 - Fully integrated European sat nav system
 - 8-inch colour touchscreen

CUSTOMER OFFERS*

Please consult your Retailer for details.

- 0% Flexible Finance**
- Flexible PCP (3.7% APR) with £2000 Vauxhall Deposit Contribution**
- Flexible Personal Lease**

* = Terms and conditions apply.





COMPANY CAR INFORMATION

Please see www.vauxhall.co.uk/fleet for details.

- P11D price starting at £19,880**
- From 17% tax band** / £57 monthly BiK tax****
- CO₂ emissions from 91g/km**

** = 2016/17 tax year.

ASTRA PRICES





Model 5-door hatchback	Price (£)	VAT (£)	Total (£)	On-the-road RRP (£)	CO ₂ (g/km)	Model 5-door hatchback	Price (£)	VAT (£)	Total (£)	On-the-road RRP (£)	CO ₂ (g/km)
DESIGN						SRI NAV VAUXHALL 					
1.4i (100PS)	12633.33	2526.67	15160.00	15915.00	124	1.4i (100PS)	15383.33	3076.67	18460.00	19215.00	128
1.0i Turbo (105PS) S/S ecoFLEX	13216.67	2643.33	15860.00	16615.00	102	1.0i Turbo (105PS) S/S ecoFLEX	15966.67	3193.33	19160.00	19915.00	104
1.0i Turbo (105PS) S/S ecoFLEX Easytronic	13550.00	2710.00	16260.00	17015.00	102	1.4i Turbo (150PS)	16216.67	3243.33	19460.00	20215.00	128
1.4i Turbo (125PS)	13258.33	2651.67	15910.00	16665.00	124	1.4i Turbo (150PS) S/S auto	17383.33	3476.67	20860.00	21615.00	127
1.4i Turbo (150PS) S/S auto	14633.33	2926.67	17560.00	18315.00	124	1.6i Turbo (200PS) S/S	17379.17	3475.83	20855.00	21755.00	141
<i>Diesel</i>						<i>Diesel</i>					
1.6CDTi (110PS)	14050.00	2810.00	16860.00	17615.00	95	1.6CDTi (110PS)	16800.00	3360.00	20160.00	20915.00	97
1.6CDTi (110PS) S/S ecoFLEX	14466.67	2893.33	17360.00	18115.00	88	1.6CDTi (110PS) S/S ecoFLEX	17216.67	3443.33	20660.00	21415.00	91
1.6CDTi (136PS) S/S	15037.50	3007.50	18045.00	18800.00	99	1.6CDTi (136PS) S/S	17787.50	3557.50	21345.00	22100.00	103
1.6CDTi (136PS) auto	16137.50	3227.50	19365.00	20120.00	115	1.6CDTi (136PS) auto	18887.50	3777.50	22665.00	23420.00	119
TECH LINE						1.6CDTi BiTurbo (160PS) S/S					
1.4i (100PS)	13216.67	2643.33	15860.00	16615.00	124	SRI VX-LINE VAUXHALL 					
1.0i Turbo (105PS) S/S ecoFLEX	13800.00	2760.00	16560.00	17315.00	102	1.4i Turbo (150PS)	16633.33	3326.67	19960.00	20715.00	128
1.4i Turbo (125PS)	13841.67	2768.33	16610.00	17365.00	124	1.4i Turbo (150PS) S/S auto	17800.00	3560.00	21360.00	22115.00	127
1.4i Turbo (150PS) S/S auto	15216.67	3043.33	18260.00	19015.00	124	1.6i Turbo (200PS) S/S	17795.83	3559.17	21355.00	22255.00	141
<i>Diesel</i>						<i>Diesel</i>					
1.6CDTi (110PS)	14633.33	2926.67	17560.00	18315.00	95	1.6CDTi (110PS)	17216.67	3443.33	20660.00	21415.00	97
1.6CDTi (110PS) S/S ecoFLEX	15050.00	3010.00	18060.00	18815.00	88	1.6CDTi (136PS) S/S	18204.17	3640.83	21845.00	22600.00	103
1.6CDTi (136PS) S/S	15620.83	3124.17	18745.00	19500.00	99	1.6CDTi (136PS) auto	19304.17	3860.83	23165.00	23920.00	119
1.6CDTi (136PS) auto	16720.83	3344.17	20065.00	20820.00	115	1.6CDTi BiTurbo (160PS) S/S	18716.67	3743.33	22460.00	23215.00	109
ENERGY						SRI VX-LINE NAV VAUXHALL 					
1.4i (100PS)	14300.00	2860.00	17160.00	17915.00	128	1.4i Turbo (150PS)	17216.67	3443.33	20660.00	21415.00	128
1.0i Turbo (105PS) S/S ecoFLEX	14883.33	2976.67	17860.00	18615.00	104	1.4i Turbo (150PS) S/S auto	18383.33	3676.67	22060.00	22815.00	127
1.4i Turbo (125PS)	14925.00	2985.00	17910.00	18665.00	128	1.6i Turbo (200PS) S/S	18379.17	3675.83	22055.00	22955.00	141
<i>Diesel</i>						<i>Diesel</i>					
1.6CDTi (110PS)	15716.67	3143.33	18860.00	19615.00	97	1.6CDTi (110PS)	17800.00	3560.00	21360.00	22115.00	97
SRI VAUXHALL 						1.6CDTi (136PS) S/S					
1.4i (100PS)	14800.00	2960.00	17760.00	18515.00	128	1.6CDTi (136PS) auto	18787.50	3757.50	22545.00	23300.00	103
1.0i Turbo (105PS) S/S ecoFLEX	15383.33	3076.67	18460.00	19215.00	104	1.6CDTi (136PS) auto	19887.50	3977.50	23865.00	24620.00	119
1.4i Turbo (150PS)	15633.33	3126.67	18760.00	19515.00	128	1.6CDTi BiTurbo (160PS) S/S	19300.00	3860.00	23160.00	23915.00	109
1.4i Turbo (150PS) S/S auto	16800.00	3360.00	20160.00	20915.00	127	Please note: On-the-road recommended retail prices (RRP) include number plates and delivery to Retailer of £700.00 (inc. £116.67 VAT), 12 months' Vehicle Excise Duty and new vehicle first registration fee of £55.00. Excludes fuel and insurance.					
1.6i Turbo (200PS) S/S	16795.83	3359.17	20155.00	21055.00	141	S/S = Start/Stop.					
<i>Diesel</i>											
1.6CDTi (110PS)	16216.67	3243.33	19460.00	20215.00	97						
1.6CDTi (110PS) S/S ecoFLEX	16633.33	3326.67	19960.00	20715.00	91						
1.6CDTi (136PS) S/S	17204.17	3440.83	20645.00	21400.00	103						
1.6CDTi (136PS) auto	18304.17	3660.83	21965.00	22720.00	119						
1.6CDTi BiTurbo (160PS) S/S	17716.67	3543.33	21260.00	22015.00	109						

ASTRA PRICES

Model 5-door hatchback	Price (£)	VAT (£)	Total (£)	On-the-road RRP (£)	CO ₂ (g/km)
ELITE VAUXHALL OnStar					
1.4i (100PS)	15400.00	3080.00	18480.00	19235.00	128
1.0i Turbo (105PS) S/S ecoFLEX	15983.33	3196.67	19180.00	19935.00	104
1.4i Turbo (150PS)	16233.33	3246.67	19480.00	20235.00	128
1.4i Turbo (150PS) S/S auto	17400.00	3480.00	20880.00	21635.00	127
1.6i Turbo (200PS) S/S	17395.83	3479.17	20875.00	21775.00	141
<i>Diesel</i>					
1.6CDTi (110PS)	16816.67	3363.33	20180.00	20935.00	97
1.6CDTi (110PS) S/S ecoFLEX	17233.33	3446.67	20680.00	21435.00	91
1.6CDTi (136PS) S/S	17804.17	3560.83	21365.00	22120.00	103
1.6CDTi (136PS) auto	18904.17	3780.83	22685.00	23440.00	119
1.6CDTi BiTurbo (160PS) S/S	18316.67	3663.33	21980.00	22735.00	109
ELITE NAV VAUXHALL OnStar					
1.4i (100PS)	15983.33	3196.67	19180.00	19935.00	128
1.0i Turbo (105PS) S/S ecoFLEX	16566.67	3313.33	19880.00	20635.00	104
1.4i Turbo (150PS)	16816.67	3363.33	20180.00	20935.00	128
1.4i Turbo (150PS) S/S auto	17983.33	3596.67	21580.00	22335.00	127
1.6i Turbo (200PS) S/S	17979.17	3595.83	21575.00	22475.00	141
<i>Diesel</i>					
1.6CDTi (110PS)	17400.00	3480.00	20880.00	21635.00	97
1.6CDTi (110PS) S/S ecoFLEX	17816.67	3563.33	21380.00	22135.00	91
1.6CDTi (136PS) S/S	18387.50	3677.50	22065.00	22820.00	103
1.6CDTi (136PS) auto	19487.50	3897.50	23385.00	24140.00	119
1.6CDTi BiTurbo (160PS) S/S	18900.00	3780.00	22680.00	23435.00	109

Please note: On-the-road recommended retail prices (RRP) include number plates and delivery to Retailer of £700.00 (inc. £116.67 VAT).
12 months' Vehicle Excise Duty and new vehicle first registration fee of £55.00. Excludes fuel and insurance.
S/S = Start/Stop.

ASTRA PRICES

Model Sports Tourer	Price (£)	VAT (£)	Total (£)	On-the-road RRP (£)	CO ₂ (g/km)	Model Sports Tourer	Price (£)	VAT (£)	Total (£)	On-the-road RRP (£)	CO ₂ (g/km)
DESIGN						SRI NAV VAUXHALL 					
1.4i (100PS)	13708.33	2741.67	16450.00	17205.00	127	1.4i (100PS)	16458.33	3291.67	19750.00	20635.00	131
1.0i Turbo (105PS) S/S ecoFLEX	14291.67	2858.33	17150.00	17905.00	103	1.4i Turbo (125PS)	17083.33	3416.67	20500.00	21255.00	130
1.4i Turbo (125PS)	14333.33	2866.67	17200.00	17955.00	127	1.4i Turbo (150PS)	17291.67	3458.33	20750.00	21505.00	130
<i>Diesel</i>						1.4i Turbo (150PS) S/S auto	18458.33	3691.67	22150.00	22905.00	128
1.6CDTi (110PS)	15125.00	3025.00	18150.00	18905.00	96	1.6i Turbo (200PS) S/S	18454.17	3690.83	22145.00	23045.00	142
1.6CDTi (110PS) S/S ecoFLEX	15541.67	3108.33	18650.00	19405.00	89	<i>Diesel</i>					
1.6CDTi (136PS) S/S	16112.50	3222.50	19335.00	20090.00	101	1.6CDTi (110PS)	17875.00	3575.00	21450.00	22205.00	99
1.6CDTi (136PS) auto	17212.50	3442.50	20655.00	21410.00	119	1.6CDTi (110PS) S/S ecoFLEX	18291.67	3658.33	21950.00	22705.00	92
TECH LINE						1.6CDTi (136PS) S/S	18862.50	3772.50	22635.00	23390.00	104
1.4i (100PS)	14291.67	2858.33	17150.00	17905.00	127	1.6CDTi (136PS) auto	19962.50	3992.50	23955.00	24710.00	122
1.0i Turbo (105PS) S/S ecoFLEX	14875.00	2975.00	17850.00	18605.00	103	1.6CDTi BiTurbo (160PS) S/S	19375.00	3875.00	23250.00	24005.00	109
1.4i Turbo (125PS)	14916.67	2983.33	17900.00	18655.00	127	ELITE VAUXHALL 					
<i>Diesel</i>						1.4i (100PS)	16475.00	3295.00	19770.00	20655.00	131
1.6CDTi (110PS)	15708.33	3141.67	18850.00	19605.00	96	1.4i Turbo (125PS)	17100.00	3420.00	20520.00	21275.00	130
1.6CDTi (110PS) S/S ecoFLEX	16125.00	3225.00	19350.00	20105.00	89	1.4i Turbo (150PS)	17308.33	3461.67	20770.00	21525.00	130
1.6CDTi (136PS) S/S	16695.83	3339.17	20035.00	20790.00	101	1.4i Turbo (150PS) S/S auto	18475.00	3695.00	22170.00	22925.00	128
1.6CDTi (136PS) auto	17795.83	3559.17	21355.00	22110.00	119	1.6i Turbo (200PS) S/S	18470.83	3694.17	22165.00	23065.00	142
SRI VAUXHALL 						<i>Diesel</i>					
1.4i (100PS)	15875.00	3175.00	19050.00	19935.00	131	1.6CDTi (110PS)	17891.67	3578.33	21470.00	22225.00	99
1.4i Turbo (125PS)	16500.00	3300.00	19800.00	20555.00	130	1.6CDTi (110PS) S/S ecoFLEX	18308.33	3661.67	21970.00	22725.00	92
1.4i Turbo (150PS)	16708.33	3341.67	20050.00	20805.00	130	1.6CDTi (136PS) S/S	18879.17	3775.83	22655.00	23410.00	104
1.4i Turbo (150PS) S/S auto	17875.00	3575.00	21450.00	22205.00	128	1.6CDTi (136PS) auto	19979.17	3995.83	23975.00	24730.00	122
1.6i Turbo (200PS) S/S	17870.83	3574.17	21445.00	22345.00	142	1.6CDTi BiTurbo (160PS) S/S	19391.67	3878.33	23270.00	24025.00	109
<i>Diesel</i>						ELITE NAV VAUXHALL 					
1.6CDTi (110PS)	17291.67	3458.33	20750.00	21505.00	99	1.4i (100PS)	17058.33	3411.67	20470.00	21355.00	131
1.6CDTi (110PS) S/S ecoFLEX	17708.33	3541.67	21250.00	22005.00	92	1.4i Turbo (125PS)	17683.33	3536.67	21220.00	21975.00	130
1.6CDTi (136PS) S/S	18279.17	3655.83	21935.00	22690.00	104	1.4i Turbo (150PS)	17891.67	3578.33	21470.00	22225.00	130
1.6CDTi (136PS) auto	19379.17	3875.83	23255.00	24010.00	122	1.4i Turbo (150PS) S/S auto	19058.33	3811.67	22870.00	23625.00	128
1.6CDTi BiTurbo (160PS) S/S	18791.67	3758.33	22550.00	23305.00	109	1.6i Turbo (200PS) S/S	19054.17	3810.83	22865.00	23765.00	142
						<i>Diesel</i>					
						1.6CDTi (110PS)	18475.00	3695.00	22170.00	22925.00	99
						1.6CDTi (110PS) S/S ecoFLEX	18891.67	3778.33	22670.00	23425.00	92
						1.6CDTi (136PS) S/S	19462.50	3892.50	23355.00	24110.00	104
						1.6CDTi (136PS) auto	20562.50	4112.50	24675.00	25430.00	122
						1.6CDTi BiTurbo (160PS) S/S	19975.00	3995.00	23970.00	24725.00	109

Please note: On-the-road recommended retail prices (RRP) include number plates and delivery to Retailer of £700.00 (inc. £116.67 VAT), 12 months' Vehicle Excise Duty and new vehicle first registration fee of £55.00. Excludes fuel and insurance.
S/S = Start/Stop.

ASTRA FEATURES/OPTIONS

SAFETY

Driver / passenger airbags

- Driver's airbag • Front passenger's airbag • Two front seat side-impact airbags
- Full-size curtain airbags for driver and front and outer rear seat passengers

Seating

- Height-adjustable front seat head restraints • Three height adjustable rear seat head restraints
- Anti-submarining ramps in all seats – Prevents occupants sliding underneath the lap belt during a collision

Seatbelts

- Height adjustable front inertia-reel lap and diagonal seatbelts • Three inertia-reel lap and diagonal rear seatbelts • Front and outer rear seatbelt pretensioner system – Pretensioners tighten the seatbelt in the event of an accident limiting forward movement • Front and outer rear seatbelt force limiters – Reduces potential upper body injuries during a frontal impact • Front and rear 'seatbelt unfastened' audible warning and warning light

Child safety

- Deactivation switch for front passenger's airbag – Permits the safe use of a child seat in the front passenger seat • ISOFIX child seat mountings incorporating top tether anchor points located on outer rear seats (does not include child seat) – Allows ISOFIX child safety seats to be securely fixed into the car. The ISOFIX mounting system reduces forward movement in an accident and makes the child seat easier to install • Child-proof locks on rear doors

Driver / passenger safety

- Energy-absorbing steering column • Pedal release system – Reduces potential injury to the driver's legs and feet during a severe frontal impact • Laminated windscreen • Side-impact protection beams • Reinforced passenger safety cell • Deformation zones front and rear
- Burst-proof door locks and anti-jam door design

Pedestrian safety

- Bonnet / headlight / wiper structure – Designed to reduce pedestrian head and upper body injuries
- Upper and lower bumper design – Reduces upper and lower leg injuries

Stability

Electronic Stability Programme (ESP):

– Works in conjunction with the vehicle's electronic braking and engine systems to keep the car stable in many different situations. ESP monitors many different inputs to determine when the car starts to lose traction, it can then immediately respond by varying the brake pressure between up to three wheels and adjust the engine output to help correct the loss of traction and improve stability.

Additional ESP features:

- Traction control • Cornering brake control • Straight line stability control • Rollover mitigation • Drag torque control – Maintain stability on slippery roads when lifting off the accelerator or changing gear

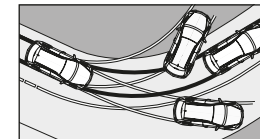

Braking

Anti-lock Braking System (ABS):

– Prevents the vehicle's wheels from locking up under heavy braking by momentarily reducing brake pressure at the appropriate wheel, ensuring that you can maintain control of the steering

Additional braking features:

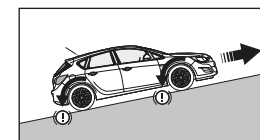

- The same electronic systems used in the ABS and ESP also deliver exceptional braking performance
- Emergency brake assist – When emergency braking is detected the vehicle automatically applies the maximum possible braking assistance • Fading brake support – Compensates for the effects of brake fade • Electronic brakeforce distribution – Automatically apportions the optimum braking force to each wheel • Adaptive brake lights – Automatically warns other road users of heavy braking • Hill start assist – Briefly maintains rear brake pressure to stop the vehicle rolling back on an incline • Hazard warning lights



Tyre pressure



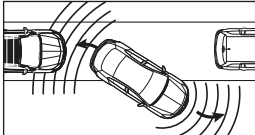
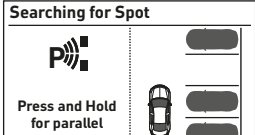
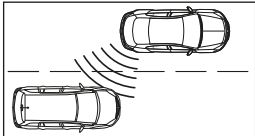

- Tyre pressure monitoring system

ASTRA FEATURES/OPTIONS

DRIVER ASSISTANCE		Design	Tech Line	Energy	SRi	SRi VX-Line	Elite	Price (£) exc. VAT	Total (£) inc. VAT
<p>Cruise control with speed limiter Cruise control enables you to maintain a constant speed – making it ideal for economical motorway driving. The speed limiter function can be set to ensure that you do not exceed the speed limit and can be easily overridden if required.</p> <ul style="list-style-type: none"> Steering wheel mounted controls 		●	●	●	●	●	●		
<p>Front and rear parking distance sensors (not available with Parking Pack)</p> <ul style="list-style-type: none"> Front and rear parking distance sensors (Design and Energy models upgraded to six speakers) Audible warning • Distance warning graphic shown in driver information display <p>✓ Easier parking</p>		○	○	○	○	○	○	383.33	460.00
<p>Parking Pack (includes front and rear parking distance sensors) Intelligent ultrasonic sensors form part of the solution for today's crowded roads and car parks – delivering exceptional assistance both when parking and protecting you on the open road.</p> <p>Advanced park assist: Advanced park assist not only detects suitable parking spaces but also expertly steers into them for you. All you have to do is to drive forward or reverse. The system works with both parallel and bay parking.</p> <ul style="list-style-type: none"> Ultrasonic side sensors with four-metre range • Ultrasonic front and rear parking sensors with a two-metre range • Fully automated steering • Detailed forward/reverse instructions are shown in the instrument cluster <p>✓ Finds suitable parking spaces ✓ Auto steers into the parking space for you</p>									
<p>Side blind spot alert: Side blind spot alert helps prevent potential collisions with other vehicles 'hidden' in the vehicle's side blind spots. If a vehicle enters one of the blind spots a warning light illuminates in the relevant door mirror.</p> <ul style="list-style-type: none"> Ultrasonic side sensors with three-metre range • LED warning light in door mirrors Audible warning is sounded if the indicators are used and the system has detected another vehicle Electrically folding door mirrors (fitted as standard on Elite models) <p>✓ Warns of vehicles in your blind spot</p>					○	○	○	512.50	615.00
<p>Rear-view camera: The rear-view camera gives a clear view of the area behind your car and helps place the car perfectly, without needing to strain your neck.</p> <ul style="list-style-type: none"> Activated when reverse gear selected • Camera view appears in infotainment screen Rear bumper and one-metre grid lines shown as reference points <p>✓ See what's behind you on the central screen</p>									
<p>Sport switch (not available on 1.4i (100PS) models) Enables the driver to change the steering feel and throttle response for a sportier driving style.</p> <ul style="list-style-type: none"> Facia mounted sport switch 					●	●			

● = Standard equipment. ○ = Optional at extra cost.

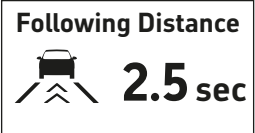
ASTRA FEATURES/OPTIONS

	Design	Tech Line	Energy	SRi	SRi VX-Line	Elite	Price (£) exc. VAT	Total (£) inc. VAT
<p>DRIVER ASSISTANCE</p> <p>Electric parking brake</p> <ul style="list-style-type: none"> Centre console switch in lieu of handbrake lever Premium centre console featuring adjustable armrest 				○	○	●	195.83	235.00
<p>Driving Assistance Pack One</p> <p><i>A wide range of class-leading driver assistance and safety features are controlled by the front camera system</i></p> <p>Forward collision alert with automatic city emergency braking:</p> <p><i>In certain circumstances and at speeds above 5mph warns when approaching another vehicle too quickly. At speeds above 5mph and up to 53mph the system provides additional braking support to help the driver brake more quickly and effectively in an emergency situation. At speeds above 5mph and up to 37mph if no avoiding action is taken by the driver, the system automatically slows the vehicle with emergency braking.</i></p> <ul style="list-style-type: none"> Visual warnings – projected onto windscreen and shown in the instrument cluster Audible warning Additional braking support Low speed collision mitigation braking <p>✔ Warns you of potential accidents</p> 								
<p>Traffic sign recognition:</p> <p><i>Detects and then displays speed limits, reducing uncertainty and the risk of speeding.</i></p> <ul style="list-style-type: none"> Recognises different road signs, including temporary speed restrictions Displays reminder in the driver information centre <p>✔ Always know the speed limit</p> 								
<p>Following distance indicator:</p> <p><i>Indicates how many seconds you are behind the vehicle in front – helping you maintain a safe distance.</i></p> <ul style="list-style-type: none"> Timings are shown in the driver information centre <p>✔ Keeps a safe distance</p> 	○	○	○	●	●	○	670.83	805.00
<p>Lane departure warning with lane assist:</p> <p><i>If the driver has not actively steered or signalled, the lane departure warning system warns when the car moves outside of lane markings at speeds above 35mph. The lane keep assist function additionally provides gentle steering correction to help drivers keep in their lane if no active inputs are made.</i></p> <ul style="list-style-type: none"> Warning light in the instrument cluster Audible warning Steering wheel 'nudge' warning Facia on / off switch Both systems switch to standby when in road works or when road markings are confused <p>Please note: Design, Tech Line and Energy models are upgraded to include</p> <ul style="list-style-type: none"> Twin front reading lights with illuminated switches Twin rear reading lights with illuminated switches Ambient LED facia/centre console downlighter Driver's and front passenger's illuminated vanity mirrors with flip-up covers Automatic lighting control with tunnel detection Automatically dimming anti-dazzle rear-view mirror Rain-sensitive windscreen wipers <p>✔ Keeps you in lane</p> 								
<p>Steering</p> <ul style="list-style-type: none"> Speed sensitive electrically assisted power steering 	●	●	●	●	●	●		

● = Standard equipment. ○ = Optional at extra cost.

ASTRA FEATURES/OPTIONS

	Design	Tech Line	Energy	SRi	SRi VX-Line	Elite	Price (£) exc. VAT	Total (£) inc. VAT
SECURITY								
Standard security features <ul style="list-style-type: none"> • 'Key left in ignition' audible warning • Electronically protected audio equipment • Engine deadlock immobiliser • Visible Vehicle Identification Number (VIN) • Locking wheel bolts for alloy wheels • Freewheeling door locks 	●	●	●	●	●	●		
Remote control central locking <ul style="list-style-type: none"> • Operates on doors, tailgate and fuel filler flap • Deadlocking • Central locking activation switch on facia • One folding key / one static key each with integral remote control function 	●	●	●	●	●	●		
Remote control ultrasonic security alarm system <ul style="list-style-type: none"> • Remote control (operates in conjunction with central locking) • Ultrasonic interior sensors • Tilt sensor • Thatcham approved <p><i>Please note:</i> Design, Tech Line and Energy models are upgraded to include</p> <ul style="list-style-type: none"> • Twin front reading lights with illuminated switches • Twin rear reading lights with illuminated switches • Ambient LED facia / centre console downlighter • Driver's and front passenger's illuminated vanity mirrors with flip-up covers <p>Alarm system is standard on Tech Line 1.6CDTi (136PS) Start/Stop manual models, and optional on SRi 1.4i (100PS) models, standard on all other SRi models.</p>	○	○	○	●	●	●	216.67	260.00

DRIVER INFORMATION

Instrumentation <ul style="list-style-type: none"> • Speedometer • Rev counter • Digital fuel gauge with low fuel level warning light • Digital water temperature gauge with warning light • Shift-up/down indication light – <i>Indicates when to change gear for optimum fuel economy</i> 	●	●	●	●	●	●		
Driver information display (centrally located in instrument cluster) <ul style="list-style-type: none"> • Monochrome display (upgraded to colour on SRi Nav and Elite Nav models) • Displays trip computer data • Total mileage • Service-due indicator • Oil life • Tyre pressure monitoring system 	●	●	●	●	●	●		
Multi-function trip computer (displayed on driver information display) <ul style="list-style-type: none"> • Trip mileage • Vehicle range based on remaining fuel • Average speed • Average fuel economy • Instantaneous fuel economy • Driving time 	●	●	●	●	●	●		
Central facia display (format dependent on infotainment unit) <ul style="list-style-type: none"> • Audio information • Digital clock with automatic RDS time adjustment • Outside air temperature with ice warning function • Additional features dependent on infotainment unit (see infotainment for details) 	●	●	●	●	●	●		

● = Standard equipment. ○ = Optional at extra cost.

ASTRA FEATURES/OPTIONS

INTERIOR STYLING	Design	Tech Line	Energy	SRi	SRi VX-Line	Elite	Price (£) exc. VAT	Total (£) inc. VAT
Design interior décor <i>Steering wheel:</i> • Three-spoke design • Satin chrome-effect bezel <i>Facia and door trim:</i> • Black facia with Antelao Sand trim inserts • Instrument panel bar Polar Silver • Black door panels with black Atlantis cloth inserts • Polar Silver trim inserts on front doors • Chrome-effect interior door handles <i>Seat trim:</i> • Talino fabric seat trim inserts • Plain black fabric side bolsters and surrounds <i>Headlining:</i> • Titanium roof lining	●							
Tech Line / Energy interior décor <i>Steering wheel:</i> • Three-spoke design • Leather-covered with accent stitching • Satin chrome-effect bezel <i>Facia and door trim:</i> • Black facia with Antelao Sand trim inserts • Instrument panel bar Polar Silver • Black door panels with black Atlantis cloth inserts • Polar Silver trim inserts on front doors • Chrome-effect interior door handles <i>Seat trim:</i> • Talino fabric seat trim inserts • Plain black fabric side bolsters and surrounds <i>Headlining:</i> • Titanium roof lining		●	●					
SRi / SRi VX-Line interior décor <i>Steering wheel:</i> • Three-spoke design • Leather-covered with accent stitching • Satin chrome-effect bezel <i>Facia and door trim:</i> • Black facia with Piano black trim inserts • Instrument panel bar Piano Black • Silver air vent surrounds • Black door panels with black Atlantis cloth inserts • Piano black trim inserts on front doors • Chrome-effect interior door handles <i>Seat trim:</i> • Formula fabric seat trim inserts • Plain black fabric side bolsters and surrounds <i>Headlining:</i> • Black roof lining				●	●			
Elite interior décor with Siena leather seat trim <i>Steering wheel:</i> • Three-spoke design • Leather-covered with accent stitching • Satin chrome-effect bezel <i>Facia and door trim:</i> • Black facia with Piano black trim inserts • Instrument panel bar Satin Chrome • Silver air vent surrounds • Black door panels with black Leather-effect inserts • Piano black trim inserts on front doors • Chrome-effect interior door handles <i>Seat trim:</i> • Black Siena leather seat trim inserts • Black leather-effect side bolsters and surrounds <i>Headlining:</i> • Titanium roof lining <i>Front door sill covers:</i> • Alloy-effect						●		
Elite interior décor with Athena cloth seat trim (featuring comfort front seats in lieu of ergonomic sports front seats) <i>Steering wheel:</i> • Three-spoke design • Leather-covered with accent stitching • Satin chrome-effect bezel <i>Facia and door trim:</i> • Black facia with Coronado brown trim inserts • Instrument panel bar Satin Chrome • Silver air vent surrounds • Black door panels with light neutral cloth inserts • Coronado brown trim inserts on front doors • Chrome-effect interior door handles <i>Seat trim:</i> • Athena cloth seat trim inserts • Leather-effect side bolsters <i>Headlining:</i> • Titanium roof lining <i>Front door sill covers:</i> • Alloy-effect						N/C	No-cost option	

● = Standard equipment. N/C = No-cost option.

ASTRA FEATURES/OPTIONS

	Design	Tech Line	Energy	SRi	SRi VX-Line	Elite	Price (£) exc. VAT	Total (£) inc. VAT
Reach and rake adjustable steering	●	●	●	●	●	●		
Comfort front seats <i>Driver's seat (eight way adjustable):</i> • Height (up/down) • Reach (fore/aft) • Backrest recline (upright/incline) • Head restraint (up/down) <i>Front passenger's seat (six way adjustable):</i> • Reach (fore/aft) • Backrest (upright/recline) • Head restraint (up/down)	●	●	●					
Sports-style front seats <i>Driver's seat (eight way adjustable):</i> • Height (up/down) • Reach (fore/aft) • Backrest recline (upright/incline) • Head restraint (up/down) <i>Front passenger's seat (six way adjustable):</i> • Reach (fore/aft) • Backrest (upright/recline) • Head restraint (up/down)				●	●			
Ergonomic driver's sport-style seat (AGR-approved*) with sports-style front passenger seat featuring Formula cloth <i>Driver's seat (16-way adjustable):</i> • Height (up/down) • Reach (fore/aft) • Tilt (fore/aft) • Backrest (upright/recline) • Seat cushion extension (fore/aft) • Lumbar adjustment (four-way electrical) • Head restraint (up/down) <i>Front passenger's seat (six way adjustable):</i> • Reach (fore/aft) • Backrest (upright/recline) • Head restraint (up/down)	○	○		○	○		216.67	260.00
Sports-style front seats featuring Siena Leather <i>Driver's and front passenger's seat (12-way adjustable):</i> • Height (up/down) • Reach (fore/aft) • Backrest (upright/recline) • Lumbar adjustment (four-way electrical) • Head restraint (up/down) • Heated front and outer rear seats • Centre rear armrest						●		
Ergonomic sports-style front seats (AGR-approved*) – changes seat trim to perforated leather <i>Driver's and front passenger's seat (16-way adjustable):</i> • Height (up/down) • Reach (fore/aft) • Tilt (fore/aft) • Backrest (upright/recline) • Seat cushion extension (fore/aft) • Lumbar adjustment (four-way electrical) • Head restraint (up/down)						○	170.83	205.00
Power front driver's seat (Only available in conjunction with optional Ergonomic sports-style front seats) <i>Driver's seat additional features:</i> • Massage function via three air cushions • Active ventilation backrest/seat cushion • Electrically operated adjustment with seat memory function • Pneumatically adjustable backrest side bolsters <i>Front passenger's seat additional feature:</i> • Active ventilation backrest/seat cushion						○	420.83	505.00
Comfort front seats featuring two-tone Athena cloth/Morrocana seat trim • Athena cloth front and rear seats (available in Light Neutral) • Heated and leather-covered steering wheel • Heated front and outer rear seats <i>Driver's seat (eight way adjustable):</i> • Height (up/down) • Reach (fore/aft) • Backrest (upright/recline) • Head restraint (up/down) <i>Front passenger's seat (six way adjustable):</i> • Reach (fore/aft) • Backrest (upright/recline) • Head restraint (up/down)						N/C	No-cost option	
Rear seating • Three person layout • Three height-adjustable and removable head restraints • ISOFIX child seat mountings incorporating top tether anchor points located on outer rear seats (does not include child seat) – <i>Allows ISOFIX child safety seats to be securely fixed into the car. The ISOFIX mounting system reduces forward movement in an accident and makes the child seat easier to install</i> • Child-proof locks on rear doors	●	●	●	●	●	●		
• 60/40 split-folding rear seat back	●	●	●	●	●			
• 40/20/40 split-folding rear seat back • FlexFold rear seats with remote electrical release (Sports Tourer only) • Leather trim only						●		

● = Standard equipment. ○ = Optional at extra cost. N/C = No-cost option. * = AGR (The Campaign for Healthier Backs) is an independent centre of excellence for ergonomics, based in Germany.







ASTRA FEATURES/OPTIONS

INFOTAINMENT	Design	Tech Line	Energy	SRi	SRi VX-Line	Elite	Price (£) exc. VAT	Total (£) inc. VAT
R4.0 IntelliLink touchscreen infotainment system <i>For use with MP3 players, USB memory sticks, mobile phones and smartphone apps</i> Onboard features: • 7-inch colour touchscreen • DAB digital radio/AM/FM stereo radio with 36 station presets • RDS with Traffic Programme Media connections: • USB connection with iPod control • Bluetooth® A2DP audio streaming (Advanced Audio Distribution Profile) Mobile phone portal: • Bluetooth® connectivity • Handsfree calls via steering wheel controls • Vehicle microphone • Phone book access – <i>Contacts/last calls/missed calls etc. are mirrored on IntelliLink's display and are easily navigated using the touchscreen (features dependent on mobile phone)</i> Smartphone interface: • Apple CarPlay™ • Android Auto™ – <i>Smartphone projection that allows operations via voice command, touchscreen and buttons to control apps and music playback.</i>	●		●	●	●	●		
Navi 900 IntelliLink touchscreen navigation and infotainment system <i>For use with MP3 players, USB memory sticks, mobile phones and smartphone apps</i> Onboard features: • 8-inch colour touchscreen • DAB digital radio/AM/FM stereo radio with 36 station presets • RDS with Traffic Programme • 60 configurable favourites including contacts, addresses, playlists, radio stations and voice recognition • Six premium speakers Navigation features: • Satellite navigation system • 3D street level mapping • European coverage Media connections: • USB connection with iPod control • Bluetooth® A2DP audio streaming (Advanced Audio Distribution Profile) Mobile phone portal: • Bluetooth® connectivity • Handsfree calls via steering wheel controls • Vehicle microphone • Phone book access – <i>Contacts/last calls/missed calls etc. are mirrored on IntelliLink's display and are easily navigated using the touchscreen (features dependent on mobile phone)</i> Smartphone interface: • Apple CarPlay™ • Android Auto™ – <i>Smartphone projection that allows operations via voice command, touchscreen and buttons to control apps and music playback.</i>		●	○	▲	▲	▲	591.67	710.00
CD drive (only available in conjunction with Navi 900 IntelliLink)		○	○	○	○	○	112.50	135.00
Four speakers (front)	●		●					
Six speakers (four front, two rear)		●		●	●	●		
Steering wheel mounted audio controls for phone, music and cruise control	●	●	●	●	●	●		
Twin USB power sockets for rear seat passengers						●		

● = Standard equipment. ○ = Optional at extra cost. ▲ = Standard on Nav models, see pricing page for details.

ASTRA FEATURES/OPTIONS

INFOTAINMENT

	Design	Tech Line	Energy	SRi	SRi VX-Line	Elite	Price (£) exc. VAT	Total (£) inc. VAT
 <p>Automatic Crash Response</p>  <p>Wi-Fi Hotspot</p>  <p>Smartphone App</p>  <p>Stolen Vehicle Assistance</p>  <p>Vehicle Diagnostics</p> <p>Vauxhall OnStar – your personal on board assistant* <i>Many car brands talk about innovation as soon as they improve their cup holders but this innovative system, now available on selected models**, is revolutionary: 24/7, 365 days a year, Vauxhall OnStar puts you in touch with a trained advisor, not a machine. With OnStar you have access to a host of innovations, from Vehicle Diagnostics and Smartphone Function to a fully integrated 4G Wi-Fi Hotspot†. In the event of an accident, Vauxhall OnStar even automatically calls for help, for an incomparable feeling of safety.</i></p> <p><small>* = Includes 12 months of OnStar services from date of first registration and a 3 month/3 GB Wi-Fi free trial period (whichever comes first) effective from the date the customer accepts the nominated network operator Wi-Fi Ts&Cs. Destination download feature only operates on models fitted with Navi 900 IntelliLink satellite navigation system. Theft alert feature only operates on models fitted with security alarm system. ** = The OnStar Services require activation and are subject to mobile network coverage and availability. Wi-Fi Hotspot service requires account with nominated network operator. † = 4G is subject to mobile network coverage and availability. Charges apply after the free trial period. The OnStar subscription packages could be different from the services included in the free trial package. Check www.vauxhall.co.uk/onstar for terms and conditions, details of availability, coverage and charges.</small></p> 	○	○	○	●	●	●	337.50	405.00

● = Standard equipment. ○ = Optional at extra cost.

ASTRA FEATURES/OPTIONS

	Design	Tech Line	Energy	SRi	SRi VX-Line	Elite	Price (£) exc. VAT	Total (£) inc. VAT
HEATING AND VENTILATION Air conditioning <ul style="list-style-type: none"> • Air recirculation facility • Cabin particulate filter – <i>Removes dust, airborne particles and pollen</i> • Multi-speed fan • Illuminated controls • Rear floor heating ducts 	●	●	●	●	●			
Electronic climate control including air conditioning <ul style="list-style-type: none"> • Dual zone control – <i>Allowing different temperature settings for driver and front passenger</i> • Advanced predictive logic control system using sun and humidity sensors • Partial air recirculation – <i>Faster warm up/cool down</i> • Cabin particulate filter – <i>Removes dust, airborne particles and pollen</i> • Automatic air direction and fan speed with manual override • LCD temperature display • Illuminated controls • Rear floor heating ducts <div style="display: flex; justify-content: space-between;"> ✔ Set and forget temperature control ✔ Set different temperature for driver and front passenger </div>				○	○	●	337.50	405.00
Additional features <ul style="list-style-type: none"> • Four adjustable facia vents • Windscreen demist vents • Side window demist vents • Heated rear screen with timed cut-off 	●	●	●	●	●	●		
Winter Pack <ul style="list-style-type: none"> • Heated leather-covered steering wheel • Heated front seats – <i>Three temperature settings</i> <div style="display: flex; align-items: center;"> ✔ Warm welcome <div style="margin-left: 20px;">  </div> </div>			●	○	○		295.83	355.00
Winter Pack – Elite models <ul style="list-style-type: none"> • Heated leather-covered steering wheel • Heated front seats – <i>Three temperature settings</i> • Heated outer rear seats 						●		

● = Standard equipment. ○ = Optional at extra cost.

ASTRA FEATURES/OPTIONS

	Design	Tech Line	Energy	SRi	SRi VX-Line	Elite	Price (£) exc. VAT	Total (£) inc. VAT
INTERIOR CONVENIENCE/LIGHTING								
Convenience features • Front 12-volt electrical accessory socket • Driver's and front passengers sunvisors • Front passenger vanity mirror • Dipping rear-view mirror	●	●	●	●	●	●		
Automatically dimming anti-dazzle rear-view mirror				●	●	●		
Front centre armrest with storage		●		●	●	●		
PowerFlex bar • Power connector attached to the centre console	○	○	○	○	○	●	45.83	55.00
Smartphone holder for smartphones with maximum dimensions of up to 150mm x 73.5mm x 11mm (only available with optional PowerFlex bar, cable supplied is compatible with selected Android phones only)	○	○	○	○	○	○	41.67	50.00
Air Wellness fragrance diffuser (only available with optional PowerFlex bar)	○	○	○	○	○	○	41.67	50.00
Twin USB power sockets for rear seat passengers – each socket provides 2.1 amps at 5 volts						●		
Standard lighting • Central front courtesy light • Central rear courtesy light • Fade up/fade down	●	●	●	●	●	●		
Premium lighting • Twin front reading lights with illuminated switches • Twin rear reading lights with illuminated switches • Ambient LED fascia/centre console downlighter • Driver's and front passenger's illuminated vanity mirrors with flip-up covers • Ambient LED lighting in front doors				●	●	●		
Interior storage • Fold out storage box on driver's side lower fascia • Glovebox with lid • Front door pockets • Two drinks holders in centre console • Rear door pockets • Storage pockets on front seat backs	●	●	●	●	●	●		
Luggage area • Luggage compartment cover (Hatchback only) • Luggage compartment retractable cover (Sports Tourer) • Illuminated load area • Fully carpeted load area • Interior tailgate handle • Four load restraint lashing eyes • Twin gas-assisted tailgate struts	●	●	●	●	●	●		
Luggage compartment 12-volt electrical accessory socket (Sports Tourer)	●	●		●		●		
Fixing points for vertical load-restraining net (Sports Tourer only)	○	○		○		○	54.17	65.00
Vertical load-restraining net (Sports Tourer only) – requires fixing points for vertical load-restraining net	○	○		○		○	112.50	135.00
FlexOrganiser® Pack (Sports Tourer only) • FlexOrganiser® rails • 3D storage net • Side net pocket • Four side rail hooks	○	○		○		○	87.50	105.00

● = Standard equipment. ○ = Optional at extra cost.

ASTRA FEATURES/OPTIONS

	Design	Tech Line	Energy	SRi	SRi VX-Line	Elite	Price (£) exc. VAT	Total (£) inc. VAT
EXTERIOR LIGHTING								
Standard lighting features								
<ul style="list-style-type: none"> LED daytime running lights Automatic lighting control: <i>When the automatic lighting control is switched on, the system switches between daytime running lights and headlights automatically depending on external lighting conditions.</i> Halogen projector headlights LED side repeat indicators Lights-on audible warning: <i>When keys are removed and driver door opened an audible warning sounds to alert the lights have been left on.</i> Manual headlight beam levelling: <i>Use to adapt headlight range to the vehicle load to prevent dazzling.</i> High-level LED centre rear brake light Rear fog light Reversing light Hazard warning lights Door-to-door illumination: <i>Headlights illuminate the area for an adjustable time after leaving the vehicle</i> 	●	●	●	●	●	●		
<ul style="list-style-type: none"> Automatic lighting control with tunnel detection 				●	●	●		
Front fog lights				●		●		
IntelliLux LED Matrix headlights								
<p><i>IntelliLux LED Matrix headlights work with the Driving Assistance Pack One incorporating front camera system, to provide outstanding lighting performance and enhanced safety. Each headlight features a matrix of eight individual LED lights. These lights replace the main beam function and supplement the dipped beam function. Each LED illuminates a separate part of the road ahead meaning that by automatically switching lights on and off, illumination is varied to suit traffic and road conditions.</i></p> <p><i>The IntelliLux system calculates which LED lights are activated and deactivated using additional data such as ambient light conditions, vehicle speed, steering angle and when the indicators are used. For example, when the front camera system detects an oncoming vehicle, the individual LED lights that would dazzle the oncoming driver are automatically switched off and then switched back on once the vehicle has passed. All other areas remain fully illuminated. Studies shown that the enhanced roadside illumination of IntelliLux LED Matrix headlights gives the driver an extra 1.5 seconds of reaction time at 50mph.</i></p> <ul style="list-style-type: none"> Dipped beam: halogen projector headlights Main beam and dynamic lighting: 16 electronically controlled LED lights (eight per headlight) Driving Assistance Pack One incorporating front camera system Intelligent main beam control Automatic headlight levelling LED tail lights 								
				○	○		1041.67	1250.00
<ul style="list-style-type: none"> ✓ Smart headlights automatically adjust the shape of high beam ✓ No need to switch between high and low beam ✓ High beam is always glare free 						○	1512.50	1815.00
<p><i>Every type of driving environment has been considered:</i></p> <p>Urban light: <i>With street lighting and speeds up to 34mph, the system automatically enhances the dipped beam function.</i></p> <p>Highway light: <i>The system recognises when the car is on a dual carriageway or motorway. At higher speeds the light distribution on the right is reduced to minimise glare from the crash barriers.</i></p> <p>Country light: <i>As speeds increase, so does the lighting's performance.</i></p> <p>Static Cornering light: <i>At lower speeds corners and bends are illuminated to match steering inputs.</i></p> <p>Parking light: <i>When reversing, additional side-facing lights are activated in the headlights.</i></p> <p>Energy saving mode: <i>On Start/Stop models, the IntelliLux LED Matrix system goes into energy saving mode when the engine is automatically stopped.</i></p>								
LED tail lights: (standard with IntelliLux LED Matrix headlights)				○	○	○	170.83	205.00
<ul style="list-style-type: none"> ✓ Sharper – easier to be seen 								















● = Standard equipment. ○ = Optional at extra cost.

ASTRA FEATURES/OPTIONS

	Design	Tech Line	Energy	SRi	SRi VX-Line	Elite	Price (£) exc. VAT	Total (£) inc. VAT
EXTERIOR CONVENIENCE / STYLING								
Keyless entry and start • Two transmitter fobs • Engine Start/Stop button • Back-up key				○	○	○	337.50	405.00
Power tailgate • With under bumper release sensor (Sports Tourer only) – only available in conjunction with optional keyless entry and start				○		○	300.00	360.00
 Swipe foot under rear bumper								
Windscreen wipers • Two-speed windscreen wipers with variable intermittent wipe • Intermittent rear window wash/wipe	●	●	●	●	●	●		
• Rain-sensitive windscreen wipers				●	●	●		
Door mirrors • Twin electrically adjustable/heated door mirrors • Manually folding door mirrors	●	●	●	●	●			
• Electrically folding door mirrors						●		
Windows • Electrically operated front and rear windows with safety autoreverse and one-touch up/down facility • Heated rear window	●	●	●	●	●	●		
• Solar heat-absorbing windscreen • Tinted windows	●	●	●	●	●	●		
• Dark-tinted rear windows				○	○	○	237.50	285.00
Power tilt and slide sunroof • Manually operated sunblind • Sunroof can be closed remotely from outside of the vehicle Please note: On SRi and SRi VX-Line models the headliner changes from black to titanium. Design, Tech Line and Energy models are upgraded to include: • Twin front reading lights with illuminated switches • Driver's and front passenger's illuminated vanity mirrors with flip-up covers • Twin rear reading lights with illuminated switches	○	○	○	○	○	○	425.00	510.00
Roof rails (Sport Tourer) • Black	●	●						
• Silver-effect				●		●		
Towing Pack • Detachable tow bar • Trailer stability programme integrated into ESP system Please note: Not available with optional VXR Styling Pack on Elite models	○	○	○	○		○	445.83	535.00
Body styling • Chrome-effect front grille bar • Chrome-effect headlight detail • Body-colour door handles • Body-colour door mirrors	●	●	●	●	●	●		
• Chrome-effect upper window trim • Body-colour rear roof spoiler								
• Matt black B-pillars • Gloss black C-pillars	●	●	●					
• Gloss black B-pillars • Gloss black C-pillars				●	●	●		
VXR Styling Pack • Sports-style front and rear bumpers • Side sills Please note: Deletes front fog lights, not available with 1.0i Turbo (105PS) or 1.6CDTi (110PS) S/S ecoFLEX models. Not available with optional Towing Pack or Royal Blue, Flip Chip Silver, Soft Bronze and Granite Grey exterior colours					●	○	829.17	995.00

● = Standard equipment. ○ = Optional at extra cost.





ASTRA FEATURES/OPTIONS

EXTERIOR COLOURS		Design	Tech Line	Energy	SRi	SRi VX-Line	Elite	Price (£) exc. VAT	Total (£) inc. VAT
	Royal Blue <ul style="list-style-type: none"> • Solid paint • Folding key with Grey insert 	●	●	●	●		●		
	Summit White <ul style="list-style-type: none"> • Brilliant paint • Folding key with White insert 	○	○	○	○	○	○	237.50	285.00
	Lava Red <ul style="list-style-type: none"> • Brilliant paint • Folding key with Red insert 								
	Sovereign Silver <ul style="list-style-type: none"> • Two-coat metallic paint • Folding key with Grey insert 								
	Deep Sky Blue <ul style="list-style-type: none"> • Two-coat metallic paint • Folding key with Grey insert 								
	Mineral Black <ul style="list-style-type: none"> • Two-coat metallic paint • Folding key with Black insert 	○	○	○	○	○	○	462.50	555.00
	Flip Chip Silver <ul style="list-style-type: none"> • Two-coat metallic paint • Not available on SRi VX-Line models • Folding key with White insert 								
	Cosmic Grey <ul style="list-style-type: none"> • Two-coat metallic paint • Folding key with Grey insert 								
	Granite Grey <ul style="list-style-type: none"> • Two-coat metallic paint • Not available on SRi VX-Line models • Folding key with Black insert 	○	○		○	○	○	462.50	555.00
	Dark Caramel <ul style="list-style-type: none"> • Two-coat metallic paint • No-cost option on SRi VX-Line models • Folding key with Black insert 								
	Soft Bronze <ul style="list-style-type: none"> • Two-coat metallic paint • Not available on SRi VX-Line models • Folding key with Grey insert 								
	Emerald Green <ul style="list-style-type: none"> • Two-coat pearlescent paint • Folding key with Black insert 								

● = Standard equipment. ○ = Optional at extra cost.

The colours reproduced may vary slightly from the actual paint colour. As a result they should be used as a guide only. Your Vauxhall Retailer has a comprehensive display of our paint samples.



ASTRA FEATURES/OPTIONS

WHEELS AND TYRES		<i>Design</i>	<i>Tech Line</i>	<i>Energy</i>	<i>SRi</i>	<i>SRi VX-Line</i>	<i>Elite</i>	Price (£) exc. VAT	Total (£) inc. VAT
Steel emergency spare wheel (in lieu of emergency tyre inflation kit) Loadspace capacity is reduced.		○	○	○	○	○	○	91.67	110.00
Full-size 16-inch steel spare wheel (in lieu of emergency tyre inflation kit) Sports Tourer only, not available with optional 17-inch alloy wheels.		○	○					91.67	110.00
	16-inch alloy wheels <ul style="list-style-type: none"> • 205/55 R 16 tyres • Emergency tyre inflation kit (in lieu of spare wheel) 	●	●						
	16-inch structure wheels <ul style="list-style-type: none"> • 205/55 R 16 tyres • Emergency tyre inflation kit (in lieu of spare wheel) 	N/C	N/C					No-cost option	
	17-inch 10-spoke alloy wheels <ul style="list-style-type: none"> • 225/45 R 17 tyres • Emergency tyre inflation kit (in lieu of spare wheel) 	○	○	●				337.50	405.00
	17-inch five twin-spoke alloy wheels <ul style="list-style-type: none"> • 225/45 R 17 tyres • Emergency tyre inflation kit (in lieu of spare wheel) 				●				

● = Standard equipment. ○ = Optional at extra cost. N/C = No-cost option.



ASTRA FEATURES/OPTIONS

WHEELS AND TYRES

	Design	Tech Line	Energy	SRi	SRi VX-Line	Elite	Price (£) exc. VAT	Total (£) inc. VAT
 <p>17-inch multi-spoke alloy wheels</p> <ul style="list-style-type: none"> • 225/45 R 17 tyres • Emergency tyre inflation kit (in lieu of spare wheel) 						●		
 <p>18-inch bi-colour alloy wheels</p> <ul style="list-style-type: none"> • 225/40 R 18 tyres • Emergency tyre inflation kit (in lieu of spare wheel) • Not available with 1.4i (100PS), 1.0i Turbo (105PS) or 1.6CDTi (110PS) ecoFLEX engines 				○		○	337.50	405.00
 <p>18-inch five twin-spoke alloy wheels</p> <ul style="list-style-type: none"> • 225/40 R 18 tyres • Emergency tyre inflation kit (in lieu of spare wheel) • Not available with 1.4i (100PS), 1.0i Turbo (105PS) or 1.6CDTi (110PS) ecoFLEX engines 				○	●		400.00	480.00

● = Standard equipment. ○ = Optional at extra cost.

TYRE RATING

Tyre size	Fuel efficiency group	Wet grip performance	External noise	
			Measured (dB)	Group
205/55 R 16	B-C	A-C	70-71	
225/45 R 17	C	A-B	71	
225/40 R 18	E	B	70	

Tyre rating according to EU Regulation 1222/2009

ASTRA SPECIFICATIONS

PETROL ENGINES

	1.0i Turbo (105PS) with Start/Stop	1.4i (100PS) ECOTEC	1.4i Turbo (125PS)
Capacity	999cc	1399cc	1399cc
Maximum power	105PS (77kW) @ 5500rpm	100PS (74kW) @ 6000rpm	125PS (92kW) @ 4000-5600rpm
Maximum torque	170Nm (125 lb.ft.) @ 1800-4250rpm	130Nm (95 lb.ft.) @ 4300rpm	245Nm (180 lb.ft.) @ 2000-3500rpm
Configuration	3 cylinders, 4 valves per cylinder, double overhead camshafts	4 cylinders, 4 valves per cylinder, double overhead camshafts	4 cylinders, 4 valves per cylinder, double overhead camshafts
Fuel/induction system	Water-cooled turbocharger with intercooler. Variable Valve Timing (VVT). Central direct fuel injection	Naturally aspirated Variable Valve Timing (VVT). Multi-point sequential fuel injection	Water-cooled turbocharger with intercooler. Variable Valve Timing (VVT). Central direct fuel injection
Emission compliance	Euro 6	Euro 6	Euro 6
Service interval	20,000 miles or 1 year (whichever occurs sooner)	20,000 miles or 1 year (whichever occurs sooner)	20,000 miles or 1 year (whichever occurs sooner)

	1.4i Turbo (150PS) with and without Start/Stop	1.6i Turbo (200PS) with Start/Stop
Capacity	1399cc	1598cc
Maximum power	150PS (110kW) @ 5000-5600rpm	200PS (147kW) @ 4700-5500rpm
Maximum torque	245Nm (180 lb.ft.) @ 2000-4000rpm	300Nm (221 lb.ft.) @ 1700-4700rpm
Configuration	4 cylinders, 4 valves per cylinder, double overhead camshafts	4 cylinders, 4 valves per cylinder, double overhead camshafts
Fuel/induction system	Water-cooled turbocharger with intercooler. Variable Valve Timing (VVT). Central direct fuel injection	Water-cooled turbocharger with intercooler. Variable Valve Timing (VVT). Central direct fuel injection
Emission compliance	Euro 6	Euro 6
Service interval	20,000 miles or 1 year (whichever occurs sooner)	20,000 miles or 1 year (whichever occurs sooner)

DIESEL ENGINES

	1.6CDTi (110PS) Turbo diesel with and without Start/Stop	1.6CDTi (136PS) Turbo diesel with and without Start/Stop	1.6CDTi BiTurbo (160PS) with Start/Stop
Capacity	1598cc	1598cc	1598cc
Maximum power	110PS (81kW) @ 3500rpm	136PS (100kW) @ 3500-4000rpm	160PS (118kW) @ 4000rpm
Maximum torque	300Nm (221 lb.ft.) @ 1750-2000rpm	320Nm (236 lb.ft.) @ 2000-2250rpm	350Nm (258 lb.ft.) @ 1500-2250rpm
Configuration	4 cylinders, 4 valves per cylinder, double overhead camshafts	4 cylinders, 4 valves per cylinder, double overhead camshafts	4 cylinders, 4 valves per cylinder, double overhead camshafts
Fuel/induction system	Turbocharger with intercooler. Common rail fuel injection	Variable geometry turbocharger with intercooler. Common rail fuel injection	Two stage turbocharger with intercooler. Common rail fuel injection
Emission compliance	Euro 6 with Diesel Particulate Filter	Euro 6 with Diesel Particulate Filter	Euro 6 with Diesel Particulate Filter
Service interval	20,000 miles or 1 year (whichever occurs sooner)	20,000 miles or 1 year (whichever occurs sooner)	20,000 miles or 1 year (whichever occurs sooner)

ASTRA SPECIFICATIONS

HATCHBACK PERFORMANCE, FUEL ECONOMY AND EMISSIONS

	Wheel size (inches)	Performance (manufacturer's figures)		Fuel economy mpg (litres/100km)#			CO ₂ emissions g/km#	Vehicle Excise Duty*		Benefit in kind company car taxation rates – 2016/17 tax year
		Maximum speed (mph)	Acceleration 0-60mph (sec)	Urban driving	Extra-urban driving	Combined figure		First year rate	Standard rate	
Manual										
1.4i (100PS)	16	115	12.6	38.7 (7.3)	67.3 (4.2)	52.3 (5.4)	124	£0.00	£110.00	21%
	17/18	115	12.6	37.7 (7.5)	64.2 (4.4)	51.4 (5.5)	128	£0.00	£110.00	22%
1.0i Turbo (105PS) Start/Stop ecoFLEX	16	121	10.5	52.3 (5.4)	72.4 (3.9)	64.2 (4.4)	102	£0.00	£20.00	17%
	17	121	10.5	52.3 (5.4)	70.6 (4.0)	62.8 (4.5)	104	£0.00	£20.00	17%
1.4i Turbo (125PS)	16	127	8.6	39.8 (7.1)	64.2 (4.4)	52.3 (5.4)	124	£0.00	£110.00	21%
	17	127	8.6	38.7 (7.3)	62.8 (4.5)	51.4 (5.5)	128	£0.00	£110.00	22%
1.4i Turbo (150PS)	17/18	134	7.8	38.7 (7.3)	62.8 (4.5)	51.4 (5.5)	128	£0.00	£110.00	22%
1.6i Turbo (200PS) Start/Stop	17/18	146	6.6	35.3 (8.0)	56.5 (5.0)	46.3 (6.1)	141	£145.00	£145.00	25%
1.6CDTi (110PS)	16	121	10.3	67.3 (4.2)	85.6 (3.3)	78.5 (3.6)	95	£0.00	£0.00	19%
	17/18	121	10.3	67.3 (4.2)	85.6 (3.3)	76.3 (3.7)	97	£0.00	£0.00	19%
1.6CDTi (110PS) Start/Stop ecoFLEX	16	124	10.2	74.3 (3.8)	91.1 (3.1)	85.6 (3.3)	88	£0.00	£0.00	18%
	17/18	124	10.2	72.4 (3.9)	88.3 (3.2)	83.1 (3.4)	91	£0.00	£0.00	18%
1.6CDTi (136PS) Start/Stop	16	127	9.0	64.2 (4.4)	83.1 (3.4)	74.3 (3.8)	99	£0.00	£0.00	19%
	17/18	127	9.0	61.4 (4.6)	80.7 (3.5)	72.4 (3.9)	103	£0.00	£20.00	20%
1.6CDTi BiTurbo (160PS) Start/Stop	17/18	137	8.1	55.4 (5.1)	78.5 (3.6)	68.9 (4.1)	109	£0.00	£20.00	21%
Easytronic										
1.0i Turbo (105PS) Start/Stop ecoFLEX	16	124	11.9	49.6 (5.7)	76.3 (3.7)	64.2 (4.4)	102	£0.00	£20.00	17%
	17	124	11.9	49.6 (5.7)	74.3 (3.8)	62.8 (4.5)	104	£0.00	£20.00	17%
Automatic										
1.4i Turbo (150PS) Start/Stop	16	130	8.4	39.8 (7.1)	64.2 (4.4)	52.3 (5.4)	124	£0.00	£110.00	21%
	17/18	130	8.4	39.2 (7.2)	62.8 (4.5)	51.4 (5.5)	127	£0.00	£110.00	22%
1.6CDTi (136PS)	16	124	9.1	51.4 (5.5)	76.3 (3.7)	64.2 (4.4)	115	£0.00	£30.00	23%
	17/18	124	9.1	49.6 (5.7)	74.3 (3.8)	62.8 (4.5)	119	£0.00	£30.00	23%

* = Correct at time of publication.

= Fuel consumption information is official government environmental data, tested in accordance with the relevant EU directive. Official EU-regulated test data is provided for comparison purposes and actual performance will depend on driving style, road conditions and other non-technical factors.

ASTRA SPECIFICATIONS

SPORTS TOURER PERFORMANCE, FUEL ECONOMY AND EMISSIONS

	Wheel size (inches)	Performance (manufacturer's figures)		Fuel economy mpg (litres/100km)#			CO ₂ emissions g/km#	Vehicle Excise Duty*		Benefit in kind company car taxation rates – 2016/17 tax year
		Maximum speed (mph)	Acceleration 0-60mph (sec)	Urban driving	Extra-urban driving	Combined figure		First year rate	Standard rate	
Manual										
1.4i (100PS)	16	115	13.1	37.7 (7.5)	65.7 (4.3)	51.4 (5.5)	127	£0.00	£110.00	22%
	17/18	115	13.1	36.2 (7.8)	62.8 (4.5)	49.6 (5.7)	131	£130.00	£130.00	23%
1.0i Turbo (105PS) Start/Stop ecoFLEX	16	121	11.0	52.3 (5.4)	72.4 (3.9)	62.8 (4.5)	103	£0.00	£20.00	17%
	17	121	11.0	51.4 (5.5)	70.6 (4.0)	61.4 (4.6)	105	£0.00	£20.00	18%
1.4i Turbo (125PS)	16	127	9.0	39.2 (7.2)	62.8 (4.5)	51.4 (5.5)	127	£0.00	£110.00	22%
	17/18	127	9.0	38.2 (7.4)	61.4 (4.6)	50.4 (5.6)	130	£0.00	£110.00	23%
1.4i Turbo (150PS)	17/18	134	8.2	38.2 (7.4)	61.4 (4.6)	50.4 (5.6)	130	£0.00	£110.00	23%
1.6i Turbo (200PS) Start/Stop	17/18	146	7.2	35.3 (8.0)	55.4 (5.1)	45.6 (6.2)	142	£145.00	£145.00	25%
1.6CDTi (110PS)	16	121	10.7	67.3 (4.2)	85.6 (3.3)	78.5 (3.6)	96	£0.00	£0.00	19%
	17/18	121	10.7	64.2 (4.4)	83.1 (3.4)	74.3 (3.8)	99	£0.00	£0.00	19%
1.6CDTi (110PS) Start/Stop ecoFLEX	16	121	10.6	74.3 (3.8)	91.1 (3.1)	83.1 (3.4)	89	£0.00	£0.00	18%
	17/18	121	10.6	72.4 (3.9)	88.3 (3.2)	80.7 (3.5)	92	£0.00	£0.00	18%
1.6CDTi (136PS) Start/Stop	16	127	9.5	62.8 (4.5)	83.1 (3.4)	74.3 (3.8)	101	£0.00	£20.00	20%
	17/18	127	9.5	60.1 (4.7)	80.7 (3.5)	72.4 (3.9)	104	£0.00	£20.00	20%
1.6CDTi BiTurbo (160PS) Start/Stop	17/18	137	8.4	55.4 (5.1)	78.5 (3.6)	68.9 (4.1)	109	£0.00	£20.00	21%
Automatic										
1.4i Turbo (150PS) Start/Stop	16	130	8.8	39.8 (7.1)	64.2 (4.4)	52.3 (5.4)	125	£0.00	£110.00	22%
	17/18	130	8.8	38.7 (7.3)	62.8 (4.5)	50.4 (5.6)	128	£0.00	£110.00	22%
1.6CDTi (136PS)	16	124	9.5	49.6 (5.7)	74.3 (3.8)	62.8 (4.5)	119	£0.00	£30.00	23%
	17/18	124	9.5	48.7 (5.8)	72.4 (3.9)	61.4 (4.6)	122	£0.00	£110.00	24%

* = Correct at time of publication.

= Fuel consumption information is official government environmental data, tested in accordance with the relevant EU directive. Official EU-regulated test data is provided for comparison purposes and actual performance will depend on driving style, road conditions and other non-technical factors.

ASTRA SPECIFICATIONS

TRANSMISSION

Five-speed manual gearbox

Standard on: 1.4i (100PS)/1.0i Turbo (105PS)

Six-speed manual gearbox

Petrol engines: 1.4i Turbo (125/150PS)/1.6i (200PS) models

Diesel engines: 1.6CDTi (110/136PS)/1.6CDTi

BiTurbo (160PS) models

Five-speed Easytronic transmission

The five-speed Easytronic 3.0 transmission is optional on 1.0i Turbo (105PS) engines. Easytronic is a five-speed manual gearbox with no clutch pedal. In manual mode you simply push the lever forward or back to shift gears up or down, whilst in automatic mode Easytronic takes control. A new electro-hydraulic actuator operates the clutch for faster and smoother gear changes plus increased economy through computer optimised gear changes.

Six-speed automatic transmission with ActiveSelect® function

A six-speed automatic transmission is optional on 1.4i Turbo (150PS) and 1.6CDTi (136PS) models. On the road, a wide selection of shift patterns is adapted to the style and habits of the driver, anticipating when maximum acceleration or maximum efficiency is required. The electronic control will also adapt to the prevailing road conditions, reducing gear shifting when climbing or descending and using engine braking assistance during down changes. The ActiveSelect® manual mode allows the gear lever to be used like a sequential manual gearbox – you simply push the lever forward or back to change up or down the gears. The driver also benefits from a 'neutral' gear disengagement at idle, which reduces vibration and contributes to improved fuel consumption.

BRAKING AND STABILITY

- Electronic Stability Programme (ESP)
- Cornering brake control
- Straight line stability control
- Rollover mitigation
- Drag torque control
- Hill start assist
- Anti-lock Braking System (ABS)
- Emergency brake assist
- Fading brake support
- Electronic brakeforce distribution
- Adaptive brake lights

1.0i Turbo (105PS)/1.4i (100PS)

Front ventilated discs: 276mm diameter

Rear discs: 264mm diameter

1.4i Turbo (125/150PS)

Front ventilated discs: 276mm diameter

Rear discs: 264mm diameter

1.6CDTi (110/136PS)

Front ventilated discs: 300mm diameter

Rear discs: 264mm diameter

1.6CDTi BiTurbo (160PS)

Front ventilated discs: 300mm diameter

Rear discs: 288mm diameter

STEERING

- Power-assisted steering
- Turning circle (wall-to-wall): – 11.05m (36.2ft.)

WEIGHTS AND TOWING DATA kg

	Gross vehicle weight		Maximum towing weights Trailer with brakes (without brakes)	
	Hatchback	Sports Tourer	Hatchback	Sports Tourer
1.4i (100PS)	1760	1830	900 (600)	800 (610)
1.0i Turbo (105PS) Start/Stop ecoFLEX	1780	1850	1220 (610)	1150 (620)
1.0i Turbo (105PS) Start/Stop ecoFLEX Easytronic	1790	–	1230 (610)	–
1.4i Turbo (125PS)	1820	1890	1550 (620)	1500 (640)
1.4i Turbo (150PS)	1820	1890	1550 (620)	1500 (640)
1.4i Turbo (150PS) Start/Stop automatic	1845	1915	1420 (620)	1420 (640)
1.6i Turbo (200PS) Start/Stop	1890	1960	1700 (650)	1650 (680)
1.6CDTi (110PS)	1865	1940	1500 (650)	1500 (680)
1.6CDTi (110PS) Start/Stop ecoFLEX	1850	1930	1400 (650)	1400 (670)
1.6CDTi (136PS) Start/Stop	1875	1950	1650 (650)	1500 (680)
1.6CDTi (136PS) automatic	1900	1975	1700 (650)	1500 (680)
1.6CDTi BiTurbo (160PS) Start/Stop	1910	1985	1700 (680)	1700 (700)

Gross vehicle weight is the total permissible weight of the vehicle including passengers and their luggage. The maximum roof rack loading should not exceed 75kg on all models. The maximum towing weights are based on the ability of the car, with two occupants of 75kg each, to restart on a 12% gradient, which is approximately 1 in 8.3, at sea level. The permitted trailer load applies up to the specified incline and up to an altitude of 1000 metres above sea level. The permissible gross train weight decreases by 10% for every 1000 metres of additional altitude. Any extra weight, such as luggage or additional passengers, should be deducted from the maximum towing weight. With a trailer fully loaded, maximum noseweight should not exceed 75kg. Always fit Vauxhall towing attachments and accessories available from your Vauxhall Retailer. They are designed specifically for Vauxhall models and carry a 12-month guarantee. During trailer towing do not exceed a maximum speed of 60mph. This speed limit is also applicable in countries with higher permitted speeds for trailer-vehicle combinations. Pay attention to the local speed limits. For trailers with low driving stability and caravans the use of an oscillation damper is strongly recommended.

SUSPENSION

Front: Independent. Lightweight MacPherson struts with gas-pressure dampers and coil springs. Anti-roll bar.

Rear: Lightweight compound crank rear axle with one-piece, hollow cast trailing arms. Built-in anti-roll bar. Progressive-rate double conical mini-block springs and gas-pressure dampers.

BODY

Aerodynamic drag co-efficient:
Hatchback – Cd 0.285
Sports Tourer – Cd 0.278

FUEL TANK CAPACITY

48 litres (10.5 gallons)

ASTRA SPECIFICATIONS

EXTERIOR DIMENSIONS millimetres (inches)

Hatchback

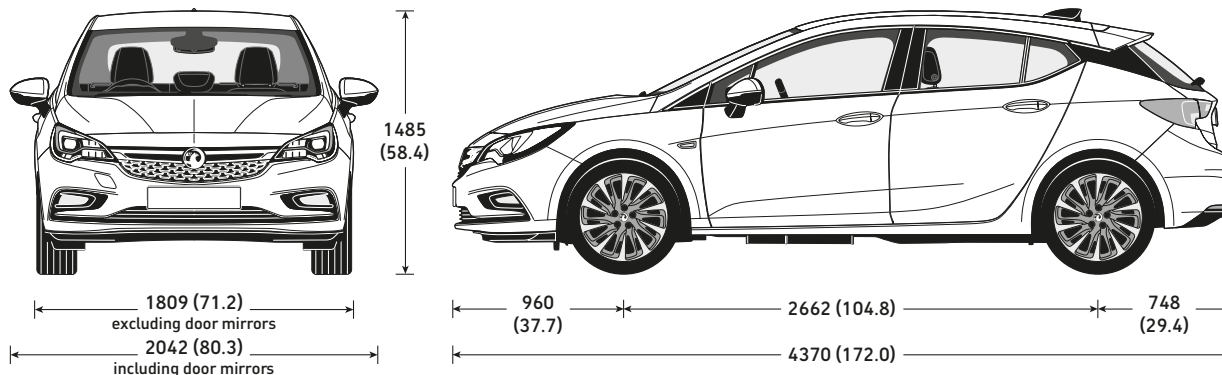

Sports Tourer

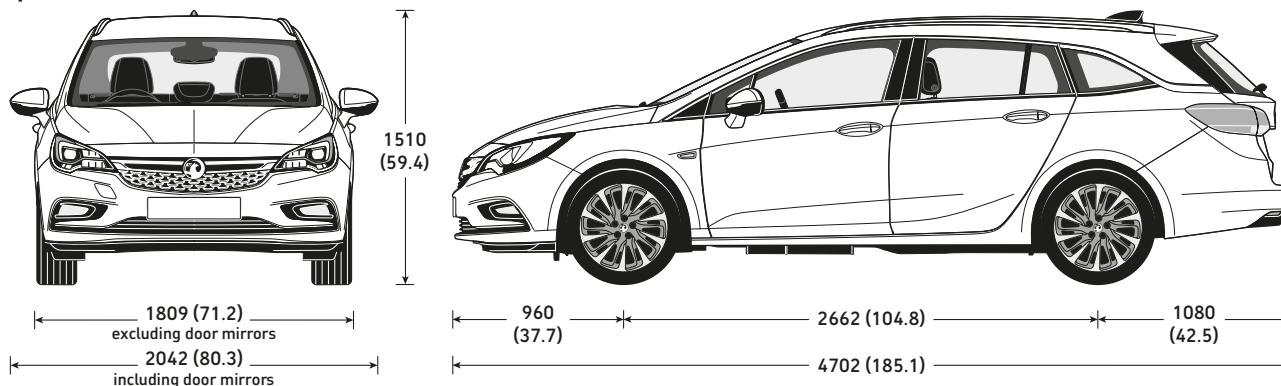

LOADSPACE DIMENSIONS mm (inches)

	Hatchback	Sports Tourer
Load floor length (rear seats folded)	1575 (62.0)	1705 (67.1)
Load floor length (behind rear seats)	828 (32.5)	1065 (41.9)
Load area width	1001 (39.4)	1050 (41.3)
Load area height	841 (33.1)	822 (32.3)
Tailgate aperture width (maximum)	1015 (39.9)	1032 (40.6)
Tailgate aperture height	600 (23.6)	747 (29.4)

LOADSPACE CAPACITIES* litres (cu.ft.)

	Hatchback	Sports Tourer
Rear seat up (under luggage compartment cover)	370 (13.0)	540 (19.0)
Rear seat down (measured to roof)	1210 (42.7)	1630 (57.5)

* = Measured using the ECIE method. When an optional spare wheel is specified loadspace capacity is reduced due to a raised luggage compartment floor.

ASTRA ACCESSORIES

INFOTAINMENT

Sat Nav updates¹

Please consult your Retailer for latest map updates or visit www.vauxhall.co.uk/accessories.

1 = For use with optional factory-fit satellite navigation systems.

CHILD SEATS²

BABY-SAFE ³ – 0-13kg/birth to 15 months	£132.00
– ISOFIX base	£227.00
DUO ISOFIX ³ – 9-18kg/9 months to 4 years	
with top tether kit	£347.00
KID ³ – 15-36kg or 4 to 12 years	£157.00

2 = Restrictions apply to the use of child seats, please consult your Vauxhall Retailer or request a copy of the Child seats brochure.

3 = Without transponder.

SECURITY

Locking wheel nuts – set of four	£39.00
----------------------------------	--------

INTERIOR

PowerFlex bar	from £119.00
Air freshener holder	£42.00
Air freshener refill	£11.00
Cupholder insert	
– Tissue	£16.00
– Notepad	£16.00
– Make-up	£16.00
Interior trim kit – Shaded Maori	£143.00

SAFETY

Parking sensors	
– four fully flush front bumper mounted sensors	£318.00
– four fully flush rear bumper mounted sensors	£318.00
Safety Pack – first aid kit, warning triangle, hi-visibility vest, Vauxhall bag	£35.00
First aid kit	£15.00
Warning triangle	£17.00
Fire extinguisher – 2kg	£37.00
Hi-visibility vest	£9.00
Temporary tyre inflation kit	£150.00
Tyre sealant	£68.00

FLEXCONNECT RANGE

FlexConnect bracket	£20.00
FlexConnect hook	£28.00
FlexConnect coat hanger	£58.00
FlexConnect folding table	£68.00
FlexConnect iPad Mini cradle	£98.00
FlexConnect iPad (1-4) cradle	£106.00
FlexConnect iPad Air cradle	£106.00
FlexConnect Samsung Galaxy cradle	£96.00

PRACTICAL

Spare bulb kit ⁴	£37.00
Spare bulb kit (white) ⁴	£37.00
Stretch tow rope – 3000kg	£34.00
Towing bar – 2500kg	£85.00
Privacy shades	
– rear window (Hatchback)	£94.00
– rear window (Sports Tourer)	£93.00
– rear side windows (Sports Tourer)	£104.00
Fog lamp wiring kit	
– Carbon fibre	£130.00
– Brushed aluminium	£116.00

4 = Excludes xenon headlight bulb for models with Adaptive Forward Lighting (AFL).

Please note:

Prices shown are a fully fitted and painted, where applicable and include VAT. Please check with your local Vauxhall Retailer for details. It is advisable to ensure your insurance policy is adequate to cover additional fitted accessories. Prices correct at time of publication.

PROTECTION

Rubber floor mats – set of four	£56.00
Velour floor mats – set of four	£61.00
Economy floor mats – set of four	£30.00
Cargo liner	from £86.00
Cargo net – horizontal	£21.00
Cargo net – sidewall	£17.00
Cargo net – vertical (Sports Tourer)	£73.00
Valve covers (set of 4)	£23.00
Load compartment storage tray	
– hatchback only	£86.00
Mudflaps	
– front	£56.00
– rear (Hatchback)	£59.00
– rear (Sports Tourer)	£55.00
FlexRail divider bar (Sports Tourer)	£95.00
FlexOrganiser® (Sports Tourer)	
– storage box	£27.00
– rail hooks	£2.00
– divider net	£184.00
– sidewall net	£17.00
– fixation straps	£35.00
Dog guard (Sports Tourer)	£188.00
Door mirror caps	
– Black	£104.00
– White	£122.00
Bumper load protection foil	from £61.00

5 = Not available with certain exterior styling products.

TRANSPORT SYSTEMS

Roof base carrier	£219.00
Roof carriers (requires base carrier)	
Bike roof carrier – Thule Freeride 532	£76.00
Surf board roof carrier – Thule 833	£101.00
Kayak roof carrier – Thule 837	£168.00
Ski roof carrier (400mm wide)	
– Thule Deluxe 726	£138.00
Ski roof carrier (600mm wide)	
– Thule 739	£235.00
Hard shell roof boxes (requires base carrier)	
Thule Ocean 80	
(320 litre / 1330 x 860 x 370mm)	£235.00
Thule Ocean 200	
(390 litre / 1750 x 820 x 450mm)	£316.00
Thule Dynamic M	
(320 litre / 2060 x 840 x 340mm)	from £625.00

THULE

Thule Dynamic L	
(430 litre / 2350 x 940 x 350mm)	£846.00
Thule Excellence	
(520 litre / 2180 x 940 x 400mm)	£898.00
Thule Motion 800	
(460 litre / 2050 x 840 x 450mm)	from £515.00
Thule Touring 200	
(400 litre / 1750 x 820 x 450mm)	£372.00
Thule Touring 780	
(430 litre / 2320 x 700 x 420mm)	£460.00
Soft roof boxes (requires base carrier)	
Thule Ranger 90	
(280 litre / 1100 x 800 x 400mm)	£285.00
Thule Ranger 500	
(300 litre / 1900 x 500 x 300mm)	£378.00
Tailgate carrier	
Bike tailgate carrier – Thule BacPac 973	£282.00
Fitting kit	£48.00
Tow bar carrier system	
Tow bar – voltage provider	£18.00
– Harness adapter – 13 to 7-pin	£16.00
– Harness adapter – 12S	£98.00
Fixed tow bar ⁷	from £617.00
Detachable tow bar ⁷	from £647.00

6 = Must be used in conjunction with a base carrier.

7 = Available with 12N, 12N/12S or 13-pin electrics. Please consult your retail or for details.

STYLING

Door sill plates	£45.00
Illuminated door sill plates	£162.00
Stainless steel pedal covers	
– manual	£117.00
– automatic	£153.00
ALLOY WHEELS (set of four with centre caps)⁸	
17-inch 5 twin-spoke	£1016.00
17-inch 10 V-spoke	£1016.00
18-inch 10 double-spoke	£1530.00

8 = Different tyres and locking wheel bolts/nuts may be required at extra cost. Price excludes new tyres and locking wheel bolts/nuts, includes static wheel balancing.

ASTRA OFFERS IN DETAIL – TERMS AND CONDITIONS

Unless otherwise stated, all offers described are available on orders or registrations between 19 December 2016 and 3 April 2017. Offer prices quoted are correct at the time of publication (December 2016). Prices are subject to change. In line with Vauxhall's policy of price transparency, the offer price shown is an on-the-road price including VAT on cars (excluding VAT on Commercial Vehicles), number plates and delivery to Retailer of £700.00 (£583.33 excluding VAT), 12 months' Government Vehicle Excise Duty (variable depending upon model – refer to the individual model price guides online) and the DVLA's new vehicle first registration fee of £55.00. Excludes fuel and insurance. Offers may not apply to Retailer stocks and are subject to availability. Restrictions may apply. Contact your Retailer for details. General Motors UK Limited trading as Vauxhall Motors reserves the right to change, amend or withdraw these offers at any point in time.

FLEXIBLE FINANCE

Available on selected models only, at participating Retailers. Conditional sale. Finance subject to status. Terms and Conditions apply. Applicants must be 18+. Finance supplied by Vauxhall Finance, PO Box 6666, CF15 7YT. Vauxhall Deposit Contributions vary and exclude certain models and are only available when vehicle is financed through Vauxhall Finance. 24-60 month term. Offer will apply to private individuals, Vauxhall Partners and small businesses 1-24 units (purchase only, excluding B2B supported units). All other customers are excluded. Refer to www.vauxhall.co.uk/offers or contact your local Vauxhall Retailer for details.

FLEXIBLE PCP

Offer subject to availability at participating Retailers only. Personal Contract Purchase. Finance subject to status. Terms and Conditions apply. Applicants must be 18+. Finance by Vauxhall Finance, PO Box 6666, CF15 7YT. Customer deposit shown after deduction of Vauxhall contribution. Vauxhall deposit contribution only available when vehicle financed through Vauxhall Finance. At the end of the agreement there are three options: i) Retain the vehicle: Pay the optional final payment to own the vehicle, ii) Return the vehicle, or iii) Replace: Part Exchange the vehicle, where equity is available. Offer applies to private individuals, Vauxhall Partners and small businesses 1-24 units (purchase only excluding B2B supported units). All other customers are excluded.

PERSONAL CONTRACT HIRE

Personal contract hire offer on orders received before 31 March 2017, subject to availability and status. Age 18+ only. Figures based on a non-maintenance contract hire package. Excess miles over contracted mileage of 24,000 over 36 months charged at 7.24 pence per mile for VIVA, 7.31 pence per mile for ADAM, 6.64 pence per mile for Corsa, 10.46 pence per mile for Astra, 12.06 pence per mile for Cascada and 11.08 pence per mile for New Mokka X. Excess charges also apply if you breach manufacturer servicing or maintenance guidelines or if the car exceeds BVRLA Fair Wear & Tear guidelines for its age/mileage when it is returned to Vauxhall Leasing. Package includes Road Fund Licence and Vauxhall Assistance. Guarantee/indemnity may be required. Prices and details are subject to change without notice. For full specification and Ts&Cs contact your local Retailer. **You will not own the car.** ALD Automotive Ltd., trading as Vauxhall Leasing, BS16 3JA. Authorised and regulated by the Financial Conduct Authority.

Please note not all offers apply to all models.

ASTRA COMPANY CAR DRIVER/FLEET INFORMATION

DESIGN AND TECH LINE HIGH SPEC, LOW P11D

Specifically developed for businesses and company car drivers alike, our Design and Tech Line models are seriously fit for Fleet.

Design models (Insignia, Astra and Corsa) all feature very low P11D values, generous standard specification with a choice of high tech ecoFLEX engines for great fuel economy and low emissions including the 'whisper diesel' 1.6CDTi (from 88g/km and 85.6mpg combined).

For even more standard specification, step up to our Tech Line range (Insignia, Astra, Mokka, Zafira Tourer and Meriva) again you are guaranteed low P11D values, plus great standard kit including Sat Nav (in lieu of parking sensors and Winter Pack on Meriva), Bluetooth®, USB connection and digital radio (excluding Meriva).

With Design and Tech Line you can take for granted low Whole Life Costs and low company car driver taxation.

COMPANY CAR DRIVER FREE* 3 DAY TEST DRIVE

Our free* 3 Day Test Drive programme is open to all Company Car Drivers which allows you to choose any model in the current Vauxhall line-up (excluding all VXR models and Commercial Vehicles), with full insurance cover provided, to give you a meaningful length of time to make an informed decision about your next company car.

Click below to book your free* test drive www.vauxhall3dtd.co.uk or call 0870 240 4848**



BENEFIT IN KIND COMPANY CAR TAXATION†

The car benefit charge will be the car's list price (including VAT, options and accessories fitted, delivery to Retailer and number plates, but excluding Vehicle Excise Duty and new vehicle first registration fee) multiplied by the percentage charge for the CO₂ emissions band in which the car falls (see table opposite). Multiply this figure by your personal income tax rate (20% for Basic Rate, 40% for Higher Rate) to calculate your annual benefit in kind tax liability.

Example:

ASTRA Tech Line 1.6CDTi (110PS)
Start/Stop ecoFLEX 5-door hatchback
(CO₂ emissions 88g/km)

On-the-road RRP	£18815.00
Deduct: Vehicle Excise Duty	(£0.00)
New vehicle first registration fee	(£55.00)
Effective list price	£18760.00
Add: Optional two-coat metallic paint	£555.00
List price for tax purposes (P11D value)	£19315.00

Car benefit charge

2016-17 tax year (18%) £3476.00

Benefit in kind tax liability (2016-17 tax year)

Basic Rate (20%) tax payer £695.20
Higher Rate (40%) tax payer £1390.40

† = Please note this Price Guide provides taxation information as a guide only. Vauxhall does not provide taxation guidance. Drivers should always take professional advice on their own tax position.

CO ₂ emissions in grams per kilometre	Percentage of car's price to be taxed	
	Petrol 2016-17 tax year	Diesel 2016-17 tax year
up to 50	7	10
51-75	11	14
76-94	15	18
95-99	16	19
100-104	17	20
105-109	18	21
110-114	19	22
115-119	20	23
120-124	21	24
125-129	22	25
130-134	23	26
135-139	24	27
140-144	25	28
145-149	26	29
150-154	27	30
155-159	28	31
160-164	29	32
165-169	30	33
170-174	31	34
175-179	32	35
180-184	33	36
185-189	34	37
190-194	35	37
195-199	36	37
200 and above	37	37

To calculate your own personal liability a car tax calculator is available at: <https://www.vauxhallfleet.co.uk/toolbox>

*The free 3 Day Test Drive programme is open to Company Car Drivers and excludes fuel and lubricants; congestion charges; parking and speeding fines and the £250 insurance excess (if applicable). It features a wide selection of models from the Vauxhall range (excluding all VXR models and Commercial Vehicles and subject to availability). Drivers must be aged 25 years or over, have held a full driving licence for at least a year and hold a major credit card. You will need to have your driving licence (and proof of identity (i.e. passport) where the driving licence is not a photocard licence) when your car is delivered. While every effort will be made to ensure that at least 3 days are provided for the test drive, this cannot always be guaranteed due to delivery and collection dates and timings. Available for UK Mainland only. Terms and conditions apply. **Telephone lines open Monday-Friday 9.00am to 5.00pm excluding Bank Holidays. Calls may be recorded or monitored for quality and/or training purposes.

FLEET TOOLBOX

Discover the facts in our online Toolbox for both Company Car Drivers and Fleet Decision Makers. The Fleet Toolbox has a host of useful calculators, comparators, interactive listings and information. Visit the Fleet Toolbox by going to www.vauxhall-toolbox.co.uk



ROADTRIP APP

The Vauxhall RoadTrip App is a free app that calculates and logs your mileage expenses for any UK business trips and generates reports to help you complete your mileage claims. Available for both iPhone and Android, visit www.vauxhall-toolbox.co.uk or visit the iPhone or Android stores and search for Vauxhall RoadTrip to download it to your smartphone or tablet.



CONTACT VAUXHALL FLEET

Please contact one of our dedicated sales teams who will be happy to help with your particular enquiry.

Company Car Drivers

Call: 0345 111 2020

Email: company-car@vauxhallinfo.co.uk

Telephone lines are open

– Monday to Friday 8.00am-9.00pm

– Saturday and Sunday 9.00am-6.00pm

Fleet Decision Makers

Depending on the size of your fleet of vehicles, we have a dedicated team to handle your enquiries. The lines are open Monday to Friday excluding Bank Holidays.

1-24 vehicles

Call: 0845 076 2254 (8.30am-5.00pm)

Email: b2bsales@vauxhall.co.uk

25+ vehicles

Call: 0870 010 0651 (8.30am-5.00pm)

Email: vauxhallfleet@vauxhall.co.uk

Special Vehicles (Police, Fire and Ambulance)

Call: 01525 408 320 (8.30am-5.00pm)

Email: vauxhallspecialvehicles@vauxhall.co.uk

ASTRA ADDITIONAL INFORMATION

ON-THE-ROAD PRICES

To eliminate uncertainty about hidden costs when buying a new car, Vauxhall publishes on-the-road recommended retail prices (RRP) and these are shown in the pricing tables within this price guide. These prices include the recommended cost of number plates and delivery to a Vauxhall Retailer of £700.00 (including £116.67 VAT), 12 months' Government Vehicle Excise Duty (see opposite for details) and the DVLA new vehicle first registration fee of £55.00*.

Please note: The on-the-road recommended retail price (RRP) does not include fuel supplied by the Retailer, motor insurance or any other goods or services supplied by agreement between the Retailer and the customer.

PRICE PROTECTION

Order a new Vauxhall for build in the current model year (as confirmed by your Retailer) for delivery no more than three months in advance and the price you are quoted is the price you pay. This is irrespective of any subsequent price rises between placing your order and delivery of your new car, but you must take delivery as soon as the car is available. General Motors UK Limited is not liable for price adjustments caused by Government changes in the rate of VAT (currently 20%), Vehicle Excise Duty, DVLA new vehicle first registration fee or by any other applicable legislation or regulations.

VEHICLE EXCISE DUTY

The amount of Vehicle Excise Duty (road fund licence) payable on new cars varies depending on the level of carbon dioxide (CO₂) emissions produced by the vehicle. CO₂ emissions are measured in grammes (g) per kilometre (km) travelled and divided into 13 charging bands shown in the table below.

From 1 April 2010 the Government introduced a new 'first year rate' of Vehicle Excise Duty payable on all new cars. In subsequent years the amount of Vehicle Excise Duty payable will revert to the standard rate.

Vehicle Excise Duty*

	CO ₂ emissions (g/km)	First year rate	Standard rate
Band A	up to 100	£0.00	£0.00
Band B	101-110	£0.00	£20.00
Band C	111-120	£0.00	£30.00
Band D	121-130	£0.00	£110.00
Band E	131-140	£130.00	£130.00
Band F	141-150	£145.00	£145.00
Band G	151-165	£185.00	£185.00
Band H	166-175	£300.00	£210.00
Band I	176-185	£355.00	£230.00
Band J	186-200	£500.00	£270.00
Band K	201-225	£650.00	£295.00
Band L	226-255	£885.00	£500.00
Band M	over 255	£1120.00	£515.00

* = Correct at time of issue.

E10 FUEL

E10 fuel is cleared for use in all petrol-engined Vauxhall vehicles excluding models with the 2.2 litre direct injection petrol engine (code Z22YH) used in Vectra, Signum and Zafira models. Owners of these vehicles should continue to use regular unleaded or premium unleaded petrol.

PROTECTING THE ENVIRONMENT

Vauxhall's commitment to the environment is demonstrated by our products' many environmental awards. For even more information on Vauxhall's efforts to achieve an environmentally sustainable future, and how to dispose of your end-of-life vehicle, see www.vauxhall.co.uk/recycling

VAUXHALL ASSISTANCE

Vauxhall Assistance is provided automatically with every new Vauxhall for 12 months from first registration and covers everything from accident assistance, roadside recovery and 'at home' service to flat tyres. With Vauxhall Assistance help is literally just a free** phone call away, 24 hours a day, 365 days a year!

** = Mobile phone users will be charged at their standard tariff.

VAUXHALL LEASING

As Vauxhall's own contract hire and fleet management operation, Vauxhall Leasing provides a one-stop-shop for competitive car and van leasing solutions – for business users and private individuals. Working with the Vauxhall Retailer network, we combine the support of a national contract with the convenience of a local contact.

For further information, please see your local Vauxhall Retailer or call us on **0870 737 2557**. Alternatively, you can visit our website at www.vauxhall-leasing.co.uk

IN THE EVENT OF AN ACCIDENT...

Vauxhall Accident Management helps keep you mobile following an accident. Benefits include vehicle recovery, Vauxhall-approved repairs and contacting your insurer. For more details, visit vauxhall.co.uk/AccidentManagement

VAUXHALL SERVICE PLAN

Vauxhall Retailers offer a great service for owners of all Vauxhall cars. Value for money, regular offers and free check-ups, combined with the peace of mind that comes from using Vauxhall-trained technicians and genuine parts, help keep your car in peak condition at all times.

FOR MORE PRODUCT INFORMATION

For a brochure on any Vauxhall model (up to a maximum of three per caller) or location of your nearest Vauxhall Retailer please call **0345 600 1500**. Alternatively, details can be found on our website at www.vauxhall.co.uk

JOIN US ONLINE:



VAUXHALL INSURANCE WITH ADDED REASSURANCE

Comprehensive cover – Summary of benefits*

- Competitive premiums
- Repairs by a Vauxhall-trained technician
- Genuine Vauxhall parts, guaranteed for three years when we repair your car within our Approved Repairer Network
- Free courtesy car as standard when using an Approved Repairer**
- 24 hour claims helpline
- Personal Accident benefit
- Cover for audio equipment
- Windscreen cover

Call for a quote on 0844 463 2670†

*The benefits listed above are for comprehensive cover only. For details of Third Party, Fire and Theft cover, please call our sales team.
**Should your car need repairing following an accident we provide a courtesy car (subject to availability) for the duration of the repair. Only genuine Vauxhall parts are used. Terms and conditions apply.
† Calls may be recorded. Vauxhall Motor Insurance is underwritten by Ageas Insurance Limited.

Every effort has been made to ensure that the contents of this document were accurate and up-to-date at the time of publication – 3 January 2017. The invoice price, including delivery to Retailer, factory-fitted options, accessories fitted by the Retailer and number plates, is subject to VAT. The right is reserved to alter specifications and prices, and withdraw products from sale, without notice. Please note that Vauxhall Retailers are not the agents of General Motors UK Limited and are not authorised to bind General Motors UK Limited by any specific or implied undertaking or representation. It is advisable to ensure that your motor insurance policy provides adequate cover for additional fitted options and accessories. All rights reserved. No part of this publication may be reproduced in any form or by any means, without the prior written permission of General Motors UK Limited.

General Motors UK Limited t/a Vauxhall, Griffin House, UK1-101-135, Osborne Road, Luton, Bedfordshire, LU1 3YT. www.vauxhall.co.uk

©2017 General Motors UK Limited



VAUXHALL