

## Trust Vauxhall

### Protecting the environment

Vauxhall's commitment to the environment is demonstrated by our products' many environmental awards, won both through the use of more recycled materials and by becoming cleaner and more efficient. For information on Vauxhall's efforts to achieve an environmentally sustainable future, see [www.vauxhall.co.uk/recycling](http://www.vauxhall.co.uk/recycling).

### Fleet Customer Services

Our dedicated support services for fleet managers includes factory demonstrators, a 48hr test drive programme and information on whole life costs, company car taxation and finance. For further information please call **0870 010 0651**.

### Buying your car

GMAC offers one of the most comprehensive and competitive ranges of financing plans in the UK. Contact your local Vauxhall retailer for details or call the GMAC customer service centre on **0845 712 3444**.

### Sureguard protection

Sureguard Assistance offers the benefits of Vauxhall Assistance for three years from first registration, while Sureguard Warranty also provides a parts and labour warranty for high-mileage or long-term owners. For details contact your local Vauxhall retailer or call **0870 752 7020**.

### Specialist Mobility advice

Motability accredited Vauxhall retailers can provide special mobility help and advice. Blue badge holders are entitled to very favourable discounts on new vehicles. Contact your local Motability accredited Vauxhall retailer or **Freefone 0800 731 5267**.

### Servicing and maintenance

The best way to maximise the performance and reliability of your Vauxhall is to have all routine servicing and maintenance carried out at one of around 400 Vauxhall retailers. To find your nearest retailer call **0845 600 1500**.

### In the event of an accident...

Vauxhall Accident Support helps keep you mobile following an accident. Benefits include scene-of-accident advice, message service, assistance with claims and vehicle recovery. Call **0800 010 304** for a free driver's pack.

### Vauxhall Insurance

Available for new and used Vauxhalls, a Vauxhall Insurance policy offers a unique package designed specifically for Vauxhall drivers. For a highly competitive quotation, call **0870 024 0240** or visit our website at [www.vauxhall.co.uk](http://www.vauxhall.co.uk).

### For more information...

For a brochure on any Vauxhall model (up to a maximum of three per caller) or location of your nearest Vauxhall retailer please **Lo-call 0845 600 1500**.

Alternatively, details can be found on our website at [www.vauxhall.co.uk](http://www.vauxhall.co.uk)



- Save up to £2000\* on a new Vauxhall with The GM Card

- 100 Rebate Points worth £100 when you use The GM Card for the first time

- Rebate Point saving is on top of any discount or offer negotiated with the Retailer

- Earn 3 Rebate Points (£3) for every £100 you spend

### Typical 14.9% APR variable

To apply call **0845 746 2777** or visit [www.gmcard.co.uk](http://www.gmcard.co.uk).

For a copy of this brochure in large print, Braille or on audio tape, please call **0845 600 1500**, or via our textphone service on **18001 08456 785 785**.

The GM Platinum Card is issued by HFC Bank Limited and is available to persons aged 18 years or over and resident in the UK (or 21 and over in the Channel Islands) and is subject to status and conditions. Written quotations are available upon request from The GM Platinum Card, PO Box 3615, Birmingham B3 2RJ. The typical APR quoted is the rate for new customers. \*Rebate Points are earned on purchases using The GM Platinum Card. Rebate Points are not earned on Balance Transfers or Cash Advances. You earn money off a new Vauxhall/Saab by accumulating Rebate Points under the Rebate Points Programme. Vauxhall Motors Ltd is solely responsible for the operation of the Rebate Points Programme, which is subject to the Rebate Points Programme Rules. You can redeem up to 2500 Rebate Points subject to the Model Line Maximum which will vary in amount in relation to different Vauxhall/Saab vehicle model lines and unlimited Partner Points. Rebate Points and unlimited Partner Points are redeemable as discounts on a new Vauxhall/Saab vehicle and must be redeemed four years from the issue date. Rebate Points may not be redeemed by Motability Contract Hire customers. The GM Card is a trading name and style of both HFC Bank Limited and Vauxhall Motors Ltd. HFC Bank registered in England No. 1117305. Registered Office: North Street, Winkfield, Windsor, Berkshire SL4 4TD is authorised and regulated by the Financial Services Authority. Member HSBC Group. HFC Bank Limited is not a member of the same group of companies as Vauxhall Motors Ltd, Saab GB Limited or GMAC (UK) plc. Vauxhall Motors Ltd, Registered Office: Griffin House, Osborne Road, Luton, Bedfordshire LU1 3YT. Registered in England number 135767. - CN6/0987.

Every effort has been made to ensure that the contents of this publication were accurate and up-to-date at the time of going to press (January 2007). Vauxhall vehicles are equipped with components manufactured by various General Motors operating units and outside suppliers. The Company reserves the right to alter specifications and withdraw products from sale without notice. Any such alterations will be notified to Vauxhall retailers at the earliest opportunity; please consult your local retailer for the latest information. The specifications detailed within this brochure are not necessarily applicable to alternative models such as Special Editions. Details of any such models will be contained in specific literature or found on the Vauxhall website. Please note that Vauxhall retailers are not the agents of Vauxhall Motors Limited and are not authorised to bind the Company by any specific or implied undertaking or representation. It is advisable to ensure that your motor insurance policy provides adequate cover for additional fitted options and accessories. As part of Vauxhall's policy of environmental care, this brochure is printed on paper manufactured using Elemental Chlorine Free pulps from specially farmed, sustainable timber resources. All rights reserved. No part of this publication may be reproduced in any form or by any means, without the prior written permission of Vauxhall Motors Limited.

VM0606814 Published February 2007 (BMB/Graymatter) Vauxhall Motors Limited, Luton LU1 3YT



# New Corsa

Put the fun back into driving





# C'MON!

## Have some fun

Get yourself into the all-new Corsa. And get a lot more fun out of life. With stunning new styling and brilliant attention to detail, inside and out. A dynamic new chassis and punchy petrol or diesel engines. Plus more clever features than ever. It can only make life better. Wherever you go. Whatever's in store for you.

This brochure covers Corsa Expression, Life, Club, Design and SXi models only. Some of the models shown include options and accessories available at extra cost. And not all of the features described are available on every model. So please check in the Equipment section for further details. From time to time, we also offer alternative Corsa models such as Special Editions, featured in their own separate literature or found on the Vauxhall website: [www.vauxhall.co.uk](http://www.vauxhall.co.uk)

Real style 6

Smart innovation 10

Fun to drive 14

Safe and secure 18

Great features 20

Make a choice 24

Vauxhall by Design 30

Colours and trims 36

Equipment 40

Technical data 50





## C'MON Check the style

New Corsa looks brilliant from every angle. The seriously sporty three-door, sharp and dynamic with real attitude. And the flexible five-door – maybe a little more grown-up, but ever so versatile and wonderfully well proportioned. On the inside, we've got sharp tailored fabrics, clean lines, new surface finishes and chrome detailing. And every model has its own unique personality, so all you have to do is choose the one that matches yours.



# C'MON

Try something new

Life never stands still. Nor does New Corsa. And the latest models are available with some pretty smart features. Like the Flex-Fix® integrated carrier system that extends when you need it, and disappears when you don't. Or voice activated Bluetooth® for your mobile phone, adaptive headlights that see round corners, and the ability to play MP3 tracks on CD. You might not use them all the time, but you'll certainly appreciate them when you do.









# C'MON!

Enjoy the drive

The best way to discover how much fun New Corsa is to drive is to try it for yourself. You certainly won't be disappointed. We've tuned the new chassis for a great ride and secure, agile roadholding. We've made even more chassis safety features available to help in emergency situations. And every Corsa engine – petrol or diesel – matches plenty of punch with remarkable fuel economy. Book that test drive today!

## A new dimension of driving fun

Okay, we could just tell you that the New Corsa chassis has been completely redesigned to ensure pure driving pleasure without ever compromising ride comfort. But wouldn't it be better to discover how much fun it is to drive by trying it for yourself?

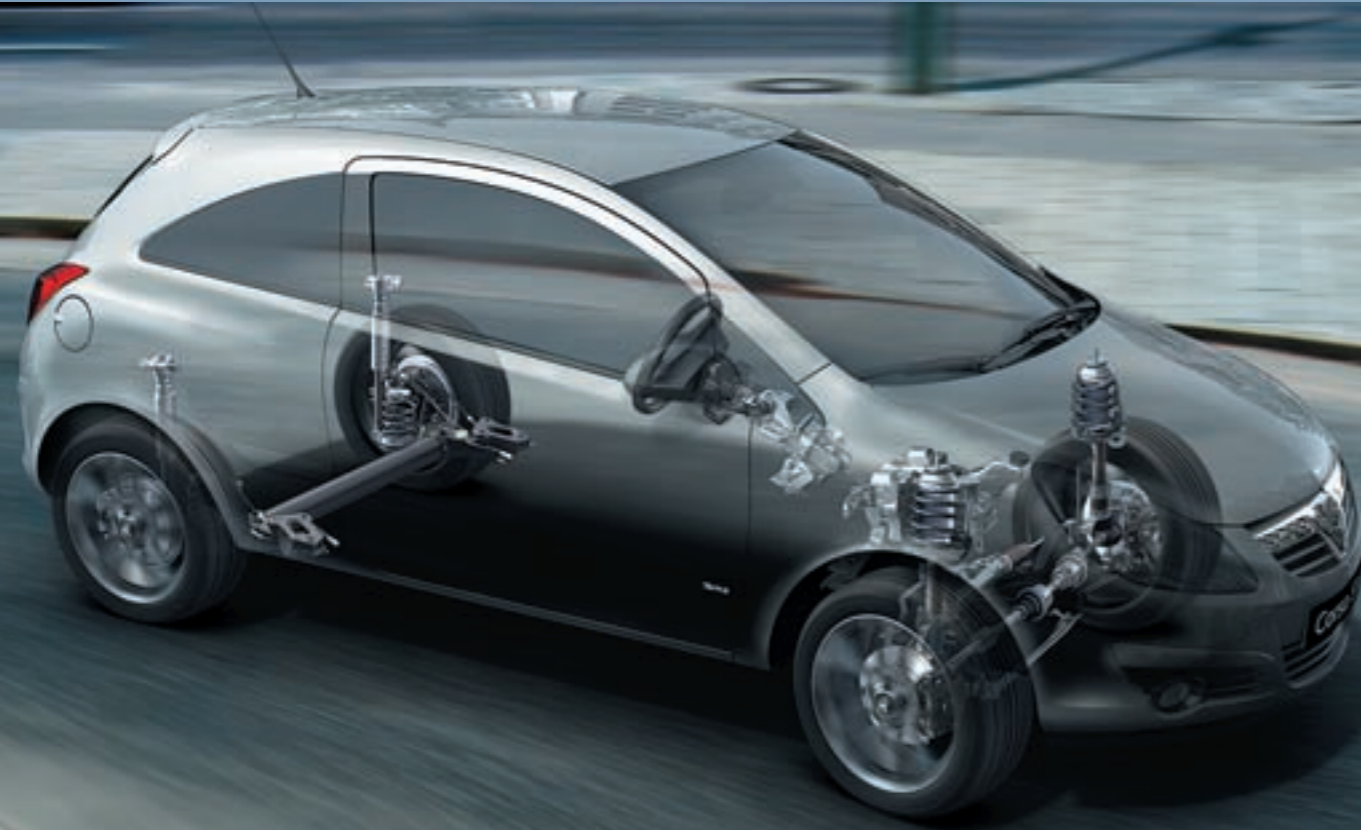

◀ **Easytronic.** Choose New Corsa's optional Easytronic transmission and you'll get a five-speed manual gearbox with a fully automatic mode. In manual mode, you simply push the lever forward or back to shift gears up or down and by nudging the lever to the side you switch to fully automatic mode. There's no clutch pedal so you can drive it on an automatic-only driving licence.





▲ **Six-speed and Auto.** Cars like Corsa never used to come with a six-speed manual gearbox, but the new 1.3CDTi 16v 90PS and 1.7CDTi 16v diesel models do. Others come with a five-speed manual as standard, with a sophisticated four-speed automatic also available.

◀ **Chassis.** The New Corsa chassis combines serious ride comfort with real agility. The advanced anti-lock braking system has a number of important new features and combines with other chassis safety features to improve stability and steering behaviour in a range of emergency situations.

Choose the sporty SXi – or choose optional 17-inch alloy wheels on Design models – and you will enjoy a lower ride height and sportier spring and damper settings, plus progressive rate variable ratio speed-sensitive power steering.

▲ **Speed-sensitive steering.** With New Corsa's power steering, it's easier to turn the wheel at parking speeds when you need it most, but more stable, with more feedback, once you're out on the road. The setup is even tuned to the specific engine to ensure the perfect level of assistance, with a progressive rate variable ratio system on SXi for an even sportier response.



**Petrol engines.** New Corsa models are available with 1.0i 12v, 1.2i 16v and 1.4i 16v multi-valve petrol engines. They all feature our Twinport variable induction system and very much the same attitude, too. Big on flexibility with lively power delivery. Big on fuel economy. But low on emissions.

**Turbo diesels.** New Corsa's 1.3CDTi 16v – 75PS and 90PS – and new 1.7CDTi 16v are low on emissions, with serious mid-range punch and incredible economy. How do we do it? Common rail injection, an intercooled variable geometry turbocharger and plenty of Vauxhall know-how.

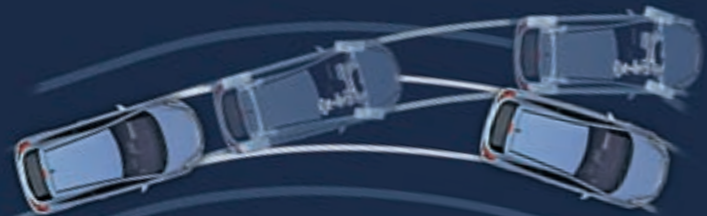

**ABS and ESP-Plus.** New Corsa's Anti-lock Braking System (ABS) includes safety features like Straight Line Stability control and Cornering Brake Control as standard. Electronic Stability Programme (ESP-plus) with Enhanced Understeering Control can be specified as an option. The Technical data section has more details.



**Airbags.** Most New Corsa models feature double-action front seatbelt pretensioners and up to six airbags, including front seat side-impact and curtain airbags too. Press a button on the centre console to deactivate the front passenger's airbag and you can keep a rear-facing child seat up front.

**Halogen AFL.** Another feature you don't expect on a car like Corsa, optional Halogen Adaptive Forward Lighting moves the headlight beams up to 15 degrees left or right of the straight ahead position when you turn the steering wheel, helping improve your vision of the approaching bend.



**Double pretensioners.** Front seatbelt pretensioners act on the diagonal shoulder restraint on all models. And on the lap belt too, on Club models and above. So in the event of a collision, they're ready to interact with the front airbags and compensate for lateral seat movement.



**Hill Start Assist (HSA).** Available on Easytronic models only, HSA stops your car rolling back on a slope when you take your foot off the brake. It does this by maintaining the brake pressure electronically for 1.5 seconds after the pedal has been released or until the accelerator is applied.

**Adaptive brake lights.** ABS brakes can shorten your stopping distance in slippery road conditions, but what about the driver behind you? With New Corsa, if the ABS is activated at over 18mph, your brake lights blink at five times a second, warning the following driver that you're emergency braking.



**Security.** Every New Corsa model comes with an engine deadlock immobiliser and central deadlocking, by remote control on most models. We've also added an internal door locking switch, for added security and reassurance in the event of unwanted attention from outside the car.



## Intelligent safety

Our life-saving safety features are almost taken for granted on Vauxhall cars nowadays, but it doesn't mean we've stopped inventing new ones. Double front seatbelt pretensioners and adaptive brake lights are just two examples of how New Corsa achieves such a high safety rating.

▼ **Door-to-door illumination.** Every New Corsa features door-to-door illumination. Just flick the headlight stalk and the dipped headlights and rear lights stay on for 30 seconds – helping you find your way out of an unlit driveway or car park. Some models feature welcome lighting too, switching on the interior light and rear number plate lights when the car is unlocked.



◀ **Infotainment.** The new CD 60 stereo radio/CD/MP3 player/satellite navigation system\* is only part of the New Corsa's infotainment programme. Steering wheel mounted audio controls are standard on many models. And Bluetooth® wireless mobile phone technology is also available featuring voice activation and full operation via the steering wheel controls and facia display.

*\*Available Spring 2007.*



◀ **Air-con and ECC.** Air-conditioning provides chilled air on hot days, faster demisting on damp days and a more pleasant atmosphere throughout the year. Move up to Electronic Climate Control (ECC) for a more consistent interior temperature with automatic air recirculation in high pollution areas.



◀ **Rain and light sensors.** Automatic lighting control can switch the car's lights on when it gets dark. Other sensors can switch the wipers on and even dim the rear-view mirror – all automatically. These features are standard on Design and optional as the Sight and Light Pack on Club and SXi.

▶ **Cruise control.** The easy-to-use, tap up/tap down cruise control, available as part of the Plus Pack on Club, Design and SXi, allows you to maintain a steady speed without keeping your foot on the throttle. So it's more comfortable on long journeys and easier to keep to speed limits too.



▲ **Driving position.** You're going to be spending some quality time in your New Corsa. So we've made it easy for you to make sure it's exactly how you want it. The New Corsa interior is big on ergonomic efficiency. Which means it's designed around real people, with space to relax and plenty of room for long legs and broad shoulders – front and rear. All the controls are within easy reach so you don't have to take your eyes off the road for more than a moment to adjust the heating or the audio, for example.

Best of all, it's easy to find the perfect seating position with a driver's seat that moves six ways – including height adjustment – on most models. On Club models and above (optional on Life), you'll find fully adjustable steering too, bringing us right back to what we said earlier about real people and perfect ergonomics.



## Easy life

New Corsa is available with some pretty brilliant features so you never have to compromise on what you really want. Like real quality audio and satellite navigation. Your favourite seating position. And added peace of mind. So it's easy to choose a New Corsa that fits the way you live perfectly.



## Clever equipment

How do you build a small car that feels like a big one? You give it plenty of space for you and your friends. You make room available for all your kit with clever storage solutions. And you make plenty of smart features available, so every New Corsa is exactly the way you want it.

◀ **Sunroof.** New Corsa's electrically operated sunroof is 25% wider than it used to be, so you can look forward to 25% more blue sky. It has a manually operated roller blind to reduce glare, and twin-chamber insulation to reduce noise when it's shut. An integrated wind deflector reduces wind noise, too.



▲ **Translucent controls.** Smart new backlit, translucent controls are standard on the audio equipment and, on some models, heating and air-conditioning system and window switches. On Design and SXi, the front and rear footwells are gently lit too, for a subtle, welcoming effect.



▲ **Flex-Fix.**® If your plans change all the time, so can your New Corsa. Choose the optional revolutionary Flex-Fix® system and it incorporates an integrated carrier for two bikes, so you don't need a separate roof or rear carrier.



▲ ▶ **Luggage area.** Some New Corsa models feature a DualFloor luggage compartment. When the rear seat backs are folded, it provides a long, level, load surface which makes loading that bit easier. And when lowered, it offers a deeper load area.

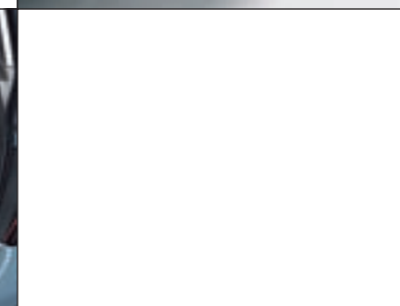

◀ ▲ ▶ Most of the time Flex-Fix® stays hidden behind the rear number plate, but when the need arises, you simply extend it, attach the extra rear lights, fix your bikes to the carrier and off you go. An acoustic warning sounds when the carrier is extended and reverse gear is engaged.



◀ ▼ **Clever storage.** New Corsa has so many places to keep your belongings. There are drinks holders and stowage compartments in the centre console, an underseat storage tray under the front passenger's seat and the front door pockets (and rear side panels on 3-door models) have holders for bottles up to 1.5L.





# C'MON!

Make a choice

So here's the question. Do you get what you want? Or make do with what you get? We suspect the former. So it's just as well that New Corsa comes with a brilliant choice of feature-packed models, petrol and diesel engines, and drop-dead gorgeous colour and trim choices.

**EXPRESSION AND LIFE**

Yet more Vauxhall models that disprove the theory that you only get what you pay for, New Corsa Expression and Life come packed with all this essential kit for a super-competitive price.

**Standard features include:**

- Driver's and front passenger's dual-stage airbags
- Anti-lock Braking System (ABS)
- Emergency Brake Assist
- Cornering Brake Control
- Electronic engine deadlock immobiliser
- Stereo radio/CD player
- Speed-sensitive power-assisted steering
- Door-to-door illumination
- Electrically adjustable door mirrors
- Body-colour bumpers
- Central locking (remote control on Life)
- Electrically operated front windows (Life)
- Welcome lighting (Life)

**Model and engine availability and insurance groups (ABI)**

Expression 3-door	
1.0i 12v	1E

Life 3- and 5-door	
1.0i 12v	1E
1.2i 16v	2E
1.2i 16v Easytronic	2E
1.3CDTi 16v (75PS)	3E

*Two-coat pearlescent paint is optional at extra cost.*



**Optional Life Plus Pack**

- Driver's seat height adjuster
- Steering column adjustable for reach and rake (above)

**CLUB**

Go on. Treat yourself. Choose New Corsa Club for specially co-ordinated interior colour combinations, added versatility and plenty of brilliant features.

**Additional features over and above Life model include:**

- Front seat side-impact and full-size curtain airbags
- Stereo radio/CD with MP3 capability/auxiliary-in connection\*
- Steering wheel mounted audio controls
- Steering column adjustable for reach and rake
- Driver's seat height adjuster
- 60/40 split-folding rear seat back
- Chrome-effect interior detailing
- DualFloor luggage compartment
- Body-colour door handles and side-protection mouldings
- 15-inch steel wheels

**Model and engine availability and insurance groups (ABI)**

3- and 5-door	
1.2i 16v	2E
1.2i 16v Easytronic	2E
1.4i 16v	3E
1.4i 16v Automatic	3E
1.3CDTi 16v (75PS)	3E

*Adaptive Forward Lighting, air-conditioning, Easytronic transmission and two-coat pearlescent paint are optional at extra cost.*

*\*Auxiliary-in connection available Spring 2007.*



**Optional Club Plus Pack**

- 15-inch five-spoke alloy wheels
- Cruise control (above)
- Front fog lights
- Multi-function trip computer

**DESIGN**

Make no mistake, New Corsa Design makes a high quality style statement in every respect. Inside and out, it's a small car loaded with upmarket features.

**Additional features over and above Club model include:**

- Air-conditioning
- 16-inch alloy wheels
- Automatic Lighting Control
- Rain-sensitive windscreen wipers
- Sports-style front seats with Morrocana side bolsters
- Front fog lights
- Electrically heated door mirrors
- Translucent lighting and window controls
- Leather-covered steering wheel
- Sports instruments
- Piano black centre console
- Platinum-coloured seatbelts
- Rear reading light (5-door)
- Front map reading lights

**Model and engine availability and insurance groups (ABI)**

3- and 5-door	
1.2i 16v	3E
1.4i 16v	4E
1.4i 16v Automatic	4E
1.3CDTi 16v (90PS)	4E
1.7CDTi 16v (125PS)	6E

*Four-speed automatic transmission and two-coat metallic paint are optional at extra cost.*

**Optional Design Plus Pack**

- Electronic Climate Control (above)
- Cruise control
- Multi-function trip computer
- Graphic Information Display

**SXi**

Dynamic handling and responsive performance are certainly good reasons to choose SXi. But so is the ability to stand out and get away in style.

**Additional features over and above Club model include:**

- 16-inch alloy wheels
- Sports suspension
- Front fog lights
- Dark-style headlights
- Sports-style front seats
- Translucent lighting and window controls
- Sports instruments
- Matt chrome-effect centre console
- Rear reading light (5-door)
- Front map reading lights
- Leather-covered sports steering wheel
- Electrically heated door mirrors
- Chrome-effect exhaust tailpipe
- Progressive rate variable ratio speed-sensitive power steering

**Model and engine availability and insurance groups (ABI)**

3- and 5-door	
1.2i 16v	3E
1.4i 16v	4E
1.4i 16v Automatic	4E
1.3CDTi 16v (90PS)	4E
1.7CDTi 16v (125PS)	6E

*Air-conditioning, 17-inch twin-spoke alloy wheels and two-coat metallic paint are optional at extra cost.*

**Optional SXi Plus Pack**

- Electronic Climate Control
- Cruise control
- Multi-function trip computer (above)
- Graphic Information Display



# Vauxhall by Design

Vauxhall by Design is all about choice – selecting your new car, then personalising it to suit yourself with a choice of individual options, special option packs and accessories available at highly attractive prices. You'll find further information on the following pages. Ask your Vauxhall retailer for more details.



Inspired by the hugely successful VX Racing team, Vauxhall VXR styling products come with all the same experience, knowledge, and passion for style and performance. They put the accent firmly on quality and exclusivity, with a winning edge. And they add flair, personality and excitement to every New Corsa model. VXR styling products are available as factory-fit option packs or accessories fitted by your Vauxhall retailer. Please refer to the Vauxhall Car and Accessory Price Guide for availability details of the full Vauxhall VXR range.

**VXR Styling Pack One.** Available on Design and SXi models the VXR Styling Pack consists of a front lower spoiler, side sills, rear roof spoiler, rear skirt and chrome exhaust tailpipe. These items are also available as accessories sold separately. Vehicle illustrated additionally features optional 17-inch alloy wheels.



**Irmscher styling.** Treat your New Corsa to Irmscher styling accessories which include: cross hatch grille with aluminium upper, 17-inch Sport Star alloy wheels, body-colour front lower spoiler, side sills and rear hood spoiler.



**Irmscher sports silencers.** For distinctive looks (with chrome-plated tailpipes) and a sportier exhaust note, they're the perfect choice for your New Corsa. Available in split oval or dual branch design, these specially designed kits can be fitted by your Vauxhall retailer at an all-inclusive price.



Developed in conjunction with auto design specialists Irmscher International, New Corsa styling accessories perfectly complement the vehicle's lines, as well as being manufactured to the same exacting standards as the car itself. For availability details of these features – please refer to the Vauxhall Car and Accessory Price Guide.



**Irmscher alloy wheels.** They're the perfect way to personalise your New Corsa. With a huge range to choose from (style illustrated is Stila), and sizes from 14 to 17 inches, you're sure to find one to suit your style and budget. And don't forget to ask about our accessory wheel locking kits too.

New Corsa options can make life better in so many ways. Alloy wheels, infotainment upgrades, air-conditioning, a sunroof – there's a huge range to choose from and they're available individually or in special option packs at great prices. You'll find further information on availability in the Equipment section. Or you can ask your Vauxhall retailer.



**Rear parking distance sensor.** This clever early warning system helps safeguard your car and pedestrians. When reverse gear is selected, the system beeps as you reverse close to an obstruction, rising to a continuous tone when the object is approximately 300mm away.



**Bluetooth.** With the optional mobile phone adaptor,\*\* your phone interfaces with the infotainment unit, for full operation via the steering wheel controls and fascia display. Bluetooth® wireless technology with voice activation is included. You don't need an extra SIM card or card adaptor.

**Options and option packs.** New Corsa options are available individually or in special option packs at great prices. The Equipment section has more details.

**Individual options include:**

- Flex-Fix® integrated carrier system
- Sunroof
- Alloy wheels
- Air-conditioning
- Halogen Adaptive Forward Lighting (AFL)
- Electronic Stability Programme-plus (ESP-plus)
- Bluetooth® mobile phone system capability
- ISOFIX system for front passenger seat

**Satellite navigation.\*** Fast becoming the 'must have' option for people on the move, this CD-ROM based SatNav system guides you to your destination, with clearly spoken directions and directional pictograms of the route. It can also point out accident black spots, schools and points of interest.



**Sight and Light Pack.**

- Automatic lighting control
- Rain-sensitive windscreen wipers
- Electro-chromatic anti-dazzle rear-view mirror



**Alloy wheels.** Nothing sets your car apart like a stunning set of Vauxhall alloys. Check out the 15-inch alloy wheel option for Club models (right) and the larger 17-inch size for Design and SXi (below).



**Hill Start Assist Pack.†**

- Hill Start Assist
- Electronic Stability Programme-plus (ESP-plus)
- Deflation Detection System



\*Available Spring 2007.  
\*\* Please check phone compatibility with your retailer.  
† Only available with Easytronic transmission. Please see page 18 for further explanation of the individual features.

Vauxhall accessories are the right choice for your New Corsa. Whatever you're into, there's certain to be a Vauxhall accessory with your name on it. We've only featured a small selection of what's available here. The Vauxhall car accessory brochure gives further details. Or check out our website at [www.vauxhall-accessories.com](http://www.vauxhall-accessories.com)



◀ **Protection Pack.**

- Velour mats
- Mudflaps
- Cargo liner



▼ **Travel Pack.**

- First aid kit
- Warning triangle
- Spare bulb kit
- Fire extinguisher
- Hi-visibility vest

▲ **Protection Plus Pack.**

- Paint and trim protection
- Velour mats
- Mudflaps



◀ **Rear parking distance sensors.** Helping reduce the risk of bumps and scrapes, this two-sensor, retailer-fit system beeps as you reverse close to an obstruction, rising to a continuous tone when the object is approximately 300mm away.



◀ **Nashville DAB35.** Digital Audio Broadcast radio sound quality and station choice, plus a 5-channel equaliser and CD/MP3/WMA playback. It's iPod ready, has a subwoofer output and can even record from the DAB to an SD or MMC card! Requires single DIN fascia kit.



◀ **Premium bicycle carrier.** With a moulded profile that holds the bicycle upright, leaving both hands free to secure it, this innovative carrier fits bikes with a frame tube of 20-80mm diameter. Two carriers may be fitted onto the base carrier, so remember to specify left or right hand fitting.



◀ **Base carrier.** The Vauxhall roof rack system begins with this base carrier. It comprises of two T-track bars which support a wide range of attachments. Each carrier is supplied with locks for security.



◀ **Casablanca MP56.** A high-end MP3/WMA tuner with FM/AM/RDS, great design, smart sound setting features and multiple connectivity options for an iPod or USB devices. It also features Bluetooth® compatibility for hands-free mobile phone use. Requires single DIN fascia kit.



◀ **Child seats.** Vauxhall offers a range of child seats, ergonomically styled for comfort and safety. The BABY-SAFE (for babies from birth to 13kg), and KID (15-36kgs) seats are fixed with a standard lap and diagonal seatbelt, while the DUO ISOFIX (9-18kg) can also be attached using the ISOFIX child seat restraint fittings, which are standard on the outer rear seats of all Corsa models. The rigid ISOFIX anchoring mechanism virtually eliminates the dangers of incorrect child seat installation. New Corsa is also compatible with Vauxhall's new Top Tether system, designed to stop the top of ISOFIX child seats moving forward in a frontal collision.

This season's 'must have' colour? Take your pick from a brilliant range of New Corsa shades. Plenty to choose from. All coupled with a great new cloth trim line-up.

*Due to the limitations of the printing process the colours reproduced may vary slightly from the actual paint colour or trim material. As a result they should be used as a guide only. Your Vauxhall retailer has a comprehensive display of all our paint samples and trim swatches.*

▶ Glacier White – solid



▶ Star Silver – metallic



▶ Ultra Blue – pearlescent



▶ Flame Red – solid



▶ Silver Lightning – metallic



▶ Black Sapphire – pearlescent



▶ Royal Blue – solid



▶ Lilac – metallic



▶ Air Blue – pearlescent



▶ Lancelot – metallic



▶ Metro Blue – metallic



▶ Green Tea – pearlescent



▼ Punch, Charcoal

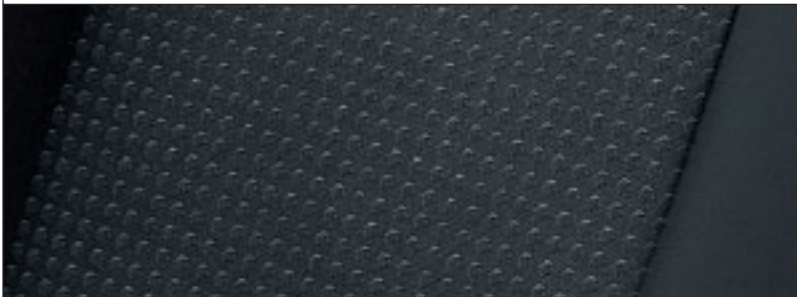

▼ Cable, Indian Red

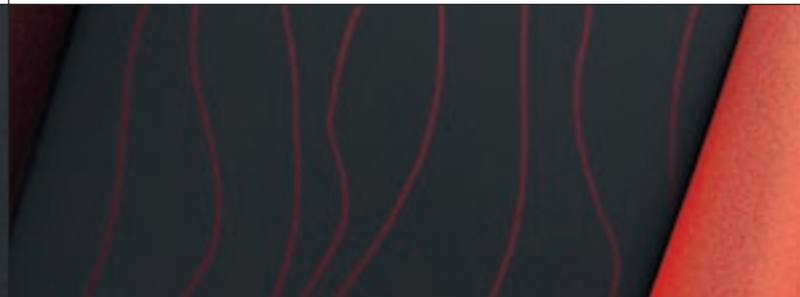

▼ Cable, Charcoal

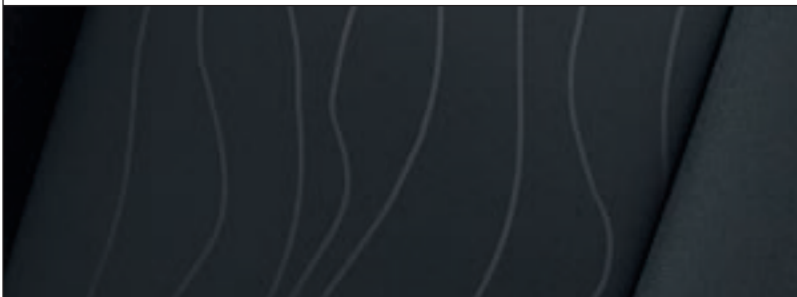

▼ Cable, Asia Blue



Exterior colours

Model, trim name and trim colour

	Expression Punch cloth	Life Punch cloth	Club Cable cloth	Design Fuse cloth/Morrocana	SXi Fuse cloth
<b>Solid</b>					
Flame Red	Charcoal	Charcoal	Charcoal	Charcoal	Red
Glacier White	Charcoal	Charcoal	Charcoal or Red	Charcoal	Red
Royal Blue	Charcoal	Charcoal	Charcoal or Blue	Charcoal	-
<b>Two-coat metallic*</b>					
Lilac	-	Charcoal	Charcoal	Charcoal	-
Metro Blue	-	Charcoal	Charcoal or Blue	Charcoal	Red
Silver Lightning	-	Charcoal	Charcoal or Blue	Charcoal	Red
Star Silver	-	Charcoal	Charcoal or Red	Charcoal	Red
Lancelot	-	Charcoal	Charcoal or Blue	Charcoal	-
<b>Two-coat pearlescent*</b>					
Ultra Blue	-	Charcoal	Charcoal	Charcoal	-
Black Sapphire	-	Charcoal	Charcoal or Red	Charcoal	Red
Air Blue	-	Charcoal	Charcoal or Blue	Charcoal	-
Green Tea	-	Charcoal	Charcoal	Charcoal	-

\* = Optional at extra cost. - = Exterior colour listed is not available on this model.

▼ Fuse/Morrocana, Charcoal

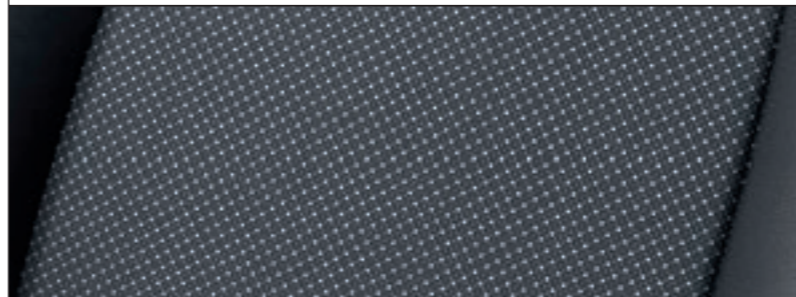

▼ Fuse, Garnet Red

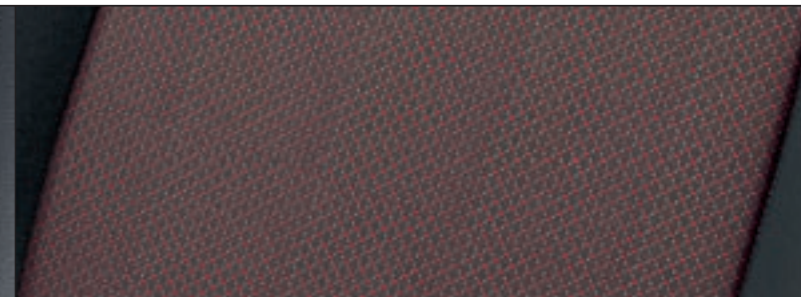



Dual-stage airbag system.



Airbag deactivation and internal door locking switches.

## Safety

**Standard features** • Driver's dual-stage airbag • Front passenger's dual-stage airbag • Pedal release system – Reduces potential injury to the driver's legs and feet during a severe frontal impact • Laminated windscreen • Reinforced passenger safety cell • Side-impact protection beams • Fuel tank located ahead of rear axle

• Child-proof locks on rear doors • ISOFIX child seat restraint system for outer rear seats incorporating top tether – Secures specially designed ISOFIX child safety seats to the vehicle itself, virtually eliminating the dangers that can result from improper installation (does not include child seat) • Deactivation switch for front passenger's airbag

• Anti-lock Braking System (ABS) with Electronic Brakeforce Distribution • Straight Line Stability control – see **D1** on page 54 • Cornering Brake Control – see **D2** on page 54 • Emergency Brake Assist – Increases brake force applied in emergency braking situations • Adaptive Brake Lights • Drag Torque Control – Helps maintain stability when suddenly lifting off the accelerator

• Height-adjustable front seat head restraints • Height-adjustable front seatbelts • Pyrotechnic front body-lock seatbelt pretensioner system – Tightens the diagonal belt during the early stages of a frontal impact • Driver's and front passenger's seatbelt force limiters – Reduces potential upper body injuries during a frontal impact • Adjustable outer rear seat head restraints • Height-adjustable centre rear seat head restraint (five-door models only) • Three inertia-reel lap and diagonal rear seatbelts • Anti-submarining ramps in all seats – Help prevent occupants sliding underneath the lap belt during a collision • Reinforced rear seat back – Helps prevent heavy items entering the passenger compartment • Driver's seatbelt unfastened audible warning

Additional features	Exp.	Life	Club	Design	SXi
Front seat side-impact airbags	□	□	●	●	●
Full-size curtain airbags	□	□	●	●	●
Pyrotechnic front lap belt pretensioner system	□	□	●	●	●
Electronic park/brake pedal safety interlock (on automatic transmission models)			●	●	●
Electronic Stability Programme-plus (ESP-plus) with traction control – see <b>D3</b> on page 54	○	○ <sup>1</sup>	○ <sup>1</sup>	○	○
ISOFIX child seat restraint system for front passenger's seat (does not include child seat)		○	○	○	○
Deflation Detection System <sup>2</sup>		□	□		
Hill Start Assist <sup>2</sup> – see <b>D4</b> on page 54		□	□		

## Security

**Standard features** • Electronic theft protection for audio equipment • Electronic engine deadlock immobiliser • 'Key left in ignition' audible warning • Visible Vehicle Identification Number (VIN) • Freewheeling door locks • Door-to-door illumination

Additional features	Exp.	Life	Club	Design	SXi
Central locking (doors, tailgate, fuel flap)	●				
Remote control central locking (doors, tailgate, fuel flap) with security deadlocks		●	●	●	●
Welcome lighting		●	●	●	●
Folding key		●	●	●	●

## Heating and ventilation

**Standard features** • Side window demist vents and four adjustable heating and ventilation outlets • Air blend heater with four-speed fan and illuminated controls • Interior pollen filter

Additional features	Exp.	Life	Club	Design	SXi
Interior odour-reducing activated charcoal filter	●	● <sup>3</sup>	● <sup>3</sup>		● <sup>3</sup>
Air-conditioning (includes air recirculation facility)		○	○	●	○
Electronic climate control incorporating air-conditioning (includes graphic information display)				□	□

## Facia, instruments and controls

**Standard features** • Multi-function display panel showing time, date, audio information and outside air temperature (with ice warning function) • Digital clock with automatic RDS time adjustment • Adjustable speed limit audible warning – Allows the driver to set the speed above which an alarm sounds • Trip odometer • Rev counter • Electronically controlled fuel gauge • Low fuel level warning light • Headlight/brake light bulb failure warning light • Service-due indicator • Handbrake-on warning light • Instrument panel light dimmer • Glovebox with lid • Electrical accessory socket

Additional features	Exp.	Life	Club	Design	SXi
Steering column adjustable for reach and rake		□	●	●	●
Leather-covered steering wheel				●	
Leather-covered sports steering wheel					●
Sports instruments				●	●
Multi-function trip computer			□	□	□
Cruise control			□	□	□



Electronic climate control.



Steering column adjustable for reach and rake.

● = Standard equipment  
 ○ = Optional at extra cost  
 □ = Only available as part of an extra-cost option pack (see page 48 for details).  
 Exp. = Expression.

<sup>1</sup> = Also available as part of an extra-cost option pack (see page 48 for details).

<sup>2</sup> = Only available on Easytronic models.

<sup>3</sup> = Activated charcoal filter is deleted if optional air-conditioning is specified.



Stowable luggage compartment cover.



Front door pockets.



Chrome-effect trim on instrument surrounds.

## Seating

**Standard features** • Reclining front seats • Front passenger's underseat storage tray<sup>4</sup> • Adjustable rear seat backrest • Easy-entry front seats with memory function (three-door models only)

<b>Additional features</b>	Exp.	Life	Club	Design	SXi
Driver's seat height adjuster		□	●	●	●
Front passenger's seat height adjuster <sup>5</sup>			○	○	○
Sports-style front seats				●	●
One-piece folding rear seat	●	●			
60/40 split-folding rear seat back			●	●	●

## Additional interior features

**Standard features** • Front door pockets • Rear door pockets (five-door models only) • Rear bottle holders (three-door models only) • Chrome-effect door handles • Drinks holder and coin holders in centre console • Front tiltable driver's and passenger's assist handles • Two rear tiltable passenger assist handles (five-door models only) • Dipping rear-view mirror • Twin sunvisors with vanity mirror and sliding cover • Two rear coat hooks • Luggage compartment cover • Stowage facility for luggage compartment cover behind rear seats • Illuminated luggage area • Load restraint lashing eyes • Interior tailgate handles • Interior courtesy light operated by door switches • Chrome-effect handbrake button • Translucent lighting for radio control

<b>Additional features</b>	Exp.	Life	Club	Design	SXi
Chrome-effect trim on instrument surrounds			●	●	●
Chrome-effect gear knob trim (manual models only)			●	●	●
Satin stone-effect centre console and steering wheel inlays	●	●	● <sup>6</sup>		
Piano black centre console and steering wheel inlays			● <sup>7</sup>	●	
Matt chrome-effect centre console and steering wheel inlays					●
Platinum-coloured seatbelts				●	●
Rear reading light (five-door models only)				●	●
Front map reading lights			○ <sup>5</sup>	●	●
Translucent lighting for heating, window and lighting controls				●	●
Ambient footwell lighting				●	●
Electro-chromatic anti-dazzle rear-view mirror			□	●	□
DualFloor luggage compartment			●	●	●

## Mechanical

**Standard features** • Front-wheel drive • Five-speed manual gearbox • Speed-sensitive electric power-assisted steering • Gas-pressure dampers • Front anti-roll bar

<b>Additional features</b>	Exp.	Life	Club	Design	SXi
Six-speed manual gearbox (1.3CDTi 1.6v (90PS), 1.7CDTi 1.6v models)				●	●
Four-speed automatic transmission with Economy, Sport and Winter driving modes (1.4i 1.6v models only)			○	○	○
Easytronic five-speed transmission with sequential manual gearshift or automatic mode (1.2i 1.6v models only)		○	○		
Progressive rate variable ratio power-assisted steering				○ <sup>8</sup>	●
Sports suspension with lower ride height				○ <sup>8</sup>	●

## Exterior and convenience features

**Standard features** • Heated rear window • Intermittent rear window wash/wipe • Two-speed windscreen wipers with variable intermittent wipe • Tinted glass • Manually foldable door mirrors

<b>Additional features</b>	Exp.	Life	Club	Design	SXi
Rain-sensitive windscreen wipers			□	●	□
Electrically operated front windows with safety autoreverse and one-touch facility		●	●	●	●
Twin electrically adjustable door mirrors (wide-angle on driver's side)	●	●	●		
Twin electrically adjustable/heated door mirrors (wide-angle on driver's side)				●	●
Two-tone horn				●	●
Electrically operated sliding glass sunroof with interior blind <sup>9</sup>			○	○	○
Rear parking distance sensors <sup>10</sup>			○	○	○
Flex-Fix <sup>®</sup> integrated carrier system (includes two-bicycle carrier attachment) <sup>11</sup>			○	○	○
Two-coat metallic or pearlescent paint		○	○	○	○

## Exterior protection and styling

<b>Features</b>	Exp.	Life	Club	Design	SXi
Body-colour bumpers	●	●	●	●	●
Black side-protection mouldings	●	●			
Body-colour side-protection mouldings			●	●	●
Dark-style headlights					●
Part body-colour door mirrors	●	●	●		
Full body-colour door mirrors				●	●
Body-colour door handles			●	●	●
Body-colour tailgate handle	●	●	●	●	●
Black foil on B-pillars <sup>12</sup>				●	●
Chrome-effect exhaust tailpipe extension				□	●



Six-speed manual gearbox.

● = Standard equipment.  
○ = Optional at extra cost.  
□ = Only available as part of an extra-cost option pack (see page 48 for details).  
Exp. = Expression.

<sup>4</sup> = Deleted if optional glass sunroof is specified.  
<sup>5</sup> = Fitted in conjunction with optional glass sunroof. Not available separately.  
<sup>6</sup> = Only on models fitted with Charcoal or Asia Blue trim.  
<sup>7</sup> = Only on models fitted with Indian Red trim.  
<sup>8</sup> = Fitted in conjunction with optional 17-inch alloy wheels. Not available separately.  
<sup>9</sup> = Also includes front passenger's seat height adjuster and front map reading lights. Deletes front passenger's underseat storage tray.  
<sup>10</sup> = Not available in conjunction with Flex-Fix<sup>®</sup> integrated carrier system.  
<sup>11</sup> = Not available in conjunction with rear parking distance sensors. The spare wheel is replaced by an emergency tyre inflation kit to effect a temporary 'get you home' repair.  
<sup>12</sup> = Deleted when optional Black Sapphire two-coat pearlescent paint is specified.



Adaptive Forward Lighting.



Front fog lights.



Automatic Lighting Control (ALC).

## Exterior lighting

**Standard features** • Lights-on audible warning • Electric headlight beam levelling • High-level LED centre brake light • Rear fog light • Dual Ellipsoidal halogen headlights

Additional features	Exp.	Life	Club	Design	SXi
Adaptive Forward Lighting			○	○	○
Automatic Lighting Control			□	●	□
Front fog lights			□	●	●

### Adaptive Forward Lighting – halogen

Optional at extra cost on Club, Design and SXi. Adaptive Forward Lighting is a sophisticated lighting system that 'allows you to see around corners'! New Corsa is one of the first cars in its class to offer such technology. *Autocar* magazine has already described it as a 'must-have' feature. There are two main functions:

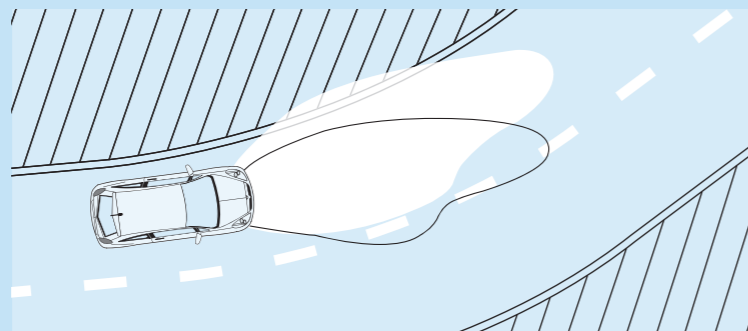

#### Curving light

Speed-dependent, the system is activated by movements of the steering wheel and allows the headlight beam to move up to 15 degrees left or right of the straight ahead position. This ensures that the main headlight beams are always aimed in the direction you're about to go – and not necessarily the direction the front of the car is already pointing in!

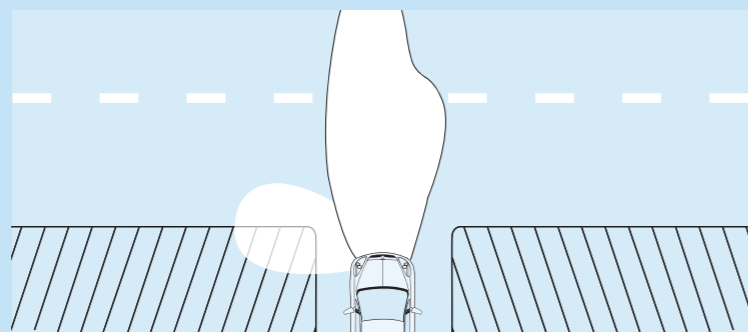

#### Cornering light

When turning into a junction or rounding a tight corner, the cornering light projects an additional beam of light at approximately 90 degrees to the direction of travel, giving the headlights a helpful 'wide angle' effect without detracting from the regular beam. It's activated in one of two ways: simply detecting the application of steering lock at slow speeds and it also reacts to the application of the indicators as you approach a junction.

## Wheels and tyres

Features	Exp.	Life	Club	Design	SXi
Flush wheel covers	●	●	●		
14-inch steel wheels with 185/70 R 14 low profile tyres <b>W1</b>	●	●			
15-inch steel wheels (14-inch spare) with 185/65 R 15 low profile tyres <b>W2</b>			●		
15-inch alloy wheels (14-inch steel spare) with locking bolts and 185/65 R 15 low profile tyres <b>W3</b>			○ <sup>1</sup>		
16-inch seven-spoke alloy wheels (15-inch steel spare) with locking bolts and 195/55 R 16 ultra-low profile tyres <b>W4</b>				●	
16-inch twin-spoke alloy wheels (15-inch steel spare) with locking bolts and 195/55 R 16 ultra-low profile tyres <b>W5</b>					●
17-inch twin-spoke alloy wheels (16-inch steel spare) with locking bolts and 215/45 R 17 ultra-low profile tyres <b>W6</b>				○ <sup>13</sup>	○

● = Standard equipment.  
○ = Optional at extra cost.  
□ = Only available as part of an extra-cost option pack (see page 48 for details).  
Exp. = Expression.

<sup>1</sup> = Also available as part of an extra-cost option pack (see page 48 for details).  
<sup>13</sup> = Also includes sports suspension with lower ride height and progressive rate variable ratio power-assisted steering.



### Standard Wheels

- W1** Standard Expression/Life wheel cover
- W2** Standard Club wheel cover
- W4** Standard Design alloy wheel
- W5** Standard SXi alloy wheel

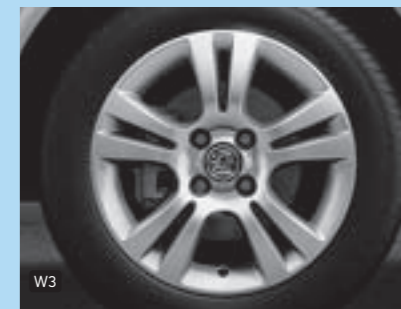

### Optional Wheels

- W3** Optional Club alloy wheel
- W6** Optional Design/SXi alloy wheel







CD 30 stereo radio/CD player.



CD 60 stereo radio/CD with MP3 capability/satellite navigation.

## Audio, navigation and communication

	Exp.	Life	Club	Design	SXi
<b>CD 30 stereo radio/CD player</b> • AM/FM stereo radio with 36 station presets • RDS with Traffic Programme • CD player • Remote display • 17 watts per channel output • 4 speakers	•	•			
<b>CD 30 MP3 stereo radio/CD player with MP3</b> • AM/FM stereo radio with 36 station presets • RDS with Traffic Programme • CD player with MP3 capability • Auxiliary-in connection <sup>14</sup> • Remote display • 20 watts per channel output • 7 speakers			•	•	•
<b>CD 60 stereo radio/CD player with MP3/satellite navigation<sup>14</sup></b> • AM/FM stereo radio with 40 station presets • RDS with Traffic Programme • CD player with MP3 capability • Satellite navigation system • Remote monochromatic graphic information display • 20 watts per channel output • 7 speakers			○	○	○
Mobile phone system with Bluetooth® (does not include phone or cradle) and graphic information display			○	○	○
Steering wheel mounted audio controls			•	•	•

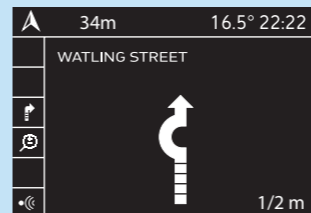

### Satellite navigation

The CD 60 stereo radio/CD with MP3 capability/navigation unit uses the international network of GPS (Global Positioning System) satellites (originally developed by the US military) linked to a comprehensive CD-ROM mapping system to determine your precise location and guide you to your chosen destination virtually anywhere in mainland Britain. The system is very simple to operate, using a range of menu-driven options which are easily accessed via the steering wheel mounted audio controls.

The audible direction guidance prompt gives details of road numbers and motorway junction numbers, while you can also plan your route to avoid toll roads, if required. In addition route guidance

instructions in the form of directional arrows are shown on the centrally mounted monochromatic graphic information display.

The CD 60 also features Traffic Message Channel (TMC), a specific application of RDS used for broadcasting real-time traffic information, delivered either visually or verbally. TMC can also offer dynamic route guidance – alerting the driver to a problem on the planned route and calculating an alternative route to avoid the incident.

The CD-ROM supplied with the system covers all major link roads and streets in towns and cities across mainland Britain. Discs are updated twice a year and are available at extra cost by subscription. Additional discs can be purchased for all major European countries, which means that making a cross-European trip can now be as simple as changing a CD.

### Mobile phone system with Bluetooth®

Vauxhall's factory-fit dual-band mobile phone system has been considerably enhanced. Now fully integrated into the audio and communication system, it also features voice control and will connect wirelessly to phones with Bluetooth technology.

All the required information is displayed on the multi-function display when a mobile phone is in use, while the menus are easily navigated by either the steering wheel audio controls or the multi-function button on the radio. Certain functions can also be controlled by voice activation. Mounted on the centre console, the phone system base unit can be fitted with cradles (available as accessories) for many different mobile phones. Contact your Vauxhall retailer for information regarding compatible mobile phones.



Mobile phone system with Bluetooth®.



Mobile phone system main menu.

● = Standard equipment.  
○ = Optional at extra cost.  
Exp. = Expression.

2 = Only available on Easytronic models.  
10 = Not available in conjunction with Flex-Fix® integrated carrier system.  
15 = Chrome-effect exhaust tailpipe extension is standard on SXi models.

Option packs

	Exp.	Life	Club	Design	SXi
<b>VXR Styling Pack One</b> <sup>10</sup> ● Body-colour front lower spoiler/side sills/ rear lower skirt/rear roof spoiler ● Chrome-effect exhaust tailpipe extension <sup>15</sup>				○	○
<b>Sight and Light Pack</b> ● Rain-sensitive windscreen wipers ● Automatic Lighting Control ● Electro-chromatic anti-dazzle rear-view mirror			○	●	○
<b>Protection Pack</b> ● Front seat side-impact airbags ● Full-size curtain airbags ● Pyrotechnic front lap belt pretensioner system	○	○	●	●	●
<b>Life Plus Pack</b> ● Driver's seat height adjuster ● Steering column adjustable for reach and rake		○			
<b>Club Plus Pack</b> ● 15-inch alloy wheels (14-inch steel spare) with locking bolts ● Front fog lights ● Cruise control ● Multi-function trip computer			○		
<b>Design/SXi Plus Pack</b> ● Electronic climate control incorporating air-conditioning (includes graphic information display) ● Cruise control ● Multi-function trip computer				○	○
<b>Hill Start Assist Pack</b> <sup>2</sup> ● Hill Start Assist ● Electronic Stability Programme-plus (ESP-plus) ● Deflation Detection System		○	○		

**VXR Styling Pack One**<sup>10</sup>  
● Body-colour front lower spoiler/side sills/rear lower skirt/rear roof spoiler  
● Chrome-effect exhaust tailpipe extension<sup>15</sup>



**Sight and Light Pack**  
● Rain-sensitive windscreen wipers  
● Automatic Lighting Control  
● Electro-chromatic anti-dazzle rear-view mirror



Protection Pack

- Front seat side-impact airbags
- Full-size curtain airbags
- Pyrotechnic front lap belt pretensioner system

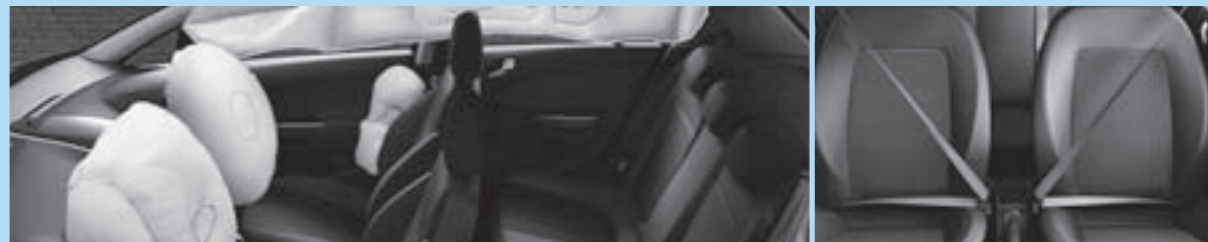

Club Plus Pack

- 15-inch alloy wheels (14-inch steel spare) with locking bolts
- Cruise control
- Front fog lights
- Multi-function trip computer



Design/SXi Plus Pack

- Electronic climate control incorporating air-conditioning (includes graphic information display)
- Cruise control
- Multi-function trip computer



Hill Start Assist Pack<sup>2</sup>

- Hill Start Assist
- Electronic Stability Programme-plus (ESP-plus)
- Deflation Detection System

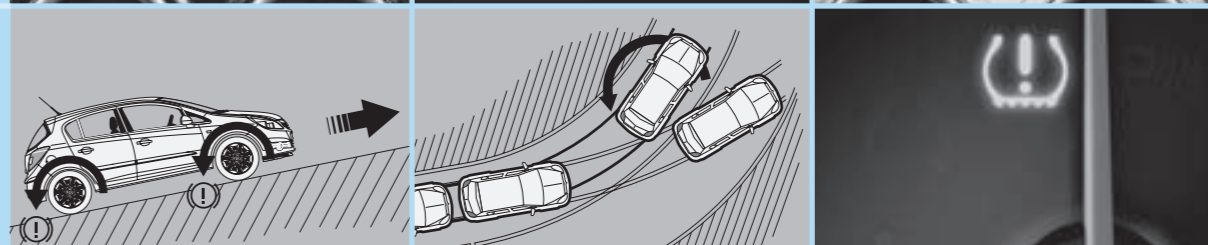

Life Plus Pack

- Driver's seat height adjuster
- Steering column adjustable for reach and rake





Twinport petrol engines.

### Petrol engines

	1.0i 12v Twinport ECOTEC-Compact	1.2i 16v Twinport ECOTEC-4	1.4i 16v Twinport ECOTEC-4
Capacity	998cc	1229cc	1364cc
Maximum power	60PS (44kW) @ 5600rpm	80PS (59kW) @ 5600rpm	90PS (66kW) @ 5600rpm
Maximum torque	88Nm (65 lb.ft.) @ 3800rpm	110Nm (81 lb.ft.) @ 4000rpm	125Nm (92 lb.ft.) @ 4000rpm
Configuration	3 cylinders, 4 valves per cylinder, double overhead camshafts	4 cylinders, 4 valves per cylinder, double overhead camshafts	
Fuel/induction system	Multi-point sequential electronic fuel injection		
Service interval	20,000 miles or 1 year (whichever occurs sooner)		
<b>Benefit in kind company car taxation – 2006/07 and 2007/08 tax years</b>			
Manual models exc. SXi	15%	15%	15%
Manual SXi models	-	16%	16%
Easytronic models	-	15%	-
Automatic 3-door models	-	-	19%
Automatic 5-door models	-	-	20%

### Diesel engines

	1.3CDTi 16v (75PS) ECOTEC-4	1.3CDTi 16v (90PS) ECOTEC-4	1.7CDTi 16v ECOTEC-4
Capacity	1248cc	1248cc	1686cc
Maximum power	75PS (55kW) @ 4000rpm	90PS (66kW) @ 4000rpm	125PS (92kW) @ 4000rpm
Maximum torque	170Nm (126 lb.ft.) @ 1750-2500rpm	200Nm (147 lb.ft.) @ 1750-2500rpm	280Nm (206 lb.ft.) @ 2300rpm
Configuration	4 cylinders, 4 valves per cylinder, double overhead camshafts		
Fuel/induction system	Variable geometry turbocharger with intercooler. Common rail fuel injection		
Service interval	20,000 miles or 1 year (whichever occurs sooner)		
<b>Benefit in kind company car taxation – 2006/07 and 2007/08 tax years</b>			
All models	18%	18%	18%



Common rail turbo diesel engines.

### Performance, fuel economy and emissions

Model	Performance (manufacturer's figures)			Fuel economy mpg (litres/100km)			CO <sub>2</sub> emissions (g/km)
	Maximum speed (mph)	Acceleration (secs) 0-60mph	30-50mph (4th gear)	Urban driving	Extra-urban driving	Combined figure	
<b>Manual</b>							
1.0i 12v	93	17.0	12.2	38.7 (7.3)	61.4 (4.6)	50.4 (5.6)	134
1.2i 16v excluding SXi	104	13.0	12.0	36.7 (7.7)	60.1 (4.7)	48.7 (5.8)	139
1.2i 16v SXi	104	13.0	9.1	35.3 (8.0)	56.5 (5.0)	46.3 (6.1)	146
1.4i 16v	107	11.8	8.2	34.9 (8.1)	55.4 (5.1)	45.6 (6.2)	149
1.3CDTi 16v (75PS)	101	13.6	8.1	48.7 (5.8)	72.4 (3.9)	61.4 (4.6)	124
1.3CDTi 16v (90PS)	107	11.9	7.6	47.9 (5.9)	74.3 (3.8)	61.4 (4.6)	124
1.7CDTi 16v 3-door	121	9.3	6.7	45.6 (6.2)	70.6 (4.0)	58.9 (4.8)	130
1.7CDTi 16v 5-door	121	9.3	6.7	44.8 (6.3)	68.9 (4.1)	57.6 (4.9)	132
<b>Easytronic</b>							
1.2i 16v	104	14.4	-	37.2 (7.6)	61.4 (4.6)	49.6 (5.7)	137
<b>Automatic</b>							
1.4i 16v 3-door	103	13.8	-	32.5 (8.7)	49.6 (5.7)	41.5 (6.8)	163
1.4i 16v 5-door	103	13.8	-	32.1 (8.8)	48.7 (5.8)	40.9 (6.9)	166

The fuel consumption figures shown comply with EC directive 1999/100 to provide a realistic indication of fuel consumption by taking into account everyday driving conditions, such as cold starts, acceleration and braking. These figures take account of the vehicles kerbweight, ascertained in accordance with the above regulation. **Important:** the results given relate to the particular car tested. Driving style, road and traffic conditions, vehicle mileage and standard of maintenance may also affect fuel consumption; therefore the results do not express or imply any guarantee of fuel consumption attainable.

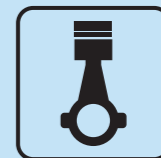

**125PS**  
1.7CDTi 16v engine gives punchy performance



**74.3mpg**  
1.3CDTi 16v (90PS) engine is compact and economical

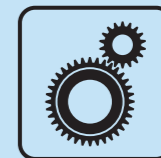

**Easytronic**  
Five-speed sequential transmission

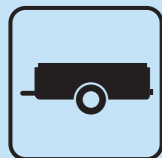

**1300kg**  
Maximum towing weight



**520kg**  
Maximum carrying capacity

### Weights and towing data (kg)

	Kerbweight (Gross vehicle weight)				Maximum towing weights Trailer with brakes (without brakes)			
	3-door		5-door		3-door		5-door	
1.0i 12v Expression	1025	(1545)	-	-	500	(450)	-	-
1.0i 12v Life	1025	(1545)	1070	(1565)	500	(450)	500	(500)
1.2i 16v Life (exc. Easytronic)	1055	(1555)	1085	(1585)	850	(450)	850	(500)
1.2i 16v Life Easytronic	1055	(1555)	1085	(1585)	800	(450)	800	(500)
1.2i 16v Club (exc. Easytronic)	1070	(1555)	1092	(1585)	850	(450)	850	(500)
1.2i 16v Club Easytronic	1070	(1555)	1092	(1585)	800	(450)	800	(500)
1.2i 16v Design	1096	(1575)	1117	(1605)	850	(450)	850	(500)
1.2i 16v SXi	1069	(1555)	1099	(1585)	850	(450)	850	(500)
1.4i 16v Club	1080	(1565)	1095	(1595)	1000	(500)	1000	(500)
1.4i 16v Club automatic	1105	(1590)	1120	(1620)	1000	(500)	1000	(500)
1.4i 16v Design	1106	(1585)	1120	(1615)	1000	(500)	1000	(500)
1.4i 16v Design automatic	1131	(1610)	1145	(1640)	1000	(500)	1000	(500)
1.4i 16v SXi	1079	(1565)	1102	(1595)	1000	(500)	1000	(500)
1.4i 16v SXi automatic	1104	(1590)	1127	(1620)	1000	(500)	1000	(500)
1.3CDTi 16v (75PS) Life	1130	(1645)	1160	(1675)	1000	(500)	1000	(500)
1.3CDTi 16v (75PS) Club	1145	(1645)	1167	(1675)	1000	(500)	1000	(500)
1.3CDTi 16v (90PS) Design	1201	(1695)	1222	(1725)	1200	(500)	1200	(500)
1.3CDTi 16v (90PS) SXi	1174	(1675)	1204	(1705)	1200	(500)	1200	(500)
1.7CDTi 16v Design	1244	(1750)	1277	(1780)	1300	(500)	1300	(500)
1.7CDTi 16v SXi	1217	(1730)	1259	(1760)	1300	(500)	1300	(500)

**Please note:** For Life, Club and SXi models fitted with optional air-conditioning 20kg must be added to both kerbweight and gross vehicle weight. **Gross vehicle weight** is the total permissible weight of the vehicle including passengers and their luggage. To determine total carrying capacity, which includes the weight of the driver, deduct kerbweight from gross vehicle weight. The **maximum roof rack loading** should not exceed a total of 75kg. The **maximum towing weights** are based on the ability of the car – with two occupants of 70kg each – to restart on a 12% gradient, which is approximately 1 in 8.3, at sea level. At altitudes above 1500 metres, the engine output may drop with a corresponding reduction in towing capability. Any extra weight, such as luggage or additional passengers, should be deducted from the maximum towing weight. With a trailer fully loaded, **maximum nose weight** should not exceed 55kg. Always fit Vauxhall towing attachments and accessories available from your Vauxhall retailer. They are designed specifically for Vauxhall models and carry a 12-month guarantee.

### Vauxhall Assistance and warranties\*

- A one-year unlimited mileage manufacturer's warranty
- Second and third year no-fee customer option warranty up to 60,000 miles (from first registration)
- Vauxhall Assistance for 12 months from first registration
- Six years' body panel anti-perforation warranty

\* = Warranty is only available on vehicles sourced from Vauxhall Motors Ltd. Terms and conditions apply – please see your Vauxhall retailer for details.

### Optional transmissions

#### Five-speed Easytronic transmission:

Available at extra cost on 1.2i 16v Life and Club models. Easytronic transmission is a five-speed manual gearbox with a fully automatic mode. In manual mode, you simply push the lever forward or back to shift gears up or down sequentially. The fascia display tells you what gear you're in – 1 to 5, N for Neutral or A for Auto. Switch to fully automatic mode and it has many of the features of a regular automatic including a kickdown function. There's no clutch pedal so you can drive it on an automatic-only driving licence. Easytronic also comes with a winter mode, which selects second gear for standing starts in slippery conditions.

#### Four-speed automatic transmission:

Optional at extra cost on 1.4i 16v models only. Electronically controlled, with Economy, Sport and Winter driving modes. Fluid drive with torque converter and lock-up on third and fourth ratios eliminating wasteful slip. Electronic park/brake pedal safety interlock. Neutral control fuel-saving feature. Transmission oil cooler integral with engine coolant radiator.

### Steering

- Rack and pinion
- Electric power-assisted steering standard on all models – variable rate on diesel models – progressive variable rate on SXi models, and on Design models fitted with optional 17-inch alloy wheels
- Turning circle (kerb-to-kerb): All models except Design with optional 17-inch alloy wheels and SXi – 10.10m (33.2ft). Design with optional 17-inch alloy wheels and SXi – 11.10m (36.4ft)

### Suspension

- Front:** Independent, MacPherson struts with gas-pressure damper cartridge and coil springs. Anti-roll bar.
- Rear:** Compound crank with progressive-rate mini-block coil springs and gas-pressure dampers.
- Suspension uprated and lowered by 20mm on SXi models, and on Design models fitted with optional 17-inch alloy wheels

### Brakes

- Anti-lock Braking System (ABS)
- Electronic Brakeforce Distribution
- Emergency Brake Assist
- Cornering Brake Control
- Straight Line Stability control
- Dual circuit, diagonally split, dual rate servo-assisted system
- Low brake fluid level warning light

#### 1.0i 12v

Front discs: 257mm diameter  
Rear drums: 203mm diameter

#### 1.2i 16v (exc. Easytronic and SXi)

Front discs: 257mm diameter  
Rear drums: 203mm diameter

#### 1.2i 16v (Easytronic and SXi)

Front ventilated discs: 257mm diameter  
Rear drums: 203mm diameter

#### 1.4i 16v/1.3CDTi 16v (75PS)

Front ventilated discs: 257mm diameter  
Rear drums: 228mm diameter

#### 1.3CDTi 16v (90PS)

Front ventilated discs: 284mm diameter  
Rear drums: 228mm diameter

#### 1.7CDTi 16v

Front ventilated discs: 278mm diameter  
Rear discs: 264mm diameter

### Body

- Aerodynamic drag co-efficient: Cd 0.33

### Fuel tank capacity

- 45 litres (9.9 gallons)



Five-speed Easytronic transmission.



MacPherson strut front suspension.



Compound crank rear suspension.

## Chassis safety features explained

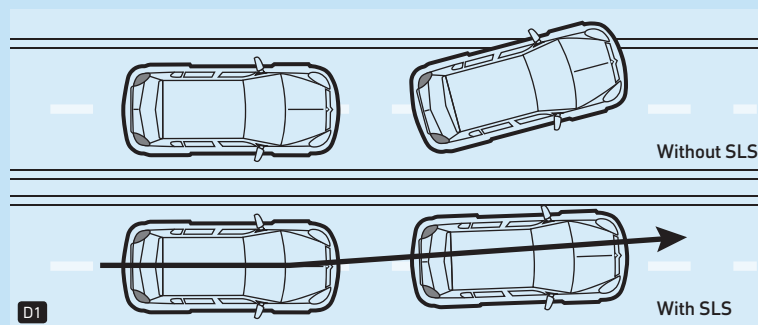

### D1. Straight Line Stability control (SLS)

Optimises directional stability when braking, particularly on roads with varying levels of grip on either side of the car – or those with a pronounced ‘crown’. It does this by monitoring the steering angle and comparing this to the rotational speeds of the wheels. By reducing brake pressure on the front and rear wheels on the appropriate side, it restores the direction of travel to the ‘straight-ahead’ position.

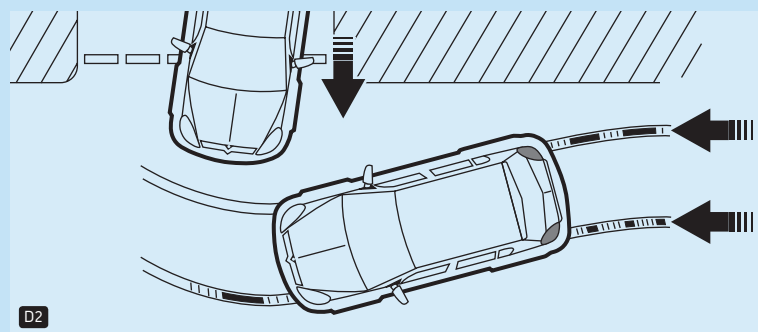

### D2. Cornering Brake Control

Makes the car easier to control in extreme situations, especially when braking sharply on a bend. Particularly effective when carrying out emergency manoeuvres. The system works by sensing the different rotational speeds of the individual road wheels and co-ordinating the level of braking pressure applied to each wheel.

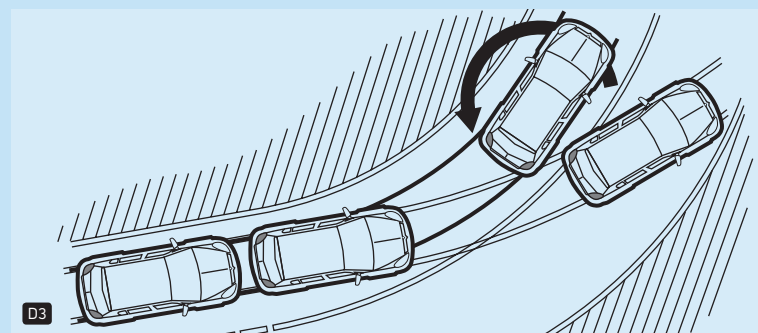

### D3. Electronic Stability Programme-plus (ESP-plus) with Enhanced Understeering Control

The system works in conjunction with the car’s traction control set-up, sensing when the vehicle is about to slide on a bend and applying corrective braking to the appropriate wheel or wheels, correcting the slide and helping you regain control more rapidly (with conventional ESP systems the braking force is applied at only one wheel).

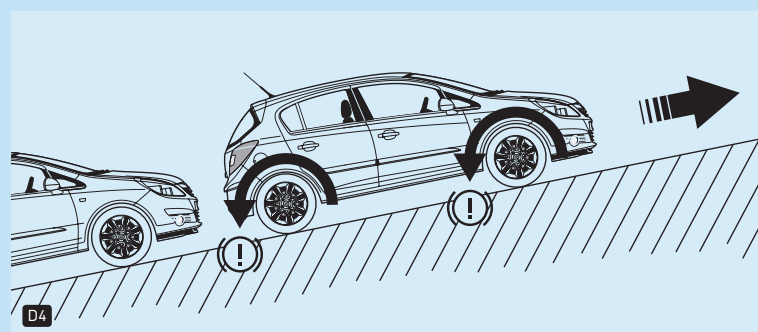

### D4. Hill Start Assist\*\*

Replicates the creep and hold function of an automatic transmission, maintaining the brake pressure for up to 1.5 seconds after the brake pedal has been released for added safety when pulling away or parking on a slope

\*\* = Only available with Easytronic transmission.

## Exterior dimensions millimetres (inches)

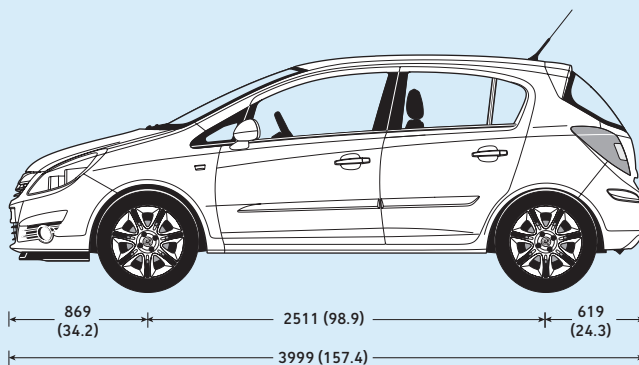
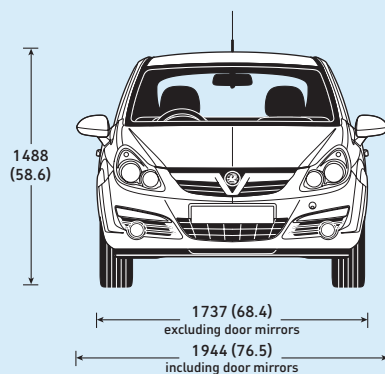
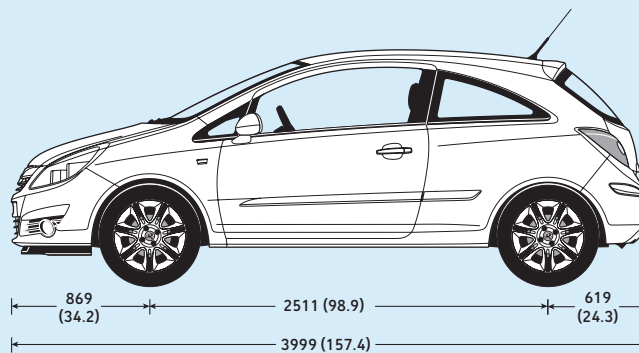
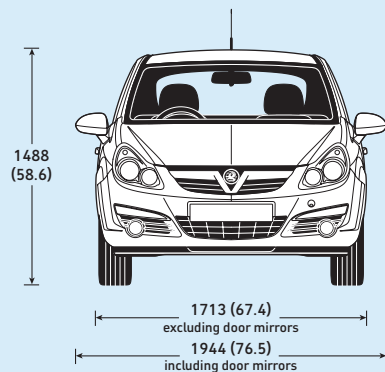

## Luggage capacities (VDA method)

	3-door		5-door	
	litres	cu.ft	litres	cu.ft
Rear seat up (under hinged luggage compartment cover)*	285	10.0	285	10.0
Rear seat down (to glassline)	690	24.4	700	24.7
Rear seat down (to roof)	1050	37.1	1100	38.8

\* = DualFloor in lowest position.

## Luggage compartment dimensions

	3-door		5-door	
	mm	inches	mm	inches
Maximum length (seats up)	703	27.7	703	27.7
Maximum length (behind front seats)	1348	53.1	1348	53.1
Maximum width	969	38.1	969	38.1
Maximum height	839	33.0	872	34.3