



VIVARO

Owner's Manual

Contents

Emergency numbers		
For emergency service call the Vauxhall Incident Manager		0800 55 33 88 (Free Linkline)*
Vauxhall Assistance General Enquiries		0845 7565 565
You will need to provide:	Vehicle registration number	Model and colour of your Vauxhall
	Contact telephone number	Details of your precise location

* Calls may be chargeable from mobile phones

Introduction	2
In brief	6
Keys, doors and windows	21
Seats, restraints	46
Storage	78
Instruments and controls	93
Lighting	135
Climate control	144
Driving and operating	158
Vehicle care	235
Service and maintenance	284
Technical data	289
Customer information	298
Index	304

Introduction

Fuel	Designation	<input type="text"/>		
Engine oil	Grade	<input type="text"/>		
	Viscosity	<input type="text"/>		
Tyre pressure	Tyre size		Front	Rear
	Summer tyres	<input type="text"/>	<input type="text"/>	<input type="text"/>
	Winter tyres	<input type="text"/>	<input type="text"/>	<input type="text"/>
Weights	Gross vehicle weight rating	<input type="text"/>		
	- Kerb weight, basic model	<input type="text"/>		
	= Loading	<input type="text"/>		

Vehicle specific data

Please enter your vehicle's data on the previous page to keep it easily accessible.

Refer to the sections "Service and maintenance", "Technical data", the vehicle's identification plate and national registration documents.

Introduction

Your **Vivaro Life / Vivaro** is a designed combination of advanced technology, safety, environmental friendliness and economy.

This Owner's Manual provides you with all the necessary information to enable you to drive your vehicle safely and efficiently.

Make sure your passengers are aware of the possible risk of accident and injury which may result from improper use of the vehicle.

You must always comply with the specific laws and regulations of the country that you are in. These laws may differ from the information in this Owner's Manual.

Disregarding the description given in this manual may affect your warranty.

When this Owner's Manual refers to a workshop visit, we recommend your Vauxhall Authorised Repairer.

All Vauxhall Authorised Repairers provide first-class service at reasonable prices. Experienced mechanics trained by Vauxhall work according to specific Vauxhall instructions.

The customer literature pack should always be kept ready to hand in the vehicle.

Using this manual

- This manual describes all options and features available for this model. **Certain descriptions, including those for display and menu functions, may not apply to your vehicle due to model variant, country specifications, special equipment or accessories.**
- The "In brief" section will give you an initial overview.

- The table of contents at the beginning of this manual and within each section shows where the information is located.
- The index will enable you to search for specific information.
- This Owner's Manual depicts left-hand drive vehicles. Operation is similar for right-hand drive vehicles.
- The Owner's Manual uses the engine identifier code. The corresponding sales designation and engineering code can be found in the section "Technical data".
- Directional data, e.g. left or right, or front or back, always relate to the direction of travel.
- Displays may not support your specific language.
- Display messages and interior labelling are written in **bold** letters.

Danger, Warnings and Cautions

Danger

Text marked ** Danger** provides information on risk of fatal injury. Disregarding this information may endanger life.

Warning

Text marked ** Warning** provides information on risk of accident or injury. Disregarding this information may lead to injury.

Caution

Text marked **Caution** provides information on possible damage to the vehicle. Disregarding this information may lead to vehicle damage.

Symbols

Page references are indicated with ⇨.
⇨ means "see page".

Page references and index entries refer to the indented headings given in the section table of content.

Thank you for choosing a Vauxhall.

We wish you many hours of pleasurable driving.

Your Vauxhall Team

In brief

Initial drive information

Vehicle unlocking



Press  to unlock the vehicle. Open the doors by pulling the handles.

Tailgate

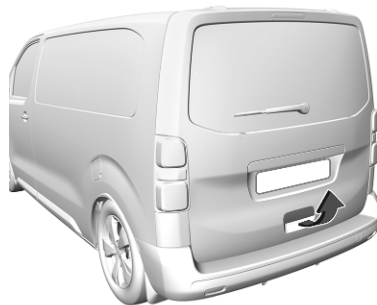

After unlocking, press the tailgate button and open the tailgate.

Radio remote control ⇨ 22.

Central locking system ⇨ 24.

Electronic key system ⇨ 23.

Load compartment ⇨ 32.

Sliding door ⇨ 30.

Seat adjustment

Longitudinal adjustment

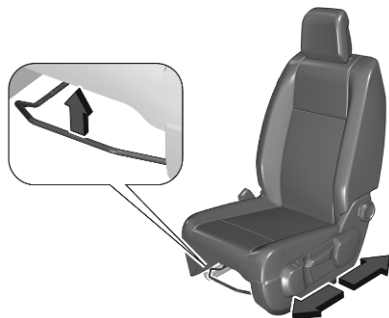

Pull the handle, slide the seat, then release the handle. Try to move the seat back and forth to ensure that the seat is locked in place.

Seat position ⇄ 47.

Manual seat adjustment ⇄ 47.

Backrest inclination



Turn handwheel to adjust inclination. Do not lean on the backrest while adjusting.

Seat position ⇄ 47.

Manual seat adjustment ⇄ 47.

Seat height

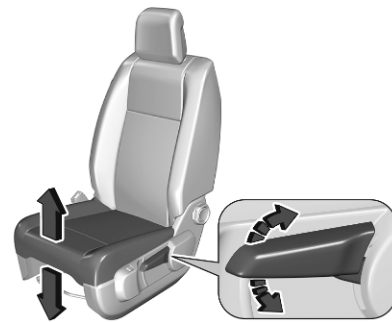

Lever pumping motion

up : seat higher
down : seat lower

Seat position ⇄ 47.

Manual seat adjustment ⇄ 47.

Lumbar support



Turn the handwheel to suit personal requirements.

Head restraint adjustment

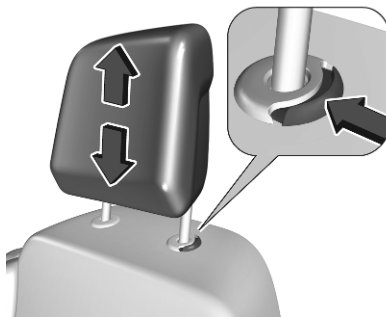

Move the head restraint upwards or downwards. If the head restraint is engaged press the catch and move the head restraint.

Head restraints ⇨ 46.

Seat belt



Pull out the seat belt and fasten in belt buckle. The seat belt must not be twisted and must fit close against the body. The backrest must not be tilted back too far (maximum approx. 25°).

To unfasten belt, press red button on belt buckle.

Seat position ⇨ 47.

Seat belts ⇨ 56.

Airbag system ⇨ 60.

Mirror adjustment

Interior mirror

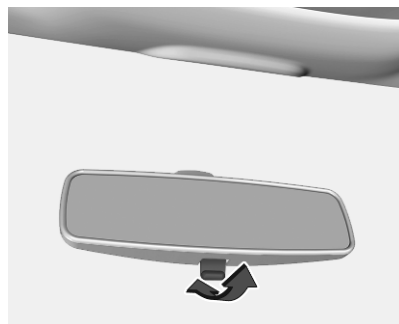



To adjust the mirror, move the mirror housing in the desired direction.

Manual anti-dazzle interior mirror
↔ 40.

Automatic anti-dazzle interior mirror
↔ 40.

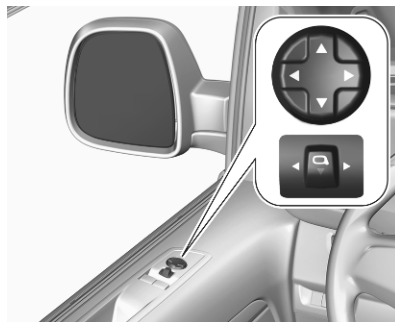
Exterior mirrors



Select the relevant exterior mirror by pushing the mirror button  to the left or right.

Adjust the respective mirror with the four-way control.

Convex mirrors ↔ 38.

Electric adjustment ↔ 38.

Folding mirrors ↔ 39.

Heated mirrors ↔ 39.

Steering wheel adjustment

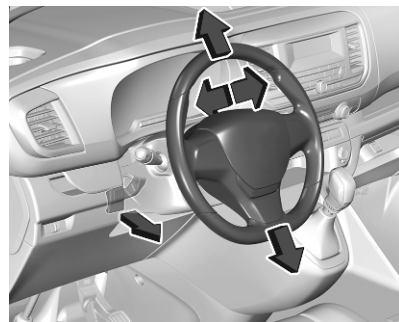

Unlock lever, adjust steering wheel, then engage lever and ensure it is fully locked. Do not adjust steering wheel unless vehicle is stationary and steering wheel lock has been released.

Seat position ↔ 47.

Ignition positions ↔ 159.

Instrument panel overview

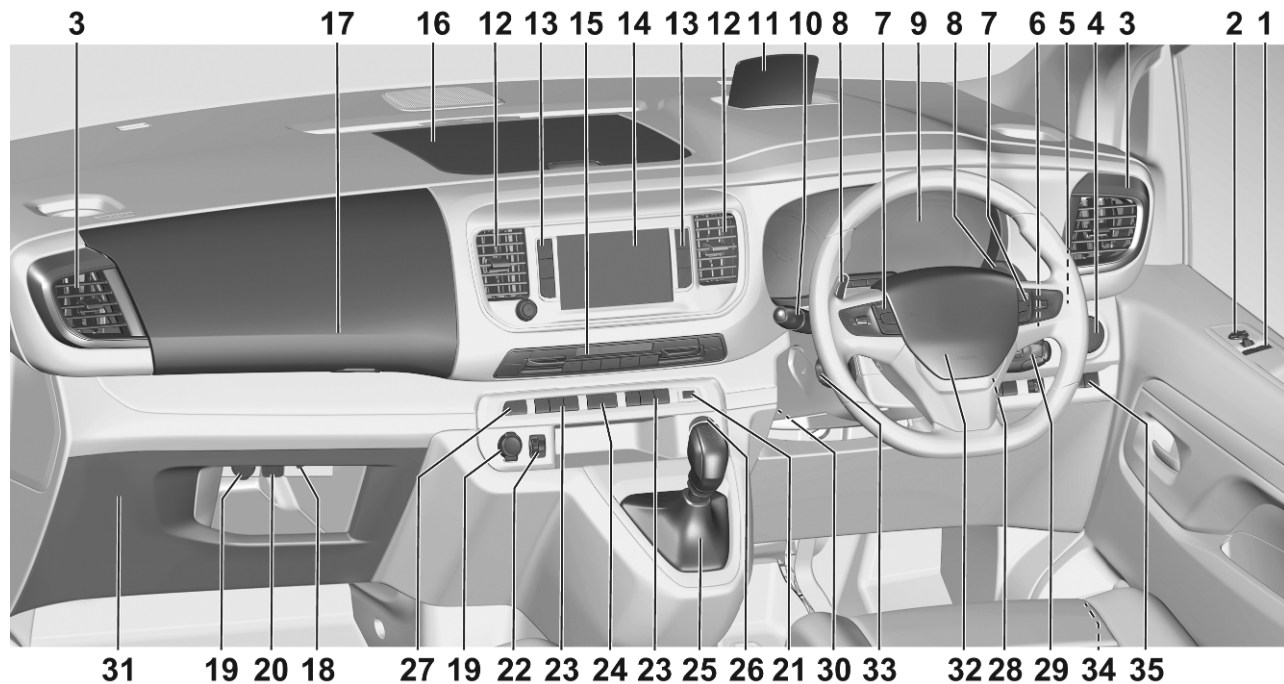



<p>1 Power windows 41</p> <p>2 Exterior mirrors 38</p> <p>3 Side air vents 155</p> <p>4 Selective ride control 184</p> <p>5 Turn lights 139</p> <p style="padding-left: 20px;">Headlight flash 137</p> <p style="padding-left: 20px;">High beam 136</p> <p style="padding-left: 20px;">Exit lighting 142</p> <p>6 Head-up display controls ... 125</p> <p>7 Steering wheel controls 94</p> <p>8 Steering wheel paddles 94</p> <p>9 Instruments 105</p> <p style="padding-left: 20px;">Driver Information Centre ... 118</p> <p>10 Button for Driver Information Centre 118</p> <p style="padding-left: 20px;">Windscreen wiper and washer 96</p> <p style="padding-left: 20px;">Rear wiper and washer 97</p> <p>11 Head-up display 125</p> <p>12 Air vents 155</p> <p>13 Control elements for Info Display 123</p>	<p>14 Info Display 123</p> <p>15 Climate control system 146</p> <p>16 Storage compartment 79</p> <p>17 Storage compartment 79</p> <p>18 AUX input</p> <p>19 Power outlet 98</p> <p>20 Airbag deactivation 64</p> <p>21 USB port 98</p> <p>22 Seat heating 51</p> <p>23 Electronic Stability Control and Traction Control 183</p> <p style="padding-left: 20px;">Tyre deflation detection system 264</p> <p style="padding-left: 20px;">Stop-start system 163</p> <p style="padding-left: 20px;">Heated windscreen 44</p> <p style="padding-left: 20px;">Electric child locks 28</p> <p style="padding-left: 20px;">Central locking system 24</p> <p>24 Hazard warning flashers 138</p> <p>25 Manual transmission 177</p> <p style="padding-left: 20px;">Automatic transmission 174</p> <p>26 Power button 160</p> <p>27 Automatic locking 28</p>	<p>28 Ignition switch 159</p> <p>29 Control elements for Infotainment system</p> <p>30 Steering wheel adjustment ... 94</p> <p>31 Fuse box 256</p> <p>32 Horn 95</p> <p>33 Cruise control 186</p> <p style="padding-left: 20px;">Speed limiter 189</p> <p style="padding-left: 20px;">Semi-adaptive cruise control 193</p> <p>34 Bonnet release lever 239</p> <p>35 Anti-theft alarm system 36</p> <p style="padding-left: 20px;">Lane departure warning 213</p> <p style="padding-left: 20px;">Side blind spot alert 207</p> <p style="padding-left: 20px;">Parking assist 204</p> <p style="padding-left: 20px;">Temperature preconditioning 153</p> <p style="padding-left: 20px;">Headlight range adjustment 137</p> <p style="padding-left: 20px;">High beam assist 136</p>
---	--	--

Exterior lighting



AUTO : automatic light control switches automatically between daytime running light and headlight

 : sidelights
 : headlight

Automatic light control ⇨ 136.

Front fog lights ⇨ 139.

Rear fog light ⇨ 139.

Headlight flash and high beam

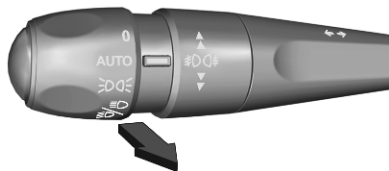

High beam ⇨ 136.

High beam assist ⇨ 136.

Headlight flash ⇨ 137.

Turn lights

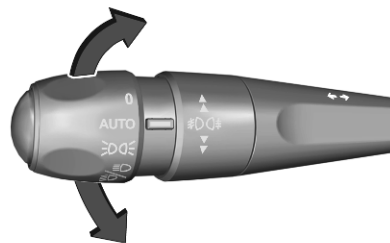

up : right turn lights
down : left turn lights

Turn lights ⇨ 139.

Hazard warning flashers



Operated by pressing .
Hazard warning flashers ⇨ 138.

Horn

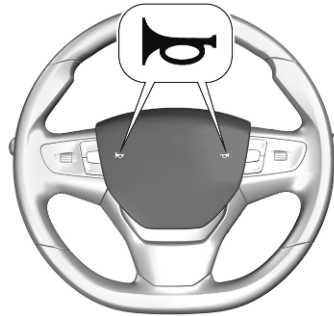

Press .

Washer and wiper systems

Windscreen wiper

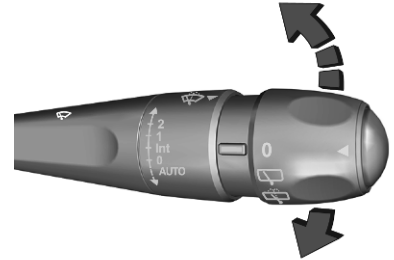

- 2** : fast
- 1** : slow
- INT** : interval wiping
- 0** : off
- AUTO** : automatic wiping with rain sensor

For a single wipe when the windscreen wiper is off, press the lever down.

Windscreen wiper ⇨ 96.

Windscreen washer



Windscreen washer system ⇨ 96.

Washer fluid ⇨ 242.

Wiper blade replacement ⇨ 245.

Rear window wiper



0 : off

 : rear window wiper

 : rear window washer

Rear window washer



Set to .

Washer fluid is sprayed on the rear window and the wiper wipes a few times.

Rear window wiper and washer
⇨ 97.

Climate control

Heated rear window

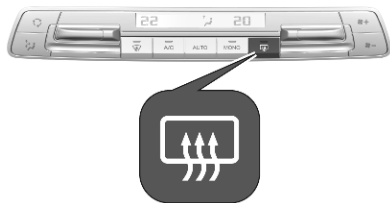



The heating is operated by pressing .

Heated rear window ⇨ 43.

Heated windscreen ⇨ 44.

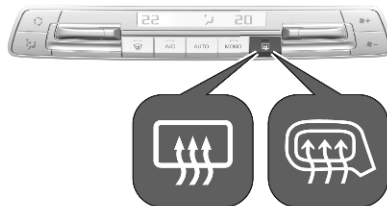
Heated exterior mirrors



Depending on the version, heating is operated by pressing  or .



Heating works with the engine running and is switched off automatically after a short time.

Heated exterior mirrors ⇨ 39.

Demisting and defrosting the windows

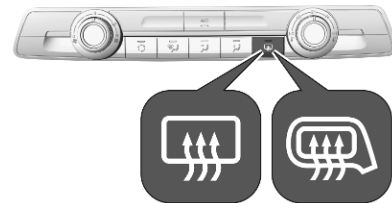
Heating and ventilation system, air conditioning system



- Set fan speed  to highest level.
- Set temperature controller  to warmest level.
- Switch on cooling **A/C**, if required.
- Switch on heated rear window .
- Open side air vents as required and direct them towards the door windows.

Notice

If the settings for demisting and defrosting are selected, an Autostop may be inhibited.

If the settings for demisting and defrosting are selected while the engine is in an Autostop, the engine will restart automatically.

Stop-start system ⇨ 163.

Heating and ventilation system
⇨ 144.

Air conditioning system ⇨ 146.

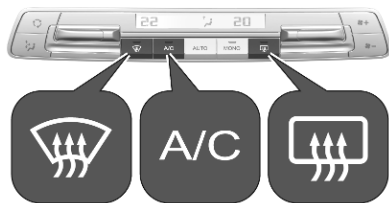
Electronic climate control system

- Press . The LED in the button illuminates to indicate activation.
- Air conditioning and automatic mode are automatically switched on. The LED in the button **A/C** illuminates, **AUTO** is shown in the display.
- Temperature and air distribution are set automatically and the fan runs at high speed.
- Switch on heated rear window .

- Switch on heated windscreen .
- To return to previous mode, press again.

Notice

If is pressed while the engine is running, an Autostop will be inhibited until is pressed again.

If is pressed while the engine is in an Autostop, the engine will restart automatically.

Electronic climate control system
⇨ 148.

Transmission

Manual transmission

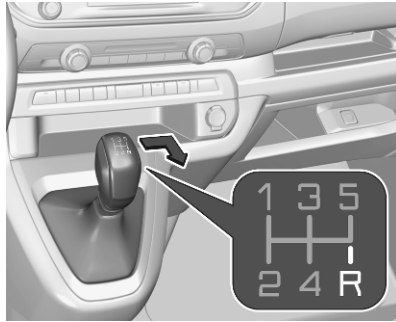

To engage reverse on 5-speed transmission, depress the clutch pedal and move the selector lever to the right and rear.

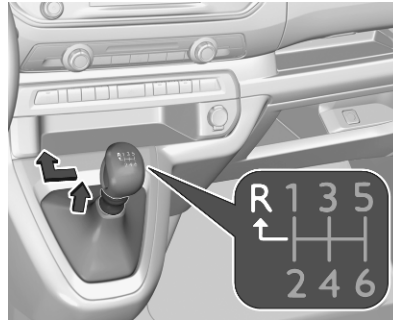

To engage reverse on 6-speed transmission, depress the clutch pedal, pull the ring under the selector lever and move the selector lever quite to the left and front.

Manual transmission ⇨ 177.

Automatic transmission

Type A



Turn the gear selector.

- P** : park position, front wheels are locked, engage only when the vehicle is stationary and the parking brake is applied
- R** : reverse gear, engage only when the vehicle is stationary
- N** : neutral
- D** : automatic mode
- M** : manual mode

Type B



Turn the gear selector.

R : reverse gear, engage only when the vehicle is stationary

N : neutral

A : automatic mode

M : manual mode

Automatic transmission ⇨ 174.

Starting off

Check before starting off

- tyre pressure ⇨ 263 and condition ⇨ 296
- engine oil level and fluid levels ⇨ 240
- all windows, mirrors, exterior lighting and number plates are free from dirt, snow and ice and are operational
- proper position of mirrors ⇨ 38, seats ⇨ 47 and seat belts ⇨ 57
- brake function at low speed, particularly if the brakes are wet

Starting the engine

Ignition switch

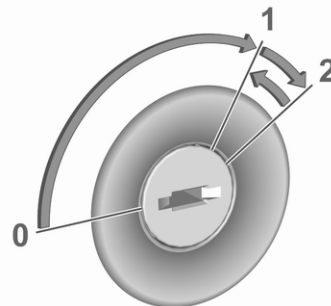

- turn key to position **1**
- move the steering wheel slightly to release the steering wheel lock
- manual transmission: operate clutch and brake pedal
automatic transmission: operate brake pedal and move selector lever to **P** or **N**
- do not operate accelerator pedal

- diesel engine: wait until control indicator  for preheating extinguishes
- turn key to position **2** and release after engine has been started

Starting the engine ⇨ 161.

Start power button





- manual transmission: operate clutch and brake pedal
- automatic transmission: operate brake pedal and move selector lever to **P** or **N**
- do not operate accelerator pedal
- press **Start/Stop** button
- release button after starting procedure begins

Stop-start system



If the vehicle is at a low speed or at a standstill and certain conditions are fulfilled, an Autostop is activated.

An Autostop is indicated by control indicator .

Manual transmission: to restart the engine, depress the clutch pedal again. Control indicator  extinguishes.

Automatic transmission: to restart the engine, release the brake pedal. Control indicator  extinguishes.

Stop-start system ⇨ 163.

Parking

⚠ Warning

- Do not park the vehicle on an easily ignitable surface. The high temperature of the exhaust system could ignite the surface.
- Always apply the parking brake.
- If the vehicle is on a level surface or uphill slope, engage first gear or set the selector lever to position **P** (automatic transmission type A) / **N** (automatic transmission type B). On an uphill slope, turn the front wheels away from the kerb.
If the vehicle is on a downhill slope, engage reverse gear or set the selector lever to position **P** (automatic transmission type A) / **N** (automatic transmission type B). Turn the front wheels towards the kerb.
- Close the windows.

- Switch off the engine.
- Remove the ignition key from the ignition switch or switch off ignition on vehicles with power button. Turn the steering wheel until the steering wheel lock is felt to engage.

- Lock the vehicle with  on the radio remote control.
Activate the anti-theft alarm system ⇨ 36.
- The engine cooling fans may run after the engine has been switched off ⇨ 238.

Caution

After running at high engine speeds or with high engine loads, operate the engine briefly at a low load or run in neutral for approx. 30 seconds before switching off, in order to protect the turbocharger.

Keys, locks ⇨ 21.

Laying-up the vehicle for a long period of time ⇨ 236.

Keys, doors and windows

Keys, locks	21
Keys	21
Radio remote control	22
Electronic key system	23
Central locking system	24
Automatic locking	28
Child locks	28
Doors	30
Sliding doors	30
Load compartment	32
Vehicle security	35
Anti-theft locking system	35
Anti-theft alarm system	36
Immobiliser	38
Exterior mirrors	38
Convex shape	38
Electric adjustment	38
Folding mirrors	39
Heated mirrors	39
Interior mirrors	40
Manual anti-dazzle	40
Automatic anti-dazzle	40
Child surveillance mirror	40

Windows	41
Windscreen	41
Power windows	41
Rear windows	42
Heated rear window	43
Heated windscreen	44
Sun visors	44
Roller blinds	44
Roof	45
Glass panel	45

Keys, locks

Keys

Caution
Do not attach heavy or bulky items to the ignition key.

Replacement keys

The key number is specified on a detachable tag.

The key number must be quoted when ordering replacement keys as it is a component of the immobiliser system.

Locks ⇨ 280.

Central locking ⇨ 24.

Starting the engine ⇨ 161.

Radio remote control ⇨ 22.

Electronic key ⇨ 23.

The code number of the adapter for the locking wheel nuts is specified on a card. It must be quoted when ordering a replacement adapter.

Wheel changing ⇨ 270.

Key with foldaway key section

Press button to extend. To fold the key, first press the button.

Lock cylinders

Designed to free-wheel if they are forcefully rotated without the correct key or if the correct key is not fully inserted. To reset, turn cylinder with the correct key until its slot is vertical, remove key then re-insert it. If the cylinder still free-wheels, turn the key through 180° and repeat operation.

Radio remote control

Depending on the version, the radio remote control enables the operation of the following functions:

- central locking system ⇨ 24
- selective unlocking ⇨ 24
- anti-theft locking system ⇨ 35
- anti-theft alarm system ⇨ 36
- tailgate unlocking ⇨ 24
- power sliding doors ⇨ 30
- power windows ⇨ 41
- mirrors folding ⇨ 39

- vehicle locator lighting ⇨ 143
- peripheral lighting ⇨ 143

The remote control has a range of up to several metres, but may also be much less due to external influences. The hazard warning flashers confirm operation.

Handle with care, protect from moisture and high temperatures and avoid unnecessary operation.

Replacing battery in radio remote control

Replace the battery as soon as the range reduces.



Batteries do not belong in household waste. They must be disposed of at an appropriate recycling collection point.

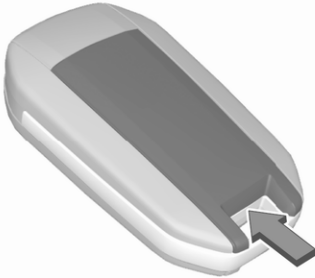

1. Remove the back cover from the remote control.
2. Extract the flat battery from its location.
3. Replace battery with a battery of the same type. Pay attention to the installation position.
4. Clip the back cover in place.

Fault

If the central locking system cannot be operated with the radio remote control, the cause may be one of the following:

- Fault in radio remote control.
- The battery voltage is too low.

- Overload of the central locking system by operating at frequent intervals, the power supply is interrupted for a short time.
- Interference from higher-power radio waves from other sources.

Manual unlocking ⇨ 24.

Electronic key system



Depending on the version, the electronic key system enables a keyless operation of the following functions:

- central locking system ⇨ 24
- tailgate unlocking
- headlight activation

The electronic key simply needs to be on the driver's person.

Additionally, the electronic key includes the functionality of the radio remote control ⇨ 22.

Handle with care, protect from moisture and high temperatures and avoid unnecessary operation.

Notice

To save battery power, the keyless functions are set to stand-by after 21 days of non-use. To reactivate the functions, press a button on the electronic key.

Replacing battery in electronic key

Replace the battery as soon as the system no longer operates properly or the range is reduced.



Batteries do not belong in household waste. They must be disposed of at an appropriate recycling collection point.



1. Remove the cover.
2. Extract the flat battery from its location.

3. Replace battery with a battery of the same type. Pay attention to the installation position.
4. Clip the cover in place.

Fault

If the central locking cannot be operated or the engine cannot be started, the cause may be one of the following:

- Fault in electronic key.
- Electronic key is out of reception range.
- The battery voltage is too low.
- Overload of the central locking system by operating at frequent intervals, the power supply is interrupted for a short time.
- Interference from higher-power radio waves from other sources.

To rectify the cause of the fault, change the position of the electronic key.

Manual unlocking ⇨ 24.

Central locking system

Unlocks and locks doors, load compartment and fuel filler flap.

A pull on an interior door handle unlocks and opens the respective door.

Notice

In the event of an accident in which airbags or belt pretensioners are deployed, the vehicle is automatically unlocked.



Notice

A short time after unlocking with the remote control the doors are locked automatically if no door has been opened. A precondition is that the setting is activated in the vehicle personalisation ⇨ 127.

Selective unlocking

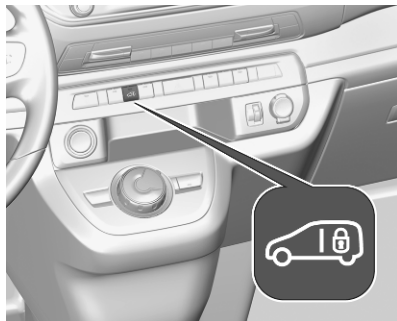
Selective unlocking allows you to unlock either the front doors and the fuel filler flap or the sliding doors, the rear doors / the tailgate. Selective unlocking has to be configured.



To activate, switch on the ignition and then press  more than 2 seconds. The LED illuminates. An audible signal is given and depending on the configuration of the vehicle, a message is displayed in Info Display. To deactivate, switch on the ignition and then press  for more than 2 seconds. The LED extinguishes.



Remote control operation

Unlocking





Press .

Unlocking mode can be set. Two settings are selectable:

- All doors and load compartment will be unlocked by pressing .
- Only the driver's door and the passenger door will be unlocked by pressing .

Unlocking the load compartment

Press  or press  two times to unlock the load compartment only, i.e. sliding doors and rear doors or tailgate.

Locking

Close doors and the load compartment.



Press .

If the vehicle is not closed properly, the central locking system will not work.

Confirmation

Operation of the central locking system is confirmed by the hazard warning flashers. A precondition is that the setting is activated in the vehicle personalisation ↪ 127.

Electronic key system operation



The electronic key must be outside the vehicle, within a range of approx. one metre of the relevant door side.

Unlocking

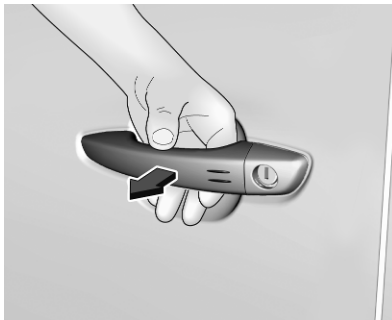

Pass a hand behind the door handle of one of the front doors, the sliding doors, the hinged doors or press the tailgate button.

Unlocking mode can be set in the vehicle personalisation menu in the Info Display. Two settings are selectable:

- All doors, the hinged doors / the load compartment and the fuel filler flap will be unlocked by passing a hand behind one of the front door handles, the handles of the sliding doors or the handles

of the hinged doors. If the vehicle is equipped with a tailgate, press the tailgate button.

- Only the front doors and the fuel filler flap will be unlocked by passing a hand behind one of front door handles.

Vehicle personalisation ↪ 127.

Unlocking the load compartment

Only the load compartment, i.e. the hinged doors or the tailgate, will be unlocked by passing a hand behind the hinged doors handle or pressing the tailgate button.

Locking



Press on one of the door handles or press the tailgate button.

All doors, load compartment and fuel filler flap will be locked.

If the vehicle is not closed properly, the electronic key remains in the vehicle or the ignition is not off, locking will not be permitted.

Confirmation

Operation of central locking system is confirmed by the hazard warning flashers.

Central locking button

Locks or unlocks all doors and the load compartment from inside the passenger compartment. If the vehicle is equipped with electronic key system, the fuel filler flap is locked or unlocked, too.



Press  to lock. The LED in the button illuminates.

Press  again to unlock. The LED in the button extinguishes.

Operation with the key in case of a central locking system fault

In case of a fault, e.g. vehicle battery or remote control / electronic key battery is discharged, the driver's door can be locked or unlocked with the mechanical key.

Manual unlocking

Electronic key: press and hold the latch to extract the integral key.

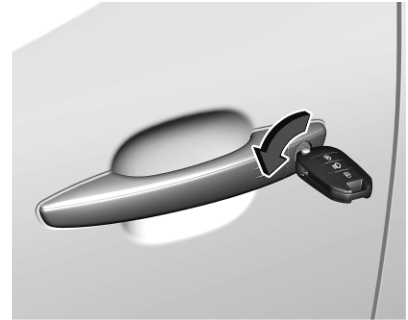

Manually unlock the driver's door by inserting and turning the key in the lock cylinder.

The other doors can be opened by pulling the interior handle.

By switching on the ignition, the anti-theft locking system is deactivated.

Manual locking

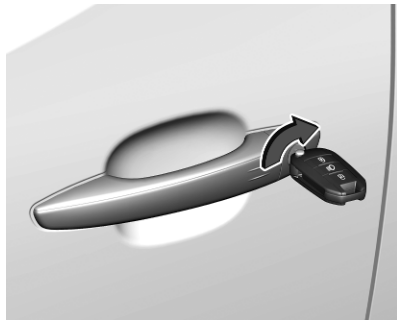

Manually lock the doors, tailgate and fuel filler flap by inserting and turning the key in the lock cylinder of the driver's door.

Automatic locking

Automatic locking after driving off

This system allows automatic locking of the doors and the tailgate as soon as the speed of the vehicle exceeds 6 mph.

If one of the doors or the tailgate is open, the automatic central locking does not take place. This is signalled

by the sound of the locks rebounding, accompanied by illumination of  in the instrument cluster, an audible signal and the display of an alert message.



This function can be activated or deactivated at any time. With the ignition on, press  until an audible signal starts and a corresponding message is displayed.

The state of the system stays in memory when switching off the ignition.

Automatic relock after unlocking

This feature automatically locks all doors, load compartment and fuel filler flap a short time after unlocking with the remote control or electronic key, provided no door has been opened.

Child locks

Warning

Use the child locks whenever children are occupying the rear seats.

Mechanical child locks

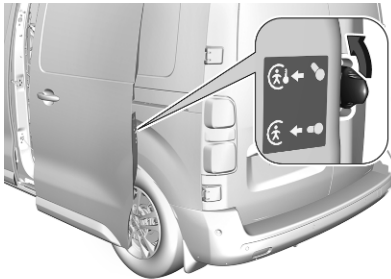

To activate, turn the child lock upwards. The sliding door cannot be opened from the inside.

To deactivate, turn the child lock downwards. The sliding door can be opened from the inside.

Electric child locks



Remotely operated system to prevent opening of the sliding doors via the interior door handles.

Switching on

Press . The indicator lamp in the button comes on, accompanied by a confirmation message. This indicator lamp remains on until the child lock is switched off.

Switching off

Press  again. The indicator lamp on button goes off, accompanied by a confirmation message. This indicator lamp remains on while child lock is switched on.

Doors

Sliding doors

Opening



After unlocking, pull the outside door handle and slide the door towards the rear beyond the point of resistance.



To open from inside, push the handle and slide the door towards the rear beyond the point of resistance.

Closing



To close from outside, pull the door handle and slide the door towards the front until it locks.



To close from inside, push the handle and slide the door towards the front until it locks.

Caution

Ensure the sliding side door is fully closed and secure before driving the vehicle.

Caution

To avoid damage, do not attempt to operate the sliding side door when the fuel filler flap is open.

⚠ Danger

Do not drive with the sliding side door open or ajar, e.g. when transporting bulky objects, since toxic exhaust gases, which cannot be seen or smelled, could enter the vehicle. This can cause unconsciousness and even death.

Refuelling ⇨ 228.









Power sliding doors**⚠ Warning**

Take care when operating the power sliding doors. Risk of injury, particularly to children.



Take particular care when the vehicle is parked on a slope: open or close the door fully until it latches into its locking position.

Keep a close watch on the moving doors when operating. Ensure that nothing becomes trapped during operation and no-one is standing within the moving area.

The power sliding doors can be operated by:

- pressing  or  on the radio remote control
- pressing  or  on the electronic key
- pressing  or  on the instrument panel
- pressing  or  on the door frame
- hands-free operation with motion sensors below the rear bumper
- pulling the respective door handle.

Operation with the electronic key

Press  or  longer to open or close the respective power sliding door.

Hands-free operation

Depending on the vehicle configuration, the vehicle may have one or two hands-free operated sliding doors.



To open or close a sliding door, move the foot below the rear bumper on the respective side back and forth.

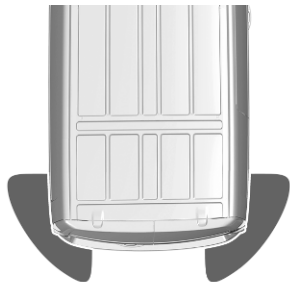

The electronic key must be outside the vehicle, within a range of approx. 1 m of the motion sensors. Depending on the configuration of the vehicle, the electronic key has to be located in the respective area. Do not hold the foot longer or move too slow below the bumper.

Activation or deactivation of hands-free operation can be set in the Info Display ⇨ 123.

Load compartment

Tailgate

Tailgate window ⇨ 42.

Opening



After unlocking, press the tailgate button and open the tailgate.

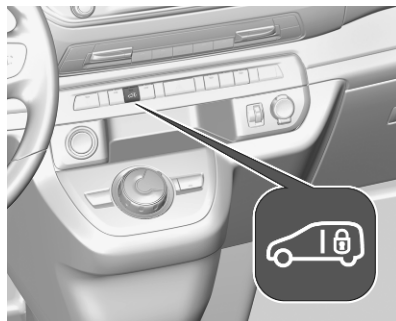

Depending on the version, press  to unlock the tailgate from the inside.

Closing

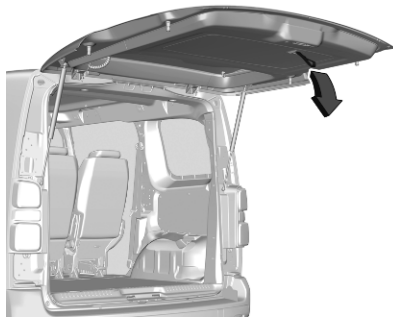

To lower the tailgate use the interior handle. Push the tailgate from above until it is fully closed.

Do not push the tailgate button whilst closing as this will unlock the tailgate again.

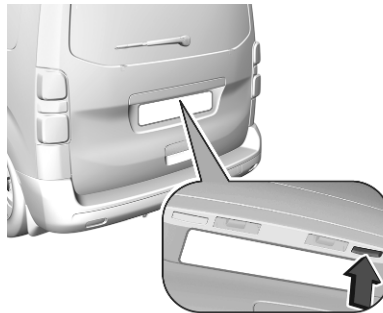

With the electronic key outside the vehicle and within a range of approx. 1 m of the tailgate, press the right tailgate button to lock the vehicle.

Central locking system ⇨ 24.

General hints for operating tailgate

Danger

Do not drive with the tailgate open or ajar, e.g. when transporting bulky objects, since toxic exhaust gases, which cannot be seen or

smelled, could enter the vehicle. This can cause unconsciousness and even death.

Caution

Before opening the tailgate, check overhead obstructions, e.g. a garage door, to avoid damage to the tailgate. Always check the moving area above and behind the tailgate.

Notice

The installation of certain heavy accessories onto the tailgate may affect its ability to remain open.

Notice

At low outside temperatures the tailgate may not open fully by itself. In this case lift the tailgate manually to its normal end position.

Emergency tailgate opening from inside the vehicle

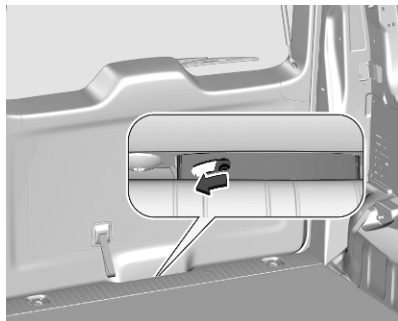

An access hole between the door and the floor enables the tailgate latch to be released using a suitable tool. Push lever to the left to unlock and open the tailgate.

Hinged doors

Unlock the hinged doors with the remote control or by turning the key in the rear door lock cylinder.

Central locking ⇨ 24.



To open the hinged doors, pull the exterior handle.



To release the right hinged door, pull the lever.

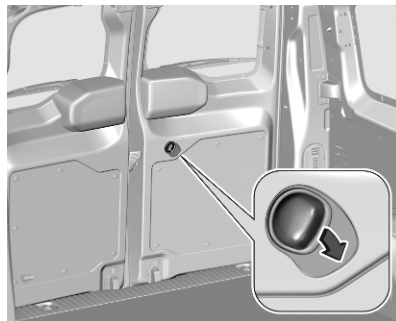

To open the door from inside the vehicle, pull the interior handle.

⚠ Warning

The rear lights may be obscured if the rear doors are open and the vehicle is parked on the roadside.

Make other road users aware of the vehicle, by using a warning triangle or other equipment specified in the road traffic regulations.



The doors are retained in the 90° position by locking stays. To open the doors to 180°, push the latch and swing open to the desired position. Before closing the doors ensure that the locking stays are in the 90° position.

⚠ Warning

Ensure extended opening doors are secured when fully opened.
Opened doors may slam closed due to the force of the wind!

Always close the right hand door before the left hand door.

Central locking system ↪ 24.

Vehicle security

Anti-theft locking system

⚠ Warning

Do not use the system if there are people in the vehicle! The doors cannot be unlocked from the inside.

The system deadlocks all the doors. All doors must be closed otherwise the system cannot be activated.

Unlocking the vehicle disables the mechanical anti-theft locking system. This is not possible with the central locking button.

Activating

Simple key: Insert the key and turn it clockwise twice within 5 seconds.

Remote control: Press  on the radio remote control twice within five seconds.

Electronic key: Press twice on one of the door handles within five seconds

Anti-theft alarm system

⚠ Warning

Do not use the system if there are people in the vehicle! The doors cannot be unlocked from the inside.

The anti-theft alarm system has been designed to protect the vehicle against theft and break-ins.



The anti-theft alarm system is combined with the central locking system.

The system monitors doors, tailgate, bonnet and the passenger compartment.

Depending on the version of the vehicle, it may not monitor the adjoining load compartment.

Activation

Ignition must be switched off. All doors must be closed and the electronic key must not remain in the vehicle. Otherwise the system cannot be activated.

- Radio remote control: Monitoring of the doors, the tailgate and the bonnet is activated 5 seconds after locking the vehicle by pressing . Monitoring of the passenger compartment is activated 45 seconds after locking the vehicle by pressing .
- Electronic key system: Monitoring of the doors, the tailgate and the bonnet is activated 5 seconds after locking the vehicle by pressing with a finger or thumb on one of the front door handles at the markings. Monitoring of the passenger compartment is activated 45 seconds after locking the vehicle by pressing with a finger or thumb on one of the front door handles at the markings.

Activation is confirmed by the flashing of the status LED and coming on of the turn lights for a short time.

If a door or the tailgate is not correctly closed and the vehicle is locked via remote control or electronic key system, the vehicle remains

unlocked. However, the anti-theft alarm system will be activated after 45 seconds.

Notice

Changes to the vehicle interior such as the use of seat covers and open windows, could impair the function of passenger compartment monitoring.

Activation without monitoring of passenger compartment



Switch off the monitoring of passenger compartment when animals are being left in the vehicle, because of high volume ultrasonic

signals or movements triggering the alarm. Also switch off when the vehicle is on a ferry or train.

1. Switch of ignition.
2. Press  within the next 10 seconds until the LED of the button illuminates constantly.
3. Get out of the vehicle.
4. Lock the vehicle immediately by using the remote control, pressing one of the door handles or by pressing the tailgate button.

Activation is indicated by the flashing of the status LED.

Indication

LED in the central locking button flashes if the anti-theft alarm system is activated.

Seek the assistance of a workshop in the event of faults.

Deactivation

Radio remote control: Unlocking the vehicle by pressing  deactivates the anti-theft alarm system.



Electronic key system: Unlocking the vehicle by pressing on one of the front door handles at the markings deactivates the anti-theft alarm system.

The electronic key must be outside the vehicle, within a range of approx. one metre of the relevant door side.



The system is not deactivated by unlocking the driver's door with the key or with the central locking button in the passenger compartment.

Notice

If the vehicle is unlocked and no door is opened, the vehicle is automatically relocked after 30 seconds. In this case, the anti-theft alarm will be reactivated, too.

Alarm

When triggered, the alarm horn sounds and the hazard warning lights flash simultaneously. The number and duration of alarm signals are stipulated by legislation.

The anti-theft alarm system can be deactivated by pressing , by pressing on one of the front door handles at the markings with electronic key system. The LED of the  button will extinguish and the turn lights flash for a short time.

A triggered alarm, which has not been interrupted by the driver, will be indicated by the rapid flashing of the LED of the  button. If the ignition is switched on, the flashing stops immediately.

If the vehicle's battery is to be disconnected (e.g. for maintenance work), the alarm siren must be

deactivated as follows: switch the ignition on then off, then disconnect the vehicle's battery within 15 seconds.

If the battery has been reconnected, wait for 10 minutes to restart the engine.

Locking the vehicle without activation of the anti-theft alarm

Lock the vehicle by inserting and turning the integrated key of the remote control or the electronic key system in the lock cylinder of the driver's door.

Malfunction of the remote control

Unlock the vehicle by inserting and turning the integrated key of the remote control or the electronic key system in the lock cylinder of the driver's door.

Open the driver's door.

The horn of the anti-theft alarm will sound.

Switch on ignition.

The horn will stop sounding and the status LED extinguishes.

Immobiliser

The system is part of the ignition switch and checks whether the vehicle is allowed to be started with the key being used.

The immobiliser is activated automatically after the key has been removed from the ignition switch.

Notice

Radio Frequency Identification (RFID) tags may cause interference with the key. Do not have it placed near the key when starting the vehicle.

Notice

The immobiliser does not lock the doors. Always lock the vehicle after leaving it ↻ 24.

Switch on the anti-theft alarm system ↻ 36.

Emergency operation of electronic key ↻ 160.

Exterior mirrors

Convex shape

The shape of the mirror makes objects appear smaller, which will affect the ability to estimate distances.

Side blind spot alert ↻ 207.

Electric adjustment

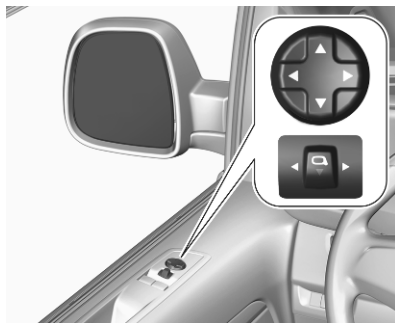

Select the relevant exterior mirror by pushing the mirror button  to the left or right.

Adjust the respective mirror with the four-way control.

Folding mirrors



For pedestrian safety, the exterior mirrors will swing out of their normal mounting position if they are struck with sufficient force. Reposition the mirror by applying slight pressure to the mirror housing.

Electric folding

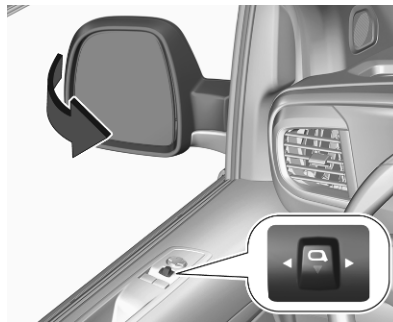

Pull the mirror button  rearwards. Both exterior mirrors will fold.

Pull the mirror button rearwards again to return both exterior mirrors to their original position.

If an electrically folded mirror is manually extended, pulling mirror button rearwards will only electrically extend the other mirror.

Automatic folding



When the vehicle is being locked, both mirrors will fold.

When the vehicle is being unlocked, the mirrors return to their original position.

The function can be deactivated in the vehicle personalisation  127.

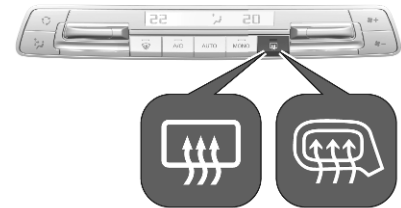
Heated mirrors



Depending on the version, heating is operated by pressing  or .

Heating works with the engine running and is switched off automatically after a short time.

Heated rear window  43.

Interior mirrors

Manual anti-dazzle

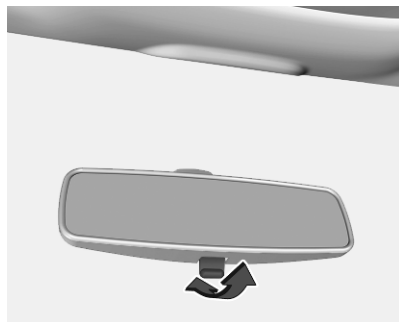

To reduce dazzle, adjust the lever on the underside of the mirror housing.

Automatic anti-dazzle



Dazzle from following vehicles is automatically reduced, when driving in the dark.

Child surveillance mirror

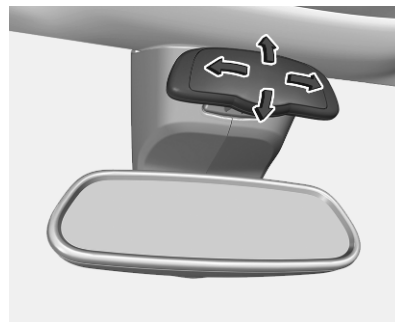

A child surveillance mirror allows to observe the rear seats. The mirror can be adjusted.

Windows

Windscreen

Windscreen stickers

Do not attach stickers such as toll road stickers or similar on the windscreen in the area of the interior mirror. Otherwise the detection zone of the sensor and the view area of the camera in the mirror housing could be restricted.

Windscreen replacement

Caution

If the vehicle has a front-looking camera sensor for the driver assistance systems, it is very important that any windscreen replacement is performed accurately according to Vauxhall specifications. Otherwise, these systems may not work properly and there is a risk of unexpected behaviour and / or messages from these systems.

Power windows

⚠ Warning

Take care when operating the power windows. Risk of injury, particularly to children.

If there are children on the rear seats, switch on the child safety system for the power windows.

Keep a close watch on the windows when closing them. Ensure that nothing becomes trapped in them as they move.

Switch on ignition to operate power windows.



Operate  for the respective window by pushing to open or pulling to close.

Pushing or pulling gently to the first detent: window moves up or down as long as the switch is operated.

Pushing or pulling firmly to the second detent then releasing: window moves up or down automatically with safety function enabled. To stop movement, operate the switch once more in the same direction.

Safety function

This function depends upon version. If the window glass encounters resistance above the middle of the window during automatic closing, it is immediately stopped and opened again.

Override safety function

In the event of closing difficulties due to frost or the like, switch on the ignition, then pull the switch to the first detent and hold. The window moves up without safety function enabled. To stop movement, release the switch.

Operating windows from outside

The windows can be closed remotely from outside the vehicle.

Press and hold  to close windows.

Release button to stop window movement.

Overload

If the windows are repeatedly operated within short intervals, the window operation is disabled for some time.

Initialising the power windows

If the windows cannot be closed automatically (e.g. after disconnecting the vehicle battery), a warning message is displayed in the Driver Information Centre.

Vehicle messages ⇨ 126.

Activate the window electronics as follows:

1. Close doors.
2. Switch on ignition.
3. Push switch until the window is completely open.
4. Pull switch until the window is completely closed and keep pulling for additional two seconds.
5. Repeat for each window.

Rear windows

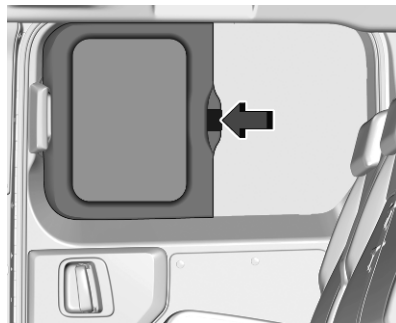

To open and close the rear windows, push the lever and slide the windows backwards or forwards.

Mechanical child lock for rear windows

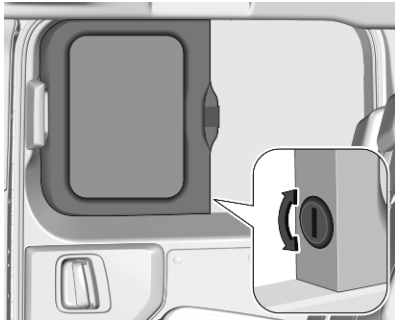

To activate, turn the child lock with the key upwards. The sliding window cannot be opened from the inside.

To deactivate, turn the child lock with the key downwards. The sliding window can be opened from the inside.

Tailgate window

The tailgate window can be opened to give access to the load compartment without opening the tailgate.

The tailgate and the tailgate window cannot be opened at the same time.

Opening

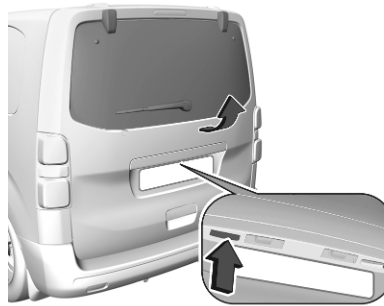

After unlocking, press the button and open the window until it is fully opened.

Closing



Press on the centre of the window until it is fully closed.

Heated rear window

Operated by pressing . Depending on the version, the heated rear window is operated together with the heated exterior mirrors.

Heating works with the engine running and is switched off automatically after a short time.

Depending on climate control system,  is located at a different position.



Heated windscreen



This function heats the windscreen along its bottom and along both sides of the windscreen.

Thus, the function allows a fast detaching of the windscreen wiper blades if they are frozen to the windscreen. Additionally, an accumulation of snow caused by the operation of the windscreen wipers is prevented.



Heating is operated by pressing . LED in button illuminates.

Heating works with the engine running and is switched off automatically depending on the ambient temperature.

Pressing  again switches off the heating operation. LED in button is extinguished.

Sun visors

The sun visors can be folded down or swivelled to the side to prevent dazzling.

The cover of the mirrors should be closed when driving.

A ticket holder is located on the backside of the sun visor.

Roller blinds



To reduce sunlight at the second row seats, pull the blind upwards using the grip and engage it at the top of the door frame.

Roof

Glass panel

Sunblinds

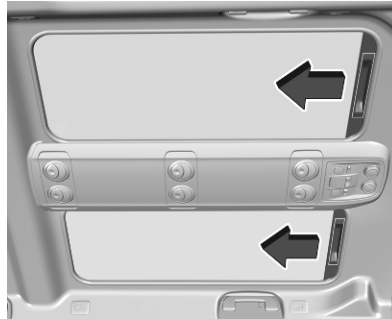

The sunblinds are operated manually. Slide the respective sunblind to the desired position.

Seats, restraints

Head restraints	46
Front seats	47
Seat position	47
Manual seat adjustment	47
Power seat adjustment	49
Seat folding	50
Armrest	51
Heating	51
Massage	52
Rear seats	52
Seat belts	56
Three-point seat belt	57
Airbag system	60
Front airbag system	63
Side airbag system	63
Curtain airbag system	64
Airbag deactivation	64
Child restraints	66
Child restraint systems	66
Child restraint installation locations	69

Head restraints

Position

⚠ Warning

Only drive with the head restraint set to the proper position.

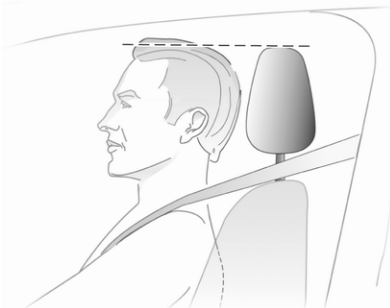

The upper edge of the head restraint should be at upper head level. If this is not possible for extremely tall people, set to highest position, and set to lowest position for small people.

Adjustment

Height adjustment

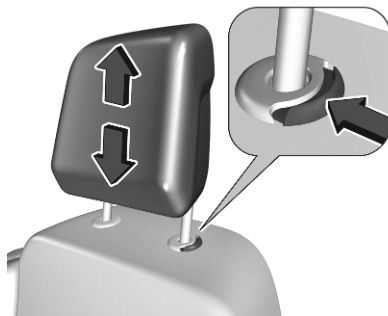

Move the head restraint upwards or downwards. If the head restraint is engaged press the catch and move the head restraint.

Removal

Move the head restraint upwards and remove it. If the head restraint is engaged press the catch and move the head restraint.

Installation

Engage the head restraint rods in the openings and push it downwards.

Front seats

Seat position

⚠ Warning

Only drive with the seat correctly adjusted.

⚠ Warning

Never adjust seats while driving as they could move uncontrollably.

⚠ Danger

Do not sit closer than 25 cm to the steering wheel, to permit safe airbag deployment.

⚠ Warning

Never store any objects under the seats.



- Sit with buttocks as far back against the backrest as possible. Adjust the distance between the seat and the pedals so that legs are slightly angled when pressing the pedals. Slide the front passenger seat as far back as possible.
- Set seat height high enough to have a clear field of vision on all sides and of all display instruments. There should be at least one hand of clearance between head and the roof frame. Your thighs should rest lightly on the seat without pressing into it.

- Sit with shoulders as far back against the backrest as possible. Set the backrest rake so that it is possible to easily reach the steering wheel with arms slightly bent. Maintain contact between shoulders and the backrest when turning the steering wheel. Do not angle the backrest too far back. We recommend a maximum rake of approx. 25°.
- Adjust seat and steering wheel in a way that the wrist rests on top of the steering wheel while the arm is fully extended and shoulders are on the backrest.
- Adjust the steering wheel ↻ 94.
- Adjust the head restraint ↻ 46.
- Adjust the lumbar support so that it supports the natural shape of the spine.

Manual seat adjustment

Drive only with engaged seats and backrests.

Longitudinal adjustment

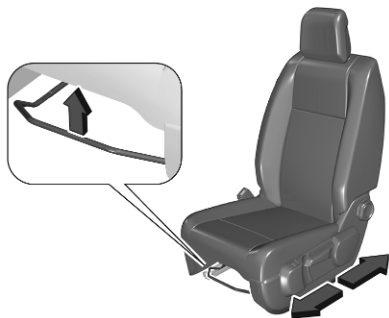

Pull the handle, slide the seat, then release the handle. Try to move the seat back and forth to ensure that the seat is locked in place.

Backrest inclination

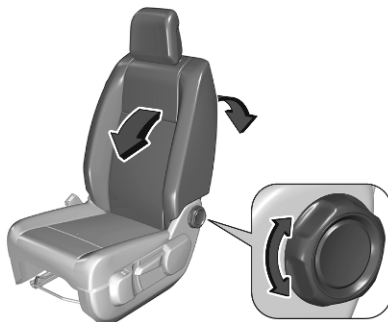

Turn handwheel to adjust inclination. Do not lean on the backrest while adjusting.

Seat height

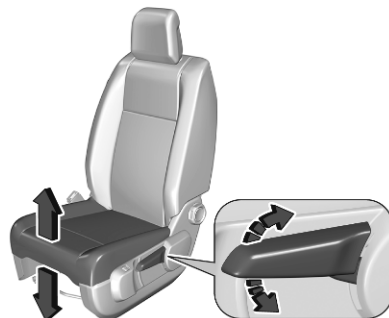

Lever pumping motion
up : seat higher
down : seat lower

Lumbar support



Turn the handwheel to suit personal requirements.

Power seat adjustment

⚠ Warning

Care must be taken when operating the power seats. There is a risk of injury, particularly for children. Objects could become trapped.

Keep a close watch on the seats when adjusting them. Vehicle passengers should be informed accordingly.

Longitudinal adjustment



Move the switch forwards / backwards.

Seat height

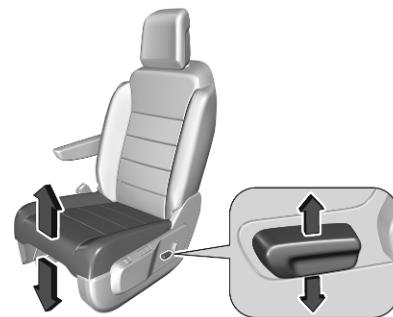

Move the switch upwards / downwards.

Backrest inclination



Tilt the switch forwards / backwards.

Lumbar support



Press  to suit personal requirements.

Seat folding

Depending on version, the front seats can be folded flat to the table position.

Front seats backrest

Folding

Slide the front seat as far back as possible, to avoid contact with the instrument panel during folding.

Push the head restraint down or remove it before folding backrest.

Head restraints ⇨ 46.

If available fold up the armrest.

Armrest ⇨ 51.

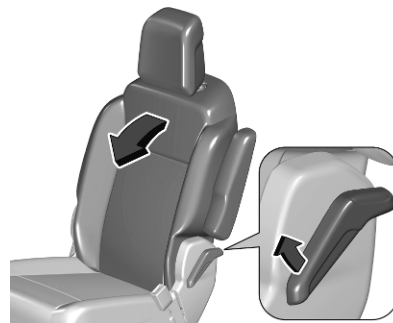

Pull the lever, fold the backrest fully forwards and release the lever.

Warning

When the front passenger seat is in the folded position, the front passenger airbag system must be deactivated.

Airbag deactivation ⇨ 64.

Unfolding

To restore the seat to the upright position, pull the lever and raise backrest fully. Then release the lever.

Bench seat front passenger side

Folding

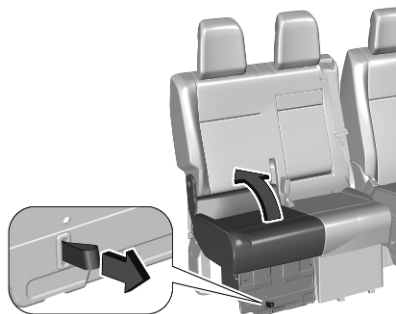

To lift the seat cushion pull the loop and raise the seat cushion against the backrest.

Cargo management system ⇨ 82.

Warning

Never put the hand underneath the seat while folding the seat.
Risk of injury.

Unfolding

To restore the seat cushion to the original position, lower the seat cushion till it is engaged.

Armrest

The armrest has several adjustment options.



1. Fold it completely up.
2. Fold it completely down.
3. Raise the armrest slowly and engage it at the desired position.

Heating



The seat heating thumb wheel can be located at the seat or on the instrument panel.



Activate seat heating by turning the thumb wheel  for the respective front seat. There are three intensity levels of heating.

To deactivate the seat heating turn the thumb wheel  to 0.

Prolonged use of the highest setting for people with sensitive skin is not recommended.

Seat heating is operational when engine is running and during an Autostop.

Stop-start system ⇨ 163.

Massage



Activate the back massage function by pressing . The LED in the button illuminates to indicate activation.

The massage function is activated for a period of 1 hour. During this time, massage is performed in six cycles with breaks in between.

To adjust the intensity of the massage press . Two levels of massage are available.

Pressing  once more deactivates massage function. The LED goes off.

The massage function is operational when engine is running and during an Autostop.

Stop-start system ⇨ 163.

Rear seats

Warning

When seats are being adjusted or folded, keep hands and feet away from the moving area. Risk of injury.

Ensure that there are no objects on the anchor points or rails.

Never adjust seats while driving as they could move uncontrollably.

Drive only with engaged seats and backrests.

Depending on version the levers of the seats can be located at different places. The illustrations show examples.

Seat backrest

Folding backrest down to table position

1. Push the head restraint down or remove it before folding the backrest.

Head restraints ⇨ 46.

- If available fold up the armrest.
Armrest ⇨ 51.

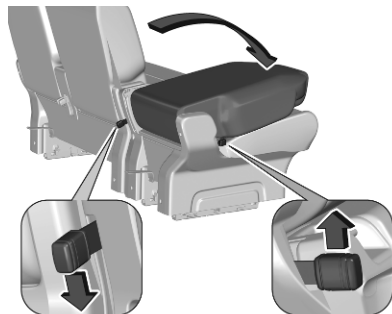

- Pull the front lever or push the rear lever to release the backrest.
- Fold the backrest fully down.

Unfolding the backrest

- Pull the front lever or press the rear lever.
- Raise the backrest fully upwards until it engages.

Fixed rear seats

Easy entry function

To permit an easy entrance to the seats of the third row, the seats of the second row can be tilted.



Pull the release lever and tilt seat to the front.

To restore the original position tilt seat back until it is engaged.

Tilted position

- Fold the backrest down to the table position.

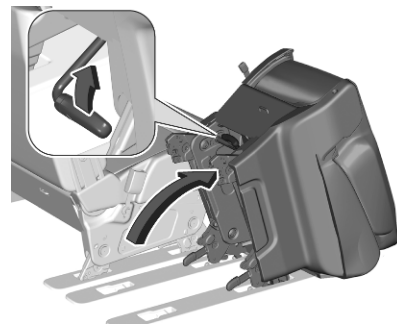

- Pull the release lever and tilt the seat to the front.

Removing

Depending on version seats can be removed.

- Fold the backrest down to the table position.
- Move the seat to the tilted position.

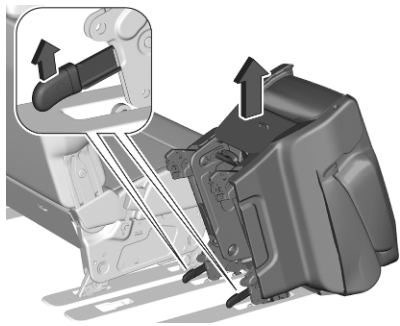

3. Release each front mount by pulling the respective lever.
4. Remove the seat.

Installing

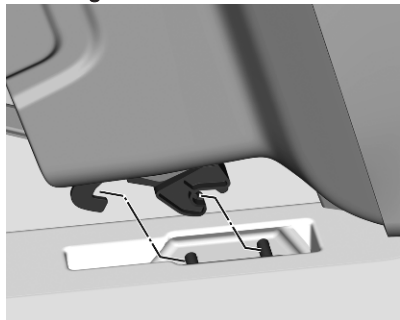

1. Engage front mounts in the anchorages.

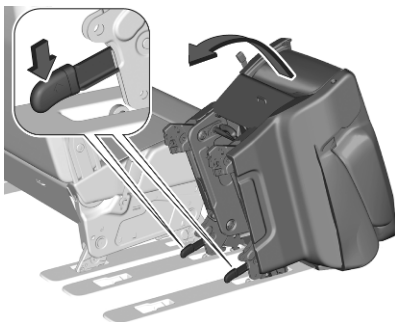

2. Push the levers to lock the front mounts and tilt the seat back until it is engaged.
3. Unfold the backrest.

Rear seats on rails

The single seats as well as the seat bench seat can be moved individually forwards and backwards. The backrest of the seat bench is splitted.

Backrest inclination

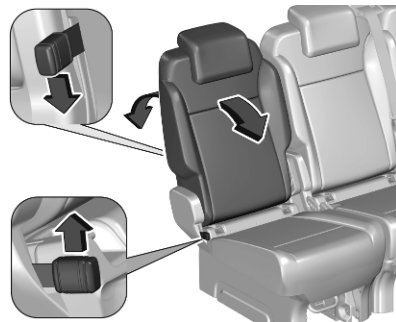

Pull the front lever or push the rear lever to release and adjust the backrest.

Release the lever when the desired position is obtained.

Longitudinal adjustment

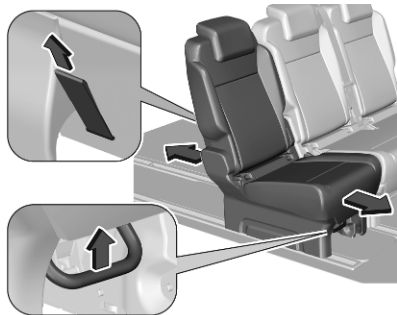

To release the seat, pull the front handle upward or pull the loop on the rear without going beyond the point of resistance.

Slide the seat forwards or backwards.

Longitudinal adjustment of row with seat bench

To move the seat bench or the single seat along the full length of the rail, fold down the backrest to the table position.

Release and move the seat by pulling the loop on the rear without going beyond the point of resistance.

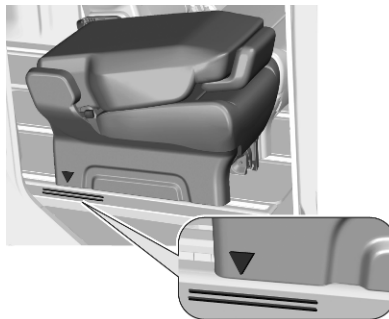

The arrow has to be positioned within the marking.

Raise the backrest fully upwards.

Removing

1. Fold the backrest down to the table position.

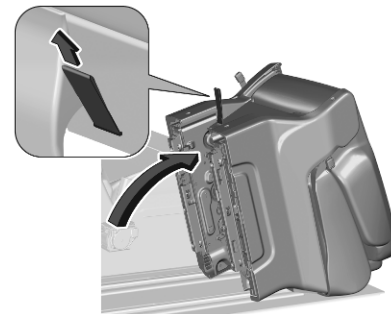

2. Pull the loop on the rear beyond the point of resistance and tilt the seat to the front.
3. Remove the seat.

Caution

Do not use the loop to lift the seat.

Installing

1. The loop on the rear has to be in the release position.

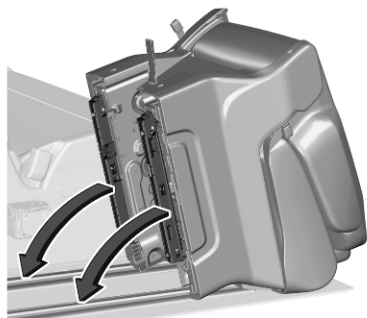

2. Place the front of the seat on the rails and then tip the rear down.

Caution

Do not use the loop to lift the seat.

3. Slide the seat until it engages.
4. Raise the backrest fully upwards.

Lounge position

The single seats on rails can be placed facing forward or backward.

Caution

Avoid contact between two seats. This could cause significant wear of the parts in contact.

1. Fold the backrest down to the table position.
2. Pull the loop on the rear beyond the point of resistance.

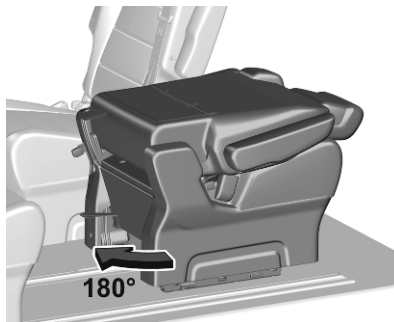

3. Slightly lift and turn the seat by 180° until it is engaged.
4. Raise the backrest fully upwards.

Seat belts



The seat belts are locked during heavy acceleration or deceleration of the vehicle, holding the occupants in the seat position. Therefore the risk of injury is considerably reduced.

⚠ Warning

Fasten seat belt before each trip. In the event of an accident, people not wearing seat belts endanger their fellow occupants and themselves.

Seat belts are designed to be used by only one person at a time.

Child restraint system ⇨ 66.

Periodically check all parts of the belt system for damage, soiling and proper functionality.

Have damaged components replaced. After an accident, have the belts and triggered belt pretensioners replaced by a workshop.

Notice

Make sure that the belts are not damaged by shoes or sharp-edged objects or are trapped. Prevent dirt from getting into the belt retractors.

Seat belt reminder

Each seat is equipped with a seat belt reminder, indicated by a control indicator  for the respective seat in the instrument cluster and in the overhead console.

Seat belt reminder ⇨ 111.

Belt force limiters

Stress on the body is reduced by the gradual release of the belt during a collision.

Belt pretensioners

In the event of a head-on, rear-end or side-on collision of a certain severity, the single front seat belts and the seat belt of the outer front bench seat are tightened by seat belt pretensioners.

Warning

Incorrect handling (e.g. removal or fitting of belts) can trigger the belt pretensioners.

Deployment of the belt pretensioners is indicated by continuous illumination of control indicator .

Airbag and belt tensioners ⇨ 111.

Triggered belt pretensioners must be replaced by a workshop. Belt pretensioners can only be triggered once.

Notice

Do not affix or install accessories or other objects that may interfere with the operation of the belt pretensioners. Do not make any

modifications to belt pretensioner components as this will invalidate the operating permit of your vehicle.

Three-point seat belt

Fasten

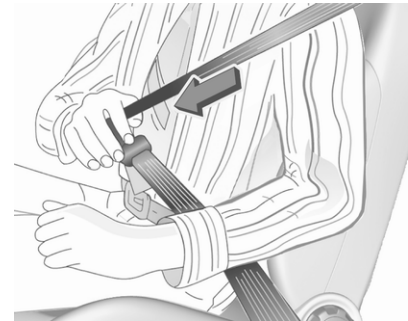

Withdraw the belt from the retractor, guide it untwisted across the body and insert the latch plate into the buckle. Make sure the belt fits tightly to the body while driving.

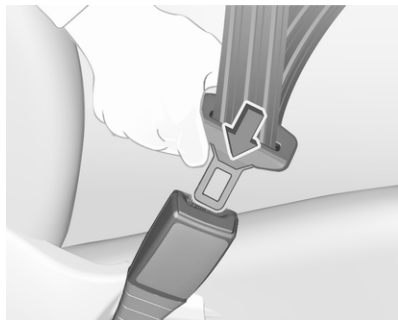

Loose or bulky clothing prevents the belt from fitting snugly. Do not place objects such as handbags or mobile phones between the belt and your body.

Warning

The belt must not rest against hard or fragile objects in the pockets of your clothing.

Seat belt reminder  111, 118.

Height adjustment

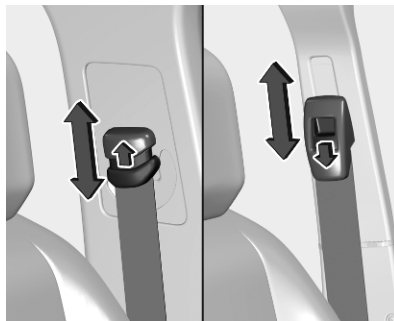

Press the release button and shift the height adjuster upwards or downwards till it engages at the desired position.



Adjust the height so that the belt lies across the shoulder. It must not lie across the throat or upper arm.

Do not adjust while driving.

Seat belts on the rear seats and bench seat



The retractor can be located on the backrest of the seat.

Unfasten

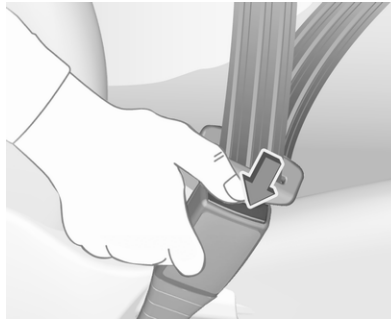

To release belt, press red button on belt buckle.

Using seat belts while pregnant



⚠ Warning

The lap belt must be positioned as low as possible across the pelvis to prevent pressure on the abdomen.

Airbag system

The airbag system consists of a number of individual systems depending on the scope of equipment.

When triggered the airbags inflate within milliseconds. They also deflate so quickly that it is often unnoticeable during the collision.

⚠ Warning

The airbag system deploys in an explosive manner, repairs must be performed by skilled personnel only.

⚠ Warning

Adding accessories that change the vehicle's frame, bumper system, height, front end or side sheet metal, may keep the airbag system from working properly. The operation of the airbag system can also be affected by changing any parts of the front seats, seat belts,

airbag sensing and diagnostic module, steering wheel, instrument panel, inner door seals including the speakers, any of the airbag modules, ceiling or pillar trim, front sensors, side impact sensors or airbag wiring.

Notice

The airbag systems and belt pretensioner control electronics are located in the centre console area. Do not put any magnetic objects in this area.

Do not affix any objects onto the airbag covers and do not cover them with other materials. Have damaged covers replaced by a workshop.

Each airbag is triggered only once. Have deployed airbags replaced by a workshop. Furthermore, it may be necessary to have the steering wheel, the instrument panel, parts of the panelling, the door seals, handles and the seats replaced.

Do not make any modifications to the airbag system as this will invalidate the vehicle operating permit.

Control indicator  for airbag systems ⇨ 111.

Child restraint systems on front passenger seat with airbag systems

Warning according to ECE R94.02:



EN: NEVER use a rearward-facing child restraint on a seat protected by an ACTIVE AIRBAG in front of it; DEATH or SERIOUS INJURY to the CHILD can occur.

DE: Nach hinten gerichtete Kindersitze NIEMALS auf einem Sitz verwenden, der durch einen davor befindlichen AKTIVEN AIRBAG

geschützt ist, da dies den TOD oder SCHWERE VERLETZUNGEN DES KINDES zur Folge haben kann.

FR: NE JAMAIS utiliser un siège d'enfant orienté vers l'arrière sur un siège protégé par un COUSSIN GONFLABLE ACTIF placé devant lui, sous peine d'infliger des BLESSURES GRAVES, voire MORTELLES à l'ENFANT.

ES: NUNCA utilice un sistema de retención infantil orientado hacia atrás en un asiento protegido por un AIRBAG FRONTAL ACTIVO. Peligro de MUERTE o LESIONES GRAVES para el NIÑO.

RU: ЗАПРЕЩАЕТСЯ устанавливать детское удерживающее устройство лицом назад на сиденье автомобиля, оборудованном фронтальной подушкой безопасности, если ПОДУШКА НЕ ОТКЛЮЧЕНА! Это может привести к СМЕРТИ или СЕРЬЕЗНЫМ ТРАВМАМ РЕБЕНКА.

NL: Gebruik NOOIT een achterwaarts gericht kinderzitje op een stoel met een ACTIEVE AIRBAG ervoor, om DODELIJK of ERNSTIG LETSEL van het KIND te voorkomen.

DA: Brug ALDRIG en bagudvendt autostol på et forsæde med AKTIV AIRBAG, BARNET kan komme i LIVSFARE eller komme ALVORLIGT TIL SKADE.

SV: Använd ALDRIG en bakåtvänd barnstol på ett säte som skyddas med en framförvarande AKTIV AIRBAG. DÖDSFALL eller ALLVARLIGA SKADOR kan drabba BARNET.

FI: ÄLÄ KOSKAAN sijoita taaksepäin suunnattua lasten turvaistuinta istuimelle, jonka edessä on AKTIIVINEN TURVATYYNYY, LAPSI VOI KUOLLA tai VAMMAUTUA VAKAVASTI.

NO: Bakovervendt barnesikringsutstyr må ALDRI brukes på et sete med AKTIV KOLLISJONSPUTE foran, da det kan føre til at BARNET utsettes for LIVSFARE og fare for ALVORLIGE SKADER.

PT: NUNCA use um sistema de retenção para crianças voltado para trás num banco protegido com um AIRBAG ACTIVO na frente do mesmo, poderá ocorrer a PERDA DE VIDA ou FERIMENTOS GRAVES na CRIANÇA.

IT: Non usare mai un sistema di sicurezza per bambini rivolto all'indietro su un sedile protetto da AIRBAG ATTIVO di fronte ad esso: pericolo di MORTE o LESIONI GRAVI per il BAMBINO!

EL: ΠΟΤΕ μη χρησιμοποιείτε παιδικό κάθισμα ασφαλείας με φορά προς τα πίσω σε κάθισμα που προστατεύεται από μετωπικό ΕΝΕΡΓΟ ΑΕΡΟΣΑΚΟ, διότι το παιδί μπορεί να υποστεί ΘΑΝΑΣΙΜΟ ή ΣΟΒΑΡΟ ΤΡΑΥΜΑΤΙΣΜΟ.

PL: NIE WOLNO montować fotelika dziecięcego zwróconego tyłem do kierunku jazdy na fotelu, przed którym znajduje się WŁĄCZONA PODUSZKA POWIETRZNA. Niezastosowanie się do tego zalecenia może być przyczyną ŚMIERCI lub POWAŻNYCH OBRAŻEŃ u DZIECKA.

TR: Arkaya bakan bir çocuk emniyet sistemini KESİNLİKLE önünde bir AKTİF HAVA YASTIĞI ile korunmakta olan bir koltukta kullanmayınız. ÇOCUK ÖLEBİLİR veya AĞIR ŞEKİLDE YARALANABİLİR.

UK: НИКОЛИ не використовуйте систему безпеки для дітей, що встановлюється обличчям назад, на сидінні з УВІМКНЕНОЮ ПОДУШКОЮ БЕЗПЕКИ, інакше це може призвести до СМЕРТІ чи СЕРІОЗНОГО ТРАВМУВАННЯ ДИТИНИ.

HU: SOHA ne használjon hátrafelé néző biztonsági gyerekülést előlről AKTÍV LÉGZSÁKKAL védett ülésen, mert a GYERMEK HALÁLÁT vagy KOMOLY SÉRÜLÉSÉT okozhatja.

HR: NIKADA nemojte koristiti sustav zadržavanja za djecu okrenut prema natrag na sjedalu s AKTIVNIM ZRAČNIM JASTUKOM ispred njega, to bi moglo dovesti do SMRTI ili OZBILJNIH OZLJEDA za DIJETE.

SL: NIKOLI ne nameščajte otroškega varnostnega sedeža, obrnjenega v nasprotni smeri vožnje, na sedež z

AKTIVNO ČELNO ZRAČNO BLAZINO, saj pri tem obstaja nevarnost RESNIH ali SMRTNIH POŠKODB za OTROKA.

SR: NIKADA ne koristiti bezbednosni sistem za decu u kome su deca okrenuta unazad na sedištu sa AKTIVNIM VAZDUŠNIM JASTUKOM ispred sedišta zato što DETE može da NASTRADA ili da se TEŠKO POVREDI.

MK: НИКОГАШ не користете детско седиште свртено наназад на седиште заштитено со АКТИВНО ВОЗДУШНО ПЕРНИЧЕ пред него, затоа што детето може ДА ЗАГИНЕ или да биде ТЕШКО ПОВРЕДЕНО.

BG: НИКОГА не използвайте детска седалка, гледаща назад, върху седалка, която е защитена чрез АКТИВНА ВЪЗДУШНА ВЪЗГЛАВНИЦА пред нея - може да се стигне до СМЪРТ или СЕРИОЗНО НАРАНЯВАНЕ на ДЕТЕТО.

RO: Nu utilizați NICIODATĂ un scaun pentru copil îndreptat spre partea din spate a mașinii pe un scaun protejat de un AIRBAG ACTIV în fața sa;

acest lucru poate duce la DECESUL sau VĂTĂMAREA GRAVĂ a COPILULUI.

CS: NIKDY nepoužívejte dětský zádržný systém instalovaný proti směru jízdy na sedadle, které je chráněno před sedadlem AKTIVNÍM AIRBAGEM. Mohlo by dojít k VÁŽNĚMU PORANĚNÍ nebo ÚMRTÍ DÍTĚTE.

SK: NIKDY nepoužívajte detskú sedačku otočenú vzad na sedadle chránenom AKTÍVNYM AIRBAGOM, pretože môže dôjsť k SMRTI alebo VÁŽNYM ZRANENIAM DIEŤAŤA.

LT: JOKIU BŪDU nemontuokite atgal atgretžtos vaiko tvirtinimo sistemas sėdynėje, prieš kurią įrengta AKTYVI ORO PAGALVĖ, nes VAIKAS GALI ŽŪTI arba RIMTAI SUSIŽALOTI.

LV: NEKĀDĀ GADĪJUMĀ neizmantojiet uz aizmuguri vērstu bērnu sēdekļīti sēdvietā, kas tiek aizsargāta ar tās priekšā uzstādītu AKTĪVU DROŠĪBAS SPILVENU, jo pretējā gadījumā BĒRNS var gūt SMAGAS TRAUMAS vai IET BOJĀ.

ET: ÄRGE kasutage tahapoole suunatud lapseturvaistet istmel, mille ees on AKTIIVSE TURVAPADJAGA kaitstud iste, sest see võib põhjustada LAPSE SURMA või TÕSISE VIGASTUSE.

MT: QATT tuża trażżin għat-tfal li jħares lejn in-naħa ta' wara fuq sit protett b'AIRBAG ATTIV quddiemu; dan jista' jikkawża I-MEWT jew ĠRIEHI SERJI lit-TFAL.

GA: Ná húsáid srian sábháilteachta linbh cúil RIAMH ar shuíochán a bhfuil mála aeir ag feidhmiú os a chomhair. Tá baol BÁIS nó GORTÚ DONA don PHÁISTE ag baint leis.

Beyond the warning required by ECE R94.02, for safety reasons a forward-facing child restraint system must only be used subject to the instructions and restrictions in the table ⇨ 69.

The airbag label is located on both sides of the front passenger sun visor. Airbag deactivation ⇨ 64.

Front airbag system

The front airbag system consists of one airbag in the steering wheel and one in the instrument panel on the front passenger side. These can be identified by the word **AIRBAG**.

The front airbag system is triggered in the event of a front-end impact of a certain severity. The ignition must be switched on.

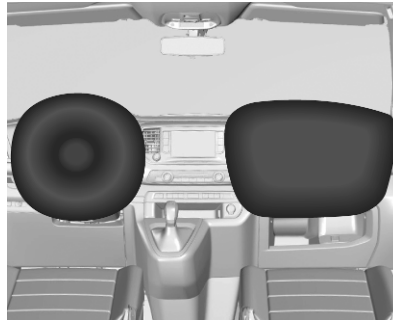

The inflated airbags cushion the impact, thereby reducing the risk of injury to the upper body and head of the front seat occupants considerably.

⚠ Warning

Optimum protection is only provided when the seat is in the proper position.

Seat position ⇨ 47.

Keep the area in which the airbag inflates clear of obstructions.

Fit the seat belt correctly and engage securely. Only then is the airbag able to protect.

Side airbag system



The side airbag system consists of an airbag in each front seat backrest. This can be identified by the word **AIRBAG**.

The side airbag system is triggered in the event of a side impact of a certain severity. The ignition must be switched on.



The inflated airbags cushion the impact, thereby reducing the risk of injury to the upper body and pelvis in the event of a side-on collision considerably.

⚠ Warning

Keep the area in which the airbag inflates clear of obstructions.

Notice

Only use protective seat covers that have been approved for the vehicle. Be careful not to cover the airbags.

Curtain airbag system

The curtain airbag system consists of an airbag in the roof frame on each side.

The curtain airbag system is triggered in the event of a side-on impact of a certain severity. The ignition must be switched on.

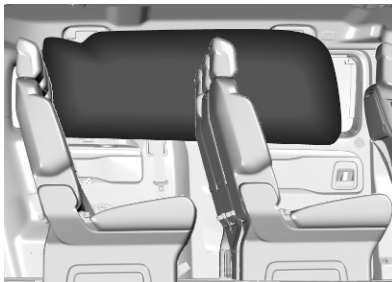

The inflated airbags cushion the impact, thereby reducing the risk of injury to the head in the event of a side-on impact considerably.

⚠ Warning

Keep the area in which the airbag inflates clear of obstructions.

The hooks on the handles in the roof frame are only suitable for hanging up light articles of clothing, without coat hangers. Do not keep any items in these clothes.

Airbag deactivation

The front passenger airbag system must be deactivated for child restraint system on the passenger seat according to the instructions in the table ⇨ 69.

When the front passenger seat is in the folded position, the front passenger airbag system must be deactivated.

Seat folding ⇨ 50.

The side airbag and curtain airbag systems, the belt pretensioners and all driver airbag systems will remain active.



The front passenger airbag system can be deactivated via a switch on the passenger side of the instrument panel.

Use the ignition key to choose the position:

- OFF \otimes : front passenger airbag is deactivated and will not inflate in the event of a collision, control indicator OFF \otimes illuminates continuously in the centre console
- ON \otimes : front passenger airbag is active

⚠ Danger

Deactivate passenger airbag in combination with the use of a child restraint system, subject to the instructions and restrictions in the tables ⇨ 69.

Otherwise, there is a risk of fatal injury for a person occupying a seat with a deactivated front passenger airbag.



If the control indicator \otimes illuminates for approx. 60 seconds after the ignition is switched on, the front passenger airbag system will inflate in the event of a collision.

If the control indicator \otimes illuminates after the ignition is switched on, the front passenger airbag system is deactivated. It stays on while the airbag is deactivated.

Change status only when the vehicle is stopped with the ignition off.

Status remains until the next change.

If \otimes is indicated in the instrument cluster permanently there is a fault in the airbag system. Seek the

assistance of a workshop. The airbags and belt pretensioners may fail to trigger in the event of an accident.

Control indicator for airbag and belt tensioners ⇨ 111.

Control indicator for airbag deactivation ⇨ 112.

Child restraints

Child restraint systems

Danger

If using a rear-facing child restraint system on the front passenger seat, the airbag system for the front passenger seat must be deactivated. This also applies to certain forward-facing child restraint systems as indicated in the tables ⇨ 69.

Airbag deactivation ⇨ 64.

Airbag label ⇨ 60.

We recommend a child restraint system which is tailored specifically to the vehicle. For further information, contact your workshop.

When a child restraint system is being used, pay attention to the following usage and installation instructions as well as to those supplied with the child restraint system.

With a child seat installed usage of one or more seats in the same row may not be allowed.

Always comply with local or national regulations. In some countries, the use of child restraint systems is forbidden on certain seats.

Child restraint systems can be fastened with:

- Three-point seat belt
- ISOFIX brackets
- Top-tether

Three-point seat belt

Child restraint systems can be fastened by using a three-point seat belt. Depending on the size of the used child restraint systems and the equipment of car, up to six child restraint systems can be attached to the rear seats. After fastening the child restraint system the seat belt has to be tightened.

Child restraint installation locations ⇨ 69.

ISOFIX brackets



ISOFIX child seats and vehicle seats with ISOFIX approval are marked with ISOFIX symbol, see illustration.

Fasten vehicle-approved ISOFIX child restraint systems to the ISOFIX brackets. Specific vehicle ISOFIX child restraint system positions are marked in the ISOFIX table ↻ 69.



i-Size child seats and vehicle seats with i-Size approval are marked with i-Size symbol, see illustration.

An i-Size child restraint system is an universal ISOFIX child restraint system according UN Regulation No. 129.

All i-Size child restraint systems can be used on any vehicle seat suitable for i-Size, i-Size table ↻ 69.

Either a Top-tether strap or a support leg must be used in addition to the ISOFIX brackets.

Top-tether anchors

Top-tether anchors are marked with the symbol  for a child seat.

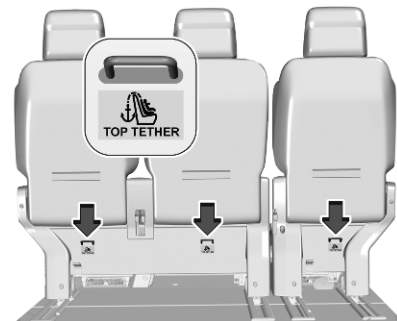

In addition to the ISOFIX mounting brackets, fasten the Top-tether strap to the Top-tether anchors.

ISOFIX child restraint systems of universal category positions are marked in the table by IUF ↻ 69.

Selecting the right system

The rear seats are the most convenient location to fasten a child restraint system.

Children should travel facing rearwards in the vehicle as long as possible. This makes sure that the

child's backbone, which is still very weak, is under less strain in the event of an accident.

Suitable are child restraint systems that comply with valid UN ECE regulations. Check local laws and regulations for mandatory use of child restraint systems.

The following child restraints are recommended for the following weight classes:

- **Group 0+:**
Römer Baby-Safe Plus installed in the rearward facing position with or without ISOFIX base for children up to 13 kg
- **Group I:**
RÖMER Duo Plus ISOFIX with or without ISOFIX and Top-tether for children from 9 kg to 18 kg
- **Group II, Group III:**
Römer Kidfix XP with or without ISOFIX for children from 15 kg to 36 kg
The child is restrained by the seat belt.

The installation is permitted only on the outer rear seats. The head restraint has to be removed.

- **Group II, Group III:**

Graco Booster for children from 15 kg to 36 kg

The child is restrained by the seat belt.

The installation is permitted on the front passenger seat or the rear seats.

Ensure that the child restraint system to be installed is compatible with the vehicle type.

Ensure that the mounting location of the child restraint system within the vehicle is correct, see following tables.

Allow children to enter and exit the vehicle only on the side facing away from the traffic.

When the child restraint system is not in use, secure the seat with a seat belt or remove it from the vehicle.

Notice

Do not affix anything on the child restraint systems and do not cover them with any other materials.

A child restraint system which has been subjected to stress in an accident must be replaced.

Child restraint installation locations

Permissible options for fastening a child restraint system with a three-point seat belt

Vivaro, without third seat row

Weight class	On front passenger seat, passenger airbag deactivated with single seat;	
	bench seat (outer seat)	bench seat (centre seat)
Group 0, Group 0+: up to 13 kg	U ^{1,2}	X
Group I: 9 to 18 kg	U ^{1,2}	X
Group II: 15 to 25 kg	U ^{1,2}	X
Group III: 22 to 36 kg	U ^{1,2}	X

Weight class	On seats in the second row ⁶
Group 0, Group 0+: up to 13 kg	U ³
Group I: 9 to 18 kg	U ^{3,4}
Group II: 15 to 25 kg	U ^{3,4}
Group III: 22 to 36 kg	U ^{3,4}

Vivaro Life, Vivaro with third seat row

On front passenger seat with
single seat;
bench seat (outer seat)

Weight class	activated airbag		bench seat (centre seat)
		deactivated airbag	
Group 0, Group 0+: up to 13 kg	X	U ^{1,2}	X
Group I: 9 to 18 kg	UF	U ^{1,2}	X
Group II: 15 to 25 kg	UF	U ^{1,2}	X
Group III: 22 to 36 kg	UF	U ^{1,2}	X

Weight class	On rear seats (row 2 and 3)
Group 0, Group 0+: up to 13 kg	U ^{3,5}
Group I: 9 to 18 kg	U ^{3,4,5}
Group II: 15 to 25 kg	U ^{3,4,5}
Group III: 22 to 36 kg	U ^{3,4,5}

U : universal suitability for forward-facing or rearward-facing child restraint systems in conjunction with three-point seat belt

UF : universal suitability for forward-facing child restraint systems in conjunction with three-point seat belt

X : no child restraint system permitted in this weight class

¹ : move seat forwards as far as necessary and adjust seat backrest inclination as far as necessary to a vertical position to ensure that the belt runs forwards from the upper anchorage point

-
- 2 : adjust seat backrest inclination as far as necessary to a vertical position to ensure that the belt is tight on the buckle side
 - 3 : move the respective seat ahead of the child restraint system forwards as far as necessary and adjust its backrest inclination as far as necessary to a vertical position
 - 4 : adjust the respective headrest as necessary or remove if required
 - 5 : single seats: with a child seat installed on the centre seat, usage of outer seats is not allowed
 - 6 : fixed seat bench; folding seat bench is in process of being approved

Permissible options for fitting an ISOFIX child restraint system with ISOFIX brackets

Vivaro

Weight class	Size class	On front passenger seat	On seats in the second row ⁶ with		with single passenger seat in front		single seats
			passenger bench in front		outer seats	centre seat	
			outer seats	centre seat			
Group 0: up to 10 kg	F	X	X	X	IL ^{3,4}	X	X
	G	X	X	X	IL ^{3,4}	X	IL ²
Group 0+: up to 13 kg	C	X	X	X	IL ^{3,4}	X	IL ²
	D	X	X	X	IL ^{3,4}	X	IL ²
	E	X	X	X	IL ^{3,4}	X	IL
Group I: 9 to 18 kg	C	X	X	X	IL ^{3,4}	X	IL ²
	D	X	X	X	IL ^{3,4}	X	IL ²
	A	X	IUF ^{3,4}	X	IUF ^{3,4}	X	IUF, IL
	B	X	IUF ^{3,4}	X	IUF ^{3,4}	X	IUF, IL
	B1	X	IUF ^{3,4}	X	IUF ^{3,4}	X	IUF, IL

Weight class	Size class	On seats in the third row	
		Fixed seat and bench seat	Fixed one-piece bench seat
Group 0: up to 10 kg	F	X	X
	G	X	X
Group 0+: up to 13 kg	C	X	X
	D	X	X
	E	X	X
Group I: 9 to 18 kg	C	X	X
	D	X	X
	A	IUF, IL ^{4,5}	X
	B	IUF, IL ^{4,5}	X
	B1	IUF, IL ^{4,5}	X

Vivaro Life

Weight class	Size class	On front passenger seat	On seats in the second row with		Single seats on rails ⁵	
			fixed seats, bench seat	1/3 - 2/3 bench seats on rails	outer seats	centre seat
Group 0: up to 10 kg	F	X	X	IL ^{1,2,3}	IL ^{1,2,3}	X
	G	X	IL ^{1,2}	IL ^{1,2,3}	IL ^{1,2,3}	X
Group 0+: up to 13 kg	C	X	IL ²	IL	IL	IL ³
	D	X	IL ²	IL	IL	IL
	E	X	IL	IL	IL	IL
Group I: 9 to 18 kg	C	X	IL ²	IL	IL	IL ³
	D	X	IL ²	IL	IL	IL
	A	X	IUF, IL ⁴	IUF, IL ⁴	IUF, IL ⁴	IUF, IL ⁴
	B	X	IUF, IL ⁴	IUF, IL ⁴	IUF, IL ⁴	IUF, IL ⁴
	B1	X	IUF, IL ⁴	IUF, IL ⁴	IUF, IL ⁴	IUF, IL ⁴
	B2	X	IUF, IL ^{4,5}	IUF, IL ^{4,5}	IUF, IL ^{4,5}	X
	B3	X	IUF, IL ^{4,5}	X	IUF, IL ^{4,5}	X

Weight class	Size class	On seats in the third row				
		Fixed seat and bench seat, fixed seats	Fixed one-piece bench seat	1/3 - 2/3 bench seats on rails		Single seats on rails ⁵
				Outer seats	centre seat	
Group 0: up to 10 kg	F	X	X	IL ^{1,2,3}	IL ^{1,2,3}	X
	G	X	X	IL ^{1,2,3}	IL ^{1,2,3}	X
Group 0+: up to 13 kg	C	X	X	X	X	IL ³
	D	X	X	IL ³	IL ³	IL ³
	E	X	X	IL ³	IL ³	IL
Group I: 9 to 18 kg	C	X	X	X	X	IL ³
	D	X	X	IL ³	IL ³	IL ³
	A	IUF, IL ^{4,5}	X	IUF, IL ⁴	IUF, IL ⁴	IUF, IL ⁴
	B	IUF, IL ^{4,5}	X	IUF, IL ⁴	IUF, IL ⁴	IUF, IL ⁴
	B1	IUF, IL ^{4,5}	X	IUF, IL ⁴	IUF, IL ⁴	IUF, IL ⁴
	B2	IUF, IL ^{4,5}	X	IUF, IL ^{3,4,5}	IUF, IL ^{3,4,5}	X
	B3	IUF, IL ^{4,5}	X	IUF, IL ^{3,4,5}	IUF, IL ^{3,4,5}	X

- IL : suitable for particular ISOFIX restraint systems of the 'specific-vehicle', 'restricted' or 'semi-universal' categories.
The ISOFIX restraint system must be approved for the specific vehicle type (refer to the vehicle type list of the child restraint system)
- IUF : suitable for ISOFIX forward-facing child restraint systems of universal category approved for use in this weight class
- X : no ISOFIX child restraint system approved in this weight class
- N/A : not applicable
- 1 : with a child seat installed usage of one or more seats in the same row may not be allowed
- 2 : installation possible only behind the driver's seat
- 3 : move the respective front seat ahead of the child restraint system forwards as far as necessary
- 4 : adjust the respective headrest as necessary or remove if required
- 5 : with a child seat installed on the centre seat, usage of outer seats is not allowed
- 6 : fixed seat bench; folding seat bench is in process of being approved

ISOFIX size class and seat device

- A – ISO//F3 : forward-facing child restraint system for children of maximum size in the weight class 9 to 18 kg
- B – ISO//F2 : forward-facing child restraint system for smaller children in the weight class 9 to 18 kg
- B1 – ISO//F2X : forward-facing child restraint system for smaller children in the weight class 9 to 18 kg
- C – ISO//R3 : rear-facing child restraint system for children of maximum size in the weight class up to 18 kg
- D – ISO//R2 : rear-facing child restraint system for smaller children in the weight class up to 18 kg
- E – ISO/R1 : rear-facing child restraint system for young children in the weight class up to 13 kg
- F – ISO/L1 : left lateral facing position child restraint system (carry-cot)
- G – ISO/L2 : right lateral facing position child restraint system (carry-cot)
- B2 – ISO//B2 : booster seat, reduced width (440 mm)
- B3 – ISO//B3 : booster seat, full width (520 mm)

Permissible options for fitting an i-Size child restraint system

i-Size child restraint systems

	On front passenger seat	On seats in the second row			On seats in the third row	
		one-piece bench seat; passenger bench in front	seat and bench seat	single seats on rails	one-piece bench seat; seat and bench seat	single seats on rails
Vivaro, without third seat row	X	X	X	N/A	N/A	N/A
Vivaro, with third seat row	X	i - UF ¹	i - U ¹	N/A	i - U ^{1,3}	N/A
Vivaro Life	X	i - U ²	i - U ²	X	i - U ^{1,3,4}	X

i - U : suitable for i-Size 'universal' forward and rearward facing child restraint systems

i - UF : suitable only for i-Size 'universal' forward facing child restraint systems

X : seating position not suitable for i-Size 'universal' child restraint systems

¹ : with a child seat installed on the centre seat, usage of outer seats is not allowed

² : adjust the respective headrest as necessary or remove if required

³ : usage of the seat in the second row is not allowed when an i-Size child seat is installed directly behind it

⁴ : move the respective seat ahead of the child restraint system forwards as far as necessary and adjust its backrest inclination as far as necessary to a vertical position

Storage

Storage compartments	78
Glovebox	78
Cupholders	78
Front storage	79
Underseat storage	80
Load compartment	81
Load compartment cover	81
Lashing eyes	82
Cargo management system	82
Safety net	84
Additional storage features	86
Folding tray	86
Table	87
Roof rack system	90
Roof rack	90
Loading information	91

Storage compartments

⚠ Warning

Do not store heavy or sharp objects in the storage compartments. Otherwise vehicle occupants could be injured by objects being thrown around in the event of hard braking, a sudden change in direction or an accident.

Glovebox

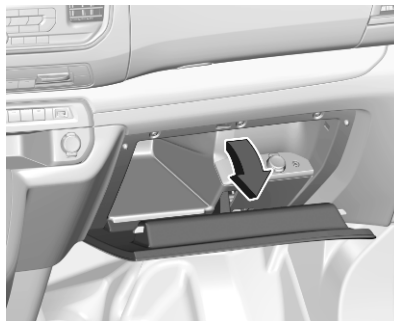

To open the glovebox pull the handle.

Some versions have a power outlet, AUX input and the switch for the front passenger airbag deactivation in the storage compartment.

The glovebox should be closed whilst driving.

Cupholders

Front cupholder



Cup holders are located at the sides of the instrument panel.

Rear cupholder

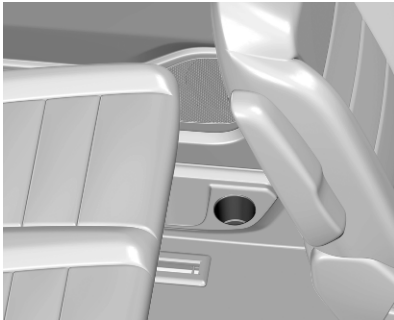

A cupholder for the second row seat can be located in the storage compartment in the footwell.



Cupholders for the third row seats can be located in the sides of the load compartment.

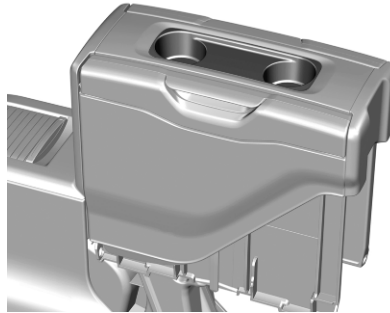

Fold up the multifunctional table.
Multifunctional table ⇨ 87.

Front storage

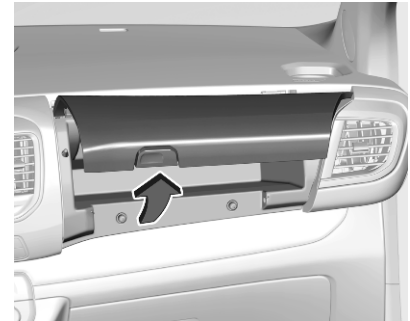

To open the storage compartment press the button and open the cover. Some versions have a glovebox cooler in the storage compartment.



To open the storage compartment press the button and open the cover. Folding tray ⇨ 86.

Underseat storage

Storage box



There may be a storage box under the centre bench seat next to the driver seat. Lift up the seat cushion by pulling the handle.



There may be a storage box under the centre and left bench seat. Lift up the seat cushion.

Depending on version the storage box can be removed from the back to accommodate long objects.

Load compartment

Depending on version, the load compartment area can be increased by folding up or removing the seats in the second and third row.

Vehicle version with seat benches in second and third row

When loading the following has to be observed:

- Only store objects on seats of the third row folded down to the table position, when the seats in the second row are also folded down to the table position.



- Bench seat in the second or third row in the tilted position: the outer seat must not be occupied.



- Single bench seat in the second or third row in the tilted position: the center seat must not be occupied.



- Seat in the second row folded down to the table position: respective seat in the third row must not be occupied.



- Seat in the second row in the tilted position: respective seat in the third row must not be occupied.

Folding the passenger seat ↗ 50.

Folding or removing the rear seats ↗ 52.

Load compartment cover

Do not place any objects on the cover.

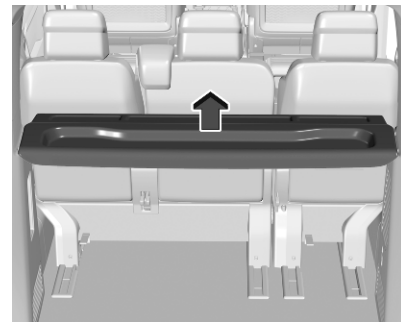

Raise the load compartment cover to remove it.

To install the load compartment cover insert it in the retainers on both sides.

Lashing eyes

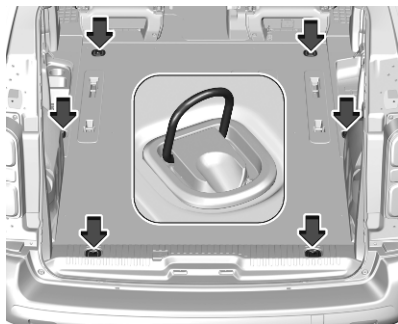

The lashing eyes are designed to secure items against slippage, e.g. using lashing straps or luggage net.

Lashing eyes may be located on the vehicle floor. The number and location of the lashing eyes may vary depending on the vehicle.

Cargo management system

Flap behind the passenger seat

Depending on version, a partition behind the front seats protects the driver and front passengers against the risk of load movement.

There may be a flap in the partition behind the passenger seat which can be removed to accommodate long objects.

If the outer passenger seat is folded and the flap is open, the centre seat has to stay free.

Removing the flap

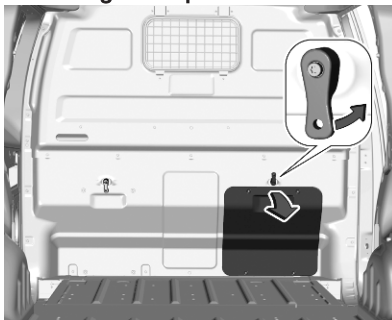

1. Release the locking device, lower the flap and then remove it.
2. Stow the flap behind the driver's seat.



Turn the locking device upwards. Put the hinges of the flap in their housing, lift the flap and close the locking device.

Sliding the flap

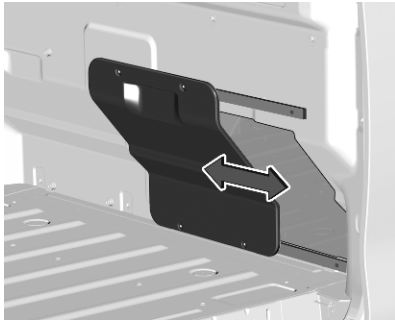

Slide the flap to the side. It is kept in position by magnets.

Fitting the protective net

The protective net must be installed whenever the bench seat of the front passenger side is folded and the partition flap is open.

1. Lift the seat cushion of the bench seat of the front passenger side.
Seat folding ⇨ 50.

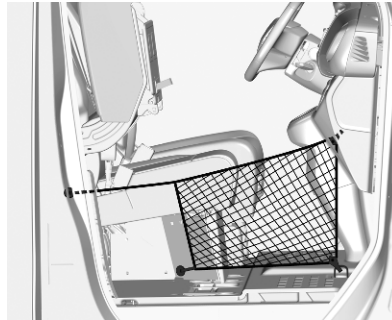

2. Fix the net like shown on the picture.

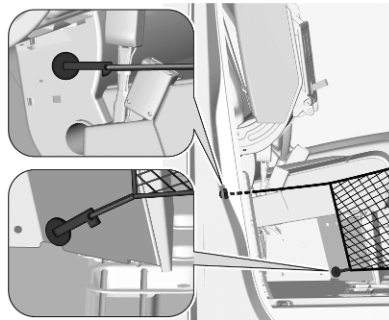

3. Fit the attachment in the opening.
To lock the attachment turn it clockwise a quarter turn.

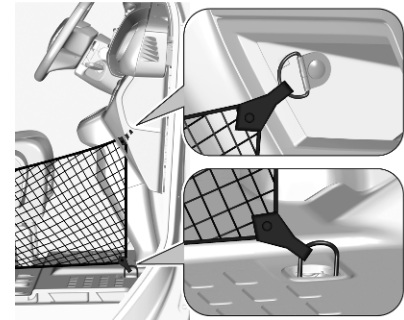

4. Attach the hooks to the lashing eyes in the glovebox and on the floor.

After transportation remove the protective net and fold down the seat.

Second row bench seat in the commercial vehicle

The bench seat in the second row can be folded to increase the load compartment.

⚠ Warning

When seats are being adjusted or folded, keep hands and feet away from the moving area. Risk of injury.

Ensure that there are no objects on the anchor points or rails.

Never adjust seats while driving as they could move uncontrollably.

Drive only with engaged seats and backrests.

Folding



1. Tilt the head restraints to the front.

Pull the loop upwards to unlock the bench seat.

2. Raise the bench seat taking the handle and fold the bench seat to the front until it is engaged.

Unfolding



1. To restore the bench seat to the original position pull the loop to unlock it.
2. Take the handle to fold the bench seat to the back until it is engaged in the original position.
Tilt up the head restraints.

Safety net

Safety net behind the seats

Depending on version, the safety net can be installed behind the second row seats, the third row seats or behind the front seats.

To increase the loading capacity the seats behind the safety net can be folded or removed.

Rear seats ⇄ 52.

Seat backrests in front of the safety net must be raised up.

Passengers must not be transported behind the safety net.

Installation in the roof frame



1. There are installation openings on both sides in the roof frame. If present, open the covers.
2. Suspend and engage the rod of net at one side, compress rod and suspend and engage at the other side.

Installation on the floor

1. a) Installation with lashing eyes

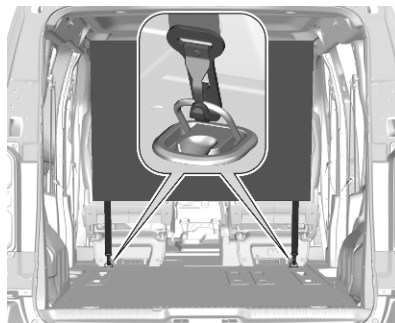

Attach the hooks of safety net straps in the lashing eyes.

Lashing eyes ⇨ 82.

- b) Installation with rear seats on rails

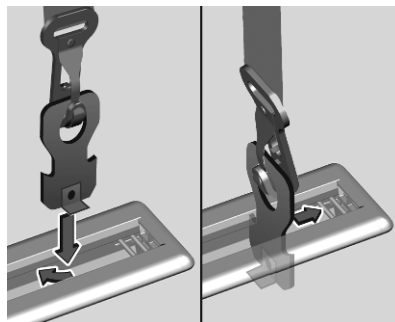

Insert the fixings in the floor anchorages on both sides. To lock the fixings turn them clockwise a quarter turn. Place them as close as possible to the end of the rail.

- c) Installation with fixed rear seats



Insert the fixings in the floor anchorages on both sides.

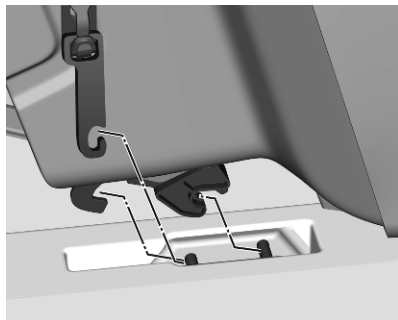

It is possible to install the safety net together with folded seats.

Folded seats ⇨ 52.

2. Tension both straps by pulling at the loose end.

Safety net on the floor

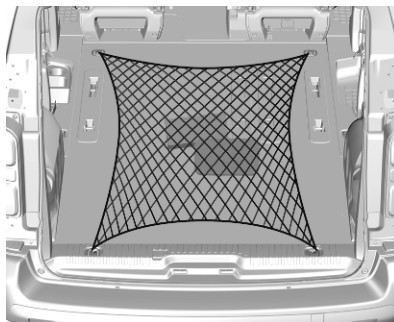

Attached to the lashing eyes on the rear floor, it allows objects to be held down.

Lashing eyes ⇨ 82.

Additional storage features

Folding tray



Trays may be located on the backrests of the front seats.

Fold down the tray. The tray contains a cupholder and a strap to secure objects.

Do not place any hard or heavy objects on the tray.

Document tray in the centre seatback

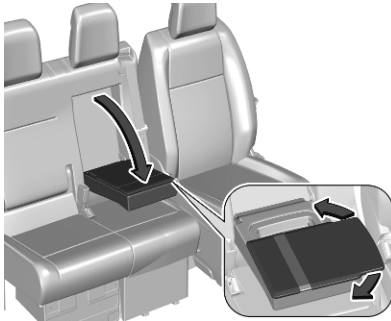

The front centre passenger seat backrest can contain a document tray.

Fold down the tray. The document tray contains a storage compartment and a swivelling shelf.

Return the swivelling shelf to its original position before raising the tray.

Table

Multifunctional table



The multifunctional table can be positioned in second or third row.

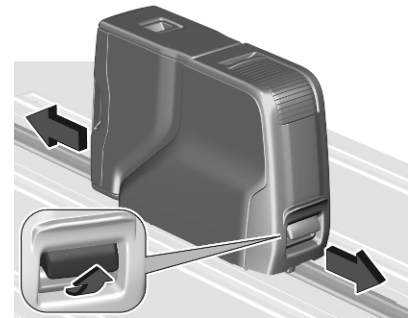

To move the multifunctional table pull the handle in the front without going beyond the point of resistance. Slide the multifunctional table forwards or backwards. Release the handle when it is in the desired position. Make sure that the multifunctional table is securely engaged.

Storage compartment in the multifunction table



Press the cover to open the storage compartment.

The maximum permitted load is 3 kg.

Unfolding

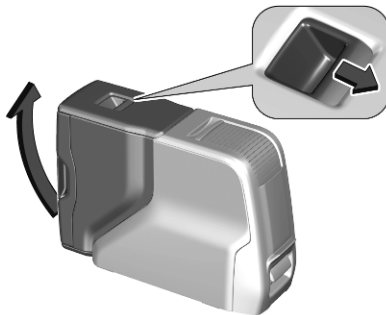

To unfold the multifunction table pull the handle on the top. Pull the rear part to the vertical position until it engages.

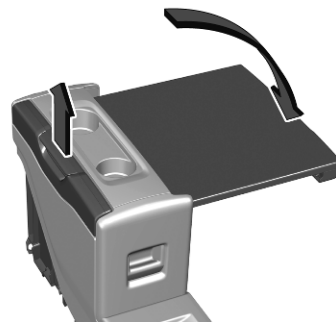

On the two sides there are tables located. Pull the table fully up and then move it into the horizontal position.

Each table can bear a maximum load of 10 kg.

Caution

To avoid damaging the table tops never unfold the table when it is between individual seats.

Folding

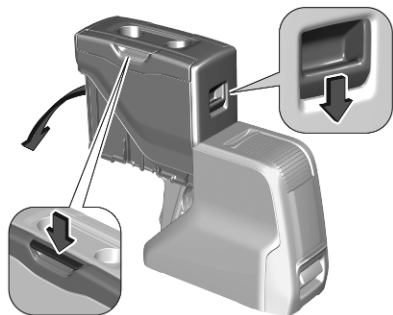

To stow the table use the handle to move it back in the folded position.
To fold the multifunctional table pull the handle and move the rear part downwards until it engages.

Removing

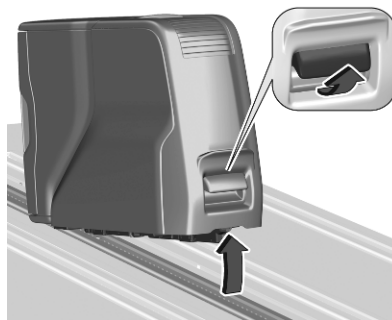

To remove the multifunctional table pull the handle in the front beyond the point of resistance. Remove the multifunctional table.

Refitting

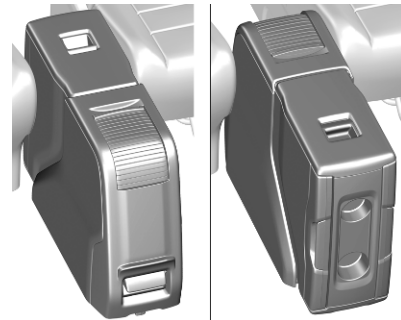

The multifunctional table can be fitted in two positions.

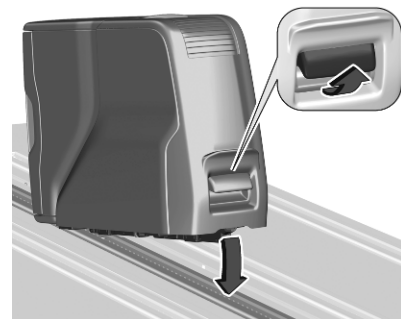

The handle in the front has to be in the tightened position. Place the rear of the multifunctional table on the rail and tip the front down. Slide the multifunctional table until it engages.

⚠ Warning

Never use the multifunctional table in the unfolded position while the vehicle is in motion. Any objects on the table will turn into projectiles in the event of a sudden stop or collision.

Ensure that the multifunctional table is correctly folded before moving or removing it.

Never use the tables as seats or lean on them.

Check that there is no object obstructing the rail and preventing locking.

Roof rack system

Roof rack

For safety reasons and to avoid damage to the roof, the vehicle approved roof rack system is recommended. For further information contact your workshop.

Follow the installation instructions and remove the roof rack when not in use.

The roof load is the combined weight of the roof rack and the load.

Loading information ⇨ 91.

Mounting

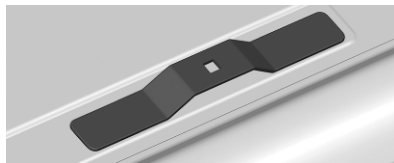

Fasten the roof rack according to the installation instructions delivered with the roof rack.

The number and location of the mounting points may vary depending on the vehicle:

Vehicles with glass panel

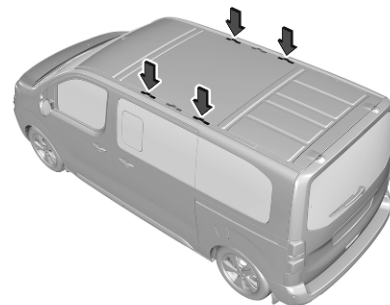

Mount two roof bars using the mounting points marked in the picture.

Permissible roof load L1, L2, L3 max. 100 kg.

Vehicles without glass panel

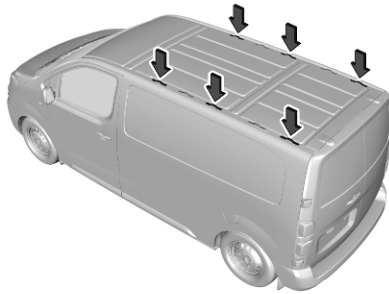

Mount three roof bars using the mounting points marked in the picture.

Permissible roof load L1, L2, L3 max.
150 kg.

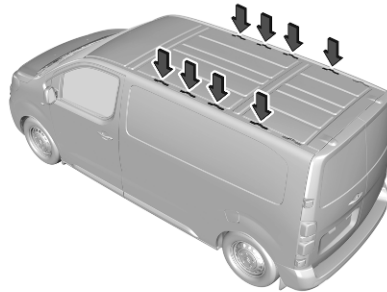

Mount the roof rack using the mounting points marked in the picture.

Permissible roof load L1 max.
140 kg.

Permissible roof load L2, L3 max.
170 kg.

Vehicle dimensions ⇨ 295

Loading information

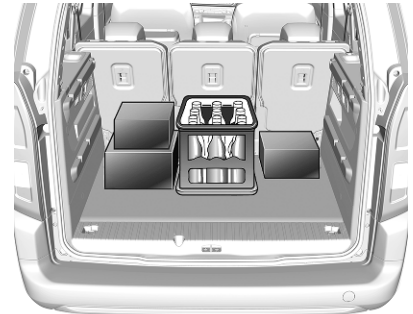

- Heavy objects in the load compartment should be placed against the seat backrests. Make sure that the backrests are securely engaged. If objects can be stacked, heavier objects should be placed at the bottom.
- Prevent sliding of loose objects by securing them with straps attached to the lashing eyes.
Lashing eyes ⇨ 82.
- Do not allow the load to protrude above the upper edge of the backrests.

- Do not place any objects on the rear luggage cover or the instrument panel, and do not cover the sensor on top of the instrument panel.
- The load must not obstruct the operation of the pedals, parking brake and gear selector, or hinder the freedom of movement of the driver. Do not place any unsecured objects in the interior.
- Do not drive with an open load compartment.

Warning

Always make sure that the load in the vehicle is securely stowed. Otherwise objects can be thrown around inside the vehicle and cause personal injury or damage to the load or car.

- The payload is the difference between the permitted gross vehicle weight (see identification plate) and the EC kerb weight. Identification plate ⇨ 289.

To calculate the payload, enter the data for your vehicle in the weights table at the front of this manual.

The EC kerb weight includes weights for the driver (68 kg), luggage (7 kg) and all fluids (fuel tank 90% full).

Optional equipment and accessories increase the kerb weight.

- Driving with a roof load increases the sensitivity of the vehicle to cross-winds and has a detrimental effect on vehicle handling due to the vehicle's higher centre of gravity. Distribute the load evenly and secure it properly with retaining straps. Adjust the tyre pressure and vehicle speed according to the load conditions. Check and retighten the straps frequently. Do not drive faster than 75 mph.

Instruments and controls

Controls	94
Steering wheel adjustment	94
Steering wheel controls	94
Horn	95
Pedestrian safety alert	95
Steering column controls	95
Windscreen wiper and washer ..	96
Rear window wiper and washer	97
Outside temperature	98
Clock	98
Power outlets	98
Warning lights, gauges and indicators	100
Instrument cluster	100
Speedometer	105
Odometer	105
Trip odometer	105
Tachometer	106
Fuel gauge	106
High voltage battery gauge	107
Power indicator gauge	108
Comfort consumption gauge ...	108

Engine coolant temperature gauge	108
Engine oil level monitor	109
Service display	109
Control indicators	110
Turn lights	111
Seat belt reminder	111
Airbag and belt tensioners	111
Airbag deactivation	112
Charging system	112
Malfunction indicator light	112
Service vehicle soon	112
Stop engine	112
System check	113
Brake system	113
Parking brake	113
Electric parking brake	113
Electric parking brake fault	113
Automatic operation of electric parking brake off	113
Antilock brake system (ABS) ..	114
Gear shifting	114
Lane departure warning	114
Electronic Stability Control and Traction Control system	114
Engine coolant temperature	114
Preheating	115
Exhaust filter	115
AdBlue	115
Deflation detection system	115

Engine oil pressure	115
Low fuel	116
Charging cable connected	116
Vehicle ready	116
Reduced engine power	116
Autostop	116
Exterior light	116
Low beam	116
High beam	116
High beam assist	116
LED headlights	117
Front fog lights	117
Rear fog light	117
Rain sensor	117
Cruise control	117
Semi-adaptive cruise control ..	117
Pedestrian safety alert fault	117
Side blind spot alert	117
Active emergency braking	117
Speed limiter	117
Door open	117
Displays	118
Driver Information Centre	118
Info Display	123
Head-up display	125
Vehicle messages	126
Warning chimes	127
Vehicle personalisation	127

Telematics services	132
Vauxhall Connect	132
ERA GLONASS	133

Controls

Steering wheel adjustment

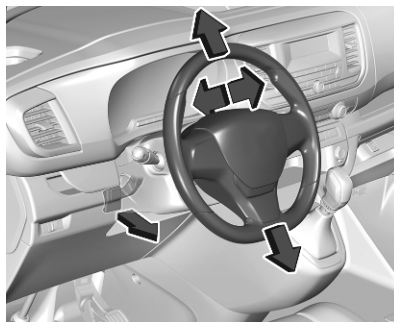

Unlock lever, adjust steering wheel, then engage lever and ensure it is fully locked.

Do not adjust steering wheel unless vehicle is stationary and steering wheel lock has been released.

Steering wheel controls



The menus and functions of the Driver Information Centre can be selected via the rotary knob on the left steering wheel stalk.

Driver Information Centre ⇨ 118.

Infotainment system can be operated via the steering wheel controls.

Further information is available in the Infotainment Manual.

Steering wheel paddles

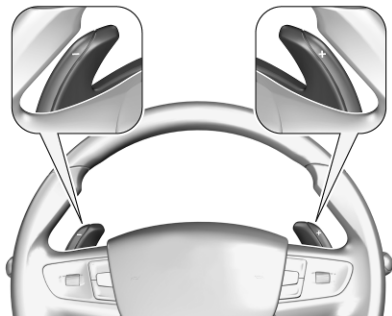

On vehicles with automatic transmission, gearshifting can be operated via + or -.

Automatic transmission ⇨ 174.

Manual mode ⇨ 175.

Horn

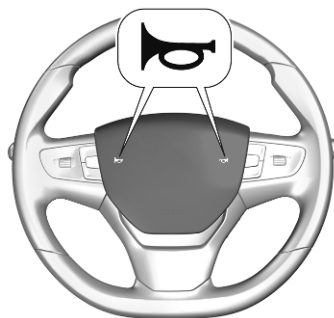

Press .

Pedestrian safety alert

The sound of the pedestrian safety alert is generated to indicate the vehicle presence to pedestrians. It is active up to 19 mph.

Steering column controls



Cruise control, semi-adaptive cruise control and speed limiter are operated via the driver assistance control on the left side of the steering column.

Cruise control ⇨ 186.

Speed limiter ⇨ 189.

Semi-adaptive cruise control ⇨ 193.

Windscreen wiper and washer

Windscreen wiper with adjustable wiper frequency



- 2** : fast
- 1** : slow
- INT** : interval wiping
- 0** : off

For a single wipe when the windscreen wiper is off, press the lever down.

Do not use if the windscreen is frozen.
Switch off in car washes.

To activate interval wiping mode the next time ignition is switched on, press the lever downwards to position **0** and back to **INT**.

Windscreen wiper with rain sensor

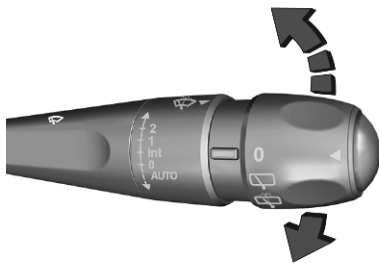

- 2** : fast
- 1** : slow
- INT** : interval wiping
- 0** : off
- AUTO** : automatic wiping with rain sensor

In **AUTO** position, the rain sensor detects the amount of water on the windscreen and automatically regulates the frequency of the

windscreen wiper. To deactivate the automatic wiping mode, press the lever downwards to **AUTO** again.

If ignition is switched off for more than a minute, automatic wiping mode is deactivated. To activate automatic wiping mode the next time ignition is switched on, press the lever downwards to **AUTO** again.

For a single wipe when the windscreen wiper is off, pull the lever briefly towards you.

Do not use if the windscreen is frozen.
Switch off in car washes.

Windscreen washer



Washer fluid is sprayed onto the windscreen and the wiper wipes a few times.

Washer fluid ↗ 242.

Functionality of the rain sensor





Keep the sensor free from dust, dirt and ice.

Control indicator  ↗ 96.

Rear window wiper and washer

Rear window wiper



- 0** : off
-  : intermittent operation
-  : rear window washer

Do not use if the rear window is frozen.

Switch off in car washes.

The rear window wiper comes on automatically when the windscreen wiper is switched on and reverse gear is engaged.

Activation or deactivation of this function can be changed in the Vehicle personalisation menu ↗ 127.

Rear window washer



Set to .

Washer fluid is sprayed onto the rear window and the wiper wipes a few times.

The rear window washer system is deactivated when the fluid level is low.

Washer fluid ↗ 242.

Outside temperature



Illustration shows an example.

If outside temperature drops to 3 °C, a warning message is displayed in the Driver Information Centre.

⚠ Warning

The road surface may already be icy even though the display indicates a few degrees above 0 °C.

Clock

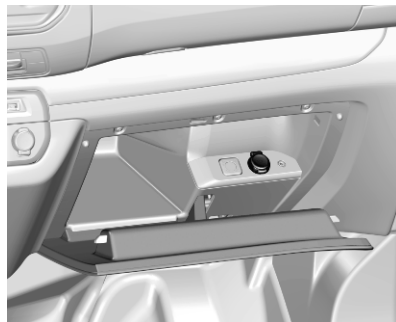

Illustration shows an example.

Date and time are shown in the Info Display.

The adjustment of date and time is described in the Infotainment Manual. Info Display ⇨ 123.

Power outlets



A 12 V power outlet is located in the glovebox.



A 12 V power outlet is located in the centre console.

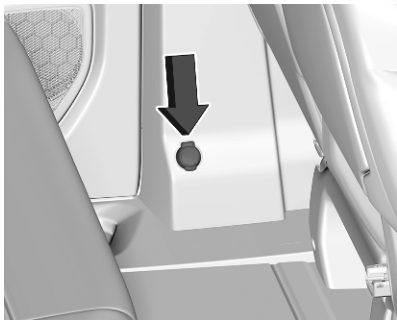

A 12 V power outlet may be located at the lower left side of the B-pillar.



A 12 V power outlet may be located on the third row left side trim.



Another 12 V power outlet may be located at the lower left side of the D-pillar.

Do not exceed the maximum power consumption of 120 W.



A 220 V power outlet may be located underneath the front passenger seat.

Do not exceed the maximum power consumption of 120 W.

With ignition off, the power outlets are deactivated. Additionally the power outlets are deactivated in the event of low vehicle battery voltage.

Electrical accessories that are connected must comply with the electromagnetic compatibility requirements laid down in DIN VDE 40 839.

Do not connect any current-delivering accessories, e.g. electrical charging devices or batteries.

Do not damage the outlet by using unsuitable plugs.

Stop-start system ⇨ 163.

USB port

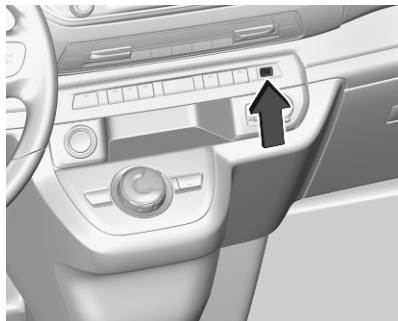

A USB port is located in the instrument panel.

A USB port may be located within the compartment located above the glovebox.

A further USB port may be located in the rear console.

The USB ports are prepared for charging external devices and provide a data connection to the

Infotainment system. For further information, see Infotainment Manual.

Notice

The sockets must always be kept clean and dry.

Warning lights, gauges and indicators

Instrument cluster

Depending on the version, three instrument clusters are available:

- Baselevel
- Midlevel
- Uplevel

Baselevel instrument cluster

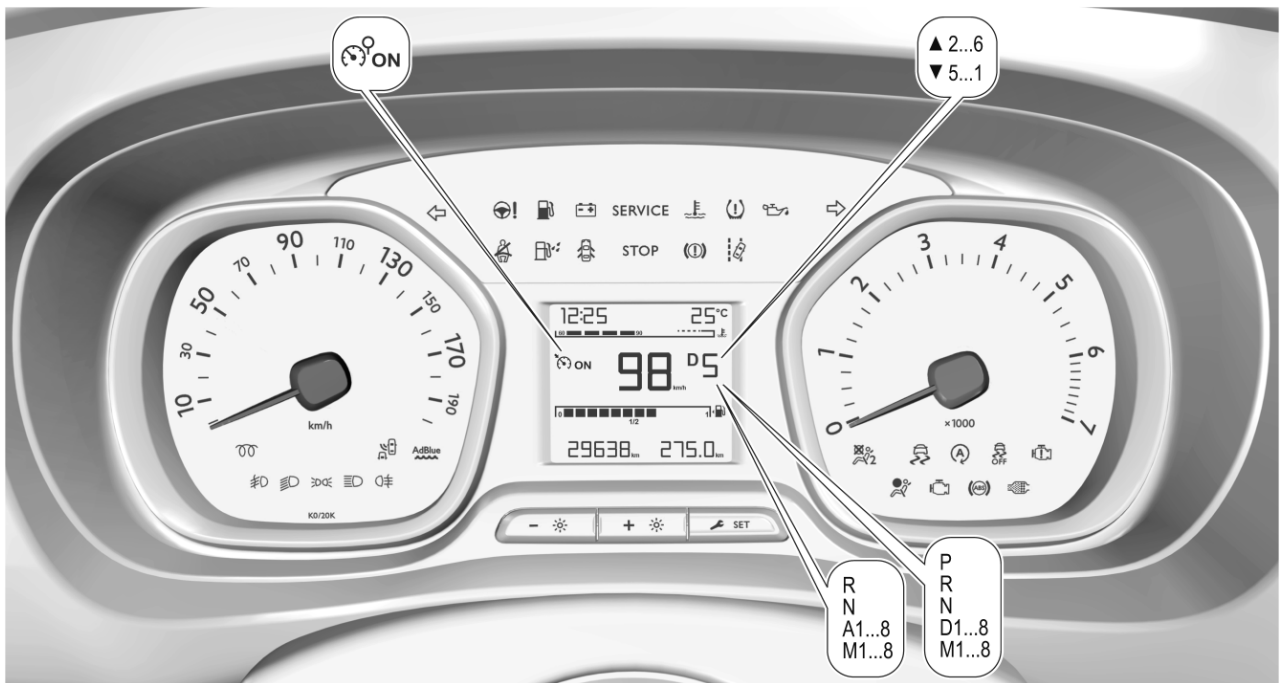

Midlevel instrument cluster

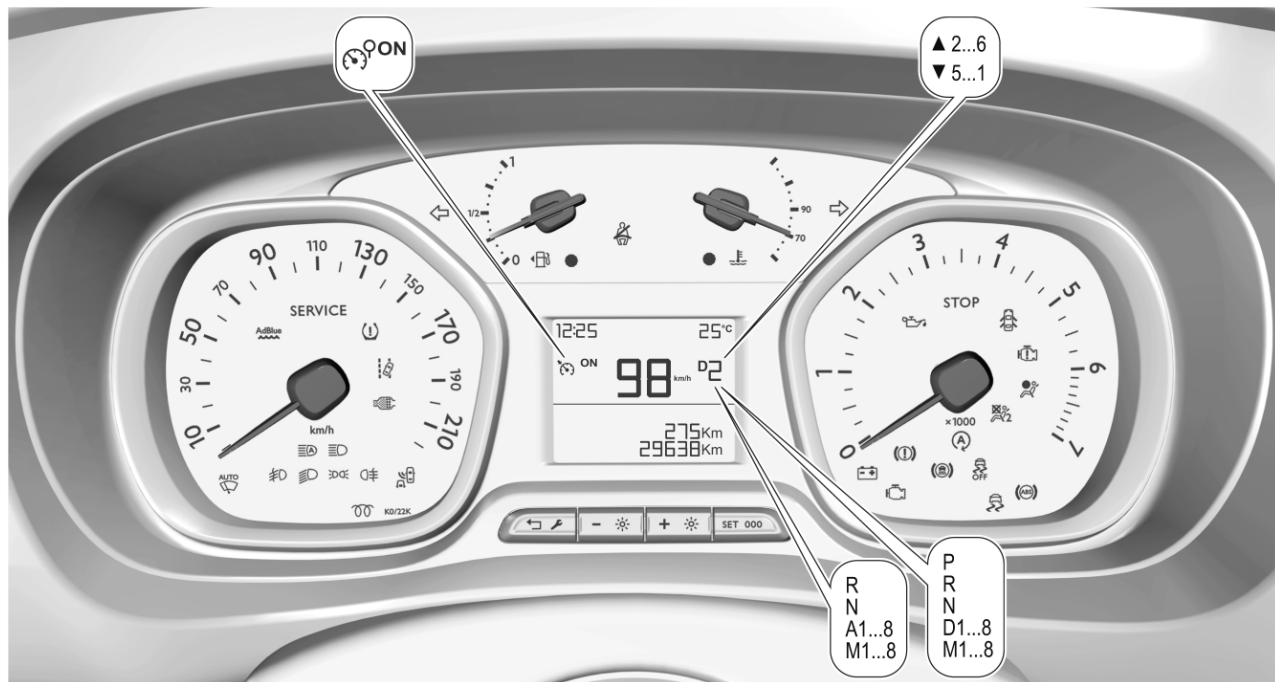



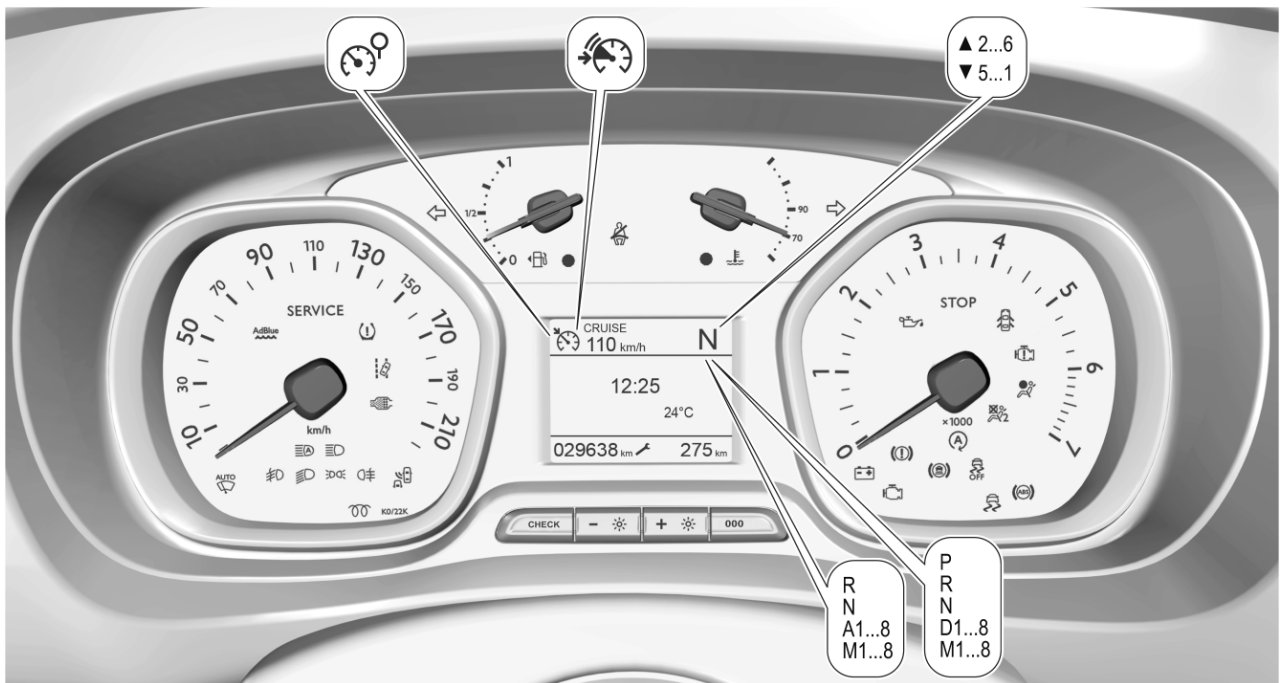



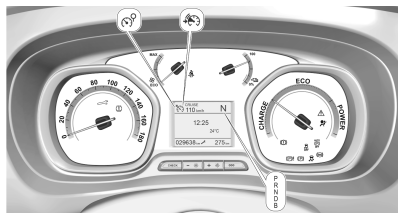

Uplevel instrument cluster































Cluster electric vehicle



Overview

-  Turn lights ⇨ 111
-  Seat belt reminder ⇨ 111
-  Airbag and belt tensioners ⇨ 111
-  Airbag deactivation ⇨ 112
-  Charging system ⇨ 112
-  Malfunction indicator light ⇨ 112
-  Service vehicle soon ⇨ 112
-  LED headlights ⇨ 117
- STOP** Stop engine ⇨ 112

-  System check ⇨ 113
-  Parking brake ⇨ 113
-  Antilock brake system (ABS) ⇨ 114
-  Gear shifting ⇨ 114
-  Lane departure warning ⇨ 114
-  Electronic Stability Control and Traction Control system ⇨ 114
-  Preheating ⇨ 115
-  Exhaust filter ⇨ 115
-  AdBlue ⇨ 115
-  Tyre deflation detection system ⇨ 115
-  Engine oil pressure ⇨ 115
-  Low fuel ⇨ 116
-  Engine coolant temperature high ⇨ 114
-  Autostop ⇨ 116
-  Exterior light ⇨ 116
-  Low beam ⇨ 116
-  High beam ⇨ 116
-  High beam assist ⇨ 116
-  Front fog lights ⇨ 117
-  Rear fog light ⇨ 117
-  Rain sensor ⇨ 117
-  Side blind spot alert ⇨ 117
-  Cruise control ⇨ 117
-  Semi-adaptive cruise control ⇨ 117
-  Speed limiter ⇨ 117
-  Active emergency braking ⇨ 117
-  Door open ⇨ 117
-  Service vehicle soon ⇨ 112
-  Charge cord connected ⇨ 116

READY Vehicle ready ⇨ 116

 Reduced engine power
⇨ 116

 Pedestrian safety alert
fault ⇨ 117

 Battery gauge ⇨ 107

Speedometer



Indicates vehicle speed.

Odometer



The total recorded distance is displayed in miles.

Trip odometer

The recorded distance since the last reset is displayed in the Driver Information Centre.

Baselevel instrument cluster



Trip odometer counts up to 9,999.9 miles without automatic reset.

Press  **SET** for 2 seconds to reset trip odometer.

Midlevel instrument cluster



Trip odometer counts up to 9,999.9 miles without automatic reset.

Press **SET 000** for 2 seconds to reset trip odometer.

Uplevel instrument cluster



Trip odometer counts up to 1,999.9 miles and resets then automatically.

Press **000** for 2 seconds to reset trip odometer.

Driver Information Centre ⇨ 118.

Tachometer



Displays the engine speed.

Drive in a low engine speed range for each gear as much as possible.

Caution

If the needle is in the red warning zone, the maximum permitted engine speed is exceeded. Engine at risk.

Fuel gauge

Displays the fuel level in the tank.

Never run the fuel tank dry.

The arrow indicates the vehicle side where the fuel filler flap is located.

Because of the fuel remaining in the tank, the top-up quantity may be less than the specified tank capacity.

Baselevel cluster



A scale consisting of white segments shows the fuel level.

If the control indicator  illuminates yellow, refuel the tank immediately.

Midlevel and uplevel instrument cluster

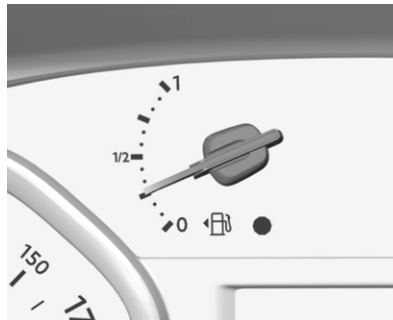

If the control indicator  illuminates yellow, refuel the tank immediately.

High voltage battery gauge

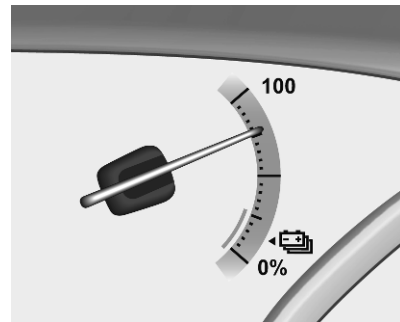

The high voltage battery gauge displays the charging level of the high voltage battery.

Power indicator gauge

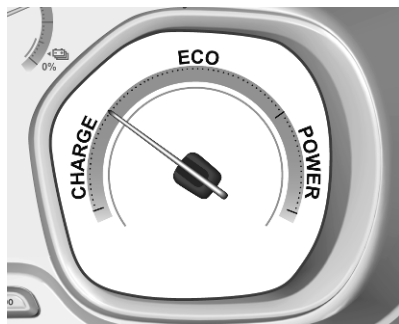

The power indicator gauge informs about the current energy situation of the vehicle.

Charge : High voltage battery is being charged with energy resulting from braking or deceleration of the vehicle

Eco : An optimum in energy is accessible in all driving modes

Power : Vehicle is driven in a dynamic driving style with focus on performance

Comfort consumption gauge



The comfort consumption gauge informs about the current electric consumption caused by the following thermal consumers:

- heating
- air conditioning
- heated windscreen
- heated rear window
- heated seats

If the drive mode **Eco mode** is selected, the performance of the thermal consumers is reduced. The needle of the comfort consumption gauge is in the **ECO** zone.

Engine coolant temperature gauge

Displays the coolant temperature.

Caution
If engine coolant temperature is too high, stop vehicle, switch off engine. Danger to engine. Check coolant level.

Baselevel cluster



A scale consisting of white segments shows the engine coolant temperature.

If the engine coolant temperature is too high, the control indicator  illuminates red.

Switch off engine immediately.

Midlevel and uplevel instrument cluster

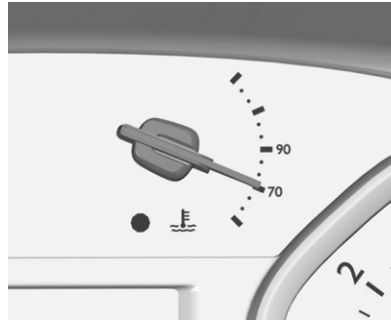

70 °C : engine operating temperature not yet reached

90 °C : normal operating temperature

red zone : temperature too high

Control indicator  illuminates if coolant temperature is too high.

Switch off engine immediately.

Engine oil level monitor



The state of the engine oil level is displayed in the Driver Information Centre for a few seconds following the service information after switching on the ignition.

A proper state of engine oil level is confirmed.

If engine oil level is low,  flashes and warning message is indicated in the Driver Information Centre.

Depending on the version,  flashes in the Driver Information Centre. Confirm engine oil level by using the oil dipstick and top up engine oil respectively.

Engine oil ⇨ 240.

A fault of measurement is indicated by  or a message in the Driver Information Centre together with . Check engine oil level manually by using the dipstick.

Service display

The service system informs when to change the engine oil and filter or a vehicle service is required. Based on

driving conditions, the interval at which an engine oil and filter change is required can vary considerably.

Service information ⇨ 284.

A required service due is displayed in the Driver Information Centre for several seconds after switching on the ignition.



If no service is required for the next 1800 miles or more no service information appears in the display.

If service is required within the next 1800 miles,  illuminates temporary as reminder. Simultaneously, the remaining distance or time duration is indicated for several seconds.

Depending on the version, the distance travelled since the due date is indicated in the Driver Information Centre.

If service is required in less than 600 miles,  flashes and then illuminates permanently. Remaining distance or time duration is indicated for several seconds. Simultaneously, the remaining distance or time duration is indicated for several seconds. Depending on the version,



the distance travelled since the due date is indicated in the Driver Information Centre.

Overdue service is indicated by a message in the Driver Information Centre which indicates the overdue distance.  flashes and then illuminates permanently until service is executed. Additionally, the control indicator  or **SERVICE** illuminates.

Reset of service interval



After each service, the service indicator must be reset to ensure proper functionality. It is recommended to seek the assistance of a workshop.

If service is executed by yourself, operate as following:

- switch off ignition
- press and hold  SET,   or **CHECK**
- switch on ignition, the distance indication begins a countdown
- when the display indicates =0, release the button and

 disappears

Retrieving service information

To retrieve the status of the service information at any time press  SET,   or **CHECK**.

The service information is displayed for a few seconds.

Instrument cluster ⇨ 100.

Service information ⇨ 284.

Control indicators

The control indicators described are not present in all vehicles. The description applies to all instrument versions. Depending on the equipment, the position of the control indicators may vary. When the ignition is switched on, most control indicators will illuminate briefly as a functionality test.

The control indicator colours mean:

- red : danger, important reminder
- yellow : warning, information, fault
- green : confirmation of activation
- blue : confirmation of activation

white : confirmation of activation
 grey : system paused, at least one
 system limitation has been
 detected

See all control indicators on different
 instrument clusters ⇨ 100.

Turn lights

⇨ ⇨ flash green.

Flash

Turn lights or the hazard warning
 flashers are activated.

Rapid flashing: failure of a turn light or
 associated fuse, failure of turn light on
 trailer.

Bulb replacement ⇨ 246.

Turn lights ⇨ 139.

Seat belt reminder

🚗 illuminates or flashes in the
 instrument cluster and, depending on
 version, in the overhead console.



After the ignition has been switched
 on, 🚗 illuminates until the seat belt
 has been fastened.

When driving faster than 12 mph and
 a seat belt is unfastened, 🚗 flashes for
 the respective seat and a chime is
 audible.

After two minutes, the chime goes off
 and 🚗 illuminates constantly in the
 overhead console until the seat belt of
 the respective seat is fastened.

Airbag and belt tensioners

🚗 illuminates yellow.

When the ignition is switched on, the
 control indicator illuminates for
 several seconds. If it does not
 illuminate, does not extinguish after
 several seconds or illuminates whilst
 driving, there is a fault in the airbag
 system. Seek the assistance of a
 workshop. The airbags and belt
 pretensioners may fail to trigger in the
 event of an accident.

Deployment of the belt pretensioners
 or airbags is indicated by continuous
 illumination of 🚗.

⚠ Warning

Have the cause of the fault
 remedied immediately by a
 workshop.

Belt pretensioners ⇨ 56.

Airbag system ⇨ 60.

Airbag deactivation



 **ON** illuminates yellow.

The front passenger airbag is activated.

 **OFF** illuminates yellow.

The front passenger airbag is deactivated.

Airbag deactivation ⇨ 64.

Charging system

 illuminates red.

Illuminates when the ignition is switched on and extinguishes shortly after the engine starts.

Illuminates when the engine is running

Stop, switch off engine. Vehicle battery is not charging. Engine cooling may be interrupted. The brake servo unit may cease to be effective. Seek the assistance of a workshop.

Malfunction indicator light

 illuminates or flashes yellow.

Illuminates when the ignition is switched on and extinguishes shortly after the engine starts.

Illuminates when the engine is running

Fault in the emission control system. The permitted emission limits may be exceeded. Seek the assistance of a workshop immediately.

Flashes when the engine is running

Fault that could lead to catalytic converter damage. Ease up on the accelerator until the flashing stops. Seek the assistance of a workshop immediately.

Service vehicle soon

 or **SERVICE** illuminates yellow.

Illuminates briefly when the ignition is switched on.

May illuminate together with other control indicators and a corresponding message in the Driver Information Centre.

Seek the assistance of a workshop immediately.

Stop engine

STOP illuminates red.

Illuminates briefly when the ignition is switched on.

Illuminates together with other control indicators, accompanied by a warning chime and a corresponding message in the Driver Information Centre.

Stop engine immediately and seek the assistance of a workshop.

System check

 illuminates yellow.

Illuminates together with **STOP**.

A major engine fault has been detected.

Stop engine as soon as possible and seek the assistance of a workshop.

Brake system

 illuminates red.

The brake fluid level is too low.

Warning

Stop. Do not continue your journey. Consult a workshop.

Parking brake

 illuminates red.

Illuminates when the manual parking brake is applied and ignition is switched on  179.

Electric parking brake

 illuminates or flashes red.

Illuminates

Electric parking brake is applied  179.

Flashes

Electric parking brake is not applied automatically. The application or the release are faulty.

Warning

Have the cause of the fault remedied immediately by a workshop.

Electric parking brake fault

! illuminates yellow.

Illuminates

Electric parking brake has a fault  179.

Warning

Have the cause of the fault remedied immediately by a workshop.

Automatic operation of electric parking brake off

 illuminates yellow.

Illuminates

Automatic operation is deactivated or faulty. In the event of a fault,  illuminates together with other control indicators or it is accompanied by a corresponding message in the Driver Information Centre.

Activate automatic operation again or have the cause remedied by a workshop in the event of a fault.



Automatic operation  179.

Antilock brake system (ABS)

 illuminates yellow.

Illuminates for a few seconds after the ignition is switched on. The system is ready for operation when the control indicator extinguishes.



If  does not extinguish after a few seconds, or if it illuminates while driving, there is a fault in the ABS. The brake system remains operational but without ABS regulation.

If  illuminates together with , a fault with the electronic brake force distribution has been detected.

Stop engine immediately and seek the assistance of a workshop.

Antilock brake system ⇨ 178.

Gear shifting

 or  with the number of the gear is indicated, when shifting is recommended for fuel saving reasons.

On some vehicles with manual transmission, the system suggests to shift into neutral position, when the activation of the stop-start system is recommended.

Lane departure warning

 flashes green.

System recognises an unintended lane change.

Lane departure warning ⇨ 213.

Electronic Stability Control and Traction Control system

 illuminates or flashes yellow.

Illuminates

A fault in the system is present. Continued driving is possible. Driving stability, however, may deteriorate depending on road surface conditions.

Have the cause of the fault remedied by a workshop.

Flashes

The system is actively engaged. Engine output may be reduced and the vehicle may be braked automatically to a small degree.

Electronic Stability Control and Traction Control system ⇨ 183.

Selective ride control ⇨ 184.

Engine coolant temperature

 or  illuminates red.

Illuminates when the engine is running

Stop, switch off engine.

Caution
Coolant temperature too high.

Check coolant level immediately ⇨ 241.



If there is sufficient coolant, consult a workshop.

Preheating

 illuminates yellow.

Preheating of diesel engine is activated. Only activates when outside temperature is low. Start the engine when control indicator extinguishes.

Exhaust filter

 or  illuminates yellow, accompanied by a message in the Driver Information Centre and a chime.

The exhaust filter requires cleaning.

Continue driving until the control indicator extinguishes.

Illuminates temporarily

Start of saturation of the exhaust filter. Start cleaning process as soon as possible by driving at a vehicle speed of at least 40 mph.

Illuminates constantly

Indication of a low additive level. Seek the assistance of a workshop.

Exhaust filter ⇨ 167.

AdBlue

 flashes or illuminates yellow.

Illuminates yellow

The remaining driving range is between 60 miles and 1500 miles.

Flashes yellow

The remaining driving range is between 0 miles and 60 miles.

AdBlue level is low. Refill AdBlue soon to avoid prevention of the engine start.

AdBlue ⇨ 168.

Deflation detection system

 illuminates or flashes yellow.

Illuminates

Tyre pressure loss in one or more wheels. Stop immediately and check tyre pressure.

Flashes

Fault in system. Consult a workshop.

Deflation detection system ⇨ 264.

Engine oil pressure

 illuminates red.

Illuminates when the ignition is switched on and extinguishes shortly after the engine starts.

Illuminates when the engine is running

Caution

Engine lubrication may be interrupted. This may result in damage to the engine and / or locking of the drive wheels.

1. Select neutral gear.
2. Move out of the flow of traffic as quickly as possible without impeding other vehicles.
3. Switch off ignition.

⚠ Warning

When the engine is off, considerably more force is needed to brake and steer. During an Autostop the brake servo unit will still be operational.

Do not remove key until vehicle is stationary, otherwise the steering wheel lock could engage unexpectedly.

Keep engine turned off and let the vehicle be towed to a workshop.

Low fuel

 or  illuminates yellow.

Level in fuel tank is too low.

Refuelling ⇨ 228.

Bleeding the diesel fuel system

⇨ 244.

Charging cable connected

 illuminates red.

The charging cable is still connected to the vehicle. The vehicle cannot be started.

Disconnect the charging cable from the charging port and close the charging port flap.

Vehicle ready

READY illuminates green. The vehicle is ready to be driven.

Reduced engine power

 illuminates yellow.

The charging level of the high voltage battery is low. Only reduced engine power is available.

Autostop

 illuminates or flashes green.

Illuminates green

Engine is in an Autostop.

Flashes green

Autostop is temporarily unavailable, or Autostop mode is invoked automatically.

Stop-start system ⇨ 163.

Exterior light

 illuminates green.

The exterior lights are on ⇨ 135.

Low beam

 illuminates green.

Illuminated when low beam is on.

High beam

 illuminates blue.

Illuminates when high beam is on or during headlight flash ⇨ 136.

High beam assist

 illuminates green.

The high beam assist is activated ⇨ 136.

LED headlights

 illuminates and a warning message is displayed in the Driver Information Centre.

Seek the assistance of a workshop.

Front fog lights

 illuminates green.

The front fog lights are on ⇨ 139.

Rear fog light

 illuminates yellow.

The rear fog light is on ⇨ 139.

Rain sensor

 illuminates green.

Illuminated when rain sensor position on wiper lever is selected.

Cruise control

 illuminates in the Driver Information Centre when speed limiter is active. Set speed is indicated in the Driver Information Centre.

Cruise control ⇨ 186.

Semi-adaptive cruise control

 illuminates in the Driver Information Centre when semi-adaptive cruise control is active.

Semi-adaptive cruise control ⇨ 193.

Pedestrian safety alert fault

 illuminates yellow.

The pedestrian safety alert is not working.

Side blind spot alert

 illuminates green.

The system is active ⇨ 207.

Active emergency braking

 illuminates or flashes yellow.

Illuminates

The system has been deactivated or a fault has been detected.

Additionally, a warning message is displayed in the Driver Information Centre.

Check the reason of the deactivation ⇨ 201 and in case of a system fault, seek the assistance of a workshop.

Flashes

The system is actively engaged.



Depending on the situation, the vehicle may automatically brake moderately or hard.

Forward collision alert ⇨ 199.

Front pedestrian protection ⇨ 203.

Active emergency braking ⇨ 201.

Speed limiter

 illuminates in the Driver Information Centre when speed limiter is active. Set speed is indicated alongside  symbol.

Speed limiter ⇨ 189.

Door open

 illuminates red.

A door, the tailgate or the tailgate window is open.

If the vehicle is equipped with hinged doors,  is not illuminated when it is open.

Displays

Driver Information Centre

The Driver Information Centre is located in the instrument cluster.

Driver Information Centre indicates:

- overall and trip odometer
- digital speed indication
- trip / fuel information menu
- gear shift indication
- service information
- vehicle and warning messages
- driver assistance messages
- pop-up messages

Selecting menus and functions

There are several ways to toggle between the respective menus and functions:



Press button.

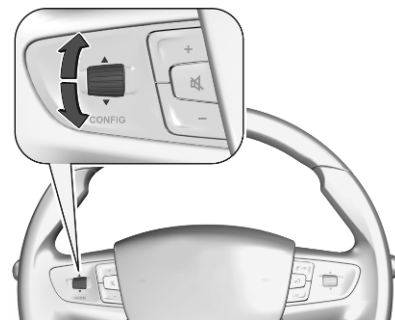

Move thumb wheel upwards or downwards on the steering wheel.

Baselevel instrument cluster

Press  SET.

Midlevel instrument cluster

Press SET 000.

Uplevel instrument cluster

Press 000.

Cluster electric vehicle

Press 000.

Vehicle and service messages are popped up in the Driver Information Centre, if required. Scroll messages by using the above mentioned controls or buttons.

Vehicle messages ⇨ 126.

Trip / fuel information menu, baselevel display



Different pages with combined information can be selected.

Select the required page:

Trip pages:

Trip odometer

The recorded distance since the reset.

To reset, press  SET for a few seconds.

Average fuel consumption

Display of average consumption. The measurement can be reset at any time and starts with a default value.

To reset, press  SET for a few seconds.

Average speed

Display of average speed. The measurement can be reset at any time.



To reset, press  SET for a few seconds.

Information pages:

Fuel range

Range is calculated from current fuel level and current consumption. The display shows average values.

After refuelling, the range is updated automatically after a brief delay.

When the fuel level is low, a message appears on the display and the control indicator  in the fuel gauge illuminates  116.

Instantaneous fuel consumption

Display of the instantaneous consumption.

Digital speed

Digital display of the instantaneous speed.

Stop and Start time counter

A time counter adds up the time spent in Autostop during a journey.

It resets to zero everytime the ignition is switched on.

Compass

Displays the geographic direction of driving.

AdBlue range

Press  SET repeatedly until the AdBlue menu is shown.

Indicates an estimate of the AdBlue level. A message indicates whether the level is sufficient or low.

AdBlue  168.

Trip / fuel information menu, midlevel display



Different pages with combined information can be selected.

Select the required page:

Trip pages: Trip odometer

The recorded distance since the reset.

To reset, press **SET 000** for a few seconds.

Average fuel consumption

Display of average consumption. The measurement can be reset at any time and starts with a default value.

To reset, press **SET 000** for a few seconds.

Average speed

Display of average speed. The measurement can be reset at any time.

To reset, press **SET 000** for a few seconds.

Information pages:

Fuel range

Range is calculated from current fuel level and current consumption. The display shows average values.

After refuelling, the range is updated automatically after a brief delay.

When the fuel level is low, a message appears on the display and the control indicator ● in the fuel gauge illuminates ⇨ 116.

Instantaneous fuel consumption

Display of the instantaneous consumption.

Digital speed

Digital display of the instantaneous speed.

Stop and Start time counter

A time counter adds up the time spent in Autostop during a journey.

It resets to zero everytime the ignition is switched on.

Compass

Displays the geographic direction of driving.

AdBlue range

Press **SET 000** repeatedly until the AdBlue menu is shown.

Indicates an estimate of the AdBlue level. A message indicates whether the level is sufficient or low.

AdBlue ⇨ 168.

AdBlue range

Press **CHECK** repeatedly until the AdBlue menu is shown.

AdBlue range

Indicates an estimate of the AdBlue level. A message indicates whether the level is sufficient or low.

Trip / fuel information menu, uplevel display



Different pages with combined information can be selected.

Select the required page:

Trip pages: Trip odometer

The recorded distance since the reset.

To reset, press **000** for a few seconds.

Average fuel consumption

Display of average consumption. The measurement can be reset at any time and starts with a default value.

To reset, press **000** for a few seconds.

Average speed

Display of average speed. The measurement can be reset at any time.

To reset, press **000** for a few seconds.

Information pages:

Fuel range

Range is calculated from current fuel level and current consumption. The display shows average values.

After refuelling, the range is updated automatically after a brief delay.

When the fuel level is low, a message appears on the display and the control indicator ● in the fuel gauge illuminates ⇨ 116.

Instantaneous fuel consumption

Display of the instantaneous consumption.

Digital speed

Digital display of the instantaneous speed.

Stop and Start time counter

A time counter adds up the time spent in Autostop during a journey.

It resets to zero everytime the ignition is switched on.

Compass

Displays the geographic direction of driving.

AdBlue range

Press **000** repeatedly until the AdBlue menu is shown.

Indicates an estimate of the AdBlue level. A message indicates whether the level is sufficient or low.

AdBlue ⇨ 168.

Trip / autonomy information menu, display electric vehicle

Different pages with combined information can be selected.

Select the required page:

Information page:

Average consumption of electric energy

Display of average consumption. The measurement can be reset at any time and starts with a default value.

To reset, press **000** for a few seconds.

Trip pages:**Average speed**

Display of average speed. The measurement can be reset at any time.

To reset, press **000** for a few seconds.

Average consumption of electric energy

Display of average consumption. The measurement can be reset at any time and starts with a default value.

To reset, press **000** for a few seconds.

Trip odometer

The recorded distance since the reset.

To reset, press **000** for a few seconds.

Traffic sign assistant page

Displays recognised traffic signs.

Flow page

Displays the current energy flow within the electric system.

Compass page

Displays the geographic direction of driving.

Digital speed page

Digital display of the instantaneous speed.

Info Display

The Info Display is located in the instrument panel near the instrument cluster.

The Info Display can indicate:

- time ↻ 98
- outside temperature ↻ 98
- date ↻ 98
- Infotainment system, see description in the Infotainment Manual
- indication of rear view camera ↻ 212
- indication of panoramic view system ↻ 209
- navigation, see description in the Infotainment Manual
- vehicle and system messages ↻ 126
- settings for vehicle personalisation ↻ 127

Radio (Infotainment system)

Press  to switch on the display.

Press **MENU** to select main menu page.

Press  to select a menu page.

Press **OK** to confirm a selection.

Press  to exit a menu without changing a setting.

Multimedia / Multimedia Navi

Selecting menus and settings

There are three options to operate the display:

- via buttons next to the display
- by touching the touchscreen with the finger
- via speech recognition

Button and touch operation





Press  to switch on the display.

Press  to select system settings (units, language, time and date).

Press  to select vehicle settings or driving functions.

Touch required menu display icon or a function with the finger.

Confirm a required function or selection by touching.

Touch  or  on the display to exit a menu without changing a setting.

For further information, see Infotainment Manual.

Speech recognition

Description see Infotainment Manual.

Flow

This menu displays the current energy flow within the electric system.



1. Press .
2. Select **Flow**.

Different colours show the energy flow.

- green: electric engine operating
- blue: regenerating energy

Average consumption

This menu displays the average power consumption during the current trip.

- green: electric energy consumed
- blue: electric energy generated from the braking and deceleration phases of the vehicle used to recharge the high voltage battery

The current trip is subdivided into time steps. For each time step, the average consumption is displayed. The time steps can be modified.



1. Press .
2. Select **Statistics**.
3. Press + and - to modify the time steps.

Vehicle personalisation ⇨ 127.

Head-up display

The head-up display displays driver information concerning the instrument cluster onto a foldable projection plane on the driver's side.

The information appears as an image projected from a lense in the instrument panel onto the projection

plane directly ahead in driver's view. The image appears focused out toward the front of the vehicle.

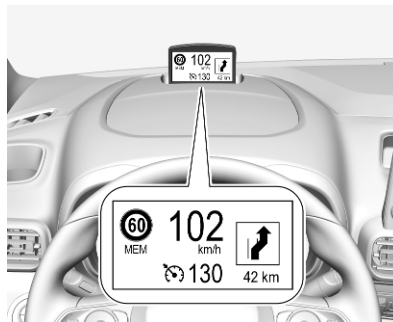

Head-up display shows:



- vehicle speed
- speed limits detected by the speed sign recognition
- set speed of speed limiter
- set speed of cruise control
- forward collision alert
- navigation information.



Switching on

Press  to switch on the head-up display.

Adjust position of head-up display image

Press  or  to centre the image. It can only be adjusted up and down, not side to side.

Warning

If the head-up display image is too bright or too high in your field of view, it may obstruct your view

when it is dark outside. Be sure to keep the head-up display image dim and placed low in your field of view.

Adjust brightness

The head-up display image will automatically dim and brighten to compensate for outside lighting. Brightness can also be adjusted manually as needed:

Press ☀ to brighten the display.

Press 🌙 to dim the display.

The image can temporarily light up depending on angle and position of sunlight.

Switching off

Press 🌙 and hold to turn the head-up display off.

Language

Preferred language can be set in vehicle personalisation menu ↗ 127.

Units

Units can be changed in vehicle personalisation menu ↗ 127.

Care of head-up display

Clean the screen of the head-up display with a soft cloth sprayed with glass cleaner. Wipe the lens gently, then dry it.

System limitations

Head-up display may not operate properly when:

- The lens in the instrument panel is covered by objects or not clean.
- Display brightness is too dim or bright.
- Image is not adjusted to the proper height.
- The driver wears polarized sunglasses.

If the head-up image is not correct for other reasons, contact a workshop.

Vehicle messages

Messages are indicated in the Driver Information Centre, in some cases together with a warning chime.



Press to confirm a message.

Vehicle and service messages

The vehicle messages are displayed as text. Follow the instructions given in the messages.

Messages in the Info Display

Some important messages may appear additionally in the Info Display. Some messages only pop-up for a few seconds.

Warning chimes

If several warnings appear at the same time, only one warning chime will sound.

When starting the engine or whilst driving

- If a seat belt is not fastened.
- If a door or the tailgate is not fully closed.
- If a certain speed is exceeded with parking brake applied.
- If a programmed speed or speed limit is exceeded.
- If a warning message appears in the Driver Information Centre.
- If the electronic key is not in the passenger compartment.
- If the parking assist detects an object.

- If an unintended lane change occurs.
- If the exhaust filter has reached the maximum filling level.

When the vehicle is parked and / or the driver's door is opened

- With exterior lights on.

During an Autostop

- If the driver's door is opened.
- If any condition for a restart of the engine is not fulfilled.

Vehicle personalisation

The vehicle's behaviour can be personalised by changing the settings in the Info Display.

Depending on vehicle equipment and country-specific regulations some of the functions described below may not be available.

Some functions are only displayed or active when the engine is running.

Radio (Infotainment system)



Press **MENU** to open the menu page. Use the arrow buttons to operate the display:

Select **Personalisation-configuration** ➔ OK.

Unit settings

Select **Display configuration** ➔ OK.

Select **Choice of units** ➔ OK.

Select desired settings ➔ OK.

Language settings

Select **Display configuration** ➔ OK.

Select **Choice of language** ➔ OK.

Select desired language ➔ OK.

Vehicle settings

Select **Define vehicle parameters** ➔ OK.

In the corresponding submenus the following settings can be changed:

- **Lamps**

- **Follow me home headlamps:**

- Activates or deactivates the function and adjusts its duration.

- **Welcome lighting:** Activates or deactivates the function and adjusts its duration.

- **Directional headlights:** Activates or deactivates the function.

- **Comfort**

- **Ambient lighting:** Adjusts the brightness of the ambient lighting.

- **Rear wiper in reverse gear:**

- Activates or deactivates automatic switching on of the rear window wiper when reverse gear is engaged.

- **Vehicle**

- **Unlocking boot only:** Activation / deactivation.

- **Plip action:** Driver / all doors.

- **Security**

- **Fatigue Detection system:**

- Activates or deactivates the driver drowsiness system.

- **Driving assistance**

- **Speed recommendation:**

- Activates or deactivates the function.

Multimedia



Press  to open settings menu.

Unit settings

Select **System configuration**.

Change units for **Distance and fuel consumption** and **Temperature**.

Language settings

Select **Language**.

Change language by touching the respective entry.

Driving function

Press .

Select **Driving function**.

In the corresponding submenus the following settings can be changed:

- **Parking sensors:** Activates or deactivates the parking assist sensors.
- **Blind spot sensors:** Activates or deactivates side blind spot alert.
- **Under-inflation initialization:** Initialises the tyre under-inflation detection system.
- **Diagnostic:** Shows alert messages of the diagnostic system.

Memorising of preset speeds

This feature enables to define and memorise up to six speed settings for cruise control and speed limiter. By default, a few speeds are already memorised.

- Press .
- Select **Adjusting speeds**.
- Select **Cruise control** or **Speed limiter**.
- Select the speed setting to be changed.

- Type the new speed value via the keypad and confirm with ✓ / OK.
- Confirm with ✓ / OK once more to exit the menu.

Vehicle settings

Press .

Select **Vehicle settings**.

In the corresponding submenus the following settings can be changed:

- **Parking**
 - Prevention of door mirror folding:** Activates or deactivates the automatic folding of the exterior mirrors.
 - Rear wiper in reverse:** Activates or deactivates automatic switching on of the rear window wiper when reverse gear is engaged.
- **Headlights**
 - Guide-me-home lighting:** Activates or deactivates the function and adjusts its duration.

Welcome lighting: Activates or deactivates the function and adjusts its duration.

Directional headlamps: Activates or deactivates the cornering lights.

- **Comfort**

Mood lighting: Adjusts the brightness of the ambient lighting.

- **Safety**

Speed reading/recommendation: Activates or deactivates the speed limit information by traffic sign recognition.

Active safety brake: Activates or deactivates active emergency braking, the alert distance for risk of collision can be selected.

Mirror adaptation in reverse: Adjusts the exterior mirrors if reverse gear is engaged to facilitate pavement visibility.

Driver's attention warning: Activates or deactivates the driver drowsiness system.

Multimedia Navi



Press  to open settings menu.

Unit settings

Select **System settings** in the options menu.

Change units for **Distance and fuel consumption** and **Temperature**.

Confirm with  / OK.

Language settings

Select **Languages**.

Change language by touching the respective entry.

Confirm with  / OK.

Driving functions

Press .

Select **Driving functions**.

In the corresponding submenus the following settings can be changed:

- **Automatic headlamp dipping:** Activates or deactivates high beam assist.
- **Lane departure warning system:** Activates or deactivates lane departure warning.
- **Stop and start:** Activates or deactivates stop-start system
- **Cruise control active:** Activates or deactivates semi-adaptive cruise control.
- **Parking sensors:** Activates or deactivates the parking assist sensors.
- **Blind spot sensors:** Activates or deactivates side blind spot alert.
- **Traction control:** Activates or deactivates Traction Control system.

- **Under-inflation initialization:** Initialises the tyre under-inflation detection system.
- **Diagnostic:** Shows alert messages of the diagnostic system.

Memorising of preset speeds

This feature enables to define and memorise up to six speed settings for cruise control and speed limiter. By default, a few speeds are already memorised.

- Press .
- Select **Adjusting speeds**.
- Select **Cruise control** or **Speed limiter**.



- Select the speed setting to be changed.
- Type the new speed value via the keypad and confirm with ✓ / OK.
- Confirm with ✓ / OK once more to exit the menu.

Vehicle settings

Press .

Select **Vehicle settings**.

In the corresponding submenus the following settings can be changed:

- **Parking**

Rear wiper in reverse: Activates or deactivates automatic switching on of the rear window wiper when reverse gear is engaged.

Blocking of door mirror folding: Activates or deactivates the automatic folding of the exterior mirrors.

- **Headlights**

Guide-me-home lighting: Activates or deactivates the function and adjusts its duration.

Welcome lighting: Activates or deactivates the function and adjusts its duration.

Directional headlamps: Activates or deactivates the cornering lights.

- **Vehicle access**

Hands-free auto locking: Activates or deactivates the function.

- **Comfort**

Mood lighting: Adjusts the brightness of the ambient lighting.

- **Safety**

Traffic Signs Recognition: Activates or deactivates the speed limit information by traffic sign recognition.

Active safety brake: Activates or deactivates active emergency braking, the alert distance for risk of collision can be selected.

Mirror adaptation in reverse: Adjusts the exterior mirrors if reverse gear is engaged to facilitate pavement visibility.

Driver's attention warning: Activates or deactivates the driver drowsiness system.

Telematics services

Vauxhall Connect

Vauxhall Connect comprises multiple connected services accessible via app, online or within the vehicle.

Notice

Full functionality of

Vauxhall Connect is subject to registration and proper activation.

Connected services may include live navigation such as online traffic information and vehicle status and information such as maintenance alerts.

Services accessible within the vehicle also include emergency call and breakdown call. These functions are automatically activated. Terms and conditions apply.

Emergency call function and breakdown call function are operated by the buttons in the overhead console.

Status LED in the overhead console

Illuminates green and red and extinguishes after a short time, when the ignition is switched on: the system works properly.

Illuminates red: fault in the system. Contact a workshop.

Flashes red: backup battery needs replacement. Contact a workshop.

Emergency call

The emergency call function will establish a connection to the nearest public safety answering point (PSAP). A minimum set of data including vehicle and location information will be sent to the PSAP.

Notice

Establishing an emergency call may not be possible in areas without sufficient network availability or due to hardware damage during an accident.

In case of an emergency, press the red **SOS** button for more than 2 seconds. The LED flashes green to

confirm that a connection to the nearest PSAP is being established. The LED illuminates steadily as long as the call is active.

Pressing the **SOS** button immediately a second time will terminate the call. The LED switches off.

Automatic crash notification

In case of an accident with airbag deployment, an automatic emergency call is established and an automatic crash notification will be transmitted to the next PSAP.

Breakdown call

Pressing the  button for more than 2 seconds connects you to a roadside assistance service provider.

For information about coverage and scope of services of the roadside assistance, please refer to the Service and warranty booklet.

Privacy settings

Privacy settings of Vauxhall Connect can be configured in your vehicle. This will impact the set of data being

sent, e.g., in case a breakdown call is triggered. The emergency call function will not be impacted.

Depending on version, the privacy settings can be changed by simultaneously pressing  and **SOS** in the overhead console or via the system settings menu in the Info Display.

ERA GLONASS

ERA GLONASS is a manually or automatically actuated emergency service. Emergency centres provide assistance and information during an emergency.

In case of an accident with an impact of appropriate severity, an emergency call is placed automatically, regardless of airbag activation. An immediate connection with an advisor will be established who will check whether help is needed.

Danger

The service is only available for markets where it is legally required and activated. Furthermore, the manual and the automatic emergency call function depend on the availability of the emergency centres and the infrastructure in the country.

Notice

In order to be available and operational, the system requires functioning vehicle electrics, mobile service and GLONASS satellite link. Depending on equipment, a backup battery is used.

Control buttons



SOS button

In an emergency situation press and hold SOS button for more than 2 seconds. The green LED and the voice message will confirm that the call has been sent to the emergency centre.

The green LED illuminates when the service connection is established. It will go out when the connection is complete.

A minimum set of data is transferred to the emergency centre, including such data as car location, car model, vehicle identification number. The operator will contact you and, if necessary, send rescue workers from the relevant support services.

To cancel the call, press the SOS button again. The green LED goes out. The voice message confirms the cancellation.

Status LED

The system provides feedback via voice messages and an LED.

Green : The system is activated. A connection to an operator is on duty.

Red : The system is booting up after switching on ignition, the LED goes out after 3 seconds. If the LED stays red, a malfunction has been detected in the system. An emergency call may not work. Contact a workshop immediately.

Red flashing : The internal backup battery is defective. Contact a workshop immediately.

Seek the assistance of a workshop if the LED does not illuminate after switching on the ignition.

Lighting

- Exterior lighting** 135
 - Light switch 135
 - Automatic light control 136
 - High beam 136
 - High beam assist 136
 - Headlight flash 137
 - Headlight range adjustment ... 137
 - Headlights when driving
 - abroad 138
 - Daytime running lights 138
 - Cornering lights 138
 - Hazard warning flashers 138
 - Turn lights 139
 - Front fog lights 139
 - Rear fog light 139
 - Reversing lights 140
 - Misted light covers 140
- Interior lighting** 140
 - Instrument panel illumination
 - control 140
 - Interior lights 140
 - Reading lights 141
 - Sunvisor lights 142
- Lighting features** 142
 - Centre console lighting 142

- Entry lighting 142
- Exit lighting 142
- Vehicle locator lighting 143
- Peripheral lighting 143
- Battery discharge protection ... 143



Exterior lighting

Light switch



Turn light switch:

AUTO : automatic light control
switches automatically
between daytime running
light and headlight

 : sidelights
 : headlight

When switching on the ignition,
automatic light control is active.

Control indicator    116.

Tail lights

Tail lights are illuminated together with low / high beam and sidelights.

Automatic light control



When the automatic light control function is switched on and the engine is running, the system switches between daytime running lights and headlights automatically depending on the external lighting conditions and information given by the wiper system.

Daytime running light ⇨ 138.

Automatic headlight activation

During poor lighting conditions the headlights are switched on.

Additionally, headlights are switched on if the windscreen wipers have been activated for several wipes.

High beam

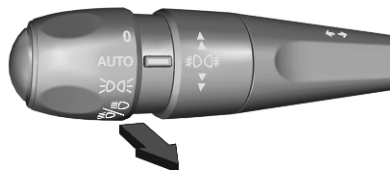

To activate the high beam, pull the lever beyond the resistance point.

High beam assist

The camera in the windscreen detects the lights of oncoming or preceding vehicles. Once activated,

high beam assist remains active and switches high beam on and off automatically. The latest setting of the high beam assist will remain after the ignition is switched on again.

This feature automatically activates the high beam at night when vehicle is faster than 15 mph.



It switches automatically back to low beam when:



- A sensor detects the lights of oncoming or preceding vehicles.
- Driving in urban areas.
- The vehicle is slower than 9 mph.
- It is foggy or snowy.
- Front or rear fog lights are switched on.

If there are no restrictions detected, the system switches back to high beam.

Activation





Depending on version the high beam assist can be activated by pressing  once or in the vehicle personalisation  127.

The green control indicator  illuminates continuously when the assist is activated, the blue one  illuminates when high beam is on.

Control indicator   116.

Deactivation

Depending on version the high beam assist can be deactivated by pressing  once or in the vehicle personalisation  127.

With high beam on, pull the indicator lever once to deactivate high beam assist.

Headlight flash



To activate the headlight flash, pull lever.

Pulling lever deactivates high beam.

Headlight range adjustment

Manual headlight range adjustment



To adapt headlight range to the vehicle load to prevent dazzling: turn thumb wheel  to required position.

- 0 : front seats occupied
- 1 : up to five people or partial load
- 2 : all seats occupied or driver and intermediate load
- 3 : driver and permissible max. load

Headlights when driving abroad

When driving in countries where traffic drives on the opposite side of the road, the headlights must be adjusted to avoid dazzling oncoming drivers.

Contact your dealer or a qualified workshop.

Daytime running lights

Daytime running lights increase visibility of the vehicle during daylight.

They are switched on automatically when the engine is running or by adjusting **0** or **AUTO**.

The system switches between daytime running lights and low beam automatically, depending on the lighting conditions.

Cornering lights



Activated at a speed of up to 25 mph when turning off. Depending on the steering angle or the activation of the turn lights the front fog light illuminate the direction of travel.

This function can be activated or deactivated in the vehicle personalisation ↻ 127.

Hazard warning flashers



Operated by pressing .

Hazard warning flashers are switched on automatically in the following situations:

- Braking in an emergency (depending on the force of deceleration).
- In the event of an accident.

They are switched off the first time you accelerate or if you press .

Turn lights

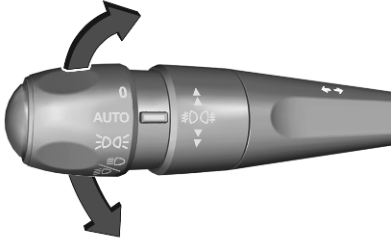

up : right turn lights
down : left turn lights

A resistance point can be felt when moving the indicator lever.

Constant flashing is activated when the indicator lever is being moved beyond the resistance point. It is deactivated when the steering wheel is moved in the opposite direction or indicator lever is manually moved back to its neutral position.

To activate three flashes, tap the indicator lever briefly without passing the resistance point.

Front fog lights



Turn the control wheel once to activate or deactivate the front fog light.

Light switch in position **AUTO**: switching on front fog lights will switch headlights on automatically.

Rear fog light



Turn the control wheel once to activate or deactivate the rear fog light.



Turn the control wheel twice to activate or deactivate the rear fog light.

Light switch in position **AUTO**: switching on rear fog light will switch headlights on automatically.

Reversing lights

The reversing light comes on when the ignition is on and reverse gear is selected.

Misted light covers

The inside of the light housing may mist up briefly in poor, wet and cold weather conditions, in heavy rain or after washing. The mist disappears quickly by itself. To help, switch on the headlights.

Interior lighting

Instrument panel illumination control



Brightness can be adjusted when the exterior lights are on.

Depending on version the brightness can be set by pressing and holding $-$ or $+$ until the desired brightness is obtained or in the vehicle personalisation \rightarrow 127.

Interior lights

During entry and exit of the vehicle, the front and rear courtesy lights automatically switch on and then off after a delay.

Front and rear courtesy light



Operate rocker switch:



-  : automatic switching on and off
- press  : on
- press  : off



Illustration shows rear courtesy light.

Load compartment lighting

The lower load compartment lights come on when the load compartment is opened.



One of the load compartment lights can also be used as a torch. Pull the torch out from the top of the recess.

Reading lights

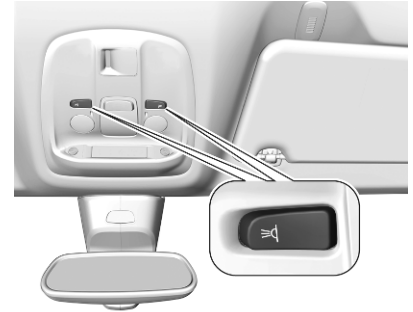



Operated by pressing  and  in the courtesy lights.



Illustration shows rear courtesy lights.

Sunvisor lights

Illuminates when the cover is opened.

Lighting features

Centre console lighting

A spotlight integrated in the overhead console illuminates the centre console when headlights are switched off.

The brightness can be adjusted in the vehicle personalisation ↻ 127.

Entry lighting

Welcome lighting

Some or all of the following lights are switched on for a short time by unlocking the vehicle with the radio remote control:

- headlights
- tail lights
- interior lights

The number of activated lights depends on the surrounding light conditions.

The lighting switches off immediately when the ignition is switched on.

Starting off ↻ 18.

This function can be activated or deactivated in the vehicle personalisation ↻ 127.

The following lights will additionally switch on when the driver's door is opened:

- illumination of some switches
- Driver Information Centre

Exit lighting

The following lights are switched on if the key is removed from the ignition switch:

- interior lights
- instrument panel light

They will switch off automatically after a delay. This function works only in the dark.

Path lighting

Headlights, tail lights and number plate lights illuminate the surrounding area for an adjustable time after leaving the vehicle.

Manual path lighting



To switch on the manual path lighting, switch off the ignition, open the driver's door and pull the indicator lever.

If the driver's door is not closed, the lights switch off after several seconds.

To switch off the manual path lighting pull the lever again while the driver's door is open.

The duration of the path lighting can be set in the vehicle personalisation ↻ 127.

Info Display ↻ 123.

Automatic path lighting

Path lighting is activated, when the ignition is switched off and the driver's door is opened.

This function can be activated or deactivated in the vehicle personalisation ↻ 127.

Info Display ↻ 123.

Vehicle locator lighting

This function allows to locate the vehicle, e.g., in weak lighting conditions using the remote control. The headlights come on and the turn lights flash for 10 seconds.

Press Ⓜ on the remote control.

The vehicle must be locked more than 5 seconds.

Peripheral lighting

Peripheral lighting allows you to switch on the position lights, low beam and number plate lighting using the remote control.

Press Ⓜ on the remote control to switch on peripheral lighting.

Press Ⓜ a second time to switch off peripheral lighting.

Battery discharge protection

To prevent discharge of the vehicle battery when the ignition is switched off, some interior lights are switched off automatically after some time.

Climate control

Climate control systems	144
Heating and ventilation system	144
Air conditioning system	146
Electronic climate control system	148
Parking heater	152
Temperature preconditioning ..	153
Air vents	155
Adjustable air vents	155
Fixed air vents	156
Glovebox cooler	156
Maintenance	157
Air intake	157
Air conditioning regular operation	157
Service	157

Climate control systems

Heating and ventilation system

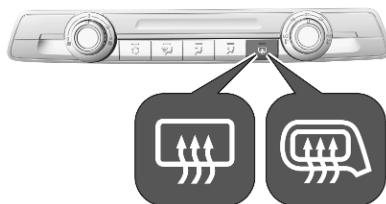

Controls for:

- temperature
- air distribution and
- fan speed
- air recirculation
- heated rear window or heated exterior mirrors

Heated rear window ↗ 43.

Heated exterior mirrors ↗ 39.

Heated seats ↗ 51.

Temperature

Adjust the temperature by turning to the desired temperature.

HI : warm

LO : cold

Heating will not be fully effective until the engine has reached normal operating temperature.

Air distribution

: to windscreen and front door windows

: to head area via adjustable air vents

: to foot well and windscreen

All combinations are possible.

Fan speed





Adjust the air flow by turning  to the desired speed.

clockwise : increase
 anticlockwise : decrease

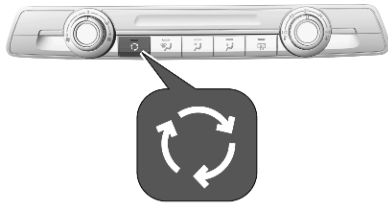
Air recirculation system



Press  to activate air recirculation mode. The LED in the button illuminates to indicate activation.

Press  again to deactivate air recirculation mode.





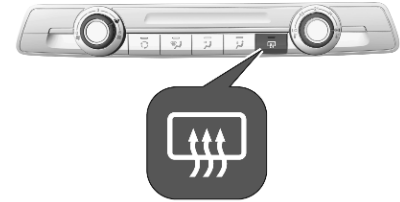

Warning

The exchange of fresh air is reduced in air recirculation mode. In operation without cooling the air humidity increases, so the windows may mist up from inside. The quality of the passenger compartment air deteriorates, which may cause the vehicle occupants to feel drowsy.

In warm and very humid ambient air conditions, the windscreen may mist up from outside when cold air is directed towards it. If windscreen mists up from outside, activate windscreen wiper and deactivate .

Demisting and defrosting



- Press : the air distribution is directed towards the windscreen.
- Set temperature controller  to warmest level.
- Set fan speed  to highest level.
- Switch on heated rear window and exterior mirrors  or switch on heated exterior mirrors .
- Switch on heated windscreen .
- Open side air vents as required and direct them towards the door windows.

Heated rear window  ↗ 43.







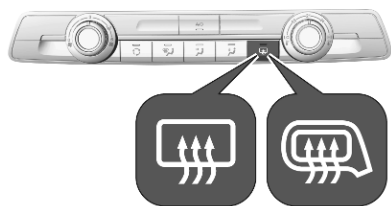

Heated exterior mirrors  ↗ 39.

Heated windscreen  ↗ 44.

Air conditioning system



Controls for:

- temperature 
- air distribution   and 
- fan speed 
- cooling **A/C**
- air recirculation 
- heated rear window  or heated exterior mirrors 

Heated rear window  ↗ 43.

Heated exterior mirrors  ↗ 39.

Temperature

Adjust the temperature by turning  to the desired temperature.

HI : warm

LO : cold

Heating will not be fully effective until the engine has reached normal operating temperature.

Air distribution

 : to windscreen and front door windows

 : to head area via adjustable air vents

 : to foot well

All combinations are possible.

Fan speed

Adjust the air flow by turning  to the desired speed.

clockwise : increase

anticlockwise : decrease

Cooling A/C

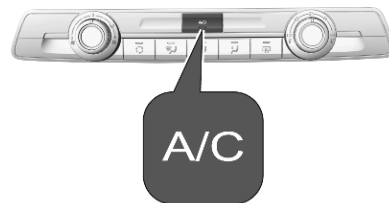

Press **A/C** to switch on cooling. The LED in the button illuminates to indicate activation. Cooling is only functional when the engine is running and fan is switched on.

Press **A/C** again to switch off cooling.

The air conditioning system cools and dehumidifies (dries) as soon as the outside temperature is slightly above the freezing point. Therefore, condensation may form and drip from under the vehicle.

If no cooling or drying is required, switch off the cooling system for fuel saving reasons.

Activated cooling may inhibit Autostops. Stop-start system ↗ 163.

Air recirculation system ↻

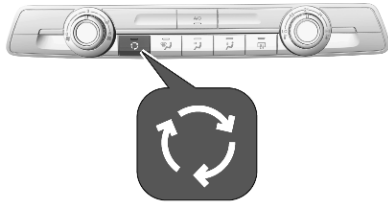

Press ↻ to activate air recirculation mode. The LED in the button illuminates to indicate activation.

Press ↻ again to deactivate air recirculation mode.

⚠ Warning

The exchange of fresh air is reduced in air recirculation mode. In operation without cooling the air humidity increases, so the

windows may mist up from inside. The quality of the passenger compartment air deteriorates, which may cause the vehicle occupants to feel drowsy.

In warm and very humid ambient air conditions, the windscreen may mist up from outside when cold air is directed towards it. If windscreen mists up from outside, activate windscreen wiper and deactivate 🚿.

Maximum cooling

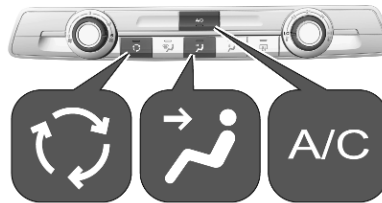



Briefly open the windows so that hot air can disperse quickly.

- Switch on cooling **A/C**.
- Press ↻ for air recirculation system on.
- Press 🌀 for air distribution.
- Set temperature control 🌡 to coldest level.
- Set fan speed 🌀 to highest level.
- Open all vents.

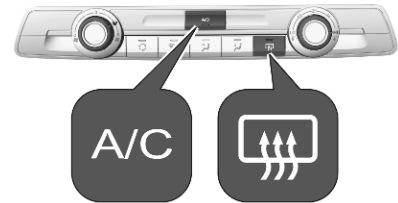
Demisting and defrosting the windows



- Set fan speed 🌀 to highest level.
- Set temperature controller 🌡 to warmest level.

- Switch on cooling **A/C**, if required.
- Switch on heated rear window  or heated exterior mirrors .
- Switch on heated windscreen .
- Open side air vents as required and direct them towards the door windows.

Notice

If the settings for demisting and defrosting are selected, an Autostop may be inhibited.

If the settings for demisting and defrosting are selected while the engine is in an Autostop, the engine will restart automatically. Stop-start system ↗ 163.

Heated rear window  ↗ 43.

Heated exterior mirrors  ↗ 39.

Heated windscreen  ↗ 44.

Stop-start system ↗ 163.



Electronic climate control system

The dual zone climate control allows different temperatures for driver side and front passenger side.

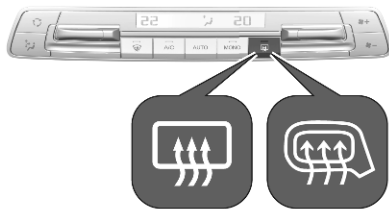



In automatic mode, temperature, fan speed and air distribution are regulated automatically.



Controls for:

- manual air recirculation 
- air distribution 
- rocker switch for adjusting the temperature on driver side and front passenger side



- demisting and defrosting 
- cooling **A/C**
- automatic mode **AUTO**
- dual zone temperature synchronisation **MONO**
- heated rear window  or heated exterior mirrors 
- fan speed  +  -

Heated rear window  ↗ 43.

Heated exterior mirrors  ↗ 39.

Activated functions are indicated by the LED in the respective control.

The electronic climate control system is only fully operational when the engine is running.

Automatic mode AUTO

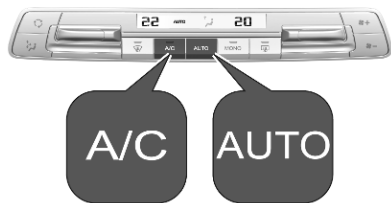

Basic setting for maximum comfort:

- Press **AUTO**, the air distribution and fan speed are regulated automatically.
- Open all air vents to allow optimised air distribution in automatic mode.

- Air conditioning must be activated for optimal cooling and demisting. Press **A/C** to switch on air conditioning. The LED in the button indicates activation.
- Set the preselected temperatures for driver and front passenger using the left and right rotary ring. Recommended temperature is 22 °C.

Press successively **AUTO** to select the desired automatic settings:

- **Soft Auto** for a soft and silent air distribution.
- **Auto** for thermal comfort and silent air distribution.
- **Auto Fast** for a dynamic and efficient air distribution.

Manual settings

Climate control system settings can be changed by activating the following functions:

Fan speed 🌀+🌀-

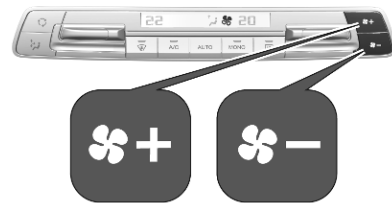



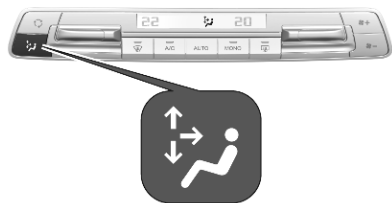

Press 🌀+ to increase or 🌀- to decrease the air flow.

To return to automatic mode, press **AUTO**.

Air distribution



Press  successively until the desired direction of the air distribution is displayed:

-  : to windscreen and front door windows
-  : to head area and rear seats via adjustable air vents
-  : to front and rear foot well
-  : to windscreen and front door windows, to head area and rear seats via adjustable air vents, to front and rear foot well

Combinations of different air distribution options can be select by pressing  successively.

To return to automatic air distribution, press **AUTO**.

Temperature preselection



Set the preselected temperatures separately for the driver and the front passenger to the desired value using the left and right switch for adjusting the temperature.

Recommended temperature is 22 °C. Temperature is indicated in the display beside the switches for adjusting the temperature.

If the minimum temperature **Lo** is set, the climate control system runs at maximum cooling, if cooling **A/C** is switched on.

If the maximum temperature **Hi** is set, the climate control system runs at maximum heating.

Notice

If **A/C** is switched on, reducing the set cabin temperature can cause the engine to restart from an Autostop or inhibit an Autostop.

Stop-start system  163.

Dual zone temperature synchronisation **MONO**

Press **MONO** to link passenger side temperature setting to the driver side / to remove the linking of the passenger side temperature setting to the driver side. The passenger side temperature setting is linked to the driver side if the LED in the button **MONO** is not illuminated.

Air conditioning A/C

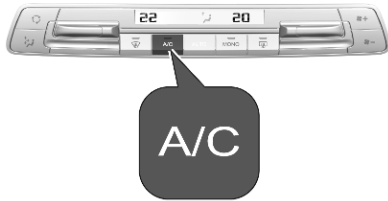

Press **A/C** to switch on cooling. Cooling is only functional when the engine is running and climate control fan is switched on.



Press **A/C** again to switch off cooling.

The air conditioning system cools and dehumidifies (dries) when outside temperature is above a specific level. Therefore condensation may form and drip from under the vehicle.

If no cooling or drying is required, switch off the cooling system for fuel saving reasons.

Manual air recirculation



Press  to activate the air recirculation mode.  is shown in the display to indicate activation.

Press  again to deactivate recirculation mode.

Warning

The exchange of fresh air is reduced in air recirculation mode. In operation without cooling, the air humidity increases, so the windows may mist up from inside. The quality of the passenger



compartment air deteriorates, which may cause the occupants to feel drowsy.

In warm and very humid ambient air conditions, the windscreen may mist up from outside, when cold air is directed towards it. If windscreen mists up from outside, activate windscreen wiper and deactivate .

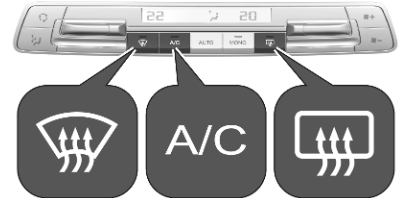

Demisting and defrosting the windows



- Press . The LED in the button illuminates to indicate activation.

- Air conditioning and automatic mode are automatically switched on. The LED in the button **A/C** illuminates, **AUTO** is shown in the display.
- Temperature and air distribution are set automatically and the fan runs at high speed.
- Switch on heated rear window .
- Switch on heated windscreen .
- To return to previous mode, press  again.

Notice

If  is pressed while the engine is running, an Autostop will be inhibited until  is pressed again.

If  is pressed while the engine is in an Autostop, the engine will restart automatically.

Heated rear window  ⇨ 43.

Heated exterior mirrors  ⇨ 39.

Heated windscreen  ⇨ 44.

Stop-start system ⇨ 163.

Deactivation of electronic climate control system

Press  – subsequently until the electronic climate control system is deactivated.

Parking heater

The parking heater allows to heat the vehicle's interior and to ventilate the vehicle's interior with ambient air.



The operating status of the parking heater is shown by an indicator with an LED.

- LED illuminates: A timer has been set.
- LED flashes: The system is operating.

The LED is extinguished at the end of the heating operation or when the parking heater is stopped using the remote control.

The parking heater can be programmed using the Infotainment system. Additionally, the parking heater can be switched on and off using a remote control.

Radio (Infotainment system)

Press **MENU** to open the menu page.

Press **Heating** or **Ventilation**.

Press **<<** or **>>** to select the desired timer. Confirm with **OK**.

Set the required time of the timer: Press **△** or **▽** to set the desired value. Confirm with **OK**.

To set the timer, press **<<** or **>>** to select **OK** on the display. Confirm with **OK**.

Multimedia / Multimedia Navi

Press .

Press **Temperature conditioning**.

Activate **Temperature conditioning** by pressing **ON**.

Press **Settings**.

Select **Heating** or **Ventilation**.

Press **Time 1** or **Time 2** to select the desired timer.

Define the time of the selected timer.

Press  to save the settings and set the timer.

Parking heater via remote control

The parking heater can be switched on using a remote control.



Press .

Replacing the battery in the remote control

If the indicator light of the remote control turns yellow, the charging status of the battery is weak. If the indicator light does not illuminate anymore, the battery is discharged and has to be replaced.

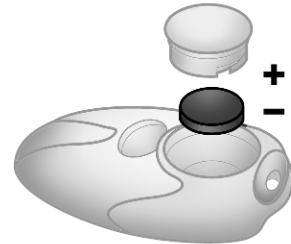

1. Remove the cap of the remote control by unscrewing it with a coin and remove the battery
2. Replace battery with a battery of the same type. Pay attention to the installation position.
3. Screw the cap in its place .

Temperature preconditioning

The temperature preconditioning allows to heat the vehicle's interior and to ventilate the vehicle's interior with ambient air.



The temperature preconditioning can be programmed using the Infotainment system.

This function is also available via the MyVauxhall App.

The operating status of the temperature preconditioning is shown by an indicator with an LED.

- LED illuminates: A timer has been set.
- LED flashes: The system is operating.

The LED is extinguished at the end of the heating /ventilation operation or when the temperature preconditioning is stopped using the remote control.

Operating conditions

The temperature preconditioning can be activated both when the vehicle is charged and when is not charged. When the vehicle is not charged, the function is only activated if the charging level of the high voltage battery is above 50 percent.

The temperature preconditioning is only activated when the ignition is off and the vehicle is locked.

Programming via Infotainment system

The temperature preconditioning can be programmed using the Infotainment system. Two timers can be defined. A timer defines the time at which the vehicle's interior is to be heated / ventilated to a factory-set temperature.

Restrictions:

- Only one timer can be activated.
- If two timers are defined and the activated timer is cancelled, the inactive timer is not activated automatically. The timer has to be activated manually.
- If only one timer is defined and activated and the vehicle is not started, the timer will be cancelled for the following day. The timer has to be activated again.

Radio (Infotainment system)

Press **MENU** to open the menu page.

Press **Heating** or **Ventilation**.

Press **<<** or **>>** to select the desired timer. Confirm with **OK**.

Set the required time of the timer: Press **Δ** or **∇** to set the desired value. Confirm with **OK**.

To set the timer, press **<<** or **>>** to select **OK** on the display. Confirm with **OK**.

Multimedia / Multimedia Navi

Press **☐☐**.

Press **Temperature conditioning**.

Activate **Temperature conditioning** by pressing **ON**.

Press **Settings**.

Select **Heating** or **Ventilation**.

Press **Time 1** or **Time 2** to select the desired timer.

Define the time of the selected timer.

Press  to save the settings and set the timer.

Air vents

Adjustable air vents

Air vents in the instrument panel

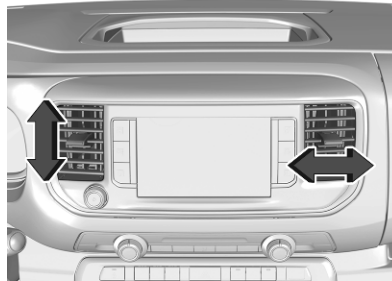

Direct the flow of air by tilting and swivelling the slats.

To close the vent, swivel the slats inwards.

Outer air vents in the instrument panel

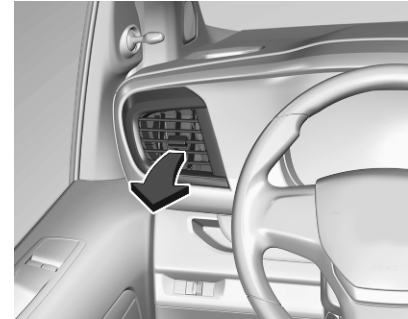

Direct the flow of air by tilting and swivelling the slats.

To close the vent, swivel the slats outwards.

At least two air vents must be open while cooling is on.

Warning

Do not attach any objects to the slats of the air vents. Risk of damage and injury in case of an accident.

Rear air vents in the ceiling

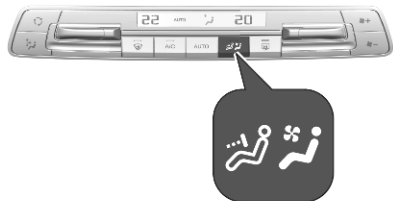

To activate the distribution of climatized / heated air via the rear air vents, press .

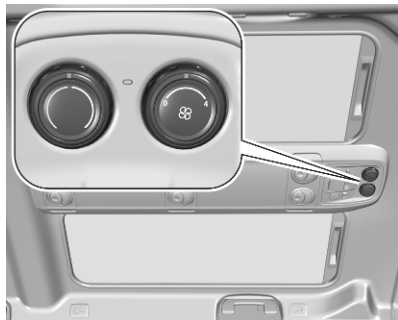

Direct the flow of air by tilting and swivelling the slats.

Adjust the air flow to select the desired speed.

Fixed air vents

Additional air vents are located beneath the windscreen, the door windows and in the foot wells.

Glovebox cooler

The air conditioning system draws cooled air into the glovebox through a nozzle.

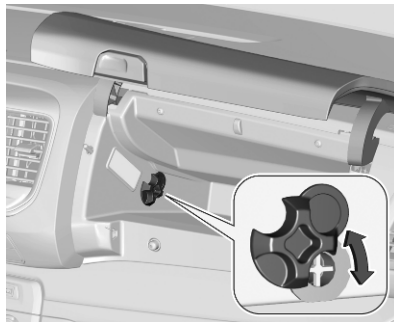

Turn the slider up or down in order to enable or disable glovebox cooling.

Maintenance

Air intake

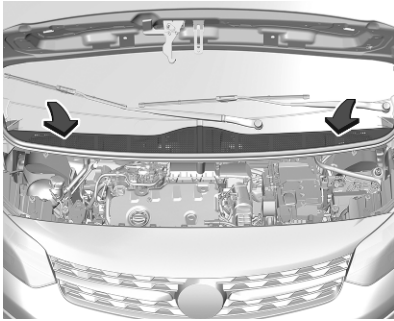

The air intake in front of the windscreen in the engine compartment must be kept clear to allow air intake. Remove any leaves, dirt or snow.

Air conditioning regular operation

In order to ensure continuously efficient performance, cooling must be operated for a few minutes once a month, irrespective of the weather and time of year. Operation with cooling is not possible when the outside temperature is too low.

Service

For optimal cooling performance, it is recommended to annually check the climate control system, starting three years after initial vehicle registration, including:

- functionality and pressure test
- heating functionality
- leakage check
- check of drive belts
- cleaning of condenser and evaporator drainage
- performance check

Driving and operating

Driving hints	159	Manual transmission	177	Charging	216
Control of the vehicle	159	Drive systems	178	General information	216
Steering	159	Drive modes	178	Charging types	217
Starting and operating	159	Brakes	178	Charging cable	218
New vehicle running-in	159	Antilock brake system	178	Programmable charging	225
Ignition switch positions	159	Parking brake	179	Charging status	226
Power button	160	Brake assist	182	Fuel	227
Starting the engine	161	Hill start assist	182	Fuel for diesel engines	227
Overrun cut-off	163	Regenerative braking	182	Refuelling	228
Stop-start system	163	Ride control systems	183	Fuel consumption - CO ₂ -	
Parking	166	Electronic Stability Control and		Emissions	229
Engine exhaust	167	Traction Control system	183	Trailer hitch	230
Exhaust filter	167	Selective ride control	184	General information	230
Catalytic converter	167	Driver assistance systems	186	Driving characteristics and	
AdBlue	168	Cruise control	186	towing tips	230
Electric drive unit	171	Speed limiter	189	Trailer towing	230
Operation	171	Semi-adaptive cruise control ...	193	Towing equipment	231
Automatic transmission	174	Forward collision alert	199	Trailer stability assist	234
Transmission display	174	Active emergency braking	201		
Gear selection	174	Front pedestrian protection	203		
Manual mode	175	Parking assist	204		
Electronic driving programmes	176	Side blind spot alert	207		
Fault	176	Panoramic view system	209		
		Rear view camera	212		
		Traffic sign assistant	213		
		Lane departure warning	213		
		Driver alert	214		

Driving hints

Control of the vehicle

Never coast with engine not running

Many systems will not function in this situation (e.g. brake servo unit, power steering). Driving in this manner is a danger to yourself and others.

All systems function during an Autostop.

Stop-start system ⇨ 163.

Pedals

To ensure the pedal travel is uninhibited, there must be no mats in the area of the pedals.

Use only floor mats, which fit properly and are fixed by the retainers on the driver side.

Steering

If power steering assist is lost because the engine stops or due to a system malfunction, the vehicle can be steered but may require increased effort.

Starting and operating

New vehicle running-in

Do not brake unnecessarily hard for the first few journeys.

During the first drive, smoke may occur because of wax and oil evaporating off the exhaust system. Park the vehicle in the open for a while after the first drive and avoid inhaling the fumes.

During the running-in period, fuel and engine oil consumption may be higher.

Additionally, the cleaning process of the exhaust filter may take place more often.

Exhaust filter ⇨ 167.

Ignition switch positions

Turn key:

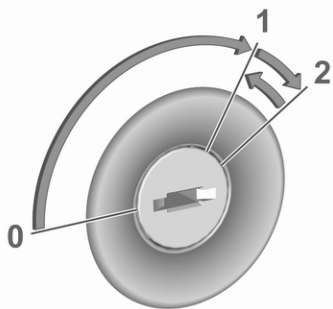

- 0 : ignition off: some functions remain active until key is removed or driver's door is opened, provided the ignition was on previously
- 1 : ignition on power mode: ignition is on, diesel engine is preheating, control indicators illuminate and most electrical functions are operable
- 2 : engine start: release key after engine has been started

Steering wheel lock

Remove key from ignition switch and turn steering wheel until it engages.

⚠ Danger

Never remove the key from ignition switch during driving as this will cause steering wheel lock.

Power button



The electronic key must be inside the vehicle.

Engine start

Operate the clutch pedal (manual transmission), the brake pedal and press **Start/Stop**.

Ignition on power mode without starting the engine

Press **Start/Stop** without operating clutch or brake pedal. Control indicators illuminate and most electrical functions are operable.

Engine and ignition off

Press **Start/Stop** briefly in each mode or when engine is running and vehicle is stationary. Some functions remain active until driver's door is opened, provided the ignition was on previously.

Emergency shut off during driving

Press **Start/Stop** for about 3 seconds ↻ 161. Steering wheel locks as soon as vehicle is stationary.

Steering wheel lock

The steering wheel lock activates automatically when:

- The vehicle is stationary.
- The ignition has been switched off.

To release steering wheel lock, open and close driver's door and switch the ignition on power mode or start the engine directly.

⚠ Warning

If the vehicle battery is discharged, the vehicle must not be towed, tow-started or jump-started as the steering wheel lock cannot be disengaged.

Operation on vehicles with electronic key system in case of failure

If either the electronic key fails or the battery of the electronic key is weak, a message may be displayed in the Driver Information Centre.



Hold the electronic key with buttons outside at the marking on the steering column cover as shown in the illustration.

Operate the clutch pedal (manual transmission), the brake pedal and press **Start/Stop**.

This option is intended for emergencies only. Replace the electronic key battery as soon as possible ⇨ 23.

For unlocking or locking the doors, see fault in radio remote control unit or electronic key system ⇨ 24.

Starting the engine

Vehicles with ignition switch

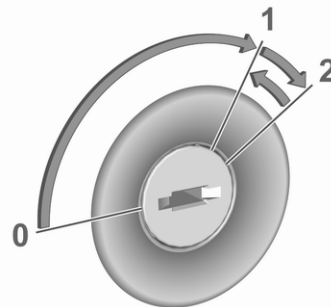

Turn key to position 1 to release the steering wheel lock.

Manual transmission: operate clutch and brake pedal.

Automatic transmission: operate brake pedal and move selector lever to **P** or **N**.

Do not operate accelerator pedal.

Diesel engines: wait until control indicator  extinguishes.

Turn key briefly to position 2 and release after engine has been started.

Manual transmission: during an Autostop, the engine can be started by depressing the clutch pedal ↻ 163.

Automatic transmission: during an Autostop, the engine can be started by releasing the brake pedal ↻ 163.

Vehicles with power button



- Manual transmission: operate clutch and brake pedal.
- Automatic transmission: operate brake pedal and move selector lever to **P** or **N**.
- Do not operate accelerator pedal.
- Press **Start/Stop** button.
- Release button after starting procedure begins. Diesel engine starts after control indicator  for preheating extinguishes.
- Before restarting or to switch off the engine when vehicle is stationary, press **Start/Stop** once more briefly.

To start the engine during an Autostop:

- Manual transmission: during an Autostop, the engine can be started by depressing the clutch pedal ↻ 163.
- Automatic transmission: during an Autostop, the engine can be started by releasing the brake pedal ↻ 163.

Emergency shut off during driving

If the engine needs to be switched off during driving in case of emergency, press **Start/Stop** for 5 seconds.

Danger

Switching off the engine during driving may cause loss of power support for brake and steering systems. Assistance systems and airbag systems are disabled. Lighting and brake lights will extinguish. Therefore power down the engine and ignition while driving only when required in case of emergency.

Starting the vehicle at low temperatures

Starting the engine without additional heaters is possible down to -25 °C for diesel engines and -30 °C for petrol engines. Required is an engine oil with the correct viscosity, the correct fuel, performed services and a sufficiently charged vehicle battery. With temperatures below -30 °C the automatic transmission requires a warming phase of approx. 5 minutes. The selector lever must be in position P.

Turbo engine warm-up

Upon start-up, engine available torque may be limited for a short time, especially when the engine temperature is cold. The limitation is to allow the lubrication system to fully protect the engine.

Overrun cut-off

The fuel supply is automatically cut off during overrun, i.e. when the vehicle is driven with a gear engaged but accelerator pedal is released.

Depending on driving conditions, the overrun cut-off may be deactivated.



Stop-start system

The stop-start system helps to save fuel and to reduce the exhaust emissions. When conditions allow, it switches off the engine as soon as the vehicle is at a low speed or at a standstill, e.g. at a traffic light or in a traffic jam.



Activation

The stop-start system is available as soon as the engine is started, the vehicle starts-off and the conditions as stated below in this section are fulfilled.

Without touchscreen

The system is ready to operate when the LED in the button  is not illuminated. To activate the system when the system is deactivated, press . If the stop-start system is temporarily not available and the button  is pressed, the LED in the button flashes.

With touchscreen

The system can be activated in the vehicle personalisation  127. If the stop-start system is temporarily not available, the control indicator  flashes for a few seconds.

Deactivation

Without touchscreen

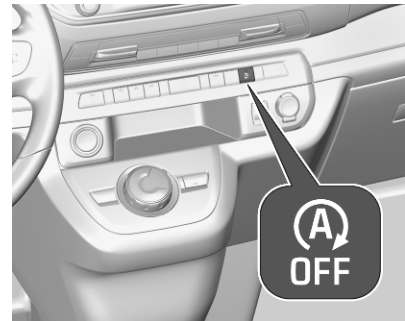

Press  to deactivate the stop-start system. The deactivation is indicated when the LED in the button illuminates.

With touchscreen

The stop-start system can be deactivated in the vehicle personalisation ↗ 127.

If the system is deactivated during an Autostop, the engine restarts immediately.

Autostop

Vehicles with manual transmission

An Autostop can be activated at a standstill or at speed below 12 mph.

Activate an Autostop as follows:

- Depress the clutch pedal.
- Set the selector lever to neutral.
- Release the clutch pedal.

The engine will be switched off while the ignition stays on.

Vehicles with automatic transmission

If the vehicle is at a standstill with depressed brake pedal or gear selector in **N**, Autostop is activated automatically.

In case of vehicles with automatic transmission of type B, an Autostop can also be activated at a speed below 12 mph.

The engine will be switched off while the ignition stays on.

Indication



An Autostop is indicated by control indicator **(A)**.

During an Autostop, the heating and brake performance will be maintained.

Conditions for an Autostop

The stop-start system checks if each of the following conditions is fulfilled.

- The stop-start system is not manually deactivated.
- The driver's door is closed or the driver's seat belt is fastened.
- The sliding doors are closed
- The vehicle battery is sufficiently charged and in good condition.
- The engine is warmed up.

- The ambient temperature is between 0 °C and 35 °C.
- The engine coolant temperature is not too high.
- The engine exhaust temperature is not too high, e.g. after driving with high engine load.
- The climate control system allows an Autostop.
- The brake vacuum is sufficient.
- The self-cleaning function of the exhaust filter is not active.
- The vehicle was driven at least at walking speed since the last Autostop.

Otherwise an Autostop will be inhibited.

Notice

The Autostop may be inhibited for several hours after a battery replacement or reconnection.

Certain settings of the climate control system may inhibit an Autostop.

Climate control ↗ 146.

Immediately after higher speed driving an Autostop may be inhibited.

New vehicle running-in ⇨ 159.

Vehicle battery discharge protection

To ensure reliable engine restarts, several vehicle battery discharge protection features are implemented as part of the stop-start system.

Power saving measures

During an Autostop, several electrical features such as auxiliary electric heater or rear window heating are disabled or switched to a power saving mode. The fan speed of the climate control system is reduced to save power.

Restart of the engine by the driver

Vehicles with manual transmission

Depress the clutch pedal without depressing the brake pedal to restart the engine.

Vehicles with automatic transmission

Type A: The engine is restarted if

- the gear selector is in position **D** with **M** activated or not and the brake pedal is released

- the gear selector is in position **N**, the brake pedal is released and the gear selector is moved to position **D** with **M** activated or not
- the gear selector is in position **P**, the brake pedal is depressed and the gear selector is moved to position **R**, **N** or **D** with **M** activated or not

- the reverse gear is engaged

Type B: The engine is restarted if

- the gear selector is in position **A** or **M** and the brake pedal is released
- the gear selector is in position **N**, the brake pedal is depressed and and the gear selector is moved to **A** or **M**
- the reverse gear is engaged

Restart of the engine by the stop-start system

The selector lever must be in neutral to enable an automatic restart.

If one of the following conditions occurs during an Autostop, the engine will be restarted automatically by the stop-start system:

- depending on engine, vehicle speed exceeding 0.6 mph or 15 mph (manual transmission)
- vehicle speed exceeding 0.6 mph (automatic transmission)
- stop-start system manually deactivated
- driver's door opened
- sliding door opened.
- driver's seat belt unfastened
- engine temperature too low
- charging level of vehicle battery below defined level
- brake vacuum not sufficient
- vehicle driven at least at walking speed
- climate control system requests engine start
- air conditioning manually switched on

If an electrical accessory, e.g. a portable CD player, is connected to the power outlet, a brief power drop during the restart might be noticeable.

Parking

⚠ Warning

- Do not park the vehicle on an easily ignitable surface. The high temperature of the exhaust system could ignite the surface.
- Apply the parking brake.
- If the vehicle is on a level surface or uphill slope, engage first gear or set the selector lever to position **P** (automatic transmission type A) / **N** (automatic transmission type B). On an uphill slope, turn the front wheels away from the kerb.
If the vehicle is on a downhill slope, engage reverse gear or set the selector lever to position **P** (automatic transmission type A) / **N** (automatic transmission type B). Turn the front wheels towards the kerb.
- Close the windows.

- Switch off the engine.
- Remove the ignition key from the ignition switch or switch off ignition on vehicles with power button. Turn the steering wheel until the steering wheel lock is felt to engage.

- Lock the vehicle.
- Activate the anti-theft alarm system.
- The engine cooling fans may run after the engine has been switched off ⇨ 238.

Caution

After running at high engine speeds or with high engine loads, operate the engine briefly at a low load or run in neutral for approx. 30 seconds before switching off, in order to protect the turbocharger.

Notice

In the event of an accident with airbag deployment, the engine is switched off automatically if the vehicle comes to a standstill within a certain time.

In countries with extremely low temperatures it may be necessary to park the vehicle without applied parking brake. Make sure to park the vehicle on a level surface.

Engine exhaust

Danger

Engine exhaust gases contain poisonous carbon monoxide, which is colourless and odourless and could be fatal if inhaled.



If exhaust gases enter the interior of the vehicle, open the windows. Have the cause of the fault rectified by a workshop.

Avoid driving with an open load compartment, otherwise exhaust gases could enter the vehicle.

Exhaust filter

Automatic cleaning process

The exhaust filter system filters soot particles out of the exhaust gases.



The start of saturation of the exhaust filter is indicated by the temporary illumination of  or , accompanied by a message in the Driver Information Centre and a chime.

As soon as the traffic conditions permit, regenerate the filter by driving at a vehicle speed of at least 40 mph until the control indicator extinguishes.

Notice

On a new vehicle, the first exhaust filter regeneration operations may be accompanied by a burning smell, which is normal. Following prolonged operation of the vehicle at very low speed or at idle, water vapour can be emitted at the exhaust on acceleration. This does not affect the behaviour of the vehicle or the environment.

Cleaning process not possible

If  or  stays on, accompanied by an audible signal and a message, this indicates that the exhaust filter additive level is too low.

The reservoir must be topped-up without delay. Seek the assistance of a workshop.

Catalytic converter

The catalytic converter reduces the amount of harmful substances in the exhaust gases.

Caution

Fuel grades other than those listed on page ⇨ 293 could damage the catalytic converter or electronic components.

Unburnt petrol will overheat and damage the catalytic converter. Therefore avoid excessive use of the starter, running the fuel tank dry and starting the engine by pushing or towing.

In the event of misfiring, uneven engine running, a reduction in engine performance or other unusual problems, have the cause of the fault rectified by a workshop as soon as possible. In an emergency, driving can be continued for a short period, keeping vehicle speed and engine speed low.

AdBlue

General information

The selective catalytic reduction (BlueInjection) is a method to substantially reduce the nitrogen oxides in the exhaust emission. This is achieved by injecting a Diesel Exhaust Fluid (DEF) into the exhaust system. The ammonia released by the fluid reacts with nitrous gases (NO_x) from the exhaust and turns it into nitrogen and water.

The designation of this fluid is AdBlue®. It is a non-toxic, non-flammable, colourless and odourless fluid which consists of 32% urea and 68% water.

Warning

Avoid contact of your eyes or skin with AdBlue.

In case of eye or skin contact, rinse off with water.

Caution

Avoid contact of the paintwork with AdBlue.

In case of contact, rinse off with water.

AdBlue freezes at a temperature of approx. -11 °C. As the vehicle is equipped with an AdBlue pre-heater, the emissions reduction at low temperatures is ensured. The AdBlue pre-heater works automatically.

Notice

Frozen and again liquefied AdBlue is usable without quality loss.

The typical AdBlue consumption is approx. 22 l per 6000 miles to 9000 miles depending on driving behaviour (e.g. high load or towing).

Level warnings

Depending on the calculated range of AdBlue, different messages are displayed in the Driver Information Centre. The messages and the restrictions are a legal requirement.

1. The first possible warning is **Top up emissions additive: Starting prevented in 1500 mi.**

When switching on the ignition, this warning will show up once briefly with the calculated range. Additionally, control indicator  will illuminate and a chime will sound. Driving is possible without any restrictions.

2. The next warning level is entered with a range below 500 miles. The message with the current range will always be displayed when ignition is switched on. Additionally, control indicator  will illuminate and a chime will sound. Refill AdBlue before entering the next warning level. When driving, the chime sounds and the message is displayed every 60 miles until the AdBlue tank has been topped-up.
3. The next warning level is entered with a range below 60 miles. The message with the current range will always be displayed when ignition is switched on. Additionally, control indicator

 will flash and a chime will sound. Refill AdBlue as soon as possible before the AdBlue tank is completely empty. Otherwise, a restart of the engine will not be possible.

When driving, the chime sounds and the message is displayed every 6 miles until the AdBlue tank has been topped-up.

4. The last warning level is entered when the AdBlue tank is empty. Restart of the engine is not possible. The following warning message will be displayed:

Top up emissions additive: Starting prevented

Additionally, control indicator  will flash and a chime will sound.

Refill the tank to a level of at least 5 l of AdBlue, otherwise restarting of the engine is not possible.



Notice

Depending on the engine different levels may apply.

High emission warnings

In the event of a fault with the emissions control system, different messages are displayed in the Driver Information Centre. The messages and the restrictions are a legal requirement.



1. If a fault is detected for the first time, the warning **Emissions fault** is displayed.

Additionally, control indicators ,  and  will illuminate and a chime will sound. Driving is possible without any restrictions.

If it is a temporary fault, the alert disappears during the next journey, after self-diagnosis of the emissions control system.

2. If the fault is confirmed by the emission control system, the following message will be displayed:



Emissions fault: Starting prevented in 650 miles.

Additionally, control indicators ,  and  will illuminate and a chime will sound.

When driving, the message is displayed every 30 s while the fault persists.

3. If the last warning level is entered, the following warning message will be displayed:

Emissions fault: Starting prevented

Additionally, control indicators ,  and  will illuminate and a chime will sound.

Consult a workshop for assistance.

Refilling AdBlue

Caution

Only use AdBlue that complies with European standards DIN 70 070 and ISO 22241-1.

Do not use additives.

Do not dilute AdBlue.

Otherwise the selective catalytic reduction system could be damaged.

Notice

Whenever a filling pump with a nozzle for passenger cars is not available at a filling station, use only AdBlue bottles or canisters with a sealed refill adapter for refilling, to prevent splashback and overspill, and in order to ensure that the fumes from the AdBlue tank are captured and do not emerge. AdBlue in bottles or canisters is available in many filling stations and can be purchased e.g. at Vauxhall dealers and other retail outlets.

Since AdBlue has a limited durability, check the date of expiry before refilling.

Notice

Refill the AdBlue tank to a level of at least 5 l to ensure that the new AdBlue level is being detected.

In case AdBlue refill is not successfully detected:

1. Continuously drive the vehicle for 10 min making sure that vehicle speed is always higher than 12 mph.
2. If AdBlue refill is detected successfully, AdBlue supply-driven warnings or limitations will disappear.

If AdBlue refill is still not detected, seek the assistance of a workshop.

If AdBlue must be refilled at temperatures below -11 °C, the refilling of AdBlue may not be detected by the system. In this event, park the vehicle in a space with a higher ambient temperature until AdBlue is liquified.

Notice

When unscrewing the protective cap from the filler neck, ammonia fumes may emerge. Do not inhale as the fumes have a pungent smell. The fumes are not harmful by inhalation.

The AdBlue tank should be filled completely. This must be done if the warning message regarding prevention of an engine restart is already displayed.

The vehicle must be parked on a level surface.

1. Remove key from ignition switch.

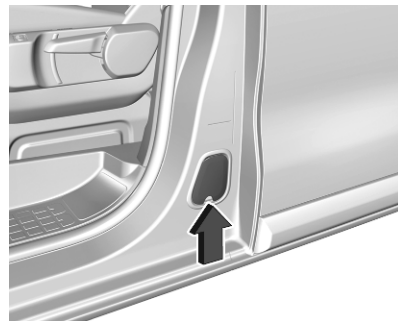

2. Open the driver's door to access the AdBlue flap.
3. Open the AdBlue flap by inserting a finger in the slot in the low part of the flap. Pull the flap to the front.

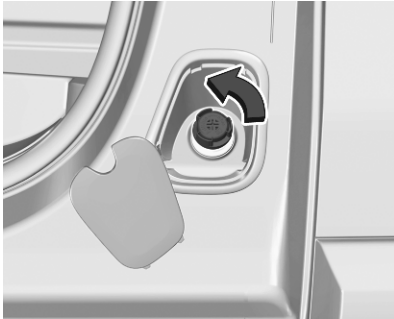

4. Unscrew protective cap from the filler neck.
5. Open AdBlue canister.
6. Mount one end of the hose on the canister and screw the other end on the filler neck.
7. Lift the canister until it is empty, or until the flow from the canister has stopped. This can take up to 5 minutes.
8. Place the canister on the ground to empty the hose, wait 15 s.
9. Unscrew the hose from the filler neck.
10. Mount the protective cap and turn clockwise until it engages.

Notice

Dispose of AdBlue canister according to environmental requirements. Hose can be reused after flushing with clear water before AdBlue dries out.

Electric drive unit

Operation

The vehicle uses an electric drive unit with a 1-gear transmission. The selector is located on the centre console between the seats.

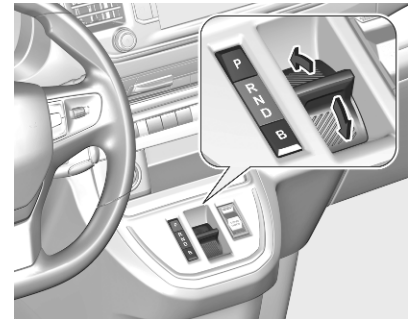

- P** : park position, wheels are locked, engage only when the vehicle is stationary, engaged automatically when driver's door is opened or engine is switched off
- R** : reverse gear, engage only when the vehicle is stationary
- N** : neutral

- D** : drive mode, low recuperation
B : regenerative braking, high recuperation

Shifting

Shifting always starts from a centre position and is operated by pushing the selector up and down. Once operated, the selector will return to the centre position. The selected gear is indicated in the instrument cluster.

Park position P

This position locks the front wheels. It is the recommended position when starting the propulsion system because the vehicle cannot move easily.

Warning

It is dangerous to get out of the vehicle if the selector lever is not fully in **P** with the parking brake firmly applied. The vehicle can roll.

Do not leave the vehicle when the propulsion system is running, the vehicle may move suddenly. You or others can be injured. To be

sure the vehicle will not move, even if you are on even ground, always apply the parking brake and move the selector lever to **P**.

The electric drive unit will shift to **P** automatically if

- the vehicle is stopped
- the driver's door is opened while the vehicle's speed is below 1 mph

The vehicle will not shift into **P** if it is moving too fast. Stop the vehicle and shift into **P**.

To shift into **P**, press the **P** button.

To shift out of **P**:

1. Depress the brake pedal.
2. Shift into the desired gear.

Reverse gear R

Use this gear to reverse.

To shift into and out of **R**:

1. Bring the vehicle to a complete stop.
2. To shift into **R**, depress the brake pedal and move the selector forward.

To shift out of **R**, depress the brake pedal and shift into the desired gear.

Caution

Shifting into **R** while the vehicle is moving forward could damage the electric drive unit. Only shift into **R** after the vehicle has been stopped.

Neutral N

In this position, the propulsion system does not transfer torque to the wheels. To restart the propulsion system when the vehicle is already moving, use **D** only.

Drive mode D

This position is for normal driving.

Caution

If the vehicle seems to accelerate slowly or not respond when you try to go faster, do not continue your journey. The electric drive unit could be damaged. Consult a workshop as soon as possible.

Notice

In slippery conditions, operate the vehicle in **D** for enhanced riding and handling performance.

Regenerative braking mode B

In this position, vehicle speed is significantly reduced by releasing the accelerator pedal, without operating the brake pedal.

Use **B** when driving down steep hills, in deep snow, in mud or in stop-and-go traffic.

⚠ Warning

In the case of extreme temperatures or if the high voltage battery is almost fully charged, the brake force of the regenerative braking may be temporarily reduced. If the braking force is not sufficient, the driver has to be prepared to use the brake pedal.

To activate **B**, shift into **D** and press button **B**.

To deactivate **B**, press button **B**.

If **B** is activated and the driver shifts from **D** to **R** or **N**, **B** is not deactivated, however the brake function is not available. The next time the driver shifts into **D**, **B** is automatically activated.

Regenerative braking ⇨ 182.

Caution

Spinning the tyres or holding the vehicle in one place on a hill using only the accelerator pedal may damage the electric drive unit. If you are stuck, do not spin the tyres. When stopping on a hill, use the brakes to hold the vehicle in place.

Deactivating the automatic operation of P mode for electric vehicles

In certain situations such as very cold weather, when being towed or using an automatic car wash, it may be necessary to deactivate the automatic operation of **P**.

The procedure for the deactivation of the automatic operation of **P** mode also deactivates the automatic operation of the electric parking brake. For this procedure, refer to the description of the parking brake.

Parking brake ⇨ 179

Automatic transmission

The automatic transmission permits automatic gearshifting (automatic mode) or manual gearshifting (manual mode).

Manual shifting is possible in manual mode.

Type A

Move gear selector to position **D**, press **M** next to the selector gear selector and shift with the steering wheel paddles **+** and **-**.

Type B

Move gear selector to **M** and shift with the steering wheel paddles **+** and **-**.

Manual mode ⇨ 175.

Gear selection ⇨ 174.

Transmission display

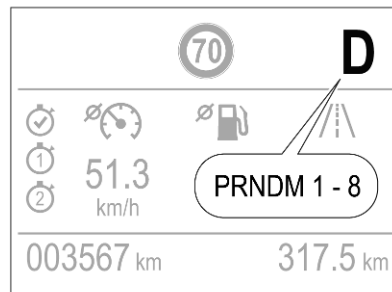

The mode or selected gear is shown in the Driver Information Centre.

In automatic mode, the driving programme is indicated by **D**, **A** or **AUTO**.

In manual mode, **M** and the number of the selected gear is indicated.

R indicates reverse gear.

N indicates neutral position.

For automatic transmission type A only: **P** indicates park position.

Gear selection ⇨ 174.

Gear selection

Type A



Turn the gear selector.

P : park position, front wheels are locked, engage only when the vehicle is stationary and the parking brake is applied

R : reverse gear, engage only when the vehicle is stationary

N : neutral

D : automatic mode

M : manual mode

The gear selector is locked in **P** and can only be moved when the ignition is on and the brake pedal is applied.

The engine can only be started with the gear selector in position **P** or **N**. When position **N** is selected, press the brake pedal or apply the parking brake before starting.

Do not accelerate while engaging a gear. Never depress the accelerator pedal and brake pedal at the same time.

When a gear is engaged, the vehicle slowly begins to creep when the brake is released.

Type B



Turn the gear selector.

R : reverse gear, engage only when the vehicle is stationary

N : neutral

A : automatic mode

M : manual mode

The engine can only be started with the gear selector in position **N**. When position **N** is selected, press the brake pedal and start the engine.

Do not accelerate while engaging a gear. Never depress the accelerator pedal and brake pedal at the same time.

When a gear is engaged, the vehicle slowly begins to creep when the brake is released.

Engine braking

To utilise the engine braking effect, select a lower gear when driving downhill.

Parking

Type A:

Apply the parking brake and select **P**.

Type B

Apply the parking brake and select **N** or leave the selected gear selector position.

Manual mode

1. Activate manual mode

a) Automatic transmission type A:

Manual mode **M** can be activated from position **D** in each driving situation and speed.

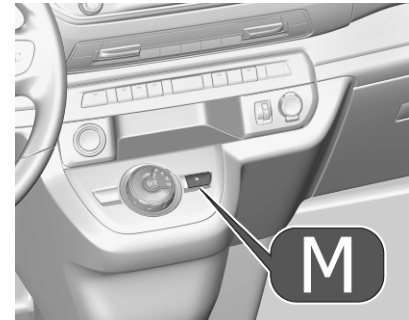

Press button **M**.

b) Automatic transmission type B:

Move gear selector to position **M** if vehicle is at a standstill.

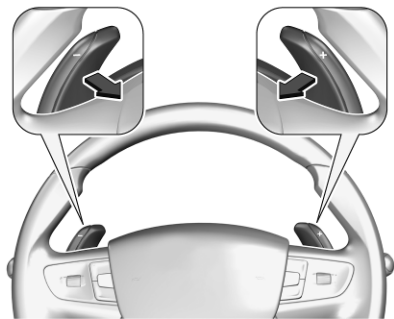

2. Pull steering wheel paddles to select gears manually.

Pull right steering wheel paddle + to shift to a higher gear.

Pull left steering wheel paddle - to shift to a lower gear.

Multiple pulls allow gears to be skipped.

The selected gear is indicated in the instrument cluster.

If a higher gear is selected when vehicle speed is too low, or a lower gear when vehicle speed is too high, the shift is not executed. This can cause a message in the Driver Information Centre.

In manual mode, no automatic shifting to a higher gear takes place at high engine revolutions.

Gear shift indication

The symbol ▲ or ▼ with a number beside it is indicated when gearshifting is recommended for fuel saving reasons.

Shift indication appears only in manual mode.

Electronic driving programmes

- Following a cold start, the operating temperature programme increases engine speed to quickly bring the catalytic converter to the required temperature.
- Special programmes automatically adapt the shifting points when driving up inclines or down hills.
- In snowy or icy conditions or on other slippery surfaces, the electronic transmission control

enables the driver to select manually first, second or third gear for starting off.

Kickdown

Pressing down the accelerator pedal beyond the kickdown detent will lead to maximum acceleration independent of selected driving mode. The transmission shifts to a lower gear depending on engine speed.

Fault

In the event of a fault a message is displayed in the Driver Information Centre.

Vehicle messages ⇨ 126.

Electronic transmission control enables only third gear. The transmission no longer shifts automatically.

Do not drive faster than 62 mph.

Have the cause of the fault remedied by a workshop.

Manual transmission

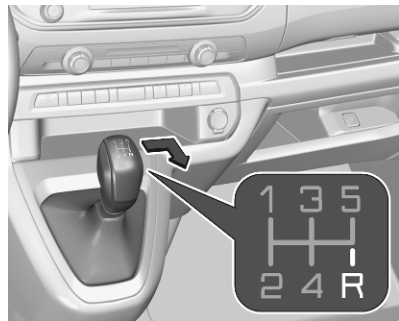

To engage reverse on 5-speed transmission, depress the clutch pedal and move the selector lever to the right and rear.

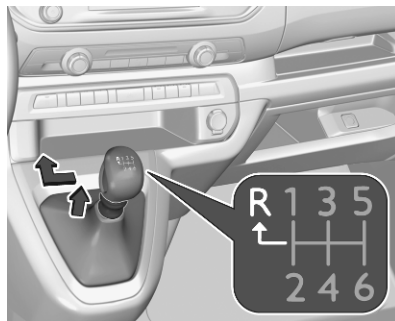

To engage reverse on 6-speed transmission, depress the clutch pedal, pull the ring under the selector lever and move the selector lever quite to the left and front.

If the gear does not engage, set the selector lever to neutral, release the clutch pedal and depress again. Then repeat gear selection.

Do not slip the clutch unnecessarily.

When operating, depress the clutch pedal completely. Do not use the pedal as a foot rest.

When clutch slip is detected for a specific time, the engine power will be reduced. A warning is displayed in the Driver Information Centre. Release the clutch.

Caution

It is not advisable to drive with the hand resting on the selector lever.

Gear shift indication ⇨ 114.

Stop-start system ⇨ 163.

Drive systems

Drive modes

Following drive modes are selectable:

- **Normal mode**
- **Power mode**
- **Eco mode**

Each drive mode corresponds to a different vehicle setting.



To select the respective drive mode, use the shown toggle switch.

Normal mode

Optimises range and dynamic performance. This mode is automatically selected everytime the vehicle is started.

Power mode

Provides the same performance as **Normal mode**, however, when the vehicle is fully loaded.

Eco mode

Optimises energy consumption by reducing the performance of heating and air conditioning as well as reducing the performance of the electric engine.

Brakes

The brake system comprises two independent brake circuits.

If a brake circuit fails, the vehicle can still be braked using the other brake circuit. However, braking effect is achieved only when the brake pedal is depressed firmly. Considerably more force is needed for this. The braking distance is extended. Seek the assistance of a workshop before continuing the journey.

When the engine is not running, the support of the brake servo unit disappears once the brake pedal has been depressed once or twice. Braking effect is not reduced, but braking requires significantly greater force. It is especially important to bear this in mind when being towed.

Antilock brake system

Antilock brake system (ABS) prevents the wheels from locking.

ABS starts to regulate brake pressure as soon as a wheel shows a tendency to lock. The vehicle remains steerable, even during hard braking.

ABS control is made apparent through a pulse in the brake pedal and the noise of the regulation process.

For optimum braking, keep the brake pedal fully depressed throughout the braking process, despite the fact that the pedal is pulsating. Do not reduce the pressure on the pedal.

When braking in an emergency, the hazard warning flashers are switched on automatically depending on the force of deceleration. They are switched off automatically the first time you accelerate.

After starting off, the system performs a self-test which may be audible.



Control indicator  114.

Fault

Warning

If there is a fault in the ABS, the wheels may be liable to lock due to braking that is heavier than normal. The advantages of ABS are no longer available. During hard braking, the vehicle can no longer be steered and may swerve.

Have the cause of the fault remedied by a workshop.

Parking brake

Warning

Before leaving the vehicle, make sure the parking brake is applied. Control indicator  illuminates constantly when parking brake is applied.

Manual parking brake

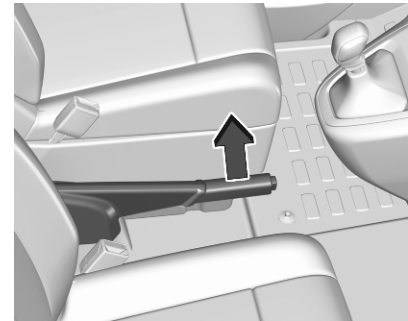

Warning

Always apply parking brake firmly without operating the release button, and apply as firmly as possible on a downhill or uphill slope.

To release the parking brake, pull the lever up slightly, press the release button and fully lower the lever.

To reduce the operating forces of the parking brake, depress the foot brake at the same time.

Electric parking brake

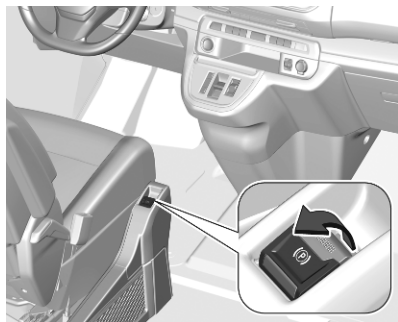

Applying when vehicle is stationary

⚠ Warning

Pull switch (P) for a minimum of 1 second until control indicator (P) illuminates constantly and electric parking brake is applied ⇨ 113. The electric parking brake operates automatically with adequate force.

Before leaving the vehicle, check the electric parking brake status.

Control indicator (P) ⇨ 113.

The electric parking brake can always be activated, even if the ignition is off.

Do not operate electric parking brake system too often without engine running as this will discharge the vehicle battery.

Releasing

Switch on ignition. Keep brake pedal depressed and then push switch (P).

Drive away function

Vehicles with manual transmission: Depressing the clutch pedal and then slightly releasing the clutch pedal and slightly depressing the accelerator pedal releases the electric parking brake automatically. This is only possible if the automatic operation of the electric parking brake is activated. It is not possible when switch (P) is pulled at the same time.

Vehicles with automatic transmission: Engaging **R**, **D** or **M** and then depressing the accelerator pedal releases the electric parking brake automatically. This is only possible if the automatic operation of the electric

parking brake is activated. It is not possible when switch (P) is pulled at the same time.

Electric vehicles: Selecting **R**, **D** or **B** and then depressing the accelerator pedal releases the electric parking brake automatically. This is only possible if the automatic operation of the electric parking brake is activated. It is not possible when switch (P) is pulled at the same time.

Braking when vehicle is moving

When the vehicle is moving and the switch (P) is kept pulled, the electric parking brake system will decelerate the vehicle. As soon as the switch (P) is released, braking will be stopped.

The antilock brake system and the Electronic Stability Control stabilise the vehicle while the switch (P) is kept pulled. If an error of the electric parking brake occurs, a warning message is displayed in the driver information centre. If the antilock brake system and the Electronic Stability Control fail, one or both indicators (ABS) and  illuminate in the

instrument cluster. In this case, stability can only be provided by repeatedly pulling and pushing the switch (P) until the vehicle is immobilised.

Automatic operation

Automatic operation includes automatic application and automatic release of the electric parking brake.

The electric parking brake can also be applied or released manually by using the switch (P).

Automatic application:

- The electric parking brake is automatically applied when the vehicle is stationary and the ignition is switched off.
- (P) illuminates in the instrument cluster and a display message pops up to confirm the application.

Automatic release:

- Parking brake releases automatically after moving off.
- (P) extinguishes in the instrument cluster and a display message pops up to confirm the release.

If the vehicle is equipped with an automatic transmission and the brake is not released automatically, make sure the front doors are properly closed.

Deactivation of the automatic operation for non-electric vehicles

In certain situations such as very cold weather or when being towed, it is necessary to deactivate the automatic operation of the electric parking brake.

1. Start the engine.
2. If the parking brake is released, apply the parking brake pulling the switch (P).
3. Take your foot off the brake pedal.
4. Press the switch (P) for at least 10 seconds and maximum 15 seconds.

5. Release the switch (P).
6. Depress the brake pedal and keep it depressed.
7. Pull the switch (P) for 2 seconds.

The deactivation of the automatic operation of the electric parking brake is confirmed by  illuminating in the instrument cluster ↗ 113. The electric parking brake can only be applied and released manually.

To reactivate the automatic operation, repeat the steps described above.

Deactivation of the automatic operation for electric vehicles

In certain situations such as very cold weather, when being towed or using an automatic car wash, it is necessary to deactivate the automatic operation of the electric parking brake.

The procedure for the deactivation of the automatic operation of the electric parking brake also deactivates the automatic operation of the park position P.

Electric drive unit ↗ 171.

1. With the vehicle stationary, the engine running and **READY** displayed in the instrument cluster, depress the brake pedal and shift into **N**.
2. Within 5 seconds, depress the brake pedal again and keep it depressed.
3. Switch off the engine.
4. Move the selector forward or backward.
5. Release the brake pedal.
6. Switch on the engine.
7. Depress the brake pedal and keep it depressed.
8. Push the switch (P).
9. Release the brake pedal.
10. Switch off the vehicle.

The deactivation of the automatic operation of the electric parking brake is confirmed by  illuminating in the instrument cluster ⇨ 113. The electric parking brake can only be applied and released manually.

To reactivate the automatic operation, repeat the steps described above.

Functionality check

When the vehicle is not moving, the electric parking brake might be applied automatically. This is done to check the system.

Fault

Failure mode of electric parking brake is indicated by a control indicator (P)! and by a vehicle message which is displayed in the Driver Information Centre.

Vehicle messages ⇨ 126.

Control indicator (P) flashes: electric parking brake is not fully applied or released. When continuously flashing, release electric parking brake and retry applying.

Brake assist

If brake pedal is depressed quickly and forcefully, maximum brake force is automatically applied.

Operation of brake assist might become apparent by a pulse in the brake pedal and a greater resistance when depressing the brake pedal.

Maintain steady pressure on the brake pedal as long as full braking is required. Maximum brake force is automatically reduced when brake pedal is released.

Hill start assist

The system helps prevent unintended movement when driving away on inclines.

When releasing the brake pedal after stopping on an incline, brakes remain on for further 2 seconds. The brakes release automatically as soon as the vehicle begins to accelerate.

Regenerative braking

Warning

While using regenerative braking, the brake lights do not illuminate. If the succeeding traffic is to be warned, depress the brake pedal.

Regenerative braking generates electrical energy resulting from engine braking to charge the high

voltage battery. Regenerative power may be limited when the high voltage battery is fully charged.

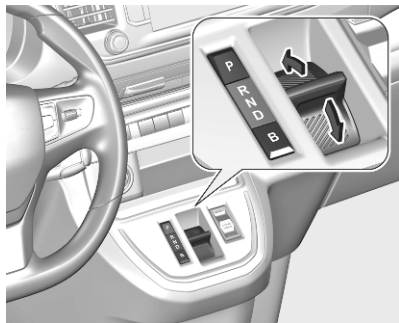

If the selector is in **B**, energy is regenerated when the accelerator pedal is lifted. In addition, the vehicle's deceleration is enforced. **B** can only be activated if the selector is in **D**.

Electric drive unit ⇨ 171.

Ride control systems

Electronic Stability Control and Traction Control system

Electronic Stability Control (ESC) improves driving stability when necessary, regardless of the type of road surface or tyre grip.

As soon as the vehicle starts to swerve (understeer / oversteer), engine output is reduced and the wheels are braked individually.

ESC operates in combination with the Traction Control system (TC). It prevents the driven wheels from spinning.

The TC is a component of the ESC.

Traction Control improves driving stability when necessary, regardless of the type of road surface or tyre grip, by preventing the driven wheels from spinning.

As soon as the driven wheels starts to spin, engine output is reduced and the wheel spinning the most is braked

individually. This considerably improves the driving stability of the vehicle on slippery road surfaces.



ESC and TC are operational after each engine start as soon as the control indicator  extinguishes.

When ESC and TC operate,  flashes.

Warning

Do not let this special safety feature tempt you into taking risks when driving.

Adapt speed to the road conditions.

Control indicator  ⇨ 114.

Deactivation



ESC and TC can be deactivated, everytime it is required: press .

The LED in the button  illuminates.

A status message appears in the Driver Information Centre when ESC and TC are deactivated.

ESC and TC are reactivated by pressing the  button again or in the case that the vehicle is driven faster than 30 mph.

The LED in the button  extinguishes when ESC and TC are reactivated.

ESC and TC are also reactivated the next time the ignition is switched on.

Fault

If there is a fault in the system, the control indicator  illuminates continuously and a message appears in the Driver Information Centre. The system is not operational.

Have the cause of the fault remedied by a workshop.

Selective ride control

Caution

The vehicle is designed to drive principally on-road, but it also enables driving off-road occasionally.

However, do not drive on terrain where the vehicle could be damaged due to obstacles, such as stones among others and on terrain with steep inclines and poor grip.

Do not cross waters.

Caution





When driving off-road, sudden motion and manoeuvres can cause a collision or losing control.

Selective ride control is designed to optimise traction in low-grip conditions (snow, mud and sand).

It adapts to the terrain by acting on the front wheels, in doing so this saves the weight normally associated with a more conventional four wheel drive system.



Selective ride control allows to choose between five driving modes by turning the control:

- ESC off mode 
- standard mode 
- snow mode 
- mud mode 
- sand mode 

An LED illuminates and a status message appears in the Driver Information Centre to confirm the chosen mode.

ESC off mode

The ESC and Traction Control are deactivated in this mode.

ESC and Traction Control are reactivated automatically from 30 mph or everytime the ignition is switched on.

Standard mode

This mode is calibrated for a low level of wheel spin, based on the different types of grip generally encountered in normal day to day driving.

Everytime the ignition is switched off, the system is automatically reset to this mode.

Snow mode

This mode adapts to the grip conditions encountered by each wheel when starting.

When advancing, the system optimises wheel spin to guarantee the best acceleration based on the available traction. Recommended in cases of deep snow and steep inclines.

This mode is active up to a speed of 30 mph.

Mud mode

This mode allows considerable wheel spin at start-up for the wheel with the least grip, this removes mud and re-establishes traction.

Simultaneously, the wheel with the most grip is provided with the most torque possible.

This mode is active up to a speed of 50 mph.

Sand mode

This mode allows a small amount of simultaneous wheel spin on the two drive wheels, enabling the vehicle to advance and reduce the risk of sinking.

This mode is active up to a speed of 75 mph.

Caution

Do not use the other modes on sand as the vehicle may become stuck.

Driver assistance systems

⚠ Warning

Driver assistance systems are developed to support the driver and not to replace the driver's attention.

The driver accepts full responsibility when driving the vehicle.

When using driver assistance systems, always take care regarding the current traffic situation.

Cruise control

The cruise control can store and maintain speeds above 25 mph. Additionally at least the third gear must be engaged on manual transmission, on automatic transmission position **D** / **A** or the second or a higher gear in position **M** must be selected.

Deviations from the stored speeds may occur when driving uphill or downhill.

The system maintains the vehicle speed at the preset speed by the driver, without any action on the accelerator pedal.

The preset speed can be exceeded temporarily by pressing the accelerator pedal firmly.

The status and preset speed is displayed in the Driver Information Centre.

Do not use the cruise control if it is not advisable to maintain a constant speed.

Control indicator  117.

Switching on the system

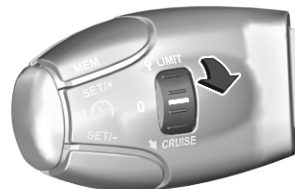

Turn to **Cruise**, the symbol  and a message are displayed in the Driver Information Centre. The system is still not active.

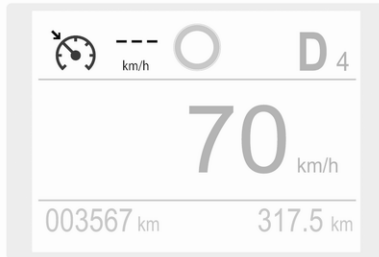

Activation of the functionality

Setting the speed manually

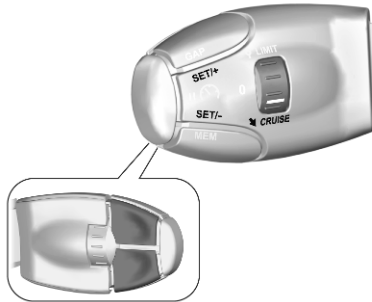

Accelerate to the desired speed and press **SET/+** or **SET/-**. The current speed is stored and maintained. Accelerator pedal can be released.

The preset speed can then be changed by pressing **SET/+** to increase or **SET/-** to decrease the speed. Short press changes speed in small steps, long press in large steps.

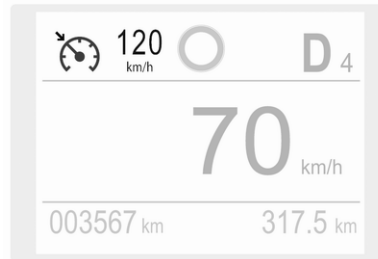

Speed value is indicated in the Driver Information Centre.

Selecting a preset speed

Preset speed values can be selected from a list in the Info Display.

Press **MEM** to display the preset speeds in the Info Display.



Select the requested speed by touching the relevant icon. This speed is the new value for the cruise control.

Memorising of preset speeds ↪ 127

Adopting the speed by the speed limit recognition

The intelligent speed adaptation informs the driver when a speed limit is detected by the speed limit recognition. The detected speed limit can be used as new value for the cruise control.

Using a camera at the top of the windscreen, this system detects and reads speed limit and end of speed limit signs. The system also takes account of information on speed limits from the navigation map data.

The function can be deactivated or activated in the personalisation menu ⇨ 127.

If the cruise control is active, the recognised speed limit will be displayed in the Driver Information Centre and **MEM** illuminates.

The displayed information depends on the Driver Information Centre version.

In the Driver Information Centre, the speed limit sign is shown in the display and **MEM** illuminates for a few seconds.

Press **MEM** to request saving of the suggested speed.

Press **MEM** once more to confirm and save the new speed setting.

This speed is the new value for the cruise control.

Exceeding the set speed

Vehicle speed can be increased by depressing the accelerator pedal. When the accelerator pedal is released, the previously stored speed is resumed.

Deactivation of the functionality



Press button to deactivate the functionality. The cruise control is in pause mode and a message is displayed. The vehicle is driven without cruise control.

Cruise control is deactivated, but not switched off. Last stored speed remains in memory for later speed resume.

Cruise control is deactivated automatically:

- The brake pedal is depressed.
- The clutch pedal is depressed.
- Vehicle speed is below 25 mph.
- The Traction Control system or Electronic Stability Control is operating.
- The selector lever is in **N** (automatic transmission) / the first or second gear (manual transmission).

Resume stored speed



Press the button at a speed above 25 mph to return to the stored speed.

Switching off the system



Turn to 0 to switch off the system.

Fault

In the event of a cruise control fault, the speed is cleared resulting in flashing of the dashes.

The cruise control may not operate correctly if traffic signs do not comply with the Vienna Convention on Road Signs and Signals.

Speed limiter

The speed limiter prevents the vehicle exceeding a preset maximum speed.

The maximum speed can be set at speeds above 18 mph.

The driver can accelerate the vehicle up to the preset speed. Deviations from the limited speed may occur when driving downhill.

The preset speed can be exceeded temporarily by pressing the accelerator pedal firmly.

The status and preset speed limit are displayed in the Driver Information Centre.

Switching on the system



Turn to **Limit**, the symbol  and a message are displayed in the Driver Information Centre. The system is still not active.



Activation of the functionality



Press the button to activate the system with the last programmed speed.

Press the button once again to pause the activation of the system.

Setting speed by the driver

To set the speed, the system does not have to be activated.

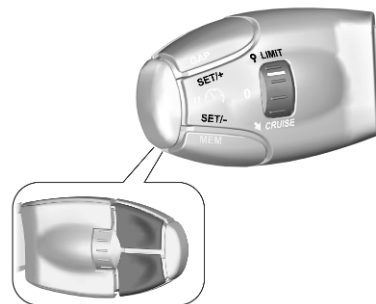

Following the preset speed can be set by pressing **SET/+** to increase or **SET/-** to decrease the desired maximum speed. Short press changes the preset speed in small steps, long press in large steps. The speed value is indicated in the Driver Information Centre.

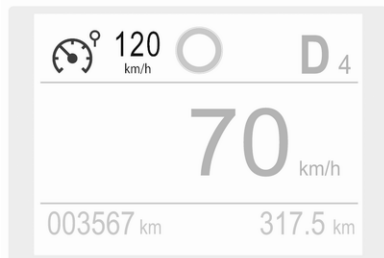

Selecting a preset speed

Preset speed values can be selected from a list in the Info Display.

Press **MEM** to display the preset speeds in the Info Display.



Select the requested speed by touching the relevant icon. This speed is the new value for the speed limiter.

Memorising of preset speeds ⇨ 127

Adopting speed by the traffic sign assistant

The intelligent speed adaptation informs the driver when a speed limit is detected by the traffic sign assistant. The detected speed limit can be used as new value for the speed limiter.

Using a camera at the top of the windscreen, this system detects and reads speed limit and end of speed

limit signs. The system also takes account of information on speed limits from the navigation map data.

The function can be activated or deactivated in the personalisation menu ⇨ 127.

If the speed limiter is active, the recognised speed limit will be displayed in the Driver Information Centre and **MEM** illuminates.

The displayed information depends on the Driver Information Centre version.

In the Driver Information Centre, the speed limit sign is shown and **MEM** illuminates for a few seconds.

Press **MEM** to request saving of the suggested speed.

Press **MEM** once more to confirm and save the new speed setting.

This speed is the new value for the speed limiter.

Exceeding the speed limit

In the event of an emergency, it is possible to exceed the speed limit by depressing the accelerator pedal firmly nearly to the final point.

Release the accelerator pedal and the speed limiter function is reactivated once a speed lower than the limit speed is obtained.

Deactivation of the functionality



Press the button to deactivate the functionality. The speed limiter is in pause mode and a message is displayed. The vehicle is driven without speed limit.

The speed limiter is deactivated, but not switched off. The last stored speed remains in memory for later speed resume.

Resume limit speed



Press the button to return to the stored speed limit.

Switching off the system



Turn to 0 to switch off the system.

Fault

In the event of a speed limiter fault, the speed is cleared resulting in flashing of the dashes.

The speed limiter may not operate correctly if traffic signs do not comply with the Vienna Convention on Road Signs and Signals.

Semi-adaptive cruise control

The semi-adaptive cruise control is an enhancement to the conventional cruise control with the additional feature of maintaining a certain following distance to the vehicle ahead. It uses a camera at the top of the windscreen and a radar sensor in the front bumper to detect the vehicles ahead. If no vehicle is detected in the driving path, the semi-adaptive cruise control will behave like a conventional cruise control.

The semi-adaptive cruise control automatically decelerates the vehicle when approaching a slower moving vehicle. It then adjusts the vehicle speed to follow the vehicle ahead at the selected following distance. The vehicle speed increases or decreases to follow the vehicle ahead, but will not exceed the set speed. The semi-adaptive cruise control does not actively brake the vehicle but uses engine braking.

If the vehicle ahead accelerates or changes lane, the semi-adaptive cruise control progressively

accelerates the vehicle to return to the stored set speed. If the driver operates the turn lights to overtake a slower vehicle, the semi-adaptive cruise control allows the vehicle to temporarily approach the vehicle ahead to help passing it. However, the set speed will never be exceeded.

If the selected following distance cannot be maintained anymore because the vehicle is moving too fast or the vehicle ahead is moving too slowly, a warning chime is given and a message is displayed in the Driver Information Centre. The message prompts the driver to take back control of the vehicle.

The semi-adaptive cruise control can store set speeds over 25 mph and 93 mph. Additionally at least the third gear must be engaged on manual transmission, on automatic transmission position **D / A** or the second or a higher gear in position **M** must be selected.

Warning

The complete driver attention is always required while driving with semi-adaptive cruise control. The driver stays fully in control of the vehicle because the brake pedal and the accelerator pedal have priority over any semi-adaptive cruise control operation.

Switching on the system

The semi-adaptive cruise control can be switched on at a speed between **25 mph** and 93 mph.

A precondition is that semi-adaptive cruise control is not deactivated in the vehicle personalisation menu ↗ 127.

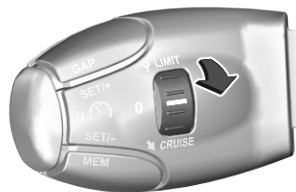

Turn to **Cruise**, the symbol  and a message are displayed in the Driver Information Centre. The system is still not active.

Activation

Setting the speed manually

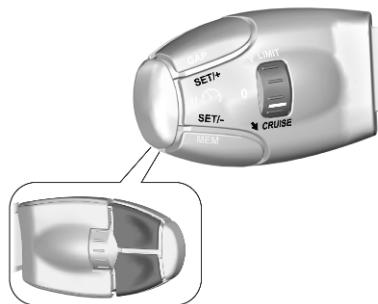

Accelerate to the desired speed and press **SET/+** or **SET/-**. The current speed is stored and maintained. Accelerator pedal can be released.

The preset speed can then be changed by pressing **SET/+** to increase or **SET/-** to decrease the speed. Short press changes speed in small steps, long press in large steps.

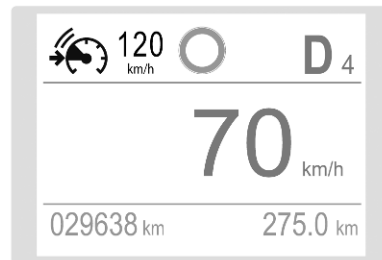
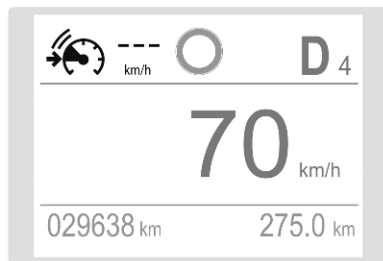

Speed value is indicated in the Driver Information Centre.

Selecting a preset speed

Preset speed values can be selected from a list in the Info Display.

Press **MEM** to display the preset speeds in the Info Display.



Select the requested speed by touching the relevant icon. This speed is the new value for the semi-adaptive cruise control.

Memorising of preset speeds ⇨ 127.

Adopting the speed by the speed limit recognition

The intelligent speed adaptation informs the driver when a speed limit is detected by the speed limit recognition. The detected speed limit can be used as new value for the semi-adaptive cruise control.

Using a camera at the top of the windscreen, this system detects and reads speed limit and end of speed

limit signs. The system also takes account of information on speed limits from the navigation map data.

The function can be deactivated or activated in the personalisation menu ⇨ 127.

If the semi-adaptive cruise control is active, the recognised speed limit will be displayed in the Driver Information Centre and **MEM** illuminates.

The displayed information depends on the Driver Information Centre version.

In the Driver Information Centre, the speed limit sign is shown in the display and **MEM** illuminates for a few seconds.

Press **MEM** to request saving of the suggested speed.

Press **MEM** once more to confirm and save the new speed setting.

This speed is the new value for the semi-adaptive cruise control.

Exceeding the set speed

Vehicle speed can be increased by depressing the accelerator pedal. When the accelerator pedal is

released, the previously stored speed is resumed. If a slower moving vehicle is ahead, the following distance selected by the driver is restored.

If the set speed is exceeded, the indicated speed setting flashes in the Driver Information Centre and a warning message appears.

Resume stored speed



Press the button at a speed above 25 mph to return to the stored speed.

Setting the following distance

When semi-adaptive cruise control detects a slower moving vehicle in the driving path, it will adjust the vehicle speed to maintain the following distance selected by the driver.

The following distance can be set to close (1 bar), normal (2 bars) or far (3 bars).

If the engine is running and the semi-adaptive cruise control is enabled (grey), you can modify the following distance setting:

Press **GAP**, the current setting is shown in the Driver Information Centre.

Press **GAP** again to change the following distance: The new setting is displayed in the Driver Information Centre.

The selected following distance is indicated by full bars in the semi-adaptive cruise control page.

Warning

The driver accepts full responsibility for the appropriate following distance based on traffic, weather and visibility conditions. Following distance must be adjusted or the system switched off when required by the prevailing conditions.



Detecting the vehicle ahead

If the system does not detect a vehicle in the driving path,  is displayed in the Driver Information Centre. The system operates as conventional cruise control.

If the system detects a vehicle in the driving path,  is displayed in the Driver Information Centre.

If the system detects a vehicle in the driving path which is too close or too slow, it adjusts the speed accordingly.  is displayed in the Driver Information Centre.

If the system approaches the limit of adjusting the speed to maintain the following distance, the driver is

warned that an automatic deactivation of the system is imminent.  and  flash in the Driver Information Centre.

If the system reaches the limit of adjusting the speed to maintain the following distance and the driver does not react to this situation, the system is automatically deactivated and  is displayed in the Driver Information Centre.

If the set speed is temporarily exceeded by the driver, the system is automatically deactivated and  is displayed in the Driver Information Centre.

Deactivation of the functionality



Press button to deactivate the functionality. The semi-adaptive cruise control is in pause mode and a message is displayed. The vehicle is driven without semi-adaptive cruise control.

Semi-adaptive cruise control is deactivated, but not switched off. Last stored speed remains in memory for later speed resume.

Semi-adaptive cruise control is deactivated automatically:

- distance between vehicle and vehicle ahead too small
- vehicle speed below 25 mph

- speed of the vehicle ahead too slow
- Traction Control system or Electronic Stability Control operating
- selected following distance reached
- another vehicle inserts between vehicle and vehicle ahead
- following distance cannot be maintained, e.g., in the case of a steep descent

Switching off the system

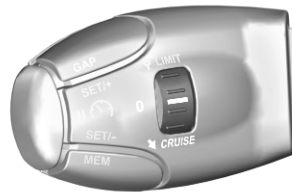

Turn to 0 to switch off the system. The symbol  and a message are displayed in the Driver Information Centre.

Switching off the ignition deletes the stored set speed.

Driver's attention

- Use the semi-adaptive cruise control carefully on bends or mountain roads, as it can lose the vehicle ahead and needs time to detect it again.
- Do not use the system on slippery roads as it can create rapid changes in tyre traction (wheel spinning), so that the control of the vehicle can be lost.
- Do not use the system when the spare wheel is in use.

System limits

⚠ Warning

The system's automatic brake force does not permit hard braking and the braking level may not be sufficient to avoid a collision.

- The control range is limited to a maximum deviation of 20 mph between the set speed and the speed of the vehicle ahead.
- After a sudden lane change, the system needs a certain time to detect the next preceding vehicle. So if a new vehicle is detected, the system may accelerate instead of braking.
- The semi-adaptive cruise control does ignore the oncoming traffic.
- The semi-adaptive cruise control does not consider pedestrians and animals for braking and driving off.
- The semi-adaptive cruise control considers stopped vehicles only at low speed.

- Do not use the semi-adaptive cruise control when towing a trailer.
- Do not use the semi-adaptive cruise control on roads with an incline of more than 10%.

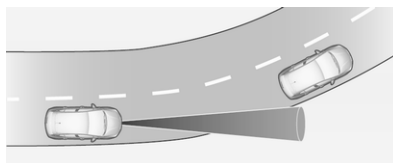
Bends

The semi-adaptive cruise control calculates a predicted path based on the centrifugal force. This predicted path considers the current bend characteristic, but cannot consider a future bend change. The system may lose the current vehicle ahead or consider a vehicle which is not in the actual lane. This can happen when entering or exiting a bend or if the bend gets stronger or weaker. If it no longer detects any vehicle ahead, then control indicator  will extinguish.

If the centrifugal force is too high in a bend, the system slows down the vehicle slightly. This braking level is not designed to avoid spinning-off the bend. The driver is responsible for reducing the selected speed before entering a bend and in general to adapt the speed to the road type and to existing speed limits.

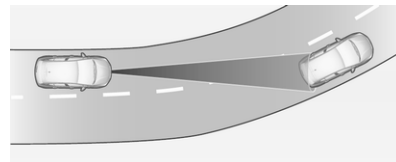
**Motorways**

On motorways, adapt the set speed to the situation and the weather. Always consider that semi-adaptive cruise control has a limited visibility range, a limited braking level and a certain reaction time to verify if a vehicle is on the driving path or not. Semi-adaptive cruise control may not be able to brake the vehicle in time to avoid a collision with a much slower vehicle or after a lane change. This is

particularly true while driving fast or if the visibility is reduced due to weather conditions.

While entering or exiting a motorway, semi-adaptive cruise control may lose the vehicle ahead and accelerate up to the set speed. For this reason, decrease the set speed before the exit or before the entry.

Vehicle path changes

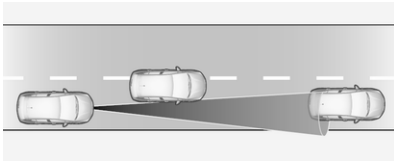

If another vehicle enters your driving path, semi-adaptive cruise control will first consider the vehicle when it is completely in your path. Be ready to take action and depress the brake pedal, if you need to brake more quickly.

Hill considerations



⚠ Warning

Do not use the semi-adaptive cruise control on steep hill roads.

System performance on hills depends on vehicle speed, vehicle load, traffic conditions and the road gradient. It may not detect a vehicle in your path while driving on hills. On steep hills, you may have to use the accelerator pedal to maintain your vehicle speed. When going downhill you may have to brake to maintain or reduce your speed.

Note that applying the brake deactivates the system.

Fault

In the event of a fault with the semi-adaptive cruise control, a warning light is illuminated and a message is displayed in the instrument cluster, accompanied by a warning chime.

The semi-adaptive cruise control may not operate correctly if traffic signs do not comply with the Vienna Convention on Road Signs and Signals.

Have the system checked by a dealer or a qualified workshop.

As a safety measure, do not use the system if the brake lights are faulty.

Forward collision alert

The forward collision alert may help to avoid or reduce the harm caused by front-end crashes.

The forward collision alert uses the front camera in the windscreen and a radar sensor in the front bumper to detect a preceding vehicle directly ahead, in your path.

If a vehicle directly ahead is approached too quickly, a warning chime and alert in the Driver Information Centre is provided.

⚠ Warning

Forward collision alert is just a warning system and does not apply the brakes. When approaching a vehicle ahead too rapidly, there may not be enough time to avoid a collision.

The driver accepts full responsibility for the appropriate following distance based on traffic, weather and visibility conditions.



The complete attention of the driver is always required while driving. The driver must always be ready to take action and apply the brakes.

Activation

Forward collision alert detects vehicles and operates automatically at all speeds above 3 mph and 53 mph. The system detects stationary vehicles if the speed does not exceed 50 mph.

Alerting the driver

The driver is warned by following alerts:

- Symbol  illuminates and a warning message is displayed in the Driver Information Centre when the distance to the vehicle ahead gets to small.
- Symbol  illuminates, a warning message is displayed in the Driver Information Centre and a warning chime sounds, when a collision is imminent and immediate driver's action is required.

⚠ Warning

Forward collision alert is just a warning system and does not apply the brakes. When approaching a vehicle ahead too rapidly, there may not be enough time to avoid a collision.

The driver accepts full responsibility for the appropriate following distance based on traffic, weather and visibility conditions.

The complete attention of the driver is always required while driving. The driver must always be ready to take action and apply the brakes.

Caution

The colour lighting of this control indicator does not correspond to local traffic laws on following distance. The driver bears full responsibility for maintaining safe following distance according to

applicable traffic rules, weather and road conditions etc. at all times.

Selecting the alert sensitivity

The alert sensitivity has to be set to close, normal or distant in the vehicle personalisation menu ⇨ 127.

The chosen setting will remain until it is changed. The alert timing will vary based on vehicle speed. The faster the vehicle speed, the farther away the alert will occur. Consider traffic and weather conditions when selecting the alert timing.

Deactivation

The system can only be deactivated by deactivating the active emergency braking in the vehicle personalisation ⇨ 127.

System limitations

Forward collision alert is designed to warn on vehicles only, but may react also to other objects.

In the following cases, forward collision alert may not detect a vehicle ahead or sensor performance is limited:

- driving on winding or hilly roads
- driving during nighttime
- weather limits visibility, such as fog, rain, or snow
- the sensor in the windscreen is blocked by snow, ice, slush, mud, dirt etc.
- the windscreen is damaged or affected by foreign objects, e.g. stickers

Active emergency braking

Active emergency braking can help to reduce the damage and injury from crashes with vehicles, pedestrians and obstacles directly ahead, when a collision can no longer be avoided either by manual braking or by steering. Before the active emergency braking applies, the driver is warned by the forward collision alert or the front pedestrian protection alert.

Forward collision alert ⇨ 199

Front pedestrian protection ⇨ 203

The feature uses various inputs (e.g. camera sensor, radar sensor, brake pressure, vehicle speed) to calculate the probability of a frontal collision.

Warning

This system is not intended to replace the driver responsibility for driving the vehicle and looking ahead. Its function is limited to supplemental use only to reduce the vehicle speed before a collision.

The system may not react to animals. After a sudden lane change, the system needs a certain time to detect the next preceding vehicle.

The driver must always be ready to take action and apply the brakes and steer to avoid collisions.

Functionality

Active emergency braking is equipped with a front camera and operates in forward gear above walking speed up to 53 mph. The system detects stationary vehicles only if the speed does not exceed 50 mph. Pedestrians are detected only if the speed does not exceed 37 mph.

A precondition is that active emergency braking is not deactivated in the vehicle personalisation menu ↪ 127.

If deactivated,  illuminates in the instrument cluster and a warning message is displayed in the Driver Information Centre.

If the system has been deactivated, it is reactivated automatically the next time the ignition is switched on.

The system includes:

- emergency automatic braking
- forward collision alert
- front pedestrian protection

Emergency automatic braking

After activation of brake preparation system and just before the imminent collision, this function automatically applies limited braking to reduce the impact speed of the collision or prohibit a crash.

If active emergency braking is applied,  flashes in the instrument cluster.

Depending on the situation, the vehicle may automatically brake moderately or hard.

Front automatic braking can only occur if a vehicle or a pedestrian ahead is detected.

Forward collision alert ↪ 199

Front pedestrian protection ↪ 203

Below a speed of 19 mph, emergency automatic braking may slow down the vehicle to a complete stop. If the speed exceeds 19 mph, emergency automatic braking reduces the speed. However, the driver must apply the brake.

Emergency automatic braking may slow the vehicle to a complete stop to try to avoid a potential crash. If the vehicle comes to a complete stop, automatic braking is maintained for up to 2 seconds.

- Automatic transmission: If the vehicle comes to a complete stop, keep the brake pedal depressed to prevent the vehicle from starting off again.
- Manual transmission: If the vehicle comes to a complete stop, the engine may stall.

Operation of the function may be felt by a slight vibration in the brake pedal.

Warning

Emergency automatic braking is an emergency crash preparation feature and is not designed to avoid crashes. Do not rely on the system to brake the vehicle. Emergency automatic braking will not brake outside of its operating

speed range and only responds to detected vehicles and pedestrians.

System limitations

In some cases, the active emergency braking system may provide an automatic braking in situations that seem to be unnecessary, for instance in parking garages, due to traffic signs in a curve or due to vehicles in another lane. This is normal operation, the vehicle does not need service. Firmly apply the accelerator pedal to override the automatic braking if the situation and the surroundings permit.

In the following cases, active emergency braking performance is limited:

- Driving on winding or hilly roads.
- Detecting all vehicles, especially vehicles with a trailer, tractors, muddy vehicles, etc.
- Detecting a vehicle when weather limits visibility, such as in fog, rain, or snow.

- Driving during nighttime.
- The windscreen is damaged or stickered.

Complete attention is always required while driving, and the driver should be ready to take action and apply the brakes and / or steer the vehicle to avoid crashes.

We recommend to deactivate the system in the vehicle personalisation in the following cases:

- when towing a trailer or caravan
- when carrying long objects on roof bars or a roof rack
- when the vehicle is being towed with the engine running
- when tyre chains are fitted
- when a spare wheel is fitted that is smaller than the other wheels
- before using an automatic car wash with the engine running
- before placing the vehicle on a rolling road in a workshop
- if the windscreen has been damaged close to the camera

- if the front bumper has been damaged
- if the brake lamps are not working

Fault

In case the system requires a service,  is illuminated in the instrument cluster, a message is displayed in the Driver Information Centre and an audible signal is given.

If the system does not work as it should do, vehicle messages are displayed in the Driver Information Centre.

Vehicle messages ⇨ 126.

Front pedestrian protection

Front pedestrian protection may help to avoid or reduce the harm caused by front-end crashes with pedestrians when driving forward.

The system uses the front camera in the windscreen and a radar sensor in the front bumper to detect a pedestrian directly ahead in your path.

Front pedestrian protection can detect and alert to pedestrians in a forward gear at speeds between 3 mph and 37 mph.

During nighttime driving, system performance is limited.

⚠ Danger

Front pedestrian braking does not provide an alert or automatically brake the vehicle, unless it detects a pedestrian.

The system may not detect pedestrians, including children, when the pedestrian is not directly ahead, not fully visible, not standing upright, or when part of a group.

Front pedestrian protection includes:

- detecting front pedestrian ahead
- front pedestrian alert

Front pedestrian protection is activated together with forward collision alert.

Forward collision alert ⇨ 199.

Detecting front pedestrian ahead

A pedestrian ahead is indicated by a symbol in the instrument cluster.

Front pedestrian alert

When approaching a detected pedestrian too quickly, a warning message is displayed in the Driver Information Centre. A warning chime is provided.

Cruise control or semi-adaptive cruise control may be disengaged when the front pedestrian alert occurs.

System limitations

In the following cases, front pedestrian protection may not detect a pedestrian ahead or the sensor performance is limited:

- vehicle speed is out of range from 3 mph to 37 mph in forward gear
- the distance to an pedestrian ahead is more than 40 m
- driving on winding or hilly roads
- driving during nighttime

- weather limits visibility, such as fog, rain, or snow
- the sensor in the windscreen is blocked by snow, ice, slush, mud, dirt etc.
- the windscreen is damaged or affected by foreign objects, e.g. stickers

Parking assist

General information

When attaching a trailer or bicycle carrier to the trailer hitch, the parking assist is deactivated.

⚠ Warning

The driver bears full responsibility for the parking manoeuvre.

Always check the surrounding area when driving backwards or forwards while using parking assist system.

Rear parking assist

The system warns the driver with acoustic signals against potentially hazardous obstacles behind the vehicle in a distance range up to 50 cm while reverse gear is engaged.

The system operates with ultrasonic parking assist sensors in the rear bumper.

Activation

Rear parking assist is activated when reverse gear is engaged and ignition is switched on. This is confirmed by a chime.



Info Display without touchscreen

The system is ready to operate when the LED in the parking assist button P_{OFF} is not illuminated.

Info Display with touchscreen

Activate the parking assist in the vehicle personalisation ↻ 127.

Indication

Depending on which side of the vehicle is closer to an obstacle, acoustic warning signals in the vehicle sound on the respective side. The interval between the sounds becomes shorter as the vehicle gets closer to that obstacle. When the distance is less than approx. 30 cm, the sound is continuous.

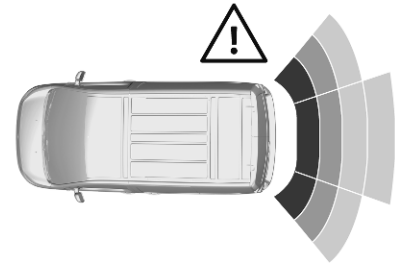

Additionally, the distance to rear obstacles is displayed by changing distance lines in the Info Display ↻ 123. When the obstacle is very close,  for danger is displayed.

Deactivation

Info Display without touchscreen

Press P_{OFF} to deactivate the system manually. The LED in the button illuminates when the system is deactivated.

Info Display with touchscreen

Deactivate the parking assist in the vehicle personalisation ↻ 127. The state of the system

If the system has been deactivated, it is not reactivated automatically the next time the ignition is switched on.

Front-rear parking assist

The front-rear parking assist measures the distance between the vehicle and obstacles in front and behind the vehicle. It informs and warns the driver by giving acoustic signals and display indication.

It uses two different acoustic warning signals for the front and rear monitoring areas, each with a different tone frequency.

The system operates with ultrasonic parking assist sensors in the rear and front bumper.

Activation

In addition to the rear parking assist, the front parking assist is triggered when an obstacle is detected in front and the speed of the vehicle is below 6 mph.

Info Display without touchscreen

The system is ready to operate when the LED in the parking assist button  is not illuminated.

Info Display with touchscreen

Activate the parking assist in the vehicle personalisation ⇨ 127.

Indication

Depending on which side of the vehicle is closer to an obstacle, acoustic warning signals in the vehicle sound on the respective side. The interval between the sounds becomes shorter as the vehicle gets closer to that obstacle. When the distance is less than approx. 30 cm, the sound is continuous.

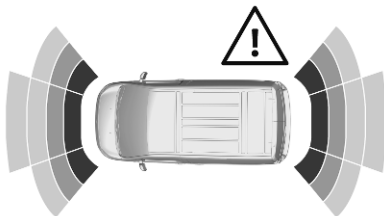

Additionally, the distance to rear and front obstacles is displayed by changing distance lines in the Info Display ⇨ 123.

If the vehicle stops for more than 3 seconds in a forward gear, if automatic transmission is in **P** or if no further obstacles are detected, no acoustic warning signals are given.

Deactivation

The system is deactivated automatically when vehicle speed exceeds 6 mph by pressing the parking assist button .

Info Display without touchscreen

Press  to deactivate the system. The LED in the button illuminates when the system is deactivated.

Info Display with touchscreen

Deactivate the parking assist in the vehicle personalisation ⇨ 127.

If the system has been deactivated manually, it is not reactivated automatically the next time the ignition is switched on.

System limitations

In the event of a fault or if the system does not work temporarily, e.g. because of high external noise level or other interference factors,  illuminates in the instrument cluster. A message is displayed in the Driver Information Centre.

Warning

Under certain circumstances, various reflective surfaces on objects or clothing as well as external noise sources may cause the system to fail to detect obstacles.

Special attention must be paid to low obstacles which can damage the lower part of the bumper.

Caution

Performance of the system can be reduced when sensors are covered, e.g. by ice or snow.

Performance of the parking assist system can be reduced due to heavy loading.

Special conditions apply if there are taller vehicles in the vicinity (e.g. off-road vehicles, mini vans, vans). Object identification and correct distance indication in the upper part of these vehicles cannot be guaranteed.

Objects with a very small reflection cross-section, e.g. objects of narrow size or soft materials, may not be detected by the system.

Parking assist systems do not detect objects outside the detection range.

Side blind spot alert

The side blind spot alert system detects and reports objects on either side of the vehicle, within a specified blind spot zone. The system displays a visual alert in each exterior mirror, when detecting objects that may not be visible in the interior and exterior mirrors.

Side blind spot alert uses some of the parking assist sensors which are located in the front and rear bumper on both sides of the vehicle.

Warning

Side blind spot alert does not replace driver vision.

The system does not detect:

- vehicles outside the side blind zones which may be rapidly approaching
- pedestrians, cyclists or animals

Before changing a lane, always check all mirrors, look over the shoulder and use the turn signal.

Activation

Info Display without touchscreen



Press .

Info Display with touchscreen

Activate the function in the vehicle personalisation.

Vehicle personalisation  127.

 illuminates green in the instrument cluster to confirm the function.

Functionality



When the system detects a vehicle in the side blind zone while driving forwards, an LED will illuminate in the relevant exterior mirror.

The LED comes on immediately when being passed.

The LED comes on after a delay when passing another vehicle slowly.

Operation conditions

The following conditions must be fulfilled for proper operation:

- all vehicles are moving in the same direction and in adjacent lanes
- the speed of your vehicle is between 7 mph and 87 mph
- passing a vehicle with a speed difference of less than 6 mph
- another vehicle is passing with a speed difference of less than 15 mph
- the traffic flow is normal
- driving on a straight or slightly curved road
- the vehicle is not pulling a trailer
- the sensors are not covered by mud, ice or snow
- the warning zones in the exterior mirrors or the detection zones on front and rear bumper are not covered

No alert will be given in the following situations:

- in the presence of non-moving objects, e.g. parked vehicles, barriers, street lamps, road signs
- in very dense traffic, when moving vehicles might be confused with a stationary object
- with vehicles moving in the opposite direction
- driving on a winding road or a sharp corner
- when passing or being passed by a very long vehicle, e.g. lorry, coach, which is at the same time detected at the rear in the blind spot angle and present in the driver's forward field of vision
- when passing too quickly

Deactivation

Info Display without touchscreen

Press .

Info Display with touchscreen

The system is deactivated in the vehicle personalisation  127.



 extinguishes in the instrument cluster. Additionally, an acoustic signal sounds.

The state of the system is stored when switching off the ignition.

The system is automatically deactivated when connecting a trailer or bike carrier.

Due to adverse weather conditions such as heavy rain, false detections may occur.

Fault

In the event of a fault,  flashes for a few moments in the instrument cluster, accompanied by  and a display message. Have the cause of the fault remedied by a workshop.

Panoramic view system

This system allows views of the vehicle's surroundings to be displayed as a nearly 180° picture in the Info display, like a bird's eye view.

The system uses:

- rear camera, installed in the tailgate
- ultrasonic parking assist sensors in the rear bumper

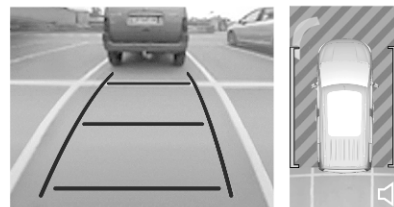

The screen in the Info Display is divided into two parts. On the right there is a view from above the vehicle, and on the left there is the view from the rear displayed. The parking sensors complete the information on the view from above the vehicle.

Change the volume of the acoustic signals by pressing  in the right lower zone of the display.

Activation

Panoramic view system is activated by:

- engaging reverse gear
- driving up to 6 mph

Functionality

Different views can be selected in the left part of the display. Change the type of view at any time during a manoeuvre by touching in the left lower zone of the display:

- **Standard view**
- **AUTO Mode**
- **Zoom view**
- **180° view**

The display is immediately updated with the type of view selected.

AUTO Mode is activated by default. In this mode, the system selects the best view, standard or zoom, to display according to the information from the parking sensors.

The state of the system is not kept in memory when the ignition is switched off.

Rear view / Standard view

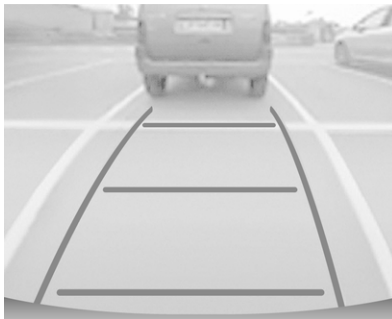

The area behind the vehicle is displayed in the screen. The vertical lines represent the width of the vehicle with mirrors unfolded. The direction of the lines changes with the position of the steering wheel.

The first horizontal line represents a distance of about 30 cm beyond the edge of vehicle's rear bumper. The upper horizontal lines represent distances of about 1 and 2 m beyond the edge of the vehicle's rear bumper.

This view is available in **AUTO Mode** or in the view selection menu.

Rear zoom view / Zoom view



The camera records the vehicle's surroundings during the manoeuvre in order to reconstruct a view from above the rear of the vehicle in its near surroundings, allowing the vehicle to be manoeuvred around obstacles nearby. This view is available with **AUTO Mode** or in the view selection menu.

Rear side view / 180° view

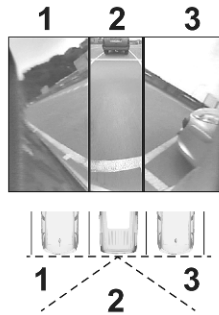

The 180° view facilitates reversing out of a parking bay, making it possible to see the approach of vehicles, pedestrians and cyclists. This view is not recommended for carrying out a complete manoeuvre. It is made up of three areas: left 1, centre 2 and right 3. This view is available from the view selection menu only.

Deactivation

Panoramic view system is deactivated when:

- driving faster than 6 mph
- seven seconds after disengaging reverse gear
- by pressing the icon ← in the left upper corner of the touch screen and then ✕
- opening the tailgate
- connecting a trailer or a bike carrier

General information

Warning

The panoramic view system does not replace driver vision. It will not display children, pedestrians, cyclists, crossing traffic, animals, or any other objects outside of the camera view area, e. g. below the bumper, or underneath the vehicle.

Do not drive or park the vehicle using only the panoramic view system.

Always check the surrounding of the vehicle before driving.

Displayed images may be further or closer than they appear. The area displayed is limited and objects that are close to either edge of the bumper or under the bumper are not displayed on the screen.

System limitations

Caution

For optimal operation of the system, it is important to keep the lense of the camera in the tailgate between the number plate lights always clean. Rinse the lense with water and wipe with a soft cloth.

Do not clean the lense with a steam-jet or high-pressure jet cleaner.

The panoramic view system may not operate properly when:

- The surrounding is dark.
- The sun or the beam of headlights is shining directly into the camera lenses.
- During nighttime driving.
- Weather limits visibility, such as fog, rain, or snow.
- The camera lenses are blocked by snow, ice, slush, mud, dirt.
- The vehicle is towing a trailer.
- The vehicle had an accident.
- There are extreme temperature changes.

Rear view camera

Depending on version, camera is mounted above the license plate in the tailgate / left rear door.

Warning

The rear view camera does not replace driver vision. Note that objects that are outside the

camera's field of view and the parking assist sensors, e.g. below the bumper or underneath the vehicle, are not displayed.

Do not reverse or park the vehicle using only the rear view camera.

Always check the surrounding of the vehicle before driving.

The view of the camera is displayed in the Info Display ↻ 123 or in the interior mirror ↻ 40.

The area displayed by the camera is limited. The distance of the image that appears on the display differs from the actual distance.

Switching on

Rear view camera is automatically activated when reverse gear is engaged.

Switching off

The camera is switched off when a forward gear is engaged.

Guidelines

The area behind the vehicle is displayed in the screen. The vertical lines represent the width of the vehicle with mirrors unfolded.

The first horizontal line represents a distance of about 30 cm beyond the edge of vehicle's rear bumper. The upper horizontal lines represent distances of about 1 and 2 m beyond the edge of the vehicle's rear bumper.

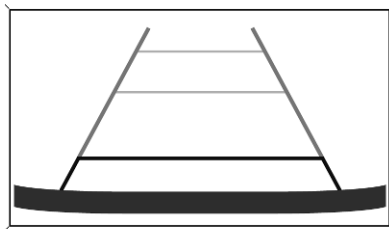

The Guidelines can be deactivated in the Vehicle personalisation ↻ 127.

System limitations

The rear view camera may not operate properly when:

- the surrounding is dark
- the beam of headlights is shining directly into the camera lenses
- weather limits visibility such as fog, rain or snow
- the camera lenses are blocked by snow, ice, slush, mud, dirt. Clean the lense, rinse with water, and wipe with a soft cloth
- the tailgate will be opened
- the vehicle is towing an electrically connected trailer, bicycle carrier etc.
- the vehicle had a rear end accident
- there are extreme temperature changes

Traffic sign assistant

The traffic sign assistant is an extension of the speed limit recognition available for speed limiter, cruise control and semi-adaptive cruise control.



The system recognises the traffic signs above and displays them in the Driver Information Centre.

⚠ Warning

The actual traffic sign always takes priority over the traffic sign displayed in the Driver Information Centre.

Speed limiter ⇨ 189.

Cruise control ⇨ 186.

Semi-adaptive cruise control ⇨ 193

Driver Information Centre ⇨ 118

Lane departure warning

The lane departure warning system observes the lane markings between which the vehicle is driving via a front camera. The system detects lane changes and warns the driver in the event of an unintended lane change via visual and acoustic signals.

Criteria for the detection of an unintended lane change are:

- no operation of turn lights
- no brake pedal operation
- no active acceleration

If the driver is active, no warning will be issued.

Activation

Info Display without touchscreen



Press  to activate the system.

The system is switched on when the LED in the button is illuminated.

Info Display with touchscreen

The system can be activated in the vehicle personalisation  127.



The system is only operable at vehicle speeds above 37 mph and if lane markings are available.

When the system recognises an unintended lane change, the control indicator  flashes yellow. Simultaneously a chime sounds.



Deactivation

Info Display without touchscreen

Press  to deactivate the system. The LED in the button  extinguishes.

Info Display with touchscreen

The system can be deactivated in the vehicle personalisation  127.

At speeds below 37 mph the system is inoperable.

Fault

Info Display without touchscreen

The LED of the  flashes.

Info Display with touchscreen

The control indicator  flashes and an error message is displayed.

Seek the assistance of a workshop.

The system cannot operate when no lane marking is detected.

System limitations

The system may not operate properly when:

- vehicle speed is below 37 mph
- driving on winding or hilly roads
- driving in the dark
- weather limits visibility, such as fog, rain, or snow
- the camera is blocked by snow, ice, slush, mud, dirt, windscreen damage or affected by foreign items, e.g. stickers
- the sun is shining directly into the camera lens
- close vehicles ahead
- banked roads
- road edges
- roads with poor lane markings
- sudden lighting changes

Driver alert

The driver alert system monitors the driving time and the vigilance of the driver. Monitoring the vigilance of the

driver is based on the trajectory variations of the vehicle compared to the lane markings.

The system cannot replace the need for vigilance on the part of the driver. Taking a break is recommended as soon as feeling tired or at least every 2 hours. Do not drive when feeling tired.

Activation or Deactivation

The system can be activated or deactivated in the vehicle personalisation ↷ 127.

The state of the system stays in memory when the ignition is switched off.

Driving time alert

The driver gets notified by a pop-up reminder symbol 🗨️ in the Driver Information Centre simultaneously with an acoustic alert if the driver has not taken a break after 2 hours of driving at a speed above 40 mph. The alert is repeated hourly until the vehicle is stopped, no matter how vehicle speed evolves.

The counting of driving time alert is reset if one of the following conditions is met:

- The vehicle has been stationary for more than 15 minutes with the engine running.
- The ignition has been switched off for a few minutes.
- The driver's seat belt has been unfastened and the driver's door is open.

Notice

If the vehicle speed drops below 40 mph, the system is paused. The driving time is counted again once the speed is above 40 mph.

Driver drowsiness detection

The system monitors the driver's level of vigilance. A camera at the top of the windscreen detects variations in trajectory compared to the lane markings. This system is particularly suited to fast roads (speed higher than 40 mph).

If the trajectory of the vehicle suggests a certain level of drowsiness or inattention by the

driver, the system triggers the first level of alert. The driver is notified by a message and an audible signal is given.

After three first level alerts, the system triggers a new alert with a message, accompanied by a more pronounced audible signal.

In certain driving conditions (poor road surface or strong winds), the system may give alerts independent of the driver's level of vigilance.

The driver drowsiness detection is reinitialised when the ignition has been switched off for a few minutes or the speed remains below 40 mph for a few minutes.

System limitations

In the following situations, the system may not operate properly or even not operate at all:

- poor visibility caused by inadequate lighting of the roadway, falling snow, heavy rain, dense fog etc.

- dazzle caused by headlamps of oncoming vehicles, low sun, reflections on damp roads, leaving a tunnel, alternating shade and light etc.
- windscreen area in front of the camera covered by dirt, snow, stickers etc.
- no lane markings detected or multiple lane markings due to roadworks
- close vehicles ahead
- winding roads or narrow roads

Charging

General information

⚠ Warning

Persons with a pacemaker should consult a doctor for possible precautions.

Charging the vehicle's high voltage battery depends upon several factors:

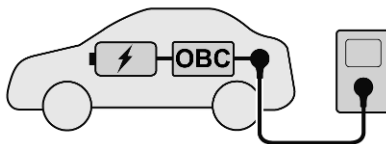

- high voltage battery of the vehicle
- internal onboard charger (OBC)
- external charging device
- charging cable

The charging cable connects the vehicle's high voltage battery with an external charging device providing electric power. This may be a

domestic electrical outlet, a Green'Up socket, a wall box or a public charging station.

The high voltage battery can be charged with direct current (DC) only. When charging from a domestic electrical outlet, a wall box or an alternating current (AC) charging station, AC has to be converted into DC. This is done by the vehicle's onboard charger. The onboard charger is available with 7 kW (single-phase) and 11 kW (3-phase).

If the vehicle is charged at a public DC charging station, no DC conversion is required. The high voltage battery can be directly charged with DC provided by the DC charging station.

The speed of charging the vehicle's high voltage battery depends upon the weakest element of the charging chain. To achieve the maximum charging speed, charging cable and charging device have to be attuned to each other.

Notice

Make sure that the charging cable used fits to the vehicle's onboard charger.

Charging types ⇨ 217.

Charging cable ⇨ 218.

Electric power consumption and range

The electric power consumption (combined) is within a range of 26.1 to 23.2 kWh/100 km for the 50 kWh high voltage battery and within a range of 27.3 to 24.4 kWh/100 km for the 75 kWh high voltage battery.

The range is up to 143 miles for the 50 kWh high voltage battery and up to 205 miles for the 75 kWh high voltage battery.

For the values specific to your vehicle, refer to the EEC Certificate of Conformity provided with your vehicle or other national registration documents.

The determination of electric power consumption is regulated by directive R (EC) No. 715/2007 and No. 2017/1151 (in the latest applicable version).

Charging types

There are different types of charging the vehicle's high voltage battery.

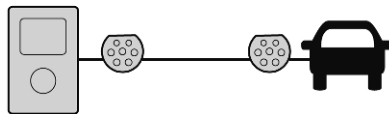

- Charging at wall boxes / public AC charging stations (mode 3 charging)

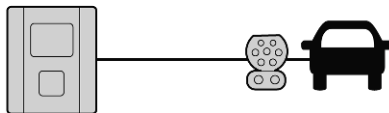

- Charging at public DC charging stations (mode 4 charging)

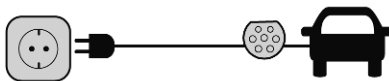

- Charging at domestic electrical outlets / Green'Up sockets (mode 2 charging)

Charging at wall boxes / public AC charging stations



A wall box is a charging unit for private households. It may provide an integrated mode 3 charging cable which has to be connected to the vehicle's charging port. For wall boxes without an integrated mode 3 charging cable, a portable mode 3 charging cable is required. This cable has to be connected to both the wall box and the vehicle's charging port.



Public AC charging stations provide a charging performance similar to that of a wall box. They may provide an integrated mode 3 charging cable which has to be connected to the vehicle's charging port. For public AC charging stations without integrated mode 3 charging cable, a portable mode 3 charging cable is required. This cable has to be connected to both the public AC charging station and the vehicle's charging port.

Charging at public DC charging stations



Public DC charging stations provide the fastest charging. To charge the vehicle's high voltage battery, the integrated mode 4 charging cable of the DC charging station has to be connected to the vehicle's charging port.

Charging at domestic electrical outlets / Green'Up sockets



The vehicle's high voltage battery can be charged at domestic electrical outlets. The domestic electrical outlet has to be installed by a certified electrician at the customer's side. For this type of charging, a basic domestic cable (mode 2) is required. This cable has to be connected to both the vehicle's charging port and the domestic electrical outlet.

The Green'Up socket provides an alternative to the domestic electrical outlet. It has to be installed by a certified electrician at the customer's side and offers a better charging performance than a domestic electrical outlet. To use a Green'Up socket, an enhanced domestic cable (mode 2) is required. This cable has

to be connected to both the vehicle's charging port and the Green'Up socket.

Charging cable

Depending on the charging type, different charging cables are used.

⚠ Warning

Improper use of portable charging cables may cause a fire, electrical shock, or burns, and may result in damage to property, serious injury, or death.

- Do not use extension cables, multi-outlet power strips, splitters, grounding adaptors, surge protectors, or similar devices.
- Do not use an electrical socket that is worn or damaged, or one that will not hold the plug firmly in place.
- Do not immerse the charging cable into any liquid.

- Do not use an electrical socket that is not properly grounded.
- Do not use an electrical socket that is on a circuit with other electrical loads.

⚠ Warning

Read all the safety warnings and instructions before using this product. Failure to follow the warnings and the instructions may result in electric shock, fire, and / or serious injury.

Never leave children unattended near the vehicle while the vehicle is charging and never allow children to play with the charging cable.

If the plug provided does not fit the electrical outlet, do not modify the plug. Arrange for a qualified electrician to inspect the electrical outlet.

Do not put fingers into the electric vehicle connector.

⚠ Danger

There is a risk of electric shock that may cause personal injury or death.

Do not use the charging cable if any part of the charging cable is damaged.

Do not open or remove the charging cable cover.

Service by qualified personnel only. Connect the charging cable to a properly grounded outlet with cables that are not damaged.

Basic domestic cable (mode 2) / enhanced domestic cable (mode 2)

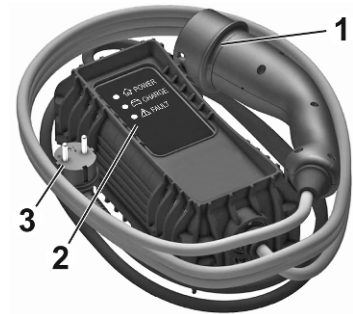

1. Vehicle plug
2. Status indicators
3. Wall plug

Basic domestic cables (mode 2) are used for charging at domestic electrical outlets. A basic domestic cable (mode 2) consists of a vehicle plug, a control box and a plug for the domestic electrical outlet. The control box has an integrated charge controller and several LEDs indicating the charging status.

Enhanced domestic cables (mode 2) are similar to basic domestic cables (mode 2). However, the charging performance of enhanced domestic cables (mode 2 charging) is better than the charging performance of basic domestic cables (mode 2). Enhanced domestic cables (mode 2) are used at Green'Up sockets which have to be installed by a certified electrician at the customer's site.

Charging cable status indicators

After plugging in the charging cable, it will perform a quick self test and all status indicators illuminate for a moment. For the functions of the status indicators, refer to the manual of the manufacturer of the charging cable.

Important information about portable electric vehicle charging

- Charging an electric vehicle can stress a building's electrical system more than a typical household appliance.

- Before you plug in to any electrical outlet, have a qualified electrician inspect and verify the electrical system (electrical outlet, wiring, junctions and protection devices) for heavy-duty service at a 10 A continuous load.
- Electrical outlets may wear out with normal usage or be damaged over time, making them unsuitable for electric vehicle charging.
- Check the electrical outlet / plug while charging and discontinue use if the electrical outlet / plug is hot, then have the electrical outlet serviced by a qualified electrician.
- When outdoors, plug into an electrical outlet that is weather-proof while in use.
- Mount the charging cable to reduce strain on the electrical outlet / plug.

Mode 3 charging cable



1. Vehicle plug
2. Plug for wall box / AC charging station

Mode 3 charging cables are used for charging at wall boxes and AC charging stations. A mode 3 charging cable provides a vehicle plug and a plug for the wall box / AC charging station. Wall boxes / AC charging stations may provide an integrated mode 3 charging cable. For more information on the mode 3 charging cable, refer to the manual of the manufacturer of the charging cable.

Mode 4 charging cable

Notice

Only use DC charging cables shorter than 30 metres.

Mode 4 charging cables are used for DC charging. Since mode 4 charging cables are integrated within DC charging stations, they only provide a vehicle plug.

Charging

This section describes the steps for charging an electric vehicle. The steps differ depending on the respective charging type.

In order to ensure the compatibility of plug and outlet, different labels are used. The labels are located on the inside of the vehicle's charging port flap. Make sure to connect only a cable of the same type.



Type 2 plug or outlet used for AC charging



FF plug or outlet used for DC charging

Charging at wall boxes

1. Shift into P and switch off the vehicle.



2. Push the charging port flap to release it.

3. Take the mode 3 charging cable out of the load compartment.
4. Plug in the wall box plug of the mode 3 charging cable into the the corresponding port of the wall box.

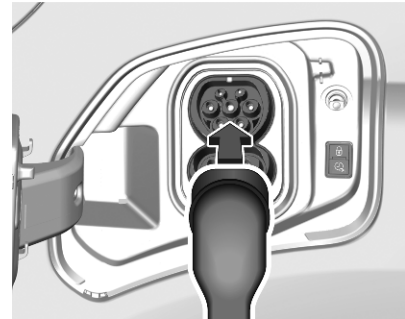

5. Plug in the vehicle plug of the mode 3 charging cable into the charging port of the vehicle.
Charging status ⇨ 226.

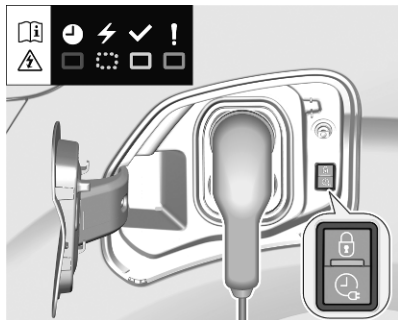

The start of charging is indicated by the green flashing of the status indicator at the charging port.

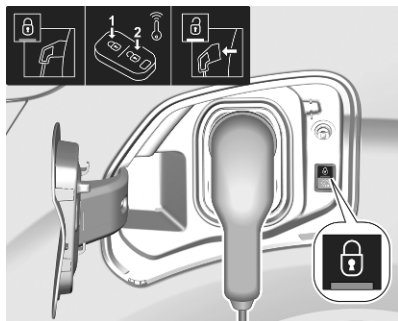



Once charging, the vehicle plug will be locked to the charging port and cannot be disconnected while charging is active.  indicator illuminates.

Charging types ⇨ 217.

Charging at public AC charging stations / public DC charging stations

When charging at a public AC charging station / public DC charging station, follow the instructions for the use of the respective charging station. Public AC charging stations may not provide an integrated charging cable. In this case, a portable mode 3 charging cable is required.

To interrupt the charging process, unlock the vehicle by pressing  on the remote control. If selective unlocking is activated, press  on the remote control two times. If the vehicle is already unlocked, press the  indicator at the charging port and keep it pressed. Public DC charging station may also provide an function to interrupt the charging process.

Charging types ⇨ 217.

Charging at domestic electrical outlets / Green'Up sockets

Warning

Only use a domestic electrical outlet which is properly grounded and protected by a 30 mA differential switch.

Only use a domestic electrical outlet protected by a circuit breaker adapted to the amperage of the electrical circuit.

Have a qualified electrician check the electrical installation to be used. The installation has to be in compliance with national standards and compatible with the vehicle.

When using a dedicated domestic electrical outlet, have it installed by a qualified electrician.

Make sure that the electrical outlet, the plug and the cable do not support the weight of the control box.

A charging cable used to charge the vehicle's high voltage battery is stored under the rear floor storage cover in the load compartment.

1. Shift into **P** and switch off the vehicle.



2. Push the charging port flap to release it.
3. Take the charging cable out of the load compartment. For charging at a domestic electrical outlet, a basic domestic cable (mode 2) is required. For charging at a Green'Up socket, an enhanced domestic cable (mode 2) is required.

4. Plug the charging cable into the domestic electrical outlet / Green'Up socket.

Verify the charging cable status.
Charging cable ↪ 218.

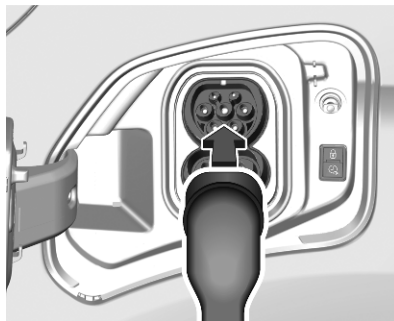

5. Plug in the vehicle plug of the charging cable into the charging port of the vehicle.
Charging status ↪ 226.

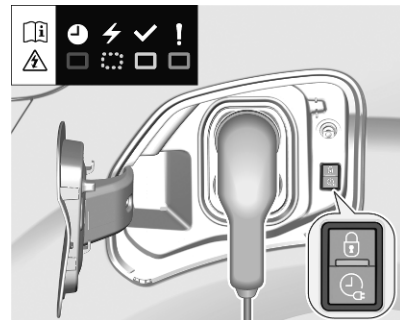

The start of charging is indicated by the green flashing of the status indicator at the charging port and at the control box of the charging cable.

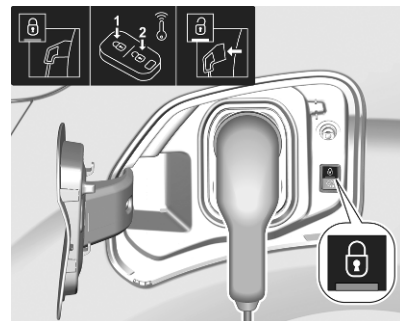

Once charging, the vehicle plug will be locked to the charging port and cannot be disconnected while charging is active.  indicator illuminates.

Cancelling the charging process

Notice

At public charging stations, the cancelling and subsequent resuming of the charging process may cause additional costs.

Once the charging process has started, the doors can only be unlocked without cancelling the charging process by previously activating selective unlocking.

Press  on the remote control to cancel the charging process at any time.

Press  twice to to cancel the charging process at any time if selective locking is activated.

Central locking system \rightarrow 24

Stop charging

Warning

After the end of the charging progress:

- Disconnect the charging cable from the charging port of the vehicle.
- Make sure the charging port flap is closed.
- Always disconnect the charging cable from the domestic electrical outlet.
- Avoid any entry of fluids into the charging port of the vehicle, the vehicle plug of the charging cable and the domestic electrical outlet.

The high voltage battery is fully charged if the status indicator on the charging port permanently illuminates green.

1. Unlock the vehicle before removing the vehicle plug from the charging port.

If the vehicle is already unlocked, lock the vehicle and unlock it again.

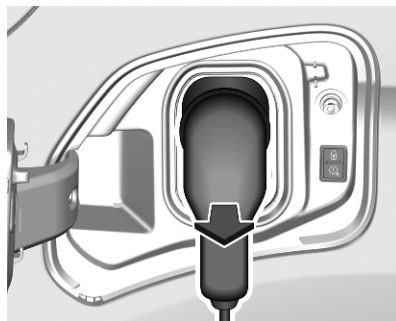

2. Disconnect the vehicle plug of the charging cable from the charging port within 30 seconds after unlocking.
3. Close the charging port flap by pressing firmly in the centre to latch properly.
4. If charging at a wall box / public AC charging station, disconnect the charging cable from the wall box / public AC charging station. If charging at a domestic electrical outlet / Green'Up socket,

disconnect the charging cable from the domestic electrical outlet / Green'Up socket.

While the charging cable is plugged into the vehicle, the vehicle cannot be driven.

Programmable charging

By default, charging starts as soon as the charging cable is connected to the charging port of the vehicle. It is also possible to schedule charging using the Info Display.

This function is also available via the MyVauxhall App.

Programmable charging is only possible when charging at a domestic electrical outlet / Green'Up socket or a wall box.





1. Press .
2. Select **Charge**.

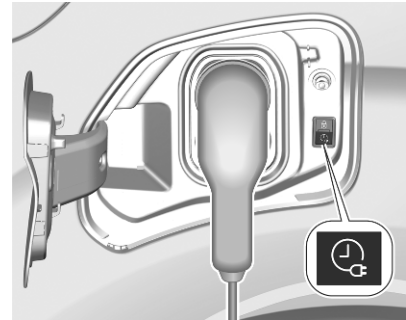

3. Press .

4. Define the number of hours and minutes after which the loading process starts.
5. Press **OK**.
6. Plug in the vehicle.



7. Within 1 minute, press  to activate programmable charging.

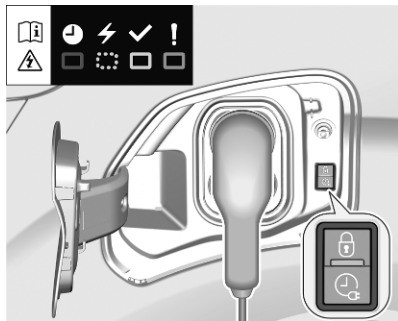

The status indicator illuminates blue indicating that programmable charging is active.

Charging ⇨ 221.

Charging status ⇨ 226.

Charging status

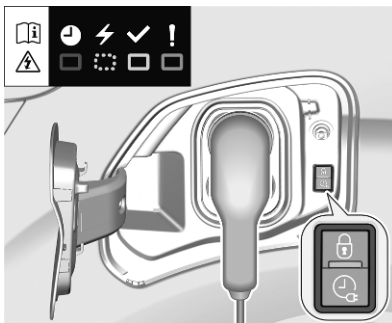

If the vehicle is plugged in and the ignition is switched off, the charging status indicator indicates the following:

- Illuminates white: welcome lighting when charging port flap is opened
- Illuminates green: charging complete
- Flashes green: charging in process
- Illuminates red: charging fault
- Illuminates blue: programmable charging active

A charging fault has occurred if the vehicle is plugged in and the charging status indicator is off.

Further charging status indicators are located on the control box of the basic domestic cable (mode 2) / enhanced domestic cable (mode 2).

Programmable charging ⇨ 225.

Charging cable ⇨ 218.

Fuel

Fuel for diesel engines

The Diesel engines are compatible with bio-fuels that conform to current and future European standards and can be obtained from filling stations:



Diesel fuel that meets standard EN590 mixed with a biofuel that meets standard EN14214 (possibly containing up to 7% Fatty Acid Methyl Ester)



Diesel fuel that meets standard EN16734 mixed with a biofuel that meets standard EN14214 (possibly containing up to 10% Fatty Acid Methyl Ester)



Paraffinic Diesel fuel that meets standard EN15940 mixed with a biofuel that meets standard EN14214 (possibly containing up to 7% Fatty Acid Methyl Ester).



The use of B20 or B30 fuel meeting standard EN16709 is possible. However, this use, even occasional, requires strict application of the special servicing conditions referred to as "Arduous conditions".

For more information, contact a dealer or a qualified workshop.

Caution

The use of any other type of (bio) fuel (vegetable or animal oils, pure or diluted, domestic fuel etc.) is strictly prohibited (risk of damage to the engine and fuel system).

Notice

The only Diesel additives authorised for use are those that meet the B715000 standard.

Low temperature operation

At temperatures below 0 °C, some diesel products with biodiesel blends may clog, freeze or gel, which may affect the fuel supply system. Starting and engine operation may not work properly. Make sure to fill winter grade diesel fuel at ambient temperatures below 0 °C.

Arctic grade diesel fuel can be used at extremely low temperatures below -20 °C. Using this fuel grade in warm or hot climates is not recommended

and may cause engine stalling, poor starting or damage on the fuel injection system.

Refuelling

Danger

Before refuelling, switch off ignition and any external heaters with combustion chambers.

Follow the operating and safety instructions of the filling station when refuelling.

Danger

Fuel is flammable and explosive. No smoking. No naked flames or sparks.

If a smell of fuel can be noticed inside the vehicle, have the cause of this remedied immediately by a workshop.

A label with symbols at the fuel filler flap is indicating the allowed fuel types. In Europe the pump nozzles of

the filling stations are marked with these symbols. Refuel only the allowed fuel type.

Caution

In case of misfuelling, do not switch on ignition.

Fuel filler flap is located at left rear side of vehicle.

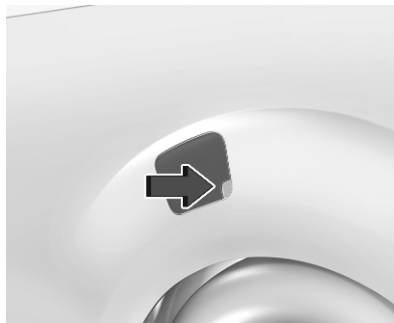

If the vehicle is equipped with an electronic key system, the fuel filler flap can only be opened if the vehicle is unlocked. Depending on the

version, release the fuel filler flap by pushing the flap or pulling at the right bottom corner.

Depending on the version, place the key in the lock and unlock the cap.

To open, turn the cap slowly anticlockwise.

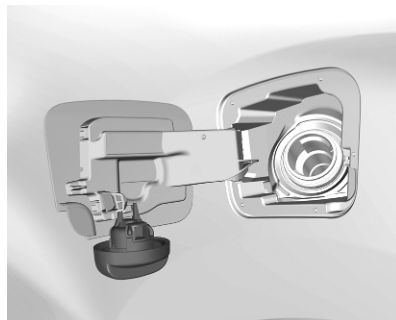

The fuel filler cap can be attached to the hook on the fuel filler flap.

Place the nozzle in straight position to the filler neck and press with slight force to insert.

To refuel, switch on pump nozzle.

After the automatic cut-off, the tank can be topped up by operating the pump nozzle a maximum of two more times.

Caution

Wipe off any overflowing fuel immediately.

To close, turn the fuel filler cap clockwise until it clicks.

Close the flap and allow it to engage.

Fuel filler cap

Only use genuine fuel filler caps.

Diesel-engined vehicles have special fuel filler caps.

Fuel consumption - CO₂-Emissions

The fuel consumption (combined) is within a range of 26 to 48 mpg.

The CO₂ emission is within a range of 289 to 156 g/km.

General information

For the values specific to your vehicle, refer to the EEC Certificate of Conformity provided with your vehicle or other national registration documents.

The determination of fuel consumption is regulated by directive R (EC) No. 715/2007 and No. 2017/1151 (in the latest applicable version).

The specification of CO₂ emission is also a constituent of the directive.

The figures given must not be taken as a guarantee for the actual fuel consumption of a particular vehicle. Furthermore, fuel consumption is dependent on personal driving style as well as road and traffic conditions.

All values are based on the EU base model with standard equipment.

The calculation of fuel consumption takes into account the vehicle's kerb weight, ascertained in accordance with the regulations. Optional equipment may result in slightly

higher fuel consumption and CO₂ emission levels and a lower maximum speed.

Trailer hitch

General information

Only use towing equipment that has been approved for the vehicle.

Entrust retrofitting of towing equipment to a workshop. It may be necessary to make changes that affect the cooling system, heat shields or other equipment.

Driving characteristics and towing tips

Before attaching a trailer, lubricate the coupling ball. However, do not do so if a stabiliser, which acts on the coupling ball, is being used to reduce snaking movements.

During trailer towing do not exceed a speed of 50 mph. A maximum speed of 60 mph is only appropriate if an oscillation damper is used and the permissible gross trailer weight does not exceed the vehicle's curb weight.

For trailers with low driving stability and caravan trailers, the use of an oscillation damper is strongly recommended.

If the trailer starts snaking, drive more slowly, do not attempt to correct the steering and brake sharply if necessary.

When driving downhill, drive in the same gear as if driving uphill and drive at a similar speed.

If the outside temperature exceeds 37 °C, reduce the load on the trailer to protect the engine of the vehicle.

At high outside temperatures it is recommended to leave the engine running for one or two minutes after having stopped the vehicle in order to facilitate cooling.

Adjust tyre pressure to the value specified for full load ⇨ 296.

Towing a trailer increases the braking distance of the vehicle. To limit the heating of the brakes, it is recommended to use the braking effect of the engine.

By driving uphill, the temperature of the coolant is increased. To reduce heating, drive at a reduced speed and pay attention to the coolant temperature. If the control indicator ● of the engine coolant temperature gauge illuminates, stop the vehicle and switch off engine as soon as possible.

Trailer towing

Trailer loads

The permissible trailer loads are vehicle and engine-dependent maximum values which must not be exceeded. The actual trailer load is the difference between the actual gross weight of the trailer and the actual coupling socket load with the trailer coupled.

The permissible trailer loads are specified in the vehicle documents. In general, they are valid for gradients up to 12%.

The permissible trailer load applies up to the specified incline and at sea level. Since engine power decreases as altitude increases due to the air

becoming thinner, therefore reducing climbing ability, the permissible gross train weight also decreases by 10% for every 1000 metres of altitude. The gross train weight does not have to be reduced when driving on roads with slight inclines (less than 8%, e.g. motorways).

The permissible gross train weight must not be exceeded. This weight is specified on the identification plate ↻ 289.

When distributing the loads in the trailer, heavy objects should be placed as close as possible to the axle.

Vertical coupling load

The vertical coupling load is the load exerted by the trailer on the coupling ball. It can be varied by changing the weight distribution when loading the trailer.

The maximum permissible vertical coupling load is specified on the towing equipment identification plate and in the vehicle documents.

Always aim for the maximum vertical coupling load, especially in the case of heavy trailers. The vertical coupling load should never fall below 25 kg.

Rear axle load

When the trailer is coupled and the towing vehicle fully loaded, the permissible rear axle load (see identification plate or vehicle documents) may be exceeded by 60 kg, the gross vehicle weight rating must not be exceeded. If the permissible rear axle load is exceeded, a maximum speed of 60 mph applies.

Towing equipment

Depending on version the vehicle can be fitted with a detachable or a fixed coupling ball bar.

Type A

Caution

When operating without a trailer, remove the coupling ball bar.

Fitting the coupling ball bar

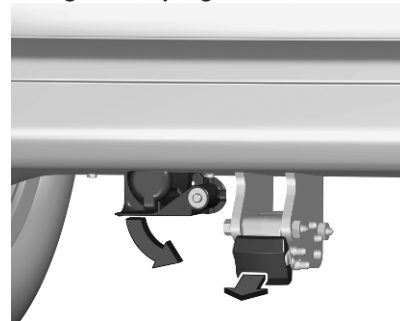

1. Swivel the connecting socket downwards. Take off the cap.

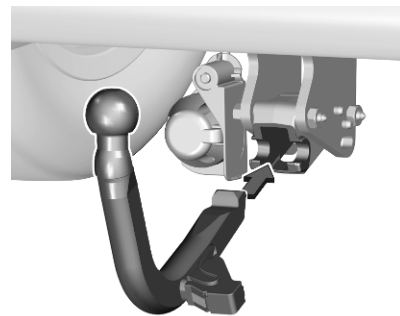

2. Insert the coupling ball bar into the opening and push firmly up to the stop.

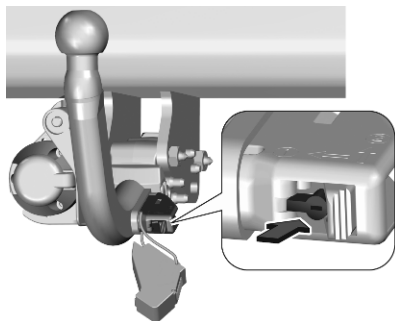

3. Insert the plug lock in the opening and lock it with the corresponding key.
4. Put on the cap.
5. Attach the trailer.

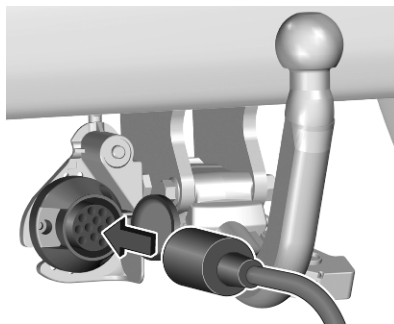

6. Connect the trailer plug to the socket.

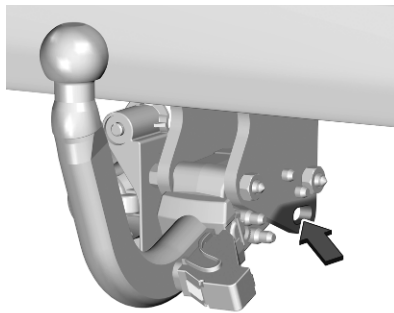

7. Attach the breakaway stopping cable to the eye on the carrier.

⚠ Warning

Towing a trailer is permitted only when a coupling ball bar is fitted correctly. If the coupling ball bar does not engage correctly, seek the assistance of a workshop.

Dismounting coupling ball bar

1. Disconnect the trailer plug.
2. Unfasten the breakaway stopping cable.
3. Remove the trailer.

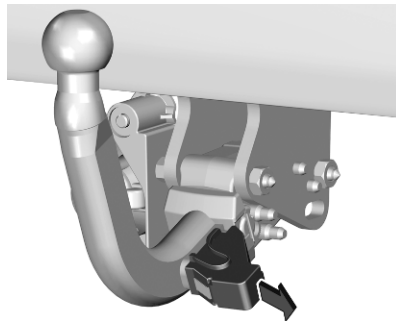

4. Take off the cap.

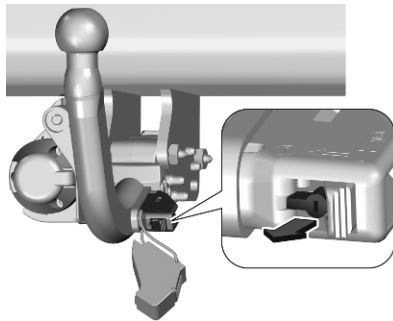

5. Insert the key in the plug lock, unlock it and remove it from the opening.

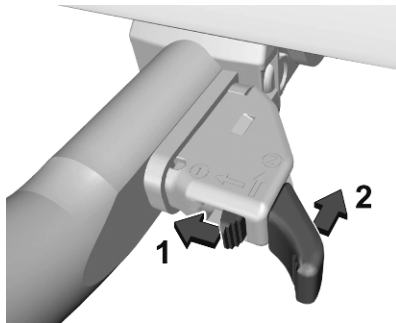

6. Move 1 to left and hold it pressed, push 2 to the back and remove the coupling ball.
7. Swivel the connecting socket upwards. Put on the cap.

Type B

1. Swivel the connecting socket downwards.
2. Attach the trailer.

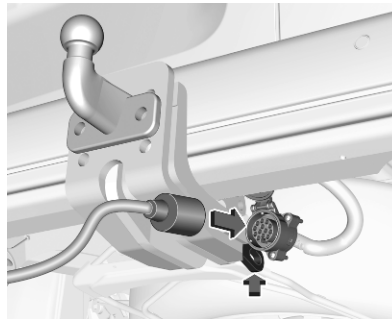

3. Connect the trailer plug to the socket and fasten the breakaway stopping cable to the eye on the carrier.

Type C

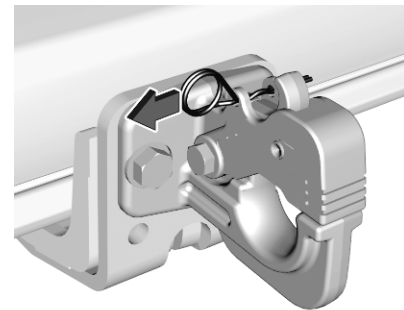

1. Remove the safety splint.

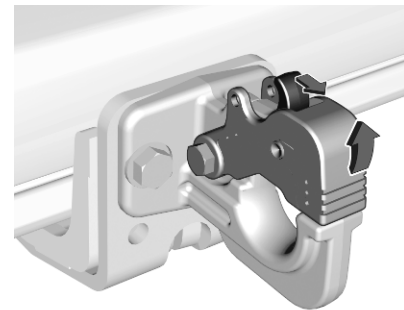

2. Pull the lever and open the towing ring.

3. Swivel the connecting socket downwards.
4. Attach the trailer, close the towing ring and fix the splint.

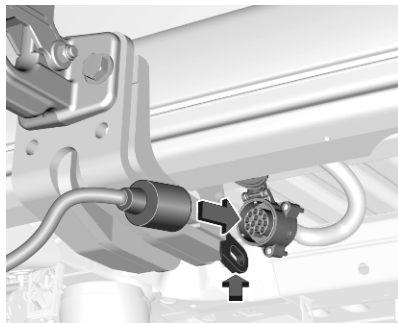

5. Connect the trailer plug to the socket and attach the breakaway stopping cable to the eye on the carrier.

Type D

1. Swivel the connecting socket downwards.
2. Attach the trailer.

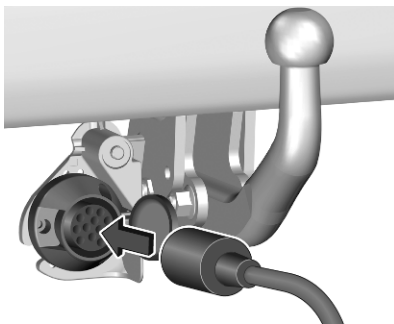

3. Connect the trailer plug to the socket and fasten the breakaway stopping cable to the eye on the carrier.

Trailer stability assist

If the system detects snaking movements, engine power is reduced and the vehicle / trailer combination is selectively braked until the snaking ceases. While system is working keep steering wheel as still as possible.

Trailer stability assist is a function of the Electronic Stability Control ↗ 183.

Vehicle care

General Information 236

- Accessories and vehicle modifications 236
- Vehicle storage 236
- End-of-life vehicle recovery 238

Vehicle checks 238

- Performing work 238
- Bonnet 239
- Engine oil 240
- Engine coolant 241
- Washer fluid 242
- Brakes 242
- Brake fluid 242
- Vehicle battery 242
- Diesel fuel system bleeding 244
- Wiper blade replacement 245

Bulb replacement 246

- Halogen headlights 246
- Xenon headlights 249
- Front fog lights 250
- Front turn lights 251
- Tail lights 252
- Side turn lights 254
- Centre high-mounted brake light 254

- Number plate light 255
- Interior lights 256

Electrical system 256

- Fuses 256
- Engine compartment fuse box 257
- Instrument panel fuse box 258

Vehicle tools 260

- Tools 260

Wheels and tyres 262

- Winter tyres 262
- Tyre designations 263
- Tyre pressure 263
- Tyre deflation detection system 264
- Tread depth 265
- Changing tyre and wheel size 266
- Wheel covers 266
- Tyre chains 266
- Tyre repair kit 267
- Wheel changing 270
- Spare wheel 271

Jump starting 276

Towing 277

- Towing the vehicle 277
- Towing another vehicle 279

Appearance care 280

- Exterior care 280

- Interior care 281
- Floor mats 282

General Information

Accessories and vehicle modifications

We recommend the use of genuine parts and accessories and factory approved parts specific for your vehicle type. We cannot assess or guarantee reliability of other products - even if they have a regulatory or otherwise granted approval.

Any modification, conversion or other changes made to standard vehicle specifications (including, without limitation, software modifications, modifications of the electronic control units) may invalidate the warranty offered by Vauxhall. Furthermore, such changes may affect driver assistance systems, may impact fuel consumption, CO₂ emissions and other emissions of the vehicle and cause the vehicle to no longer conform to the operating permit, impacting the validity of your vehicle registration.

Caution

When transporting the vehicle on a train or on a recovery vehicle, the mud flaps might be damaged.

Cold protection covers

In order to prevent the accumulation of snow at the radiator cooling fan, it is recommended to install removable protection covers.

The protection covers must be professionally installed, consult a workshop.

Caution

The protection covers must be removed when one of the following conditions occurs:

- The ambient temperature is above 10 °C.
- When the vehicle is towed.
- The vehicle is driven at speeds above 75 mph.

Vehicle storage

Storage for a long period of time (non-electric vehicle)

If the vehicle is to be stored for several months:

- Wash and wax the vehicle.
- Have the wax in the engine compartment and underbody checked.
- Clean and preserve the rubber seals.
- Fill up fuel tank completely.
- Change the engine oil.
- Drain the washer fluid reservoir.
- Check the coolant antifreeze and corrosion protection.
- Adjust tyre pressure to the value specified for full load.
- Park the vehicle in a dry, well ventilated place. Engage first or reverse gear or set selector lever to **P**. Prevent the vehicle from rolling.
- Do not apply the parking brake.

- Open the bonnet, close all doors and lock the vehicle.
- Disconnect the clamp from the negative terminal of the vehicle battery. Note that all systems are not functional, e.g. anti-theft alarm system.

Storage for a long period of time (electric vehicle)

If the vehicle is to be stored for several months:

- Wash and wax the vehicle.
- Have the wax in the engine compartment and underbody checked.
- Clean and preserve the rubber seals.
- Drain the washer fluid reservoir.
- Check the coolant antifreeze and corrosion protection.
- Adjust tyre pressure to the value specified for full load.

- Park the vehicle in a dry, well ventilated place. Engage first or reverse gear or set selector lever to **P**. Prevent the vehicle from rolling.
- Do not apply the parking brake.
- Open the bonnet, close all doors and lock the vehicle.

Up to four weeks

Plug in the charging cable.

Four weeks to twelve months

- Discharge the high voltage battery until 30 percent remain on the battery range indicator (battery symbol) on the instrument cluster.
- Do not plug in the charging cable.
- Always store the vehicle in a place with temperatures between $-10\text{ }^{\circ}\text{C}$ and $30\text{ }^{\circ}\text{C}$.
- Vehicle storage at extreme temperatures may cause damage to the high voltage battery.
- Remove the black negative (-) cable from the 12 V vehicle battery and attach a trickle charger to the vehicle battery

terminals or keep the 12 V vehicle battery cables connected and trickle charge from the positive (+) and negative (-) terminals in the engine compartment.

- Every three months, check the battery's state of charge. If the state of charge is below 30 percent, recharge the battery to 30 percent.

Putting back into operation (non-electric vehicle)

When the vehicle is to be put back into operation:

- Connect the clamp to the negative terminal of the vehicle battery. Initialize the power windows ↷ 41.
- Check tyre pressure.
- Fill up the washer fluid reservoir.
- Check the engine oil level.
- Check the coolant level.
- Fit the number plates if necessary.

Putting back into operation (electric vehicle)

When the vehicle is to be put back into operation:

- Connect the clamp to the negative terminal of the 12 V vehicle battery. Initialise the power windows ⇨ 41.
- Check tyre pressure.
- Fill up the washer fluid reservoir.
- Check the coolant level.
- Fit the number plate if necessary.

End-of-life vehicle recovery

Information on end-of-life vehicle recovery centres and the recycling of end-of-life vehicles is available on our website, where legally required. Only entrust this work to an authorised recycling centre.

Vehicle checks

Performing work

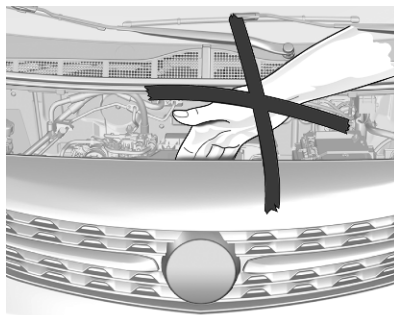

⚠ Warning

Only perform engine compartment checks when the ignition is off.
The cooling fan may start operating even if the ignition is off.

⚠ Danger

The ignition system uses extremely high voltage. Do not touch.



⚠ Danger

Electric or hybrid versions:

Never try to perform maintenance work on high voltage components yourself. You may be injured and the vehicle may be damaged. Service and repair of these high voltage components should only be performed by a trained service technician with proper knowledge and tools. Exposure to high voltage may cause shock, burns, and even death. The high voltage

components in the vehicle can only be serviced by technicians with special training.

High voltage components are identified by labels. Do not remove, open, take apart, or modify these components. High voltage cable or wiring has orange covering. Do not probe, tamper with, cut, or modify high voltage cable or wiring.

⚠ Warning

Electric or hybrid versions:
Only perform engine compartment checks when the vehicle is off.
The cooling fan may start operating even if the vehicle is off.

Caution

Electric or hybrid versions:
Even small amounts of contamination to the liquids can cause damage to vehicle systems.

Do not allow contaminants to contact the fluids, reservoir caps, or dipsticks.

Bonnet

Opening

Open the driver's door.

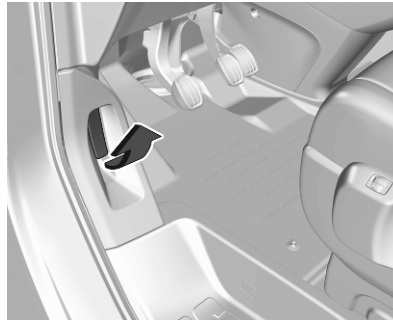

Pull the release lever and return it to its original position.



Push the safety catch upwards and open the bonnet.

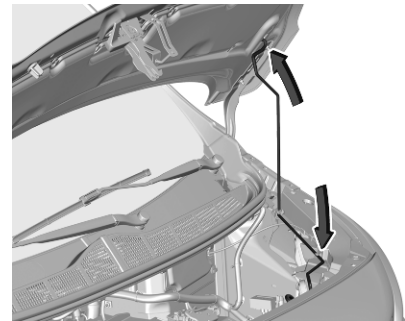

Secure the bonnet support.

Closing

Before closing the bonnet, press the support into the holder.

Lower the bonnet and let it fall into the latch from a low height (20-25 cm). Check that the bonnet is engaged.

Caution

Do not press the bonnet into the latch to avoid dents.

Engine oil

Check the engine oil level manually on a regular basis to prevent damage to the engine. Ensure that the correct specification of oil is used.

Recommended fluids and lubricants
⇨ 287.

The maximum engine oil consumption is 0.6 l per 600 miles.

Check with the vehicle on a level surface. The engine must be at operating temperature and switched off for at least 5 minutes.

Caution

It is the owner's responsibility to maintain the proper level of an appropriate quality oil in the engine.

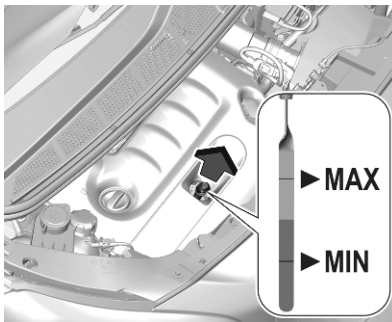

Different dipsticks are used depending on engine variant.

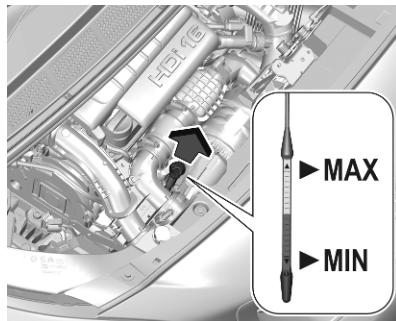

Pull out the dipstick, wipe it clean, reinsert it fully, pull out and read the engine oil level.

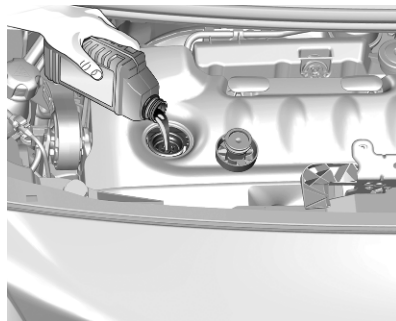

When the engine oil level has dropped to the **MIN** mark, top up the engine oil.

We recommend the use of the same grade of engine oil that was used at last change.

The engine oil level must not exceed the **MAX** mark on the dipstick.

Caution

Overfilled engine oil must be drained or suctioned out. If the oil exceeds the maximum level, do not start the vehicle and contact a workshop.

Capacities ⇨ 295.

Fit the cap on straight and tighten it.

Engine coolant

The factory filled coolant provides freeze protection down to approx. -37 °C.

Caution

Only use approved antifreeze.

Coolant and antifreeze ⇨ 287.

Coolant level

Caution

Too low a coolant level can cause engine damage.

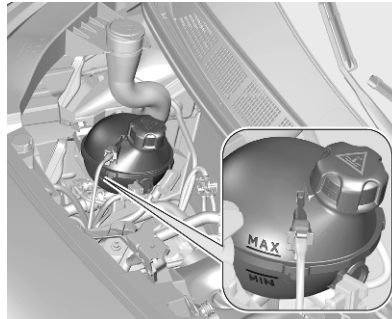

If the cooling system is cold, the coolant level should be above the **MIN** mark. Top up if the level is low.

⚠ Warning

Allow the engine to cool before opening the cap. Carefully open the cap, relieving the pressure slowly.

To top up, use a 1:1 mixture of released coolant concentrate mixed with clean tap water. If no coolant concentrate is available, use clean tap water. Install the cap tightly. Have the coolant concentration checked and have the cause of the coolant loss remedied by a workshop.

Washer fluid

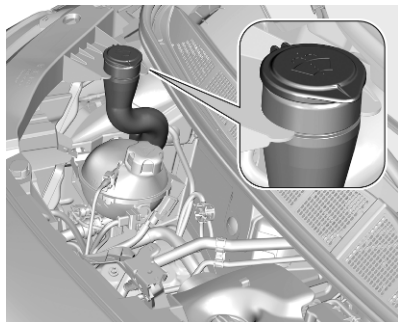

Fill with clean water mixed with a suitable quantity of approved windscreen washer fluid which contains antifreeze.

Caution

Only washer fluid with a sufficient antifreeze concentration provides protection at low temperatures or a sudden drop in temperature.

Washer fluid ⇨ 287.

Brakes

In the event of minimum thickness of the brake lining, a squealing noise sounds during braking.

Continued driving is possible but have the brake lining replaced as soon as possible.

Once new brake linings are installed, do not brake unnecessarily hard for the first few journeys.

Brake fluid

⚠ Warning

Brake fluid is poisonous and corrosive. Avoid contact with eyes, skin, fabrics and painted surfaces.

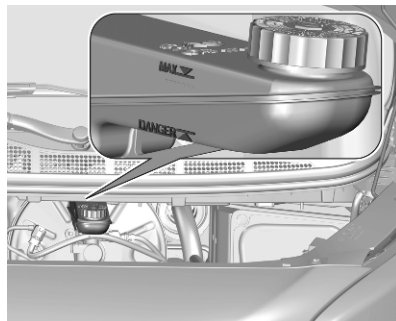

The brake fluid level must be between the **DANGER** and **MAX** marks.

If fluid level is below **DANGER**, seek the assistance of a workshop.

Brake and clutch fluid ⇨ 287.

Vehicle battery

The vehicle battery is maintenance-free provided that the driving profile allows sufficient charging of the battery. Short-distance-driving and frequent engine starts can discharge the battery. Avoid the use of unnecessary electrical consumers.



Batteries do not belong in household waste. They must be disposed of at an appropriate recycling collection point.

Laying up the vehicle for more than four weeks can lead to battery discharge. Disconnect the clamp from the negative terminal of the vehicle battery.

Ensure the ignition is switched off before connecting or disconnecting the vehicle battery.

Battery discharge protection ⇨ 143.

Replacing the vehicle battery

Notice

Any deviation from the instructions given in this section may lead to temporary deactivation or disturbance of the stop-start system.

When the vehicle battery is being replaced, please ensure that there are no open ventilation holes in the vicinity of the positive terminal. If a ventilation hole is open in this area, it must be closed off with a dummy cap, and the ventilation in the vicinity of the negative terminal must be opened.

Ensure that the battery is always replaced by the same type of battery.

The vehicle battery has to be replaced by a workshop.

Stop-start system ⇨ 163.

Charging the vehicle battery

⚠ Warning

On vehicles with stop-start system, ensure that the charging potential does not exceed 14.6 V when using a battery charger. Otherwise the vehicle battery may be damaged.

Jump starting ⇨ 276.

Discharge protection

Battery voltage

When the vehicle battery voltage is running low, a warning message will appear in the Driver Information Centre.

When the vehicle is being driven, the load reduction function temporarily deactivates certain functions, such as the air conditioning, the heated rear window, heated steering wheel, etc.

The deactivated functions are reactivated automatically as soon as conditions permit.

Idle boost

If charging of the vehicle battery is required due to battery condition, the power output of the generator must be increased. This will be achieved by an idle boost which may be audible.

A message appears in the Driver Information Centre.

Power outlet

The power outlets are deactivated in the event of low vehicle battery voltage.

Warning label



Meaning of symbols:

- No sparks, naked flames or smoking.
- Always shield eyes. Explosive gases can cause blindness or injury.
- Keep the vehicle battery out of reach of children.
- The vehicle battery contains sulphuric acid which could cause blindness or serious burn injuries.

- See the Owner's Manual for further information.
- Explosive gas may be present in the vicinity of the vehicle battery.

Heating functionalities

Notice

Individual heating functionalities, such as heated seats or heated steering wheel, may be temporarily unavailable in the event of electrical loading constraints. Functions will be resumed after some minutes.

Power saving mode

This mode deactivates electrical consumers to avoid excessive discharging of the vehicle battery. These consumers, such as the Infotainment system, windscreen wipers, low beam headlights, courtesy light, etc. can be used for a total maximum time of about 40 minutes after ignition is switched off.

Deactivating power saving mode

Power saving mode is deactivated automatically when the engine is restarted. Run the engine for a sufficient charge:

- for less than 10 minutes to use the consumers for approx. 5 minutes
- for more than 10 minutes to use the consumers for up to approx. 30 minutes

Diesel fuel system bleeding

If the tank has been run dry, the diesel fuel system must be bled. The bleeding procedure differs between the engine types ⇨ 293. Fuel up with at least five litres of diesel before starting the bleeding procedure.

Engines DV5RUCd, DV5RUC

1. Switch on the ignition.
2. Wait 1 minute and switch off the ignition.
3. Try to start the engine.

If the engine does not start after a short time, repeat the procedure.

Engines DW10FEU, DW10FD, DW10FDCU, DW10F

1. Switch on the ignition.
2. Wait 6 seconds and switch off the ignition.
3. Repeat steps 1 and 2 for ten times.
4. Try to start the engine.

If the engine does not start after a short time, repeat the procedure.

Engine DV6DU

1. Open the engine bonnet.
2. If necessary, unclip the engine style cover to access the priming pump.
3. Operate the priming pump repeatedly until resistance is felt (there may be resistance at the first press).
4. Try to start the engine. If the engine does not start after a short time, wait around 15 seconds before trying again. If the engine does not start after a few attempts, repeat step 3 and try again to start the engine.
5. Put the engine style cover in place and clip it in.

6. Close the bonnet.

Wiper blade replacement

Windscreen

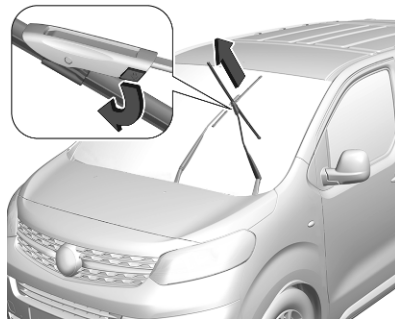

Switch off the ignition.

Within 1 minute after switching off the ignition, operate the wiper lever to position the wiper blades vertically on the windscreen.

Lift the wiper arm until it stays in the raised position, disengage and remove the wiper blade.

Attach the wiper blade to the wiper arm and push until it engages.

Lower the wiper arm carefully.

Rear window

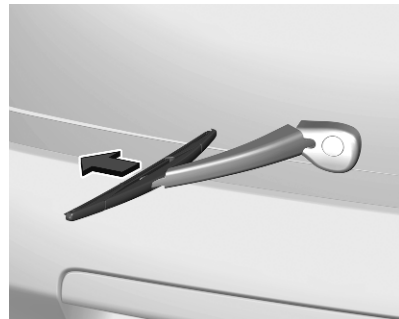

Lift the wiper arm. Disengage the wiper blade as shown in the illustration and remove.

Attach the wiper blade slightly angled to the wiper arm and push until it engages.

Lower the wiper arm carefully.

Bulb replacement

Before replacing a bulb, ensure that all exterior and interior lights and the ignition are switched off. All doors have to be closed.

Only hold a new bulb at the base. Do not touch the bulb glass with bare hands.

Use only the same bulb type for replacement.

Replace headlight bulbs from within the engine compartment.

Bulb check

After a bulb replacement switch on the ignition, operate and check the lights.

Halogen headlights

Front turn lights ⇨ 251.

Illustrations show the right headlight unit.

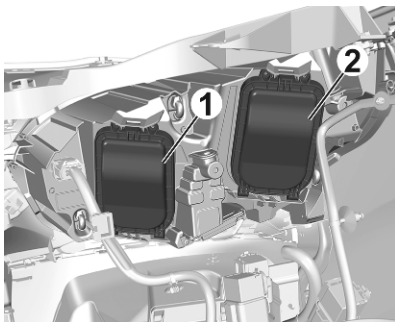

Low beam bulb sits in outer chamber (2)

High beam bulb sits in inner chamber (1)

Parking light bulb sits in inner chamber (1)

Daytime running light bulb sits in outer chamber (2)

Low beam

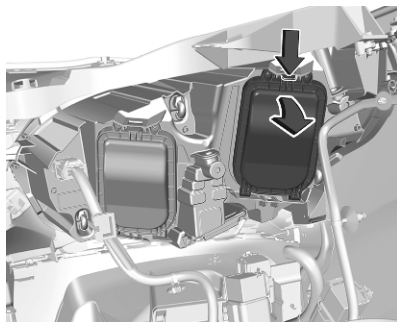

1. Remove the protective cover.

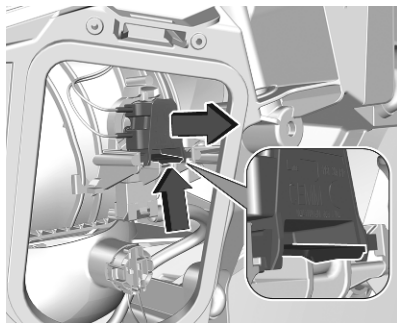

2. Press latch and remove the bulb socket from reflector housing.

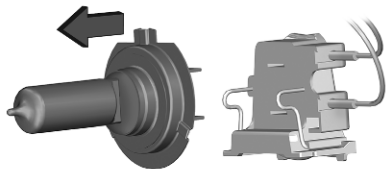

3. Detach the bulb from the bulb socket and replace the bulb.
4. Insert the bulb socket into the reflector housing.
5. Fit the cover.

High beam

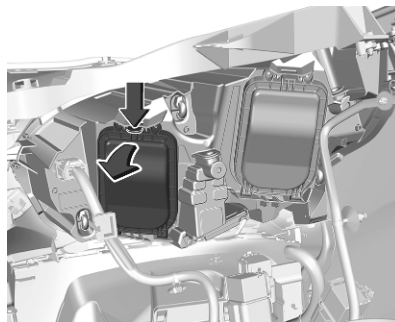

1. Remove the protective cover.

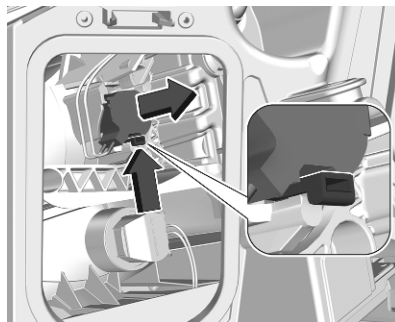

2. Press latch and remove the bulb socket from reflector housing.

Withdraw the bulb holder from the reflector housing.

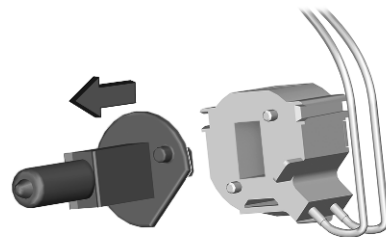

3. Detach the bulb from the bulb socket and replace the bulb.
4. Insert the bulb socket into the reflector housing.
5. Fit the cover.

Parking light

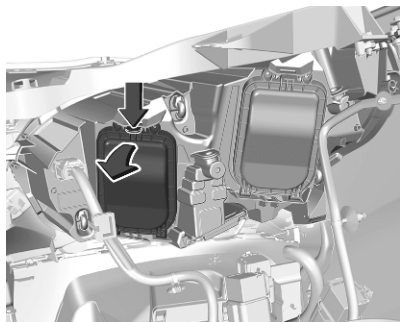

1. Remove the protective cover.

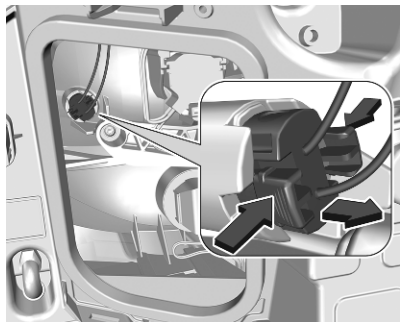

2. Press the clips on the bulb socket to disengage and withdraw socket from the reflector.

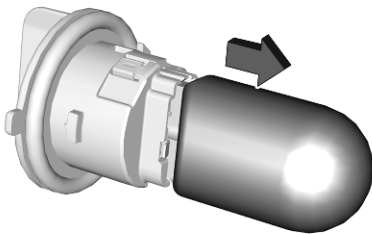

3. Remove the bulb from the socket by pulling.
4. Replace and insert the new bulb into the socket.
5. Insert the bulb socket into the housing.

Daytime running light

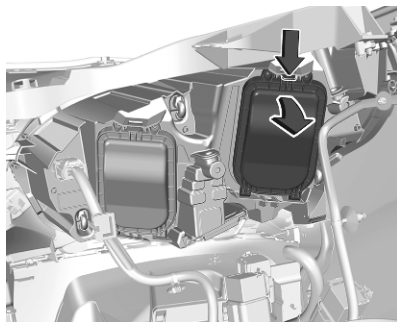

1. Remove the protective cover.

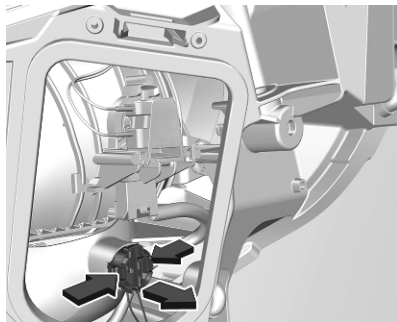

- Press the clips on the bulb socket to disengage and withdraw socket from the reflector.

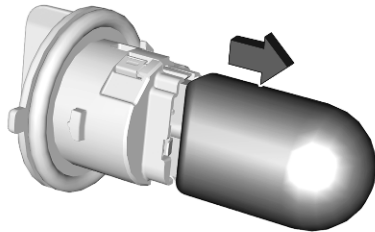

- Remove the bulb from the socket by pulling.
- Replace and insert the new bulb into the socket.
- Insert the bulb socket into the housing.

Daytime running light with LEDs

The daytime running light unit in the lower bumper area is designed with LEDs. In case of defective LEDs, have them replaced by a workshop.

Xenon headlights

Front turn lights ⇨ 251.

Illustrations show the right headlight unit.

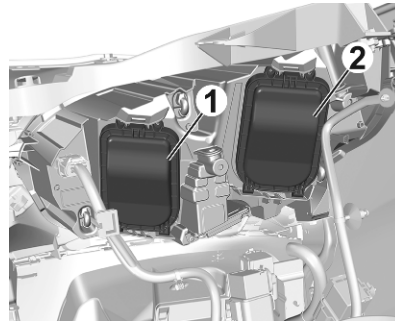

Low beam bulb sits in outer chamber (2)

High beam bulb sits in inner chamber (1)

Low beam

⚠ Danger

Xenon headlights work under extremely high electrical voltage. Do not touch. Have bulbs replaced by a workshop.

High beam

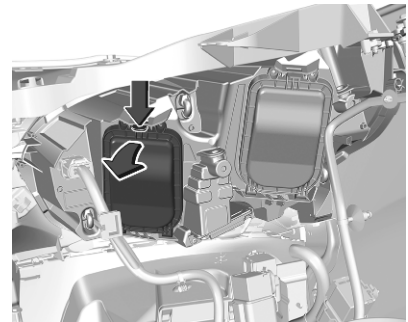

- Remove the protective cover.

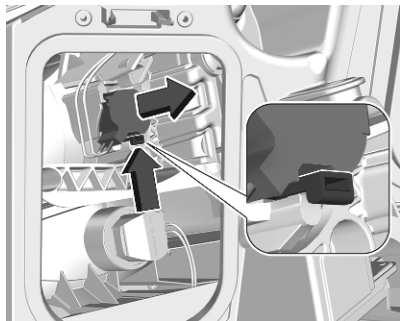

2. Press latch and remove the bulb socket from reflector housing.
Withdraw the bulb holder from the reflector housing.

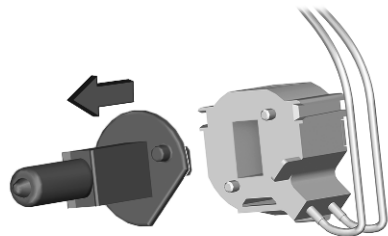

3. Detach the bulb from the bulb socket and replace the bulb.
4. Insert the bulb socket into the reflector housing.
5. Fit the cover.

Front fog lights

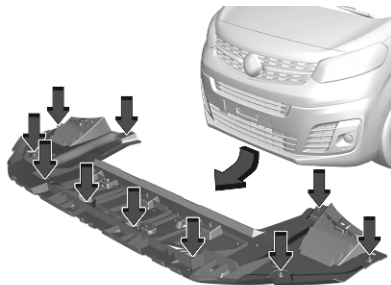

1. Unscrew and remove the underfloor cover.

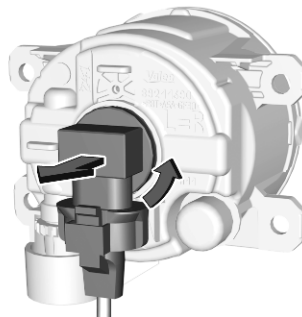

2. Turn the bulb socket anticlockwise and remove it from the light assembly.

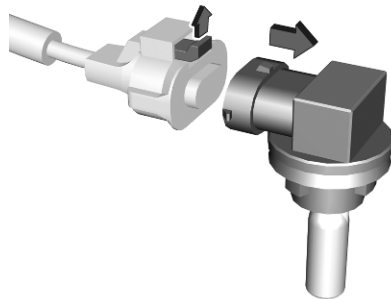

3. Disengage the plug connector by pulling the retaining lug.

4. Remove and replace the bulb unit and attach the plug connector. Note that the bulb and the socket are one unit and have to be changed together.
5. Insert the bulb socket into the light assembly by turning clockwise and engage.
6. Mount the light assembly by tightening the two screws.
7. Attach and engage the cover.

Front turn lights

Illustrations show the right headlight unit.

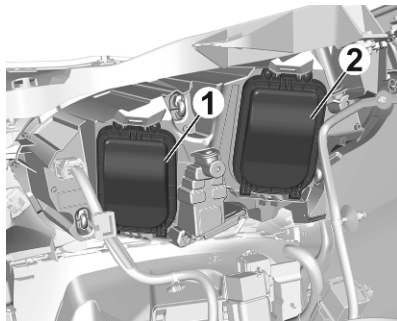

Turn light bulb sits in inner chamber (1)

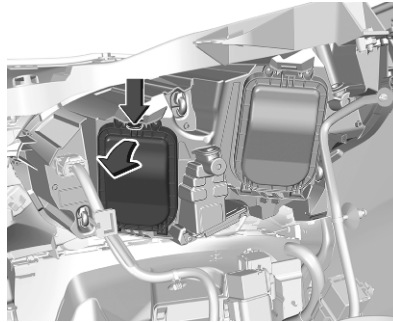

1. Remove the protective cover.

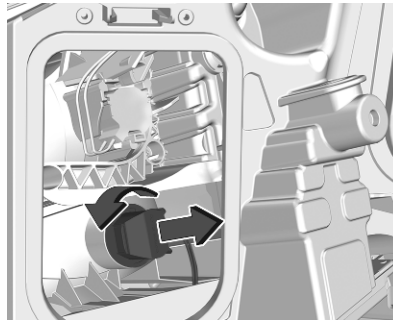

2. Rotate the bulb socket anticlockwise to disengage and withdraw from the reflector.

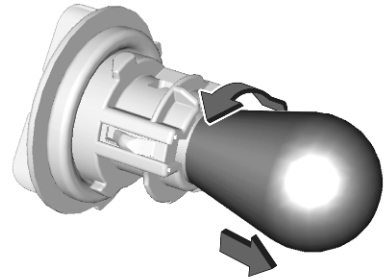

3. Slightly press down the bulb, turn it anticlockwise and remove it from the socket.
4. Replace and insert the new bulb into socket by turning clockwise.
5. Insert the bulb socket into the reflector and turn clockwise.

Tail lights

Tail light assembly

All body styles except platform cab



1. Vehicles with a cover hiding the lower tail light assembly screw: remove cover by carefully releasing its retaining lugs with a screwdriver and tilting the cover slightly towards the outside.



2. Unscrew and remove the two screws.



3. Vehicles with air vent or cover behind the tail light, in the trim: Remove air vent or cover.

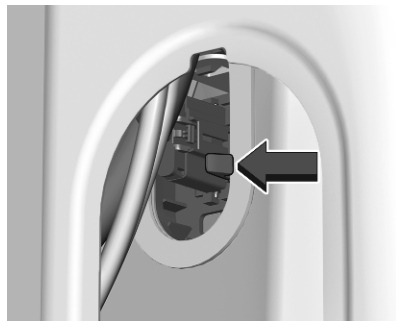

4. While holding the light assembly, push the retaining lug which holds the tail light assembly in the body.

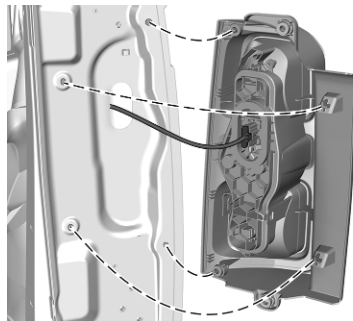

- Carefully withdraw the tail light assembly from recess and remove. Take care that the cable duct remains in position.
- Detach the cable from the retainer in the light assembly.

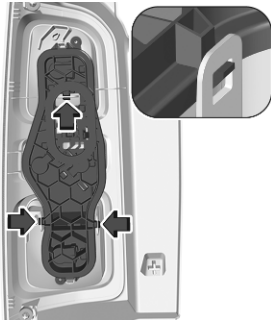

- Disengage the central retaining lug, pull the bulb carrier and disengage the remaining retaining lugs.

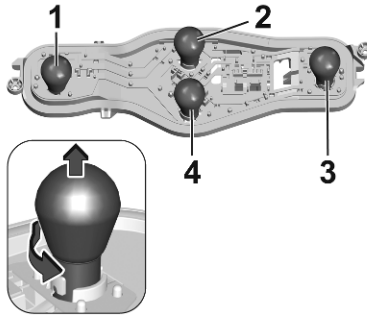

- Push the bulb slightly down, turn it and remove it from the bulb carrier. Replace the bulb:
 Tail light / parking light (1)
 Reverse light (2)
 Brake light / parking light (3)
 Turn light / hazard warning flasher (4)
- Attach the bulb carrier to the light assembly.
- Attach the cable to the retainer.
- Attach the light assembly to the vehicle body and tighten both screws.

- Clip in cover which may have covered the lower tail light assembly screw.
- Attach cover or air vent behind the tail light if removed before.

Platform Cab

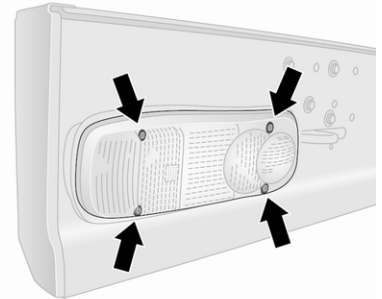

- Remove the four screws from the lens.
- Remove lens from the aperture.

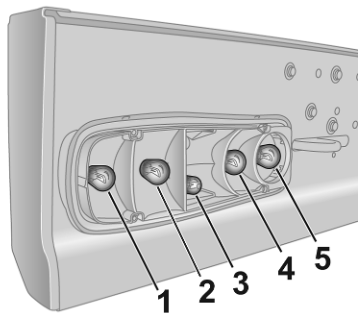

3. Push bulb into socket slightly, rotate anticlockwise, remove and renew bulb.

Turn light (1)

Brake light (2)

Tail light (3)

Reversing light (4)

Rear fog light, may be on one side only (5)

4. Install lens in aperture and replace the four screws.

Side turn lights

To replace the bulb, remove the light housing:

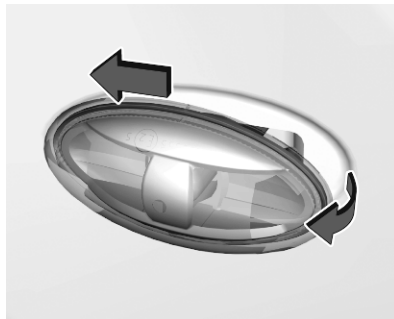

1. Slide the lamp housing forward and remove it at the back. It may help to use a screwdriver to lever out the light housing from the body. Wrap the tip of the screwdriver with a cloth to prevent paint damage.

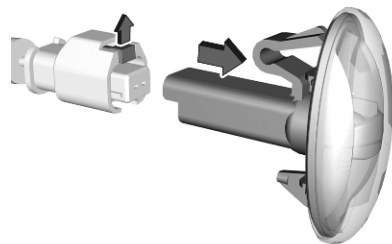

2. Pull the retaining lug upwards and remove the bulb socket from the plug connector.
3. Replace the complete unit.
4. Insert left end of the lamp, slide to the left and insert right end.

Centre high-mounted brake light

Vehicles with hinged doors or tailgate

1. Open the rear doors.

2. a) vehicles with tailgate:

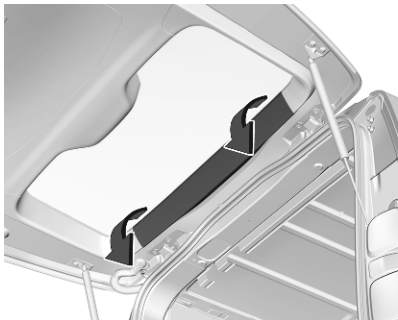

Loose the inner trim from clips by swiveling it upwards and downwards. Pull trim off carefully.

b) vehicles with hinged doors:



- Wrap a cloth around the tip of a slot screwdriver to prevent paint damage. Remove the inner cover or air vent with the screwdriver.
- Push the brake light assembly carefully out through the recess.
 - Detach the cable from the retainer in the light assembly.

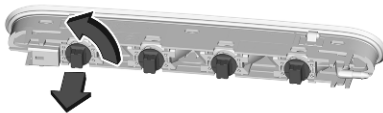

- Remove the socket of the defect bulb by turning it a quarter turn anti-clockwise.
- Renew bulb.
- Install brake light assembly like explained above, in reversed order.

Number plate light

1. a) vehicles with tailgate:



Insert a thin screwdriver, e.g., in one of the recesses of the cover and push it outwards to unclip it. Remove the cover.

b) vehicles with hinged doors:

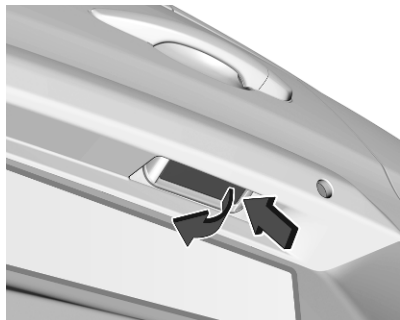

Insert a screwdriver in one of the recesses of the cover and lever it out. Remove the cover.

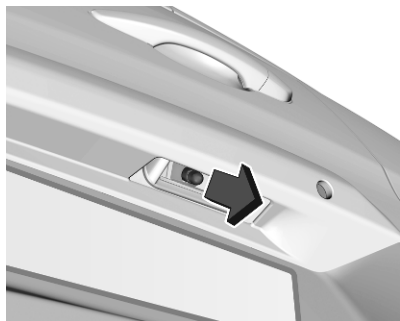

2. Pull the bulb from the bulb holder and replace it.
3. Attach the cover.

Interior lights

Have the following lights replaced by a workshop:

- courtesy light, reading lights
- load compartment light
- instrument panel illumination

Electrical system

Fuses

Data on the replacement fuse must match the data on the defective fuse.

There are two fuse boxes in the vehicle:

- engine compartment
- instrument panel

Before replacing a fuse, turn off the respective switch and the ignition.

A blown fuse can be recognised by its melted wire.

Caution

Do not replace the fuse until the cause of the fault has been remedied.

Some functions are protected by several fuses.

Fuses may also be inserted without existence of a function.

Fuse extractor

A fuse extractor may be located behind the passenger compartment fuse box cover:

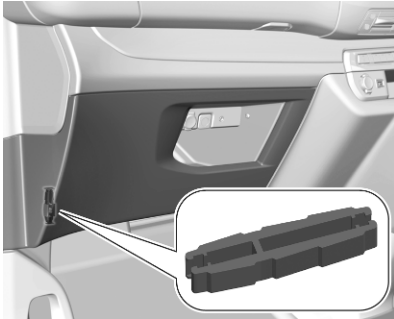

Unclip the cover by pulling at the top left, then right. Disengage the cover completely and turn it over.

The extractor has two sides, each side is designed for a different type of fuses.

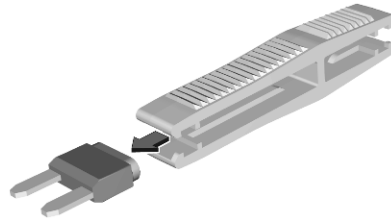

Grab the fuse with the fuse extractor and withdraw the fuse.

Engine compartment fuse box

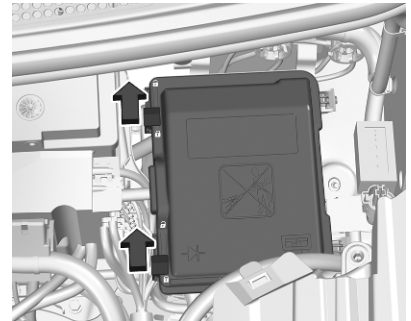

The fuse box is in the front left of the engine compartment.

Disengage the cover and remove it.

No. Circuit

- 12 Heated washer jets
- 14 Front and rear screenwash pump
- 15 Front radar system, electric power steering
- 17 Built-in systems interface

No. Circuit

- 19 Front wiper motor
- 20 Front and rear screenwash pump
- 21 Headlight wash pump
- 22 Horn
- 23 Right high beam
- 24 Left high beam

After having changed defective fuses, close the fuse box cover and lock it. If the fuse box cover is not closed correctly, malfunction may occur.

Instrument panel fuse box

The fuse box is located behind a cover in the instrument panel at the left side.

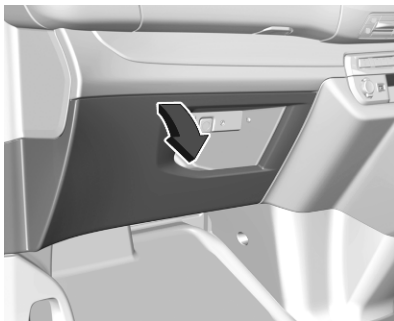

Remove the cover by pulling at the top left, then at the right side.

Version 1 (Eco)

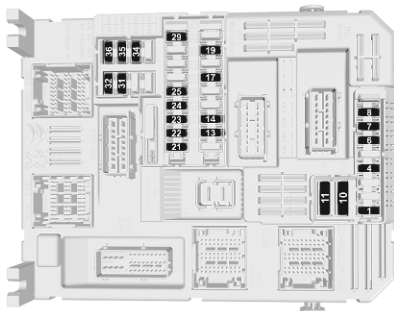

No. Circuit

- 1 Clutch switch, power steering
- 4 Horn
- 5 Front and rear screenwash pump
- 6 Front and rear screenwash pump
- 7 Rear power outlet
- 8 Rear window wipers
- 10/11 Central locking system
- 13 Head-up display, climate controls, Infotainment system controls, gear selector
- 14 Anti-theft alarm system, telematic unit
- 17 Instrument cluster
- 19 Steering wheel controls
- 21 Anti-theft system or electronic key system
- 22 Front camera, rain and light sensor

No.	Circuit
23	Seat belt reminder
24	Parking assist, Infotainment system, rear view camera
25	Airbags
29	Infotainment system
31	Infotainment system (+ battery)
32	Front power outlet
34	Interior mirror, blind spot monitoring system, door mirror controls
35	Heated washer jets, headlight range adjustment
36	Interior lights, torch charger

Version 2 (Full)

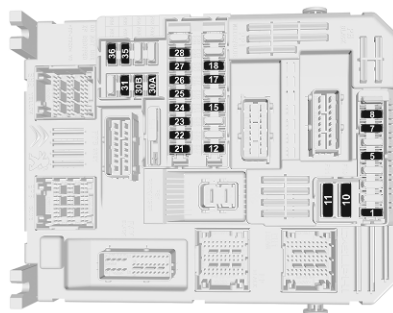

No.	Circuit
1	Anti-theft system or electronic key system
5	Parking assist, Infotainment system, rear view camera
7	Rear climate controls, audio system amplifier
8	Rear window wipers
10/11	Central locking system
12	Anti-theft alarm system

No.	Circuit
17	Rear power outlet
18	Telematic unit
21	Interior lights, torch charger
22	Interior lights, glovebox light
23	Blind spot monitoring system, door mirror controls
24	Steering wheel controls
25	Headlight range adjustment
26	Seat belt reminder
27	Front camera, rain and light sensor
28	Head-up display, front climate controls, Infotainment system controls, gear selector
30A or 30B	Audio system (+ battery)

No.	Circuit
31	Airbag
33	Front power outlet
35	Instrument cluster
36	Infotainment system

Vehicle tools

Tools

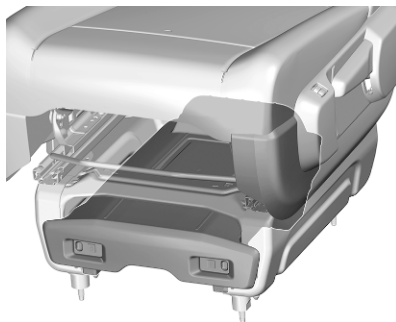

The tools are located in the box underneath the left front seat.

Opening of the box

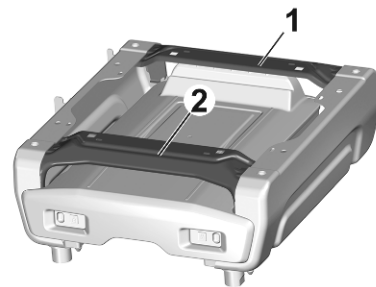

1. The box is secured by two bars which prevent its escaping from its housing, if it is not stowed correctly.

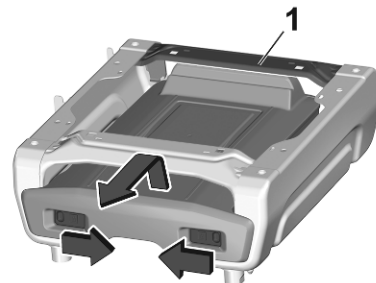

2. Press latches and slide them inwards to release the box. Lift the box slightly to release it from bar 2.
1. Pull it out.

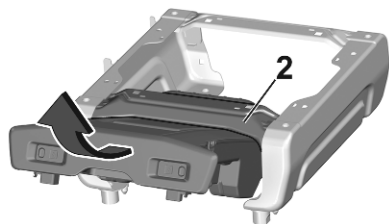

3. Lift the box upwards to take it past bar 2.

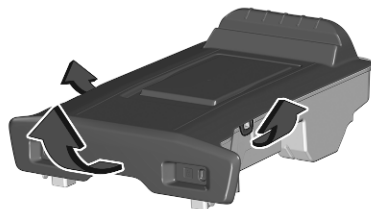

4. Unclip retainers on the box cover and open it.

Stowing the box

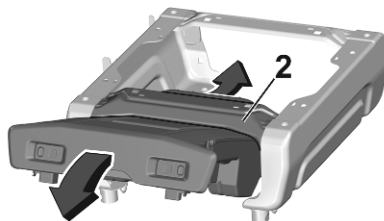

1. Insert the box with the front inclined upwards. To take it past bar 2, push the box in and down.

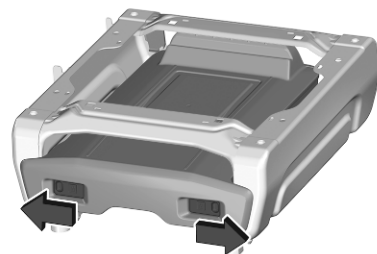

2. Once the box is in the housing, push it down and slide latches outwards to secure it.

Vehicles with spare wheel

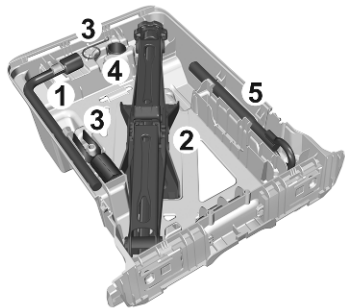

The box contains:

1. a wheelbrace for removing the wheel bolts and operating the jack.
2. a jack to raise the vehicle.
3. wheel bolt cap or hub cap removal tools. These tools are designed to remove the wheel bolt head covers on alloy wheels or the hub cap on steel wheels.
4. a wheelbrace adapter for the security wheel bolts.
5. a towing eye.

Vehicles without spare wheel

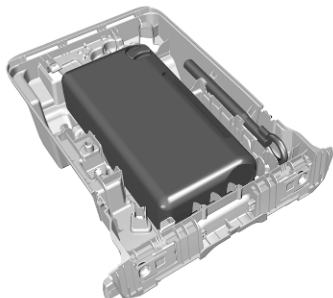

The box contains a towing eye and a tyre repair kit.

Tyre repair kit ↪ 267.

Wheels and tyres

Tyre condition, wheel condition

Drive over edges slowly and at right angles if possible. Driving over sharp edges can cause tyre and wheel damage. Do not trap tyres on the kerb when parking.

Regularly check the wheels for damage. Seek the assistance of a workshop in the event of damage or unusual wear.

Winter tyres

Winter tyres improve driving safety at temperatures below 7 °C and should therefore be fitted on all wheels.

In accordance with country-specific regulations, affix the speed sticker in the driver's field of view.

All tyre sizes are permitted as winter tyres ↪ 296.

Tyre designations

E.g. **225/55 R 18 98 V**

- 225** : tyre width, mm
55 : cross-section ratio (tyre height to tyre width), %
R : belt type: Radial
RF : type: RunFlat
18 : wheel diameter, inches
98 : load index e.g. 98 is equivalent to 750 kg
V : speed code letter

Speed code letter:

- Q** : up to 100 mph
S : up to 112 mph
T : up to 118 mph
H : up to 130 mph
V : up to 150 mph
W : up to 168 mph

Choose a tyre appropriate for the maximum speed of your vehicle. Refer to the EEC Certificate of Conformity provided with your vehicle or other national registration documents. Optional equipment could reduce the maximum speed of the vehicle.

Directional tyres

Directional tyres should be mounted so that they rotate in the correct direction. The proper rotation direction is indicated by a symbol (e.g. an arrow) on the sidewall.

Tyre pressure

Check the pressure of cold tyres at least every 14 days and before any long journey. Do not forget the spare wheel. This also applies to vehicles with tyre pressure monitoring system.

Tyre pressure ⇨ 296.

The tyre pressure data refers to cold tyres. It applies to summer and winter tyres.

Always inflate the spare tyre to the pressure specified for full load.

Incorrect tyre pressures will impair safety, vehicle handling, comfort and fuel economy and will increase tyre wear.

Tyre pressures differ depending on various options. For the correct tyre pressure value, follow the procedure below:

1. Identify the engine identifier code.
Engine data ⇨ 293.
2. Identify the respective tyre.

The tyre pressure tables show all possible tyre combinations ⇨ 296.

For the tyres approved for your vehicle, refer to the EEC Certificate of Conformity provided with your vehicle or other national registration documents.

The driver is responsible for correct adjustment of tyre pressure.

Warning

If the pressure is too low, this can result in considerable tyre warm-up and internal damage, leading to tread separation and even to tyre blow-out at high speeds.

⚠ Warning

For specific tyres the recommended tyre pressure as shown in the tyre pressure table may exceed the maximum tyre pressure as indicated on the tyre. Never exceed the maximum tyre pressure as indicated on the tyre.

Temperature dependency

The tyre pressure depends on the temperature of the tyre. During driving, tyre temperature and pressure increase. Tyre pressure values provided on the tyre information label and tyre pressure chart are valid for cold tyres, which means at 20 °C.

The pressure increases by nearly 1.5 psi for a 10 °C temperature increase. This must be considered when warm tyres are checked.

Tyre deflation detection system

The tyre deflation detection system continually checks the rotation speed of all four wheels and warns on low tyre pressure condition once vehicle is driving. This is achieved by comparing tyre rolling circumference with reference values and further signals.

If a tyre loses pressure the control indicator (⚠) illuminates, a warning chime is given and a warning message is displayed in the Driver Information Centre.

In this case reduce speed, avoid sharp cornering and strong braking. Stop at next safe opportunity and check tyre pressure.

Control indicator (⚠) ⇨ 115.

After adjusting tyre pressure initialise system to extinguish the control indicator and restart system.

Caution

Deflation detection system warns just about low tyre pressure condition and does not replace regular tyre maintenance by the driver.

In case of a system malfunction, the control indicators (⚠) and  appear at the same time or a message is displayed in the Driver Information Centre. Set correct tyre pressure and reinitialise system. If the failure continues to be displayed, contact a workshop. The system is inoperable when ABS or ESC has a malfunction or a temporary spare wheel is used. Once the road tyre has been refitted, check the tyre pressure with cold tyres and initialise the system.

System initialisation

After tyre pressure correction or wheel change, the system must be initialised to learn new circumference reference values:

1. Always ensure that all four tyres have correct tyre pressure
↪ 296.
2. Apply parking brake.
3. Start the initialisation procedure:

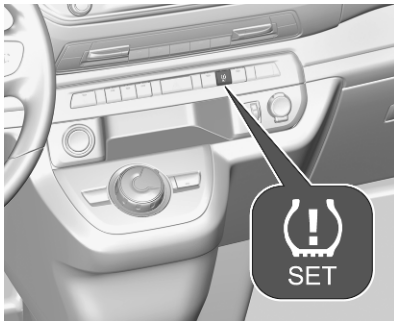

- a) Vehicles without Infotainment system: Press button (⚠) for 3 seconds. A chime confirms the start.
 - b) Vehicles with Infotainment system: Initialise the deflation detection system in the vehicle personalisation ↪ 127.
4. Reset is confirmed by pop-up indication.

After initialisation system automatically calibrates to new tyre pressures during driving. After longer drive the system will adopt and monitor new pressures.

Always check tyre pressure with cold tyres.

System has to be reinitialised when:

- Tyre pressure has been changed
- Load condition has been changed
- Wheels have been swapped or exchanged

The system will not warn instantaneously on a tyre blow out or a rapid deflation. This is due to required calculation time.

Tread depth

Check tread depth at regular intervals.

For safety reasons, it is recommended that the tread depth of the tyres on one axle should not vary by more than 2 mm.



The legally permissible minimum tread depth (1.6 mm) has been reached when the tread has worn down as far as one of the tread wear indicators (TWI). Their position is indicated by markings on the sidewall.

If there is more wear at the front than the rear, swap round front wheels and rear wheels periodically. Ensure that the direction of rotation of the wheels remains the same.

Tyres age, even if they are not used. We recommend tyre replacement every six years.

Changing tyre and wheel size

If tyres of a different size than those fitted at the factory are used, it may be necessary to reprogramme the tyre deflation detection system and make other vehicle modifications.

Tyre deflation detection system
 ⇨ 264.

Have the label with tyre pressures replaced.

⚠ Warning

The use of unsuitable tyres or wheels may lead to accidents and will invalidate the vehicle operating permit.

Wheel covers

Wheel covers and tyres that are factory approved for the respective vehicle and comply with all of the relevant wheel and tyre combination requirements must be used.

If the wheel covers and tyres used are not factory approved, the tyres must not have a rim protection ridge.

Wheel covers must not impair brake cooling.

⚠ Warning

Use of unsuitable tyres or wheel covers could lead to sudden pressure loss and thereby accidents.

Vehicles with steel wheels: When using locking wheel nuts, do not attach wheel covers.

Tyre chains

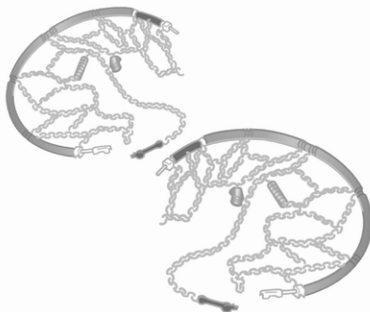

Tyre chains are only permitted on the front wheels. The use of tyre chains is not permitted on the temporary spare wheel.

Only use tyre chains designed to be used with tyre type of the vehicle:

- For 16 inch tyres, only use 12 mm link tyre chains.
- For 17 inch tyres, only use König K-Summit Van K84 tyre chains.

Notice

The use of tyre chains and the maximum allowed speed is regulated by country-specific legislation.

⚠ Warning

Damage may lead to tyre blowout.

When fitting the tyre chains follow the instructions provided by the manufacturer of the tyre chains.

After having fitted the tyre chains, stop the vehicle after having driven a short distance and make sure that the tyre chains are correctly tightened.

Tyre repair kit

Minor damage to the tyre tread can be repaired with the tyre repair kit.

Do not remove foreign bodies from the tyres.

Tyre damage exceeding 4 mm or that is at tyre's sidewall cannot be repaired with the tyre repair kit.

⚠ Warning

Do not drive faster than 50 mph.
Do not use for a lengthy period.
Steering and handling may be affected.

In the case of a flat tyre:

Apply the parking brake and engage first gear, reverse gear or **P**.

The tyre repair kit is located in the tool box underneath the left front seat.

Tool box ↻ 260.

1. Pull speed limit label from the tyre repair kit and place it in driver's visible area.

2. Pull the electrical cable and air hose out of the compartments on the underside of the kit.

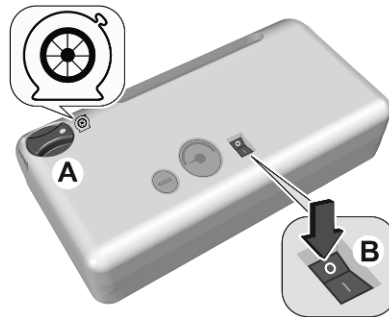

3. Turn selector **A** to the "sealant" position. Check that switch **B** is in position **O**.

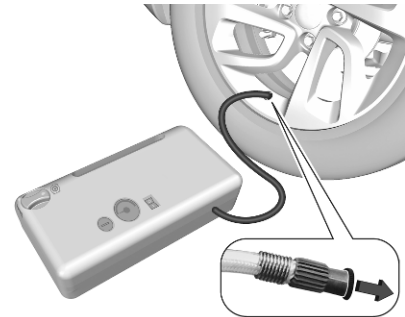

4. Uncoil the air hose fully and unscrew the cap from the end of the hose. Connect hose to the valve of the defective tyre.

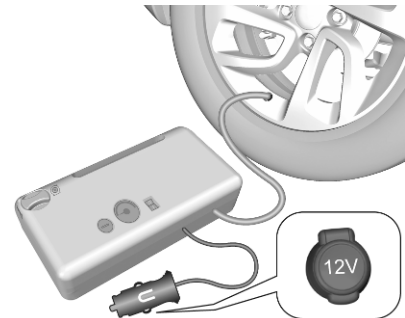

5. Connect the electrical cable to the vehicle's 12 V front power outlet
⇨ 98.

To avoid discharging the battery, we recommend running the engine.

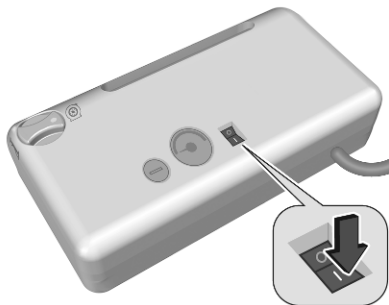

6. Set the rocker switch on the compressor to I. The tyre is filled with sealant.
7. The compressor pressure gauge briefly indicates up to 600 kPa (6 bar) whilst the sealant cartridge is emptying (approx. 30 s). Then the pressure starts to drop.

8. All of the sealant is pumped into the tyre. Then the tyre is being inflated.

9. The prescribed tyre pressure should be obtained within ten minutes.

Tyre pressure ⇨ 296.

When the correct pressure is obtained, switch off the compressor.

If the prescribed tyre pressure is not obtained within ten minutes, remove the tyre repair kit. Move the vehicle one tyre rotation. Reattach the tyre repair kit and continue the filling procedure for ten minutes. If the prescribed tyre pressure is still not obtained, the tyre is too badly damaged. Seek the assistance of a workshop.



Drain excess tyre pressure with the button.

Do not run the compressor longer than ten minutes.

10. Detach the tyre repair kit. Stow tyre repair kit in load compartment.
11. Remove any excess sealant using a cloth.

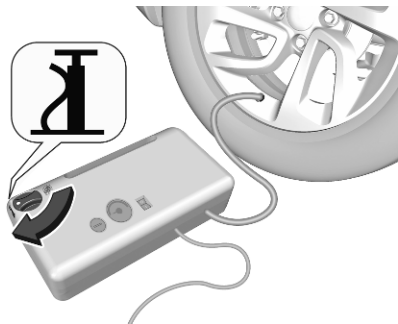

12. Start driving immediately so that sealant is evenly distributed in the tyre. After driving approx. three miles but no more than ten minutes, stop and check tyre pressure. Turn selector on the kit to the air pump symbol. Connect compressor air hose to tyre valve. Fill tyre as described before. Drain excess tyre pressure with the button on the kit.

If tyre pressure hasn't decreased under 150 kPa (1.5 bar), set it to the correct value. Otherwise the vehicle must not be used. Seek assistance of a workshop. ↪ 296

Repeat the checking procedure once more after driving further three miles but no more than ten minutes to check that there is no more loss of pressure.

If the tyre pressure has fallen below 150 kPa (1.5 bar), the vehicle must not be used. Seek the assistance of a workshop.

13. Stow away tyre repair kit in load compartment.

Notice

The driving characteristics of the repaired tyre are severely affected, therefore have this tyre replaced.

If unusual noise is heard or the compressor becomes hot, turn compressor off for at least 30 minutes.

Note the expiry date of the kit. After this date its sealing capability is no longer guaranteed. Pay attention to storage information on sealant bottle.

Replace the used sealant cartridge. Dispose of the bottle as prescribed by applicable laws.

The compressor and sealant can be used from approx. -30 °C.

Removing the pipe and cartridge

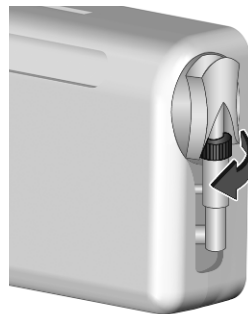

1. Turn pipe assembly to the left until it contacts the unit.

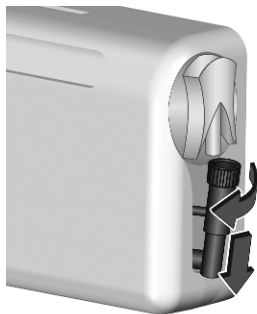

2. Disconnect the connector from the cartridge by turning it a quarter turn anti-clockwise.

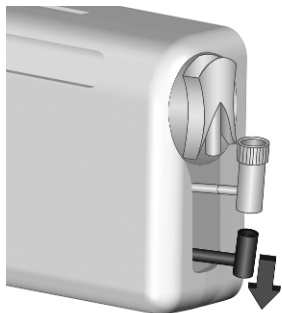

3. Pull pipe assembly out slightly, then disconnect connector from the air hose by turning it a quarter turn anticlockwise.

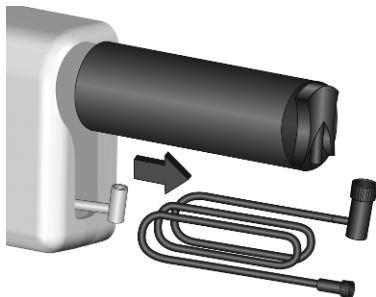

4. Remove air hose.
Keep the kit vertical and unscrew the cartridge from the bottom.
5. To fit the new cartridge and new pipe, carry out these operations in reverse order.

Wheel changing

Make the following preparations and observe the following information:

- Park the vehicle on a level, firm and non-skid surface. The front wheels must be in the straight-ahead position.
- If necessary, place a chock under the wheel diagonally opposite the wheel to be changed.
- Apply the parking brake and engage first gear, reverse gear or P.
- If the ground on which the vehicle is standing is soft, a solid board (max. 1 cm thick) should be placed under the jack.
- Take heavy objects out of the vehicle before jacking up.
- No people or animals may be in the vehicle when it is jacked-up.
- Never crawl under a jacked-up vehicle.
- Do not start the vehicle when it is raised on the jack.
- Before screwing in the wheel bolts, clean them.

⚠ Warning

Do not grease wheel bolts.

Tightening torques**Caution**

If the vehicle is equipped with alloy wheels, tighten the wheel bolts manually at least for the first five turns.

There are two different types of wheels with two different bolts and tightening torques.

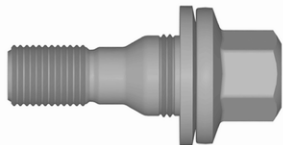

Tightening torque for alloy wheels is 125 Nm.



Tightening torque for steel wheels is 125 Nm.

Use the correct wheel bolts for the respective wheels.

Jacking positions

The jacking positions shown refer to the use of lifting arms and accessory jacks used for changing winter / summer tyres.



The rear arm position of the lifting platform is centrally under the relevant vehicle jacking point.

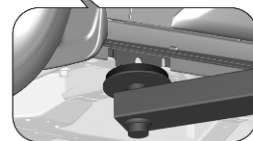

The front arm position of the lifting platform is centrally under the relevant vehicle jacking point.

Spare wheel

The spare wheel is located in a holder beneath the vehicle floor.

The tools are in a box in the left front seat ⇨ 260.

Use the jack only on the specific jacking positions ⇨ 270.

The spare wheel can be classified as a temporary spare wheel depending on the size compared to the other mounted wheels and country regulations. In this case a permissible maximum speed applies, even though no label at the spare wheel indicates this.

Only mount one temporary spare wheel. Do not drive faster than 50 mph. Take curves slowly. Do not use for a long period of time.

Caution

The use of a spare wheel that is smaller than the other wheels or in combination with winter tyres could affect driveability. Have the defective tyre replaced as soon as possible.

If the vehicle is equipped with a trailer hitch, lift the back of the vehicle on one of the rear vehicle jacking points for easier access to the spare wheel.

1. Depending on the version, open the tailgate or the rear doors.

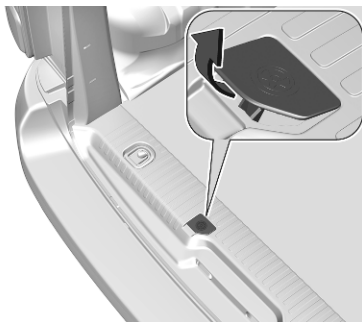

2. Remove the cover of the carrier bolt, located on the rear door sill



3. Fit the wheel wrench on the hexagon bolt. Turn it anticlockwise until the spare wheel holder is low enough to allow the catch to be unhooked.

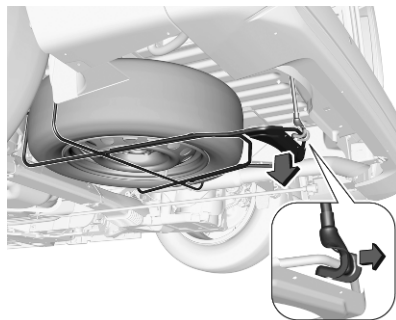

4. Lift the spare wheel holder and unhook the catch. Lower the spare wheel holder.

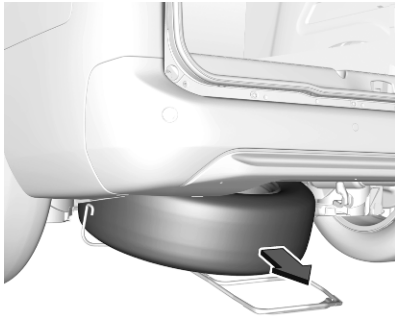

5. Remove the spare wheel.
6. Change the wheel.
7. Position the damaged wheel with the outside down in the spare wheel holder.
8. Lift the spare wheel holder and engage in the catch. The open side of the catch must point in the direction of travel.
9. Close the spare wheel holder by turning the hexagon bolt clockwise using the wheel wrench.
10. Stow wheel wrench in the storage.
11. Close the tailgate or the rear doors.

Only mount one temporary spare wheel. The permissible maximum speed on the label on the temporary spare wheel is only valid for the factory-fitted tyre size.

Fitting the spare wheel

Make the following preparations and observe the following information:

- Park the vehicle on a level, firm and non-skid surface. The front wheels must be in the straight-ahead position.
- If necessary, place a chock under the wheel diagonally opposite the wheel to be changed.
- Apply the parking brake and engage first gear, reverse gear or **P**.
- Remove the spare wheel ↗ 271.
- Never change more than one wheel at once.
- Use the jack only to change wheels in case of puncture, not for seasonal winter or summer tyre change.
- The jack is maintenance-free.

- If the ground on which the vehicle is standing is soft, a solid board (max. 1 cm thick) should be placed under the jack.
- Take heavy objects out of the vehicle before jacking up.
- No people or animals may be in the vehicle when it is jacked-up.
- Never crawl under a jacked-up vehicle.
- Do not start the vehicle when it is raised on the jack.
- Before screwing in the wheel bolts, clean them.

⚠ Warning

Do not grease wheel bolts.

⚠ Warning

Ensure to use always the correct wheel bolts if changing the wheels. When installing the spare wheel, the bolts for alloy wheels can also be used.

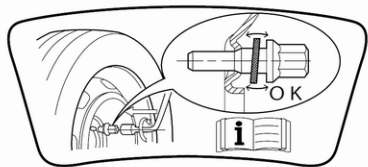

- Note that the spare wheel is secured by the conical contact of each bolt if the wheel bolts for the alloy wheels are used. In this case, the washers do not come into contact with the spare wheel.

1. Steel wheels with cover: Pull off the wheel cover with the designated tool ↪ 260.

Alloy wheels: Disengage wheel bolt caps with the designated tool ↪ 260.



2. Attach the wheel wrench and loosen each wheel bolt by half a turn.

The wheels might be protected by security wheel bolts. To loosen these specific bolts, attach the adapter onto the head of the bolt before installing the wheel wrench. The adapter is located in the tool box. ↪ 260

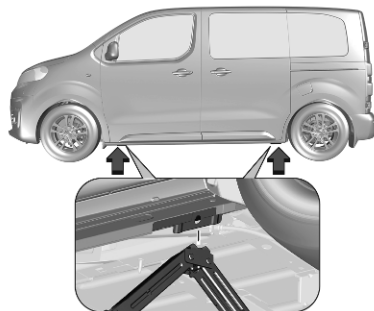

3. Ensure the jack is correctly positioned under the relevant vehicle jacking point. Position it directly below the jacking point in a manner that prevents it from slipping.

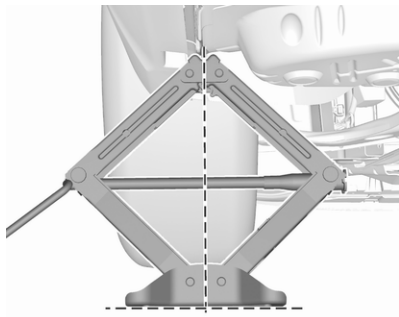

4. Set the jack to the necessary height by turning the hand wheel.

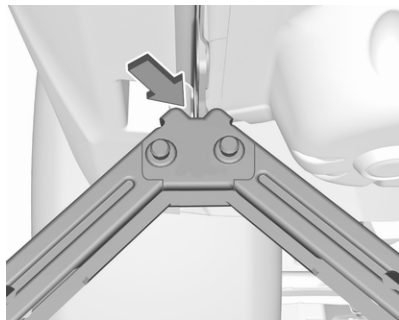

Ensure that the edge of the body fits into the notch of the jack.



With the jack correctly aligned rotate wheel wrench until wheel is clear of the ground.

5. Unscrew the wheel bolts.
6. Change the wheel.
Spare wheel ⇨ 271.
7. Screw on the wheel bolts.
8. Lower the vehicle and remove jack.
9. Install the wheel wrench ensuring that it is located securely and tighten each bolt in a crosswise sequence. Tightening torque is 115 Nm.

If the vehicle is equipped with alloy wheels, note that the wheel

bolts can also be used for the steel spare wheel. In this case, the spare wheel is secured by the conical contact of each bolt.

10. Align the valve hole in the wheel cover with the tyre valve before installing.

Install wheel bolt caps.

11. Stow the replaced wheel ⇨ 271, the vehicle tools ⇨ 260 and the adapter for the security wheel bolts.
12. Check the tyre pressure of the installed tyre and the wheel bolt torque as soon as possible.

Jump starting

Do not start with quick charger.

A vehicle with a discharged vehicle battery can be started using jump leads and the vehicle battery of another vehicle.

Caution

Never jump start another vehicle with an electric vehicle.

⚠ Warning

Be extremely careful when starting with jump leads. Any deviation from the following instructions can lead to injuries or damage caused by battery explosion or damage to the electrical systems of both vehicles.

⚠ Warning

Avoid contact of the battery with eyes, skin, fabrics and painted surfaces. The fluid contains sulphuric acid which can cause injuries and damage in the event of direct contact.

- Never expose the vehicle battery to naked flames or sparks.
- A discharged vehicle battery can already freeze at a temperature of 0 °C. Defrost the frozen battery before connecting jump leads.
- Wear eye protection and protective clothing when handling a battery.
- Use a booster battery with the same voltage (12 V). Its capacity (Ah) must not be much less than that of the discharged vehicle battery.
- Use jump leads with insulated terminals and a cross section of at least 16 mm² (25 mm² for diesel engines).

- Do not disconnect the discharged vehicle battery from the vehicle.
- Switch off all unnecessary electrical consumers.
- Do not lean over the vehicle battery during jump starting.
- Do not allow the terminals of one lead to touch those of the other lead.
- The vehicles must not come into contact with each other during the jump starting process.
- Apply the parking brake, transmission in neutral, automatic transmission in P.

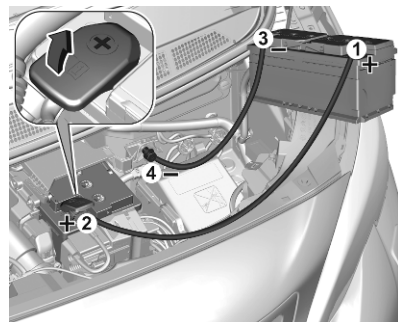

Open the positive terminal protection caps of both vehicle batteries.

Lead connection order:

1. Connect the red lead to the positive terminal of the booster battery.
2. Connect the other end of the red lead to the positive terminal of the discharged battery.
3. Connect the black lead to the negative terminal of the booster battery.
4. Connect the other end of the black lead to a vehicle grounding point of your vehicle in the engine compartment.

Route the leads so that they cannot catch on rotating parts in the engine compartment.

To start the engine:

1. Start the engine of the vehicle providing the jump.
2. After 5 minutes, start the other engine. Start attempts should be made for no longer than 15 seconds at an interval of 1 minute.

3. Allow both engines to idle for approx. three minutes with the leads connected.
4. Switch on electrical consumers e.g. headlights, heated rear window of the vehicle receiving the jump start.
5. Reverse above sequence exactly when removing leads.

Towing

Towing the vehicle

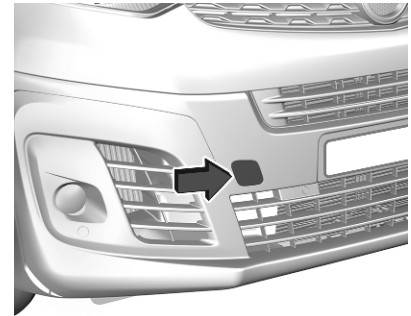

Press in the middle of the cover plate and slide to the upper left corner to unclip it.

The towing eye is stowed with the vehicle tools ↗ 260.

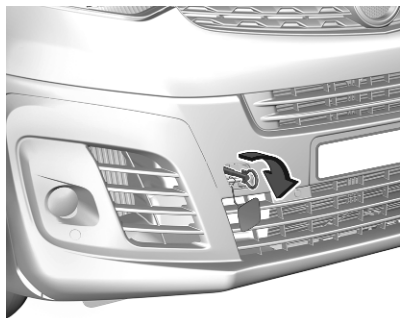

Screw in the towing eye clockwise as far as it will go until it stops in a horizontal position.

Attach a tow rope – or better a tow rod – to the towing eye.

The towing eye must only be used for towing and not for recovering the vehicle.

Switch on ignition to release steering wheel lock and to permit operation of brake lights, horn and windscreen wiper.

Caution

Deactivate the driver assistance systems like active emergency braking ⇨ 201, otherwise the vehicle may automatically brake during towing.

Switch the selector lever to neutral.
Release the parking brake.

Caution

Drive slowly. Do not drive jerkily. Excessive tractive force can damage the vehicle.

When the engine is not running, considerably more force is needed to brake and steer.

To prevent the entry of exhaust gases from the towing vehicle, switch on the air recirculation and close the windows.

Vehicles with automatic transmission: The vehicle must be towed facing forwards, not faster than 50 mph nor further than 60 miles. In all other

cases and when the transmission is defective, the front axle must be raised off the ground.

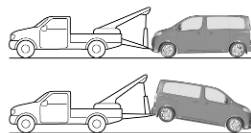
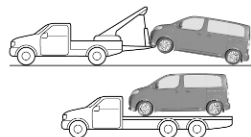

When towing an electric vehicle or a vehicle equipped with an automatic transmission, transport the vehicle on a platform or tow it with the front wheels lifted.

Seek the assistance of a workshop.
After towing, unscrew the towing eye.
Insert cap with the flange into the recess and fix cap by pushing.

Towing another vehicle



On the rear bumper, press the cover plate on its upper left corner to unclip it.

The towing eye is stowed with the vehicle tools ⇨ 260.



Screw in the towing eye clockwise as far as it will go until it stops in a horizontal position.

The lashing eye at the rear underneath the vehicle must never be used as a towing eye.

Attach a tow rope – or better a tow rod – to the towing eye.

The towing eye must only be used for towing and not for recovering a vehicle.

Caution

Drive slowly. Do not drive jerkily. Excessive tractive force can damage the vehicle.

After towing, unscrew the towing eye. Insert cap with the upper flange into the recess and fix cap by pushing.

Appearance care

Exterior care

Locks

The locks are lubricated at the factory using a high quality lock cylinder grease. Use a de-icing agent only when absolutely necessary, as this has a degreasing effect and impairs lock function. After using a de-icing agent, have the locks regreased by a workshop.

Washing

The paintwork of your vehicle is exposed to environmental influences.

Bird droppings, dead insects, resin, pollen and the like should be cleaned off immediately, as they contain aggressive constituents which can cause paint damage.

If using a vehicle wash, comply with the vehicle wash manufacturer's instructions. The windscreen wiper and rear window wiper must be

switched off. Remove antenna and external accessories such as roof racks etc.

If you wash your vehicle by hand, make sure that the insides of the wheel housings are also thoroughly rinsed out.

Wax painted parts of the vehicle regularly.

Clean edges and folds on opened doors and the bonnet as well as the areas they cover.

Clean bright metal mouldings with a cleaning solution approved for aluminium to avoid damages.

Caution

Always use a cleaning agent with a pH value of 4 to 9.

Do not use cleaning agents on hot surfaces.

Do not clean the engine compartment with a steam-jet or high-pressure jet cleaner.

Thoroughly rinse and leather-off the vehicle. Rinse leather frequently. Use separate leathers for painted and glass surfaces: remnants of wax on the windows will impair vision.

Have the door hinges of all doors greased by a workshop.

Exterior lights

Headlight and other light covers are made of plastic. Do not use any abrasive or caustic agents, do not use an ice scraper, and do not clean them dry.

Polishing and waxing

Polishing is necessary only if the paint has become dull or if solid deposits have become attached to it.

Plastic body parts must not be treated with wax or polishing agents.

Windows and wiper blades

Switch off wipers before handling in their areas.

Use a soft lint-free cloth or chamois leather together with window cleaner and insect remover.

When cleaning the rear window from inside, always wipe in parallel to the heating element to prevent damage.

For mechanical removal of ice, use a sharp-edged ice scraper. Press the scraper firmly against the glass so that no dirt can get under it and scratch the glass.

Clean smearing wiper blades with a soft cloth and window cleaner. Also make sure to remove any residues such as wax, insect residues and similar from the window.

Ice residues, pollution and continuous wiping on dry windows will damage or even destroy the wiper blades.

Glass panel

Use a soft lint-free cloth or chamois leather together with window cleaner to clean the glass panel.

Wheels and tyres

Do not use high-pressure jet cleaners.

Clean rims with a pH-neutral wheel cleaner.

Rims are painted and can be treated with the same agents as the body.

Paintwork damage

Rectify minor paintwork damage with a touch-up pen before rust forms. Have more extensive damage or rust areas repaired by a workshop.

Underbody

Some areas of the vehicle underbody have a PVC undercoating while other critical areas have a durable protective wax coating.

After the underbody is washed, check the underbody and have it waxed if necessary.

Bitumen / rubber materials could damage the PVC coating. Have underbody work carried out by a workshop.

Before and after winter, wash the underbody and have the protective wax coating checked.

Liquid gas system

Danger

Liquid gas is heavier than air and can collect in sink points.

Take care when performing work at the underbody in a pit.

For painting work and when using a drying booth at a temperature above 60 °C, the liquid gas tank must be removed.

Do not make any modifications to the liquid gas system.

Towing equipment

Do not clean the coupling ball bar with a steam-jet or high-pressure jet cleaner.

Interior care

Interior and upholstery

Only clean the vehicle interior, including the instrument panel fascia and panelling, with a dry cloth or interior cleaner.

Clean the leather upholstery with clear water and a soft cloth. In case of heavy soiling, use leather care.

The instrument cluster and the displays should only be cleaned using a soft damp cloth. If necessary use a weak soap solution.

Clean fabric upholstery with a vacuum cleaner and brush. Remove stains with an upholstery cleaner.

Clothing fabrics may not be colourfast. This could cause visible discolourations, especially on light-coloured upholstery. Removable stains and discolourations should be cleaned as soon as possible.

Clean seat belts with lukewarm water or interior cleaner.

Caution

Close Velcro fasteners as open Velcro fasteners on clothing could damage seat upholstery.

The same applies to clothing with sharp-edged objects, like zips or belts or studded jeans.

Plastic and rubber parts

Plastic and rubber parts can be cleaned with the same cleaner as used to clean the body. Use interior cleaner if necessary. Do not use any other agent. Avoid solvents and petrol in particular. Do not use high-pressure jet cleaners.

Floor mats

Warning

If a floor mat has the wrong size or is not properly installed, it can interfere with the accelerator pedal and/or brake pedal, what can cause unintended acceleration and/or increased stopping distance which can cause a crash and injury.

Use the following guidelines for proper floor mat usage.

- The original equipment floor mats were designed for your vehicle. If the floor mats need replacing, it is recommended that certified

floor mats be purchased. Always check that the floor mats do not interfere with the pedals.

- Use the floor mat with the correct side up. Do not turn it over.
- Do not place anything on top of the driver side floor mat.
- Use only a single floor mat on the driver side.
- Do not place one floor mat on top of another.

Inserting and removing the floor mats

The driver side floor mat is held in place by two retainers.

To install the driver's side floor mat:

1. Move the driver's seat backwards as far as possible.

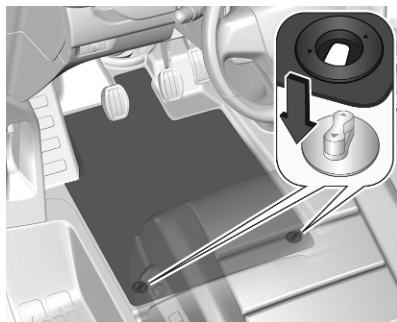

2. Align slots in the mat with the retainers, as shown.

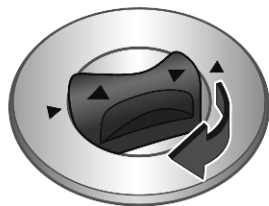

3. Turn retainers clockwise for a quarter turn.

Removing

1. Move the driver's seat backwards as far as possible.
2. Turn retainers a quarter turn towards the opposite direction than during installation.
3. Remove the mat.

Service and maintenance

General information	284
Service information	284
Recommended fluids, lubricants and parts	287
Recommended fluids and lubricants	287

General information

Service information

In order to ensure economical and safe vehicle operation and to maintain the value of your vehicle, it is of vital importance that all maintenance work is carried out at the proper intervals as specified.

The detailed, up-to-date service schedule for your vehicle is available at the workshop.

Severe operating conditions exist if one or more of the following circumstances occur frequently: Cold starting, stop and go operation, e.g. for taxis and police vehicles, trailer operation, mountain driving, driving on poor and sandy road surfaces, increased air pollution, presence of airborne sand and high dust content, driving at high altitude and large variations of temperature.

Under these severe operating conditions, certain service work may be required more frequently than the regular service interval indicated in

the service display. Contact a workshop for customised service schedules.

Service display ⇨ 109.

Service intervals

Engine code	DV5RC DV5RD	DW10FDU DW10FCU DW10FEU	DV6DU DW10F	Electric engine
Country group 1	25,000 miles / 2 year ¹⁾	32,000 miles / 2 year		25,000 miles / 2 years ²⁾
Country group 2	25,000 miles / 2 year	32,000 miles / 2 year		25,000 miles / 2 years ²⁾
Country group 3	12,500 miles / 1 year	12,500 miles / 1 year		25,000 miles / 1 year
Country group 4	12,500 miles / 1 year	12,500 miles / 1 year	12,500 miles / 1 year	25,000 miles / 1 year
Country group 5	6,000 miles / 1 year	6,000 miles / 1 year	6,000 miles / 1 year	25,000 miles / 1 year

1) Unless otherwise indicated in the service display.

2) Initial service interval is 12,500 miles / 1year

Country Group 1:

Andorra, Austria, Belgium, Cyprus, Denmark, Finland, France, Germany, Greece, Iceland, Ireland, Italy, Liechtenstein, Luxembourg, Malta, Monaco, Netherlands, Norway, Portugal, San Marino, Spain, Sweden, Switzerland, United Kingdom.

Country Group 2:

Bosnia-Herzegovina, Bulgaria, Croatia, Czech Republic, Estonia, Hungary, Latvia, Lithuania, North Macedonia, Poland, Romania, Slovakia, Slovenia.

Country Group 3:

Albania, Montenegro, Serbia, Kosovo.

Country Group 4:

Israel, Russia, South Africa, Turkey.

Country Group 5:

All other countries which are not listed in the previous country groups. (International interval)

Confirmations

Confirmation of service is recorded in the Service and warranty booklet. The date and mileage is completed with the stamp and signature of the servicing workshop.

Make sure that the Service and warranty booklet is completed correctly as continuous proof of service is essential if any warranty or goodwill claims are to be met, and is also a benefit when selling the vehicle.

Recommended fluids, lubricants and parts

Recommended fluids and lubricants

Only use products that meet the recommended specifications.

Warning

Operating materials are hazardous and could be poisonous. Handle with care. Pay attention to information given on the containers.

Engine oil

Engine oil is identified by its quality and its viscosity. Quality is more important than viscosity when selecting which engine oil to use. The oil quality ensures e.g. engine cleanliness, wear protection and oil aging control, whereas viscosity grade gives information on the oil's thickness over a temperature range.

Select the appropriate engine oil based on its quality and on the minimum ambient temperature ⇨ 291.

Topping up engine oil

Caution

In case of any spilled oil, wipe it up and dispose it properly.

Engine oils of different manufacturers and brands can be mixed as long as they comply with the required engine oil quality and viscosity.

Use of engine oils for all petrol engines with only ACEA quality is prohibited, since it can cause engine damage under certain operating conditions.

Select the appropriate engine oil based on its quality and on the minimum ambient temperature ⇨ 291.

Additional engine oil additives

The use of additional engine oil additives could cause damage and invalidate the warranty.

Engine oil viscosity grades

The SAE viscosity grade gives information of the thickness of the oil.

Multigrade oil is indicated by two figures, e.g. SAE 5W-30. The first figure, followed by a W, indicates the low temperature viscosity and the second figure the high temperature viscosity.

Select the appropriate viscosity grade depending on the minimum ambient temperature ⇨ 291.

All of the recommended viscosity grades are suitable for high ambient temperatures.

Coolant and antifreeze

Use only Lobrid antifreeze approved for the vehicle. Consult a workshop.

The system is factory filled with coolant designed for excellent corrosion protection and frost protection down to approx. -37 °C. This concentration should be maintained all year round. The use of additional coolant additives that intend to give additional corrosion protection or seal against minor leaks

can cause function problems. Liability for consequences resulting from the use of additional coolant additives will be rejected.

Washer fluid

Use only washer fluid approved for the vehicle to prevent damage of wiper blades, paintwork, plastic and rubber parts. Consult a workshop.

Brake and clutch fluid

Over time, brake fluid absorbs moisture which will reduce braking effectiveness. The brake fluid should therefore be replaced at the specified interval.

AdBlue

Only use AdBlue to reduce the nitrogen oxides in the exhaust emission ↪ 168.

Technical data

Vehicle identification	289
Vehicle Identification Number ..	289
Identification plate	289
Engine identification	290
Vehicle data	291
Recommended fluids and lubricants	291
Engine data	293
Vehicle dimensions	295
Capacities	295
Tyre pressures	296

Vehicle identification

Vehicle Identification Number



The Vehicle Identification Number may be embossed on the instrument panel, visible through the windscreen.

Identification plate

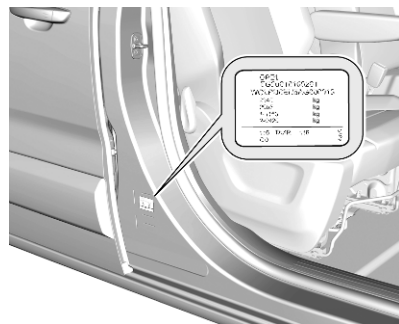

The identification plate is located on the front left or right door frame.

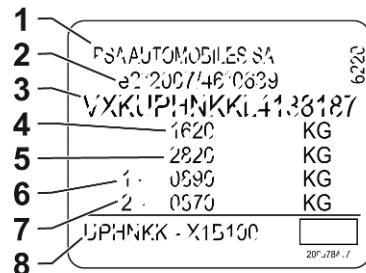

Information on identification label:

- 1** : manufacturer
- 2** : type approval number
- 3** : vehicle identification number
- 4** : permissible gross vehicle weight rating in kg
- 5** : permissible gross train weight in kg
- 6** : maximum permissible front axle load in kg
- 7** : maximum permissible rear axle load in kg
- 8** : vehicle-specific or country-specific data

The combined total of front and rear axle loads must not exceed the permissible gross vehicle weight.

Vehicle's kerb weight depends on the specification of the vehicle, e.g. optional equipment and accessories. Refer to the EEC Certificate of Conformity provided with your vehicle or other national registration documents.

The technical data is determined in accordance with European Community standards. We reserve the right to make modifications.

Specifications in the vehicle documents always have priority over those given in this manual.

Engine identification

The technical data tables show the engine identifier code.

Engine data ⇨ 293.

To identify the respective engine, refer to the engine power in the EEC Certificate of Conformity provided with your vehicle or other national registration documents.

Vehicle data

Recommended fluids and lubricants

Required engine oil quality

Country groups ⇨ 284

Countries included in country groups 1 and 2

	DV5RUCd DV5RUC	all other engines
Vauxhall Original engine oil	B71 2010 / B71 2312	B71 2312

Countries included in country groups 3 to 5

	all engines
Vauxhall Original engine oil	B71 2302

Engine oil viscosity grades

Country groups ⇨ 284

Countries included in country groups 1 and 2

	B71 2010	B71 2312
Engine oil viscosity grade	SAE 0W-20	SAE 0W-30

292 Technical data

Countries included in country groups 3 to 5

B71 2302

Engine oil viscosity grade

SAE 0W-30

Engine data

Engine identifier code	D15DT / F15DT	D15DTH / F15DTH	D20DTL	F20DT
Sales designation	1.5 Turbo	1.5 Turbo	2.0 Turbo	2.0 Turbo
Engineering code	DV5RUCd	DV5RUC	DW10FEU	DW10FDDU
Piston displacement [cm ³]	1499	1499	1997	1997
Engine power [kW]	75	88	90	103
at rpm	3500	3500	3750	3750
Torque [Nm]	270	300	340	370
at rpm	1600	1750	2000	2000
Fuel type	Diesel	Diesel	Diesel	Diesel
Engine identifier code	A20DTH / D20DTH	D20DTR / F20DTR	Z16DT / B16DT	Electric engine
Sales designation	2.0 Turbo	2.0 Turbo	1.5 Turbo	-
Engineering code	DW10FDU	DW10FDCU	DV6DU	ZAE
Piston displacement [cm ³]	1997	1997	1560	-
Engine power [kW]	110	130	70	100
at rpm	4400	3750	1)	-

294 Technical data

Engine identifier code	A20DTH / D20DTH	D20DTR / F20DTR	Z16DT / B16DT	Electric engine
Sales designation	2.0 Turbo	2.0 Turbo	1.5 Turbo	-
Engineering code	DW10FDU	DW10FDCU	DV6DU	ZAE
Torque [Nm]	370	400	— ¹⁾	260
at rpm	2000	2000	— ¹⁾	-
Fuel type	Diesel	Diesel	Diesel	-

1) not available at time of printing

Vehicle dimensions

Size	L1	L2	L3
Length [mm]	4609	4959	5306 / 5309
Width without exterior mirrors [mm]	1920	1920	1920
Width with exterior mirrors [mm]	2204	2204	2204
Height without roof railing [mm]	1892 - 1950 ²⁾	1881 - 1949 ²⁾	1890 - 1940 ²⁾
Wheelbase [mm]	2925	3275	3275
Turning circle diameter [m]	11,8	12,9	12,9

2) with increased payload

Capacities

Engine oil

Engine	DV5RUCd DV5RUC	DV6DU	DW10FEU DW10FD DW10FDCU DW10FDDU
including filter [l]	5.75	3.75	6.0
between MIN and MAX [l]	1	1.5	1.2

Fuel tank

Diesel, refilling quantity [l] 69

AdBlue tank

AdBlue, refilling quantity [l] 19 / 20

High voltage battery

Battery capacity [kWh] 50 / 75

Tyre pressures

Regarding tyre pressures for a specific vehicle, refer to the tyre pressure information label on the B-pillar.

The tyre pressure information label indicates the original equipment tyres and the correspondent tyre pressures.

Standard payload

Tyres	Vehicle with up to 3 people		With full load	
	front	rear	front	rear
	[kPa/bar] ([psi])	[kPa/bar] ([psi])	[kPa/bar] ([psi])	[kPa/bar] ([psi])
215/65 R16	280/2.8 (41)	310/3.1 (45)	300/3.0 (44)	350/3.5 (51)
215/60 R17	280/2.8 (41)	310/3.1 (45)	320/3.2 (46)	350/3.5 (51)
225/55 R17	300/3.0 (44)	250/2.5 (36)	300/3.0 (44)	280/2.8 (41)

Increased payload

Tyres	Vehicle with up to 3 people		With full load	
	front	rear	front	rear
	[kPa/bar] ([psi])	[kPa/bar] ([psi])	[kPa/bar] ([psi])	[kPa/bar] ([psi])
215/65 R16	300/3.0 (44)	300/3.0 (44)	300/3.0 (44)	370/3.7 (54)
215/60 R17	300/3.0 (44)	300/3.0 (44)	300/3.0 (44)	370/3.7 (54)

Customer information

Customer information	298
Declaration of conformity	298
REACH	299
Registered trademarks	300
Vehicle data recording and privacy	300
Event data recorders	300
Radio Frequency Identification (RFID)	303

Customer information

Declaration of conformity

Radio transmission systems

This vehicle has systems that transmit and / or receive radio waves subject to Directive 2014/53/EU. The manufacturers of the systems listed below declare conformity with Directive 2014/53/EU. The full text of the EU declaration of conformity for each system is available at the following internet address: www.opel.com/conformity.

Importer is
Opel / Vauxhall, Bahnhofspatz,
65423 Ruesselsheim am Main,
Germany.

Infotainment system Multimedia Navi

Continental

LCIE Bureau Veritas-Site de
Fontenay aux Roses, 33 avenue du
général Leclerc, 92260 Fontenay aux
Roses, France

Operation frequency (MHz)	Maximum output (dBm)
---------------------------	----------------------

2400.0 - 2483.5	2.2
-----------------	-----

2400.0 - 2483.5	15
-----------------	----

Infotainment system Radio

Clarion

244 rue du Pré à Varois, 54670
Custines, France

Operation frequency:
2400 - 2480 MHz

Maximum output: 4 dBm

Infotainment system Multimedia

Robert Bosch Car Multimedia GmbH

Robert-Bosch-Straße 200, 31139
Hildesheim, Germany

Operation frequency (MHz)	Maximum output (dBm)
---------------------------	----------------------

2402.0 - 2480.0	17
-----------------	----

2412.0 - 2472.0	4.15
-----------------	------

BTA Module

Magneti Marelli S.p.A.

Viale A. Borletti 61/63, 20011
Corbetta, Italy

Operation frequency (MHz)	Maximum output (dBm)
880 - 915	33
1710 - 1785	24
1850 - 1910	24
1920 - 1980	24
2500 - 2570	23

Antenna module

Hirschmann Car Communication
GmbH

Stuttgarter Strasse 45-51, 72654
Neckartenzlingen, Germany

Operation frequency: N/A

Maximum output: N/A

Radio remote control transmitter

Hülsbeck & Fürst GmbH & Co. KG
Steeger Straße 17, 42551 Velbert,
Germany

Operation frequency: 433.92 MHz

Maximum output: 10 dBm

Radio remote control receiver

Delphi European, Middle Eastern &
African Regional Offices Customer
Technology

Center Avenue de Luxembourg,
L-4940 Bascharage, G.D. of
Luxembourg

Operation frequency: 119 - 128.6

Maximum output:
16 dB μ A/m @ 10 m

Electronic key transmitter

Valeo

43 Rue Bayen, 75017 Paris, France

Operation frequency: 433.92 MHz

Maximum output: 10 dBm

Radar unit

ZF TRW Autocruise SAS

Secteur de la Pointe du Diable,
Avenue du technopôle, 29280
Plouzane, France

Operation frequency:
24.15 - 24.25 GHz

Maximum output: 20 dBm

Immobiliser

KOSTAL of America, Inc.

350 Stephenson Hwy, Troy MI 48083,
USA

Operation frequency: 125 kHz

Maximum output: 5 dB μ A/m at 10 m

ICASA type approval numbers

List of all Independent
Communications Authority of South
Africa (ICASA) type approval
numbers:

TA-2016/121, TA-2016/3261,
TA-2017/2387, TA-2017/2745,
TA-2013/430, TA-2017/1106,
TA-2016/929, TA-2017/3180

REACH

Registration, Evaluation,
Authorisation and Restriction of
Chemicals (REACH) is a European
Union regulation adopted to improve
the protection of human health and
the environment from the risks that
can be posed by chemicals. Visit
www.opel.com/reach for further
information and for access to the
Article 33 communication.

Registered trademarks

Apple Inc.

Apple CarPlay™ is a trademark of Apple Inc.

App Store® and iTunes Store® are registered trademarks of Apple Inc.

iPhone®, iPod®, iPod touch®, iPod nano®, iPad® and Siri® are registered trademarks of Apple Inc.

Bluetooth SIG, Inc.

Bluetooth® is a registered trademark of Bluetooth SIG, Inc.

DivX, LLC

DivX® and DivX Certified® are registered trademarks of DivX, LLC.

Google Inc.

Android™ and Google Play™ Store are trademarks of Google Inc.

Verband der Automobilindustrie e.V.

AdBlue® is a registered trademark of the VDA.

Vehicle data recording and privacy

Event data recorders

Electronic control units are installed in your vehicle. Control units process data which is received by vehicle sensors, for example, or which they generate themselves or exchange amongst themselves. Some control units are necessary for the safe functioning of your vehicle, others assist you while you drive (driver assistance systems), while others provide comfort or Infotainment functions.

The following contains general information about data processing in the vehicle. You will find additional information as to which specific data is uploaded, stored and passed on to third parties and for what purpose in your vehicle under the key word Data Protection closely linked to the references for the affected functional characteristics in the relevant Owner's Manual or in the general terms of sale. These are also available online.

Operating data in the vehicle

Control units process data for operation of the vehicle.

This data includes, e.g.:

- vehicle status information (e.g. speed, movement delay, lateral acceleration, wheel rotation rate, "seat belts fastened" display)
- ambient conditions (e.g. temperature, rain sensor, distance sensor)

As a rule such data is transient, not stored for longer than an operational cycle, and only processed on board the vehicle itself. Control units often include data storage (including the vehicle key). This is used to allow information to be documented temporarily or permanently on vehicle condition, component stress, maintenance requirements and technical events and errors.

Depending on technical equipment level, the data stored is as follows:

- system component operating states (e.g. fill level, tyre pressure, battery status)
- faults and defects in important system components (e.g. lights, brakes)
- system reactions in special driving situations (e.g. triggering of an airbag, actuation of the stability control systems)
- information on events damaging the vehicle
- for electric vehicles the amount of charge in the high-voltage battery, estimated range

In special cases (e.g. if the vehicle has detected a malfunction), it may be necessary to save data that would otherwise just be volatile.

When you use services (e.g. repairs, maintenance), the operating data saved can be read together with the vehicle identification number and used when necessary. Staff working for the service network (e.g. garages, manufacturers) or third parties (e.g.

breakdown services) can read the data from the vehicle. The same applies to warranty work and quality assurance measures.

Data is generally read via the OBD (On-Board Diagnostics) port prescribed by law in the vehicle. The operating data which is read out, documents the technical condition of the vehicle or individual components and assists with fault diagnosis, compliance with warranty obligations and quality improvement. This data, in particular information on component stress, technical events, operator errors and other faults, is transmitted to the manufacturer where appropriate, together with the vehicle identification number. The manufacturer is also subject to product liability. The manufacturer potentially also uses operating data from vehicles for product recalls. This data can also be used to check customer warranty and guarantee claims.

Fault memories in the vehicle can be reset by a service company when carrying out servicing or repairs or at your request.

Comfort and Infotainment functions

Comfort settings and custom settings can be stored in the vehicle and changed or reset at any time.

Depending on the equipment level in question, these include

- seat and steering wheel position settings
- chassis and air conditioning settings
- custom settings such as interior lighting

You can input your own data in the Infotainment functions for your vehicle as part of the selected features.

Depending on the equipment level in question, these include

- multimedia data such as music, videos or photos for playback in an integrated multimedia system
- address book data for use with an integrated hands-free system or an integrated navigation system

- input destinations
- data on the use of online services

This data for comfort and Infotainment functions can be stored locally in the vehicle or be kept on a device that you have connected to the vehicle (e.g. a smartphone, USB stick or MP3 player). Data that you have input yourself can be deleted at any time.

This data can only be transmitted out of the vehicle at your request, particularly when using online services in accordance with the settings selected by you.

Smartphone integration, e.g. Android Auto or Apple CarPlay

If your vehicle is equipped accordingly, you can connect your smartphone or another mobile device to the vehicle so that you can control it via the controls integrated in the vehicle. The smartphone image and sound can be output via the multimedia system in this case. At the same time, specific information is transmitted to your smartphone. Depending on the type of integration,

this includes data such as position data, day / night mode and other general vehicle information. For more information, please see the operating instructions for the vehicle / Infotainment system.

Integration allows selected smartphone apps to be used, such as navigation or music playback. No further integration is possible between smartphone and vehicle, in particular active access to vehicle data. The nature of further data processing is determined by the provider of the app used. Whether you can define settings, and if so which ones, is dependent on the app in question and your smartphone's operating system.

Online services

If your vehicle has a radio network connection, this allows data to be exchanged between your vehicle and other systems. The radio network connection is made possible by means of a transmitter device in your vehicle or a mobile device provided by you (e.g. a smartphone). Online functions can be used via this radio network connection. These include online services and applications / apps provided to you by the manufacturer or other providers.

Proprietary services

In the case of the manufacturer's online services, the relevant functions are described by the manufacturer in an appropriate location (e.g. Owner's Manual, the manufacturer's website) and the associated data protection information is provided. Personal data may be used to provide online services. Data exchange for this purpose takes place via a protected connection, e.g. using the manufacturer's IT systems provided for the purpose. Collection,

processing and use of personal data for the purposes of preparation of services take place solely on the basis of legal permission, e.g. in the case of a legally prescribed emergency communication system or a contractual agreement, or by virtue of consent.

You can activate or deactivate the services and functions (which are subject to charges to some extent) and, in some cases, the vehicle's entire radio network connection. This does not include statutory functions and services such as an emergency communication system.

Third party services

If you make use of online services from other providers (third parties), these services are subject to the liability and data protection and usage conditions of the provider in question. The manufacturer frequently has no influence over the content exchanged in this regard.

Therefore, please note the nature, scope and purpose of the collection and use of personal data within the scope of third party services provided by the service provider in question.

Radio Frequency Identification (RFID)

RFID technology is used in some vehicles for functions such as tyre pressure monitoring and immobiliser. It is also used in connection with conveniences such as radio remote controls for door locking / unlocking and starting. RFID technology in Vauxhall vehicles does not use or record personal information or link with any other Vauxhall system containing personal information.

Index

A

- Accessories and vehicle modifications 236
- Active emergency braking.. 117, 201
- AdBlue..... 115, 168
- Adjustable air vents 155
- Airbag and belt tensioners 111
- Airbag deactivation 64, 112
- Airbag label..... 60
- Airbag system 60
- Air conditioning regular operation 157
- Air conditioning system 146
- Air intake 157
- Air vents..... 155
- Antilock brake system 178
- Antilock brake system (ABS) 114
- Anti-theft alarm system 36
- Anti-theft locking system 35
- Appearance care..... 280
- Armrest..... 51
- Automatic anti-dazzle 40
- Automatic crash notification (ACN)..... 132
- Automatic light control 136
- Automatic locking 28
- Automatic operation of electric parking brake off..... 113
- Automatic transmission 174
- Autostop..... 116, 163

B

- Battery discharge protection 143
- BlueInjection..... 168
- Bonnet 239
- Brake and clutch fluid..... 287
- Brake assist 182
- Brake fluid 242
- Brakes 178, 242
- Brake system 113
- Breakdown..... 277
- Bulb replacement 246

C

- Camera display..... 212
- Capacities 295
- Cargo management system 82
- Car wash mode..... 171
- Catalytic converter 167
- Central locking system 24
- Centre console lighting 142
- Centre high-mounted brake light 254
- Changing tyre and wheel size ... 266
- Charging..... 221
- Charging cable..... 218
- Charging cable connected..... 116
- Charging status..... 226
- Charging system 112
- Charging types..... 217
- child lock..... 42
- Child locks 28

Child restraint installation	
locations	69
Child restraints.....	66
Child restraint systems	66
Child surveillance mirror.....	40
Climate control	15
Climate control systems.....	144
Clock.....	98
Comfort consumption gauge.....	108
Control indicators.....	110
Control of the vehicle	159
Controls.....	94
Convex shape	38
Coolant and antifreeze.....	287
Cornering lights.....	138
Cruise control	117, 186
Cupholders	78
Curtain airbag system	64

D

Danger, Warnings and Cautions ...	4
Daytime running lights	138
Declaration of conformity.....	298
DEF.....	168
Deflation detection system.....	115
Diesel exhaust fluid.....	168
Diesel fuel system bleeding	244
Door open	117
Doors.....	30, 32
Drive modes.....	178

Driver alert.....	214
Driver assistance systems.....	186
Driver Information Centre.....	118
Driving characteristics and towing tips	230
Driving hints.....	159

E

Electric adjustment	38
Electrical system.....	256
Electric drive unit.....	171
Electric parking brake.....	113
Electric parking brake fault.....	113
Electronic climate control system	148
Electronic driving programmes ..	176
Electronic key system.....	23
Electronic Stability Control and Traction Control system. .	114, 183
Emergency call.....	132
End-of-life vehicle recovery	238
Engine compartment fuse box ..	257
Engine coolant	241
Engine coolant temperature	114
Engine coolant temperature gauge	108
Engine data	293
Engine exhaust	167
Engine identification.....	290
Engine oil	240, 287, 291
Engine oil level monitor.....	109

Engine oil pressure	115
Entry lighting	142
ERA GLONASS.....	133
Event data recorders.....	300
Exhaust filter.....	115, 167
Exit lighting	142
Exterior care	280
Exterior light	116
Exterior lighting	12, 135
Exterior mirrors.....	38

F

Fault	176
Fixed air vents	156
Floor mats.....	282
Folding front seat.....	50
Folding mirrors	39
Folding tray	86
Forward collision alert.....	199
Front airbag system	63
Front fog lights	117, 139, 250
Front pedestrian protection.....	203
Front seats.....	47
Front storage.....	79
Front turn lights	251
Fuel consumption - CO ₂ - Emissions	229
Fuel for diesel engines	227
Fuel gauge	106
Fuses	256

G

Gauges.....	105
Gear selection	174
Gear shifting.....	114
General information.....	216, 230
Glass panel	45
Glovebox	78
Glovebox cooler	156

H

Halogen headlights	246
Hand brake.....	179
Hazard warning flashers	138
Headlight flash	137
Headlight range adjustment	137
Headlights.....	135
Headlights when driving abroad	138
Head restraint adjustment	8
Head restraints	46
Head-up display.....	125
Heated mirrors	39
Heated rear window	43
Heated windscreen.....	44
Heating	51
Heating and ventilation system .	144
High beam	116, 136
High beam assist.....	116, 136
High voltage battery gauge.....	107
Hill start assist	182

Hinged doors.....	32
Horn	13, 95

I

Identification plate	289
Ignition switch positions	159
Immobiliser	38
Indicators.....	105
Info Display.....	123
Instrument cluster	100
Instrument panel fuse box	258
Instrument panel illumination control	140
Instrument panel overview	10
Interior care	281
Interior lighting.....	140
Interior lights	140, 256
Interior mirror Rear view camera display.....	212
Interior mirrors.....	40
Introduction	3

J

Jump starting	276
---------------------	-----

K

Keys	21
Keys, locks.....	21

L

Lane departure warning.....	114, 213
Lashing eyes	82
LED headlights.....	117
Lighting features.....	142
Light switch	135
load compartment.....	140
Load compartment	32, 81
Load compartment cover	81
load compartment lighting.....	140
Loading.....	50
Loading information	91
Low beam.....	116
Low fuel	116

M

Malfunction indicator light	112
Manual anti-dazzle	40
Manual mode	175
Manual seat adjustment.....	47
Manual transmission	177
Massage.....	52
mechanical child lock.....	42
Mirror adjustment	9
Misted light covers	140
Multimedia.....	127
Multimedia Navi.....	127

N

New vehicle running-in	159
Number plate light	255

- O**
- Object detection systems..... 204
 - Odometer 105
 - Oil, engine..... 287, 291
 - Operation..... 171
 - Outside temperature 98
 - Overrun cut-off 163
- P**
- Panoramic roof..... 45
 - Panoramic view system..... 209
 - Parking 20, 166
 - Parking assist 204
 - Parking brake..... 113, 179
 - Parking heater..... 152
 - Particulate filter..... 167
 - Pedestrian safety alert..... 95
 - Pedestrian safety alert fault..... 117
 - Performing work 238
 - Peripheral lighting..... 143
 - Power button..... 160
 - Power indicator gauge..... 108
 - Power outlets 98
 - Power seat adjustment 49
 - Power sliding doors..... 30
 - Power windows 41
 - Preheating 115
 - Programmable charging..... 225
 - Puncture..... 271
- R**
- Radio Frequency Identification (RFID)..... 303
 - Radio (Infotainment system)..... 127
 - Radio remote control 22
 - Rain sensor..... 117
 - REACH..... 299
 - Reading lights 141
 - Rear doors..... 30
 - Rear fog light 117, 139, 252
 - Rear seats 52
 - Rear view camera 212
 - Rear windows 42
 - Rear window wiper and washer . . 97
 - Recommended fluids and lubricants 287, 291
 - Reduced engine power..... 116
 - Refuelling 228
 - Regenerative braking..... 182
 - Registered trademarks..... 300
 - Reversing lights 140
 - Ride control systems..... 183
 - Roadside assistance..... 132
 - Roller blinds 44
 - Roof..... 45
 - Roof bars..... 90
 - Roof load..... 91
 - Roof rack 90
- S**
- Safety net 84
 - Seat adjustment 7
 - Seat belt 8
 - Seat belt reminder 111
 - Seat belts 56
 - Seat folding 50
 - Seat heating..... 51
 - Seat position 47
 - Selective catalytic reduction..... 168
 - Selective ride control..... 184
 - Selector lever..... 174
 - Semi-adaptive cruise control..... 117, 193
 - Service 157, 284
 - Service display 109
 - Service information 284
 - Service vehicle soon 112
 - Side airbag system 63
 - Side blind spot alert..... 117, 207
 - Sidelights..... 135
 - Side turn lights 254
 - Sliding doors 30
 - Sliding side doors..... 30
 - SOS..... 132
 - Spare wheel 271
 - Speed limiter..... 117, 189
 - Speed limit recognition 186, 189, 193
 - Speedometer 105
 - Starting and operating..... 159

Starting off	18
Starting the engine	161
Steering.....	159
Steering column controls.....	95
Steering wheel.....	95
Steering wheel adjustment	9, 94
Steering wheel controls	94
Stop engine.....	112
Stop-start system.....	163
Storage.....	78
Storage compartments.....	78
Sunvisor lights	142
Sun visors	44
Symbols	4
System check.....	113

T

Table.....	87
Tachometer	106
Tailgate.....	32
tailgate window.....	42
Tail lights	252
Temperature preconditioning.....	153
Three-point seat belt	57
Tools	260
torch.....	140
Tow bar.....	230
Towing.....	230, 277
Towing another vehicle	279
Towing equipment	231

Towing the vehicle	277
Traffic sign assistant.....	213
Trailer coupling.....	230
Trailer stability assist	234
Trailer towing	230
Transmission	17
Transmission display	174
Tread depth	265
Trip odometer	105
Turn lights	111, 139
Tyre chains	266
Tyre deflation detection system ..	264
Tyre designations	263
Tyre pressure	263
Tyre pressures	296
Tyre repair kit	267

U

Ultrasonic parking assist.....	204
Underseat storage	80
Upholstery.....	281
USB port.....	98
Using this manual	3

V

Valet mode.....	123
Vauxhall Connect.....	132
Vehicle battery	242
Vehicle checks.....	238
Vehicle data.....	291

Vehicle data recording and privacy.....	300
Vehicle dimensions	295
Vehicle Identification Number	289
Vehicle jack.....	260
Vehicle locator lighting.....	143
Vehicle messages	126
Vehicle personalisation	127
Vehicle ready.....	116
Vehicle security.....	35
Vehicle specific data	3
Vehicle storage.....	236
Vehicle tools.....	260
Vehicle unlocking	6
Ventilation.....	152

W

Warning chimes	127
Warning lights.....	105
Washer and wiper systems	13
Washer fluid	242
Wheel changing	270
Wheel covers	266
Wheels and tyres	262
Windows.....	41
Windscreen.....	41
Windscreen wiper and washer	96
Winter tyres	262
Wiper blade replacement	245

X

Xenon headlights 249

Copyright by Vauxhall Motors Ltd.

The information contained in this publication is effective as of the date indicated below. Vauxhall Motors Ltd. reserves the right to make changes to the technical specifications, features and design of the vehicles relative to the information contained in this publication, as well as changes to the publication itself.

Edition: June 2021, Vauxhall Motors Ltd.

Printed on chlorine-free bleached paper.

ID-VVICORIE2106-en

