

# VIVARO

Owner's Manual



VAUXHALL



---

# Contents

Introduction .....	2
In brief .....	6
Keys, doors and windows .....	19
Seats, restraints .....	44
Storage .....	71
Instruments and controls .....	82
Lighting .....	108
Climate control .....	116
Driving and operating .....	129
Vehicle care .....	164
Service and maintenance .....	203
Technical data .....	206
Customer information .....	214
Index .....	222

## Introduction

Fuel	Designation	<input type="text"/>		
Engine oil	Grade	<input type="text"/>		
	Viscosity	<input type="text"/>		
Tyre pressure	Tyre size		Front	Rear
	Summer tyres	<input type="text"/>	<input type="text"/>	<input type="text"/>
	Winter tyres	<input type="text"/>	<input type="text"/>	<input type="text"/>
Weights	Gross vehicle weight rating	<input type="text"/>		
	- Kerb weight, basic model	<input type="text"/>		
	= Loading	<input type="text"/>		

## Vehicle specific data

Please enter your vehicle's data on the previous page to keep it easily accessible. This information is available in the sections "Service and maintenance" and "Technical data" as well as on the identification plate.

## Introduction

Your vehicle is a designed combination of advanced technology, safety, environmental friendliness and economy.

This Owner's Manual provides you with all the necessary information to enable you to drive your vehicle safely and efficiently.

Make sure your passengers are aware of the possible risk of accident and injury which may result from improper use of the vehicle.

You must always comply with the specific laws and regulations of the country that you are in. These laws may differ from the information in this Owner's Manual.

Disregarding the description given in this manual may affect your warranty.

When this Owner's Manual refers to a workshop visit, we recommend your Vauxhall Authorised Repairer.

All Vauxhall Authorised Repairers provide first-class service at reasonable prices. Experienced mechanics trained by Vauxhall work according to specific Vauxhall instructions.

The customer literature pack should always be kept ready to hand in the vehicle.

## Using this manual

- This manual describes all options and features available for this model. **Certain descriptions, including those for display and menu functions, may not apply to your vehicle due to model variant, country specifications, special equipment or accessories.**
- The "In brief" section will give you an initial overview.

- The table of contents at the beginning of this manual and within each section shows where the information is located.
- The index will enable you to search for specific information.
- This Owner's Manual depicts left-hand drive vehicles. Operation is similar for right-hand drive vehicles.
- The Owner's Manual uses the factory engine designations. The corresponding sales designations can be found in the section "Technical data".
- Directional data, e.g. left or right, or front or back, always relate to the direction of travel.
- The vehicle display screens may not support your specific language.
- Display messages and interior labelling are written in **bold** letters.

## Danger, Warnings and Cautions

### **⚠ Danger**

Text marked **⚠ Danger** provides information on risk of fatal injury. Disregarding this information may endanger life.

### **⚠ Warning**

Text marked **⚠ Warning** provides information on risk of accident or injury. Disregarding this information may lead to injury.

### **Caution**

Text marked **Caution** provides information on possible damage to the vehicle. Disregarding this information may lead to vehicle damage.

## Symbols

Page references are indicated with ⇨.  
⇨ means "see page".

Page references and index entries refer to the indented headings given in the section table of content.

Thank you for choosing a Vauxhall.

We wish you many hours of pleasurable driving.

**Your Vauxhall Team**



## In brief

## Initial drive information

### Vehicle unlocking

#### Unlocking with remote control



Press  to unlock the driver's door.  
Press again to unlock entire vehicle.  
Open the doors by pulling the handles.

Press . Only the load compartment is unlocked.  
Radio remote control ⇨ 20.  
Central locking system ⇨ 24.  
Load compartment ⇨ 33.  
Unlocking with manual key ⇨ 24.

### Unlocking with electronic key

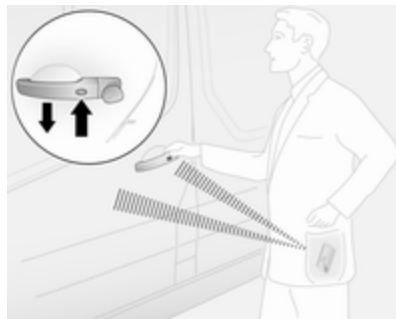

Press the button on any exterior door handle when the electronic key is within range of the detection zone (approx. 1 m of the front doors or load compartment) and pull the handle to open.

- or -

Press electronic key button  to unlock all doors and the load compartment.

Electronic key system ⇨ 21.



## Seat adjustment

### Longitudinal adjustment



Pull handle, slide seat, release handle.

Try to move the seat back and forth to ensure that the seat is locked in place.

Seat position ⇨ 45.

Seat adjustment ⇨ 46.

## Backrests inclination

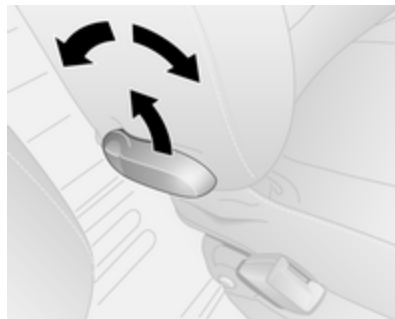

Pull lever, adjust inclination and release lever. Allow the backrest to engage. Do not lean on backrest when adjusting.

Seat position ⇨ 45.

Seat adjustment ⇨ 46.

## Seat height

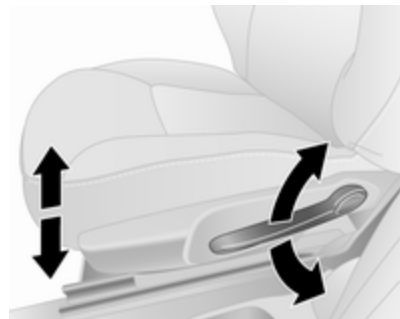

Lever pumping motion:

up : seat higher  
down : seat lower

Seat position ⇨ 45.

Seat adjustment ⇨ 46.

## Head restraint adjustment

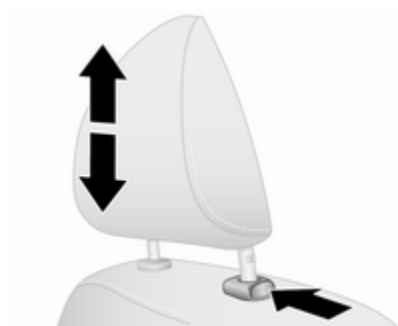

Press release button, adjust height, engage.

Head restraints ⇨ 44.

## Seat belt



Pull out the seat belt and fasten in belt buckle. The seat belt must not be twisted and must fit close against the body. The backrest must not be tilted back too far (maximum approx. 25°).

To unfasten belt, press red button on belt buckle.

Seat position ⇨ 45.

Seat belts ⇨ 53.

Airbag system ⇨ 58.

## Mirror adjustment

### Interior mirror



To adjust the mirror, move the mirror housing in the desired direction.

Interior mirror, Wide view mirror ⇨ 40.

Automatic anti-dazzle interior mirror ⇨ 41.

## Exterior mirrors

### Manual adjustment

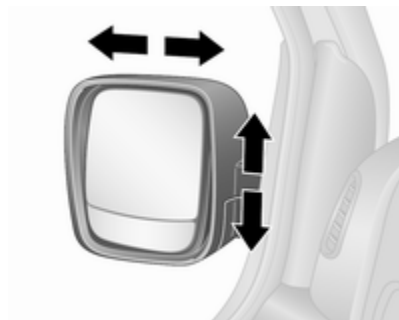

Swivel mirror in required direction.  
Exterior mirrors ⇨ 39.

### Electric adjustment



Select the relevant exterior mirror and adjust it.  
Convex exterior mirrors ⇨ 39.  
Electric adjustment ⇨ 39.  
Folding exterior mirrors ⇨ 39.  
Heated exterior mirrors ⇨ 40.

## Steering wheel adjustment

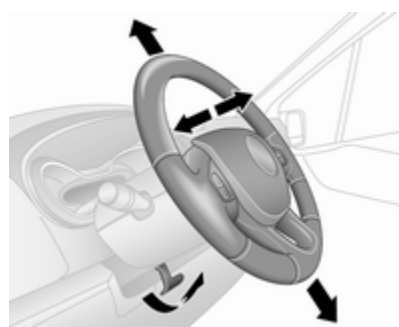

Unlock the lever, adjust the steering wheel, then engage the lever and ensure it is fully locked.

Do not adjust the steering wheel unless vehicle is stationary and the steering wheel lock has been released.

Airbag system ⇨ 58.

Ignition positions ⇨ 131.

## Instrument panel overview

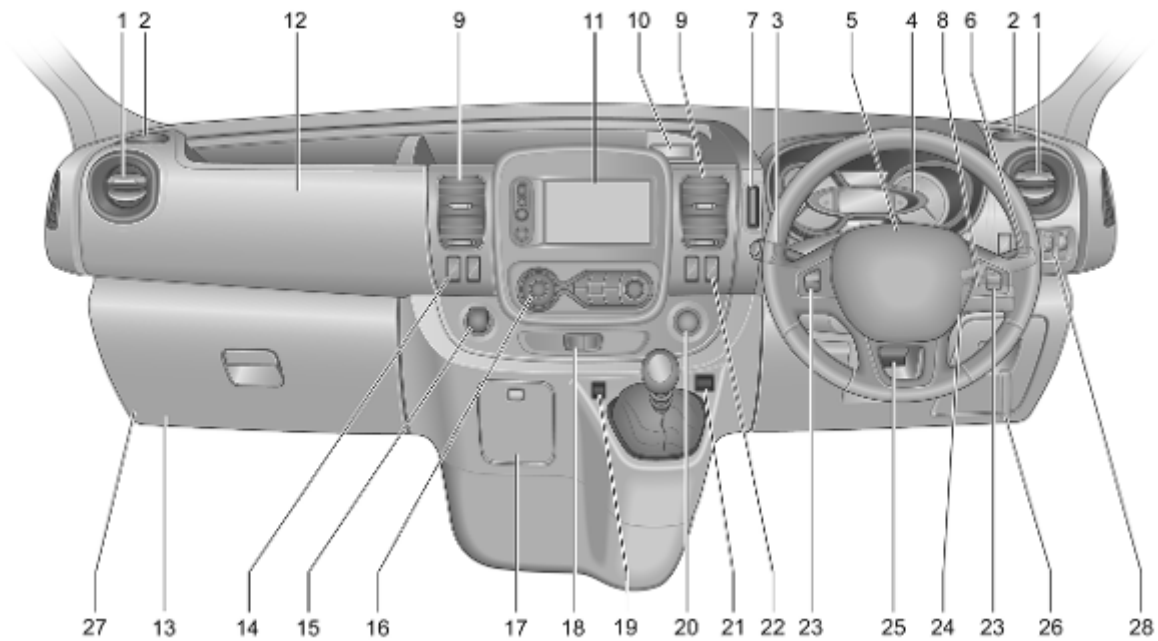



<p><b>1</b> Side air vents ..... 127</p> <p><b>2</b> Ashtray ..... 88</p> <p style="padding-left: 20px;">Cupholder ..... 73</p> <p><b>3</b> Light switch ..... 108</p> <p style="padding-left: 20px;">Rear fog light ..... 112</p> <p style="padding-left: 20px;">Front fog lights ..... 111</p> <p style="padding-left: 20px;">Exit lighting ..... 114</p> <p style="padding-left: 20px;">Turn lights ..... 111</p> <p style="padding-left: 20px;">Sidelights ..... 108</p> <p style="padding-left: 20px;">Headlight flash, low beam and high beam ..... 109</p> <p><b>4</b> Instruments ..... 89</p> <p style="padding-left: 20px;">Driver Information Centre .... 101</p> <p style="padding-left: 20px;">Trip computer ..... 104</p> <p><b>5</b> Horn ..... 83</p> <p style="padding-left: 20px;">Driver airbag ..... 61</p> <p><b>6</b> Windscreen wiper, windscreen washer system .. 84</p> <p style="padding-left: 20px;">Rear window wiper, rear window washer system ..... 85</p> <p style="padding-left: 20px;">Trip computer ..... 104</p>	<p><b>7</b> Card reader for electronic key system ..... 21</p> <p><b>8</b> Steering column controls ..... 83</p> <p><b>9</b> Centre air vents ..... 127</p> <p><b>10</b> Power outlet ..... 87</p> <p style="padding-left: 20px;">Cigarette lighter ..... 88</p> <p style="padding-left: 20px;">Coin tray, USB slot ..... 71</p> <p><b>11</b> Info display ..... 102</p> <p><b>12</b> Front passenger airbag ..... 61</p> <p><b>13</b> Glovebox ..... 72</p> <p><b>14</b> Heated exterior mirrors ..... 40</p> <p style="padding-left: 20px;">Heated rear window ..... 43</p> <p style="padding-left: 20px;">Idle speed control ..... 134</p> <p><b>15</b> Power outlet ..... 87</p> <p style="padding-left: 20px;">Cigarette lighter ..... 88</p> <p><b>16</b> Climate control system ..... 116</p> <p style="padding-left: 20px;">Electronic climate control system ..... 118</p> <p><b>17</b> Ashtray ..... 88</p> <p style="padding-left: 20px;">Cupholder ..... 73</p> <p><b>18</b> Hazard warning flashers ..... 111</p> <p style="padding-left: 20px;">Central locking system ..... 24</p>	<p><b>19</b> Front parking assist ..... 154</p> <p><b>20</b> Power button for electronic key system ..... 131</p> <p><b>21</b> Eco button for fuel economy mode ..... 129</p> <p><b>22</b> Stop-start system ..... 135</p> <p style="padding-left: 20px;">Cruise control ..... 151</p> <p style="padding-left: 20px;">Speed limiter ..... 153</p> <p><b>23</b> Remote control on steering wheel ..... 83</p> <p style="padding-left: 20px;">Cruise control ..... 151</p> <p><b>24</b> Ignition switch with steering wheel lock ..... 131</p> <p><b>25</b> Steering wheel adjustment ... 83</p> <p><b>26</b> Bonnet release lever ..... 166</p> <p><b>27</b> Fuse box ..... 182</p> <p><b>28</b> Rear parking assist ..... 154</p> <p style="padding-left: 20px;">Electronic Stability Control .. 149</p> <p style="padding-left: 20px;">Traction Control system ..... 148</p> <p style="padding-left: 20px;">Headlight range adjustment ..... 109</p> <p style="padding-left: 20px;">Instrument panel illumination control ..... 112</p>
--	---	--

Auxiliary heater .....	122
Speed limiter .....	153

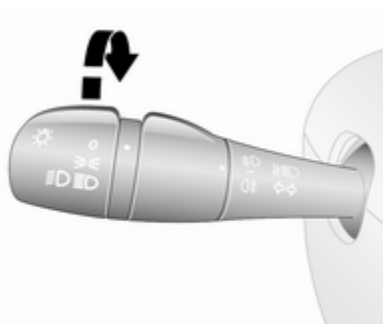
## Exterior lighting



Turn outer light switch:

- 0** : off
-  : sidelights
-  : headlights

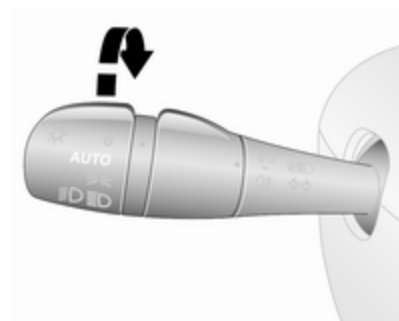

Vehicles with automatic light control:

**AUTO** : automatic light control:  
 exterior lighting is switched  
 on and off automatically  
 depending on external  
 lighting conditions.

Lighting ⇨ 108.

Automatic light control ⇨ 109.

Headlight warning device ⇨ 103.

### Front and rear fog lights

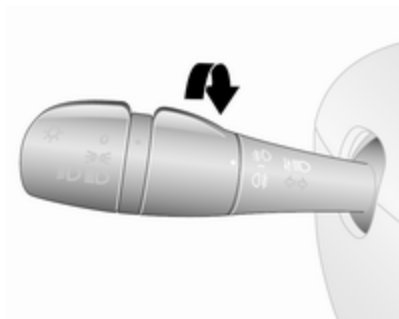

Turn inner light switch

☉ : front fog lights

☾ : rear fog light

Front fog lights ⇨ 111.

Rear fog light ⇨ 112.

### Headlight flash, high beam and low beam

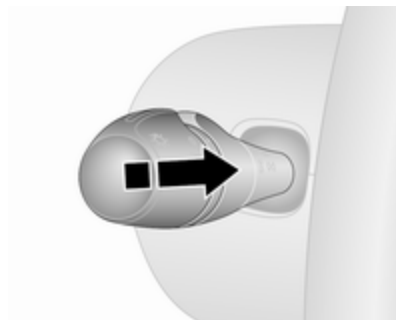

headlight flash : pull stalk

high beam : push stalk

low beam : push or pull stalk

Automatic light control ⇨ 109.

High beam ⇨ 109.

Headlight flash ⇨ 109.

### Turn lights

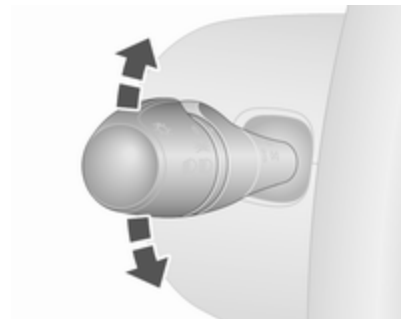

stalk up : right turn light

stalk down : left turn light

Turn lights ⇨ 111.

## Hazard warning flashers



Operated by pressing .

Hazard warning flashers ⇨ 111.

## Horn



Press .

## Washer and wiper systems

### Windscreen wiper

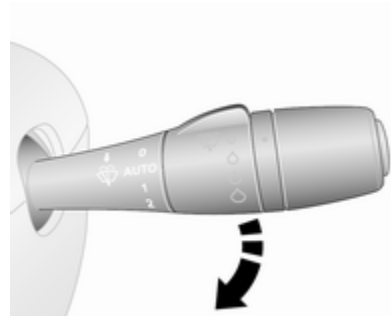

- 0** : off
- AUTO** or  : interval wiping or automatic wiping with rain sensor
- 1** : slow
- 2** : fast

Windscreen wiper ⇨ 84.

Wiper blade replacement ⇨ 174.



## Windscreen washer

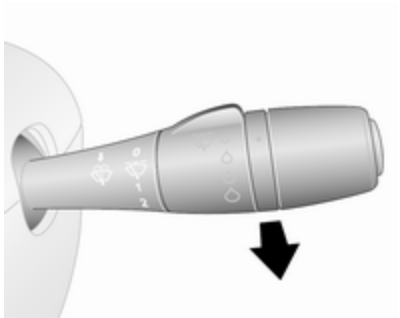

Pull lever.

Windscreen washer ↪ 84.

Washer fluid ↪ 170.

## Rear window wiper and washer system

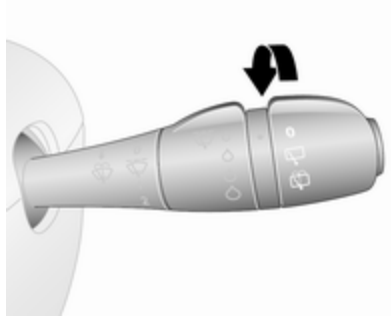

Turn lever:

- : off
- ☐ : wiper
- ☐ : washer

Rear window wiper and washer  
↪ 85.

Washer fluid ↪ 170.

## Climate control

### Heated rear window



Heating is operated by pressing ☐.

Heated rear window ↪ 43.

### Heated exterior mirrors



Pressing ☐ also activates the heated exterior mirrors.

Heated exterior mirrors ↪ 40.

## Demisting and defrosting the windows

### Climate control system





- Air distribution to .
- Set temperature control to warmest level.
- Set fan speed to highest level.
- Cooling **A/C** on.
- Heated rear window  on.

Climate control system ⇨ 116.

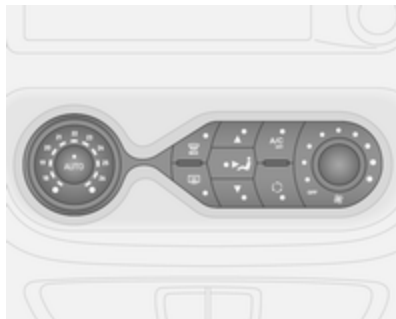
### Electronic climate control system



- Press . LED illuminates in the button when activated.
- Temperature, air distribution and cooling are regulated automatically and the fan runs at high speed.
- Switch on heated rear window  ⇨ 43.

Electronic climate control system  
⇨ 118.

## Transmission

### Manual transmission



Reverse: with the vehicle stationary, wait three seconds after depressing clutch pedal and then pull up the collar on the selector lever and engage the gear.

If the gear does not engage, set the lever to neutral, release the clutch pedal and depress again; then repeat gear selection.

Manual transmission ⇨ 145.

## Starting off

### Check before starting off

- Tyre pressure ⇨ 186 and condition ⇨ 213.
- Engine oil level and fluid levels ⇨ 167.
- All windows, mirrors, exterior lighting and number plates are free from dirt, snow and ice and are operational.
- Proper position of mirrors ⇨ 39, seats ⇨ 45 and seat belts ⇨ 54.
- Brake function at low speed, particularly if the brakes are wet.

### Starting the engine with key

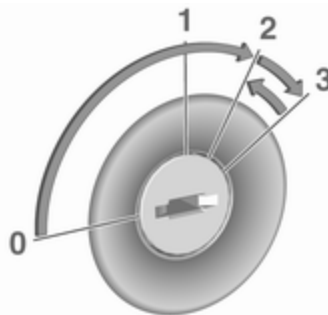

- Turn key to position 1.
- Move the steering wheel slightly to release the steering wheel lock.
- Operate clutch and brake pedal.
- Do not operate accelerator pedal.
- Diesel engines: turn the key to position 2 for preheating and wait until control indicator  extinguishes in the instrument cluster.
- Turn key to position 3 and release.

Starting the engine ⇨ 133.

### Starting the engine with the power button



Electronic key must be inside the vehicle, either in the card reader or the front passenger compartment.

- Move the steering wheel slightly to release the steering wheel lock.
- Operate clutch and brake pedal.
- Do not operate accelerator pedal.
- Press **START/STOP** and release.
- Engine starts after a short delay.

Power button ⇨ 131.

## Stop-start system



If the vehicle is at low speed or in standstill and certain conditions are fulfilled, activate an Autostop as follows:

- Depress the clutch pedal.
- Move the selector lever to neutral.
- Release the clutch pedal.

An Autostop is indicated when **A** illuminates in the instrument cluster ↪ 100.

To restart the engine, depress the clutch pedal again.

Stop-start system ↪ 135.

## Parking

### ⚠ Warning

- Do not park the vehicle on an easily ignitable surface. The high temperature of the exhaust system could ignite the surface.
- Always apply parking brake without pressing release button. Apply as firmly as possible on a downhill slope or uphill slope. Depress brake pedal at the same time to reduce operating force.
- Switch off the engine.
- If the vehicle is on a level surface or uphill slope, engage first gear. On an uphill slope, turn the front wheels away from the kerb.

If the vehicle is on a downhill slope, engage reverse gear. Turn the front wheels towards the kerb.

- Close the windows.
- Remove the ignition key from the ignition switch. Turn the steering wheel until the steering wheel lock is felt to engage.

- Lock the vehicle by pressing **T** on the remote control ↪ 24.

Activate the anti-theft locking system ↪ 35 and anti-theft alarm system ↪ 36.

- The engine cooling fans may run after the engine has been switched off ↪ 166.

### Caution

After running at high engine speeds or with high engine loads, operate the engine briefly at a low load or run in neutral for approx. 30 seconds before switching off, in order to protect the turbocharger.

Keys, locks ↪ 19.

Laying the vehicle up for a long period of time ↪ 165.

## Keys, doors and windows

<b>Keys, locks</b> .....	<b>19</b>
Keys .....	19
Car Pass .....	20
Radio remote control .....	20
Electronic key system .....	21
Door locks .....	24
Central locking system .....	24
Automatic locking .....	30
Child locks .....	30
<b>Doors</b> .....	<b>31</b>
Sliding door .....	31
Rear doors .....	31
Load compartment .....	33
<b>Vehicle security</b> .....	<b>35</b>
Anti-theft locking system .....	35
Anti-theft alarm system .....	36
Immobiliser .....	38
<b>Exterior mirrors</b> .....	<b>39</b>
Convex shape .....	39
Manual adjustment .....	39
Electric adjustment .....	39
Folding mirrors .....	39
Heated mirrors .....	40

<b>Interior mirrors</b> .....	<b>40</b>
Manual anti-dazzle .....	40
Automatic anti-dazzle .....	41
<b>Windows</b> .....	<b>41</b>
Windscreen .....	41
Power windows .....	42
Rear windows .....	42
Heated rear window .....	43
Sun visors .....	43

## Keys, locks

### Keys

<b>Caution</b>
Do not attach heavy or bulky items to the ignition key.

### Replacement keys

The key number is specified on the key or on a detachable tag.

The key number must be quoted when ordering replacement keys as it is a component of the immobiliser system.

If the electronic key needs to be replaced, the vehicle must be taken to a workshop.

Locks ⇨ 200.

Radio remote control ⇨ 20.

Electronic key system ⇨ 21.

Central locking system ⇨ 24.

Starting the engine ⇨ 133.

## Lock cylinders

Designed to free-wheel if they are forcefully rotated without the correct key or if the correct key is not fully inserted. To reset, turn cylinder with the correct key until its slot is vertical, remove key and then re-insert it. If the cylinder still free-wheels, turn the key through 180° and repeat operation.

## Car Pass

The Car Pass contains security related vehicle data and should therefore be kept in a safe place.

When the vehicle is taken to a workshop, this vehicle data is needed in order to perform certain operations.

## Radio remote control



Used to operate:

- central locking system ⇨ 24
- load compartment ⇨ 33
- anti-theft locking system ⇨ 35
- anti-theft alarm system ⇨ 36

The remote control has a range of approx. 5 m. It can be restricted by external influences. The hazard warning flashers confirm operation.

Handle with care, protect it from moisture and high temperatures and avoid unnecessary operation.

Depending on model, the vehicle may use a 2-button or 3-button remote control or an electronic key which includes the functionality of the remote control.

Electronic key system ⇨ 21.

## Fault

If the central locking system cannot be operated with the remote control, it may be due to the following:

- The range is exceeded.
- The battery voltage is too low.
- Frequent, repeated operation of the remote control while not in range, which will require reprogramming by a workshop.
- Overload of the central locking system by operating at frequent intervals; the power supply is interrupted for a short time.
- Interference from higher-power radio waves from other sources.

Manual key operation ⇨ 24.

## Remote control battery replacement

Replace the battery as soon as the range reduces.



Batteries do not belong in household waste. They must be disposed of at an appropriate recycling collection point.



Remove screw and open battery compartment by inserting a coin into the slot and twisting.

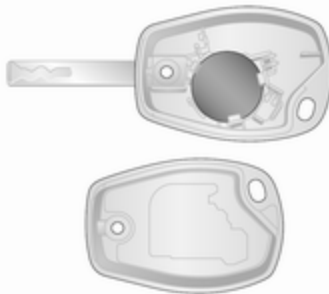

Replace the battery (battery type CR2016), paying attention to the installation position.

Reattach both halves of the cover, ensuring they engage correctly.

Replace screw and tighten.

## Electronic key system

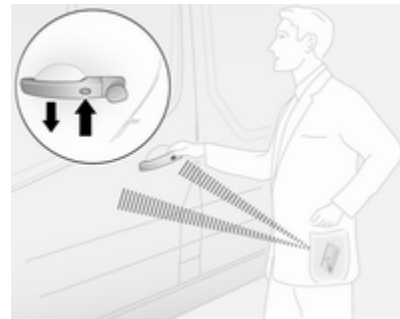

Enables a hands-free operation of the following functions:

- central locking system ⇨ 24
- load compartment ⇨ 33
- ignition switching on and starting the engine ⇨ 131
- anti-theft locking system ⇨ 35
- anti-theft alarm system ⇨ 36

The electronic key simply needs to be on the driver's person.

**Notice**

Always take the electronic key with you when exiting the vehicle.

The electronic key being left in the card reader is indicated by a warning chime ↻ 103 and a message in the Driver Information Centre ↻ 102 when the driver's door is opened.

Additionally, the electronic key includes the functionality of the remote control ↻ 20 and an entry lighting function ↻ 114.

For hands-free operation, the electronic key must be outside the vehicle, within a range of approx. 1 m of the front doors or load compartment. The range of operation for the electronic key buttons can be restricted by external influences. The hazard warning flashers confirm operation.

Handle with care, protect from moisture and high temperatures and avoid unnecessary operation.

**Notice**

Do not put the electronic key in the load compartment during driving, as this is outside of the detection zone

(indicated by a warning chime at low speed ↻ 103 and a message in the Driver Information Centre ↻ 102).

**Notice**

In the event the electronic key is kept in the front passenger compartment and a message appears in the Driver Information Centre (possibly accompanied by a warning chime) indicating that it is out of reception range, we recommend inserting the electronic key in the card reader.

**Notice**

If the electronic key is not detected in the front passenger compartment after opening and closing a door with the engine running, a message appears in the Driver Information Centre (accompanied by a warning chime when a certain speed is exceeded), indicating that it is out of reception range.

This helps you avoid, e.g., driving off after dropping off a passenger who has the electronic key.

The message disappears when the electronic key is detected again.

Hands-free operation is automatically disabled when the electronic key buttons have been operated or the central locking switch  ↻ 24 is pressed. To re-enable hands-free operation, restart the engine.

Power button ↻ 131.

**Electronic key battery replacement**

Replace the battery as soon as the system no longer operates properly or the range is reduced. The need for battery replacement is indicated by a message in the Driver Information Centre ↻ 102.



Batteries do not belong in household waste. They must be disposed of at an appropriate recycling collection point.



The need for battery replacement is indicated by a message in the Driver Information Centre ↗ 102.

### Notice

In an emergency, the vehicle can still be locked / unlocked using the emergency manual key in the housing of the electronic key ↗ 21.

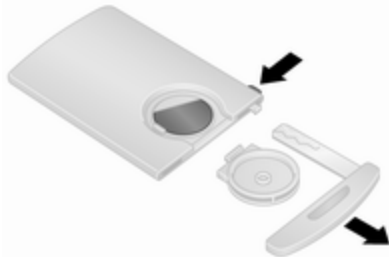

Press and hold the release button on the side of the electronic key and pull out the emergency manual key from the top. Unclip the battery cover located on the rear of the electronic key, then press one side of the battery to release and remove the battery.

Replace the battery (battery type CR2016), paying attention to the installation position.

Reattach battery cover and reinsert the emergency manual key.

### Electronic key synchronisation

Press any button on the electronic key four times within range of the detection zone (approx. 1 m) of the front doors or load compartment. The electronic key will be synchronised when the ignition is switched on.

### Fault

If the central locking system cannot be operated or the engine cannot be started, the cause may be one of the following:

- fault in electronic key
- electronic key out of reception range
- battery voltage too low

- overload of the central locking system by operating at frequent intervals, the power supply is interrupted for a short time
- interference from higher-power radio waves from other sources

### Emergency manual key

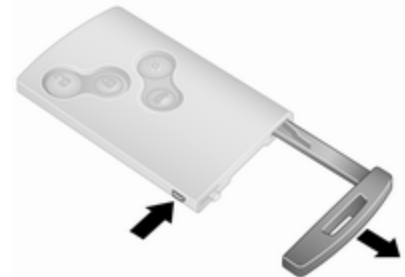

Press and hold the release button on the side of the electronic key and pull out the emergency manual key from the top.

Manually lock or unlock the doors by turning the key in the lock.

After use, reinsert the emergency manual key in the housing of the electronic key.

## Door locks

### Anti-theft security lock



To prevent the doors from being opened from the outside, open the driver's door and engage the anti-theft security lock.

Using a suitable tool, turn the lock switch on the door to the locked position. The doors/tailgate cannot be opened from outside.

The anti-theft security lock remains engaged even after unlocking the vehicle with the remote control. The doors / tailgate can only be opened from inside or by using the manual key.

#### Notice

Depending on version, the tailgate may remain unlocked when the anti-theft security lock is engaged.

To disengage, turn the switch to the unlocked position.

### Rear door manual lock



Turn the lock switch clockwise to lock the left-hand rear door from inside the load compartment. To disengage lock, turn the switch anticlockwise.

Rear doors ⇨ 31.

## Central locking system

Unlocks and locks the front doors, sliding side doors and load compartment.

With the 3-button remote control, the front doors and load compartment/ sliding side doors (where fitted) can be unlocked and locked separately.

For safety reasons, the vehicle cannot be locked if the key is in the ignition switch.

#### Notice

If no door is opened within approx. two minutes after the vehicle has been unlocked, the vehicle is re-locked automatically.

Close doors and load compartment. If the doors are not closed properly, the central locking system will not work.

Refer to "Manual key operation" below for further information.

## Remote control operation

Operation of central locking system with the remote control is confirmed by the hazard warning flashers. The hazard warning flashers flash once to indicate the vehicle is unlocked, and twice to indicate the vehicle is locked.



### Unlocking with 2-button remote control



Depending on model and configuration:

- Press and hold  to unlock all doors and the load compartment.



- or -

- Press  once to unlock the driver's door, and press  twice to unlock all doors and the load compartment.

### Unlocking with 3-button remote control



Depending on model and configuration:

- Press and hold  to unlock all doors and the load compartment.
- or -
- Press  once to unlock the driver's door, and press  twice to

unlock all doors and the load compartment.

- or -

- Press  once to unlock all doors and the load compartment.

### Locking with 2-button remote control





Press : All doors and the load compartment are locked.

## Locking with 3-button remote control



Press : All doors and the load compartment are locked.

**Notice**

Where fitted, alarm monitoring of the passenger compartment  36 is switched off by pressing and holding  (which is confirmed by an audible signal).

If this was done unintentionally, unlock the doors again and press  briefly to lock the vehicle.

## Load compartment locking and unlocking with 2-button remote control



Depending on model and configuration, press  once or twice to unlock the load compartment (and sliding side doors).

Press  to lock the load compartment (and, depending on version, the sliding side doors).

## Load compartment locking and unlocking with 3-button remote control



Press  to lock or unlock load compartment (and, depending on version, the sliding side doors).

## Electronic key system operation



For hands-free operation, the electronic key must be outside the vehicle, within a range of approx. 1 m of the front doors or load compartment.

### Notice

There is no button for hands-free operation in the exterior door handle of the sliding side door.

There must be no electronic key left inside the vehicle and no additional electronic key in the detection zones, or hands-free operation of the central locking system will not work.

Operation of central locking system with the electronic key is confirmed by the hazard warning flashers. The hazard warning flashers flash once to indicate the vehicle is unlocked, and twice to indicate the vehicle is locked.

When locking, if a door is open or incorrectly closed, the central locking system will lock and unlock in quick succession without flashing the hazard warning flashers.

### **⚠ Danger**

Never leave an electronic key inside the vehicle when children or animals are left in the vehicle, to avoid unintended operation of windows, doors or engine. Risk of fatal injury.

## Unlocking with electronic key - hands-free operation

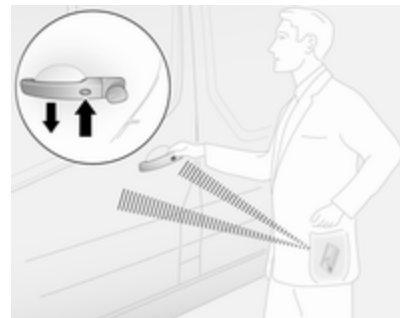

Press the button on either front door exterior handle to unlock, and pull the handle to open.

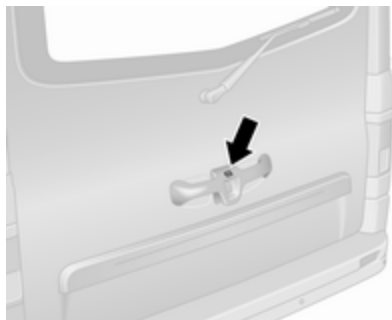

For the rear doors / tailgate, press the button on the exterior handle to unlock, and pull the handle to open.

The vehicle only unlocks when at least three seconds have passed since locking using hands-free operation.

Hands-free operation is automatically disabled when the electronic key buttons have been operated. To re-enable hands-free operation, restart the engine.

### Unlocking with electronic key buttons



Press  to unlock all doors and the load compartment.

### Locking with electronic key - hands-free operation

Press the button on any exterior door handle. All doors and the load compartment are locked.

The vehicle only locks when at least 3 seconds have passed since unlocking using hands-free operation.

Hands-free operation is automatically disabled when the electronic key buttons have been operated. To re-enable hands-free operation, restart the engine.

### Locking with electronic key buttons



Press  to lock all doors and the load compartment.

### Load compartment locking and unlocking with electronic key - hands-free operation

Press the button on the exterior door handle to lock or unlock the rear doors / tailgate (and sliding side

doors) when the electronic key is within range of the detection zone (approx. 1 m).

The rear doors / tailgate (and sliding side doors) only lock / unlock when at least 3 seconds have passed since the button was last pressed.

Hands-free operation is automatically disabled when the electronic key buttons have been operated. To re-enable hands-free operation, restart the engine.

### Load compartment locking and unlocking with electronic key buttons



Press  to lock / unlock the rear doors / tailgate (and sliding side doors).

Electronic key system ⇨ 21.

### Manual key operation

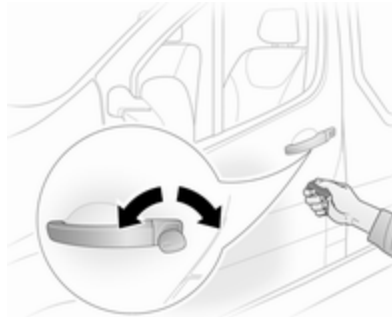

Manually lock or unlock the doors by turning the key in the lock.

#### Notice

If the battery in the electronic key needs to be replaced, the vehicle can still be locked / unlocked using the emergency manual key in the housing of the electronic key ⇨ 21.

### Central locking switch

Locks or unlocks the doors and load compartment from the passenger compartment.



Press  to lock the vehicle. Activation is indicated by the LED in the button. When closing any open door, the door is locked automatically.

Press  again to unlock the vehicle.

If the vehicle is driven with an open load compartment, the front doors (and sliding side doors) can still be locked. With the ignition switched on, press and hold  for approx.

5 seconds. When closing the rear doors / tailgate, they are locked automatically.

Automatic locking ⇨ 30.

Hands-free operation is automatically disabled when  is pressed. To re-enable hands-free operation, restart the engine.

Electronic key system ⇨ 21.

## Automatic locking

### Automatic locking after driving off

This security feature can be configured to automatically lock the doors and load compartment as soon as the vehicle is driven.

### Activation

With the engine running, press and hold  on the central locking switch for approx. 5 seconds. An audible signal confirms activation.

### Deactivation

With the engine running, press and hold  on the central locking switch for approx. 5 seconds. An audible signal confirms deactivation.

Central locking switch ⇨ 24.

## Child locks

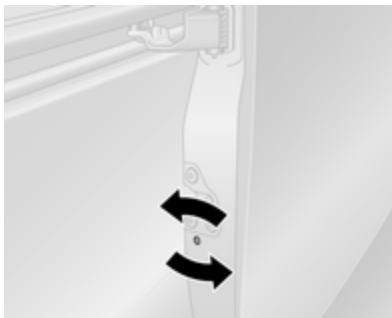

The child safety lock for the sliding side door is located on its rearward facing edge.

To prevent the sliding side door from being opened from the inside, open the door and engage the child lock.

### Warning

Use the child locks whenever children are occupying the rear seats, to prevent unintentional opening from the inside.

Using a suitable tool, turn the child lock switch in the sliding side door to the locked position; the door cannot be opened from the inside.

The child lock remains engaged even after unlocking the vehicle with the remote control. The door can only be opened from outside.

To disengage, turn the child lock switch to the unlocked position.



## Doors

### Sliding door

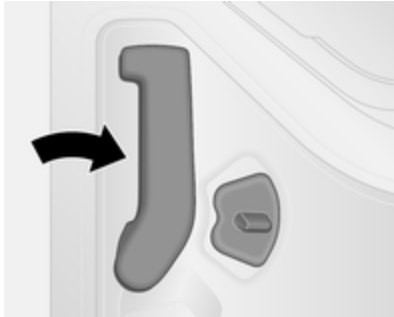

Open and close the sliding side door only when the vehicle is at a standstill with the parking brake applied.

Pull the handle towards the rear to unlock and open from the inside.

The door can be locked from inside the vehicle with the interior lock switch.

Central locking system ⇨ 24.

### ⚠ Warning

Take care when operating the sliding side door. Risk of injury.

Ensure that nothing becomes trapped during operation and no-one is standing within the moving area.

If the vehicle is parked on a slope, open sliding doors may move accidentally on account of their weight.

Close the sliding doors before driving off.



The right-hand rear door is released using the lever.

### ⚠ Warning

The rear lights may be obscured if the rear doors are open and the vehicle is parked on the roadside.

Make other road users aware of the vehicle, by using a warning triangle or other equipment specified in the road traffic regulations.

### Rear doors

The rear doors can only be opened if the vehicle is unlocked.

Central locking system ⇨ 24.

To open the left-hand rear door, pull the outside handle.

The door is opened from inside the vehicle by pulling the interior handle.



The doors are retained in the 90° position by locking stays. To open the doors to 180° or further, pull the door release handles and swing open to the desired position.

### **⚠ Warning**

Ensure extended opening doors are secured when fully opened.

Opened doors may slam closed due to the force of the wind!

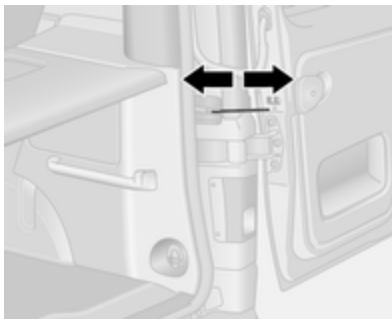

When closing the doors, secure each locking stay to the catch on the door frame.

Always close the right-hand door before the left-hand door.

Door locks ⇨ 24.

Central locking system ⇨ 24.

### Driving with an open load compartment



In exceptional cases only, to drive with the right-hand rear door open (e.g. if long objects need to be transported), open the left-hand followed by the right-hand rear door, then close the left-hand rear door.

### **Notice**

Do not use the left-hand rear door to hold objects in place.

If possible, secure objects with lashing straps attached to lashing eyes ⇨ 77.

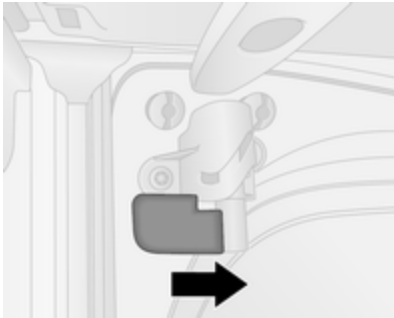

Engage the interior lock in its housing by turning the handle clockwise to the locked position. The door is bolted and cannot be opened from outside.

#### Notice

The number plate is only distinguishable and illuminated correctly if the rear doors are closed.

Disengage the lock by turning the handle anticlockwise, to enable the door to be opened.

#### Caution

Always make sure that the load in the vehicle is securely stowed when driving with an open load compartment.

For further information, refer to "Loading information" ⇨ 80.

Always comply with local or national regulations.

#### ⚠ Danger

Engine exhaust gases contain poisonous carbon monoxide, which is colourless and odourless and could be fatal if inhaled.

When driving with an open load compartment, exhaust gases could enter the vehicle. Open the windows.

## Load compartment

### Tailgate

#### Opening

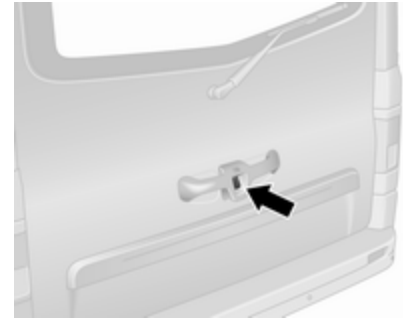

After unlocking, press tailgate button and lift tailgate to the fully open position.

The tailgate can be also opened from inside the vehicle by operating the tailgate interior release.

#### Notice

In very cold climates, the opening assistance provided by the tailgate hydraulic struts may be reduced.

Central locking system ⇨ 24.

## Closing

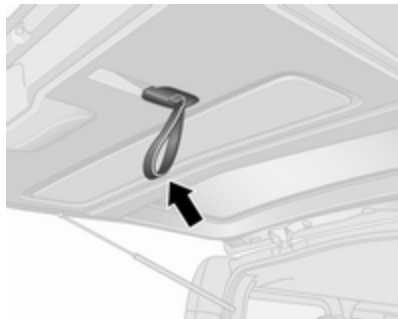

Lower the tailgate using the interior strap.

**Caution**

Place fingers through the strap before pulling, to avoid damage to the strap.

Release strap when tailgate is lowered and push tailgate to close fully.

Central locking system ⇨ 24.

## Emergency tailgate opening from inside the vehicle



Depending on model, prise off the cover on the inside of the tailgate.

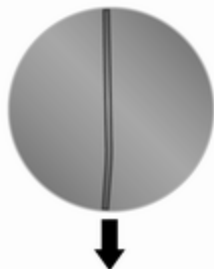

Then grasp the metal string and pull it downwards to unlock. Push the tailgate to open.

**General hints for operating tailgate****⚠ Danger**

Do not drive with the tailgate open or ajar, e.g. when transporting bulky objects, since toxic exhaust gases, which can not be seen or smelled, could enter the vehicle. This can cause unconsciousness and even death.

**Caution**

Before opening the tailgate, check overhead obstructions, e.g. a garage door, to avoid damage to the tailgate.

Ensure there is adequate clearance both above (at least 2.15 m) and behind when opening tailgate.

**Notice**

The installation of certain heavy accessories onto the tailgate may affect its ability to remain open.

**Vehicle security****Anti-theft locking system****⚠ Warning**

Do not use the system if there are people in the vehicle! The doors cannot be unlocked from the inside.

The system deadlocks all doors and the load compartment.

All doors and the load compartment must be closed or the system cannot be activated.

**Notice**

The anti-theft locking system cannot be activated when the hazard warning lights or sidelights are switched on.

Activation and deactivation are not possible with the central locking switch.

Central locking system ⇨ 24.

**2-button and 3-button remote control operation**

Operation is confirmed by the hazard warning flashers flashing five times.

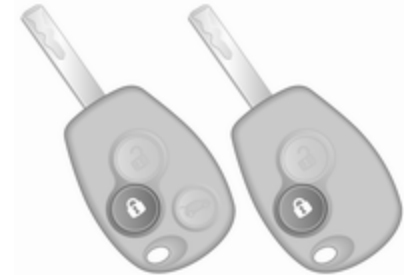
**Activation**

Press  twice.

- or -

Turn manual key in driver's door lock towards rear of vehicle twice.

**Deactivation**

Unlock the doors by pressing  on the remote control or by turning the manual key in driver's door lock towards front of vehicle.

## Electronic key system operation

Operation is confirmed by the hazard warning flashers.

### Activation

For hands-free operation, the electronic key must be outside the vehicle, within a range of approx. 1 m of the front doors or load compartment.

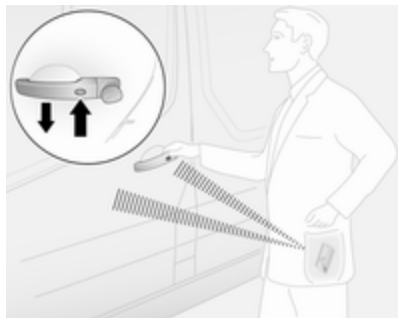

Press the button twice on any exterior door handle.

- or -



Press  twice.

### Deactivation

Unlock the doors by pressing the button on any exterior door handle or press .

Hands-free operation is automatically disabled when the electronic key buttons have been operated (or the central locking switch  is pressed). To re-enable hands-free operation, restart the engine.

Central locking system ⇨ 24.

Electronic key system ⇨ 21.

## Anti-theft alarm system

The anti-theft alarm system is operated in conjunction with the central locking system ⇨ 24.

It monitors:

- doors, rear doors / tailgate, bonnet
- passenger compartment
- load compartment
- ignition
- interruption of alarm siren power supply

### Activation

All doors and the bonnet must be closed.

Hazard warning lights flash to confirm activation. If the hazard warning lights do not flash upon activation, a door or the bonnet is not fully closed.

## 2-button and 3-button remote control

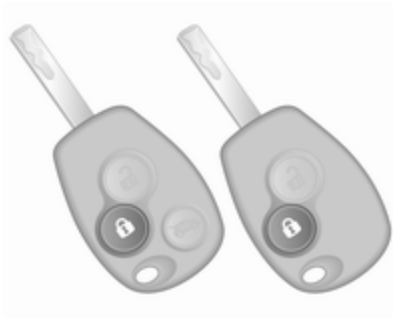

Press  to activate the anti-theft alarm system.

### Electronic key

For hands-free operation, the electronic key must be outside the vehicle, within a range of approx. 1 m of the front doors or load compartment.

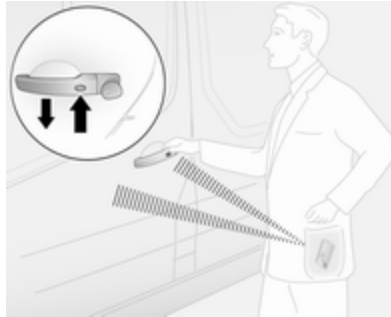

Press the button on any exterior door handle.

- or -



Press  to activate the anti-theft alarm system.

Electronic key system  21.

### Deactivation

Unlocking the vehicle (with  or the button on any exterior door handle) or switching on the ignition deactivates the anti-theft alarm system. Hazard warning lights flash to confirm deactivation.

The system is not deactivated when unlocking the driver's door with the key or with the central locking switch in the passenger compartment.

### Notice

If the alarm has been triggered, unlocking the vehicle with the key will not stop the alarm siren. To stop the siren, switch on the ignition. The hazard warning lights will not flash upon deactivation if the alarm has been triggered.

### Activation without monitoring of passenger compartment

Disable monitoring of the passenger compartment, e.g. when animals are being left in the vehicle, or if the auxiliary heater has been set for a timed or remote controlled start ↗ 122.

Press and hold  on the remote control or electronic key. An audible signal will sound as confirmation.

The status will remain until the doors are unlocked.

### Alarm

When triggered, the alarm sounds via a separate battery-backed power sounder, and the hazard warning lights flash simultaneously. The number and duration of alarm signals are stipulated by legislation.

If the vehicle battery is disconnected or its power supply is interrupted, the alarm siren will be triggered. First deactivate the anti-theft alarm system if the vehicle battery must be disconnected.

To silence the alarm siren (if triggered) and therefore deactivate the anti-theft alarm system, reconnect vehicle battery and unlock the vehicle or switch on the ignition.

### Immobiliser

The immobiliser is part of the ignition switch and checks whether the vehicle is allowed to be started with the key being used.

The immobiliser is activated automatically after the key has been removed from the ignition switch and also if the key is left in the ignition switch when the engine is turned off.

If the engine cannot be started, switch off the ignition and remove key, wait approx. two seconds and then repeat the start attempt. If start attempt is unsuccessful, attempt to start the engine using the spare key and seek the assistance of a workshop.

### Notice

Radio Frequency Identification (RFID) tags may cause interference with the key. Do not have it placed near the key when starting the vehicle.

### Notice

The immobiliser does not lock the doors. You should always lock the vehicle after leaving it and switch on the anti-theft alarm system ↗ 24, ↗ 36.



## Exterior mirrors

### Convex shape

The convex exterior mirror contains an aspherical area and reduces blind spots. The shape of the mirror makes objects appear smaller, which will affect the ability to estimate distances.

### Manual adjustment

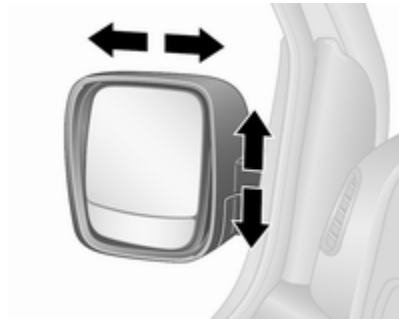

Adjust mirrors by swivelling in required direction.

### Electric adjustment



Select the relevant exterior mirror by switching the control to the left or right, then swivel the control to adjust the mirror.

No mirror is selected when the control is in the centre position.

### Folding mirrors

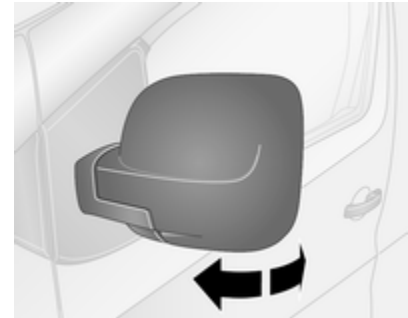

For pedestrian safety, the exterior mirrors will swing out of their normal mounting position if they are struck with sufficient force. Reposition the mirror by applying slight pressure to the mirror housing.

### Parking position

The exterior mirrors can be folded in by pressing gently on the outer edge of the housing, e.g. when in a confined parking situation.

Depending on version, exterior mirrors can be automatically folded to the parking position upon locking the vehicle. For further information, refer to the Infotainment manual.

## Heated mirrors



Operated by pressing . Activation is indicated by the LED in the button.

Heating functions with the engine running. It is switched off automatically after a short time.

Climate control system ⇨ 116.

## Interior mirrors

### Manual anti-dazzle



To reduce dazzle, adjust the lever on the underside of the mirror housing.

## Wide view mirror



Depending on vehicle, a large convex mirror is located in the front passenger sun visor which helps to increase visibility and reduce blind spots.

## Automatic anti-dazzle



Dazzle from following vehicles is automatically reduced, when driving in the dark.

## Windows

### Windscreen

#### Heat-reflecting windscreen

The heat-reflecting windscreen has a coating which reflects solar radiation. Also data signals, e.g. from toll stations, might be reflected.



The marked areas on the windscreen are not covered with the coating. Devices for electronic data recording and fee payment must be attached in these areas. Otherwise data recording malfunctions may occur.

### Windscreen stickers

Do not attach stickers such as toll road stickers or similar on the windscreen in the area of the interior mirror.

### Windscreen replacement

#### Caution

If the vehicle has a front-looking camera sensor for the driver assistance systems, it is very important that any windscreen replacement is performed accurately according to Vauxhall specifications. Otherwise, these systems may not work properly and there is a risk of unexpected behaviour and/or messages from these systems.

## Power windows

### ⚠ Warning

Take care when operating the power windows. Risk of injury, particularly to children.

Keep a close watch on the windows when closing them. Ensure that nothing becomes trapped in them as they move.

Switch on ignition to operate the power windows.



Operate the switch for the respective window by pushing to open or pulling to close.

For incremental operation: Push or pull switch briefly.

For automatic opening or closing: Push or pull switch for longer. Window moves up or down automatically with safety function enabled. To stop movement, operate the switch once more in the same direction.

In the event of closing difficulties due to frost or the like, operate the switch several times to close the window in stages.

### Safety function

If the window glass encounters resistance during automatic closing, it is immediately stopped and opened again.

### Overload

If the windows are repeatedly operated within short intervals, the window operation is disabled for some time.

## Rear windows

### Sliding side windows

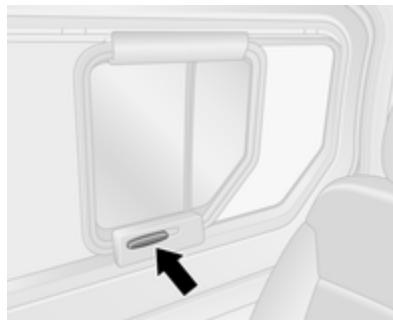

To open or close, first release the window by pushing the front part of the handle down until it reaches the vertical position then slide window.

## Sun blind

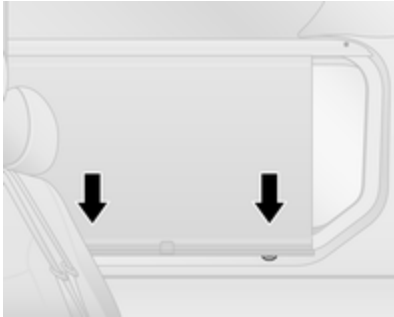

Depending on vehicle, a sunblind is integrated into the window cover.

To close, pull handle downwards and engage the locks at the bottom.

To open, disengage the locks by pulling sunblind towards you slightly and guide it upwards.

## Heated rear window



Operated by pressing . Activation is indicated by the LED in the button.

Heating functions with the engine running and is switched off automatically after a short time.

Climate control system ↗ 116.

## Sun visors

The sun visors can be folded down or swivelled to the side to prevent dazzling.

Sun visors have vanity mirrors and a ticket holder on the rear.

The mirror covers should be closed when driving.

Wide view mirror ↗ 40.

## Seats, restraints

<b>Head restraints</b> .....	<b>44</b>
<b>Front seats</b> .....	<b>45</b>
Seat position .....	45
Seat adjustment .....	46
Seat folding .....	48
Armrest .....	48
Heating .....	48
<b>Rear seats</b> .....	<b>49</b>
<b>Seat belts</b> .....	<b>53</b>
Three-point seat belt .....	54
<b>Airbag system</b> .....	<b>58</b>
Front airbag system .....	61
Side airbag system .....	61
Curtain airbag system .....	62
Airbag deactivation .....	62
<b>Child restraints</b> .....	<b>64</b>
Child restraint systems .....	64
Child restraint installation locations .....	66

## Head restraints

### Position

#### ⚠ Warning

Only drive with the head restraint set to the proper position.

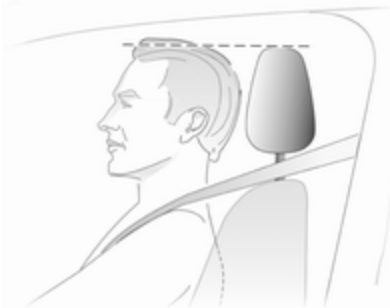

The upper edge of the head restraint should be at upper head level. If this is not possible for extremely tall people, set to highest position, and set to lowest position for small people.

### Adjustment

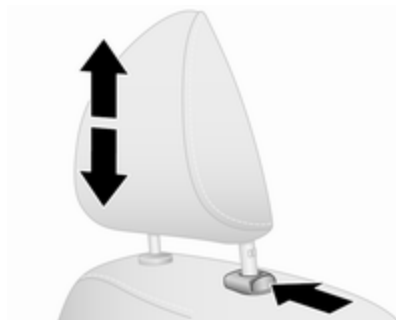

To raise, pull up head restraint and engage.

To lower, press release button, adjust height and engage.



The rear seat head restraints can also be folded forwards.

#### Notice

Approved accessories may only be attached to the front passenger seat head restraint if the seat is not in use.

#### Removal

E.g. when using a child restraint system ⇨ 64.

First tilt the backrest forwards, then pull up head restraint to uppermost position. Press release button and pull the head restraint upwards to remove.

Stow head restraints securely in load compartment.

Do not drive with head restraints removed if the seat is occupied.

#### Installation

First tilt the backrest forwards, then insert the rods of the head restraint into their holes.

Lower head restraint as far as possible, then raise head restraint (press release button first if necessary) until it engages securely in desired position.

## Front seats

### Seat position

#### ⚠ Warning

Only drive with the seat correctly adjusted.

#### ⚠ Danger

Do not sit closer than 25 cm to the steering wheel, to permit safe airbag deployment.

#### ⚠ Warning

Never adjust seats while driving as they could move uncontrollably.

#### ⚠ Warning

Never store any loose objects under the seats.

Underseat storage, storage box ⇨ 74.



- Sit with buttocks as far back against the backrest as possible. Adjust the distance between the seat and the pedals so that legs are slightly angled when pressing the pedals. Slide the front passenger seat as far back as possible.
- Set seat height high enough to have a clear field of vision on all sides and of all display instruments. There should be at least one hand of clearance between head and the roof frame. Thighs should rest lightly on the seat without pressing into it.

- Sit with shoulders as far back against the backrest as possible. Set the backrest rake so that it is possible to reach the steering wheel with arms slightly bent. Maintain contact between shoulders and the backrest when turning the steering wheel. Do not angle the backrest too far back. We recommend a maximum rake of approx. 25°.
- Adjust seat and steering wheel in a way that the wrist rests on top of the steering wheel while the arm is fully extended and shoulders on the backrest.
- Adjust the steering wheel ↻ 83.
- Adjust the head restraint ↻ 44.
- Adjust the height of the seat belt ↻ 54.
- Adjust the lumbar support so that it supports the natural shape of the spine ↻ 46.

### Seat adjustment

Drive only with engaged seats and backrests.

### Longitudinal adjustment



Pull handle, slide seat, then release handle.

Try to move the seat back and forth to ensure that the seat is locked in place.



### Backrest inclination



Pull lever, adjust inclination and release lever. Allow the backrest to engage audibly.

Do not lean on backrest when adjusting.

### Seat height

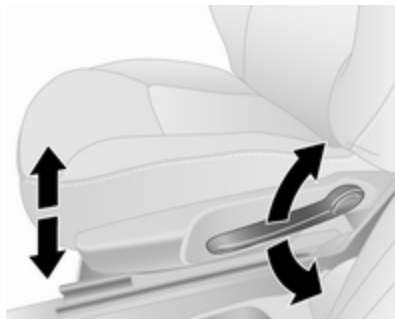

Lever pumping motion:

up : seat higher  
down : seat lower

### Lumbar support

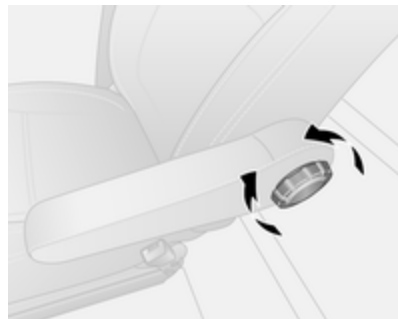

Adjust lumbar support using handwheel to suit personal requirements.

Rotate handwheel to increase and decrease support.

## Seat folding

### Folding front centre passenger seat

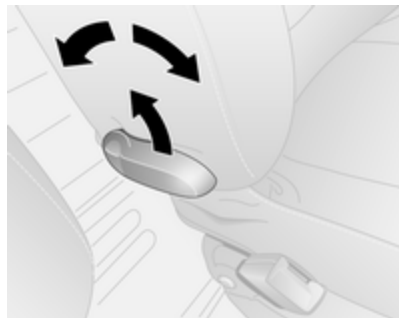

Pull release lever, fold backrest fully forwards then release the lever. Allow the backrest to engage audibly.

#### Notice

When seat height is in its highest position, push head restraints down before folding backrest.

Ensure that nothing prevents the seat from folding, e.g. sun visor ↪ 43, cup holder ↪ 73.

To restore, pull release lever, raise backrest then release the lever. Allow the backrest to engage audibly.

#### ⚠ Warning

When the front passenger seat is in the folded position, the front passenger airbag system must be deactivated.

Airbag deactivation ↪ 62.

### Armrest

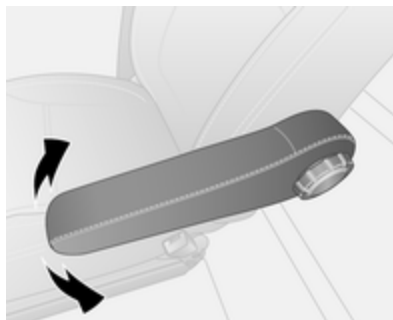

Fold away armrest in most upright position when not required or to enable movement into lowest position.

Raise the armrest as required.

### Heating



Press  for the respective seat when the engine is running; LED in switch illuminates. Press other end of rocker switch to turn seat heating off.

Seat heating is thermostatically controlled and switches off automatically when seat temperature is sufficient.

Prolonged use for people with sensitive skin is not recommended.

## Rear seats

Depending on vehicle, 2nd row and 3rd row rear seats may be fitted.

### Rear seat access



To facilitate access to the 3rd row seats (where fitted), open sliding side door and push down release lever on folding access seat in the 2nd row and fold the seat backrest forwards. If necessary, unfasten seat belts from their buckles.

### Warning

Ensure that the backrest returns to its correct position and the seat belt buckles are fastened securely.

Fastening and unfastening seat belt  
⇨ 54.

Sliding door ⇨ 31.

### Seat cushion

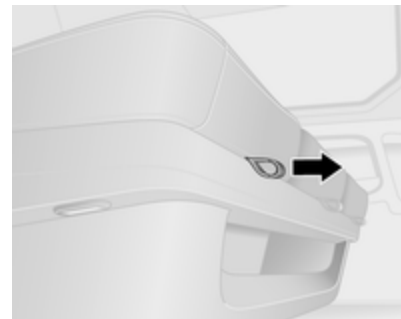

Depending on version, the seat cushion can be adjusted to one of five positions by pulling the strap

located at the front of the seat and sliding seat cushion gently forwards or backwards.

Underseat storage ⇨ 74.

## Folding and removing rear seats

### ⚠ Warning

When rear seats are being folded or removed, keep hands and feet away from the moving area.

Never adjust seats while driving as they could move uncontrollably.

Ensure that the rear seats and backrests are fully engaged before occupying the rear seats.



Before folding or removing the rear seats, ensure that the armrests are folded away in their most upright position.

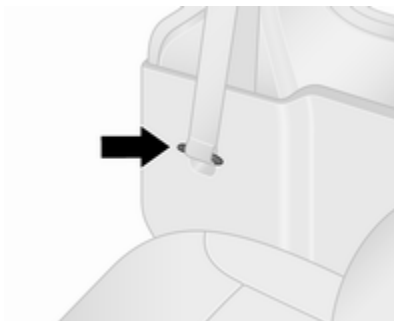

Before folding or removing the rear seats, first release outboard seat belts from their buckles and store the latch plates in their housing.

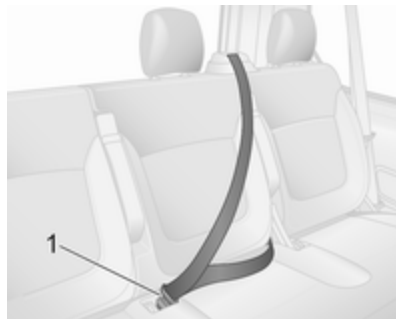

For the rear centre seat, insert the latch plate into the buckle 1.

### Folding rear seats

On some variants, the load compartment area can be increased by folding the 3rd row rear seats (where fitted).

**⚠ Warning**

When folding the seat use caution – beware of moving parts. Ensure the seat is secure when completely folded.

If necessary, remove the head restraints ⇨ 44.

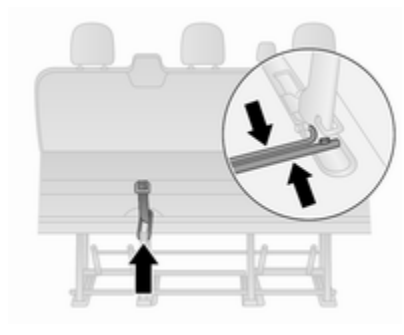

Pull the release strap and fold the backrest onto the seat.  
Hold the locking bars and bring them together simultaneously.

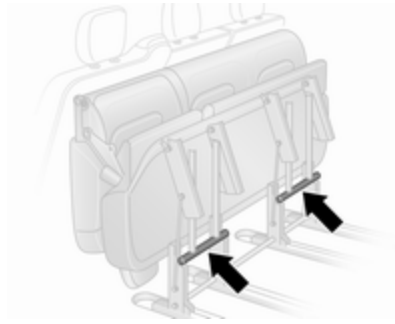

Lift and fold the seat assembly forwards until it engages in the folded forward position.

Press on the top of the seat and lock it into position by pushing the locking levers (arrowed). Ensure that the seat is engaged securely.

**Caution**

For safety reasons, do not place loads on the folded rear seats.

When returning the seat assembly to its original position, pull locking bars, carefully lower seat assembly and ensure the locking levers are correctly located and latched.

**Notice**

Make sure that the anchor points are clean before installing the seat. They should be free from grit or any other item which may prevent the seat from locking securely.

Raise the backrest, and if necessary, replace the head restraints.

**Removing rear seats**

On some variants, the load compartment area can be increased by removing the 2nd row and 3rd row rear seats (where fitted).

**⚠ Warning**

Never remove the rear seats while driving as they could move uncontrollably.

**⚠ Warning**

Removable seats are heavy! Do not attempt to remove without assistance.

If necessary, remove the head restraints ⇨ 44.

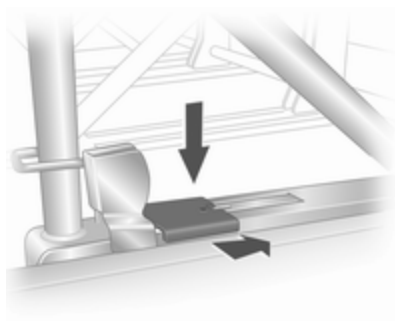

Release the seats by pressing down and sliding forward the locking catches located on the left and right-hand seat mountings.

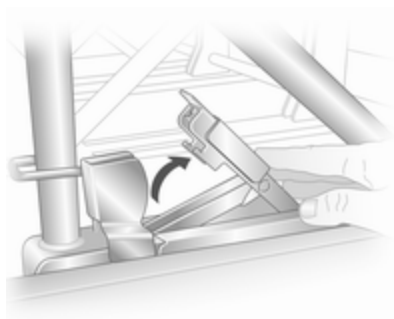

Raise the locking catches, then move the seat unit towards the rear to release from the rear floor anchor points.

Raise the seat unit, then move it towards the rear again to release from the front floor anchor points. The seat unit can then be lifted out.

The seats must be removed through the sliding side door only (not through the rear doors / tailgate). The 2nd row seats must be removed from the vehicle before the 3rd row seats.

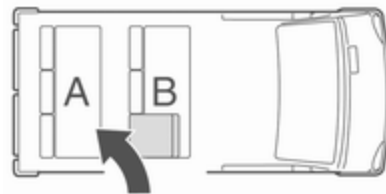
**Installing rear seats**

When re-installing seats, always ensure that the row with the folding access seat **B** is positioned correctly in front of the fixed seat row **A**.

The seats must be introduced through the sliding side door only (not through the rear doors / tailgate). The 3rd row seats must be introduced into the vehicle before the 2nd row seats.

**Caution**

The 2nd and 3rd row seats are not interchangeable and must be fitted back into their original position.

**Notice**

Make sure that the anchor points are clean before installing the seat. They should be free from grit or any other item which may prevent the seat from locking securely.

Position the seat unit over the front anchor points, then push the seat unit until it sits over the rear anchor points.

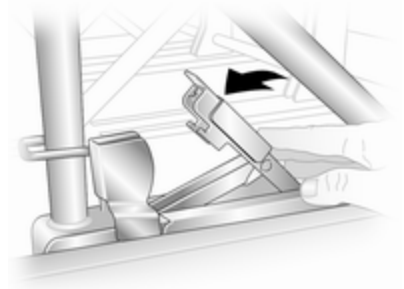

Lower the locking catches and push them until they are locked securely in place. Ensure that the visual markers on the locking catches are correctly aligned.

**⚠ Warning**

When installing the seats, ensure that the seats are properly located on the anchor points and that the locking catches are fully engaged.

Consult a workshop if the seats cannot be locked securely in position.

**Seat belts**

The seat belts are locked during heavy acceleration or deceleration of the vehicle holding the occupants in the sitting position. Therefore, the risk of injury is considerably reduced.

**⚠ Warning**

Fasten seat belt before each trip.

In the event of an accident, people not wearing seat belts endanger their fellow occupants and themselves.

Seat belts are only designed for use by one person at a time.

Child restraint system ⇨ 64.

Periodically check all parts of the belt system for damage and proper functionality.

Have damaged components replaced. After an accident, have the belts and triggered belt tensioners replaced by a workshop.

#### Notice

Make sure that the belts are not damaged by shoes or sharp-edged objects or are trapped. Prevent dirt from getting into the belt retractors.

#### Seat belt reminder

Depending on version, both front seats may be equipped with a seat belt reminder, indicated by control indicator  in the roof console ⇨ 96.

#### Belt force limiters

On the front seats, stress on the body is reduced by the gradual release of the belt during a collision.

#### Belt tensioners

In the event of a head-on or rear-end collision of a certain severity, the front seat belts are tightened.

#### Warning

Incorrect handling (e.g. removal or fitting of belts) can trigger the belt tensioners with risk of injury.

Deployment of the belt tensioners is indicated by continuous illumination of control indicator  ⇨ 96.

Triggered belt tensioners must be replaced by a workshop. Belt tensioners can only be triggered once.

#### Notice

Do not affix or install accessories or other objects that may interfere with the operation of the belt pretensioners. Do not make any modifications to belt pretensioner components as this will invalidate the vehicle operating permit.

#### Three-point seat belt

##### Seat belts on the front seats

##### Fasten



Withdraw the belt from the retractor, guide it untwisted across the body and insert the latch plate into the buckle.

Tighten the lap belt regularly whilst driving by pulling the shoulder belt.



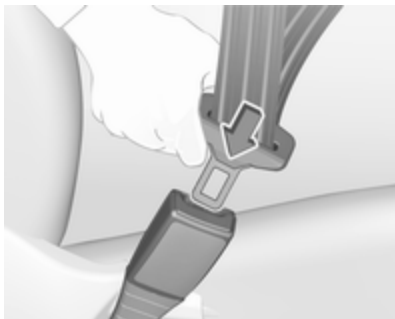

Loose or bulky clothing prevents the belt from fitting snugly. Do not place objects such as handbags or mobile phones between the belt and your body.

### **⚠ Warning**

The belt must not rest against hard or fragile objects in the pockets of your clothing.

Seat belt reminder   96.

### Height adjustment

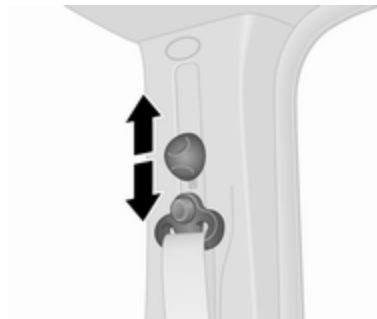

Slide adjuster up or down to desired position:

- Pull belt out slightly.
- Tilt adjuster downwards to disengage then slide height adjustment downwards or push the height adjustment up without tilting adjuster.



Adjust the height so that the belt lies across the shoulder. It must not lie across the throat or upper arm.

### **⚠ Warning**

Do not adjust while driving.

## Unfasten



To unfasten belt, press red button on belt buckle. The seat belt retracts automatically.

## Seat belts on the rear seats

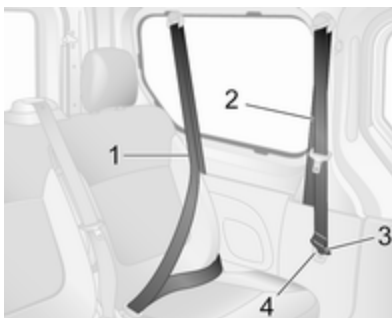

For the 2nd row seats, always use frontmost seat belts **2** (located behind the 2nd row seats). When the 2nd row seat belts **2** are not in use, place latch plate **3** in its housing **4** to avoid damage to the vehicle.

For the 3rd row seats (see illustration), always use rearmost seat belts **1** (located behind the 3rd row seats).

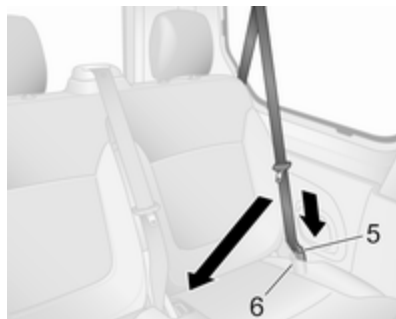

Before fastening the rear outer seat belt, first ensure that the lower latch plate **5** is fully engaged in its buckle **6**.

Then guide the belt over the lap area and the shoulder (do not twist) and insert the upper latch plate into the appropriate buckle.

Refer to "Seat belts on the front seats" above for fastening and unfastening.

**⚠ Warning**

The seat belt will not be effective in the event of an accident unless both the lower and upper latch plates are correctly fitted.

When unfastening the seat belt, always release the upper latch plate from its buckle before the lower latch plate.

Remove latch plates from their buckles before removing seats from the vehicle or to facilitate access to the rear seats.

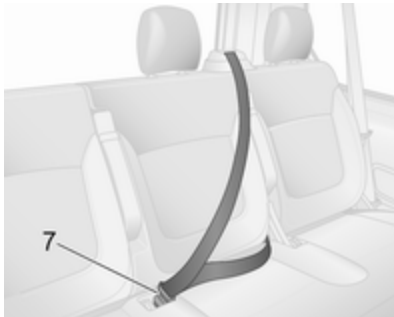

For the rear centre seat, withdraw belt from the retractor, guide it untwisted across the body and insert latch plate into the buckle 7.

**⚠ Warning**

Ensure that the rear seats and backrests are fully engaged before occupying the rear seats.

Rear seats ⇨ 49.

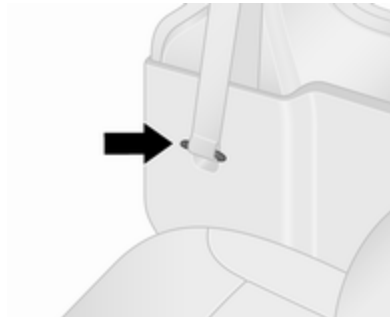

To avoid damage to the vehicle, always store outboard rear seat belt latch plates in their housing, if available.

For the rear centre seat, insert the latch plate into the appropriate buckle when the seat is not occupied.

**Using the seat belt while pregnant****⚠ Warning**

The lap belt must be positioned as low as possible across the pelvis to prevent pressure on the abdomen.

## Airbag system

The airbag system consists of a number of individual systems depending on the scope of equipment.

When triggered, the airbags inflate within milliseconds. They also deflate so quickly that it is often unnoticeable during the collision.

### ⚠ Warning

As the airbag system deploys in an explosive manner, repairs must be performed by skilled personnel only.

### ⚠ Warning

Adding accessories that change the vehicle's frame, bumper system, height, front end or side sheet metal, may keep the airbag system from working properly. The operation of the airbag system can also be affected by changing any parts of the front seats, seat belts,

airbag sensing and diagnostic module, steering wheel, instrument panel, inner door seals including the speakers, any of the airbag modules, ceiling or pillar trim, front sensors, side impact sensors or airbag wiring.

### Notice

The airbag systems and belt pretensioner control electronics are located in the centre console area. Do not put any magnetic objects in this area.

Do not affix any objects onto the airbag covers and do not cover them with other materials. Have damaged covers replaced by a workshop.

Each airbag is triggered only once. Have deployed airbags replaced by a workshop. Furthermore, it may be necessary to have the steering wheel, the instrument panel, parts of the panelling, the door seals, handles and the seats replaced.

Do not make any modifications to the airbag system as this will invalidate the vehicle operating permit.

Control indicator  for airbag systems  
 ⇨ 96.

## Child restraint systems on front passenger seat with airbag systems

Warning according to ECE R94.02:



**EN:** NEVER use a rear-facing child restraint system on a seat protected by an ACTIVE AIRBAG in front of it, DEATH or SERIOUS INJURY to the CHILD can occur.

**DE:** Nach hinten gerichtete Kindersitze NIEMALS auf einem Sitz verwenden, der durch einen davor befindlichen AKTIVEN AIRBAG

geschützt ist, da dies den TOD oder SCHWERE VERLETZUNGEN DES KINDES zur Folge haben kann.

**FR:** NE JAMAIS utiliser un siège d'enfant orienté vers l'arrière sur un siège protégé par un COUSSIN GONFLABLE ACTIF placé devant lui, sous peine d'infliger des BLESSURES GRAVES, voire MORTELLES à l'ENFANT.

**ES:** NUNCA utilice un sistema de retención infantil orientado hacia atrás en un asiento protegido por un AIRBAG FRONTAL ACTIVO. Peligro de MUERTE o LESIONES GRAVES para el NIÑO.

**RU:** ЗАПРЕЩАЕТСЯ устанавливать детское удерживающее устройство лицом назад на сиденье автомобиля, оборудованном фронтальной подушкой безопасности, если ПОДУШКА НЕ ОТКЛЮЧЕНА! Это может привести к СМЕРТИ или СЕРЬЕЗНЫМ ТРАВМАМ РЕБЕНКА.

**NL:** Gebruik NOOIT een achterwaarts gericht kinderzitje op een stoel met een ACTIEVE AIRBAG ervoor, om DODELIJK of ERNSTIG LETSEL van het KIND te voorkomen.

**DA:** Brug ALDRIG en bagudvendt autostol på et forsæde med AKTIV AIRBAG, BARNET kan komme i LIVSFARE eller komme ALVORLIGT TIL SKADE.

**SV:** Använd ALDRIG en bakåtvänd barnstol på ett säte som skyddas med en framförvarande AKTIV AIRBAG. DÖDSFALL eller ALLVARLIGA SKADOR kan drabba BARNET.

**FI:** ÄLÄ KOSKAAN sijoita taaksepäin suunnattua lasten turvaistuinta istuimelle, jonka edessä on AKTIIVINEN TURVATYYNY, LAPSI VOI KUOLLA tai VAMMAUTUA VAKAVASTI.

**NO:** Bakovervendt barnesikringsutstyr må ALDRI brukes på et sete med AKTIV KOLLISJONSPUTE foran, da det kan føre til at BARNET utsettes for LIVSFARE og fare for ALVORLIGE SKADER.

**PT:** NUNCA use um sistema de retenção para crianças voltado para trás num banco protegido com um AIRBAG ACTIVO na frente do mesmo, poderá ocorrer a PERDA DE VIDA ou FERIMENTOS GRAVES na CRIANÇA.

**IT:** Non usare mai un sistema di sicurezza per bambini rivolto all'indietro su un sedile protetto da AIRBAG ATTIVO di fronte ad esso: pericolo di MORTE o LESIONI GRAVI per il BAMBINO!

**EL:** ΠΟΤΕ μη χρησιμοποιείτε παιδικό κάθισμα ασφαλείας με φορά προς τα πίσω σε κάθισμα που προστατεύεται από μετωπικό ΕΝΕΡΓΟ ΑΕΡΟΣΑΚΟ, διότι το παιδί μπορεί να υποστεί ΘΑΝΑΣΙΜΟ ή ΣΟΒΑΡΟ ΤΡΑΥΜΑΤΙΣΜΟ.

**PL:** NIE WOLNO montować fotelika dziecięcego zwróconego tyłem do kierunku jazdy na fotelu, przed którym znajduje się WŁĄCZONA PODUSZKA POWIETRZNA. Niezastosowanie się do tego zalecenia może być przyczyną ŚMIERCI lub POWAŻNYCH OBRAŻEŃ u DZIECKA.

**TR:** Arkaya bakan bir çocuk emniyet sistemini KESİNLİKLE önünde bir AKTİF HAVA YASTIĞI ile korunmakta olan bir koltukta kullanmayınız. ÇOCUK ÖLEBİLİR veya AĞIR ŞEKİLDE YARALANABİLİR.

**UK:** НИКОЛИ не використовуйте систему безпеки для дітей, що встановлюється обличчям назад, на сидінні з УВІМКНЕНОЮ ПОДУШКОЮ БЕЗПЕКИ, інакше це може призвести до СМЕРТІ чи СЕРІОЗНОГО ТРАВМУВАННЯ ДИТИНИ.

**HU:** SOHA ne használjon hátrafelé néző biztonsági gyerekülést előlről AKTÍV LÉGZSÁKKAL védett ülésen, mert a GYERMEK HALÁLÁT vagy KOMOLY SÉRÜLÉSÉT okozhatja.

**HR:** NIKADA nemojte koristiti sustav zadržavanja za djecu okrenut prema natrag na sjedalu s AKTIVNIM ZRAČNIM JASTUKOM ispred njega, to bi moglo dovesti do SMRTI ili OZBILJNIH OZLJEDA za DIJETE.

**SL:** NIKOLI ne nameščajte otroškega varnostnega sedeža, obrnjenega v nasprotni smeri vožnje, na sedež z

AKTIVNO ČELNO ZRAČNO BLAZINO, saj pri tem obstaja nevarnost RESNIH ali SMRTNIH POŠKODB za OTROKA.

**SR:** NIKADA ne koristiti bezbednosni sistem za decu u kome su deca okrenuta unazad na sedištu sa AKTIVNIM VAZDUŠNIM JASTUKOM ispred sedišta zato što DETE može da NASTRADA ili da se TEŠKO POVREDI.

**MK:** НИКОГАШ не користете детско седиште свртено наназад на седиште заштитено со АКТИВНО ВОЗДУШНО ПЕРНИЧЕ пред него, затоа што детето може ДА ЗАГИНЕ или да биде ТЕШКО ПОВРЕДЕНО.

**BG:** НИКОГА не използвайте детска седалка, гледаща назад, върху седалка, която е защитена чрез АКТИВНА ВЪЗДУШНА ВЪЗГЛАВНИЦА пред нея - може да се стигне до СМЪРТ или СЕРИОЗНО НАРАНЯВАНЕ на ДЕТЕТО.

**RO:** Nu utilizați NICIODATĂ un scaun pentru copil îndreptat spre partea din spate a mașinii pe un scaun protejat de un AIRBAG ACTIV în fața sa;

acest lucru poate duce la DECESUL sau VĂTĂMAREA GRAVĂ a COPILULUI.

**CS:** NIKDY nepoužívejte dětský zádržný systém instalovaný proti směru jízdy na sedadle, které je chráněno před sedadlem AKTIVNÍM AIRBAGEM. Mohlo by dojít k VÁŽNĚMU PORANĚNÍ nebo ÚMRTÍ DÍTĚTE.

**SK:** NIKDY nepoužívajte detskú sedačku otočenú vzad na sedadle chránenom AKTÍVNYM AIRBAGOM, pretože môže dôjsť k SMRTI alebo VÁŽNYM ZRANENIAM DIEŤAŤA.

**LT:** JOKIU BŪDU nemontuokite atgal atgretžtos vaiko tvirtinimo sistemas sėdynėje, prieš kurią įrengta AKTYVI ORO PAGALVĖ, nes VAIKAS GALI ŽŪTI arba RIMTAI SUSIŽALOTI.

**LV:** NEKĀDĀ GADĪJUMĀ neizmantojiet uz aizmuguri vērstu bērnu sēdekļīti sēdvietā, kas tiek aizsargāta ar tās priekšā uzstādītu AKTĪVU DROŠĪBAS SPILVENU, jo pretējā gadījumā BĒRNS var gūt SMAGAS TRAUMAS vai IET BOJĀ.

**ET:** ÄRGE kasutage tahapoolle suunatud lapseturvaistet istmel, mille ees on AKTIIVSE TURVAPADJAGA kaitstud iste, sest see võib põhjustada LAPSE SURMA või TÕSISE VIGASTUSE.

**MT:** QATT tuża trażżin għat-tfal li jħares lejn in-naħa ta' wara fuq sit protett b'AIRBAG ATTIV quddiemu; dan jista' jikkawża I-MEWT jew ĠRIEHI SERJI lit-TFAL.

**GA:** Ná húsáid srian sábháilteachta linbh cúil RIAMH ar shuíochán a bhfuil mála aeir ag feidhmiú os a chomhair. Tá baol BÁIS nó GORTÚ DONA don PHÁISTE ag baint leis.

Beyond the warning required by ECE R94.02, for safety reasons a forward-facing child restraint system must only be used subject to the instructions and restrictions in the Child restraint installation locations tables ⇨ 66.

The airbag label is located on the front passenger sun visor.

### ⚠ Danger

Do not use a child restraint system on the passenger seat with active front airbag.

Airbag deactivation ⇨ 62.

### Front airbag system

The front airbag system consists of one airbag in the steering wheel and one in the instrument panel on the front passenger side. These can be identified by the word **AIRBAG**.

The front airbag system is triggered in the event of an accident of a certain severity. The ignition must be switched on.

The inflated airbags cushion the impact, thereby reducing the risk of injury to the upper body and head of the front seat occupants considerably.

### ⚠ Warning

Optimum protection is only provided when the seat is in the proper position.

Seat position ⇨ 45.

Keep the area in which the airbag inflates clear of obstructions.

Fasten the seat belt correctly and engage securely. Only then is the airbag able to protect.

### Side airbag system



The side airbag system consists of an airbag in each front seat backrest. This may be identified by the word **AIRBAG**.

The side airbag system is triggered in the event of an accident of a certain severity. The ignition must be switched on.

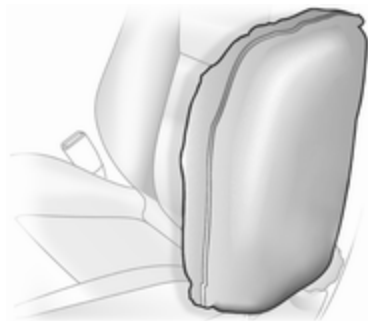

The inflated airbags cushion the impact, thereby reducing the risk of injury to the upper body and pelvis in the event of a side-on collision considerably.

**⚠ Warning**

Keep the area in which the airbag inflates clear of obstructions.

**Notice**

Only use protective seat covers that have been approved for the vehicle. Be careful not to cover the airbags.

**Curtain airbag system**



The curtain airbag system consists of an airbag in the roof frame on each side. This may be identified by the word **AIRBAG** on the headlining trim.

The curtain airbag system is triggered in the event of a side-on impact of a certain severity. The ignition must be switched on.

The inflated airbags cushion the impact, thereby reducing the risk of injury to the head in the event of a side-on impact considerably.

**⚠ Warning**

Keep the area in which the airbag inflates clear of obstructions.

The hooks on the handles in the roof frame are only suitable for hanging up light articles of clothing, without coat hangers. Do not keep any items in these clothes.

**Airbag deactivation**

The front passenger airbag system must be deactivated if a child restraint is to be fitted on the front passenger seat in accordance with the instructions in the Child restraint installation locations tables ↗ 66.





The belt tensioners and all other airbag systems will remain active.

Depending on vehicle, there is a warning on the airbag label located on the front passenger sun visor. Refer to "Airbag system" for further information ⇨ 58.



Front passenger airbag system can be deactivated via a switch located on the side of the instrument panel. Do not open the front passenger door to access the switch unless the vehicle is stationary and the ignition has been switched off.

Press the switch in and rotate to choose the position:



 OFF : front passenger seat airbag system is deactivated and will not inflate in the event of a collision. With ignition on, control indicator  OFF illuminates continuously in the roof console ⇨ 92, ⇨ 96 and a corresponding message appears in the Driver Information Centre ⇨ 101.



 ON : front passenger airbag system is active.





### Danger

Deactivate passenger airbag only in combination with the use of a child restraint system, subject to the instructions and restrictions in the table ⇨ 66.

Otherwise, there is a risk of fatal injury for a person occupying a seat with a deactivated front passenger airbag.

If control indicator  ON illuminates after the ignition is switched on and control indicator  OFF is not illuminated, the front passenger airbag system will inflate in the event of a collision.

If both control indicators  ON and  OFF are illuminated simultaneously, there is a system failure. The status of the system is not discernible, therefore no person is permitted to occupy the front passenger seat. Contact a workshop immediately.

If control indicator  ⇨ 97 illuminates together with  ⇨ 96, this indicates a fault within the system. The switch position may have been changed inadvertently with the ignition on. Turn ignition off and on again and reset the switch position. If  and  still remain illuminated, seek the assistance of a workshop.

Change status only when the vehicle is stopped with the ignition off. Status remains until the next change.

Control indicator for airbag deactivation ⇨ 96.

## Child restraints

### Child restraint systems

#### ⚠ Danger

If using a rear-facing child restraint system on the front passenger seat, the airbag system for the front passenger seat must be deactivated. This also applies to certain forward-facing child restraint systems as indicated in the table ⇨ 66.

Airbag deactivation ⇨ 62.

Airbag label ⇨ 58.

We recommend a child restraint system which is tailored specifically to the vehicle. For further information, contact your workshop.

When a child restraint system is being used, pay attention to the following usage and installation instructions and also those supplied with the child restraint system.

Always comply with local or national regulations. In some countries, the use of child restraint systems is forbidden on certain seats.

Child restraint systems can be fastened with:

- Three-point seat belt
- ISOFIX brackets
- Top-Tether

#### Three-point seat belt

Child restraint systems can be fastened by using a three-point seat belt ⇨ 54.

Depending on the size of the used child restraint systems and the model variant, child restraint systems can be attached to certain 2nd row and 3rd row rear seats. After fastening the child restraint system the seat belt has to be tightened ⇨ 66.

#### ISOFIX brackets

ISOFIX mounting brackets are indicated by the ISOFIX logo or symbol on the seat cushion.

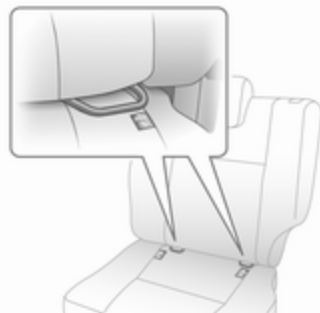

Fasten vehicle-approved ISOFIX child restraint systems to the ISOFIX mounting brackets.

When using ISOFIX mounting brackets for seat mounting, universally approved child restraint systems for ISOFIX may be used.

A Top-Tether strap must be used in addition to the ISOFIX mounting brackets.

Permissible mounting location positions for ISOFIX child restraint systems are marked in the tables by +, IL and IUF.

## Top-Tether anchors

Top-Tether anchors are located on the back of the seat.

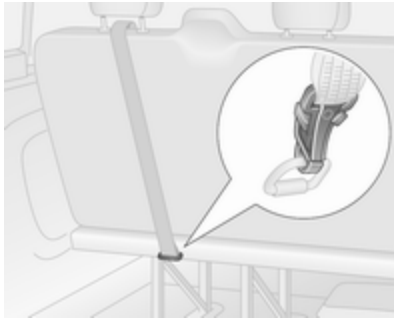

In addition to the ISOFIX mounting brackets, fasten the Top-Tether strap to the Top-Tether anchors. The strap must run between the two guide rods of the head restraint.

ISOFIX child restraint systems of universal category positions are marked in the table by IUF ⇨ 66.

## Selecting the right system

The rear seats are the most convenient location to fasten a child restraint system.

Children should travel facing rearwards in the vehicle as long as possible. This makes sure that the child's backbone, which is still very weak, is under less strain in the event of an accident.

Suitable are restraint systems that comply with valid UN ECE regulations. Check local laws and regulations for mandatory use of child restraint systems.

Ensure that the child restraint system to be installed is compatible with the vehicle type.

Ensure that the mounting location of the child restraint system within the vehicle is correct, see following tables.

Allow children to enter and exit the vehicle only on the side facing away from the traffic.

When the child restraint system is not in use, secure the seat with a seat belt or remove it from the vehicle.

### Notice

Do not affix anything on the child restraint systems and do not cover them with any other materials.

A child restraint system which has been subjected to stress in an accident must be replaced.

Child locks ⇨ 30.

Central locking system ⇨ 24.

## Child restraint installation locations

### Permissible options for fitting a child restraint system

#### Front seats - Van

Weight and age class	Single front passenger seat <sup>1</sup>		Double front passenger seat		
	activated airbag	deactivated or without airbag	activated airbag	deactivated or without airbag centre	outer
Group 0: up to 10 kg					
Group 0+: up to 13 kg	X	U	X	X	U
Group I: 9 to 18 kg	X	U	X	X	U
Group II: 15 to 25 kg	X	U	X	X	U
Group III: 22 to 36 kg	X	U	X	X	U

<sup>1</sup> : Forward-facing child restraints: Remove head restraint ⇨ 44. Slide seat as far back as possible. Set seat height to highest position. Maximum backrest rake is 25°. Seat adjustment ⇨ 46.

## Front seats - Combi, Double cab

Weight and age class	Single front passenger seat <sup>1</sup>		Double front passenger seat		
	activated airbag	deactivated or without airbag	activated airbag	deactivated or without airbag centre	outer
Group 0: up to 10 kg Group 0+: up to 13 kg	X	U	X	X	U
Group I: 9 to 18 kg	X	U <sup>2</sup>	X	X	U <sup>2</sup>
Group II: 15 to 25 kg Group III: 22 to 36 kg	X	X	X	X	X

<sup>1</sup> : If adjustable, slide seat as far back as possible and set seat height to highest position. Maximum backrest rake is 25°. Seat adjustment ⇨ 46.

<sup>2</sup> : Rear-facing child restraints only for this weight and age class.

## 68 Seats, restraints

---

### Rear seats - Combi, Double cab

Weight and age class	2nd row seats <sup>1</sup>	3rd row seats
Group 0: up to 10 kg	U	U
Group 0+: up to 13 kg		
Group I: 9 to 18 kg	U <sup>2</sup>	U <sup>2</sup>
Group II: 15 to 25 kg		
Group III: 22 to 36 kg	U <sup>2</sup>	U <sup>2</sup>

---

<sup>1</sup> : If necessary, slide adjustable front seat forwards to install a child restraint system on these seats. There may not be enough clearance to install particular child restraint systems on vehicles fitted with fixed front seats.

<sup>2</sup> : Forward-facing child restraints: Remove head restraint ⇨ 44 before installing child restraint. The seat in front of this installation position must not be more than halfway back on its runners. Maximum backrest rake is 25°. Seat adjustment ⇨ 46.

U : Suitable for universal category restraint systems for use in this weight and age class, in conjunction with three-point seat belt.

X : Seat position not suitable for children in this weight and age class.

## Permissible options for fitting an ISOFIX child restraint system

Weight class	Size class	Fixture	Front seats	2nd row seats <sup>1</sup>		3rd row seats
				Centre	Outer	
				vehicles with single passenger seat	vehicles with double passenger seat	
Group 0: up to 10 kg	E	ISO/R1	X	X	IL	IL X
Group 0+: up to 13 kg	E	ISO/R1	X	X	IL	IL X
	D	ISO/R2	X	X	IL	X X
	C	ISO/R3	X	X	IL	X X
Group I: 9 to 18 kg	D	ISO/R2	X	X	IL	X X
	C	ISO/R3	X	X	IL	X X
	B	ISO/F2	X	X	IL, IU <sup>F2</sup>	IL, IU <sup>F2</sup> X
	B1	ISO/F2X	X	X	IL, IU <sup>F2</sup>	IL, IU <sup>F2</sup> X
	A	ISO/F3	X	X	IL, IU <sup>F2</sup>	IL, IU <sup>F2</sup> X
Group II: 15 to 25 kg			X	X	IL, IU <sup>F2</sup>	IL, IU <sup>F2</sup> X
Group III: 22 to 36 kg			X	X	IL, IU <sup>F2</sup>	IL, IU <sup>F2</sup> X

- <sup>1</sup> : If necessary, slide adjustable front seat forwards to install a child restraint system on these seats. There may not be enough clearance to install a child restraint system on vehicles fitted with fixed front seats.
- <sup>2</sup> : Forward-facing child restraints: Remove head restraint ⇨ 44 before installing child restraint. The seat in front of this installation position must not be more than halfway back on its runners. Maximum backrest rake is 25°. Seat adjustment ⇨ 46.

IUF : Suitable for ISOFIX forward-facing child restraint systems of universal category approved for use in this weight class.

X : No ISOFIX child restraint system approved in this weight class.

IL : Suitable for particular ISOFIX restraint systems of the 'specific-vehicle', 'restricted' or 'semi-universal' categories.  
The ISOFIX restraint system must be approved for the specific vehicle type.

#### **ISOFIX size class and seat device**

- A - ISO/F3 : Forward-facing child restraint system for children of maximum size in the weight class 9 to 18 kg.
- B - ISO/F2 : Forward-facing child restraint system for smaller children in the weight class 9 to 18 kg.
- B1 - ISO/F2X : Forward-facing child restraint system for smaller children in the weight class 9 to 18 kg.
- C - ISO/R3 : Rear-facing child restraint system for children of maximum size in the weight class up to 18 kg.
- D - ISO/R2 : Rear-facing child restraint system for smaller children in the weight class up to 18 kg.
- E - ISO/R1 : Rear-facing child restraint system for young children in the weight class up to 13 kg.



## Storage

<b>Storage compartments</b> .....	<b>71</b>
Instrument panel storage .....	71
Glovebox .....	72
Cupholders .....	73
Front storage .....	73
Door panel storage .....	74
Underseat storage .....	74
Overcab storage .....	76
<b>Load compartment</b> .....	<b>76</b>
Load compartment cover .....	77
Lashing eyes .....	77
Safety net .....	78
Load compartment grille .....	79
Warning triangle .....	80
First aid kit .....	80
<b>Roof rack system</b> .....	<b>80</b>
Roof rack .....	80
<b>Loading information</b> .....	<b>80</b>

## Storage compartments

### ⚠ Warning

Do not store heavy or sharp objects in the storage compartments. Otherwise, the storage compartment lid could open and vehicle occupants could be injured by objects being thrown around in the event of hard braking, a sudden change in direction or an accident.

## Instrument panel storage

Storage compartments, pockets and trays are located in the instrument panel.



A coin holder may be located on the instrument panel.

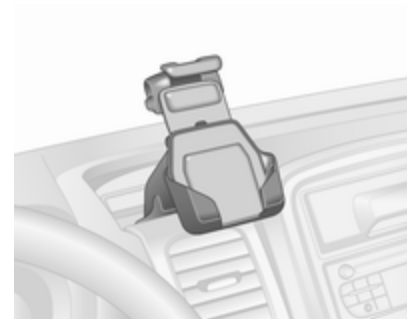

A phone holder may be located on the instrument panel.

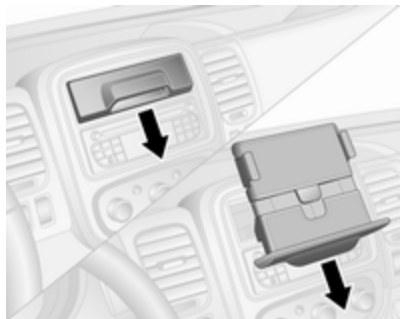

A tablet holder may be located on the instrument panel.

To use the tablet holder, pull the handle towards you fully. Swivel holder and push it in fully. If required, lower the base of the holder to extend it.

To refit, pull tablet holder fully towards you, lift it up until it is horizontal and push it in fully.

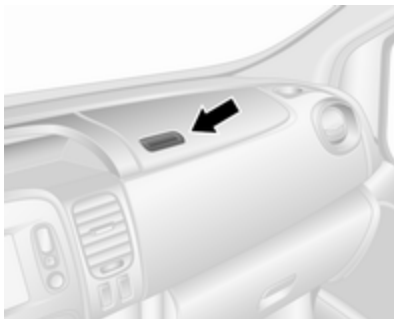

Depending on version, the tray located on top of the instrument panel may have a lid.

## Glovebox

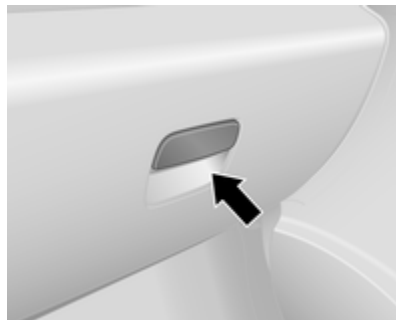

To open, pull the handle.

Depending on version, the glovebox may feature a light that comes on when the glovebox is opened, and may also be lockable.

The glovebox should be closed while driving.

## Cupholders



Cupholders are located at both ends of the instrument panel, centrally in the lower instrument panel, and depending on version, also in the door pockets and in the rear seat area.

Additional cupholders are located on the back of the folded down centre rear seat ↗ 73, ↗ 49.

The cupholders can also be used to hold the portable ashtray unit. Remove the portable ashtray unit to use the cupholders.

Ashtrays ↗ 88.

## Front storage

Coat hooks are located on the cabin bulkhead and on the grab handles in the roof lining.

## Folding centre seatback

The front centre passenger seat backrest, when folded fully forwards, features a storage compartment, cupholder and a document tray.

Seat folding ↗ 48.

### **⚠ Warning**

When the front centre passenger seat is in the folded position, the front passenger airbag system must be deactivated.

Airbag deactivation ↗ 62.

Close the instrument panel cupholder before folding down the backrest.



Press button (arrowed) on rear side of backrest to unlock the document tray and access the storage compartments.

To install the document tray, insert the end piece(s) into any of the slots by the cupholder.

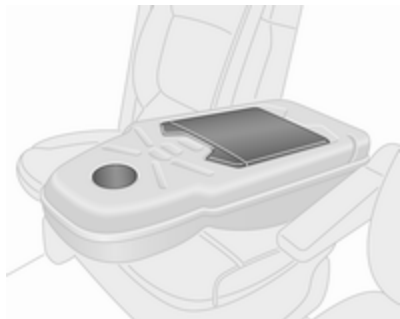

The document tray must always be returned to its original position before raising the seat backrest.



If necessary, secure objects with the strap.

When the storage compartment is closed, it is possible to run a charging cord from an item in the storage compartment through the notch, e.g. to connect devices to a power outlet.

Power outlets ⇨ 87.

### Door panel storage

The front and rear door pockets contain bottle holders and depending on version, a holder for cups or ashtrays.

### Underseat storage

On some variants, a storage box is located under the front seat. Pull storage box to remove.

Bench seats may also contain a storage compartment at the lower front part of the seat.



Using the straps on the passenger seat cushion, pull the cushion forwards to gain access to the storage under the seat cushion.

### Double cab – Underseat storage

Depending on version, bench seats contain removable storage boxes beneath some of the seat cushions.

### Opening

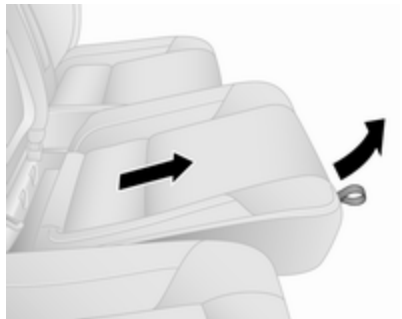

To access each storage box, first release the seat cushion by grasping the strap located at the front edge of the cushion and pulling the cushion up, then slide the seat cushion gently forwards.

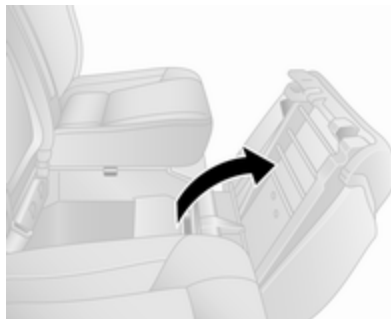

Then pull up the rear of the seat cushion to flip open.

### Removing

The storage box can also be removed when the seat cushion is flipped open. Pull up to remove the retaining ring from inside the box, then slide the box out from beneath the seat.

Replace the storage box when not in use.

### Closing

To close; fold down seat cushion, push it slightly rearwards then press front part of cushion downwards to engage.

When folded down, pulling the strap also allows you to adjust the position of the seat cushion to suit personal requirements.

Seat adjustment ⇨ 46.

Rear seats ⇨ 49.

### Load-through feature

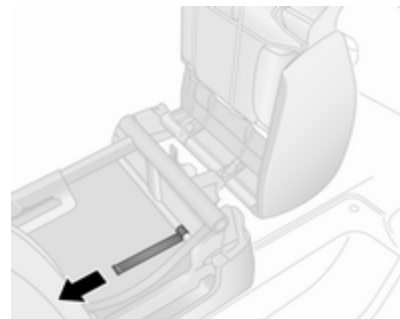

To enable long items to be stored under the rear seats (on the front passenger side of the vehicle only), the lower trim flaps can be released.

First pull the strap on the passenger seat cushion to raise the seat, then tilt front flap inwards by pulling the tab behind the seat (see illustration).

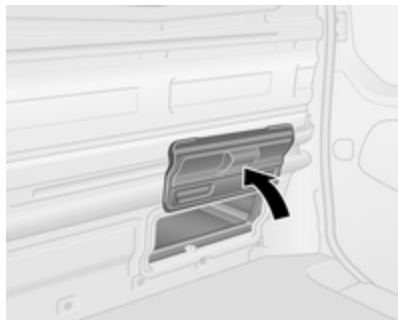

Fold up the rear flap by hand. It is retained in the open position by magnets.

### ⚠ Warning

Passengers must not use the seat when transporting objects beneath it with the lower trim flaps opened.

### Overcab storage



The total weight in this compartment must not exceed 35 kg.

### Load compartment

Do not attach items to or hang items on the upper or lower struts on either side of the load compartment.

### ⚠ Warning

Always make sure that the load in the vehicle is securely stowed. Otherwise objects can be thrown around inside the vehicle and cause personal injury or damage to the load or car.

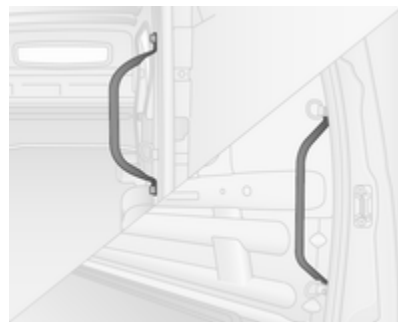

Use the grab handles, located beside the rear and sliding side door(s), to assist during entry and exit of the load compartment.

## Load compartment cover

### Rear parcel shelf

Do not place any excessively heavy or sharp-edged objects on the rear parcel shelf.

The maximum load permissible is 50 kg.

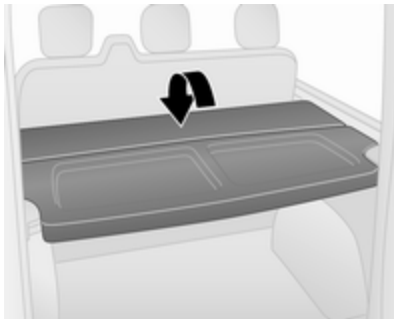

The rear parcel shelf can be installed in two positions, i.e. the upper position or the lower position.

The rear parcel shelf may also be folded up, allowing for greater flexibility in the load compartment.

### Removing

To remove, release parcel shelf from its retainers on both sides.

If the rear seats ⇨ 49 are in the folded position, remove the parcel shelf and store it horizontally in front of the folded rear seats.

### Installing

Refit the parcel shelf by engaging in the retainers on both sides.

## Lashing eyes

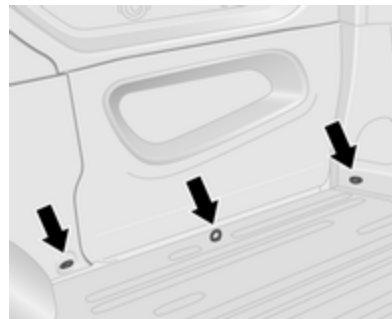

Lashing eyes are mounted in the load compartment to enable cargo to be secured against slippage using lashing straps or a luggage floor net.



Lashing eyes may be located on the vehicle floor and / or in the sidewall. The number and location of the lashing eyes may vary depending on the vehicle.

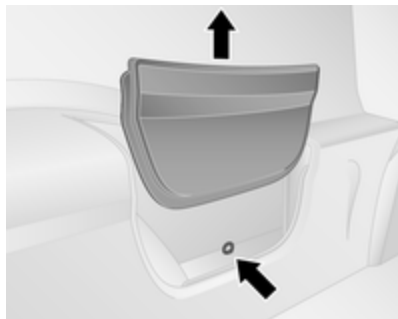

Depending on vehicle, lashing eyes may be located behind a trim panel in the sidewall. To access lashing eye, remove the trim panel by pulling it upwards and place it in one of the rear storage pockets.

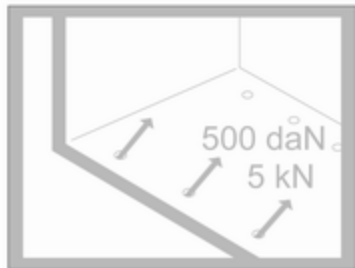

The maximum force applied to the lashing eyes should not exceed 500 daN / 5 kN / 5000 N.

Depending on country, the maximum force may be shown on a label.

#### Notice

Specifications on the label always have priority over those given in this manual.

Loading information ⇨ 80.

### Safety net

The safety net can be installed behind the front seats or the rear seats.

Passengers must not be transported behind the safety net.

### Installing



Release the covers in the roof lining (using a flat blade screwdriver) to access the mountings, then insert the load compartment net rods into the left and right mounting locations and secure.



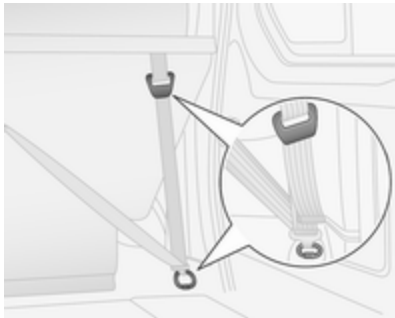

Attach the straps to the lashing eyes or rings behind the seats, then tension the straps.

### Removal

Release tension from straps and unhook straps from lashing eyes or rings. Remove net rods from their mounting locations and close the covers.

### Load compartment grille

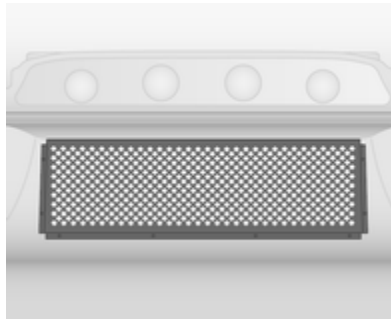

Vehicles with a window in the cabin bulkhead may include a metal grille on the load compartment side.

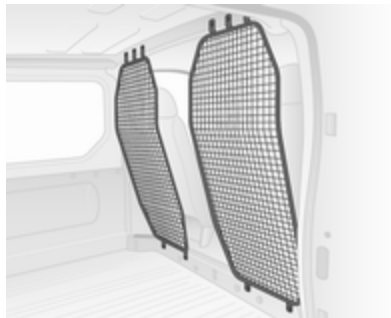

Depending on vehicle, vehicles without a cabin bulkhead may include restraining lattices behind the front seats.



Combi vehicles may include a restraining lattice behind the 2nd row seats.

### Notice

The grille or lattice provides protection from load compartment objects being thrown around in the event of hard braking, a sudden change in direction or an accident.

Loading information ⇨ 80.

## Warning triangle

The warning triangle can be accommodated in the space under the seats.

Underseat storage ⇨ 74.

## First aid kit

The first aid kit can be accommodated in the space under the seats.

Underseat storage ⇨ 74.

## Roof rack system

### Roof rack

For safety reasons and to avoid damage to the roof, the vehicle approved roof rack system is recommended. For further information, contact your workshop.

Follow the installation instructions and remove the roof rack when not in use.

#### Notice

If tyres of size 215/60 R17 C are fitted, consult a workshop before installing a roof rack.

Refer to "Loading information" below for further information.

## Loading information

- Heavy objects in the load compartment should be evenly distributed and placed as far forward as possible. If objects can be stacked, the heavier objects should be placed at the bottom.
- Prevent sliding of loose objects by securing them with straps attached to the lashing eyes ⇨ 77.
- When transporting objects in the load compartment, the backrests of the rear seats must not be angled forward.
- Do not allow the load to protrude above the upper edge of the backrests.
- Do not place any objects on the instrument panel.
- The load must not obstruct the operation of the pedals, parking brake and gear selector, or hinder the freedom of movement of the driver. Do not place any unsecured objects in the interior.

- Do not drive with an open load compartment. In addition, the number plate is only distinguishable and illuminated correctly if the doors are closed.

### Warning

Always make sure that the load in the vehicle is securely stowed. Otherwise objects can be thrown around inside the vehicle and cause personal injury or damage to the load or car.

- The payload is the difference between the permitted gross vehicle weight (see identification plate ⇨ 207) and the EC kerb weight.  
To calculate the payload, enter the data for your vehicle in the Weights table at the front of this manual.  
The EC kerb weight includes weights for the driver (68 kg), luggage (7 kg) and all fluids (fuel tank 90% full).

Optional equipment and accessories increase the kerb weight.

- Driving with a roof load increases the sensitivity of the vehicle to cross-winds and has a detrimental effect on vehicle handling due to the vehicle's higher centre of gravity. Distribute the load evenly and secure it properly with retaining straps. Adjust the tyre pressure and vehicle speed according to the load conditions. Check and retighten the straps frequently.  
Do not drive faster than 75 mph.  
The permissible roof load is 200 kg for H1 Roof height variants and 150 kg for H2 Roof height variants (excludes Platform cab conversions). The roof load is the combined weight of the roof rack and the load.

# Instruments and controls

<b>Controls</b> .....	<b>83</b>
Steering wheel adjustment .....	83
Steering wheel controls .....	83
Horn .....	83
Steering column controls .....	83
Windscreen wiper and washer ..	84
Rear window wiper and washer .....	85
Outside temperature .....	85
Clock .....	86
Power outlets .....	87
Cigarette lighter .....	88
Ashtrays .....	88
<b>Warning lights, gauges and indicators</b> .....	<b>89</b>
Instrument cluster .....	89
Speedometer .....	89
Odometer .....	90
Trip odometer .....	90
Tachometer .....	90
Fuel gauge .....	90
Fuel economy gauge .....	91
Service display .....	92
Control indicators .....	92

Turn lights .....	95
Seat belt reminder .....	96
Airbag and belt tensioners .....	96
Airbag deactivation .....	96
Charging system .....	97
Malfunction indicator light .....	97
Service vehicle soon .....	97
Stop engine .....	97
Brake system .....	97
Antilock brake system (ABS) .....	98
Gear shifting .....	98
Electronic Stability Control .....	98
Electronic Stability Control off ..	98
Engine coolant temperature .....	98
Preheating .....	99
AdBlue .....	99
Tyre pressure monitoring system .....	99
Engine oil pressure .....	99
Fuel economy mode .....	100
Low fuel .....	100
Stop-start system .....	100
Exterior light .....	100
High beam .....	100
Front fog lights .....	101
Rear fog light .....	101
Cruise control .....	101
Speed limiter .....	101
Tachograph .....	101
Door open .....	101

<b>Displays</b> .....	<b>101</b>
Driver Information Centre .....	101
Info Display .....	102
<b>Vehicle messages</b> .....	<b>102</b>
Warning chimes .....	103
Engine oil level .....	104
<b>Trip computer</b> .....	<b>104</b>
<b>Tachograph</b> .....	<b>106</b>

## Controls

### Steering wheel adjustment

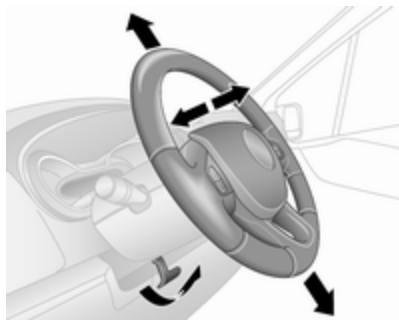

Unlock lever, adjust steering wheel, then engage lever and ensure it is fully locked.

Do not adjust steering wheel unless vehicle is stationary and steering wheel lock has been released.

### Steering wheel controls



The cruise control and speed limiter can be operated via the controls on the steering wheel.

Cruise control ⇨ 151.

### Horn



Press .

The horn will sound regardless of ignition switch position.

### Steering column controls

The Infotainment system and a connected mobile phone can be operated via the controls on the steering column.

Further information is available in the Infotainment manual.

## Windscreen wiper and washer

### Windscreen wiper

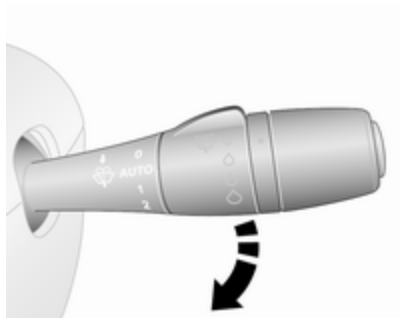

- 0** : off  
**AUTO** or  : interval wiping or automatic wiping with rain sensor  
**1** : slow  
**2** : fast

Do not use if the windscreen is frozen.  
Switch off in car washes.

### Notice

During driving, wiper speed is reduced automatically when the vehicle is at a standstill. As soon as the vehicle starts to move, wiping returns to the selected speed unless the lever has been moved.

### Adjustable wiper interval

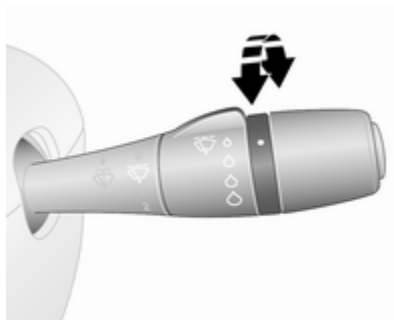

Wiper lever in position **AUTO** or .  
Turn the adjuster wheel to adjust the desired wipe interval.

### Automatic wiping with rain sensor

Wiper lever in position **AUTO** or .

The rain sensor detects the amount of water on the windscreen and automatically regulates the frequency of the windscreen wiper.

Automatic wiping will need to be reselected whenever the ignition has been switched off.

### Adjustable sensitivity of the rain sensor

Turn the adjuster wheel to adjust the sensitivity.



The rain sensor is located on the windscreen. Keep the sensor area free from dust, dirt and ice.

## Windscreen washer

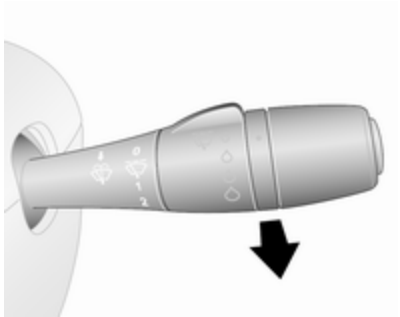

Pull lever. Washer fluid is sprayed onto the windscreen.

short pull : wiper swipes once  
long pull : wiper swipes for a few strokes

## Maintenance position

Depending on version, the windscreen wiper lever may be equipped with a maintenance position to make wiper blade replacement easier.

Before replacing the wiper blades, switch on the ignition then move the wiper lever down as far as it will go; the wiper stops in a position away from the bonnet.

Wiper blade replacement ⇨ 174.

## Rear window wiper and washer

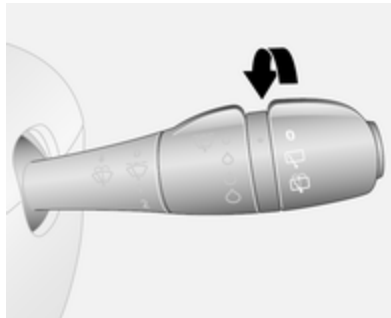

Turn lever:

- : off
- ☐ : wiper operation
- ☐ : washer fluid is sprayed onto the rear window

The wiping frequency depends on the vehicle speed.

The rear window wiper comes on automatically when the windscreen wiper is switched on and reverse gear is engaged.

Do not use if the rear window is frozen.

Switch off in car washes.

## Outside temperature



A drop in temperature is indicated immediately and a rise in temperature after a time delay.

If outside temperatures drop to 3 °C, the °C flashes in the Driver Information Centre as a warning for icy road conditions. This will continue to flash until temperatures rise above 3 °C.

### **⚠ Warning**

The road surface may already be icy even though the display indicates a few degrees above 0 °C.

## **Clock**

Depending on vehicle, the current time may appear in the Info Display or the Driver Information Centre.

## **Info Display**



Hours and minutes can be adjusted by pressing the appropriate buttons by the display or with the Infotainment system controls.

For further information, refer to the Infotainment manual.

## **Driver Information Centre**

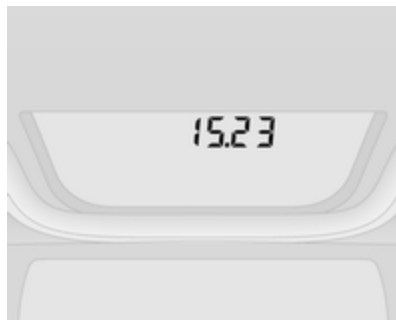

Display the clock setting function by pressing the button repeatedly on the end of the wiper lever.

Press and hold the button for approx. 5 seconds:

- hours flash
- press button repeatedly to change hours
- wait for approx. 5 seconds to set hours
- minutes flash



- press button repeatedly to change minutes
- wait for approx. 5 seconds to set minutes

Driver Information Centre ⇨ 101.

## Power outlets



A 12 V power outlet is located on the instrument panel. Fold the cover upwards.



Depending on vehicle, an additional outlet may be located in the rear of the vehicle.

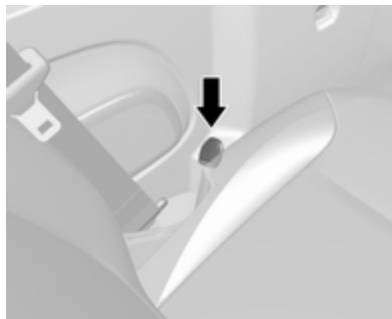

A further additional outlet may be located alongside the outer edge of the bench seat.

Connecting electrical accessories while the engine is off will discharge the vehicle battery. Do not exceed the maximum power consumption of 120 W.

### **⚠ Danger**

To avoid the risk of fire, if multiple power outlets are used simultaneously, the total power consumption of connected accessories must not exceed 180 W.

With ignition off the power outlet may be deactivated.

Additionally, the power outlet may be deactivated in case of low battery voltage.

Electrical accessories that are connected must comply with the electromagnetic compatibility requirements laid down in DIN VDE 40 839.

**Caution**

Do not connect any current-delivering accessories, e.g. electrical charging devices or batteries.

Do not damage the outlets by using unsuitable plugs.

**USB socket**

In the Infotainment unit (or on the instrument panel) there is a USB socket  $\psi$  for the connection of external audio sources and for charging devices.

**Notice**

The sockets must always be kept clean and dry.

AUX socket, SD card slot – refer to the Infotainment manual.

**Cigarette lighter**

The cigarette lighter is located on the instrument panel.

Press in cigarette lighter. It switches off automatically once the element is glowing. Pull out lighter.

**Ashtrays****Caution**

To be used only for ash and not for combustible rubbish.

**Portable ashtray**

Ashtray container for mobile use in the vehicle. To use, open cover.

Ashtrays can be placed in the cupholders at both ends of the instrument panel, centrally in the lower instrument panel, and depending on version, in the door pockets or in the rear seat area.

Cupholders ⇨ 73.

## Warning lights, gauges and indicators

### Instrument cluster

In some versions, the needles of the instruments briefly rotate to the end position when the ignition is switched on.

### Speedometer

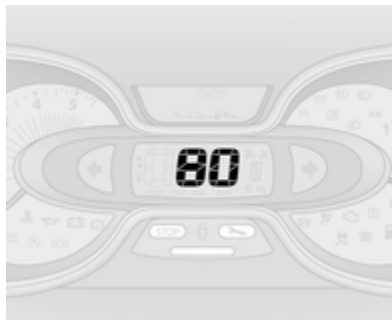

Indicates vehicle speed.

### Speed limiter

Maximum speed may be restricted by a speed limiter. As a visible indication of this, a warning label is located on the instrument panel.

A warning chime will sound for 10 seconds every 40 seconds if the vehicle briefly exceeds the set limit.

#### Notice

Under certain conditions (e.g. steep inclines), the vehicle speed may exceed the set limit.

Speed limiter ⇨ 153.

Cruise control ⇨ 151.

## Odometer



Displays the recorded distance.

## Trip odometer

The trip odometer appears below the odometer in the Driver Information Centre and displays the distance travelled since the last reset.

To reset, with the trip odometer displayed, press and hold button on end of wiper lever for a few seconds with the ignition on. The display will flash and the value will reset to zero.

Driver Information Centre ↻ 101.

## Tachometer



Displays the engine speed.

Drive in a low engine speed range for each gear as much as possible.

### Caution

If the needle is in the yellow warning zone, the maximum permitted engine speed is exceeded. Engine at risk.

## Fuel gauge

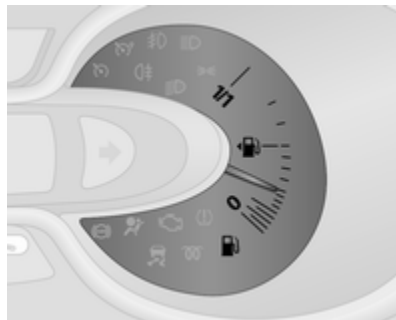

Displays fuel level in the tank.

The arrow indicates the vehicle side where the fuel filler flap is located.

Control indicator  also illuminates in instrument cluster ↻ 92 when fuel level is low (range of approx. 30 miles): refuel immediately ↻ 160.

Never run the tank dry.

Diesel fuel system, bleeding ↻ 173.

**Notice**

To ensure the fuel level is displayed correctly, the ignition must be switched off before refuelling. Avoid minor fuel top-ups (e.g. less than 5 l) to ensure accurate readings.

Because of the fuel remaining in the tank, the top-up quantity may be less than the specified tank capacity.

**AdBlue level indicator**

The current AdBlue percentage remaining can be shown in the Driver Information Centre ↻ 101.

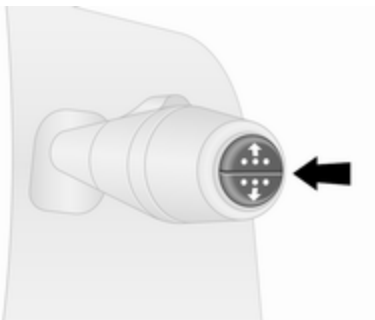

Press button on end of wiper lever repeatedly until the 'AdBlue percentage remaining' menu is displayed.

**Level warnings**

If the AdBlue level falls below a certain value, a level warning will be displayed in the Driver Information Centre ↻ 101. Additionally, control indicator  ↻ 99 illuminates continuously together with a warning chime.

Refill the AdBlue tank as soon as possible.

AdBlue ↻ 140.

**Fuel economy gauge**

Depending on version, the fuel economy gauge (or 'driving style indicator') provides an instantaneous calculation of fuel efficiency based on current driving style.

The gauge uses colours to indicate current fuel efficiency:

- Green : best fuel economy is being achieved
- Yellow : driving style too aggressive
- Orange : least efficient fuel economy

The fuel economy gauge is enabled by default.

Depending on version, the fuel economy gauge (or 'driving style indicator') can be disabled via the Infotainment system. Refer to Infotainment manual for further information.

## Service display

When the ignition is switched on, the remaining distance before the next service is due may be shown briefly in the Driver Information Centre. Based on driving conditions, the interval at which a service will be indicated can vary considerably.

The 'distance before service' display can also be shown by pressing button on end of wiper lever for approx. 5 seconds.

When the remaining distance before the next service is less than 1000 miles or one month, a message appears in the Driver Information Centre.

When the distance reaches 0 miles or the service date is due, control indicator  illuminates in the instrument cluster and the Driver Information Centre respectively, and a corresponding message appears in the Driver Information Centre.

The vehicle needs a service. Seek the assistance of a workshop.

### Resetting the service display

After a service, the service display must be reset:

Select the 'distance before service' display in the Driver Information Centre by pressing button repeatedly on the end of the wiper lever, then press and hold button for approx. 10 seconds until the 'distance before service' is displayed continuously, i.e. the display no longer flashes.

On some vehicles, it may be necessary to press and hold the button twice. In this event, proceed as follows:

After selecting the 'distance before service' display, press and hold button for approx. 10 seconds until the 'distance before service' flashes in

the display. Then press and hold button again for approx. 10 seconds to reset the service interval.

If control indicator  does not extinguish from the instrument cluster, drive a minimum of 10 miles then switch off ignition for at least 1 minute before repeating procedure.

Trip computer ⇨ 104.

Driver Information Centre ⇨ 101.

Service information ⇨ 203.

## Control indicators

The control indicators described are not present in all vehicles. The description applies to all instrument versions.

Depending on the equipment the position of the control indicators may vary.

When the ignition is switched on, most control indicators will illuminate briefly as a functionality test.

The control indicator colours mean:

red : danger, important reminder  
 yellow : warning, information, fault  
 green : confirmation of activation

---

blue : confirmation of activation  
white : confirmation of activation



## Control indicators in the instrument cluster



































## Control indicators in the roof console



### Overview

-  Turn lights ⇨ 95
-  Seat belt reminder ⇨ 96
-  Airbag and belt tensioners ⇨ 96
-  ON Airbag activation ⇨ 96
-  OFF Airbag deactivation ⇨ 96
-  Charging system ⇨ 97
-  Malfunction indicator light ⇨ 97

-  Service vehicle soon ⇨ 97
- STOP  
 Stop engine ⇨ 97
-  Brake system ⇨ 97
-  Antilock brake system (ABS) ⇨ 98
-  Gear shifting ⇨ 98
-  Electronic Stability Control ⇨ 98
-  Electronic Stability Control off ⇨ 98
-  Engine coolant temperature ⇨ 98
-  Preheating ⇨ 99
-  AdBlue ⇨ 99
-  Tyre pressure monitoring system ⇨ 99
-  Engine oil pressure ⇨ 99
- ECO** Fuel economy mode ⇨ 100
-  Low fuel ⇨ 100
-  Autostop (Stop-start system) ⇨ 100

-  Autostop inhibited (Stop-start system) ⇨ 100
-  Exterior light ⇨ 100
-  Exterior light ⇨ 100
-  High beam ⇨ 100
-  Fog light ⇨ 101
-  Rear fog light ⇨ 101
-  Cruise control ⇨ 101
-  Speed limiter ⇨ 101
- T** Tachograph ⇨ 101
-  Door open ⇨ 101

### Turn lights

⇨ flashes green.

Flashes if a turn light or the hazard warning flashers are activated.

Rapid flashing: failure of a turn light or associated fuse.

An audible warning can be heard when the turn lights are on.

Bulb replacement ⇨ 175.

Fuses ⇨ 181.

Turn lights ⇨ 111.

## Seat belt reminder

 illuminates or flashes red.

If the seat belt is unfastened, control indicator  will flash when vehicle speed exceeds approx. 10 mph. A warning chime also sounds for up to two minutes.

If the seat belt is fastened, the indicator light extinguishes.

### Notice

Heavy objects on the front seats may cause control indicator  to illuminate. Remove the object from the seat or fasten the seat belt.

### Warning

Fasten seat belt before each trip.

In the event of an accident, people not wearing seat belts endanger their fellow occupants and themselves.

Three-point seat belts ⇨ 54.

## Airbag and belt tensioners

 illuminates yellow.

Illuminates briefly when the ignition is switched on.

If it does not illuminate or illuminates whilst driving, there is a fault in the belt tensioner or the airbag system. The airbags and belt tensioners may fail to trigger in the event of an accident.

Deployment of the belt tensioners or airbags is indicated by continuous illumination of .

### Warning

Have the cause of the fault remedied immediately by a workshop.

Belt tensioners ⇨ 53.

Airbag system ⇨ 58.



## Airbag deactivation



 ON illuminates yellow.

The front passenger airbag is activated.

 OFF illuminates yellow.

The front passenger airbag is deactivated ⇨ 62.

If both control indicators  ON and  OFF are illuminated simultaneously, there is a system failure. The status of the system is not discernible, therefore no person is permitted to occupy the front passenger seat. Contact a workshop immediately.

If illuminated in conjunction with  or , seek the assistance of a workshop.

### Danger

Risk of fatal injury for a child using a child restraint system together with activated front passenger airbag.

Risk of fatal injury for an adult person with deactivated front passenger airbag.

Airbag system ⇨ 58.

Belt tensioners ⇨ 53.

Airbag deactivation ⇨ 62.

## Charging system

 illuminates red.

Illuminates briefly when the ignition is switched on.

## Illuminates when the engine is running

If control indicator  illuminates when the engine is running (together with control indicator STOP and a warning chime): Stop, switch off engine.

Vehicle battery is not charging.  
Engine cooling may be interrupted.  
Power to the brake servo unit may be cut. Seek the assistance of a workshop.

## Malfunction indicator light

 illuminates or flashes yellow.

Illuminates briefly when the ignition is switched on.

## Illuminates when the engine is running

Fault in the emission control system. The permitted emission limits may be exceeded. Seek the assistance of a workshop immediately.

## Flashes when the engine is running

Fault that could lead to catalytic converter damage. Ease up on the accelerator until the flashing stops. Seek the immediate assistance of a workshop.

## Service vehicle soon

 illuminates yellow.



Illuminates briefly when the ignition is switched on.

May illuminate together with other control indicators and a corresponding message in the Driver Information Centre  $\rightarrow$  101. Seek the assistance of a workshop immediately.

## Stop engine

STOP illuminates red.

Illuminates briefly when the ignition is switched on.

Illuminates together with other control indicators (e.g., ,  and ), accompanied by a warning chime and a corresponding message in the Driver Information Centre  $\rightarrow$  101: stop engine immediately and seek the assistance of a workshop.

## Brake system

 illuminates red.

Illuminates after the ignition is switched on if the parking brake is applied  $\rightarrow$  147 and extinguishes when the parking brake is released.

Illuminates when the parking brake is released if the brake fluid level is too low  $\rightarrow$  170.

### Warning

Stop. Do not continue your journey. Consult a workshop.



If  illuminates together with control indicator STOP and a warning chime, there is a fault in the braking system. A corresponding message also appears in the Driver Information Centre ⇨ 101. Seek the assistance of a workshop immediately.



Brake system ⇨ 146.

## Antilock brake system (ABS)

 illuminates yellow.

Illuminates briefly after the ignition is switched on. The system is ready for operation when  extinguishes.

If control indicator  does not go out after a few seconds, or if it illuminates while driving, there is a fault in the ABS. Control indicator  may also illuminate in the instrument cluster together a corresponding message in the Driver Information Centre ⇨ 101. The brake system remains operational but without ABS regulation and Electronic Stability Control.

If control indicators , ,  and STOP illuminate, there is a fault in the braking system. A corresponding message appears in the Driver Information Centre. Seek the assistance of a workshop immediately.

Antilock brake system (ABS) ⇨ 146.

## Gear shifting

 or  illuminates.

It is recommended to shift gear when illuminated to improve fuel economy.

## Electronic Stability Control

 flashes or illuminates yellow.

Illuminates briefly when the ignition is switched on.

## Flashing during driving

The system is actively engaged. Engine output may be reduced and the vehicle may be braked automatically to a small degree.

## Illuminates while driving



The system is not available. A corresponding message also appears in the Driver Information Centre ⇨ 101.

ESC ⇨ 149.

Traction Control system ⇨ 148.

## Electronic Stability Control off

 illuminates green.

If ESC has been deactivated with  on the instrument panel, control indicator  illuminates and a corresponding message appears in the Driver Information Centre ⇨ 101.

ESC ⇨ 149.

Traction Control system ⇨ 148.

## Engine coolant temperature

 illuminates blue or red.

Illuminates red briefly when the ignition is switched on, then turns blue.

## Illuminates red when the engine is running

Stop, switch off engine.

Caution
Coolant temperature too high.

Check coolant level ↗ 169.

If there is sufficient coolant, consult a workshop.

The control indicator must be blue before continuing driving.

## Preheating

 illuminates yellow.

Preheating is activated. Only activates when outside temperature is low.

## AdBlue

 illuminates yellow.

AdBlue level is low. Refill AdBlue as soon as possible, to avoid prevention of engine starts.

Illuminates together with control indicator  to indicate a system failure or as a warning that engine starting may not be possible after a certain distance. Seek the assistance of a workshop immediately.

A corresponding message appears in the Driver Information Centre ↗ 101.

AdBlue percentage remaining can also be checked by pressing button repeatedly on end of wiper lever.

Trip computer ↗ 104.

AdBlue ↗ 140.



## Tyre pressure monitoring system

 illuminates or flashes yellow.

Illuminates briefly when the ignition is switched on.

### Illuminates



Tyre pressure loss. Stop immediately and check tyre pressure.

Control indicator  illuminates together with  ↗ 97 and a corresponding message appears in

the Driver Information Centre when a puncture or severely under-inflated tyre is detected.

### Flashes

Fault in system. After a delay the control indicator illuminates continuously. Consult a workshop.

Control indicator  illuminates together with  ↗ 97 and a corresponding message appears in the Driver Information Centre when a tyre without a pressure sensor is mounted (e.g. spare wheel).

Tyre pressure monitoring system ↗ 188.

## Engine oil pressure

 illuminates red.

Illuminates briefly when the ignition is switched on.

**Illuminates when the engine is running**

If control indicator  illuminates when the engine is running (together with control indicator STOP and a warning chime): Stop, switch off engine.

**Caution**

Engine lubrication may be interrupted. This may result in damage to the engine and / or locking of the drive wheels.

1. Depress clutch.
2. Select neutral gear (or move selector lever to **N**).
3. Move out of the flow of traffic as quickly as possible without impeding other vehicles.
4. Switch off ignition.

**⚠ Warning**

When the engine is off, considerably more force is needed to brake and steer.

Do not remove key until vehicle is stationary, otherwise the steering wheel lock could engage unexpectedly.

Keep engine turned off and let the vehicle be towed to a workshop  
↻ 167.

**Fuel economy mode**

**ECO** illuminates green when ECO mode is engaged to reduce fuel consumption.

ECO mode, driving economically  
↻ 129.

**Low fuel**

 illuminates yellow.

Illuminates briefly when the ignition is switched on.

Illuminates when level in fuel tank is low (range of approx. 30 miles).

Refuel immediately ↻ 160.

Catalytic converter ↻ 139.

Diesel fuel system bleeding ↻ 173.

**Stop-start system**

 illuminates when engine is in an Autostop.

 illuminates when an Autostop is inhibited when certain conditions are not fulfilled.

Stop-start system ↻ 135.

**Exterior light**

 illuminates green.

Illuminated when the headlights are on.

 illuminates green.

Illuminated when the sidelights are on.

Lighting ↻ 108.

**High beam**

 illuminates blue.

Illuminated when high beam is on and during headlight flash ↗ 109.

## Front fog lights

☾ illuminates green.

Illuminated when the front fog lights are on ↗ 111.

## Rear fog light

☾ illuminates yellow.

Illuminated when the rear fog light is on ↗ 112.

## Cruise control

☾, ☾ illuminate green.

☾ illuminates green when a certain speed is stored.

☾ illuminates green when the system is on.

Cruise control ↗ 151.

## Speed limiter

☾ illuminates yellow.

Illuminates when the system is on.

Speed limiter ↗ 153.

## Tachograph

T illuminates when there is a fault ↗ 106.

## Door open

☾ illuminates red.

Illuminates when a door is not fully closed.

A corresponding message also appears in the Driver Information Centre ↗ 101.

## Displays

### Driver Information Centre



Depending on vehicle configuration, the following items appear in the display:

- outside temperature ↗ 85
- clock ↗ 86
- odometer ↗ 90
- trip odometer ↗ 90
- service display ↗ 92
- vehicle messages ↗ 102
- trip computer ↗ 104

## Info Display



The Info Display displays Infotainment system information, the time and depending on version the outside temperature.

Press  $\odot$  to switch the Infotainment system on. Alternatively, it automatically switches on when the ignition is switched on.

Depending on system, the Infotainment system is operated via buttons and rotary knobs on the Infotainment system fascia, the steering column controls, the voice recognition system (if available) or via the touchscreen display.

## Touchscreen operation

Make the appropriate selection from the available menus and options by touching the display screen with the finger.

For further information, refer to the Infotainment manual.

## Vehicle messages

Messages are displayed in the Driver Information Centre and may be accompanied by illumination of control indicator  $\blacktriangleright$  or STOP in the instrument cluster.

### Information messages

Information messages regarding, e.g. engine starting conditions, stop-start system, parking brake application, central locking, steering wheel lock etc. provide the current status of certain vehicle functions and instructions for use.

### Fault messages

Fault messages regarding, e.g. fuel filter, airbags, exhaust emissions etc. are displayed together with control indicator  $\blacktriangleright$ . Drive with caution and seek the assistance of a workshop as soon as possible.

To remove fault messages, e.g. "CHECK INJECTION", from the display, press button on end of wiper lever. After a few seconds the message may disappear



automatically and  remains illuminated. The fault will then be stored in the on board system.

### Warning messages

Warning messages regarding, e.g. engine, battery or brake system failure, are displayed together with control indicator  and may be accompanied by a warning chime. Stop engine immediately and seek the assistance of a workshop.

Warning messages, e.g. "**BATTERY CHARGING FAULT**" disappear from the display automatically when the cause of the fault has been remedied.

### Fuel economy messages

Fuel economy messages provide tips to improve fuel efficiency. Journeys can be saved in the system memory, enabling you to compare performances.

Refer to Infotainment manual for further information.

Fuel economy rating ⇨ 104.

### Warning chimes

If several warnings appear at the same time, only one warning chime will sound.

### When starting the engine or whilst driving:

The warning chime regarding unfastened seat belts has priority over any other warning chime.

- If seat belt is not fastened ⇨ 53.
- If the parking assist detects an object ⇨ 154.
- If the vehicle speed briefly exceeds a set limit ⇨ 151, ⇨ 153.
- If a door or the bonnet is not properly closed when vehicle exceeds a certain speed.
- During activation and deactivation of alarm monitoring of vehicle inclination ⇨ 36.
- If there is a fault in the brake system ⇨ 97.
- If the vehicle battery is not charging ⇨ 97.

- If engine lubrication is interrupted ⇨ 99.
- If AdBlue needs to be refilled or a fault is present ⇨ 140.
- If the electronic key is outside of the detection range.  
Electronic key system ⇨ 21.  
Power button ⇨ 131.

### When the vehicle is parked and / or the driver's door is opened:

- If the key has been left in the ignition.
- If the electronic key has been left in the card reader.  
Electronic key system ⇨ 21.  
Power button ⇨ 131.
- If the vehicle is in an Autostop.  
Stop-start system ⇨ 135.
- If the exterior lights are on ⇨ 108.

## Engine oil level

If the minimum engine oil level is reached, a message is displayed in the Driver Information Centre ⇨ 101 for 30 seconds after the engine is started.

Check oil level ⇨ 167.

## Trip computer

The trip computer provides information on driving data, which is continually recorded and evaluated electronically.

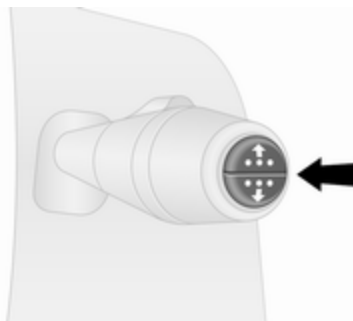

Depending on vehicle, the following functions can be selected by pressing button repeatedly on end of wiper lever:

- fuel used
- average consumption
- instantaneous consumption
- range
- distance travelled

- average speed
- AdBlue percentage remaining ⇨ 140
- distance before service ⇨ 92
- clock ⇨ 86
- outside temperature ⇨ 85
- cruise control and speed limiter stored speed ⇨ 151
- fuel economy rating (ecoScoring)
- fault and information messages
- odometer ⇨ 90
- trip odometer ⇨ 90

## Fuel used

Displays the amount of fuel consumed since the last reset.

The measurement can be restarted at any time by pressing and holding the button.

## Average consumption

The value is displayed after driving a distance of 0.25 miles.

Average consumption is displayed, taking into consideration the distance travelled and the fuel used since the last reset.

The measurement can be restarted at any time.

### **Instantaneous consumption**

The value is displayed after reaching a speed of 20 mph.

### **Range**

The value is displayed after driving a distance of 0.25 miles.

The range is calculated from the current contents of the fuel tank and the average consumption since the last reset.

The range will not be displayed if control indicator  is illuminated in the Driver Information Centre ↗ 100.

### **Distance travelled**

Displays the distance driven since the last reset.

The measurement can be restarted at any time.

### **Average speed**

The value is displayed after driving a distance of 0.25 miles.

The average speed since the last reset is displayed.

The measurement can be restarted at any time.

Interruptions in the journey with the ignition off are not included in the calculations.

### **Reset trip computer information**

To reset the trip computer, select one of its functions then press and hold the button on the end of the wiper lever.

The following trip computer information can be reset:

- fuel used
- average consumption
- distance travelled
- average speed

The trip computer will reset automatically when the maximum value of any of the parameters is exceeded.

### **Fuel economy rating (ecoScoring)**

If equipped, a rating of 0 to 100 is shown in the Driver Information Centre to help evaluate fuel efficiency, based on your driving style.

Higher ratings indicate better fuel economy.

Tips to improve fuel economy are also given in the Driver Information Centre. Journeys can be saved in the system memory, enabling you to compare performances. Refer to Infotainment manual for further information.

Vehicle messages ↗ 102.

### **Journey record**

When the engine is switched off, a record of the last journey may be shown in the Driver Information Centre.

The following information is displayed:

- average fuel consumption
- total fuel consumption

- trip odometer
- fuel saved in miles

### Unit of measurement

To change the unit of measurement for the duration of a journey:

#### Vehicles with power button:

With ignition off, simultaneously press and hold button on end of wiper lever and press the power button ↗ 131. The Driver Information Centre flashes for approx. 10 seconds until the new unit is displayed. Release button on end of wiper lever when the display stops flashing.

#### Vehicles without power button:

With ignition off, simultaneously press and hold button on end of wiper lever and switch on the ignition. The Driver Information Centre flashes for approx. 10 seconds until the new unit is displayed. Release button on end of wiper lever when the display stops flashing.

When the engine is switched off, the trip computer automatically returns to the original unit of measurement.

### Interruption of power supply

If the power supply has been interrupted or if the vehicle battery voltage has dropped too low, the values stored in the trip computer will be lost.

## Tachograph

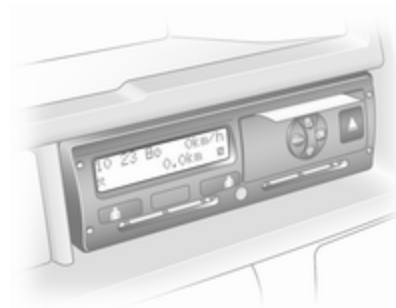

The tachograph is operated as described in the operating instructions supplied. Observe regulations regarding use.

Depending on equipment, the tachograph may be fitted in a console located above the Infotainment system in the instrument panel.

**Notice**

When a tachograph is fitted, the total distance travelled may be shown only on the tachograph and not in the odometer within the instrument display.

Odometer ⇨ 90.

Control indicator T ⇨ 101 illuminates in the instrument cluster in the event of a fault. Seek the assistance of a workshop.

## Lighting

<b>Exterior lighting</b> .....	<b>108</b>
Light switch .....	108
Automatic light control .....	109
High beam .....	109
Headlight flash .....	109
Headlight range adjustment ....	109
Headlights when driving	
abroad .....	110
Daytime running lights .....	110
Cornering lights .....	110
Hazard warning flashers .....	111
Turn lights .....	111
Front fog lights .....	111
Rear fog light .....	112
Reversing lights .....	112
Misted light covers .....	112
<b>Interior lighting</b> .....	<b>112</b>
Instrument panel illumination	
control .....	112
Interior lights .....	112
Load compartment lighting .....	114
Reading lights .....	114
Glove box lighting .....	114
<b>Lighting features</b> .....	<b>114</b>
Entry lighting .....	114

Exit lighting .....	114
Battery discharge protection ....	115

## Exterior lighting

### Light switch

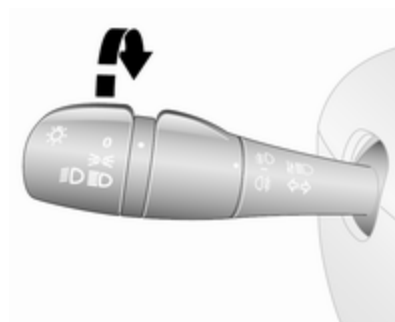

Turn outter switch:

- O** : off
- ☞☞** : sidelights
- ☞☞☞** : headlights

High beam control indicator **☞☞☞**  
 ⇄ 100.

Low beam control indicator **☞☞☞** ⇄ 100.

#### Notice

If the headlights have been switched on manually, a warning chime will sound when the engine is switched

off and when the driver's door is opened as a reminder that the lights are still on.

### Tail lights

Tail lights are illuminated together with low beam and sidelights.

### Automatic light control

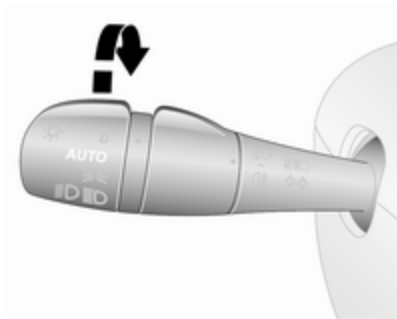

**AUTO** : automatic light control

When the automatic light control function is activated and the engine is running, the system switches between daytime running lights and headlights depending on the external lighting conditions.

For reasons of safety, it is advisable to have the automatic light control function activated.

### Automatic headlight activation

During poor lighting conditions the headlights are switched on.

Additionally, headlights are switched on if the windscreen wiper has been activated for several wipes.

Daytime running lights ⇨ 110.

### High beam

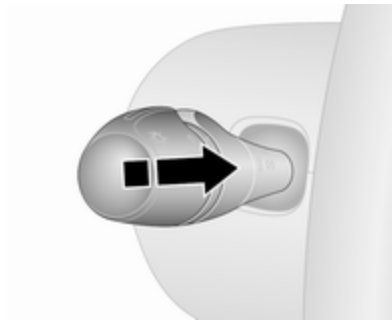

To switch from low to high beam, push stalk.

To switch back to low beam, push stalk again or pull.

### Headlight flash

To activate the headlight flash, pull stalk.

### Headlight range adjustment

#### Manual headlight range adjustment



Adapt headlight range to the vehicle load to prevent dazzling of oncoming traffic.

Turn thumb wheel  to required position:

0 : only driver, no load  
2 : with passengers and full load

Select another position depending on load condition.

### Headlights when driving abroad

The asymmetrical headlight beam extends visibility at the edge of the road at the passenger side.

However, when driving in countries where traffic drives on the opposite side of the road, adjust the headlights to prevent dazzling of oncoming traffic.

### Adjustment

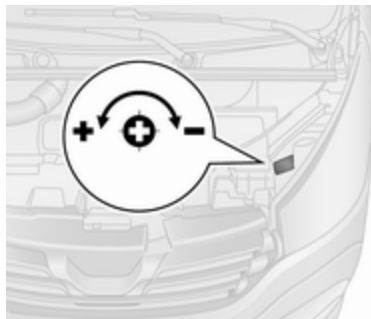

Open the bonnet  166 and identify the marking (shown in the illustration) beside each of the headlights.

For each headlight:

Using a screwdriver, turn the screw by a  $\frac{1}{4}$  turn towards the **-** symbol to lower the beams or towards the **+** symbol to raise the beams.

Ensure the headlight beams are returned to their original positions when required.

### Daytime running lights

Daytime running lights increase visibility of the vehicle during daylight. They may be switched on automatically when the engine is running.

If required, the daytime running lights can be deactivated via the Infotainment system. For further information, refer to Infotainment manual.

Automatic light control  109.

### Cornering lights

With the low beam switched on, depending on the steering angle, vehicle speed and gear selected when cornering, the front fog light will also switch on, to illuminate the corner of the road on the respective side.



## Hazard warning flashers



Operated by pressing .

In the event of hard braking, the hazard warning flashers may turn on automatically. Switch off by pressing .

## Turn lights

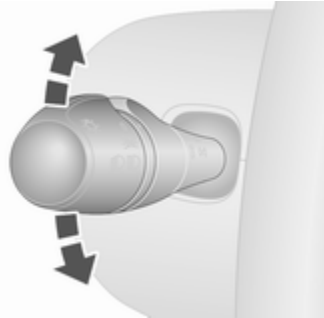

stalk up : right turn light  
stalk down : left turn light

A resistance point can be felt when moving the stalk.



Constant flashing is activated when the stalk is being moved beyond the resistance point. It is deactivated when the steering wheel is moved in the opposite direction or stalk is manually moved back to its neutral position.

Activate temporary flashing by holding the stalk just before the resistance point. Turn lights will flash until stalk is being released.

To activate three flashes, tap the stalk briefly without passing the resistance point.

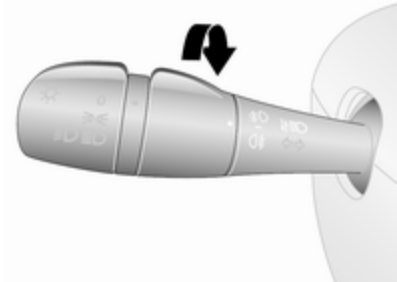
## Front fog lights



Turn inner switch to position . Control indicator  illuminates in the instrument cluster.

Front fog lights will only operate when the ignition and headlights are switched on.

## Rear fog light

Turn inner switch to position 0#.  
Control indicator 0# illuminates in the instrument cluster.

Rear fog light comes on together with front fog lights and will only operate when the ignition and headlights are switched on.

## Reversing lights

The reversing lights come on when the ignition is on and reverse gear is selected.

## Misted light covers

The inside of the light covers may mist up briefly in poor, wet and cold weather conditions, in heavy rain or after washing. The mist disappears quickly by itself. To help, switch on the headlights.

## Interior lighting

### Instrument panel illumination control



Brightness of the following lights can be adjusted when the exterior lights are on:

- instrument panel illumination
- Info Display
- illuminated switches and operation elements

Turn thumb wheel  until the desired brightness is obtained.

## Interior lights

### Courtesy lights

During entry and exit of the vehicle, depending on switch position the front and rear courtesy lights automatically switch on, together with the foot well lights, then switch off after a delay.

### Front courtesy lights



Operate rocker switch:

press **0** : off  
 centre position : automatic switching on and off  
 press  : on

With the rocker switch in its central position, the light functions as a courtesy light and illuminates when the front doors are opened.

When the front doors are closed, the courtesy light extinguishes after a delay.

### Rear courtesy lights

The upper load compartment lights can be set to illuminate when the side or rear doors are opened, or switched on constantly.



Operate rocker switch:

press **O** : off  
 centre position : automatic switching on and off  
 press  : on

With the rocker switch in its central position, the light functions as a courtesy light and illuminates when the side or rear doors are opened.

When the doors are closed, the courtesy light extinguishes after a delay.

### LED spotlights

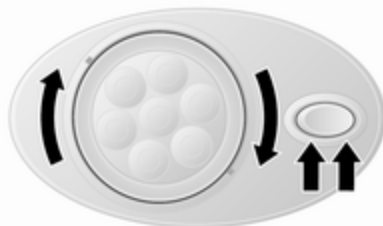

Depending on vehicle, adjustable LED spotlights, also including rocker switch, may be present.

### Bench seat lights

Depending on vehicle, bench seat light illuminates when the sliding side door is opened.

### Rear seats lights



Depending on vehicle, rear seats lights can be set to illuminate when a door is opened, or switched on constantly.

The lights are operated by pressing the switch of the respective light.

## Load compartment lighting

The lower load compartment lights come on when the load compartment is opened.

## Reading lights

### Front reading light



Operate rocker switch:

press **O** : off

press  : on

## Glove box lighting

The glovebox light comes on when the glovebox is opened.

## Lighting features

### Entry lighting

#### Welcome lighting

Vehicle lights are switched on for a short time to facilitate locating the vehicle when it is dark.

#### Remote control operation

Lights switch on when unlocking the vehicle with the remote control.

#### Electronic key system operation



Press . Press again to switch off.

## Exit lighting

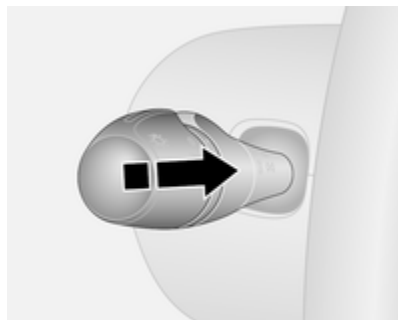

If equipped, headlights come on for approx. 30 seconds after the vehicle is parked and the system is activated.

### Activating

1. Switch off lights (position **O**).
2. Switch off ignition.
3. Remove ignition key.
4. Open driver's door.
5. Pull stalk towards steering wheel.

A corresponding message may appear in the Driver Information Centre  101.

This action can be repeated up to four times to a maximum period of 2 minutes.

The lighting is turned off immediately by switching on the ignition or turning the light switch.

### **Battery discharge protection**

To prevent discharge of the vehicle battery when the ignition is switched off, some interior lights may be switched off automatically after some time.

## Climate control

<b>Climate control systems</b> .....	<b>116</b>
Heating and ventilation system	116
Air conditioning system .....	117
Electronic climate control system .....	118
Rear heating system .....	120
Rear air conditioning system ...	121
Auxiliary heater .....	122
<b>Air vents</b> .....	<b>127</b>
Adjustable air vents .....	127
Fixed air vents .....	128
Glovebox cooler .....	128
<b>Maintenance</b> .....	<b>128</b>
Air intake .....	128
Air conditioning regular operation .....	128
Service .....	128

## Climate control systems

### Heating and ventilation system



Controls for:

- temperature
- fan speed
- air distribution

Heated rear window  ⇨ 43.

### Temperature





red : warm  
blue : cold

Heating will not be fully effective until the engine has reached normal operating temperature.

### Fan speed



Adjust the air flow by switching the fan to the desired speed.

### Air distribution

-  : to head area
-  : to head area and foot well
-  : to foot well
-  : to windscreen, front door windows and foot well
-  : to windscreen and front door windows

Intermediate settings are possible.

### Demisting and defrosting the windows

- Set temperature control to warmest level.
- Set fan speed to highest level.
- Set air distribution control to .
- Switch on heated rear window .

- Open side air vents as required and direct them towards door windows.
- For simultaneous warming of the foot well, set air distribution control to .

Heated rear window  43.

## Air conditioning system

In addition to the heating and ventilation system, the air conditioning system has controls for:

**A/C** : cooling

 : air recirculation

Heated seats  48.

## Cooling (A/C)



Press **A/C** to switch on cooling. Activation is indicated by illumination of the LED in the button. Cooling is only functional when the engine is running and climate control fan is switched on.

Press **A/C** again to switch off cooling.

The air conditioning system cools and dehumidifies (dries) the air when outside temperature is above a specific level. Therefore condensation may form and drip from under the vehicle.

If no cooling or drying is required, switch off the cooling system for fuel saving reasons. Activated cooling may inhibit an Autostop.

Stop-start system  135.

### Notice

Air conditioning performance is reduced when ECO mode has been activated  129.

## Air recirculation system





Press  to activate air recirculation mode. Activation is indicated by illumination of the LED in the button.

Press  again to deactivate air recirculation mode.



**Warning**

The exchange of fresh air is reduced in air recirculation mode. In operation without cooling, the air humidity increases, so the windows may mist up from inside. The quality of the passenger compartment air deteriorates, which may cause the vehicle occupants to feel drowsy.

In warm and very humid ambient air conditions, the windscreen might mist up from outside when cold air is directed towards it. If windscreen mists up from outside, activate windscreen wiper and avoid the use of air distribution settings  and .



**Maximum cooling**

Briefly open the windows so that hot air can disperse quickly.

- Cooling **A/C** on.
- Air recirculation system  on.
- Set air distribution control to .
- Set temperature control to coldest level.

- Set fan speed to highest level.
- Open all air vents.

**Demisting and defrosting the windows**

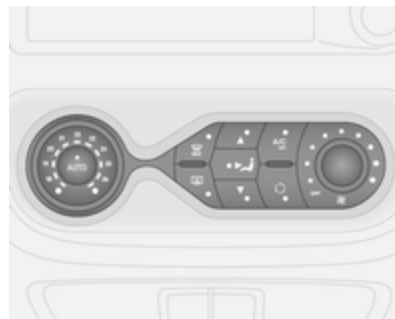

- Set temperature control to warmest level.
- Set fan speed to highest level.
- Set air distribution control to .
- Switch cooling **A/C** on.
- Switch on heated rear window .
- Open side air vents as required and direct them towards door windows.
- For simultaneous warming of the foot well, set air distribution control to .

Heated rear window  ⇨ 43.

**Electronic climate control system**

Controls for:

- air distribution
- temperature
- fan speed

**AUTO** : automatic mode  
 : demisting and defrosting  
 : heated rear window  
**A/C OFF** : switch off air conditioning  
 : manual air recirculation

Heated rear window  ⇨ 43.

Heated seats ⇨ 48.



The preselected temperature is automatically regulated. In Automatic mode, the fan speed and air distribution automatically regulate the air flow.

The system can be manually adapted via the use of air distribution and air flow controls.

Electronic climate control system is only fully operational when the engine is running.

## Automatic mode AUTO

Basic setting for maximum comfort:

- Switch on the fan.
- Press **AUTO**: fan speed, air distribution, cooling and air recirculation are regulated automatically.
- Set the desired temperature.
- Open all air vents.

To switch off the electronic climate control system, switch off the fan.



## Temperature preselection

Temperatures can be set to the desired value.

If the minimum temperature is set, the climate control system runs at maximum cooling.



If the maximum temperature is set, the climate control system runs at maximum heating.

## Demisting and defrosting the windows

- Press : LED illuminates in the button when activated.
- Temperature, air distribution and cooling are regulated automatically and the fan runs at high speed.
- Switch on heated rear window   43.

To return to Automatic mode: press  or **AUTO**.

### Notice

If  is pressed while the engine is running, an Autostop will be inhibited until  is pressed again.

If  is pressed while the engine is in an Autostop, the engine will restart automatically.

Stop-start system  135.

## Manual settings

Manually changing any of the following settings will deactivate Automatic mode:

### Fan speed

Adjust the air flow manually by switching the fan to the desired speed.

If the fan is switched off, the air conditioning is also deactivated.

### Air distribution

Press appropriate button for desired adjustment. LED illuminates in the button when activated.

▲ : to windscreen and front door windows

↺ : to head area

▼ : to foot well

Combinations of settings are possible by pressing two buttons until both LEDs are illuminated.

To return to Automatic mode: Press **AUTO** button.

## Cooling A/C

The air conditioning system cools and dehumidifies (dries) the air when outside temperature is above a specific level. Therefore condensation may form and drip from under the vehicle.

### Notice

Air conditioning performance is reduced when ECO mode has been activated ⇨ 129.

If no cooling or drying is required press **A/C OFF** to switch the cooling system off, thus saving fuel. LED illuminates in the button.

To return to Automatic mode: Press **AUTO** button.

## Air recirculation mode

Activate or deactivate manual air recirculation mode with . LED illuminates in the button when activated.

## Warning

The exchange of fresh air is reduced in air recirculation mode. In operation without cooling the air humidity increases, so the windows may mist up from inside. The quality of the passenger compartment air deteriorates, which may cause the vehicle occupants to feel drowsy.

To return to Automatic mode: Press **AUTO** button.

## Rear heating system



The rear passenger compartment heating fan assists air flow to the rear passenger compartment via the rear air vents.



The rate of air flow is determined by the fan. Air temperature is controlled using the temperature control on the instrument panel.



To operate the heating fan, press <sup>A/C OFF</sup> to activate the heating fan. The heating fan is activated if both the LED of the button and the LED of the fan control at the roof are not illuminated.

Set the heating fan  $\curvearrowright$  to regulate the amount of heated air to be flown into the rear passenger compartment.

## Rear air conditioning system

The rear air conditioning system is actuated in conjunction with the front passenger compartment air conditioning system.

## Rear air conditioning fan switch



The rear air conditioning fan assists air flow to the rear passenger compartment via the rear air vents. The rate of air flow is determined by the fan.

To allow cooled and dehumidified (dried) air to be distributed:

Press **A/C OFF** to switch on the air conditioning system. The system is operating if the LED of the button is not illuminated.



Press <sup>A/C OFF</sup> to activate the rear air conditioning fan. The fan is activated if both the LED of the button and the LED of the fan control at the roof are not illuminated.



Set the fan  to regulate the amount of cooled air to be blown into the rear passenger compartment.

## Auxiliary heater

### Coolant heater

The engine-independent, fuel-powered coolant heater provides rapid heating of the engine coolant to enable heating of the vehicle interior without the engine running.

#### Warning

Do not operate the system when refuelling, when dust or combustible vapours are present or in enclosed spaces (e.g. garage).

Before starting or programming the system to start, turn the vehicle's climate control system to heat, set the air distribution to  and turn the fan on.

Switch off when not required. Heating stops automatically after the programmed runtime. It will also cease to operate if the vehicle fuel level drops too low.

During operation, power from the vehicle battery is used. The driving time should therefore be at least as long as the heating time. For short journey times, check the vehicle battery regularly and recharge if necessary.



To ensure efficient performance, briefly operate the auxiliary heater once a month.

### Control units

The timer or remote control unit turns the system on and off, and is used to programme specific departure times.

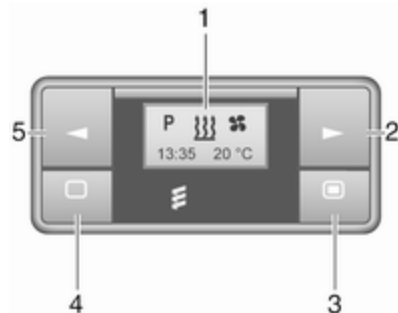
### Timer (Type A)



- 1 Display** : Displays preset, current time or preset time, temperature,  and 
- 2 ►** : Adjusts values up
- 3 ■** : Long press: switch heater on, short press: turns display on or confirms selection
- 4 □** : Long press: switch heater off, short press: turns display on or exit menu
- 5 ◀** : Adjusts values down

### Remote control (Type A)



- 1 Display** : Displays preset, current time or preset time, temperature,  $\nabla$ ,  $\text{||||}$ ,  $\text{|||}$  and  $\text{⊕}$
- 2 ■** : Long press: switch heater on, short press: turns display on or confirms selection
- 3 ►** : Adjusts values up
- 4 □** : Long press: switch heater off, short press: turns display on or exit menu
- 5 ◀** : Adjusts values down

If no buttons are pressed within ten seconds the display automatically turns off.

### Remote control (Type A) fault displays

- INIT** : automatic detection – wait until automatic detection is finished
- NO SIGNAL** : no signal – check heater fuse
- $\nabla$  : poor signal – move closer
- $\text{||||}$  : battery low – replace battery
- $\text{|||}$  : heater fault – consult workshop
- Add, AddE** : system in learning mode

### Teach remote control (Type A)

If the vehicle battery is reconnected, the LED in the instrument panel button illuminates and the system configures the remote control menu automatically. If the LED flashes, select **Add** or **AddE** and confirm.

Additional remote control units may also be configured. Press the button until LED flashes, switch on the remote control, select **Add** and confirm.

**AddE** teaches the current remote control unit exclusively and blocks all previously configured units. **Add** teaches up to four remote control units, but only one unit can operate the system at any one time.



### Remote control (Type B)



- 1 Display** : Displays preset, current time or preset time, temperature,  $\nabla$ ,  $\text{||||}$ ,  $\text{|||}$  and  $\text{⊕}$

2 ► : Adjusts values up

3 : Switch heater off, or press  
**OFF**  and **OFF** simultaneously  
to confirm selection

4  : Switch heater on, or press   
and **OFF** simultaneously to  
confirm selection

5 ◀ : Adjusts values down



If no buttons are pressed within  
30 seconds the display automatically  
turns off.

### Warning

When refuelling, switch off the  
remote control unit as well as the  
heater!

The remote control has a maximum  
range of 1000 m. The range may be  
reduced due to environmental  
conditions and as the battery  
becomes weaker.

### Remote control (Type B) fault displays

-  : poor signal – adjust position
- FAIL** : error during signal  
transmission –  
move closer or check heater  
fuse
-  : battery low – replace battery

### Teach remote control (Type B)

Up to four additional remote control  
units may also be configured. During  
additional teaching processes, the  
oldest transmitter will be deleted each  
time.

Remove the heater fuse for  
5 seconds, then refit the fuse. Within  
2–6 seconds press **OFF** for  
1 second. Teaching is completed.

If the remote has not been used for a  
long period, press the **OFF** button six  
times at intervals of 2 seconds, then  
press and hold for another  
2 seconds, then wait 2 minutes.

### Manual control

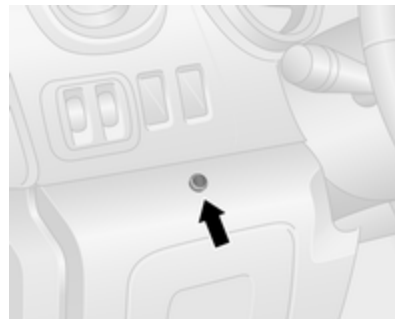

Depending on version, the auxiliary  
heater can also be switched on for the  
last duration time or the default  
duration 30 minutes, or cut-off  
immediately, using the button on the  
lower part of the instrument panel,  
beside the steering wheel.

The LED in the button confirms  
operation.

### Battery replacement

Replace the battery when the range  
of the remote control is reduced or  
when the battery charge symbol  
flashes.

Open the cover and replace the battery (Type A: CR 2430, Type B: 2CR 11108, or equivalent), ensuring the new battery is correctly installed with the positive (+) side facing the positive terminals. Replace the cover securely.

Dispose of old batteries in accordance with environmental regulations.



Batteries do not belong in household waste. They must be disposed of at an appropriate recycling collection point.

## Operation (Type A)

### Heating

Select in the menu bar and press to confirm. The predetermined heating duration, e.g. **L 30**, flashes in the display. The factory setting is 30 minutes.

Adjust the heating duration using or and confirm. The value can be set from ten to 120 minutes. Due to the power consumption, note the heating duration.

To switch off, select in the menu bar again and press .

### Programming P

Up to three preset departure times can be programmed, either during one day or over one week.

- Select **P** in the menu bar and press to confirm.
- Select desired preset memory number **P1**, **P2** or **P3** and confirm.
- Select and confirm.
- Select weekday or weekday group and confirm.
- Select hour and confirm.
- Select minutes and confirm.
- Select and confirm.
- Select ECO or HIGH and confirm.
- Select duration and confirm.
- Press to exit.

Repeat the procedure to programme the other preset memory numbers if required.

To activate a desired preset memory number select **P1**, **P2** or **P3**, then select On and confirm.

When a program is activated **P** and will be displayed together.

To deactivate a preset memory, select **P1**, **P2** or **P3**, then select Off and confirm.











Heating stops automatically 5 minutes after the programmed departure time.

### Notice

The remote control system features a temperature sensor which calculates the runtime according to the ambient temperature and the desired heating level (ECO or HIGH). The system starts automatically between five and 60 minutes prior to the programmed departure time.



### Set time and weekday

If the vehicle battery is disconnected or its voltage is too low, the unit will need to be reset.

- Select  in the menu bar and confirm.
- Select  in the menu bar and confirm.
- Adjust using  or  to change the hour and confirm.
- Adjust using  or  to change the minutes and confirm.
- Press  to exit.
- Select  in the menu bar and confirm.
- Select **Mo** in the menu bar and confirm.
- Adjust using  or  to change the weekday and confirm.
- Press  to exit.

### Heating level







The preferred heating level for programmed departure times can be set to either ECO or HIGH.

- Select  in the menu bar and confirm.
- Select ECO or HIGH and confirm.
- Press  to exit.

### Operation (Type B)







#### Heating

Select the operating mode , if necessary.

- Press  three times.
- Press  and **OFF** simultaneously,  flashes.
- Adjust using  or  to select .
- Press  and **OFF** simultaneously to confirm.

To switch on, press  for one second. The predetermined heating duration, e.g. **30**, is displayed. The factory setting is 30 minutes.







The heating duration can be set in increments of ten minutes. Due to the power consumption, note the heating duration.

- Press  four times.
- Press  and **OFF** simultaneously,  flashes.
- Adjust using  or  to select the desired heating duration.
- Press  and **OFF** simultaneously to confirm.

To switch off, press **OFF**.

#### Programming

The system calculates the operating time of the heater depending on the temperature inside the vehicle.

- Press  twice.
- Press  and **OFF** simultaneously,  flashes.
- Adjust using  or  to select the departure time.
- Press  and **OFF** simultaneously to confirm.

To switch on, press  for one second, **HTM** is displayed.



Heating stops automatically after the programmed departure time, or can be manually switched off.

- Press  twice.
- Press **OFF** for one second, **HTM** goes out.

#### Set time



If the vehicle battery is disconnected or its voltage is too low, the time will need to be reset.



- Press ► once.
- Press  and **OFF** simultaneously,  flashes.
- Adjust using ◀ or ▶ to set the time.
- Press  and **OFF** simultaneously to confirm.

### Heating level

The preferred heating level for programmed departure times can be set to between C1 and C5.

- Press ◀ three times.
- Press  and **OFF** simultaneously,  flashes.
- Adjust using ◀ or ▶ to set the heating level.
- Press  and **OFF** simultaneously to confirm.

To display the passenger compartment temperature, press ► twice.

## Air vents

### Adjustable air vents

At least one air vent must be open while cooling is on, in order to prevent the evaporator from icing up due to lack of air movement.

#### Warning

Do not attach any objects to the slats of the air vents. Risk of damage and injury in case of an accident.

### Centre air vents



To open or close the centre air vents and direct the flow of air, tilt the slats up or down and turn the adjuster wheel left or right.

### Side air vents

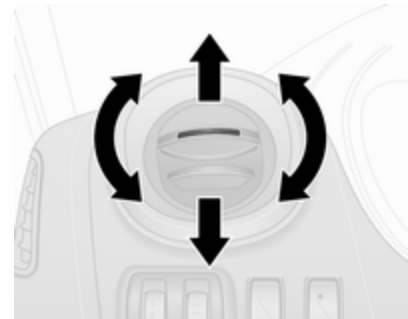

To open or close the side air vents, tilt the slats up or down.

Direct the flow of air by rotating the vents.

Depending upon the position of the temperature control, air will be directed into the vehicle via the side air vents.

### Rear air vents

Depending on vehicle, additional adjustable air vents are located in the rear passenger compartment.

### Fixed air vents

Additional air vents are located beneath the windscreen and door windows, in the foot wells and, depending on vehicle, in the rear passenger compartment.

### Glovebox cooler

The air conditioning system can also keep the contents of the glovebox cool.

## Maintenance

### Air intake

The air intake in front of the windscreen in the engine compartment must be kept clear to allow air intake. Remove any leaves, dirt or snow.

### Air conditioning regular operation

In order to ensure continuously efficient performance, cooling must be operated for a few minutes once a month, irrespective of the weather and time of year. Operation with cooling is not possible when outside temperature is too low.

### Service

For optimal cooling performance, it is recommended to annually check the climate control system, starting 3 years after initial vehicle registration, including:

- functionality and pressure test
- heating functionality

- leakage check
- check of drive belts
- cleaning of condenser and evaporator drainage
- performance check

### Notice

Refrigerant R-134a contains fluorinated greenhouse gases with a global warming potential of 1430.

Front air conditioning system is filled with 0.58 kg and has a CO<sub>2</sub> equivalent of 0.83 tonnes, the front and rear air conditioning system is filled with 0.88 kg and has a CO<sub>2</sub> equivalent of 1.26 tonnes.

Depending on vehicle, information regarding air conditioning refrigerant appears on a label located in the engine compartment.

## Driving and operating

<b>Driving hints</b> .....	<b>129</b>
Driving economically .....	129
Control of the vehicle .....	130
Steering .....	130
<b>Starting and operating</b> .....	<b>131</b>
New vehicle running-in .....	131
Ignition switch positions .....	131
Power button .....	131
Starting the engine .....	133
Idle speed control .....	134
Vehicle shutdown .....	134
Overrun cut-off .....	135
Stop-start system .....	135
Parking .....	138
<b>Engine exhaust</b> .....	<b>139</b>
Diesel particle filter .....	139
Catalytic converter .....	139
AdBlue .....	140
<b>Manual transmission</b> .....	<b>145</b>
<b>Brakes</b> .....	<b>146</b>
Antilock brake system .....	146
Parking brake .....	147

Brake assist .....	147
Hill start assist .....	147
<b>Ride control systems</b> .....	<b>148</b>
Traction Control system .....	148
Electronic Stability Control .....	149
<b>Driver assistance systems</b> .....	<b>151</b>
Cruise control .....	151
Speed limiter .....	153
Parking assist .....	154
Rear view camera .....	157
<b>Fuel</b> .....	<b>159</b>
Fuel for diesel engines .....	159
Refuelling .....	160
<b>Trailer hitch</b> .....	<b>162</b>
General information .....	162
Driving characteristics and towing tips .....	162
Trailer towing .....	162
Trailer stability assist .....	163

## Driving hints

### Driving economically

#### ECO mode

ECO mode is a function that optimises fuel consumption. It affects engine power and torque, acceleration, gear shift indication, heating, air conditioning and electrical consumers.

#### Activation



Press **ECO**. Control indicator **ECO** illuminates in the instrument cluster when activated.

### Notice

The use of ECO mode may affect the performance of the climate control system ⇨ 116.



During driving, it is possible to temporarily disable ECO mode, e.g. to increase engine performance, by depressing the accelerator pedal firmly.

ECO mode is reactivated when pressure is reduced on the accelerator pedal.

### Deactivation

Press **ECO** again. Control indicator **ECO** extinguishes in the instrument cluster.

## Control of the vehicle

### Never coast with engine not running (except during Autostop)

Many systems will not function in this situation (e.g. brake servo unit, power steering). Driving in this manner is a danger to yourself and others. All systems function during an Autostop, but there may be a controlled reduction in power steering assist and vehicle speed is reduced.

Stop-start system ⇨ 135.

### Pedals

To ensure the pedal travel is uninhibited, there must be no mats in the area of the pedals.

Use only floor mats which fit properly and are fixed by the retainers on the driver's side.

### Driving downhill

Engage a gear when driving downhill to ensure that sufficient brake pressure is available.

## Steering

If power steering assist is lost because the engine stops or due to a system malfunction, the vehicle can be steered but may require increased effort.

### Caution

Vehicles equipped with hydraulic power steering:

If the steering wheel is turned until it reaches the end of its travel, and is held in that position for more than 15 seconds, damage may occur to the power steering system and there may be loss of power steering assist.

## Starting and operating

### New vehicle running-in

Do not brake unnecessarily hard for the first few journeys and after new disc brake pads have been fitted.

During the first drive, smoke may occur because of wax and oil evaporating off the exhaust system. Park the vehicle in the open for a while after the first drive and avoid inhaling the fumes.

During the running-in period, fuel and engine oil consumption may be higher and the cleaning process of the diesel particle filter may take place more often. Autostop may be inhibited to allow for charging the vehicle battery.

Stop-start system ↗ 135.

Diesel particle filter ↗ 139.

### Ignition switch positions

Turn key:

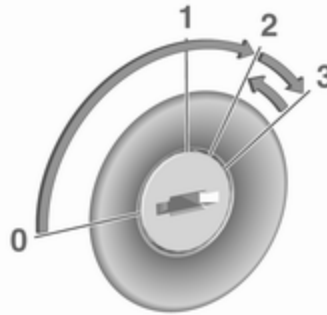

- 0 : ignition off: Some functions remain active until key is removed or driver's door is opened, provided the ignition was on previously
- 1 : accessory power mode: Steering wheel lock released, some electrical functions are operable, ignition is off
- 2 : ignition is on, diesel engine is preheating. Control indicators illuminate and most electrical functions are operable
- 3 : engine start: Release key after starting procedure begins

### Steering wheel lock

Remove key from ignition switch and turn steering wheel until it engages.

**⚠ Danger**

Never remove the key from ignition switch during driving as this will cause steering wheel lock.

### Power button



Electronic key must be inside the vehicle, either in the card reader or the front passenger compartment.

If the electronic key is not inside the vehicle, a corresponding message appears in the Driver Information Centre ↷ 101.

#### Notice

Do not put the electronic key in the load compartment during driving, as this is outside of the detection zone (indicated by a warning chime at low speed ↷ 103 and a message in the Driver Information Centre ↷ 102).

#### Notice

In the event the electronic key is kept in the front passenger compartment and a message appears in the Driver Information Centre (possibly accompanied by a warning chime) indicating that it is out of reception range, we recommend inserting the electronic key in the card reader.

Some functions, e.g. Infotainment system, are available for use as soon as you enter the vehicle.

### Accessory power mode

Press **START/STOP** without operating clutch or brake pedal to enable further electrical functions to be operated.

These functions switch off automatically after a delay.

### Engine start

Operate clutch and brake pedal and press **START/STOP**. Release button after starting procedure begins.

If a gear is engaged, the engine can be started only by operating the clutch pedal and pressing the **START/STOP** button.

In some cases, it may be necessary to move the steering wheel slightly while pressing **START/STOP** to release the steering wheel lock. A corresponding message appears in the Driver Information Centre ↷ 101.

At very low outside temperatures (e.g. below -10 °C) keep the clutch pedal depressed while pressing **START/STOP** until the engine starts.

If one of the starting conditions is not applied, a corresponding message appears in the Driver Information Centre ↷ 101.

Vehicle messages ↷ 102.

### Engine stop

Electronic key must be inside the vehicle, either in the card reader or the front passenger compartment.

With the vehicle stationary, press **START/STOP** to stop the engine. The steering wheel lock is engaged when the driver's door is opened and the vehicle is locked.

If the electronic key is not detected, a corresponding message appears in the Driver Information Centre ↷ 101. In this event, press **START/STOP** for 2 seconds to stop the engine.

Central locking system ↷ 24.

### Retained power off

Press **START/STOP** for more than 2 seconds. The engine is stopped while some functions, e.g. Infotainment system, are available for use for approx. 10 minutes.

These functions stop working when the driver's door is opened and the vehicle is locked.

### Notice

Always take the electronic key with you when exiting the vehicle.

The electronic key being left in the card reader is indicated by a warning chime ⇨ 103 and a message in the Driver Information Centre ⇨ 102 when the driver's door is opened.

### ⚠ Danger

Never leave an electronic key inside the vehicle when children or animals are left in the vehicle, to avoid unintended operation of windows, doors or engine. Risk of fatal injury.

### Fault

If the engine cannot be started, the cause may be one of the following:

- Fault in electronic key.
- Electronic key out of reception range.
- Battery voltage too low.

- Overload of the central locking system by operating at frequent intervals, the power supply is interrupted for a short time.
- Interference from higher-power radio waves from other sources.

Battery replacement ⇨ 20.

Central locking system ⇨ 24.

Electronic key system ⇨ 21.

### Starting the engine

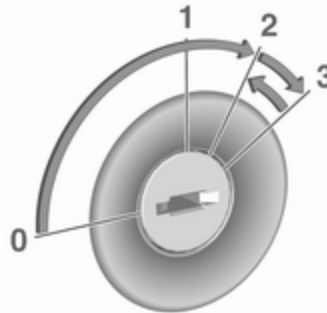

Manual transmission: operate clutch.

Do not accelerate.

Diesel engines: turn the key to position **2** for preheating until control indicator  extinguishes in the instrument cluster ⇨ 99.

Turn key to position **3** and release.

The increased engine speed automatically returns to normal idling speed as the engine temperature rises.

Start attempts should not last longer than 15 seconds. If engine does not start, wait 15 seconds before repeating starting procedure. If necessary, depress accelerator before repeating starting procedure.

Before restarting or to switch off the engine, turn key back to **0**.

During an Autostop, the engine can be started by depressing the clutch pedal.

Stop-start system ⇨ 135.

### Turbo engine warm-up



Upon start-up, engine available torque may be limited for a short time, especially when the engine temperature is cold. The limitation is to allow the lubrication system to fully protect the engine.

### Idle speed control



To increase the idle speed, press the switch. After a few seconds the function will be activated.

The function will be deactivated when:

- The clutch pedal is depressed.
- The accelerator pedal is depressed.
- Vehicle speed is above 0 mph.
- Control indicator ,  or STOP illuminate in the instrument cluster.

To increase or decrease the fast idle speed rate, consult a workshop.

#### Notice

When the fast idle function is activated, the stop-start system is automatically deactivated.

Stop-start system ⇨ 135.

### Vehicle shutdown

#### Fuel cut-off system

If the vehicle runs out of fuel, the fuel system is cut-off and must be reset after refuelling. A corresponding warning message may also appear in the Driver Information Centre ⇨ 101.

### Danger

If you can smell fuel in the vehicle, or a fuel leak is present, have the cause of this remedied immediately by a workshop. Do not reset the fuel cut-off system, to avoid the risk of fire.

### Resetting with remote control key / manual key

To reset the fuel cut-off system and enable the vehicle to be driven:

1. Turn the ignition key to position **2** ⇨ 131.
2. Wait a few minutes to allow the fuel system to be reset.
3. Turn key to position **3** to start the engine.

If the engine does not start, repeat the procedure.



## Resetting with electronic key system

To reset the fuel cut-off system and enable the vehicle to be driven:

1. Insert the electronic key in the card reader ↪ 131.
2. Press **START/STOP** without depressing any pedals.
3. Wait a few minutes to allow the fuel system to be reset.

If the engine does not start, repeat the procedure.

Electronic key system ↪ 21.

Power button ↪ 131.

Refuelling ↪ 160.

## Overrun cut-off

The fuel supply is automatically cut off during overrun, i.e. when the vehicle is driven with a gear engaged but accelerator pedal is released.

Depending on driving conditions, the overrun cut-off may be deactivated.

## Stop-start system

The stop-start system helps to save fuel and to reduce the exhaust emissions. When conditions allow, it switches off the engine as soon as the vehicle is at a low speed or at a standstill, e.g. at a traffic light or in a traffic jam. It restarts the engine automatically as soon as the clutch pedal is depressed.

A vehicle battery sensor ensures that an Autostop is only performed if the vehicle battery is sufficiently charged for a restart.

Switch off engine and ignition before exiting the vehicle.

## Activation

The stop-start system is available as soon as the engine is started, the vehicle starts-off and the conditions as stated below in this section are fulfilled.

If the below conditions are not fulfilled, an Autostop is prohibited and control indicator  illuminates in the instrument cluster ↪ 100.

## Deactivation



Deactivate the stop-start system manually by pressing . LED in the button illuminates to indicate deactivation and a corresponding message appears in the Driver Information Centre ↪ 101.

If deactivated manually, it is possible to reactivate the stop-start system by pressing  again. The LED extinguishes in the button and a corresponding message appears in the Driver Information Centre. The system is reactivated automatically the next time the ignition is switched on.

Vehicle messages ⇨ 102.

**Notice**

When the fast idle function is activated, the stop-start system is automatically deactivated and cannot be reactivated by pressing . LED in button illuminates to indicate deactivation and a corresponding message may appear in the Driver Information Centre ⇨ 101.

Idle speed control ⇨ 134.

Depending on version, if the driver's door is opened or the driver's seat belt is unfastened, the stop-start system is deactivated automatically, and the engine is switched off. Restart engine by pressing **START/STOP**.

Power button ⇨ 131.

**Autostop**

If the vehicle is at a low speed or at a standstill, activate an Autostop as follows:

- depress the clutch pedal
- move the selector lever to neutral
- release the clutch pedal

The engine will be switched off while the ignition stays on if the required conditions are met.



An Autostop is indicated when  illuminates in the instrument cluster ⇨ 100.

During an Autostop, heating and brake performance will be maintained. Brake assist, however, is not available ⇨ 147.

<b>Caution</b>
The power steering assist may be reduced during an Autostop.

If you exit the vehicle while the engine is in an Autostop, a warning chime will sound and a message **"IGNITION OFF"** is displayed in the Driver Information Centre as a reminder that the engine is on standby and has not been switched off.

**Conditions for an Autostop**

The stop-start system checks if each of the following conditions is fulfilled, otherwise an Autostop will be inhibited and control indicator  will illuminate in the instrument cluster:

- the stop-start system is not manually deactivated
- the bonnet is fully closed
- the driver's door is closed or the driver's seat belt is fastened
- the vehicle battery is sufficiently charged and in good condition
- the engine is warmed up
- the engine coolant temperature is not too high
- the outside temperature is not too low or too high (e.g. below 0 °C or above 35 °C)

- the defrosting function is not activated
- the climate control system does not inhibit an Autostop
- the brake vacuum is sufficient
- the self-cleaning function of the diesel particle filter is not active ⇨ 139
- the Antilock brake system (ABS) ⇨ 146, Traction Control system (TC) ⇨ 148 and Electronic Stability Control (ESC) ⇨ 149 ride control systems are not actively engaged
- the vehicle has moved since the last Autostop

Otherwise an Autostop will be inhibited.

Certain settings of the climate control system may also inhibit an Autostop. See "**Climate control**" chapter for further information ⇨ 118.

Immediately after motorway driving an Autostop may be inhibited.

New vehicle running-in ⇨ 131.

### Vehicle battery discharge protection

To ensure reliable engine restarts, several battery discharge protection features are implemented as part of the stop-start system.

### Restart of the engine by the driver

Depress the clutch pedal to restart the engine.

#### Notice

If any gear is selected, the clutch pedal must be fully depressed to restart the engine.

The engine restart may be interrupted if the clutch pedal is released too quickly while a gear is engaged.

If the engine does not restart first time, depress clutch pedal fully again.

Alternatively, press button  to restart the engine while in an Autostop.

Control indicator  ⇨ 100 extinguishes in the instrument cluster when the engine is restarted.

### Restart of the engine by the stop-start system

The selector lever must be in neutral to enable an automatic restart.

If one of the following conditions occurs during an Autostop, the engine will be restarted automatically by the stop-start system:

- the vehicle battery is discharged
- the outside temperature is too low or too high (e.g. below 0 °C or above 35 °C)
- the defrosting function is activated ⇨ 118
- the brake vacuum is not sufficient
- the brake pedal is operated repeatedly
- the vehicle starts to move

An automatic engine restart may not be possible if a door or the bonnet is open.

If an electrical accessory, e.g. a portable CD player, is connected to the power outlet, a brief power drop during engine restart may be noticeable.

If the Infotainment system is active, audio sound may briefly be reduced or interrupted during the restart.

## Fault

If a fault occurs in the stop-start system, the LED in  illuminates, and a corresponding message appears in the Driver Information Centre ↪ 101. Seek the assistance of a workshop.

Vehicle messages ↪ 102.

Warning chimes ↪ 103.

## Parking

### Warning

- Do not park the vehicle on an easily ignitable surface. The high temperature of the exhaust system could ignite the surface.
- Always apply parking brake without pressing release button. Apply as firmly as possible on a downhill slope or

uphill slope. Depress brake pedal at the same time to reduce operating force.

- Switch off the engine.
- If the vehicle is on a level surface or uphill slope, engage first gear. On an uphill slope, turn the front wheels away from the kerb.

If the vehicle is on a downhill slope, engage reverse gear. Turn the front wheels towards the kerb.

- Close the windows.
- Remove the ignition key from the ignition switch. Turn the steering wheel until the steering wheel lock is felt to engage.
- Lock the vehicle by pressing  on the remote control ↪ 24. Activate the anti-theft alarm system ↪ 36.
- The engine cooling fans may run after the engine has been switched off ↪ 166.

### Caution

After running at high engine speeds or with high engine loads, operate the engine briefly at a low load or run in neutral for approx. 30 seconds before switching off, in order to protect the turbocharger.

Vehicle storage ↪ 165.

## Engine exhaust

### Danger

Engine exhaust gases contain poisonous carbon monoxide, which is colourless and odourless and could be fatal if inhaled.

If exhaust gases enter the interior of the vehicle, open the windows. Have the cause of the fault rectified by a workshop.

Avoid driving with an open load compartment, otherwise exhaust gases could enter the vehicle.



## Diesel particle filter

The diesel particle filter system filters soot particles out of the exhaust gases. The system includes a self-cleaning function that runs automatically during driving without any notification.

The filter is cleaned by periodically burning off the soot particles at high temperature. This process takes place automatically under set driving

conditions. Autostop is not available and fuel consumption may be higher during this period. The emission of smells and smoke during this process is normal.

Under certain driving conditions, e.g. short distances, the system cannot clean itself automatically.

If cleaning of the filter is required and if previous driving conditions did not enable automatic cleaning, it will be indicated by the illumination of control indicators  97 and  97 in the instrument cluster. Seek the assistance of a workshop immediately.

### Caution

If the cleaning process is interrupted, there is a risk of provoking severe engine damage.

Cleaning takes place quickest at high engine speeds and loads.

## Catalytic converter



The catalytic converter reduces the amount of harmful substances in the exhaust gases.

### Caution

Fuel grades other than those listed on page  159 could damage the catalytic converter or electronic components.

Unburnt fuel will overheat and damage the catalytic converter. Therefore avoid excessive use of the starter, running the fuel tank dry and starting the engine by pushing or towing.

In the event of misfiring, uneven engine running, a reduction in engine performance or other unusual problems, have the cause of the fault rectified by a workshop as soon as possible. In an emergency, driving can be continued for a short period, keeping vehicle speed and engine speed low.

If control indicator  flashes, the permitted emission limits may be exceeded. Lift your foot off the accelerator until  stops flashing and is steadily illuminated. Contact a workshop immediately.

Malfunction indicator light  97.

### AdBlue

#### General information

The selective catalytic reduction is a method to substantially reduce the nitrogen oxides in the exhaust emission. This is achieved by injecting a Diesel Exhaust Fluid (DEF) into the exhaust system.

The designation of this fluid is AdBlue®. It is a non-toxic, non-flammable, colourless and odourless fluid which consists of 32% urea and 68% water.

#### Warning

Avoid contact of your eyes or skin with AdBlue.

In case of eye or skin contact, rinse off with water.

#### Caution

Avoid contact of the paintwork with AdBlue.

In case of contact, rinse off with water.

AdBlue freezes at a temperature of approx.  $-11^{\circ}\text{C}$ . As the vehicle is equipped with an AdBlue pre-heater, the emissions reduction at low temperatures is ensured. The AdBlue pre-heater works automatically.

### AdBlue level indicator



The current AdBlue percentage remaining can be shown in the Driver Information Centre  101.

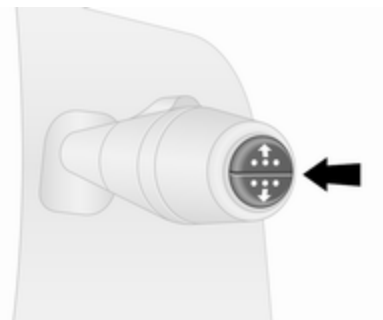

Press button on end of wiper lever repeatedly until the 'AdBlue percentage remaining' menu is displayed.

## Level warnings

The AdBlue consumption is approx. 3.5 l per 600 miles (800 mpg) and depends on the driving behaviour.



If the AdBlue level falls below a certain value, a level warning will be displayed in the Driver Information Centre ↻ 101. Additionally, control indicator  illuminates continuously together with a warning chime.

Refill the AdBlue tank as soon as possible. Refer to "Refilling AdBlue" below.

If AdBlue is not refilled within a certain distance, further level warnings are displayed in the Driver Information Centre depending on the current AdBlue level.

## Engine restarts prevented

Subsequent requests to refill AdBlue and finally the announcement that an engine restart will be prevented are displayed in the Driver Information Centre.

### Notice

These restrictions are a legal requirement.

Before the prevention of an engine restart, a warning message with 0 miles is displayed in the Driver Information Centre, indicating that after switching off the ignition an engine restart will be prohibited.

After the prevention of an engine start, a warning message is displayed in the Driver Information Centre reminding the driver that AdBlue level is insufficient.

To allow the engine to be restarted, the tank should be refilled completely or with a volume of at least 10 l of AdBlue, depending on AdBlue consumption.

## Warning stages: level warnings, engine restarts prevented

1. The warning message **ADBLUE LEVEL LOW** is displayed after the ignition is switched on and the range is less than 1500 miles.

Driving is possible without any restrictions.

Refill the AdBlue tank soon.

2.  illuminates and the warning message **ADBLUE TO FILL** is displayed after the ignition is switched on and the range is less than 930 miles.

Refill the AdBlue tank soon.

3.  illuminates and the warning message **XXXX KM FAILURE TOP UP ADBLUE** is displayed after the ignition is switched on and the range is less than 620 miles.

Refill the tank completely or with a volume of at least 10 l of AdBlue (depending on AdBlue consumption) as soon as possible.

4.  illuminates during driving with warning message **OKM FAILURE TOP UP ADBLUE**.



The engine cannot be restarted after switching off the ignition.

To allow the engine to be restarted, refill the tank completely or with a volume of at least 10 l of AdBlue (depending on AdBlue consumption) as soon as possible.

Illumination of control indicator  may be accompanied by a warning chime.

Warning chimes ⇨ 103.

### High emission warnings

If the exhaust emission rises above a certain value, warnings similar to the range warnings as described above will be displayed in the Driver Information Centre. Control indicator  illuminates continuously together with  and a warning chime.

Requests to have the exhaust system checked and finally the announcement that an engine restart will be prevented are displayed in the Driver Information Centre.

#### Notice

These restrictions are a legal requirement.

At an AdBlue range of approx. 680 miles, a warning message is displayed in the Driver Information Centre showing the remaining distance the vehicle can travel before engine restarts are prevented. This warning message is repeated approx. every 60 miles.

Seek the assistance of a workshop as soon as possible.

#### Warning stages: high emission warnings

1.  and  illuminate with warning message **CHECK ANTI-POLLUTION**.

Fault in the system that may result in a loss of engine power.

Seek the assistance of a workshop as soon as possible.

2.  and  illuminate with warning message **XXXX KM FAILURE TOP UP ADBLUE**.

Indicates that in less than 680 miles an engine restart will be prohibited after switching off the ignition.

This warning message will be repeated every 60 miles.



Vehicle speed may be limited to 12 mph after switching the engine off and on again until the range is reduced to 0 miles.

Seek the assistance of a workshop as soon as possible.

3.  and  illuminate with warning message **OKM FAILURE TOP UP ADBLUE**.

The engine cannot be restarted after switching off the ignition.

Seek the assistance of a workshop.

Illumination of control indicators  and  may be accompanied by a warning chime.

Warning chimes ⇨ 103.



## Refilling AdBlue



### Caution

Only use AdBlue that complies with European standards DIN 70 070 and ISO 22241-1.

Do not use additives.

Do not dilute AdBlue.

Otherwise the selective catalytic reduction system could be damaged.

### Notice

If AdBlue must be refilled at very low temperatures, the refilling of AdBlue may not be detected by the system. In this case, park the vehicle in a space with a higher ambient temperature until AdBlue is liquefied.

### Notice

If engine starting is prohibited due to low AdBlue level, we recommend refilling the tank completely or with a volume of at least 10 l of AdBlue (depending on AdBlue consumption).

Avoid minor top-ups (e.g. less than 10 l), otherwise the system may not detect a refill.

### Notice

When unscrewing the protective cap from the filler neck, ammonia fumes may emerge. Do not inhale as the fumes have a pungent smell. The fumes are not harmful by inhalation.

The vehicle must be parked on a level surface.

The filler neck for AdBlue is located behind the fuel filler flap, located on the left-hand side of the vehicle.

The fuel filler flap can only be opened if the vehicle is unlocked and the left-hand door is opened.

### ⚠ Danger

Vehicles with stop-start system:  
The engine must be switched off and the ignition key removed, to avoid risk of engine being restarted automatically by the system.

Capacities ⇨ 211.

### Filling station

### ⚠ Danger

Follow the operating and safety instructions of the filling station when refilling AdBlue.

1. Switch off engine and remove key from ignition switch.

- Open left-hand door and pull fuel filler flap to open.



- Unscrew protective cap anticlockwise from the filler neck.

### Caution

The AdBlue protective cap is the blue lower cap (arrowed in illustration), and the fuel filler cap is the black upper cap ↻ 160.

In case of incorrect refilling, do not switch on ignition. Seek the assistance of a workshop immediately.

- Fully insert the pump nozzle into the filler neck and switch it on.
- When refilling is complete, mount the protective cap and turn clockwise until it engages.
- Close fuel filler flap and left-hand door.

### AdBlue canister

#### Notice

Only use the designated AdBlue canisters for refilling, to prevent a topping-up of too much AdBlue. Additionally, the fumes in the tank are captured in the canister and do not emerge.

#### Notice

Since AdBlue has a limited durability, check the date of expiry before refilling.

- Switch off engine and remove key from ignition switch.
- Open left-hand door and pull fuel filler flap to open.



- Unscrew protective cap anticlockwise from the filler neck.

### Caution

The AdBlue protective cap is the blue lower cap (arrowed in illustration), and the fuel filler cap is the black upper cap ↻ 160.

In case of incorrect refilling, do not switch on ignition. Seek the assistance of a workshop immediately.

- Open AdBlue canister.

5. Mount one end of the hose on the canister and screw the other end on the filler neck.
6. Lift the canister until it is empty, or until the flow from the canister has stopped. This can take up to 5 minutes.
7. Place the canister on the ground to empty the hose, wait 15 seconds.
8. Unscrew the hose from the filler neck.
9. Mount the protective cap and turn clockwise until it engages.
10. Close fuel filler flap and left-hand door.

**Notice**

Dispose of AdBlue canister according to environmental requirements. Hose can be reused after flushing with clear water before AdBlue dries out.

**Notice**

Allow the vehicle to idle for at least ten seconds to allow the system to detect the AdBlue refill.

Failure to observe this procedure will result in the system only recognising the AdBlue refill after approx. 20 minutes of driving.



If the AdBlue refill is detected successfully, AdBlue level warnings will disappear.

If the AdBlue refill is not detected some time after running the engine, seek the assistance of a workshop.

**Filler cap**

Only use genuine filler caps. AdBlue tank has a special filler cap.

**Fault**

If the system detects an operating fault, control indicator  illuminates together with  and a warning chime. Seek the assistance of a workshop immediately.

A corresponding message appears in the Driver Information Centre  101.

## Manual transmission



To engage reverse, with the vehicle stationary depress the clutch pedal, pull up the collar on the selector lever and engage the gear against the resistance.

If the gear does not engage, set the lever in neutral, release the clutch pedal and depress again. Then repeat gear selection.

Do not slip the clutch unnecessarily.

When operating, depress the clutch pedal completely. Do not use the pedal as a foot rest.

**Caution**

It is inadvisable to drive with hand resting on the selector lever.

Gear shifting ⇨ 98.

Stop-start system ⇨ 135.

**Brakes**

The brake system comprises two independent brake circuits.

If a brake circuit fails, the vehicle can still be braked using the other brake circuit. However, braking effect is achieved only when you depress the brake pedal firmly. You need to use considerably more force for this. The braking distance is extended. Seek the assistance of a workshop before continuing your journey.

When the engine is not running, the support of the brake servo unit disappears once the brake pedal has been depressed once or twice. Braking effect is not reduced, but braking requires significantly greater force. It is especially important to bear this in mind when being towed.

If control indicator  illuminates in the instrument cluster while driving and a corresponding message appears in the Driver Information Centre ⇨ 101, there is a fault in the braking system. Seek the assistance of a workshop immediately.

Control indicator  ⇨ 97.

Vehicle messages ⇨ 102.

**Antilock brake system**

Antilock brake system (ABS) prevents the wheels from locking.

ABS starts to regulate brake pressure as soon as a wheel shows a tendency to lock. The vehicle remains steerable, even during hard braking.

ABS control is made apparent through a pulse in the brake pedal and the noise of the regulation process.

For optimum braking, keep the brake pedal fully depressed throughout the braking process, despite the fact that the pedal is pulsating. Do not reduce the pressure on the pedal.

After starting-off, the system performs a self-test which may be audible.

Control indicator  ⇨ 98.





**Fault**

If control indicator  does not go out a few seconds after the ignition is switched on, or if it illuminates while

driving, there is a fault in the ABS. Control indicator  ↻ 97 may also illuminate in the instrument cluster together with a corresponding message in the Driver Information Centre. The brake system remains operational but without ABS regulation.

### Warning

If there is a fault in the ABS, the wheels may be liable to lock due to braking that is heavier than normal. The advantages of ABS are no longer available. During hard braking, the vehicle can no longer be steered and may swerve.

If control indicators , ,  ↻ 97 and  97 illuminate, there is a fault in the braking system. A corresponding message also appears in the Driver Information Centre ↻ 101. Have the cause of the fault remedied by a workshop. Vehicle messages ↻ 102.

## Parking brake

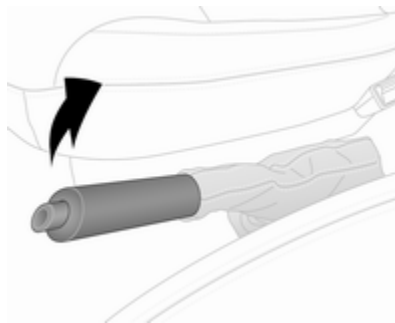

### Warning

Always apply parking brake firmly without operating the release button, and apply as firmly as possible on a downhill or uphill slope.

To release the parking brake, pull the lever up slightly, press the release button and fully lower the lever.

To reduce the operating forces of the parking brake, depress the brake pedal at the same time.

Control indicator  ↻ 97.  
Parking ↻ 138.

## Brake assist

If the brake pedal is depressed quickly and forcefully, maximum brake force is automatically applied (full braking).

Maintain steady pressure on the brake pedal for as long as full braking is required. Maximum brake force is automatically reduced when the brake pedal is released.

Brake assist is not available during an Autostop.

Stop-start system ↻ 135.

## Hill start assist

The system helps prevent unintended movement when driving away on inclines.

When releasing the brake pedal after stopping on an incline (with the selector lever in a forward gear or reverse gear), the brakes remain on

for a further 2 seconds. The brakes release automatically as soon as the vehicle begins to accelerate.

### Caution

The Hill start assist cannot completely prevent vehicle movement in all situations (extremely steep gradients, etc.). If necessary, depress the brake pedal to prevent the vehicle from rolling forwards or backwards.

The Hill start assist is not active during an Autostop.

Stop-start system ⇨ 135.

## Ride control systems

### Traction Control system

The Traction Control system (TC) is a component part of the Electronic Stability Control (ESC) which improves driving stability when necessary, regardless of the type of road surface or tyre grip, by preventing the drive wheels from spinning.

As soon as the drive wheels starts to spin, engine output is reduced and the wheel spinning the most is braked individually. This considerably improves the driving stability of the vehicle on slippery road surfaces.

The Traction Control system is operational as soon as the ignition is switched on and control indicator  extinguishes in the instrument cluster. A corresponding message also appears in the Driver Information Centre ⇨ 101.

When the Traction Control system is active  flashes.

### Warning

Do not let this special safety feature tempt you into taking risks when driving.

Adapt speed to the road conditions.

Control indicator  ⇨ 98.

Trailer stability assist ⇨ 163.

### Enhanced traction function





If necessary, in the event of soft ground, mud or snow-covered road surfaces, the Traction Control system can be deactivated to enhance traction:

Press  on the instrument panel.





Control indicator  illuminates in the instrument cluster and a corresponding message appears in the Driver Information Centre ⇨ 101.

When vehicle speed reaches 30 mph, the system switches automatically from enhanced traction function to Traction Control operation. Control indicator  extinguishes in the instrument cluster.

Traction Control is reactivated by pressing  again. Control indicator  extinguishes.

Traction Control is also reactivated the next time the ignition is switched on.

### Fault

If the system detects a fault, control indicator  ⇨ 98 illuminates together with  ⇨ 97 in the instrument cluster and a corresponding message appears in the Driver Information Centre ⇨ 101.

Traction Control system is not operational. Have the cause of the fault remedied by a workshop.

Vehicle messages ⇨ 102.

### Electronic Stability Control

The Electronic Stability Control (ESC) improves driving stability when necessary, regardless of the type of road surface or tyre grip. It also prevents the drive wheels from spinning.

As soon as the vehicle starts to swerve (understeer / oversteer), engine output is reduced and the wheels are braked individually. This considerably improves the driving stability of the vehicle on slippery road surfaces.

ESC is operational as soon as the ignition is switched on and control indicator  extinguishes in the instrument cluster. A corresponding message also appears in the Driver Information Centre ⇨ 101.

When ESC comes into action  flashes.

### Warning

Do not let this special safety feature tempt you into taking risks when driving.

Adapt speed to the road conditions.

Control indicator  ⇨ 98.

Trailer stability assist ⇨ 163.



## Enhanced traction function





If necessary, in the event of soft ground, mud or snow-covered road surfaces, ESC can be deactivated to enhance traction:

Press  on the instrument panel.



Control indicator  illuminates in the instrument cluster and a corresponding message appears in the Driver Information Centre  101.

When vehicle speed reaches 30 mph, the system switches automatically from enhanced traction function to ESC operation. Control indicator  extinguishes in the instrument cluster.





ESC is reactivated by pressing  again. Control indicator  extinguishes.

ESC is also reactivated the next time the ignition is switched on.

## Engine drag torque control

The engine drag torque control system is an integral feature of ESC. When downshifting under slippery road conditions, the engine speed and torque increase to help prevent locking of the drive wheels during sudden deceleration.

### Fault

If the system detects a fault, control indicator   98 illuminates together with   97 in the instrument cluster and a corresponding message appears in the Driver Information Centre  101.

The ESC is not operational. Have the cause of the fault remedied by a workshop.

Vehicle messages  102.



## Driver assistance systems

### ⚠ Warning

Driver assistance systems are developed to support the driver and not to replace the driver's attention.

The driver accepts full responsibility when driving the vehicle.

When using driver assistance systems, always take care regarding the current traffic situation.

## Cruise control

The cruise control can store and maintain speeds of 20 mph and above. Deviations from the stored speeds may occur when driving uphill or downhill.



For safety reasons, the cruise control cannot be activated until the brake pedal has been operated once.

Do not use the cruise control if it is not advisable to maintain a constant speed.

Control indicators  and  101.

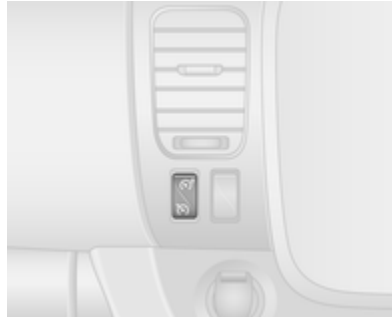
### Switching on the system





Press . Control indicator  illuminates green in the instrument cluster.

Cruise control is now in standby mode and a corresponding message appears in the Driver Information Centre.



Accelerate to the desired speed and press **+** or **-**. The current speed is now stored and maintained and the accelerator pedal can be released.



Control indicator  illuminates green in the instrument cluster together with  and a corresponding message appears in the Driver Information Centre.

Vehicle speed can be increased by depressing the accelerator pedal. The stored speed flashes in the instrument cluster. When the accelerator pedal is released, the previously stored speed is resumed.

Cruise control remains activated while gearshifting.

The speed is saved until the ignition is switched off.

### Increase speed

With cruise control active, the vehicle speed can be increased continuously or in small increments by holding down or tapping  repeatedly.

When the switch is released the current speed is stored and maintained.

Alternatively, accelerate to the desired speed and store by pressing .



### Reduce speed

With cruise control active, the vehicle speed can be decreased continuously or in small increments by holding down or tapping  repeatedly.

When the switch is released the current speed is stored and maintained.

### Deactivation of the functionality



Press . Cruise control is deactivated and the green control indicator  extinguishes in the instrument cluster.

Automatic deactivation:

- vehicle speed drops below 20 mph
- the brake pedal is depressed
- the clutch pedal is depressed
- selector lever in **N**
- engine speed is in a very low or very high range



The speed is stored and a corresponding message appears in the Driver Information Centre.

### Activation of the functionality

Press **R** at a speed above 20 mph. If the stored speed is much higher than the current speed, the vehicle will accelerate powerfully until the stored speed is obtained.

Pressing  will also reactivate the cruise control function, but at the current vehicle speed only, not the stored speed.

### Switching off the system

Press . The green control indicators  and  extinguish in the instrument cluster.

## Speed limiter

The speed limiter prevents the vehicle exceeding a preset maximum speed above 20 mph.

### Switching on the system



Press **S**. Control indicator **S** illuminates yellow in the instrument cluster.

Cruise control speed limiter function is now in standby mode and a corresponding message appears in the Driver Information Centre.

Accelerate to the desired speed and press **+** or **-**. The current speed is recorded.

The vehicle can be driven normally but it will not be possible to exceed the programmed speed limit except in an emergency.

Where the limit speed cannot be maintained, e.g. when driving on a steep decline, the limit speed will flash in the Driver Information Centre **▷ 101**, accompanied by a warning chime.

### Increase limit speed

The limit speed can be increased continuously or in small increments by holding down or tapping **+** repeatedly.

### Decrease limit speed

The limit speed can be decreased continuously or in small increments by holding down or tapping **-** repeatedly.

### Exceeding the limit speed

In the event of an emergency, it is possible to exceed the limit speed by depressing the accelerator pedal firmly beyond the point of resistance. The limit speed will flash in the Driver

Information Centre **▷ 101** during this period, accompanied by a warning chime.

Release the accelerator pedal and the speed limiter function is reactivated once a speed lower than the limit speed is obtained.

### Deactivation of the functionality

Press **O**. The speed limiter is deactivated and the vehicle can be driven normally.

The limit speed is stored and a corresponding message appears in the Driver Information Centre.

### Activation of the functionality

Press **R**. The speed limiter function is reactivated.

Pressing **+** will also reactivate the speed limiter function, but at the current vehicle speed only, not the stored speed.

### Switching off the system

Press **S**. The yellow control indicator **S** extinguishes in the instrument cluster.

## Maximum speed limiter

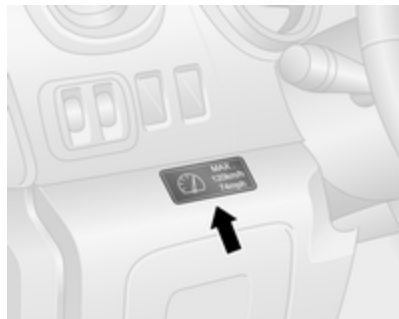

In accordance with local or national regulations, the vehicle may be equipped with a fixed maximum speed limiter that cannot be disabled.

If equipped, a warning label indicating the fixed maximum speed limit (55 to 80 mph) is located on the instrument panel.

Deviations from the maximum speed limit may occur briefly when driving downhill, for physical reasons.

A warning chime will sound for ten seconds every 40 seconds if the vehicle briefly exceeds the set limit.

Vehicles also equipped with cruise control speed limiter: the maximum speed cannot be exceeded by depressing the accelerator pedal firmly beyond the point of resistance.

## Parking assist

### Rear parking assist

#### Warning

It is the driver who bears full responsibility for the parking manoeuvre.

Always check the surrounding area while reversing and using the rear parking assist system.

The parking assist measures the distance between the vehicle and obstacles behind the vehicle. It informs and warns the driver by giving acoustic signals and display indication.

An attached trailer hitch is not considered.



The system consists of four ultrasonic parking sensors in the rear bumper.

#### Notice

Attached parts in the detection area cause system malfunction.

#### Activation

When reverse gear is engaged, the system switches itself on automatically. Readiness for operation is indicated by a brief acoustic signal.

The interval between the acoustic signals becomes shorter as the vehicle gets closer to the obstacle. When the distance is less than 30 cm, the signal is continuous.

**Notice**

In versions with Info Display indication, the volume of the chimes can be adjusted via the Infotainment system. Refer to Infotainment manual for further information.

**Deactivation**

It is possible to permanently or temporarily deactivate the system.

**Notice**

In versions with Info Display indication, the function can be deactivated via the Infotainment system. Refer to Infotainment manual for further information.

**Temporary deactivation**

Temporarily deactivate the system by pressing **P** on the instrument panel with the ignition on. LED illuminates in the button when deactivated.

When reverse gear is selected, no acoustic signal will sound, indicating deactivation.

The function is reactivated by pressing **P** again or the next time the ignition is switched on.

**Permanent deactivation**

Permanently deactivate the system by pressing and holding **P** on the instrument panel for approx. 3 seconds with the ignition on. LED illuminates continuously in the button when permanently deactivated.

The system is deactivated and will not operate. When reverse gear is selected, no acoustic signal will sound, indicating deactivation.

The function is reactivated by pressing and holding **P** for approx. 3 seconds.

**Fault**

If the system detects an operating fault, when selecting reverse gear a continuous acoustic alarm will sound for approx. 5 seconds, a corresponding message appears in the Driver Information Centre  $\diamond$  101 and  $\blacktriangleright$  illuminates in the instrument cluster  $\diamond$  97. Consult a workshop to have the cause of the fault remedied.

**Caution**

When reversing, the area should be free from obstacles which could impact on the underside of the vehicle.

Impact to the rear axle, which may not be visible, could lead to uncharacteristic changes in the vehicle handling. In the event of such an impact, consult a workshop.

Vehicle messages  $\diamond$  102.

## Front parking assist

### ⚠ Warning

The driver bears full responsibility for the parking manoeuvre.

Always check the surrounding area when driving backwards or forwards while using parking assist system.

The front parking assist measures the distance between the vehicle and obstacles in front of the vehicle. It informs and warns the driver by giving acoustic signals.

The system has four ultrasonic parking sensors in the front bumper.

### Activation

The system is activated automatically at a speed up to 10 mph.



An illuminated LED in the parking assist button **P**⚠ indicates that the system is ready to operate.

### Indication

The system warns the driver with acoustic signals against potentially hazardous obstacles in front of the vehicle in a distance range up to 80 cm.

The interval between the signals becomes shorter as the vehicle gets closer to that obstacle. When the distance is less than approx. 30 cm, the signal is continuous.

### Deactivation

The system is deactivated automatically when vehicle speed exceeds 13 mph.

Manual deactivation is also possible by pressing the parking assist button **P**⚠.

When the system is deactivated manually, the LED in the button extinguishes.

After a manual deactivation, the front-rear parking assist is activated again if **P**⚠ is pressed.

### Fault

In the event of a fault or if the system does not work temporarily, a long beep sounds followed by a number of short beeps.

### Basic notes on parking assist system

### ⚠ Warning

Under certain circumstances, various reflective surfaces on objects or clothing as well as

external noise sources may cause the system to fail to detect obstacles.

Special attention must be paid to low obstacles which can damage the lower part of the bumper.

### Caution

Performance of the sensors can be reduced when sensors are covered, e.g. by ice or snow.

Performance of the parking assist system can be reduced due to heavy loading.

Special conditions apply if there are taller vehicles involved (e.g. off-road vehicles, mini vans, vans). Object identification in the upper part of these vehicles cannot be guaranteed.

Objects with a very small reflection cross-section, e.g. objects of narrow size or soft materials, may not be detected by the system.

The parking assist system will not detect objects which are out of the detection range of the sensors.

### Rear view camera

The rear view camera assists the driver when reversing by displaying a view of the area behind the vehicle in either the interior mirror or the Info Display.

### ⚠ Warning

The rear view camera does not replace driver vision. Note that objects that are outside the camera's field of view, e.g. below the bumper or underneath the vehicle, are not displayed.

Do not reverse the vehicle by only looking at the display and check the surrounding area behind and around the vehicle before reversing.



The camera is mounted above the rear doors / tailgate.

The area displayed by the camera is limited. The distance of the image that appears on the display differs from the actual distance.

### Notice

To achieve the optimum visibility, the rear view camera must not be obscured by dirt, snow or ice.

## Activation

### Interior mirror display screen



Rear view camera display is automatically activated when reverse gear is engaged. An audible signal confirms activation.

## Info Display



In vehicles with Navigation system, the rear view camera display may be shown on the Info Display (depending on version).

## Trajectory lane display (1)

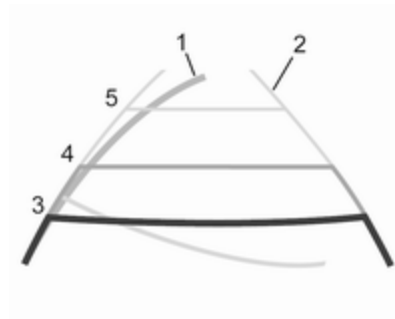

Depending on version, the trajectory lane (1) of the vehicle is shown in blue on the Info Display. It shows the path of the vehicle in accordance with the steering angle.

### Fixed lane display (2)

The fixed lane display (2) shows the path of the vehicle if the wheels are kept straight.

Guide lines (3, 4, 5) are used together with the fixed lane display (2) and indicate the distance behind the vehicle.



The guide line intervals are as follows:

- 3 (red) : 30 cm
- 4 (yellow) : 70 cm
- 5 (green) : 150 cm

### Settings

Settings, e.g. brightness, contrast and colours can be changed via the Infotainment system. The feature may also be switched off permanently. Refer to Infotainment manual for further information.

### Deactivation

The camera is deactivated after a delay if reverse gear is not engaged for approx. 5 seconds.

### Fault

The rear view camera may not operate properly when:

- the surrounding is dark
- the sun or the beam of headlights is shining directly into the camera lens

- ice, snow, mud, or anything else covers the camera lens. Clean the lens, rinse it with water, and wipe it with a soft cloth
- the rear doors / tailgate are not closed correctly
- the vehicle had a rear-end accident
- there are extreme temperature changes

## Fuel

### Fuel for diesel engines

The Diesel engines are compatible with fuels that conform to current and future European standards and can be obtained from filling stations:



Diesel fuel that meets standard EN590 mixed with a biofuel that meets standard EN14214 (possibly containing up to 7 % Fatty Acid Methyl Ester).

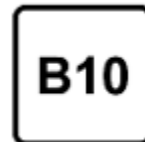

Diesel fuel that meets standard EN16734 mixed with a biofuel that meets standard EN14214 (possibly containing up to 10 % Fatty Acid Methyl Ester).

If travelling in countries outside the European Union, occasional use of Euro-Diesel fuel with a sulphur concentration below 50 ppm is possible.

**Caution**

Frequent usage of diesel fuel containing more than 15 ppm sulphur will cause severe engine damage.

**Caution**

Use of fuel that does not comply to EN 590 or similar can lead to engine powerloss, increased wear or engine damage and may affect your warranty.

Do not use marine diesel oils, heating oils, Aquazole and similar diesel-water emulsions. Diesel fuels must not be diluted with fuels for petrol engines.

The flow and filterability of diesel fuels are temperature-dependent. When temperatures are low, refuel with diesel fuel with guaranteed winter properties.

Diesel fuel filter ⇨ 173.

Diesel fuel system bleeding ⇨ 173.

**Low temperature operation**

At temperatures below 0 °C, some diesel products with biodiesel blends may clog, freeze or gel, which may affect the fuel supply system. Starting and engine operation may not work properly. Make sure to fill winter grade diesel fuel at ambient temperatures below 0 °C.

Arctic grade diesel fuel can be used in extreme cold temperatures below -20 °C. Using this fuel grade in warm or hot climates is not recommended and may cause engine stalling, poor starting or damage to the fuel injection system.

**Refuelling**

**⚠ Danger**

Before refuelling, switch off engine and any external heaters with combustion chambers.

Vehicles with stop-start system: The engine must be switched off and the ignition key removed, to avoid risk of engine being restarted automatically by the system.

Switch off any mobile phones.

Follow the operating and safety instructions of the filling station when refuelling.

**⚠ Danger**

Fuel is flammable and explosive. No smoking. No naked flames or sparks.

If you can smell fuel in your vehicle, have the cause of this remedied immediately by a workshop.

A label with symbols at the fuel filler flap is indicating the allowed fuel types. In Europe the pump nozzles of the filling stations are marked with these symbols. Refuel only the allowed fuel type.

### Caution

In case of misfuelling, do not switch on ignition.

### Notice

To ensure the fuel level is displayed correctly, the ignition must be switched off before refuelling. Avoid minor fuel top-ups (e.g. less than 5 l) to ensure accurate readings.

The fuel filler flap is located on the left-hand side of the vehicle.

The fuel filler flap can only be opened if the vehicle is unlocked and the left-hand door is opened.

### Notice

Do not open the left-hand sliding side door during refuelling.

Pull flap to open.



### Caution

In vehicles with AdBlue, the AdBlue protective cap is the blue lower cap ↻ 140, and the fuel filler cap is the black upper cap (arrowed in illustration).

In case of misfuelling, do not switch on ignition. Seek the assistance of a workshop immediately.

To open, turn the cap slowly anticlockwise.

The fuel filler cap can be retained in the bracket on the fuel filler flap.

Place the nozzle in straight position to the filler neck and press with slight force to insert.

To refuel, switch on pump nozzle.

After automatic cut-off, it can be topped up by operating the pump nozzle a maximum of two more times.

### Caution

Wipe off any overflowing fuel immediately.

When refuelling is complete, replace the fuel filler cap and turn clockwise as far as it will go.

Close the fuel filler flap.

### Fuel filler cap

Only use genuine fuel filler caps. Diesel-engined vehicles have special fuel filler caps.

## Trailer hitch

### General information

Entrust retrofitting of towing equipment to a workshop. It may be necessary to make changes that affect the cooling system, heat shields or other equipment. Only use towing equipment that has been approved for your vehicle.

### Driving characteristics and towing tips

In the case of trailers with brakes, attach the breakaway stopping cable.

Before attaching a trailer, lubricate the coupling ball. However, do not do so if a stabiliser, which acts on the coupling ball, is being used to reduce snaking movements. For trailers with low driving stability the use of a stabiliser is recommended.

A maximum speed of 50 mph must not be exceeded, even in countries where higher speeds are permitted.

If the trailer starts snaking, drive more slowly, do not attempt to correct the steering and brake sharply if necessary.

When driving downhill, drive in the same gear as if driving uphill and drive at a similar speed.

Adjust tyre pressure to the value specified for full load ⇨ 213.

### Trailer towing

#### Trailer loads

The permissible trailer loads are vehicle and engine-dependent maximum values which must not be exceeded. The actual trailer load is the difference between the actual gross weight of the trailer and the actual coupling socket load with the trailer coupled.

The permissible trailer loads are specified in the vehicle documents. In general, they are valid for gradients up to max. 12%.

The permitted trailer load applies up to the specified incline and up to an altitude of 1000 m above sea level.

Since engine power decreases as altitude increases due to the air becoming thinner, therefore reducing climbing ability, the permissible gross train weight also decreases by 10% for every 1000 m of additional altitude. The gross train weight does not have to be reduced when driving on roads with slight inclines (less than 8%, e.g. motorways).

The permissible gross train weight must not be exceeded. This weight is specified on the identification plate ⇨ 207.

#### Vertical coupling load

The vertical coupling load is the load exerted by the trailer on the coupling ball. It can be varied by changing the weight distribution when loading the trailer.

The maximum permissible vertical coupling load is specified on the towing equipment identification plate and in the vehicle documents. Always aim for the maximum load, especially in the case of heavy trailers. The vertical coupling load should never fall below 25 kg.

In the case of trailer loads of 1200 kg or more, the vertical coupling load should not be less than 50 kg.

### **Rear axle load**

When the trailer is coupled and the towing vehicle fully loaded (including all occupants), the permissible rear axle load (see identification plate or vehicle documents) must not be exceeded.

### **Trailer stability assist**

If the system detects snaking movements, engine power is reduced and the vehicle / trailer combination is selectively braked until the snaking ceases. While the system is working, keep steering wheel as still as possible.

Trailer stability assist is a function of the Electronic Stability Control (ESC)  
⇨ 149.

## Vehicle care

<b>General Information</b> .....	<b>165</b>
Accessories and vehicle modifications .....	165
Vehicle storage .....	165
End-of-life vehicle recovery .....	166
<b>Vehicle checks</b> .....	<b>166</b>
Performing work .....	166
Bonnet .....	166
Engine oil .....	167
Engine air filter .....	168
Engine coolant .....	169
Power steering fluid .....	169
Washer fluid .....	170
Brakes .....	170
Brake fluid .....	170
Vehicle battery .....	171
Diesel fuel filter .....	173
Diesel fuel system bleeding .....	173
Wiper blade replacement .....	174
<b>Bulb replacement</b> .....	<b>175</b>
Headlights .....	175
Front fog lights .....	176
Front turn lights .....	176
Tail lights .....	176
Side turn lights .....	177

Centre high-mounted brake light .....	177
Reversing light .....	178
Number plate light .....	179
Fog tail light .....	179
Interior lights .....	180
Instrument panel illumination .....	181
<b>Electrical system</b> .....	<b>181</b>
Fuses .....	181
Instrument panel fuse box .....	182
<b>Vehicle tools</b> .....	<b>185</b>
Tools .....	185
<b>Wheels and tyres</b> .....	<b>186</b>
Tyres .....	186
Winter tyres .....	186
Tyre designations .....	186
Tyre pressure .....	186
Tyre pressure monitoring system .....	188
Tread depth .....	189
Changing tyre and wheel size .....	190
Wheel covers .....	190
Tyre chains .....	190
Tyre repair kit .....	191
Wheel changing .....	194
Spare wheel .....	195
<b>Jump starting</b> .....	<b>197</b>

<b>Towing</b> .....	<b>198</b>
Towing the vehicle .....	198
Towing another vehicle .....	199
<b>Appearance care</b> .....	<b>200</b>
Exterior care .....	200
Interior care .....	202

## General Information

### Accessories and vehicle modifications

We recommend the use of genuine parts and accessories and factory approved parts specific for your vehicle type. We cannot assess or guarantee reliability of other products - even if they have a regulatory or otherwise granted approval.

Any modification, conversion or other changes made to standard vehicle specifications (including, without limitation, software modifications, modifications of the electronic control units) may invalidate the warranty offered by Vauxhall. Furthermore, such changes may affect driver assistance systems, fuel consumption, CO<sub>2</sub> emissions and other emissions of the vehicle. They may also invalidate the vehicle operating permit.

### Caution

When transporting the vehicle on a train or on a recovery vehicle, the mud flaps might be damaged.

## Vehicle storage

### Storage for a long period of time

If the vehicle is to be stored for several months:

- Wash the vehicle. Wax painted parts of the vehicle.  
Exterior care ⇨ 200.
- Have the wax in the engine compartment and underbody checked.
- Clean and preserve rubber seals.
- Fill up fuel tank completely.
- Change the engine oil.
- Drain the washer fluid reservoir.
- Check the coolant antifreeze and corrosion protection.
- Adjust tyre pressure to the value specified for full load.

- Park vehicle in a dry, well ventilated place. Engage first or reverse gear. Prevent the vehicle from rolling.
- Do not apply the parking brake.
- Open the bonnet, close all doors and lock the vehicle.

### Putting back into operation

When the vehicle is to be put back into operation:

- Check tyre pressure.
- Fill up the washer fluid reservoir.
- Check the engine oil level.
- Check the coolant level.
- Since the durability of AdBlue is limited to two years, fluid should be exchanged if it is too old. Seek the assistance of a workshop.
- Fit the number plate, if necessary.

## End-of-life vehicle recovery

Information on end-of-life vehicle recovery centres and the recycling of end-of-life vehicles is available on our website, where legally required. Only entrust this work to an authorised recycling centre.

## Vehicle checks

### Performing work

#### **⚠ Warning**

Only perform engine compartment checks when the ignition is off. The vehicle must not be in an Autostop ⇨ 135.

The cooling fan may start operating even if the ignition is off.

#### **⚠ Danger**

The ignition system generates extremely high voltages. Do not touch.

The caps for topping up the engine oil, the coolant, the brake fluid, the washer fluid and the oil dipstick handle are yellow for ease of identification.

## Bonnet

### Opening



Pull the release lever and return it to its original position.



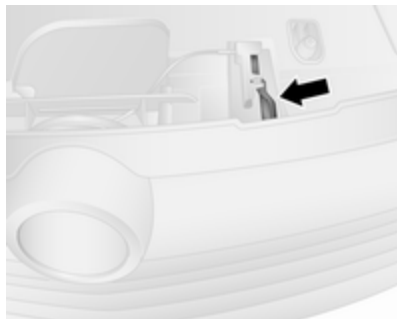

Move the safety catch, located slightly right of centre, to the left and raise the bonnet.

The bonnet is held open automatically by a lifter.

If the bonnet is opened during an Autostop, the engine will be restarted automatically for safety reasons.

Stop-start system ⇨ 135.

**Caution**

Ensure the windscreen wiper is switched off before opening the bonnet ⇨ 84.

**Closing**

Lower the bonnet and allow it to fall into the latch from a low height (approx. 30 cm). Check that the bonnet is engaged.

**Caution**

Do not press the bonnet into the latch, to avoid dents.

**⚠ Warning**

In the event of even a minor head-on collision, have the bonnet safety catch checked by a workshop.

**Engine oil**

Check the engine oil level manually on a regular basis to prevent damage to the engine.

Ensure that the correct specification of engine oil is used.

Recommended fluids and lubricants ⇨ 204.

The maximum engine oil consumption is 0.6 l per 600 miles.

Check with the vehicle on a level surface. The engine must be at operating temperature and switched off for at least 10 minutes.

**Caution**

It is the owner's responsibility to maintain the proper level of an appropriate quality oil in the engine.

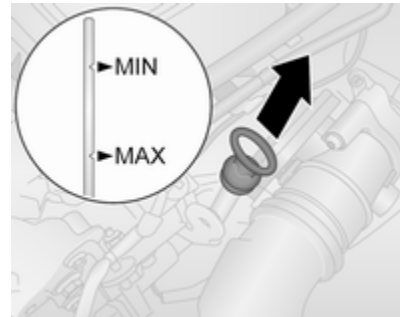

Pull out the dipstick, wipe it clean, reinsert fully, pull out and read the engine oil level.

When the engine oil level has dropped to the **MIN** mark, top-up engine oil.

**Caution**

Do not allow the engine oil level to drop below the minimum level!

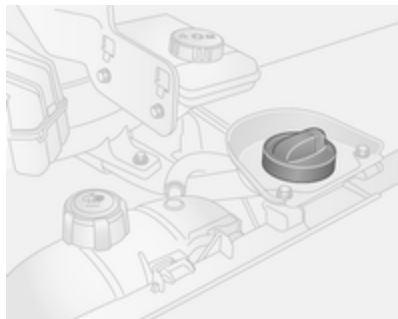

We recommend the use of the same grade of engine oil that was used at the last change.

Between the **MIN** and **MAX** marks a volume of approx. 2.1 l for engines R9M 408, R9M 413 and R9M 415

respectively approx. 3.5 l for engines R9M 450 and R9M 452 can be filled in.

The engine oil level must not exceed the maximum mark **MAX** on the dipstick.

**Caution**

Overfilled engine oil must be drained or suctioned out. If the oil exceeds the maximum level, do not start the vehicle and contact a workshop.

To prevent spillage when replenishing the engine oil, we recommend using a funnel to top-up the engine oil. Ensure funnel is securely located onto the filler pipe.

After topping-up, put the funnel into a plastic bag and stow it securely.

A stabilization of the engine oil consumption will not take place until the vehicle has been driven several thousand miles. Only then can the actual degree of consumption be established.

If consumption exceeds more than 0.6 l every 600 miles after this running-in period, consult a workshop.

Fit the cap on straight and tighten it.

## Engine air filter

### Engine air flow indicator

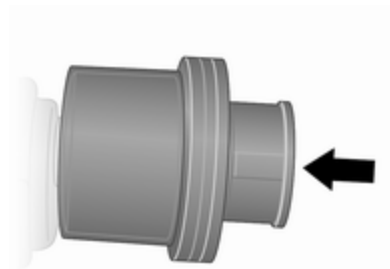

On certain models, an indicator is located in the engine induction system and indicates if the air-intake to the engine is restricted.

Clear : No restriction  
Red tell-tale : Restricted

If the red tell-tale is displayed when the engine is running, consult a workshop.

### Engine coolant

The coolant provides freeze protection down to approx. -28 °C.

<b>Caution</b>
Only use approved antifreeze.

### Coolant level

<b>Caution</b>
Too low a coolant level can cause engine damage.

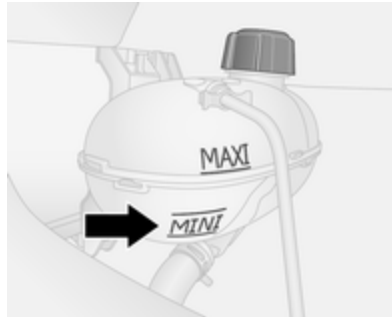

If the cooling system is cold, the coolant level should be just above the MINI mark. Top-up if the level is low.

<b>⚠ Warning</b>
Allow the engine to cool before opening the cap. Carefully open the cap, relieving the pressure slowly.

Top-up with antifreeze. If no antifreeze is available, use clean tap water or distilled water. Install the cap tightly. Have the antifreeze

concentration checked and have the cause of the coolant loss remedied by a workshop.

If a substantial amount of coolant is required, it will be necessary to bleed any trapped air from the cooling system. Seek the assistance of a workshop.

If the coolant temperature is too high, control indicator 98 illuminates red in the instrument cluster, together with 97. Consult a workshop if coolant level is sufficient.

### Power steering fluid

<b>Caution</b>
Extremely small amounts of contamination can cause steering system damage and cause it to not work properly. Do not allow contaminants to contact the fluid side of the reservoir cap or from entering the reservoir.

The power steering fluid reservoir is located below the front left wheel arch, behind a trim panel.

The fluid level normally does not need to be checked. If an unusual noise is heard during steering or if the power steering reacts conspicuously, seek the assistance of a workshop.

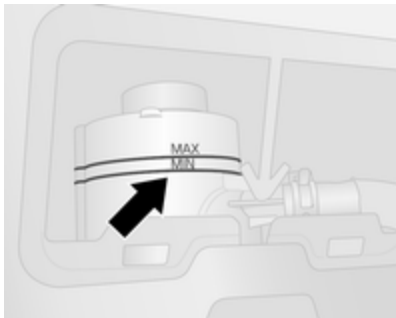

If the fluid level in the reservoir falls below the **MIN** mark consult a workshop.

## Washer fluid

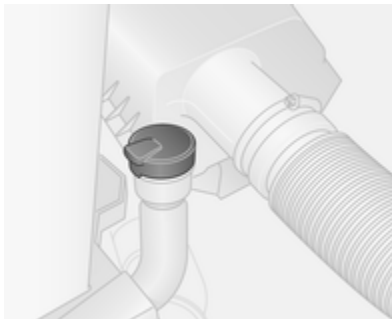

Fill with clean water mixed with a suitable quantity of windscreen washer fluid which contains antifreeze.

### Caution

Only washer fluid with a sufficient antifreeze concentration provides protection at low temperatures or a sudden drop in temperature.

Use of washer fluid containing isopropanol can damage exterior lamps.

Washer fluid ⇨ 204.

## Brakes

Once new brake linings are installed, do not brake unnecessarily hard for the first few journeys.

## Brake fluid

### ⚠ Warning

Brake fluid is poisonous and corrosive. Avoid contact with eyes, skin, fabrics and painted surfaces.



The brake fluid level must be between the **MINI** and **MAXI** marks.

When topping up, ensure maximum cleanliness as contamination of the brake fluid can lead to brake system malfunctions. Have the cause of the loss of brake fluid remedied by a workshop.

Only use high-performance brake fluid approved for your vehicle.

Brake fluid ↗ 204.

## Vehicle battery

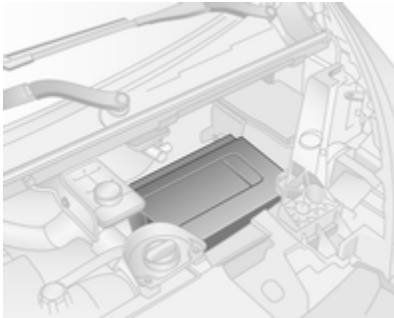

The vehicle battery is located under a cover in the engine compartment.

The vehicle battery is maintenance-free provided that the driving profile allows sufficient charging of the battery. Short-distance driving and frequent engine starts can discharge the battery. Avoid the use of unnecessary electrical consumers.

Control indicator  illuminates if there is a fault with the charging system. Stop, switch off engine and seek the assistance of a workshop.

Charging system ↗ 97.



Batteries do not belong in household waste. They must be disposed of at an appropriate recycling collection point.

Laying up the vehicle for more than four weeks can lead to battery discharge.

### Danger

Ensure the ignition is switched off completely (the vehicle must not be in an Autostop) before connecting or disconnecting the vehicle battery.

Stop-start system ↗ 135.

### Replacing the vehicle battery

Ensure that the battery is always replaced by the same type of battery.

Seek the assistance of a workshop to have the vehicle battery replaced.

Stop-start system ↗ 135.

### Charging the vehicle battery

#### Warning

On vehicles with stop-start system, ensure that the charging potential does not exceed 14.6 V when using a battery charger. Otherwise the vehicle battery may be damaged.

**⚠ Danger**

Ensure adequate ventilation when charging the battery. There is a risk of explosion if gases generated during charging are allowed to accumulate!

Jump starting ⇨ 197.

**Warning label****Meaning of symbols:**

- No sparks, naked flames or smoking.
- Always shield eyes. Explosive gases can cause blindness or injury.
- Keep the vehicle battery out of reach of children.
- The vehicle battery contains sulfuric acid which could cause blindness or serious burn injuries.
- See the Owner's Manual for further information.
- Explosive gas may be present in the vicinity of the battery.

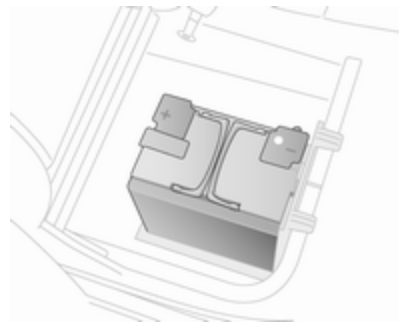
**Additional battery**

Depending on the vehicle's auxiliary equipment, certain models may have an additional battery mounted under the front passenger bench seat.

**Notice**

The additional battery is automatically connected to the main vehicle battery only when the engine is running. It does not need to be manually disconnected before

disconnecting the main vehicle battery or before jump starting the vehicle.

The terminals are designed for additional electrical consumers up to a maximum of 50 A.

Jump starting ⇨ 197.

## Diesel fuel filter

The diesel fuel filter is accessible from the underside of the vehicle.



Drain filter of residual water at every engine oil change.

Place a container underneath the filter housing. Loosen the knurled screw on the lower part of the filter by approx. one turn, to drain off the water.

The filter is drained as soon as water-free diesel fuel emerges. Retighten the screw.

Check diesel fuel filter at shorter intervals if the vehicle is subjected to extreme operating conditions.

## Diesel fuel system bleeding

If the fuel tank has been run dry, it will be necessary to air vent or bleed the diesel fuel system.

Refuel then proceed as follows:

With ignition key

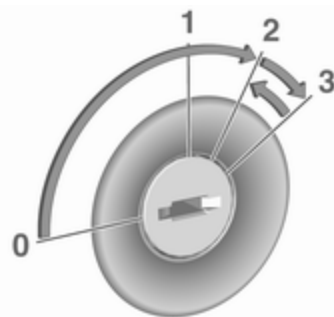

- Switch on the ignition (key to position 2) for 5 seconds at a time.
- Switch off ignition (key to position 1) for 3 seconds.
- Repeat this process multiple times.
- Start the engine (key to position 3) then switch off (key to position 0).

Ignition switch positions ⇨ 131.

### With power button



- Insert the electronic key in the card reader.
- Press **START/STOP** without pressing any of the pedals.
- Wait a few minutes before starting engine.

Power button ⇨ 131.

If the engine fails to start, seek the assistance of a workshop.

Starting the engine ⇨ 133.

### Wiper blade replacement

#### Wiper blades on the windscreen

Before replacing the wiper blades, move the wiper lever to the maintenance position (if equipped).  
Windscreen wiper and washer ⇨ 84.

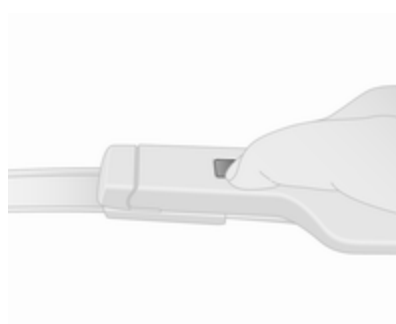

Lift the wiper arm, press button to disengage the wiper blade and remove.

Attach new wiper blade slightly angled to the wiper arm and push until it engages.

Lower wiper arm carefully.

### Wiper blade on the rear window

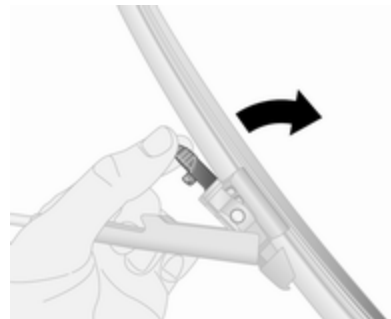

Lift wiper arm, press retaining lugs together to disengage the wiper blade and raise to remove.

Lower wiper arm carefully.

When attaching new wiper blade, ensure it is engaged securely.



## Bulb replacement

Switch off the ignition and turn off the relevant switch or close the doors.

Only hold a new bulb at the base. Do not touch the bulb glass with bare hands.

Use only the same bulb type for replacement.

### Bulb check

After a bulb replacement, switch on the ignition, operate and check the lights.

## Headlights

### Low beam and high beam

Replace headlight bulbs from within the engine compartment.

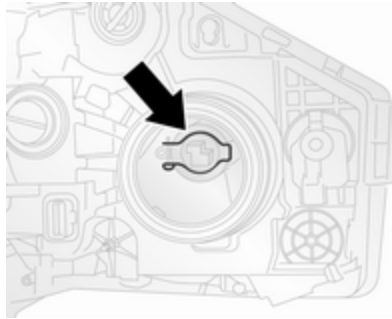

1. Remove protective cover by rotating it anticlockwise.
2. Detach wiring connector.
3. Release retaining clip (see illustration) and remove bulb.
4. Renew bulb and install retaining clip ensuring that bulb is in correct orientation.
5. Reattach wiring connector and protective cover.

## Sidelights / Daytime running lights

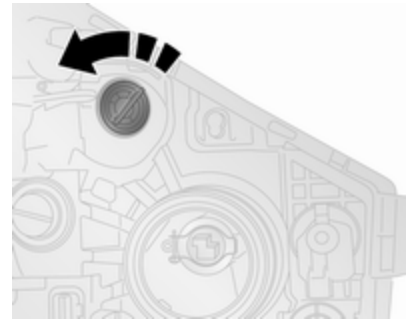

1. Remove protective cover by rotating it anticlockwise.
2. Release retaining clips and remove bulb holder from reflector housing.
3. Renew bulb.
4. Install bulb holder in reflector housing and engage retaining clips.
5. Install protective cover.

## Daytime running light with LEDs

Daytime running lights consist of LEDs which cannot be changed. Consult a workshop in case of a defective LED.

## Front fog lights

Access the front fog light bulb from beneath the vehicle.

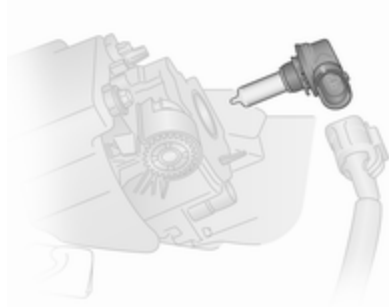

1. On left vehicle side, release retaining clip and open the access cover.

On right vehicle side, remove the two screws and retaining clips to remove the access cover.

2. Detach wiring connector.
3. Rotate bulb holder anticlockwise and remove bulb.
4. Renew bulb and install bulb holder.
5. Reattach wiring connector.
6. On left vehicle side, close the access cover.

On right vehicle side, install the access cover and replace the two screws.

## Front turn lights



1. Remove bulb holder from reflector housing by rotating anticlockwise.
2. Renew bulb.
3. Install bulb holder in reflector housing.

## Tail lights

### Rear brake, turn light and tail lights

Open rear doors / tailgate to access the tail lights.



1. Remove the three bolts (using the tool supplied).

- Carefully pull lamp assembly from retaining pins on the outer side and remove.
- Detach wiring connector from lamp assembly.

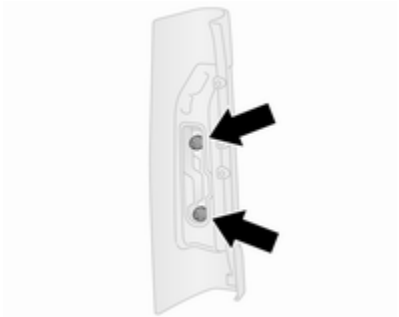

- Rotate bulb holder anticlockwise to separate from lamp.
- Renew bulb.
- Push to install the bulb holder into the lamp, then rotate clockwise to secure.
- Reattach wiring connector to lamp assembly and check that it is located correctly.

- Replace lamp assembly into original position, ensuring that it is seated correctly on retaining pins.
- Replace the three bolts.

### Side turn lights

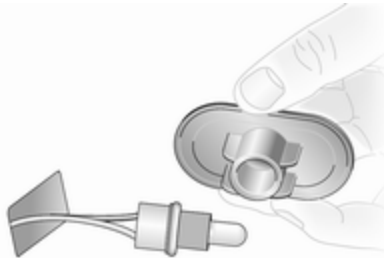

- Release lamp assembly from wing by depressing clips using a suitable tool and lift out lamp assembly from aperture.
- Remove bulb holder from lamp assembly by rotating anticlockwise and renew bulb.
- Install bulb holder in lamp assembly and install lamp assembly into aperture.

### Centre high-mounted brake light

#### Rear doors

- Open the rear doors.



- Remove the two bolts from inside the rear doors.

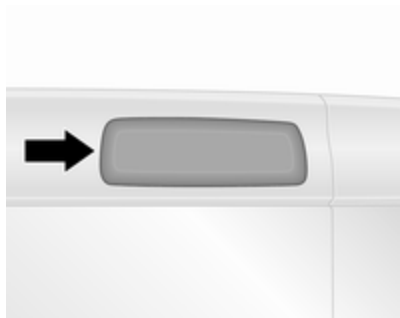

3. From outside the vehicle, remove the bulb holder by releasing the clips with a flat blade screwdriver.
4. Renew bulb.
5. Install bulb holder and replace the two bolts.

### Tailgate

1. Open the tailgate.

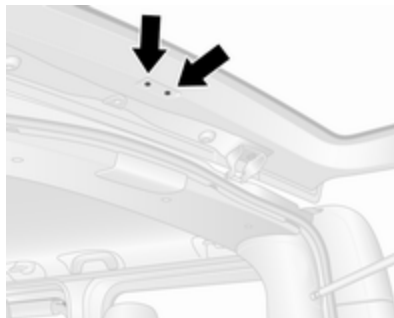

2. Remove the two bolts from the tailgate.



3. From outside the vehicle, remove the bulb holder by releasing the clips with a flat blade screwdriver.

4. Renew bulb.
5. Install bulb holder and replace the two bolts.

### Reversing light



1. Remove the two bolts (using the tool supplied) and remove lamp assembly.
2. Detach wiring connector from lamp assembly.
3. Rotate bulb housing anticlockwise to separate from lamp assembly.
4. Renew lower bulb.

5. Push to install the bulb holder into the lamp assembly, then rotate clockwise to secure.
6. Reattach wiring connector to lamp assembly.
7. Install lamp assembly with the two bolts.

## Number plate light

### H1 roof height

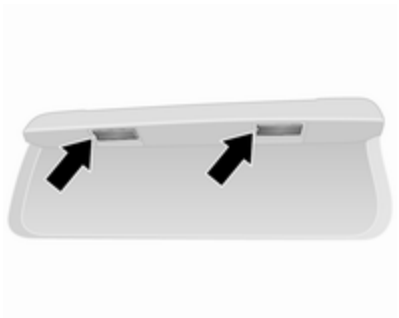

1. Prise out lamp using a flat blade screwdriver.
2. Detach wiring connector.
3. Prise off lens to release the clips.

4. Renew bulb.
5. Install lens and reattach wiring connector.
6. Replace lamp in housing.

### H2 roof height

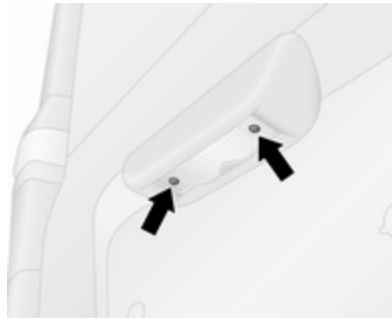

1. Remove the two screws (using the tool supplied) to release lens.
2. Renew bulb.
3. Install lens in housing and replace the two screws.

## Fog tail light



1. Remove the two bolts (using the tool supplied) and remove lamp assembly.
2. Detach wiring connector from lamp assembly.
3. Rotate bulb housing anticlockwise to separate from lamp assembly.
4. Renew upper bulb.
5. Push to install the bulb holder into the lamp assembly, then rotate clockwise to secure.

6. Reattach wiring connector to lamp assembly.
7. Install lamp assembly with the two bolts.

## Interior lights

### Front and rear courtesy lights



1. Release lens assembly from the clips and the locator using a flat blade screwdriver.
2. Renew bulb.
3. Install lens assembly.

### Rear seats lights



Have bulbs replaced by a workshop.

### Load compartment light



1. Release lens assembly from the clips using a flat blade screwdriver.
2. Remove rear cover on lamp assembly.
3. Renew bulb.
4. Install rear cover and lamp assembly.

### Glovebox light

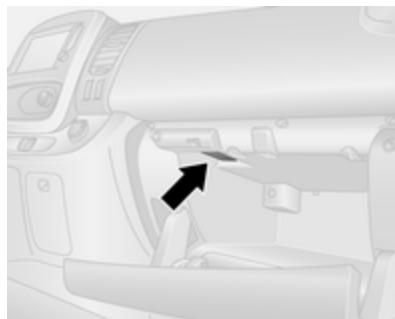

1. Remove lens assembly using a flat blade screwdriver.
2. Renew bulb.
3. Install lens assembly.

## Instrument panel illumination

Have bulbs replaced by a workshop.

## Electrical system

### Fuses

Data on the replacement fuse must match the data on the defective fuse.

There are two fuse boxes in the vehicle:

- on the left-hand side of the instrument panel, behind the trim panel
- in the engine compartment located next to the battery

### Notice

The engine compartment fuse box should only be accessed by a workshop.

Before replacing a fuse, turn off the respective switch and the ignition.

There are different types of fuses in the vehicle.

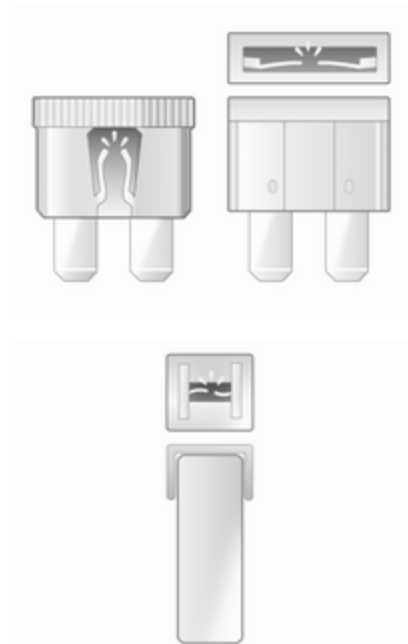

Depending on the type of fuse, a blown fuse can be recognised by its melted wire. Do not replace the fuse until the cause of the fault has been remedied.

It is advisable to carry a full set of fuses. Provision is made in the fuse box for the storing of spare fuses.

Some functions are protected by several fuses.

Fuses may also be inserted without existence of a function.

**Notice**

Not all fuse box descriptions in this Owner's Manual may apply to your vehicle. Refer to the fuse box label, where fitted.

**Fuse extractor**

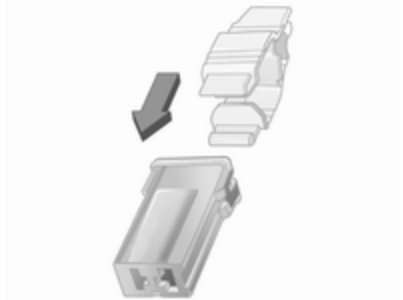
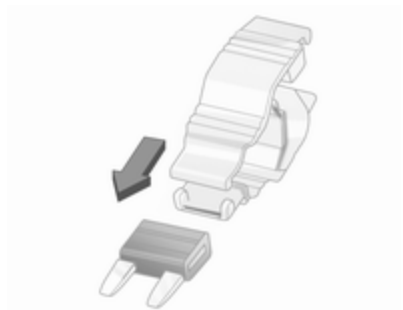

A fuse extractor may be located on the instrument panel fuse box cover.

Place the fuse extractor on the various types of fuse from the top or side, and withdraw fuse.

**Instrument panel fuse box**

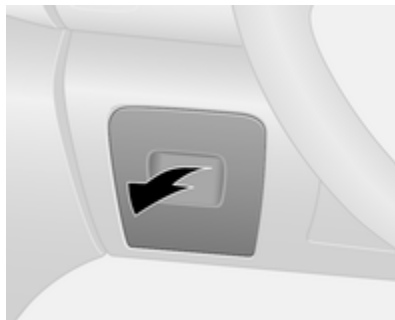

The fuse box is located on the left-hand side of the instrument panel, behind a trim panel.

Pull upper part of trim panel and remove to access the fuse box.

Do not store any objects behind this panel.

Some circuits may be protected by several fuses.



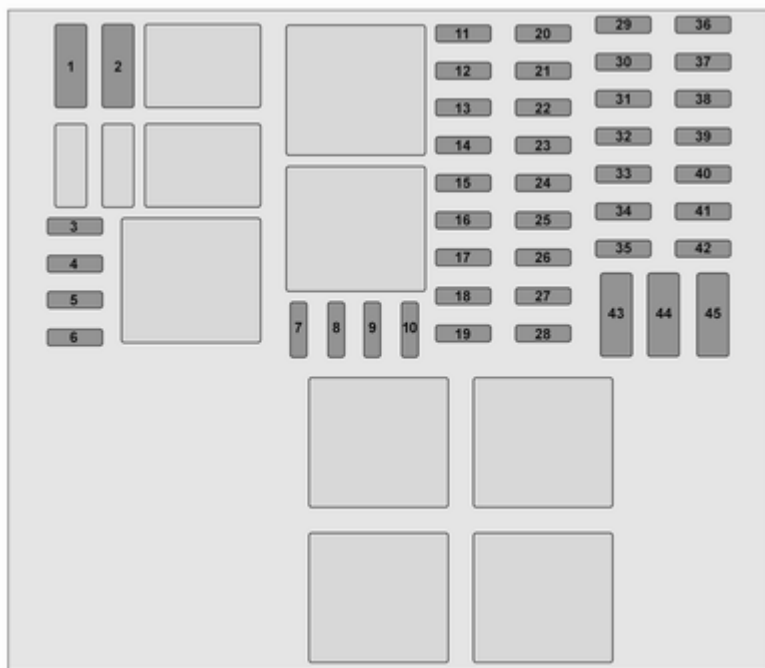

**No. Circuit**

---

- 1 Battery backup (with electronic key system)
- 2 Adaptations
- 3 Adaptations
- 4 Vehicle battery (with electronic key system)
- 5 Additional heating and ventilation / Air conditioning system
- 6 Supplementary heating and ventilation system
- 7 Electric exterior mirrors / Additional adaptations
- 8 Heated exterior mirrors
- 9 Radio / Multimedia / Electric exterior mirrors / Diagnostic socket
- 10 Multimedia / Trailer hitch
- 11 Courtesy lights / Battery discharge protection

**No. Circuit**

---

- 12 Right-hand high beam / Left-hand low beam / Sidelights / Right-hand daytime running light
- 13 Hazard warning flashers / Turn lights
- 14 Central locking
- 15 Left-hand high beam / Right-hand low beam / Tail lights / Left-hand daytime running light
- 16 Front fog lights / Rear fog lights / Number plate lighting
- 17 Alarm / Horn / Lighting / Wiper
- 18 Instrument cluster
- 19 Heating and ventilation system
- 20 Rear window wiper / Windscreen washer pump / Horn
- 21 General battery
- 22 Reversing lights
- 23 Brake switch

**No. Circuit**

---

- 24 Fuel injection / Starter
- 25 Airbag / Steering column lock
- 26 Passenger power window
- 27 Power steering
- 28 Brake lights
- 29 Battery backup (with electronic key system)
- 30 Service display
- 31 Cigarette lighter / Power outlet
- 32 Heating and ventilation system
- 33 Brake lights / ABS / Immobiliser
- 34 Interior lighting / Air conditioning
- 35 Starting with electronic key system
- 36 Rear window wiper
- 37 Warning chimes
- 38 Load compartment power outlet
- 39 Driver power window

**No. Circuit**

- 40 Rear power outlet
- 41 Starting / Body control module
- 42 Heated seats
- 43 Tachograph
- 44 Windscreen wiper
- 45 Heating / Air conditioning

After having changed defective fuses, replace the trim panel.

**Vehicle tools****Tools**

The jack, wheel wrench, wheel bolt sleeve, torx key, adapters, wheel cover hook, towing eye are contained in a unit, stowed under the driver's seat.

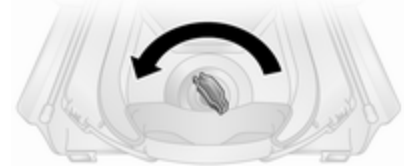

Slide seat forwards and fold the backrest forwards ⇨ 46 to access the tool box. The tool box may be secured in position with a wing nut. Rotate wing nut anticlockwise to release.

Wheel changing ⇨ 194.

Spare wheel ⇨ 195.

Vehicles with tyre repair kit: The wheel cover hook and torx key are stored within the tyre repair kit case, stowed under the driver's seat.

Tyre repair kit ⇨ 191.

## Wheels and tyres

### Tyre condition, wheel condition

Drive over edges slowly and at right angles if possible. Driving over sharp edges can cause tyre and wheel damage. Do not trap tyres on the kerb when parking.

Regularly check the wheels for damage. Seek the assistance of a workshop in the event of damage or unusual wear.

We recommend not swapping the front wheels with the rear wheels and vice versa, as this can affect vehicle stability. Always use less worn tyres on the rear axle.

### Tyres

Factory-fitted tyres are matched to the chassis and offer optimum driving comfort and safety.

### Winter tyres

Winter tyres improve driving safety at temperatures below 7 °C and should therefore be fitted on all wheels.

In accordance with country-specific regulations, a notice indicating the maximum permissible speed for the tyres must be affixed within the driver's field of vision.

### Tyre designations

E.g. **195/65 R 16 C 88 Q**

**195** : Tyre width, mm

**65** : Cross-section ratio (tyre height to tyre width), %

**R** : Belt type: Radial

**RF** : Type: RunFlat

**16** : Wheel diameter, inches

**C** : Cargo or commercial use

**88** : Load index e.g. 88 is equivalent to 567 kg

**Q** : Speed code letter

Speed code letter:

**Q** : up to 100 mph

**S** : up to 112 mph

**T** : up to 118 mph

**H** : up to 130 mph

**V** : up to 150 mph

**W** : up to 168 mph

Choose a tyre appropriate for the maximum speed of your vehicle.

The maximum speed is achievable at kerb weight with driver (75 kg) plus 125 kg payload. Optional equipment could reduce the maximum speed of the vehicle.

### Directional tyres

Fit directional tyres such that they roll in the direction of travel. The rolling direction is indicated by a symbol (e.g. an arrow) on the sidewall.

### Tyre pressure

Check the pressure of cold tyres at least every 14 days and before any long journey. Do not forget the spare wheel. This also applies to vehicles with tyre pressure monitoring system.



The tyre pressure information label on the driver's door frame indicates the original equipment tyres and the correspondent tyre pressures. Always inflate tyres to the pressures shown on the label.

Tyre pressures ⇨ 213.

The tyre pressure data refers to cold tyres. It applies to summer and winter tyres.

Always inflate the spare tyre to the highest pressure specified for this tyre size.

Incorrect tyre pressures will impair safety, vehicle handling, comfort and fuel economy and will increase tyre wear.

The tyre pressure table shows all possible tyre combinations ⇨ 213.

For the tyres approved for your vehicle, refer to the EEC Certificate of Conformity provided with your vehicle or other national registration documents.

The driver is responsible for correct adjustment of tyre pressure.

#### **⚠ Warning**

If the pressure is too low, this can result in considerable tyre warm-up and internal damage, leading to tread separation and even to tyre blow-out at high speeds.

#### **⚠ Warning**

For specific tyres the recommended tyre pressure as shown in the tyre pressure table may exceed the maximum tyre

pressure as indicated on the tyre. Never exceed the maximum tyre pressure as indicated on the tyre.

### **Temperature dependency**

Tyre pressure depends on the temperature of the tyre. During driving, tyre temperature and pressure increase.

Tyre pressure values provided on the tyre information label and tyre pressure chart are valid for cold tyres, which means at 20 °C. The pressure increases by nearly 1.5 psi (10 kPa / 0.1 bar) for a 10 °C temperature increase. This must be considered when warm tyres are checked.

### **Trailer towing**

When towing a trailer with a fully laden vehicle, the tyre pressure must be increased by 20 kPa / 0.2 bar (3.0 psi) and the maximum speed limited to 60 mph.

Trailer towing ⇨ 162.

## Tyre pressure monitoring system

The tyre pressure monitoring system uses radio and sensor technology to check tyre pressure levels.

### Caution

Tyre pressure monitoring system warns only about low tyre pressure condition and does not replace regular tyre maintenance by the driver.

All wheels must be equipped with pressure sensors and the tyres must have the prescribed pressure.

### Notice

In countries where the tyre pressure monitoring system is legally required, the use of wheels without pressure sensors will invalidate the vehicle operating permit.

The tyre pressure monitoring system sensors monitor the air pressure in the tyres and transmit tyre pressure readings to a receiver located in the vehicle.

Tyre pressure chart ↗ 213.

### Low tyre pressure condition



A detected low tyre pressure condition is indicated by illumination of control indicator (⚠) ↗ 99 and a corresponding message appears in the Driver Information Centre.

If (⚠) illuminates, stop as soon as possible and inflate the tyres as recommended ↗ 213.

After inflating, some driving may be required to update the tyre pressure values in the system. During this time (⚠) may illuminate.

If (⚠) illuminates at lower temperatures and extinguishes after some driving, this could be an indicator for approaching a low tyre pressure condition. Check tyre pressure of all four tyres.

If the tyre pressure must be reduced or increased, switch off ignition.

Only mount wheels with pressure sensors, otherwise (⚠) flashes for several seconds then illuminates continuously together with control indicator ↗ 97 and a corresponding message appears in the Driver Information Centre.

A spare wheel or temporary spare wheel is not equipped with pressure sensors. The tyre pressure monitoring system is not operational for these wheels. For the further three wheels, the tyre pressure monitoring system remains operational.

Control indicator (⚠) and the corresponding message appears at each ignition cycle until the tyres are inflated to the correct tyre pressure.

Driver Information Centre ↗ 101.

Vehicle messages ↗ 102.

## Puncture

A puncture or severely under-inflated tyre is indicated by illumination of control indicator (⚠) together with STOP ⇨ 97 and a corresponding message appears in the Driver Information Centre. Stop vehicle and switch off engine.

Tyre pressure ⇨ 213.

Tyre repair kit ⇨ 191.

Spare wheel ⇨ 195.

Wheel changing ⇨ 194.

## Relearn function

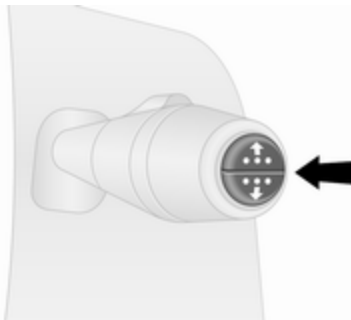

After a puncture has been repaired and the driver has inflated the tyres to the correct tyre pressure, the tyre pressure monitoring system needs to recalculate.

Tyre pressure ⇨ 213.

Tyre repair kit ⇨ 191.

During driving, select the tyre pressure menu in the Driver Information Centre by pressing button on end of wiper lever. Press and hold button for approx. 5 seconds to initialise recalculation. A corresponding message appears in the Driver Information Centre.

Several minutes of driving at a speed above 25 mph may be required to complete the relearn process. The system can only provide limited information during this time.

If problems occur during the relearn process, control indicator (⚠) remains illuminated and a warning message is displayed in the Driver Information Centre.

Driver Information Centre ⇨ 101.

Vehicle messages ⇨ 102.

## General information

The use of tyre chains or commercially available liquid tyre repair kits can impair the function of the system. Factory-approved tyre repair kits can be used.

Tyre repair kit ⇨ 191.

Tyre chains ⇨ 190.

External high-power radio equipment could disrupt the tyre pressure monitoring system.

Each time the tyres are replaced, the tyre pressure monitoring system sensors must be dismantled and serviced by a workshop.

## Tread depth

Check tread depth at regular intervals.

Tyres should be replaced for safety reasons at a tread depth of 2–3 mm (4 mm for winter tyres).

For safety reasons it is recommended that the tread depth of the tyres on one axle should not vary by more than 2 mm.



The legally permissible minimum tread depth (1.6 mm) has been reached when the tread has worn down as far as one of the tread wear indicators (TWI). Their position is indicated by markings on the sidewall.

Tyres age, even if they are not used. We recommend tyre replacement every 6 years.

## Changing tyre and wheel size

If tyres of a different size than those fitted at the factory are used, it may be necessary to reprogramme the nominal tyre pressure and make other vehicle modifications.

After converting to a different tyre size, have the label with tyre pressures replaced.

Tyre pressure monitoring system  
⇒ 188.

### ⚠ Warning

The use of unsuitable tyres or wheels may lead to accidents and will invalidate the vehicle operating permit.

## Wheel covers

Wheel covers and tyres that are factory approved for the respective vehicle and comply with all of the relevant wheel and tyre combination requirements must be used.

If the wheel covers and tyres used are not factory approved, the tyres must not have a rim protection ridge.

Wheel covers must not impair brake cooling.

### ⚠ Warning

Use of unsuitable tyres or wheel covers could lead to sudden pressure loss and thereby accidents.

## Tyre chains



Tyre chains are only permitted on the front wheels.



Always use fine mesh chains that add no more than 15 mm to the tyre tread and the inboard sides (including chain lock).

For tyre size 215/60 R17, consult a workshop.

### ⚠ Warning

Damage may lead to tyre blowout.

Wheel covers on steel wheels may come into contact with parts of the chains. In such cases, remove the wheel covers.

Tyre chains may only be used at speeds up to 30 mph and, when travelling on roads that are free of snow, they may only be used for brief periods since they are subject to rapid wear on a hard road and may snap.

The use of tyre chains is not permitted on the temporary spare wheel.

## Tyre repair kit

Minor damage to the tyre tread or sidewall can be repaired with the tyre repair kit.

Do not remove foreign bodies from the tyres.

Tyre damage exceeding four mm or that is at tyre sidewall near the rim cannot be repaired with the tyre repair kit.

### ⚠ Warning

Do not drive faster than 50 mph.  
Do not use for a lengthy period.  
Steering and handling may be affected.

If the vehicle has a flat tyre:

Apply the parking brake and engage first gear or reverse gear.

The tyre repair kit is located under the driver's seat.

Vehicle tools ⇨ 185.

1. Remove the compressor and sealant bottle from the tyre repair kit case.
2. Remove the electrical connection cable and air hose from the compartments on the underside of the compressor.



3. Screw the air hose to the connection on the sealant bottle.
4. Fit the sealant bottle into the retainer on the compressor.  
Set the compressor near the tyre in such a way that the sealant bottle is upright.
5. Unscrew valve cap from defective tyre.

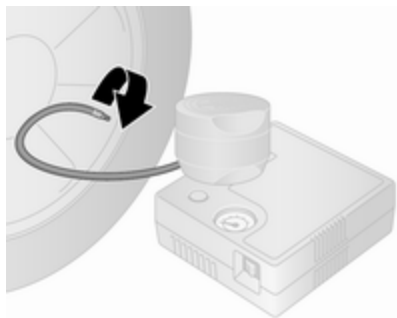

6. Screw the filler hose to the tyre valve.
7. The switch on the compressor must be set to **O**.
8. Connect the electrical connection cable to the power outlet or cigarette lighter socket.

To avoid discharging the vehicle battery, we recommend running the engine.

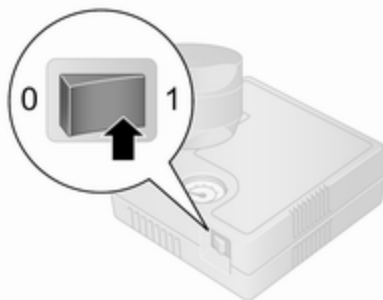

9. Set the rocker switch on the compressor to **I**. The tyre is filled with sealant.
10. The compressor pressure gauge briefly indicates up to six bar (600 kPa/87 psi). Then the pressure starts to drop.
11. All of the sealant is pumped into the tyre. Then the tyre is inflated.



12. The prescribed tyre pressure should be obtained within 15 minutes.

Tyre pressure ⇄ 213.

When the correct pressure is obtained, switch off the compressor.

If the prescribed tyre pressure is not obtained within 15 minutes, remove the tyre repair kit. Move the vehicle one tyre rotation (approx. 2 m). Reattach the tyre repair kit and continue the filling procedure for 15 minutes. If the prescribed tyre pressure is still not obtained, the tyre is too badly

damaged. Seek the assistance of a workshop.

Drain excess tyre pressure with the button beside the pressure indicator.

Do not run the compressor for longer than 15 minutes.

13. Detach the tyre repair kit.
14. Remove any excess sealant using a cloth.
15. Take the label indicating maximum permitted speed from the tyre repair kit and affix in the driver's field of view.
16. Store the sealant bottle in the plastic bag. Return tyre repair kit to case and stow under the driver's seat.

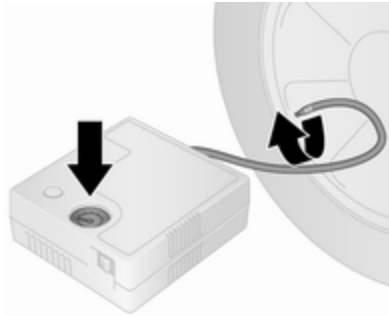

17. Continue driving immediately so that the sealant is evenly distributed throughout the tyre. After driving approx. 6 miles, but no more than 10 minutes, stop and check tyre pressure using the compressor. Screw air hose from compressor directly onto tyre valve when doing this.
18. If the tyre pressure is more than 2.2 bar (220 kPa/31 psi), set it to the correct value. Repeat the procedure until there is no more loss of pressure.  
  
If the tyre pressure has fallen below 2.2 bar (220 kPa/31 psi), the vehicle must not be driven.

Seek the assistance of a workshop.

19. Detach the tyre repair kit, return to case and stow under the driver's seat.

**Warning**

Do not allow the sealant to contact skin, eyes or clothing. If swallowed seek medical assistance immediately.

**Notice**

The driving characteristics of the repaired tyre is severely affected, therefore have this tyre replaced.

If unusual noise is heard or the compressor becomes hot, turn compressor off for at least 30 minutes.

Pay attention to storage information and expiry date on sealant bottle. Its sealing capability is not guaranteed after this time.

Replace the used sealant bottle. Dispose of the sealant bottle as prescribed by applicable laws.

## Wheel changing

Some vehicles are equipped with a tyre repair kit instead of a spare wheel ↪ 191.

Make the following preparations and observe the following information:

- Park the vehicle on a level, firm and non-slippery surface. The front wheels must be in the straight-ahead position.
- Apply the parking brake and engage first gear or reverse gear.
- Remove the spare wheel ↪ 195.
- Never change more than one wheel at a time.
- Use the jack only to change wheels in case of puncture, not for a seasonal winter or summer tyre change.
- The jack is maintenance-free.
- If the ground on which the vehicle is standing is soft, a solid board (max. 1 cm thick) should be placed under the jack.
- Remove heavy objects out of the vehicle before jacking up.

- No people or animals may be in the vehicle when it is jacked-up.
- Never crawl under a jacked-up vehicle.
- Do not start the engine when the vehicle is raised on the jack.
- Clean wheel bolts / nuts and thread with a clean cloth before mounting the wheel.

### Warning

Do not grease wheel bolt, wheel nut and wheel nut cone.

1. Remove the wheel cover (using the hook supplied).  
Vehicle tools ↪ 185.

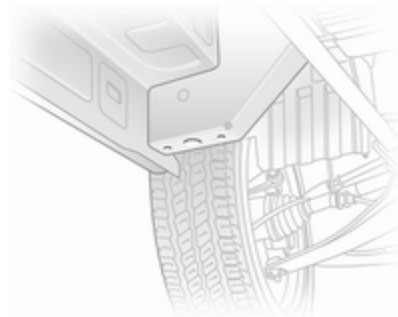

2. Loosen each of the wheel bolts by half a turn using the wheel wrench. Ensure the wrench is securely located. The wrench should turn anticlockwise to loosen the bolts. Invert the wrench if necessary.

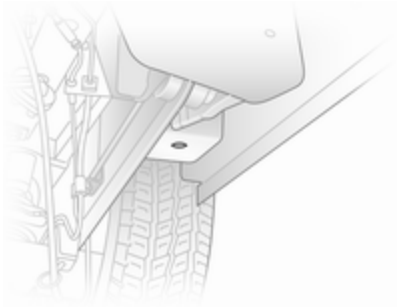

3. Place lifting pad spigot of the jack under the jacking hole located nearest the wheel concerned.  
Ensure the jack is positioned correctly. The jack base must be on the ground directly below the jacking hole in a manner that prevents it from slipping.
4. Install wrench onto the jack and raise the vehicle by turning the wrench until the wheel is clear of the ground.
5. Unscrew wheel bolts completely by turning anticlockwise and wipe clean with a cloth.

Put wheel bolts somewhere where the threads will not be soiled.

6. Change the wheel.  
Spare wheel ⇨ 195.
7. Screw in the wheel bolts.
8. Lower the vehicle and remove jack.
9. Tighten each of the wheel bolts in a crosswise sequence using the wheel wrench. Ensure the wrench is securely located. The wrench should turn clockwise to tighten the bolts. Invert the wrench if necessary.  
Tightening torque is 160 Nm.
10. Replace the wheel cover, ensuring that the valve hole in the wheel cover is aligned with the tyre valve before installing.

#### Notice

If applicable, fit anti-theft bolts nearest the tyre valve (otherwise it may not be possible to refit the wheel cover).

11. Stow the replaced wheel ⇨ 195 and the vehicle tools ⇨ 185.
12. Have the new wheel balanced on the vehicle.  
Check the tyre pressure of the installed tyre ⇨ 213.  
Check the wheel bolt torque.  
Have the defective tyre renewed or repaired as soon as possible.

## Spare wheel

Some vehicles are equipped with a tyre repair kit instead of a spare wheel ⇨ 191.

The spare wheel can be classified as a temporary spare wheel depending on the size compared to the other mounted wheels and country regulations. In this case a permissible maximum speed applies, even though no label at the spare wheel indicates this.

**Caution**

The use of a spare wheel that is smaller than the other wheels or in combination with winter tyres could affect driveability. Have the defective tyre replaced as soon as possible.

It may be necessary to jack the vehicle up to gain access to the spare wheel on a fully loaded vehicle with a flat rear tyre.

Wheel changing ⇨ 194.

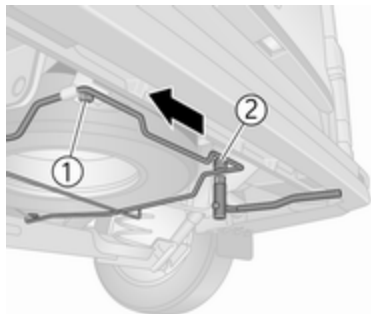

The spare wheel is mounted under the rear underbody and may be secured using a security bolt that can only be removed using the wheel bolt sleeve supplied.

Vehicle tools ⇨ 185.

**⚠ Warning**

Due to the weight of the tyre assembly, exercise caution when releasing the spare wheel carrier. Do not fully remove bolt 1.

Support the spare wheel with a suitable object to prevent the wheel falling suddenly when loosening the carrier bolts - risk of injury!

To release the spare wheel carrier, fully remove bolt 2 then loosen bolt 1, ensuring it is not fully removed. Then move the spare wheel carrier up and down and from side to side, until it clears bolt 1, and lower the carrier assembly.

When installing the wheel ensure that the spare wheel carrier is correctly positioned before tightening the bolts.

**Summer and winter tyres**

If you use winter tyres, the spare wheel may still be fitted with a summer tyre.

If you use the spare wheel when it is fitted with a summer tyre the vehicle's driveability may be affected, especially on slippery road surfaces.

**Directional tyres**

Fit directional tyres such that they roll in the direction of travel. The rolling direction is indicated by a symbol (e.g. an arrow) on the sidewall.

The following applies to tyres fitted opposing the rolling direction:

- Driveability may be affected. Have the defective tyre renewed or repaired as soon as possible and fit it instead of the spare wheel.
- Do not drive faster than 50 mph.
- Drive particularly carefully on wet and snow-covered road surfaces.

## Jump starting

Do not start with a quick charger.

A vehicle with a discharged battery can be started using jump leads and the vehicle battery of another vehicle.

### ⚠ Warning

Be extremely careful when starting with jump leads. Any deviation from the following instructions can lead to injuries or damage caused by battery explosion or damage to the electrical systems of both vehicles.

### ⚠ Warning

Avoid contact of the battery with eyes, skin, fabrics and painted surfaces. The fluid contains sulphuric acid which can cause injuries and damage in the event of direct contact.

- Never expose the battery to naked flames or sparks.

- A discharged vehicle battery can already freeze at a temperature of 0 °C. Defrost the frozen battery before connecting jump leads.
- Wear eye protection and protective clothing when handling a battery.
- Use a booster battery with the same voltage (12 V). Its capacity (Ah) must not be much less than that of the discharged battery.
- Use jump leads with insulated terminals and a cross section of at least 16 mm<sup>2</sup> (25 mm<sup>2</sup> for diesel engines).
- Do not disconnect the discharged vehicle battery from the vehicle.
- Switch off all unnecessary electrical consumers.
- Do not lean over the battery during jump starting.
- Do not allow the terminals of one lead to touch those of the other lead.
- The vehicles must not come into contact with each other during the jump starting process.

- Apply the parking brake, transmission in neutral.
- Open the positive terminal protection caps of both batteries.

The battery is located in the engine compartment.

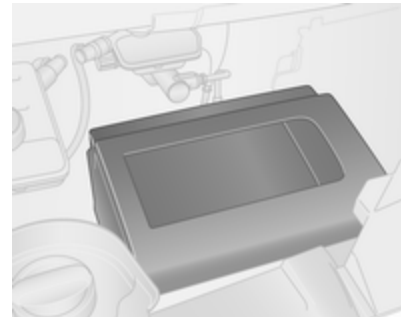

Remove cover to access the battery.

### Notice

If present, the additional battery is automatically connected to the main vehicle battery only when the engine is running. It does not need to be manually disconnected before jump starting the vehicle.

Vehicle battery ⇨ 171.

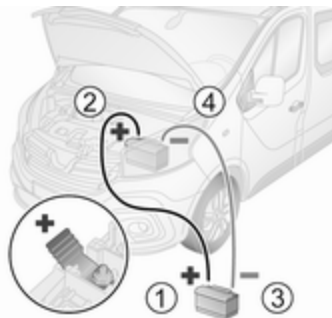

Lead connection order:

1. Connect the red lead to the positive terminal (1) of the booster battery.
2. Connect the other end of the red lead to the positive terminal (2) of the discharged vehicle battery.
3. Connect the black lead to the negative terminal (3) of the booster battery.
4. Connect the other end of the black lead to a vehicle grounding point (4), such as the engine block or an engine mounting bolt. Connect as

far away from the discharged vehicle battery as possible, however at least 60 cm.

Route the leads so that they cannot catch on rotating parts in the engine compartment.

To start the engine:

1. Start the engine of the vehicle providing the jump start.
2. After five minutes, start the other engine. Start attempts should be made for no longer than 15 seconds at an interval of 1 minute.
3. Allow both engines to idle for approx. 3 minutes with the leads connected.
4. Switch on electrical consumers (e.g. headlights, heated rear window) of the vehicle receiving the jump start.
5. Reverse above sequence exactly when removing leads.

## Towing

### Towing the vehicle

The towing eye is stowed with the vehicle tools ⇨ 185.

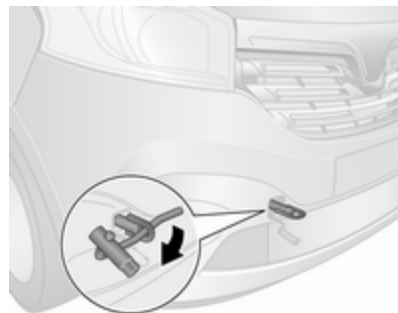

Release cap using a suitable tool.

Screw the towing eye clockwise into the front towing point and tighten fully using the wheel wrench.

Attach a tow rope - or better still a tow rod - to the towing eye, never to the bumper or front suspension units.



**Caution**

Do not tow the vehicle from the rear. The front towing eye must only be used for towing and not recovering a vehicle.

**Caution**

Activate the child locks in the rear doors if the rear seats are occupied.

Child locks ⇨ 30.

Switch on ignition to permit operation of brake lights, horn and windscreen wipers, and move the steering wheel slightly to release the steering wheel lock.

**Notice**

Depending on version, it may be necessary to switch on the engine to permit operation of brake lights.

Move the selector lever to neutral.

Release the parking brake.

**Caution**

Drive slowly. Do not drive jerkily. Excessive tractive force can damage the vehicle.

When the engine is not running, considerably more force is needed to brake and steer.

Switch on hazard warning flashers  
⇨ 111.

To prevent the entry of exhaust fumes from the towing vehicle, switch on the air recirculation system ⇨ 117 and close the windows.

Seek the assistance of a workshop.

After towing, unscrew the towing eye and replace cap.

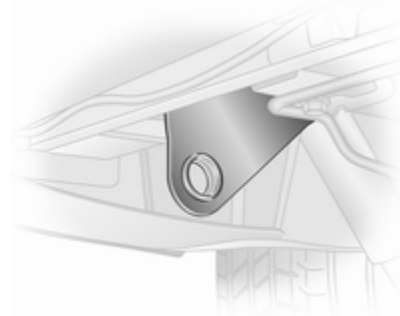
**Towing another vehicle**

The fixed towing eye is located under the rear bumper, on the left vehicle side.

Attach a tow rope - or better still a tow rod - to the rear towing eye, never to the rear axle and suspension units.

The rear towing eye must only be used for towing and not recovering a vehicle.

**Caution**

Drive slowly. Do not drive jerkily. Excessive tractive force can damage the vehicle.

Trailer hitch ⇨ 162.

**Appearance care****Exterior care****Locks**

The locks are lubricated at the factory using a high quality lock cylinder grease. Use de-icing agent only when absolutely necessary, as this has a degreasing effect and impairs lock function. After using a de-icing agent, have the locks regreased by a workshop.

**Washing**

The paintwork of your vehicle is exposed to environmental influences, therefore wash your vehicle regularly.

When using automatic vehicle washes, we recommend one with textile brushes and a programme without wax additives. Restrictions for filmed or matt painted body parts or decor tapes, see "Polishing and waxing".

Never use a steam-jet or high-pressure jet cleaner for the engine compartment.

Wax painted parts of the vehicle regularly.

Bird droppings, dead insects, resin, pollen and the like should be cleaned off immediately, as they contain aggressive constituents which can cause paint damage.

If using a vehicle wash, comply with the vehicle wash manufacturer's instructions. The windscreen wipers and rear window wiper must be switched off and the exterior mirrors must be folded in. Remove antenna and external accessories such as roof racks etc.

If you wash your vehicle by hand, make sure that the insides of the wheel housings are also thoroughly rinsed out.

Clean edges and folds on opened doors and the bonnet as well as the areas they cover.

Clean bright metal mouldings with a cleaning solution approved for aluminium, to avoid damage.

### Caution

Always use a cleaning agent with a pH value of four to nine.

Do not use cleaning agents on hot surfaces.

Thoroughly rinse and leather-off the vehicle. Rinse leather frequently. Use separate leathers for painted and glass surfaces: remnants of wax on the windows will impair vision.

Have the door hinges of all doors greased by a workshop.

### Exterior lights

Headlight and other light covers are made of plastic. Do not use any abrasive or caustic agents, do not use an ice scraper, and do not clean them dry.

### Polishing and waxing

Wax the vehicle regularly (at the latest when water no longer beads). Otherwise, the paintwork will dry out.

Polishing is necessary only if the paint has become dull or if solid deposits have become attached to it.

Paintwork polish with silicone forms a protective film, making waxing unnecessary.

Unpainted plastic body parts must not be treated with wax or polishing agents.

Matt filmed body parts or decor tapes must not be polished, to avoid gleaming. Do not use hot wax programmes in automatic car washes if the vehicle is equipped with these parts.

Matt painted decor parts, e.g. mirror housing cover, must not be polished. Otherwise these parts would become a gleam or the colour would be dissolved.

### Windows and wiper blades

Switch off wipers before handling in their movement areas.

Use a soft lint-free cloth or chamois leather together with window cleaner and insect remover.

When cleaning the rear window from inside, always wipe in parallel to the heating element to prevent damage.

For mechanical removal of ice, use a sharp-edged ice scraper. Press the scraper firmly against the glass so that no dirt can get under it and scratch the glass.

Remove dirt residues from smearing wiper blades by using a soft cloth and window cleaner. Also make sure to remove any residues such as wax, insect residues and similar from the window.

Ice residues, pollution and continuous wiping on dry windows will damage or even destroy the wiper blades.

### Wheels and tyres

Do not use high-pressure jet cleaners.

Clean rims with a pH-neutral wheel cleaner.

Rims are painted and can be treated with the same agents as the body.

### Paintwork damage

Rectify minor paintwork damage with a touch-up pen before rust forms. Have more extensive damage or rust areas repaired by a workshop.

### Underbody

Some areas of the vehicle underbody have a PVC undercoating while other critical areas have a durable protective wax coating.

After the underbody is washed, check the underbody and have it waxed if necessary.

Bitumen / rubber materials could damage the PVC coating. Have underbody work carried out by a workshop.

Before and after winter, wash the underbody and have the protective wax coating checked.

### Towing equipment

Do not clean the coupling ball bar with a steam-jet or high-pressure jet cleaner.

## Interior care

### Interior and upholstery

Only clean the vehicle interior, including the instrument panel fascia and panelling, with a dry cloth or interior cleaner.

Clean any leather upholstery with clear water and a soft cloth. In case of heavy soiling, use leather care.

The instrument cluster and the displays should only be cleaned using a soft damp cloth. If necessary use a weak soap solution.

Clean fabric upholstery with a vacuum cleaner and brush. Remove stains with an upholstery cleaner.

Clothing fabrics may not be colourfast. This could cause visible discolourations, especially on light-coloured upholstery. Removable stains and discolourations should be cleaned as soon as possible.

Clean seat belts with lukewarm water or interior cleaner.

### Caution

Close Velcro fasteners as open Velcro fasteners on clothing could damage seat upholstery.

The same applies to clothing with sharp-edged objects, like zips or belts or studded jeans.

### Plastic and rubber parts

Plastic and rubber parts can be cleaned with the same cleaner as used to clean the body. Use interior cleaner if necessary. Do not use any other agent. Avoid solvents and petrol in particular. Do not use high-pressure jet cleaners.

## Service and maintenance

<b>General information</b> .....	<b>203</b>
Service information .....	203
<b>Recommended fluids, lubricants and parts</b> .....	<b>204</b>
Recommended fluids and lubricants .....	204

## General information

### Service information

In order to ensure economical and safe vehicle operation and to maintain the value of your vehicle, it is of vital importance that all maintenance work is carried out at the proper intervals as specified.

The detailed, up-to-date service schedule for the vehicle is available at the workshop.

Service display ⇨ 92.

Engine identification ⇨ 207.

### European service intervals

Maintenance of your vehicle is required every 25,000 miles or after two years, whichever occurs first, unless otherwise indicated by the service display.

A shorter service interval can be valid for severe driving behaviour, e.g. for taxis and police vehicles.

The European service intervals are valid for the following countries:

Andorra, Austria, Belgium, Croatia, Czech Republic, Denmark, Estonia, Finland, France, Germany, Greece, Hungary, Iceland, Ireland, Italy, Latvia, Liechtenstein, Lithuania, Luxembourg, Netherlands, Norway, Poland, Portugal, Slovakia, Slovenia, Spain, Sweden, Switzerland, United Kingdom.

Service display ⇨ 92.

### Confirmations

Confirmation of service is recorded in the Service and warranty booklet. The date and mileage is completed with the stamp and signature of the servicing workshop.

Make sure that the Service and warranty booklet is completed correctly as continuous proof of service is essential if any warranty or goodwill claims are to be met, and is also a benefit when selling the vehicle.

### Service display

The service interval is based on several parameters depending on usage.

The service display, located in the Driver Information Centre, indicates when the next service is due. Seek the assistance of a workshop.

Service display ⇨ 92.

## Recommended fluids, lubricants and parts

### Recommended fluids and lubricants

Only use products that meet the recommended specifications.

#### Warning

Operating materials are hazardous and could be poisonous. Handle with care. Pay attention to information given on the containers.

### Engine oil

Engine oil is identified by its quality and its viscosity. Quality is more important than viscosity when selecting which engine oil to use. The oil quality ensures e.g. engine cleanliness, wear protection and oil aging control, whereas viscosity grade gives information on the oil's thickness over a temperature range.

Dexos is the newest engine oil quality that provides optimum protection for diesel engines. If it is unavailable, engine oils of other listed qualities must be used.

Select the appropriate engine oil based on its quality and on the minimum ambient temperature ⇨ 208.

### Topping up engine oil

#### Caution

In case of any spilled oil, wipe it up and dispose of it properly.

Engine oils of different manufacturers and brands can be mixed as long as they comply with the required engine oil quality and viscosity.

Select the appropriate engine oil based on its quality and on the minimum ambient temperature ⇨ 208.

### Additional engine oil additives

The use of additional engine oil additives could cause damage and invalidate the warranty.

**Engine oil viscosity grades**

The SAE viscosity grade gives information of the thickness of the oil.

Multigrade oil is indicated by two figures, e.g. SAE 5W-30. The first figure, followed by a W, indicates the low temperature viscosity and the second figure the high temperature viscosity.

Select the appropriate viscosity grade depending on the minimum ambient temperature ↗ 208.

All of the recommended viscosity grades are suitable for high ambient temperatures.

**Coolant and antifreeze**

Use only silicate-free long life coolant (LLC) antifreeze approved for the vehicle. Consult a workshop.

The system is factory filled with coolant designed for excellent corrosion protection and frost protection down to approx. -28 °C. This concentration should be maintained all year round. The use of additional coolant additives that intend to give additional corrosion

protection or seal against minor leaks can cause function problems. Liability for consequences resulting from the use of additional coolant additives will be rejected.

**Washer fluid**

Use only washer fluid approved for the vehicle to prevent damage of wiper blades, paintwork, plastic and rubber parts. Consult a workshop.

**Brake fluid**

Over time, brake fluid absorbs moisture which will reduce braking effectiveness. The brake fluid should therefore be replaced at the specified interval.

**AdBlue**

Only use AdBlue to reduce the nitrogen oxides in the exhaust emission ↗ 140.

## Technical data

<b>Vehicle identification</b> .....	<b>206</b>
Vehicle Identification Number ..	206
Identification plate .....	207
Engine identification .....	207
<b>Vehicle data</b> .....	<b>208</b>
Recommended fluids and lubricants .....	208
Vehicle dimensions .....	209
Capacities .....	212
Tyre pressures .....	213

## Vehicle identification

### Vehicle Identification Number



The Vehicle Identification Number is visible through the windscreen.

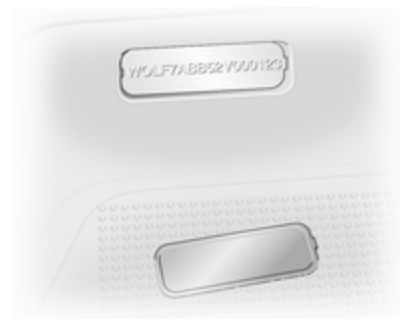

The VIN is also displayed behind a removable plastic cover on the right-hand side door step.



## Identification plate



The identification plate is located on the right-hand door pillar.

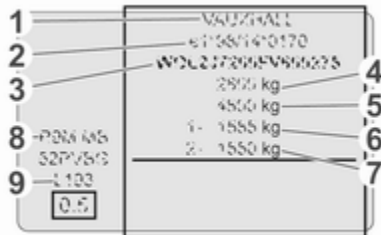

Information on identification plate:

- 1 : Manufacturer
- 2 : Type approval number
- 3 : Vehicle Identification Number
- 4 : Permissible gross vehicle weight rating in kg
- 5 : Permissible gross train weight in kg
- 6 : Maximum permissible front axle load in kg
- 7 : Maximum permissible rear axle load in kg
- 8 : Engine coding
- 9 : Vehicle-specific or country specific data

### Notice

The identification plate on your vehicle may differ from the illustration shown.

The combined total of front and rear axle loads must not exceed the permissible gross vehicle weight.

Vehicle's kerb weight depends on the specification of the vehicle, e.g. optional equipment and accessories. Refer to the EEC Certificate of

Conformity provided with your vehicle or other national registration documents.

The technical data is determined in accordance with European Community standards. We reserve the right to make modifications. Specifications in the vehicle documents always have priority over those given in this manual.

## Engine identification

Vivaro has diesel engines with four cylinders and a piston displacement of 1598 cm<sup>3</sup>. The engine identifier code starts with R9M and identifies the power and the emission category. It is part of the identification plate and stamped on the engine cylinder block.

For further technical data, refer to the EEC Certificate of Conformity provided with your vehicle or other national registration documents.

It is also possible, using the Vehicle Identification Number (VIN), to determine the engine type that is installed in your vehicle. For further information consult a workshop.

## Vehicle data

### Recommended fluids and lubricants

#### Required engine oil quality

##### Engine oil quality: Europe

---

**dexos 2** ✓

For countries with International service interval ⇨ 203, you may use the oil qualities listed below:

##### Engine oil quality: International

---

**dexos 2** ✓

ACEA C3 ✓  
engines with diesel particle filter

ACEA A3/B4 ✓  
engines without diesel particle filter

### Engine oil viscosity grades

#### Ambient temperature

---

down to -25 °C SAE 0W-30 or SAE 0W-40

SAE 5W-30 or SAE 5W-40

below -25 °C SAE 0W-30 or SAE 0W-40

## Vehicle dimensions

Type	Van		Combi		Double cab		Platform cab
	L1	L2	L1	L2	L1	L2	L2
Wheelbase							
Length [mm]	4999	5399	4999	5399	4999	5399	5248
Width without exterior mirrors [mm]	1956	1956	1956	1956	1956	1956	1955
Width with two exterior mirrors [mm]	2283	2283	2283	2283	2283	2283	2283
Height - unladen (without antenna) [mm]							
H1	1971	1967	1970	1970	1971	1967	1971
H2	2493	2493	-	-	-	-	-
Wheelbase [mm]	3098	3498	3098	3498	3098	3498	3498

## Loadspace dimensions

Van	L1		L2	
	H1	H2	H1	H2
Roof height				
Maximum rear door aperture height [mm]	1295	1818	1295	1818
Rear door aperture width (at floor) [mm]	1391	1391	1391	1391
Maximum load area height [mm]	1387	1913	1387	1913
Maximum load area width [mm]	1662	1662	1662	1662

## 210 Technical data

<b>Van</b>	<b>L1</b>		<b>L2</b>	
<b>Roof height</b>	<b>H1</b>	<b>H2</b>	<b>H1</b>	<b>H2</b>
Width between wheel arches [mm]	1268	1268	1268	1268
Maximum load floor length [mm]	2537	2537	2937	2937
Maximum load floor length - up to front passenger foot well (with load-through feature) [mm]	3815	3815	4150	4150
Sliding side door aperture width [mm]	1229	1229	1229	1229
Sliding side door aperture width - at 100 mm from floor [mm]	1030	1030	1030	1030
Sliding side door aperture height [mm]	1284	1284	1284	1284
<b>Combi</b>	<b>L1</b>		<b>L2</b>	
Maximum rear door aperture height [mm]	1295		1295	
Rear door aperture width (at floor) [mm]	1391		1391	
Maximum load area height [mm]	1369		1369	
Maximum load area width [mm]	1662		1662	
Width between wheel arches [mm]	1268		1268	
Maximum load floor length - with tailgate [mm]	736 / 1620 <sup>1)</sup>		1136 / 2020 <sup>1)</sup>	
Maximum load floor length - with rear doors [mm]	765 / 1679 <sup>1)</sup>		1165 / 2079 <sup>1)</sup>	

<b>Combi</b>	<b>L1</b>	<b>L2</b>
Sliding side door aperture width [mm]	1229	1229
Sliding side door aperture width - at 100 mm from floor [mm]	1030	1030
Sliding side door aperture height [mm]	1284	1284

1) Depending on seat row.

<b>Double cab</b>	<b>L1</b>	<b>L2</b>
Maximum rear door aperture height [mm]	1320	1320
Rear door aperture width (at floor) [mm]	1391	1391
Maximum load area height [mm]	1387	1387
Maximum load area width [mm]	1662	1662
Width between wheel arches [mm]	1268	1268
Maximum load floor length [mm]	2000	2400
Maximum load floor length - behind rear seats [mm]	1370	1770
Sliding side door aperture width [mm]	1229	1229
Sliding side door aperture width - at 100 mm from floor [mm]	1030	1030
Sliding side door aperture height [mm]	1284	1284

## Capacities

### Fuel tank

Fuel tank, nominal capacity [l] 80

---

### AdBlue tank

AdBlue, nominal capacity [l] 22.5

---

## Tyre pressures

Tyre	Front	Rear
	[kPa/bar] (psi)	[kPa/bar] (psi)
195/75 R16 C 107/105T, 205/65 R16 C 107/105T	380/3.8 (55)	420/4.2 (61)
215/65 R16 C 106/104T, 215/65 R16 C 107/105T	310/3.1 (45)	340/3.4 (49)
215/60 R17 C 109/107T	350/3.5 (51) <sup>2)</sup>	390/3.9 (57) <sup>3)</sup>

2) Combi: 320/3.2 (46) for non-motorway driving.

3) Combi: 350/3.5 (51) for non-motorway driving.

## Customer information

<b>Customer information</b> .....	<b>214</b>
Declaration of conformity .....	214
REACH .....	218
Registered trademarks .....	218
<b>Vehicle data recording and privacy</b> .....	<b>218</b>
Event data recorders .....	218
Radio Frequency Identification (RFID) .....	221

## Customer information

### Declaration of conformity

#### Radio transmission systems

This vehicle has systems that transmit and / or receive radio waves subject to Directive 2014/53/EU. The manufacturers of the systems listed below declare conformity with Directive 2014/53/EU. The full text of the EU declaration of conformity for each system is available at the following internet address: [www.opel.com/conformity](http://www.opel.com/conformity).

Importer is  
Opel / Vauxhall, Bahnhofspatz,  
65423 Ruesselsheim am Main,  
Germany.

#### Electronic key transmitter

Continental Automotive  
1 Rue de Clairefontaine, 78120  
Rambouillet, France  
Operation frequency: 433 MHz  
Maximum output: 10 mW ERP

#### Immobiliser

Visteon Electronics  
04 Rue Nelson Mandela, Zone  
Industrielle Borj Cedria, 2055 Bir El  
Bey, Tunisia

Operation frequency: 125 kHz  
Maximum output:  
42 dBµA/m @ 10 m

#### Immobiliser

Continental Automotive  
1 Rue de Clairefontaine, 78120  
Rambouillet, France  
Operation frequency: 125 kHz  
Maximum output:  
42 dBµA/m @ 10 m

#### IntelliLink Touch

Continental Automotive  
1 Rue de Clairefontaine, 78120  
Rambouillet, France  
Operation frequency: N/A  
Maximum output: N/A

#### NAVI 50 IntelliLink / NAVI 80 IntelliLink

LG Electronics



LG Electronics European Shared Service Center B.V., Krijgsman 1, 1186 DM Amstelveen, The Netherlands

Operation frequency: 2.4 GHz

Maximum output: 100 mW EIRP

### Navigation module

TomTom Int'l BV

De Ruijterkade 154, 1011 AC Amsterdam, The Netherlands

Operation frequency: 2.4 GHz

Maximum output: 100 mW EIRP

### Parking heater remote control receiver

Eberspaecher Climate Control Systems GmbH & Co. KG

Eberspaecherstrasse 24, 73730 Esslingen, Germany

Operation frequency: N/A

Maximum output: N/A

### Parking heater remote control transmitter

Eberspaecher Climate Control Systems GmbH & Co. KG

Eberspaecherstrasse 24, 73730 Esslingen, Germany

Operation frequency: 434.6 MHz

Maximum output: 10 dBm

### Telematics control unit

Continental Automotive

1 Rue de Clairefontaine, 78120 Rambouillet, France

Operation frequency: 2400 – 2483,5 MHz

Maximum output: 100 mW EIRP

### R16 / R16 BT USB / CD18 BT USB

Visteon Electronics

04 Rue Nelson Mandela, Zone Industrielle Borj Cedria, 2055 Bir El Bey, Tunisia

Operation frequency: 2.4 GHz

Maximum output: 100 mW EIRP

### Radio remote control transmitter

Visteon Electronics

04 Rue Nelson Mandela, Zone Industrielle Borj Cedria, 2055 Bir El Bey, Tunisia

Operation frequency: 433 MHz

Maximum output: 10 mW ERP

### Radio remote control receiver

Visteon Electronics

04 Rue Nelson Mandela, Zone Industrielle Borj Cedria, 2055 Bir El Bey, Tunisia

Operation frequency: 433 MHz

Maximum output: 10 mW ERP

### Rear view camera display

Ficosa International

Gran Via de Carles III, 98, 08028 Barcelona, Spain

Operation frequency (MHz)	Maximum output (dBm)
---------------------------	----------------------

824 - 894	39
-----------	----

880 - 960	39
-----------	----

1710 - 1880	36
-------------	----

1850 - 1890	33
-------------	----

### Telematics module

Masternaut International

4 Rue Charles Cros, 27400 Louviers, France

Operation frequency (MHz)	Maximum output (dBm)
900	33
1800	30

### **Tyre Pressure Monitoring**

Schrader Electronics

Trooperslane Industrial Estate, 2  
Meadowbank Rd, Carrickfergus  
BT38 8YF, United Kingdom

Operation frequency: 433 MHz

Maximum output: 10 mW ERP

### **Radar systems**

Country-specific Declarations of  
Conformity for radar systems are  
shown on the following page:

**European Union**

EC Directive: 1999/5/EC  
 Manufacturer: Delphi Electronics & Safety  
 Model / Type Designation: L2C0038TR  
 Description / Intended Use:  
 Electronically Scanned Radar (ESR),  
 a 76.5GHz adaptive cruise control system  
 radar fitted to motor vehicles at vehicle  
 manufacture  
 Applied Standards:  
 47 CFR Part 15  
 CEPT ERC Recommendation 70-03  
 EN 60950  
 EN 301 091  
 European Commission Directive  
 2006/28/EC

I declare that the product referenced  
 above is in compliance with the essential  
 requirements and other relevant  
 provisions of Directive 1999/5/EC, on the  
 approximation of the laws of the member  
 states relating to Directive 1999/5/EC.

**Brazil**

Modelo: L2C0038TR



1071-10-3451



0107897843800248

Este equipamento  
 opera em caráter  
 secundário, isto é,  
 não tem direito a  
 proteção contra  
 interferência  
 prejudicial, mesmo de estações do  
 mesmo tipo, e não pode causar  
 interferência a sistemas operando em  
 caráter primário

**Indonesia**

14785/POSTEL/2010  
 1982

**Jordan**

Type Approval No.: TRC/LPD/2009/87  
 Equipment Type: Low Power Device (LPD)

**Malaysia**

Approval #: B 05358

**Moldova**

8526

**Morocco**

AGREE PAR L'ANRT MAROC  
 Numéro d'agrément :  
 MR 4838 ANRT 2009  
 Date d'agrément : 22/5/2009

**Singapore**

Complies with  
 IDA Standards  
 DA105753

**South Africa**

TA-2009/163  
 APPROVED

**South Korea**

방송통신위원회  
 인가번호 : KCC-0809R120038TR

**Taiwan**

● CCAB09LP4590T3

**UAE**

TRA  
 REGISTERED No:  
 0018923/09  
 DEALER No:  
 DA0047809/10

**United States of America and Canada**

Model / FCC ID: L2C0038TR IC: 3432A-0038TR

This device complies with Part 15 of the FCC Rules  
 and with Industry Canada license-exempt RSS  
 standard(s). Operation is subject to the following  
 two conditions: (1) This device may not cause  
 harmful interference, and (2) This device must  
 accept any interference received, including  
 interference that may cause undesired operation.

Le présent appareil est conforme aux CNR  
 d'Industrie Canada applicables aux appareils  
 radio exempts de licence. L'exploitation est  
 autorisée aux deux conditions suivantes: (1)  
 l'appareil ne doit pas produire de brouillage, et  
 (2) l'utilisateur de l'appareil doit accepter tout  
 brouillage radioélectrique subi, même si le  
 brouillage est susceptible d'en compromettre le  
 fonctionnement.

Note: Changes or modifications not expressly  
 approved by the party responsible for compliance  
 could void the user's authority to operate the  
 equipment. The term "IC:" before the radio  
 certification number only signifies that Industry  
 Canada technical specifications were met.

Note: This equipment complies with radiation  
 exposure limits set forth for an uncontrolled  
 environment. This equipment should be installed  
 and operated with minimum distance of 20 cm  
 between the radiator and your body.

## REACH

Registration, Evaluation, Authorisation and Restriction of Chemicals (REACH) is a European Union regulation adopted to improve the protection of human health and the environment from the risks that can be posed by chemicals. Visit [www.opel.com/reach](http://www.opel.com/reach) for further information and for access to the Article 33 communication.

## Registered trademarks

### Apple Inc.

Apple CarPlay™ is a trademark of Apple Inc.

App Store® and iTunes Store® are registered trademarks of Apple Inc.

iPhone®, iPod®, iPod touch®, iPod nano®, iPad® and Siri® are registered trademarks of Apple Inc.

### Bluetooth SIG, Inc.

Bluetooth® is a registered trademark of Bluetooth SIG, Inc.

### DivX, LLC

DivX® and DivX Certified® are registered trademarks of DivX, LLC.

### EnGIS Technologies, Inc.

BringGo® is a registered trademark of EnGIS Technologies, Inc.

### Google Inc.

Android™ and Google Play™ Store are trademarks of Google Inc.

### Stitcher Inc.

Stitcher™ is a trademark of Stitcher, Inc.

### Verband der Automobilindustrie e.V.

AdBlue® is a registered trademark of the VDA.

## Vehicle data recording and privacy

### Event data recorders

Electronic control units are installed in your vehicle. Control units process data which is received by vehicle sensors, for example, or which they generate themselves or exchange amongst themselves. Some control units are necessary for the safe functioning of your vehicle, others assist you while you drive (driver assistance systems), while others provide comfort or infotainment functions.

The following contains general information about data processing in the vehicle. You will find additional information as to which specific data is uploaded, stored and passed on to third parties and for what purpose in your vehicle under the key word Data Protection closely linked to the references for the affected functional characteristics in the relevant owner's manual or in the general terms of sale. These are also available online.

## Operating data in the vehicle

Control units process data for operation of the vehicle.

This data includes, e.g.:

- vehicle status information (e.g. speed, movement delay, lateral acceleration, wheel rotation rate, "seat belts fastened" display)
- ambient conditions (e.g. temperature, rain sensor, distance sensor)

As a rule such data is transient, not stored for longer than an operational cycle, and only processed on board the vehicle itself. Control units often include data storage (including the vehicle key). This is used to allow information to be documented temporarily or permanently on vehicle condition, component stress, maintenance requirements and technical events and errors.

Depending on technical equipment level, the data stored is as follows:

- system component operating states (e.g. fill level, tyre pressure, battery status)
- faults and defects in important system components (e.g. lights, brakes)
- system reactions in special driving situations (e.g. triggering of an airbag, actuation of the stability control systems)
- information on events damaging the vehicle
- for electric vehicles the amount of charge in the high-voltage battery, estimated range

In special cases (e.g. if the vehicle has detected a malfunction), it may be necessary to save data that would otherwise just be volatile.

When you use services (e.g. repairs, maintenance), the operating data saved can be read together with the vehicle identification number and used when necessary. Staff working for the service network (e.g. garages, manufacturers) or third parties (e.g.

breakdown services) can read the data from the vehicle. The same applies to warranty work and quality assurance measures.

Data is generally read via the OBD (On-Board Diagnostics) port prescribed by law in the vehicle. The operating data which is read out, documents the technical condition of the vehicle or individual components and assists with fault diagnosis, compliance with warranty obligations and quality improvement. This data, in particular information on component stress, technical events, operator errors and other faults, is transmitted to the manufacturer where appropriate, together with the vehicle identification number. The manufacturer is also subject to product liability. The manufacturer potentially also uses operating data from vehicles for product recalls. This data can also be used to check customer warranty and guarantee claims.

Fault memories in the vehicle can be reset by a service company when carrying out servicing or repairs or at your request.

## Comfort and infotainment functions

Comfort settings and custom settings can be stored in the vehicle and changed or reset at any time.

Depending on the equipment level in question, these include

- seat and steering wheel position settings
- chassis and air conditioning settings
- custom settings such as interior lighting

You can input your own data in the infotainment functions for your vehicle as part of the selected features.

Depending on the equipment level in question, these include

- multimedia data such as music, videos or photos for playback in an integrated multimedia system
- address book data for use with an integrated hands-free system or an integrated navigation system

- input destinations
- data on the use of online services

This data for comfort and infotainment functions can be stored locally in the vehicle or be kept on a device that you have connected to the vehicle (e.g. a smartphone, USB stick or MP3 player). Data that you have input yourself can be deleted at any time.

This data can only be transmitted out of the vehicle at your request, particularly when using online services in accordance with the settings selected by you.

### Smartphone integration, e.g. Android Auto or Apple CarPlay

If your vehicle is equipped accordingly, you can connect your smartphone or another mobile device to the vehicle so that you can control it via the controls integrated in the vehicle. The smartphone image and sound can be output via the multimedia system in this case. At the same time, specific information is transmitted to your smartphone. Depending on the type of integration,

this includes data such as position data, day / night mode and other general vehicle information. For more information, please see the operating instructions for the vehicle / infotainment system.

Integration allows selected smartphone apps to be used, such as navigation or music playback. No further integration is possible between smartphone and vehicle, in particular active access to vehicle data. The nature of further data processing is determined by the provider of the app used. Whether you can define settings, and if so which ones, is dependent on the app in question and your smartphone's operating system.

## Online services

If your vehicle has a radio network connection, this allows data to be exchanged between your vehicle and other systems. The radio network connection is made possible by means of a transmitter device in your vehicle or a mobile device provided by you (e.g. a smartphone). Online functions can be used via this radio network connection. These include online services and applications / apps provided to you by the manufacturer or other providers.

## Proprietary services

In the case of the manufacturer's online services, the relevant functions are described by the manufacturer in an appropriate location (e.g. Owner's Manual, the manufacturer's website) and the associated data protection information is provided. Personal data may be used to provide online services. Data exchange for this purpose takes place via a protected connection, e.g. using the manufacturer's IT systems provided for the purpose. Collection,

processing and use of personal data for the purposes of preparation of services take place solely on the basis of legal permission, e.g. in the case of a legally prescribed emergency communication system or a contractual agreement, or by virtue of consent.

You can activate or deactivate the services and functions (which are subject to charges to some extent) and, in some cases, the vehicle's entire radio network connection. This does not include statutory functions and services such as an emergency communication system.

## Third party services

If you make use of online services from other providers (third parties), these services are subject to the liability and data protection and usage conditions of the provider in question. The manufacturer frequently has no influence over the content exchanged in this regard.

Therefore, please note the nature, scope and purpose of the collection and use of personal data within the scope of third party services provided by the service provider in question.

## Radio Frequency Identification (RFID)

RFID technology is used in some vehicles for functions such as tyre pressure monitoring and immobiliser. It is also used in connection with conveniences such as radio remote controls for door locking / unlocking and starting. RFID technology in Vauxhall vehicles does not use or record personal information or link with any other Vauxhall system containing personal information.

## Index

- A**
- Absorptive Glass Mat battery..... 171
  - Accessories and vehicle modifications ..... 165
  - AdBlue..... 99, 104, 140, 204
  - AdBlue tank..... 212
  - Adjustable air vents ..... 127
  - AGM battery..... 171
  - Airbag and belt tensioners ..... 96
  - Airbag deactivation ..... 62, 96
  - Airbag label..... 58, 62
  - Airbag system ..... 58
  - Air conditioning regular operation ..... 128
  - Air conditioning system ..... 117
  - Air intake ..... 128
  - Air recirculation..... 117, 198
  - Air vents..... 127
  - Alert..... 103
  - Antifreeze..... 169
  - Antilock brake system ..... 146
  - Antilock brake system (ABS) ..... 98
  - Anti-theft alarm system ..... 36
  - Anti-theft bolts..... 194
  - Anti-theft locking system ..... 35
  - Anti-theft security lock..... 24
  - Appearance care..... 200
  - Armrest ..... 48
  - Ashtrays ..... 88
  - Automatic anti-dazzle ..... 41
  - Automatic fuel cut-off..... 134
  - Automatic light control ..... 109
  - Automatic locking ..... 30
  - Autostop..... 133, 135
  - Auxiliary heater..... 122
- B**
- Battery..... 20, 21, 122, 171
  - Battery discharge protection ..... 115
  - Battery, jump starting..... 197
  - Belts..... 53
  - Bench seat..... 74
  - Bonnet ..... 166
  - Bottle holders..... 74
  - Brake and clutch fluid..... 204
  - Brake assist ..... 147
  - Brake fluid ..... 170
  - Brakes ..... 146, 170
  - Brake system ..... 97
  - Breakdown..... 198
  - Bulb replacement ..... 175
- C**
- Capacities ..... 212
  - Car Pass ..... 20
  - Catalytic converter ..... 139
  - Central locking system ..... 24
  - Centre high-mounted brake light 177
  - Changing tyre and wheel size ... 190
  - Charging system ..... 97
  - Child locks ..... 30



Child restraint installation		DEF.....	140	Electronic climate control system	118
locations .....	66	Demisting and defrosting.....	15	Electronic data recording.....	41
Child restraints.....	64	Diesel exhaust fluid.....	140	Electronic key system.....	21
Child restraint systems .....	64	Diesel fuel.....	159	Electronic Stability Control . .	98, 149
Cigarette lighter .....	88	Diesel fuel filter .....	173	Electronic Stability Control off.....	98
Cleaning the vehicle.....	200	Diesel fuel system bleeding .....	173	Electronic stability program	149, 163
Climate control .....	15	Diesel particle filter .....	139	End-of-life vehicle recovery .....	166
Climate control systems.....	116	Directional tyres.....	186, 195	Engine air filter.....	168
Clock .....	86	Distance to service.....	92	Engine air flow indicator.....	168
Coat hooks.....	73	Document tray.....	73	Engine coolant .....	169
Coin holder.....	71	Door locks.....	24	Engine coolant temperature .....	98
Control indicators.....	92	Door open .....	101	Engine drag torque control.....	149
Control of the vehicle .....	130	Door panel storage.....	74	Engine exhaust .....	139
Controls.....	83	Doors.....	31	Engine identification.....	207
Controls in steering wheel.....	83	Double cab.....	74	Engine oil .....	167, 204, 208
Convex shape .....	39	DPF (diesel particle filter).....	139	Engine oil additives.....	204
Coolant.....	169	Driver assistance systems.....	151	Engine oil level .....	104
Coolant and antifreeze.....	204	Driver Information Centre .....	101	Engine oil pressure .....	99
Coolant heater.....	122	Driving characteristics and		Engine oil viscosity grades.....	204
Cooling (A/C).....	117	towing tips .....	162	Enhanced traction function.	148, 149
Cornering lights.....	110	Driving economically.....	129	Entry lighting .....	114
Cruise control .....	101, 151	Driving hints.....	129, 130	Event data recorders.....	218
Cupholders .....	73	Driving style indicator.....	91	Exhaust gases.....	139, 198
Curtain airbag system .....	62			Exit lighting .....	114
<b>D</b>		<b>E</b>		Exterior care .....	200
Danger, Warnings and Cautions . . .	4	ECO mode.....	129	Exterior light .....	100
Dashboard.....	10	ecoScoring.....	104	Exterior lighting .....	12, 108
Daytime running lights.....	109, 110	Electric adjustment .....	39	Exterior mirrors.....	39
Declaration of conformity.....	214	Electrical accessories.....	87		
		Electrical system.....	181		

**F**

Fault messages.....	102
First aid kit .....	80
Fixed air vents .....	128
Fog lights.....	111
Fog tail light .....	179
Folding centre seatback.....	73
Folding front centre passenger seat.....	48
Folding mirrors .....	39
Foot well lights.....	112
Front airbag system .....	61
Front courtesy lights.....	112
Front door pockets.....	74
Front fog lights .....	101, 111, 176
Front reading light.....	114
Front seats.....	45
Front storage.....	73
Front turn lights .....	176
Fuel cut-off system.....	134
Fuel economy gauge.....	91
Fuel economy mode.....	100
Fuel economy rating.....	102, 104
Fuel for diesel engines .....	159
Fuel gauge .....	90
Fuel tank.....	212
Fuse box.....	182
Fuses .....	181

**G**

Gauges.....	89
Gear shifting.....	98
General information .....	162
Glovebox .....	72
Glovebox cooler .....	128
Glove box lighting.....	114
Grab handles.....	76

**H**

Hand brake.....	146
Hand brake - see Parking brake.	147
Hazard warning flashers .....	111
Headlight flash .....	109
Headlight range adjustment .....	109
Headlights.....	108, 109, 175
Headlights when driving abroad	110
Head restraint adjustment .....	8
Head restraints .....	44
Heated exterior mirrors.....	15
Heated mirrors .....	40
Heated rear window.....	15, 43
Heating .....	48
Heating and ventilation system .	116
Heat-reflecting windscreen.....	41
High beam .....	100, 109
Hill start assist .....	147
Horn .....	14, 83

**I**

Identification plate .....	207
Idle speed control.....	134
Ignition switch positions .....	131
Immobiliser .....	38
Indicators.....	89
Info Display.....	102
Information displays.....	101
Infotainment system.....	102
Initial drive information.....	6
Instrument cluster .....	89
Instrument panel fuse box .....	182
Instrument panel illumination .....	181
Instrument panel illumination control .....	112
Instrument panel overview .....	10
Instrument panel storage.....	71
Instrument panel tray.....	71
Interior care .....	202
Interior lighting.....	112
Interior lights .....	112, 180
Interior mirrors.....	40
Introduction .....	3
ISOFIX.....	64

**J**

Jack.....	185
Journey record.....	104
Jump starting .....	197

- K**  
 Keys ..... 19  
 Keys, locks..... 19
- L**  
 Lashing eyes ..... 77  
 Lashing straps..... 77  
 Laying up the vehicle..... 165, 171  
 LED spotlights..... 112  
 Light covers, misted..... 112  
 Lighting..... 108  
 Lighting features..... 114  
 Light switch ..... 108  
 Load compartment ..... 33, 76  
 Load compartment cover ..... 77  
 Load compartment grille..... 79  
 Load compartment lighting..... 114  
 Loading information ..... 80  
 Load-through feature..... 74  
 Low fuel ..... 100  
 Luggage floor net..... 77
- M**  
 Malfunction indicator light ..... 97  
 Manual adjustment ..... 39  
 Manual anti-dazzle ..... 40  
 Manual transmission ..... 145  
 Maximum speed limiter..... 153  
 Messages..... 102  
 Mirror adjustment ..... 8
- Mirrors..... 39, 40  
 Misted light covers ..... 112
- N**  
 New vehicle running-in ..... 131  
 Number plate light ..... 179
- O**  
 Object detection systems..... 154  
 Odometer ..... 90  
 Oil..... 167  
 Oil, engine..... 167, 204, 208  
 Oil pressure..... 99  
 Outside temperature ..... 85  
 Overcab storage ..... 76  
 Overrun cut-off ..... 135
- P**  
 Parking ..... 18, 138  
 Parking assist ..... 154  
 Parking brake ..... 147  
 Parking distance control..... 154  
 Parking heater..... 122  
 Particulate filter..... 139  
 Pedals..... 130  
 Performing work ..... 166  
 Phone controls..... 83  
 Phone holder..... 71  
 Power button..... 17, 131  
 Power outlets ..... 87  
 Power steering fluid..... 169
- Power windows ..... 42  
 Preheating ..... 99, 133  
 Puncture..... 194
- R**  
 Radio Frequency Identification  
 (RFID)..... 221  
 Radio remote control ..... 20  
 REACH..... 218  
 Reading lights ..... 114  
 Rear air conditioning system .... 121  
 Rear courtesy lights..... 112  
 Rear door manual lock..... 24  
 Rear doors..... 24, 31  
 Rear fog light ..... 101, 112  
 Rear heating system ..... 120  
 Rear parcel shelf..... 77  
 Rear seats ..... 49  
   2nd row seats..... 49  
   3rd row seats..... 49  
   Folding..... 49  
   Installing..... 49  
   Rear seat access..... 49  
   Removing..... 49  
   Seat cushion adjustment..... 49  
 Rear seats lights..... 112  
 Rear view camera ..... 157  
 Rear windows ..... 42  
 Rear window wiper and washer . . 85

Recommended fluids and lubricants .....	204, 208
Refuelling .....	160
Registered trademarks.....	218
Remote control.....	20
Restraining lattice.....	79
Reversing light .....	178
Reversing lights .....	112
Ride control systems.....	148
Roof load.....	80
Roof rack .....	80

## S

Safety belts.....	53
Safety net .....	78
Seat adjustment .....	7, 46
Seat belt .....	8
Seat belt reminder .....	96
Seat belts .....	53
Seat folding .....	48
Seat heating.....	48
Seat position .....	45
Seats.....	74
Selective catalytic reduction.....	140
Service .....	128, 203
Service display .....	92
Service information .....	203
Service vehicle soon .....	97
Side airbag system .....	61
Sidelights.....	108

Side turn lights .....	177
Sliding door .....	31
Sliding side door.....	31
Spare wheel .....	195
Spare wheel security tool.....	185
Speed limiter.....	89, 101, 153
Speedometer .....	89
Starting and operating.....	131
Starting off .....	17
Starting the engine.....	17, 133
Steering.....	130
Steering column controls.....	83
Steering wheel adjustment .....	9, 83
Steering wheel controls .....	83
Stop engine.....	97
Stop-start system.....	17, 100, 135
Storage.....	71
Storage box.....	74
Storage compartment.....	73
Storage compartments.....	71
Sun visors .....	43
Symbols .....	4

## T

Tablet holder.....	71
Tachograph.....	101, 106
Tachometer .....	90
Tailgate.....	33
Tailgate emergency release.....	33
Tail lights .....	176

Temporary spare wheel.....	195
Three-point seat belt .....	54
Toll road stickers.....	41
Tools .....	185
Top-Tether.....	64
Torx key.....	185
Touchscreen.....	102
Tow bar.....	162
Towing.....	162, 198
Towing another vehicle .....	199
Towing a trailer.....	162
Towing eye.....	185, 198
Towing the vehicle .....	198
Traction Control system .....	148
Trailer coupling.....	162
Trailer stability assist .....	163
Trailer towing .....	162
Transmission .....	16
Tread depth .....	189
Trip computer .....	104
Trip odometer .....	90
Turbo engine warm-up.....	133
Turn lights .....	95, 111
Tyre chains .....	190
Tyre changing.....	194
Tyre designations .....	186
Tyre pressure .....	186
Tyre pressure monitoring system.....	99, 188
Tyre pressures .....	213

Tyre repair kit .....	191
Tyres .....	186
Tyres and wheel size, changing. ....	190

## U

Ultrasonic parking assist.....	154
Underseat storage .....	74
Upholstery.....	202
USB socket.....	87
Using this manual .....	3

## V

Vehicle battery .....	171, 197
Vehicle checks.....	166
Vehicle data.....	208
Vehicle data recording and privacy.....	218
Vehicle dimensions .....	209
Vehicle Identification Number ....	206
Vehicle jack.....	185
Vehicle messages .....	102
Vehicle security.....	35
Vehicle shutdown .....	134
Vehicle specific data .....	3
Vehicle storage.....	165
Vehicle tools.....	185, 198
Vehicle unlocking .....	6
Ventilation.....	116

## W

Warning chimes .....	103
Warning lights.....	89
Warning messages.....	102
Warning triangle .....	80
Washer and wiper systems .....	14
Washer fluid .....	170
Washing the vehicle.....	200
Welcome lighting.....	114
Wheel changing .....	194
Wheel cover hook.....	185
Wheel covers .....	190
Wheels and tyres .....	186
Wheel wrench.....	185
Wide view mirror.....	40
Windows.....	41, 42
Windscreen.....	41
Windscreen stickers.....	41
Windscreen wiper and washer ....	84
Winter tyres .....	186
Wiper blade replacement .....	174



Copyright by Vauxhall Motors Ltd.

The information contained in this publication is effective as of the date indicated below. Vauxhall Motors Ltd. reserves the right to make changes to the technical specifications, features and design of the vehicles relative to the information contained in this publication, as well as changes to the publication itself.

Edition: August 2018, Vauxhall Motors Ltd.

Printed on chlorine-free bleached paper.

**ID-VVIBORIE1808-en**

