

21 May 2021 | Model Year 2021

MY 2021



Car Range

Price Guide

Price and Specification Guide
7 April 2021 | Model Year 2021D



All-new Corsa

Contents

To find the information you want use the links below to navigate around the guide:

[Choose your Trim Level](#)

[Range Highlights](#)

[Models](#)

[Prices](#)

[Features/Options](#)

[Infotainment](#)

[Interior Style and Comfort](#)

[Exterior Colours](#)

[Wheels and Tyres](#)

[Engines and Technical Data](#)

[Performance, Economy and Emissions](#)

[Specifications](#)

[Dimensions and Capacities](#)

[Accessories](#)

[Company Car Information](#)

[Further Information](#)

Choose Your Trim Level

SE

VX_COR_31867



First in the line-up is the wonderfully well-equipped SE.

Corsa-e SE Nav Premium

Say hello to the new Corsa-e. It's 100% electric, 100% exciting.

Griffin Edition

VX_COR_31863



Griffin Edition is the high-spec, great looking model that's available at a competitive monthly payment.

SRi

VX_COR_31868



This sporty number also comes with a Premium version available; SRi and SRi Premium.

Corsa-e SRi Nav Premium

For even more style in your Corsa-e.

Elite Edition

VX_COR_32012



For even more features, designed to be the trim for 'comfort'. Elite Nav Premium gives you even more features; Elite Edition and Elite Nav Premium.

Corsa-e Elite Nav Premium

Step inside for a bigger touchscreen and more comfort with heated seats and steering wheel.

Ultimate Nav

VX_COR_31866



All you could ask for; our range-topping Ultimate Nav model completes the range.

All-new Corsa Range Highlights

SE

Standard features include:

- 7-inch colour touchscreen
- Multimedia infotainment system
- LED headlights with high beam assist
- 16-inch silver 8-spoke alloy wheels
- Air conditioning
- Cruise control with intelligent speed limiter
- Trip computer
- Driver's seat height adjuster
- Body-colour front and rear bumpers
- Remote control central locking
- Electrically operated front and rear windows
- Electrically adjustable/heated door mirrors
- Lane departure warning with lane assist
- Speed sign recognition
- Leather-covered flat-bottom steering wheel
- Driver drowsiness system
- Automatic emergency city braking
- Anti-lock Braking System (ABS)
- Six airbags
- 60/40 split-folding rear seat back
- Electric parking brake (auto models only)
- Paddle shift (auto models only)

Griffin Edition

Features over SE models:

- 7-inch digital instrument cluster
- Heated front seats
- Heated steering wheel (excluding auto models)
- Rain-sensitive windscreen wipers
- Automatic lighting control
- Automatic anti-dazzle rear-view mirror
- Front passenger's seat height adjuster
- Centre armrest with storage
- Fabric/premium leather-effect seat trim
- Panoramic rear-view camera
- Front and rear parking distance sensors
- Electrically folding door mirrors
- Black roof and A-pillars
- High gloss black B-pillars
- Dark-tinted rear windows
- Chrome-effect lower side window trim
- 17-inch diamond-cut gloss black 5-twinspoke alloy wheels
- Remote control security alarm system
- Front and rear floor mats (front Griffin-branded)

SRI

Features over SE models:

- 7-inch digital instrument cluster
- Sports front and rear body styling
- Alloy-effect sports pedals
- Sport switch
- Sports-style front seats
- LED tail lights
- LED front fog lights
- Chrome-effect exhaust tailpipe extension
- Black roof and A-pillars
- High gloss black B-pillars
- Dark-tinted rear windows
- Rear parking distance sensors
- 17-inch diamond-cut gloss black 5-twinspoke alloy wheels
- Remote control security alarm system
- Rain-sensitive windscreen wipers
- Automatic lighting control
- Automatic anti-dazzle rear-view mirror
- Black headliner
- Electric parking brake (all models)

Elite Edition

Features over SE models:

- 7-inch digital instrument cluster
- Heated front seats
- Heated steering wheel (excluding auto models)
- Rain-sensitive windscreen wipers
- Automatic lighting control
- Automatic anti-dazzle rear-view mirror
- Front passenger's seat height adjuster
- Centre armrest with storage
- Fabric/premium leather-effect seat trim
- Panoramic rear-view camera
- Front and rear parking distance sensors
- Electrically folding door mirrors
- Black roof and A-pillars
- High gloss black B-pillars
- Dark-tinted rear windows
- Chrome-effect lower side window trim
- 17-inch diamond-cut gloss black 5-twinspoke alloy wheels
- Remote control security alarm system

Ultimate Nav

Features over Elite Edition models:

- Multimedia Navi Pro infotainment system – Rear USB connection
- 10-inch colour touchscreen
- Electronic climate control
- Perforated leather seat trim inserts
- Driver's seat with massage function
- IntelliLux LED® Matrix headlights with LED tail lights
- Adaptive cruise control
- Keyless entry and start
- Electric parking brake (all models)
- Lane positioning assistant
- Black headliner
- Vauxhall Connect

All-new Corsa-e Range Highlights

SE Nav Premium

Standard features include:

- Multimedia Navi infotainment system
- 7-inch colour touchscreen
- Electronic climate control
- Rain-sensitive windscreen wipers
- Automatic lighting control
- Automatic anti-dazzle rear-view mirror
- Electric parking brake
- Rear parking distance sensors
- Keyless start
- 16-inch bi-colour alloy wheels
- High gloss black B-pillars
- Remote control security alarm system
- LED headlights with high beam assist
- Cruise control with intelligent speed limiter
- Trip computer
- Driver's seat height adjuster
- Body-colour front and rear bumpers
- Remote control central locking
- Electrically operated front and rear windows
- Electrically adjustable/heated door mirrors
- Lane departure warning with lane assist
- Speed sign recognition
- Leather-covered flat-bottom steering wheel
- Driver drowsiness system
- Automatic emergency city braking
- Anti-lock Braking System (ABS)
- Six airbags
- 60/40 split-folding rear seat back
- Vauxhall Connect
- 7-inch digital instrument cluster

SRI Nav Premium

Features over SE Nav Premium models:

- Sports style front seats
- Black headliner
- Alloy-effect sports pedals
- LED tail lights
- Black roof and A-pillars
- Dark tinted rear windows
- 17-inch bi-colour alloy wheels

Elite Nav Premium

Features over SE Nav Premium models:

- Multimedia Navi Pro infotainment system
- 10-inch colour touchscreen
- IntelliLux LED® Matrix headlights
- Keyless entry and start
- 17-inch bi-colour alloy wheels
- Heated front seats
- Heated steering wheel
- Front passenger's seat height adjuster
- Centre armrest with storage
- Fabric/premium leather-effect seat trim
- Panoramic rear-view camera
- Front and rear parking distance sensors
- Electrically folding door mirrors
- Black roof and A-pillars
- Dark-tinted rear windows
- Chrome-effect lower side window trim

All-new Corsa SE

VX_COR_31867



SE

OTR from £16,815

Infotainment:

- Multimedia system
 - 7-inch colour touchscreen
 - AM/FM/DAB digital radio
 - Bluetooth® audio streaming
 - Bluetooth® mobile phone portal
 - Apple CarPlay/Android Auto™
 - USB audio connection
- Six speakers

Interior convenience/styling:

- Air conditioning
- Flat-bottomed leather-covered steering wheel
- Cruise control with intelligent speed limiter
- Trip computer
- Speed-sensitive power-assisted steering
- Steering column adjustable for reach/rake
- Steering wheel audio/phone/cruise controls
- Driver's seat height adjuster
- 60/40 split-folding rear seat back
- Electric parking brake (auto models only)
- Paddle shift (auto models only)

Exterior convenience/styling:

- LED headlights
- High beam assist
- 16-inch silver 8-spoke alloy wheels
- Remote control central locking
- Electrically operated front and rear windows
- Electrically adjustable/heated door mirrors
- Body-colour front and rear bumpers

Safety/security:

- Lane departure warning with lane assist
- Speed sign recognition
- Automatic emergency city braking
- Hill start assist
- ISOFIX child seat fixings on outer rear seats

All-new Corsa Griffin Edition

VX_COR_31863



Griffin Edition

OTR from
£18,530

Infotainment:

- Multimedia system
 - 7-inch colour touchscreen
 - AM/FM/DAB digital radio
 - Bluetooth® audio streaming
 - Bluetooth® mobile phone portal
 - Apple CarPlay/Android Auto™
 - USB audio connection
- Six speakers

Interior convenience/styling:

- Air conditioning
- Flat-bottomed leather-covered steering wheel
- Heated front seats and steering wheel (excluding auto models)
- Rain-sensitive windscreen wipers
- Automatic lighting control
- Automatic anti-dazzle rear-view mirror
- Driver's and front passenger's seat height adjuster
- Centre armrest with storage
- Fabric/premium leather-effect seat trim
- Electric parking brake (auto models only)
- 7-inch digital instrument cluster
- Paddle shift (auto models only)
- Front and rear floor mats (front Griffin-branded)

Exterior convenience/styling:

- LED headlights
- High beam assist
- 17-inch diamond-cut gloss black 5-twinspoke alloy wheels
- Panoramic rear-view camera
- Front and rear parking distance sensors
- Electrically adjustable/folding/heated door mirrors
- Remote control central locking
- Electrically operated front and rear windows
- LED front fog lights
- Black roof and A-pillars
- High gloss black B-pillars
- Dark-tinted rear windows
- Chrome-effect lower side window trim

Safety/security:

- Lane departure warning with lane assist
- Traffic sign recognition with intelligent speed adaptation
- Automatic emergency city braking
- Remote control security alarm system
- ISOFIX child seat fixings on outer rear seats

All-new Corsa SRi

VX_COR_31868



SRi OTR from £20,065

Infotainment:

- Multimedia system
 - 7-inch colour touchscreen
 - AM/FM/DAB digital radio
 - Bluetooth® audio streaming
 - Bluetooth® mobile phone portal
 - Apple CarPlay/Android Auto™
 - USB audio connection
- Six speakers

Interior convenience/styling:

- Air conditioning
- Flat-bottomed leather-covered steering wheel
- Steering column adjustable for reach/rake
- Steering wheel audio/phone/cruise controls
- Sport switch
- Sports-style front seats
- 7-inch digital instrument cluster
- Rain-sensitive windscreen wipers
- Automatic lighting control
- Automatic anti-dazzle rear-view mirror
- Black headliner
- Alloy-effect sports pedals
- Paddle shift (auto models only)
- Electric parking brake

Exterior convenience/styling:

- LED head and tail lights
- LED front fog lights
- High beam assist
- 17-inch diamond-cut gloss black 5-twin-spoke alloy wheels
- Remote control central locking
- Electrically operated front and rear windows
- Electrically adjustable/heated door mirrors
- Chrome-effect exhaust tailpipe extension
- Black roof and A-pillars
- High gloss black B-pillars
- Dark-tinted rear windows
- Rear parking distance sensors

Safety/security:

- Lane departure warning with lane assist
- Speed sign recognition
- Automatic emergency city braking
- Remote control security alarm system
- ISOFIX child seat fixings on outer rear seats

SRi Premium OTR from £21,030

Features over SRi

- Heated front seats and steering wheel (excluding auto models)
- Electronic climate control
- Electrically folding door mirrors
- Keyless entry and start

All-new Corsa Elite Edition

VX_COR_32012



Elite Edition model illustrated.

Elite Edition OTR from £18,730

Infotainment:

- Multimedia system
 - 7-inch colour touchscreen
 - AM/FM/DAB digital radio
 - Bluetooth® audio streaming
 - Bluetooth® mobile phone portal
 - Apple CarPlay/Android Auto™
 - USB audio connection
- Six speakers

Interior convenience/styling:

- Air conditioning
- Flat-bottomed leather-covered steering wheel
- Heated front seats and steering wheel (excluding auto models)
- Rain-sensitive windscreen wipers
- Automatic lighting control
- Automatic anti-dazzle rear-view mirror
- Driver's and front passenger's seat height adjuster
- Centre armrest with storage
- Fabric/premium leather-effect seat trim
- Electric parking brake (auto models only)
- 7-inch digital instrument cluster
- Paddle shift (auto models only)

Exterior convenience/styling:

- LED headlights
- High beam assist
- 17-inch diamond-cut gloss black 5-twinspoke alloy wheels
- Panoramic rear-view camera
- Front and rear parking distance sensors
- Electrically adjustable/folding/heated door mirrors
- Remote control central locking
- Electrically operated front and rear windows

- LED front fog lights
- Black roof and A-pillars
- High gloss black B-pillars
- Dark-tinted rear windows
- Chrome-effect lower side window trim

Safety/security:

- Lane departure warning with lane assist
- Traffic sign recognition with intelligent speed adaptation
- Automatic emergency city braking
- Remote control security alarm system
- ISOFIX child seat fixings on outer rear seats

Elite Nav Premium

OTR from
£21,850

Features over Elite Edition

- Multimedia Navi Pro system
 - 10-inch colour touchscreen
 - Satellite navigation system
 - 2D/3D street level mapping
 - European coverage
 - Points-of-interest search
- Keyless entry and start
- Electronic climate control
- Electric parking brake
- Vauxhall Connect

This vehicle is covered by our Price Protection Guarantee. See 'Further Information' page for details.

All-new Corsa Ultimate Nav

VX_COR_31866



Ultimate Nav OTR from £25,500

Infotainment:

- Multimedia Navi Pro system
 - Satellite navigation
 - 10-inch colour touchscreen
 - 2D/3D street level mapping
 - European coverage
 - Points-of-interest search
 - AM/FM/DAB digital radio
 - Bluetooth® audio streaming
 - Bluetooth® mobile phone portal
 - Apple CarPlay/Android Auto™
 - USB audio connection
 - Rear USB connection
- Six speakers
- Vauxhall Connect

Interior convenience/styling:

- Electronic climate control
- Black headliner
- Flat-bottomed leather-covered steering wheel
- Heated front seats
- Rain-sensitive windscreen wipers
- Automatic lighting control
- Automatic anti-dazzle rear-view mirror
- Steering column adjustable for reach/rake
- Steering wheel audio/phone/cruise controls
- Alcantara seat trim
- Driver's seat with massage function
- Driver's and front passenger's seat height adjuster
- Centre armrest with storage
- 60/40 split-folding rear seat back
- Electric parking brake
- 7-inch digital instrument cluster
- Paddle shift (auto models only)

Exterior convenience/styling:

- IntelliLux LED® Matrix headlights with LED tail lights
- High beam assist
- 17-inch diamond-cut gloss black 5-twinspoke alloy wheels
- Panoramic rear-view camera
- Front and rear parking distance sensors
- Electrically adjustable/folding/heated door mirrors
- Remote control central locking
- Electrically operated front and rear windows
- LED front fog lights
- Black roof and A-pillars
- High gloss black B-pillars
- Dark-tinted rear windows
- Keyless entry and start
- Chrome-effect lower side window trim

Safety/security:

- Adaptive cruise control
- Automatic emergency braking
- Lane positioning assistant
- Traffic sign recognition with intelligent speed adaptation
- Driver drowsiness system
- LED daytime running lights
- Remote control security alarm system
- ISOFIX child seat fixings on outer rear seats

Effective 7 April 2021

All-new Corsa Model Year 2021D

All-new Corsa-e SE Nav Premium

VX_COR_e_31860



SE Nav
Premium

OTR from
£27,140*

Infotainment:

- Multimedia Navi system
 - Satellite navigation
 - 7-inch colour touchscreen
 - 2D/3D street level mapping
 - European coverage
 - Points-of-interest search
 - AM/FM/DAB digital radio
 - Bluetooth® audio streaming
 - Bluetooth® mobile phone portal
 - Apple CarPlay/Android Auto™
 - USB audio connection
- Six speakers
- Vauxhall Connect

Interior convenience/styling:

- Electronic climate control
- Flat-bottomed leather-covered steering wheel
- Rain-sensitive windscreen wipers
- Automatic lighting control
- Automatic anti-dazzle rear-view mirror
- Cruise control with speed limiter
- Trip computer
- Speed-sensitive power-assisted steering
- Steering column adjustable for reach/rake
- Steering wheel audio/phone/cruise controls
- Driver's seat height adjuster
- 60/40 split-folding rear seat back
- Electric parking brake
- 7-inch digital instrument cluster

Exterior convenience/styling:

- LED headlights
- High beam assist
- 16-inch bi-colour alloy wheels
- High gloss black B-pillars
- Remote control central locking
- Electrically operated front and rear windows
- Electrically adjustable/heated door mirrors
- Body-colour front and rear bumpers
- Rear parking distance sensors
- Keyless start

Safety/security:

- Lane departure warning with lane assist
- Speed sign recognition
- Driver drowsiness system
- Hill start assist
- Remote control security alarm system
- Automatic emergency city braking
- ISOFIX child seat fixings on outer rear seats

*Price shown is after allowing for PiCG (Plug-in Car Grant).

All-new Corsa-e SRi Nav Premium

VX_COR_e_31861



**SRi Nav
Premium**

**OTR from
£28,390***

Infotainment:

- Multimedia Navi system
 - Satellite navigation
 - 7-inch colour touchscreen
 - 2D/3D street level mapping
 - European coverage
 - Points-of-interest search
 - AM/FM/DAB digital radio
 - Bluetooth® audio streaming
 - Bluetooth® mobile phone portal
 - Apple CarPlay/Android Auto™
 - USB audio connection
- Six speakers
- Vauxhall Connect

Interior convenience/styling:

- Sports-style front seats
- Black headliner
- Alloy-effect sports pedals
- Electronic climate control
- Flat-bottomed leather-covered steering wheel
- Rain-sensitive windscreen wipers
- Automatic lighting control
- Automatic anti-dazzle rear-view mirror
- Cruise control with speed limiter
- Trip computer
- Speed-sensitive power-assisted steering
- Steering column adjustable for reach/rake
- Steering wheel audio/phone/cruise controls
- Driver's seat height adjuster
- 60/40 split-folding rear seat back
- Electric parking brake
- 7-inch digital instrument cluster

Exterior convenience/styling:

- LED headlights and tail lights
- High beam assist
- 17-inch bi-colour alloy wheels
- Remote control central locking
- Electrically operated front and rear windows
- Electrically adjustable/heated door mirrors
- Body-colour front and rear bumpers
- Rear parking distance sensors
- Keyless start
- Black roof and A-pillars
- High gloss black B-pillars
- Dark-tinted rear windows

Safety/security:

- Lane departure warning with lane assist
- Speed sign recognition
- Driver drowsiness system
- Hill start assist
- Remote control security alarm system
- Automatic emergency city braking
- ISOFIX child seat fixings on outer rear seats

*Price shown is after allowing for PiCG (Plug-in Car Grant).

All-new Corsa-e Elite Nav Premium

VX_COR_e_31862



**Elite Nav
Premium**

**OTR from
£30,545***

Infotainment:

- Multimedia Navi Pro system
 - Satellite navigation
 - 10-inch colour touchscreen
 - 2D/3D street level mapping
 - European coverage
 - Points-of-interest search
 - AM/FM/DAB digital radio
 - Bluetooth® audio streaming
 - Bluetooth® mobile phone portal
 - Apple CarPlay/Android Auto™
 - USB audio connection
- Six speakers
- Vauxhall Connect

Interior convenience/styling:

- Electronic climate control
- Flat-bottomed leather-covered steering wheel
- Heated front seats and steering wheel
- Rain-sensitive windscreen wipers
- Automatic lighting control
- Automatic anti-dazzle rear-view mirror
- Driver's and front passenger's seat height adjuster
- Centre armrest with storage
- Fabric/premium leather-effect seat trim
- Electric parking brake
- 7-inch digital instrument cluster

Exterior convenience/styling:

- IntelliLux LED® Matrix headlights with LED tail lights
- High beam assist with anti-glare
- 17-inch bi-colour diamond-cut alloy wheels
- Panoramic rear-view camera
- Front and rear parking distance sensors
- Electrically adjustable/folding/heated door mirrors
- Remote control central locking
- Electrically operated front and rear windows
- LED front fog lights
- Black roof and A-pillars
- High gloss black B-pillars
- Dark-tinted rear windows
- Keyless entry and start
- Chrome-effect lower side window trim

Safety/security:

- Lane departure warning with lane assist
- Traffic sign recognition
- Driver drowsiness system
- Remote control security alarm system
- Automatic emergency city braking
- ISOFIX child seat fixings on outer rear seats

*Price shown is after allowing for PiCG (Plug-in Car Grant).

All-new Corsa Prices

	Pack Code	Fuel Type	Price (£)	VAT (£)	Total (£)	On-the-road RRP (£)	Financial Year 2021/22 BiK 20% (£)	WLTP Combined CO ₂ (g/km)* - pack code	Insurance groups
SE									
1.2 (75PS)	AC48 ED11	Petrol	13,233.33	2,646.67	15,880.00	16,815.00	74.60	118	10E
1.2 (100PS) Turbo	AC48 EU61	Petrol	13,983.33	2,796.67	16,780.00	17,715.00	78.65	117	16E
1.2 (100PS) Turbo auto	AC48 EE81	Petrol	15,425.00	3,085.00	18,510.00	19,445.00	89.63	121	16E
1.5 (102PS) Turbo D	AC48 HT61	Diesel	14,908.33	2,981.67	17,890.00	18,805.00	77.45	105	tba
Griffin Edition									
1.2 (75PS)	AE48 ED1X	Petrol	14,662.50	2,932.50	17,595.00	18,530.00	85.37	121	12E
1.2 (100PS) Turbo	AE48 EU6X	Petrol	15,412.50	3,082.50	18,495.00	19,430.00	89.57	120	18E
1.2 (100PS) Turbo auto	AE48 EE8X	Petrol	16,854.17	3,370.83	20,225.00	21,160.00	97.63	123	17E
1.5 (102PS) Turbo D	AE48 HT6X	Diesel	16,337.50	3,267.50	19,605.00	20,520.00	84.60	107	19E
SRI									
1.2 (100PS) Turbo	AL48 EU61	Petrol	15,941.67	3,188.33	19,130.00	20,065.00	89.23	119	17E
1.2 (130PS) Turbo auto	AL48 EF81	Petrol	18,191.67	3,638.33	21,830.00	22,765.00	105.13	123	22E
1.5 (102PS) Turbo D	AL48 HT61	Diesel	16,866.67	3,373.33	20,240.00	21,155.00	87.23	107	18E
SRI Premium									
1.2 (100PS) Turbo	AL48 EU6X	Petrol	16,745.83	3,349.17	20,095.00	21,030.00	97.03	120	17E
1.2 (130PS) Turbo auto	AL48 EF8X	Petrol	18,995.83	3,799.17	22,795.00	23,730.00	109.63	123	22E
1.5 (102PS) Turbo D	AL48 HT6X	Diesel	17,670.83	3,534.17	21,205.00	22,120.00	91.27	107	18E

Corsa's petrol and diesel engines meet the Real Driving Emissions Step 2 (RDE2) standards.

WLTP Combined CO₂ (g/km) figures are based on a configured vehicle as per pack code for UK with no options fitted.

*Provisional fuel consumption and CO₂ figures are determined according to the WLTP test cycle. CO₂ figures, BiK values and RRP pricing shown above are for a standard vehicle without any additional optional equipment. CO₂ figures are used to calculate Vehicle Excise Duty (VED) for the first registration of the vehicle and BiK. The addition of optional extras could increase the certified CO₂ emission output. This in turn may affect the amount of VED payable upon registration, and, for company car drivers, the P11D value and the amount of Benefit in Kind (BiK) tax payable. Figures shown are for comparison purposes and should only be compared to the fuel consumption and CO₂ values of other cars tested to the same technical standard. The fuel consumption achieved, and CO₂ produced, in real world conditions will depend upon a number of factors including, but not limited to: the accessories fitted (pre and post registration); variations in weather; driving styles and vehicle load. The WLTP (Worldwide Harmonised Light Vehicles Test Procedure) is used to measure fuel consumption and CO₂ figures. Full data relating to WLTP test cycles can be found at: www.vauxhall.co.uk/wltp

Please note: On-the-road recommended retail prices (RRP) include number plates and delivery to Retailer of £700.00 (inc. £116.67 VAT), 12 months' Vehicle Excise Duty and new vehicle first registration fee of £55.00. Excludes fuel and insurance. Company Car Benefit in Kind (BiK) rates are monthly based on the standard paint price.

All-new Corsa Prices

	Pack Code	Fuel Type	Price (£)	VAT (£)	Total (£)	On-the-road RRP (£)	Financial Year 2021/22 BiK 20% (£)	WLTP Combined CO ₂ (g/km) [#] – pack code	Insurance groups
Elite Edition									
1.2 (75PS)	AE48 ED11	Petrol	14,829.17	2,965.83	17,795.00	18,730.00	86.30	121	12E
1.2 (100PS) Turbo	AE48 EU61	Petrol	15,579.17	3,115.83	18,695.00	19,630.00	90.50	120	18E
1.2 (100PS) Turbo auto	AE48 EE81	Petrol	17,020.83	3,404.17	20,425.00	21,360.00	98.57	123	16E
1.5 (102PS) Turbo D	AE48 HT61	Diesel	16,504.17	3,300.83	19,805.00	20,720.00	85.43	107	19E
Elite Nav Premium									
1.2 (100PS) Turbo	AK48 EU6X	Petrol	17,429.17	3,485.83	20,915.00	21,850.00	100.87	120	17E
1.2 (100PS) Turbo auto	AK48 EE8X	Petrol	18,870.83	3,774.17	22,645.00	23,580.00	108.93	123	17E
1.5 (102PS) Turbo D	AK48 HT6X	Diesel	18,354.17	3,670.83	22,025.00	22,940.00	94.68	107	18E
Ultimate Nav									
1.2 (100PS) Turbo	AM48 EU61	Petrol	20,470.83	4,094.17	24,565.00	25,500.00	113.68	119	17E
1.2 (130PS) Turbo auto	AM48 EF81	Petrol	22,837.50	4,567.50	27,405.00	28,340.00	131.15	123	23E

Corsa's petrol and diesel engines meet the Real Driving Emissions Step 2 (RDE2) standards.

WLTP Combined CO₂ (g/km) figures are based on a configured vehicle as per pack code for UK with no options fitted.

[#]Provisional fuel consumption and CO₂ figures are determined according to the WLTP test cycle. CO₂ figures, BiK values and RRP pricing shown above are for a standard vehicle without any additional optional equipment. CO₂ figures are used to calculate Vehicle Excise Duty (VED) for the first registration of the vehicle and BiK. The addition of optional extras could increase the certified CO₂ emission output. This in turn may affect the amount of VED payable upon registration, and, for company car drivers, the P11D value and the amount of Benefit in Kind (BiK) tax payable. Figures shown are for comparison purposes and should only be compared to the fuel consumption and CO₂ values of other cars tested to the same technical standard. The fuel consumption achieved, and CO₂ produced, in real world conditions will depend upon a number of factors including, but not limited to: the accessories fitted (pre and post registration); variations in weather; driving styles and vehicle load. The WLTP (Worldwide Harmonised Light Vehicles Test Procedure) is used to measure fuel consumption and CO₂ figures. Full data relating to WLTP test cycles can be found at: www.vauxhall.co.uk/wltp

Please note: On-the-road recommended retail prices (RRP) include number plates and delivery to Retailer of £700.00 (inc. £116.67 VAT), 12 months' Vehicle Excise Duty and new vehicle first registration fee of £55.00. Excludes fuel and insurance. Company Car Benefit in Kind (BiK) rates are monthly based on the standard paint price.

All-new Corsa-e Prices

	Pack Code	Price (£)	VAT (£)	Total (£)	On-the-road RRP before PiCG (£)	On-the-road RRP after PiCG (£)	Financial Year 2021/22 BiK 20% (£)	WLTP Combined CO ₂ (g/km) - pack code	Insurance groups
SE Nav Premium 7.4kW									
Electric Propulsion (136PS) auto	AN48 9CQ1	24,070.83	4,814.17	28,885.00	29,640.00	27,140.00	4.92	0	24E
SE Nav Premium 11kW									
Electric Propulsion (136PS) auto	AN48 9CQX	24,779.17	4,955.83	29,735.00	30,490.00	27,990.00	5.07	0	24E
SRI Nav Premium 7.4kW									
Electric Propulsion (136PS) auto	AP48 9CQ1	25,112.50	5,022.50	30,135.00	30,890.00	28,390.00	5.13	0	24E
SRI Nav Premium 11kW									
Electric Propulsion (136PS) auto	AP48 9CQX	25,820.83	5,164.17	30,985.00	31,740.00	29,240.00	5.27	0	24E
Elite Nav Premium 7.4kW									
Electric Propulsion (136PS) auto	AX48 9CQ1	26,908.33	5,381.67	32,290.00	33,045.00	30,545.00	5.48	0	25E
Elite Nav Premium 11kW									
Electric Propulsion (136PS) auto	AX48 9CQX	27,616.67	5,523.33	33,140.00	33,895.00	31,395.00	5.63	0	25E

WLTP Combined CO₂ (g/km) figures are based on a configured vehicle as per pack code for UK with no options fitted.

Please note: On-the-road recommended retail prices (RRP) include number plates and delivery to Retailer of £700.00 (inc. £116.67 VAT), 12 months' Vehicle Excise Duty and new vehicle first registration fee of £55.00. Excludes fuel and insurance. Company Car Benefit in Kind (BiK) rates are monthly based on the standard paint price. Price has been calculated using manufacturer estimates and includes a £2,500.00 OZEV grant which has been deducted from the price of the vehicle (OZEV Grant not available in the Isle of Man). The grant is a government incentive and is subject to withdrawal prior to delivery of your vehicle. Retailers may be required to carry out more than one credit check during the course of the order process. You may be required to place a deposit when placing your order with your supplying Retailer.

Corsa-e is not covered by our Price Protection Guarantee. See 'Further Information' page for details.

Safety

Standard Features – The following features are standard across the entire all-new Corsa range.

Airbags

- Driver's airbag
- Front passenger's airbag
- Front seat side-impact airbags
- Full-size curtain airbags

Seating

- Height-adjustable head restraints

Seatbelts

- Inertia-reel lap and diagonal seatbelts
- 'Seatbelt unfastened' audible warning and warning light

Braking

- Automatic emergency city braking – The system works automatically in conjunction with forward collision alert, at speeds between 3mph and 53mph, and detects both vehicles and pedestrians. If no avoiding action is taken by the driver, at speeds below 19mph the system automatically slows the vehicle to a full stop with emergency braking of 0.9g. At speeds from 19mph to 53mph it brakes automatically to reduce speed by a maximum of 14mph – to reduce speed even further the driver must brake him/herself.

- Anti-lock Braking System (ABS)
- Emergency brake assist – When emergency braking is detected the vehicle automatically applies the maximum possible braking assistance.
- Electronic brakeforce distribution – Automatically apportions the optimum braking force to each wheel.
- Hill start assist – Briefly maintains rear brake pressure to stop the vehicle rolling back when pulling away on an incline.

Child Safety

- Deactivation switch for front passenger's airbag
- ISOFIX child seat mountings incorporating top tether anchor points located on outer rear seats (does not include child seat) – Allows ISOFIX child safety seats to be securely fixed into the car. The ISOFIX mounting system reduces forward movement in an accident and makes the child seat easier to install.
- Child-proof locks on rear doors
- Bonnet/headlight/wiper structure – Designed to reduce pedestrian head and upper body injuries.
- Upper and lower bumper design – Reduces upper and lower leg injuries.

Stability

- Electronic Stability Programme (ESP)
ESP monitors many different inputs to determine when the car starts to lose traction, it can then immediately respond by varying the brake pressure between up to three wheels and adjust the engine output to help correct the loss of traction and improve stability.

Additional ESP features

- Traction control
- Cornering brake control
- Straight line stability control
- Drag torque control – Maintain stability on slippery roads when lifting off the accelerator or changing gear.

Tyre pressure

- Tyre pressure monitoring system

Vauxhall driver assistance systems are intended to support the driver within the system-imminent limitations. The driver remains responsible for the driving task at all times.



Hill start assist.



ISOFIX child seat mountings.

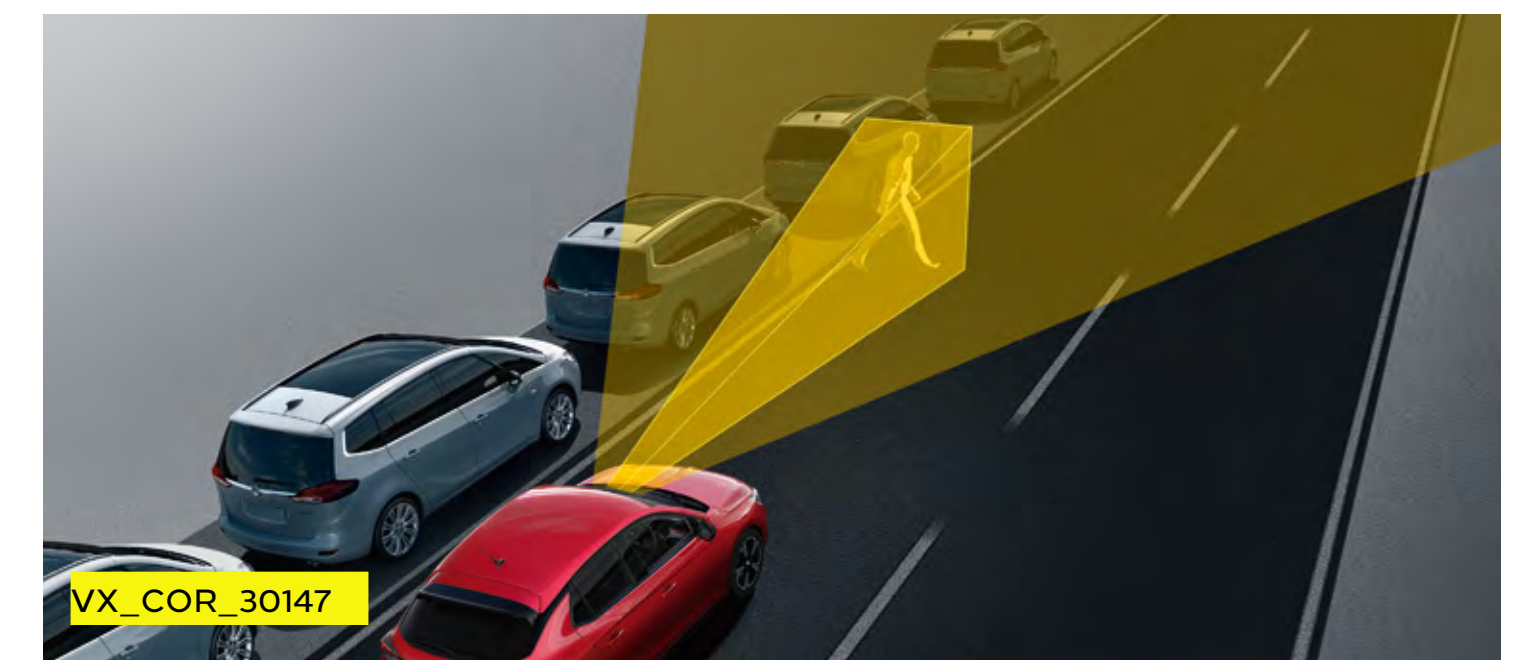

Automatic emergency city braking.

Driver Assistance

Standard Features – The following features are standard across the entire all-new Corsa range. Specific features by model are outlined in the separate tabular information.

Cruise control with speed limiter

With steering wheel mounted controls. Enables you to maintain a constant speed, making it ideal for economical motorway driving.

Front camera system

A range of class-leading driver assistance and safety features are controlled by the front camera system.

Forward collision alert

The system operates automatically from 3mph and gives an audible warning as well as a visual warning when approaching another vehicle too quickly.

Lane departure warning with lane assist

If the driver has not actively steered or signalled, the lane departure warning system provides gentle steering correction and warns when the car moves outside of lane markings at speeds above 40mph.

- Warning light in instrument cluster
- Facia on/off switch

Driver drowsiness system

The system monitors driving time and driving behaviour to help prevent accidents caused by tiredness.

Speed sign recognition

Detects and then displays speed limits, reducing uncertainty and the risk of speeding.

- Recognises different speed signs, including temporary speed restrictions
- Displays reminder in the instrument cluster
- Works in conjunction with the cruise control/speed limiter to help the driver adapt to the recognised speed limit

Model Specific Features

	SE	Griffin Edition	SRi	SRi Premium	Elite Edition	Elite Nav Premium	Ultimate Nav	Electric models		
								SE Nav Premium	SRi Nav Premium	Elite Nav Premium
Driver Assistance										
Rain-sensitive windscreen wipers		●	●	●	●	●	●	●	●	●
Automatic anti-dazzle rear-view mirror		●	●	●	●	●	●	●	●	●
Rear parking distance sensors		●	●	●	●	●	●	●	●	●
Front and rear parking distance sensors		●			●	●	●			●
Panoramic rear-view camera		●			●	●	●			●
Electrically folding door mirrors		●		●	●	●	●			●
Adaptive cruise control							●			
Lane positioning assistant							●			
Electric parking brake – Centre console switch in lieu of handbrake lever	Auto only	Auto only	Auto only	●	Auto only	●	●	●	●	●
Paddle shift	Auto only	Auto only	Auto only	Auto only	Auto only	Auto only	Auto only			

Driver Information and Security

Standard Features – The following features are standard across the entire all-new Corsa range. Specific features by model are outlined in the separate tabular information.

Driver Information

Instrumentation

- Speedometer and rev counter
- Fuel gauge with low fuel level warning light
- Water temperature gauge with warning light
- Shift-up indication light (manual models only) – indicates when to change gear for optimum fuel economy.

Driver information display (centrally located in instrument cluster)

- Service-due indicator
- Deflation detection system

Multi-function trip computer (displayed on driver information display)

- Trip mileage
- Vehicle range based on remaining fuel
- Average speed
- Average fuel economy
- Instantaneous fuel economy

Central facia display (format dependent on infotainment unit)

- Audio information
- Digital clock with automatic RDS time adjustment
- Outside air temperature with ice warning function
- Additional features dependent on infotainment unit (see infotainment for details)

Security

- Electronic engine deadlock immobiliser
- Steering column lock
- Lockable fuel filler flap
- Remote control central door locking
- Two keys – One folding with integral remote

Model Specific Features

	SE	Griffin Edition	SRI	SRI Premium	Elite Edition	Elite Nav Premium	Ultimate Nav	Electric models		
								SE Nav Premium	SRI Nav Premium	Elite Nav Premium
Driver Information										
3.5-inch colour instrument cluster	●									
7-inch digital instrument cluster		●	●	●	●	●	●	●	●	●
Security										
Remote control security alarm system		●	●	●	●	●	●	●	●	●
Keyless start								●	●	
Keyless entry and start				●		●	●			●

Convenience

Standard Features – The following features are standard across the entire all-new Corsa range. Specific features by model are outlined in the separate tabular information.

Interior Convenience

- 12-volt electrical accessory socket
- Driver's and front passenger's sunvisors incorporating vanity mirrors with covers
- Illuminated glovebox with lid
- Interior courtesy light and front map reading lights
- Luggage compartment lighting
- Two-litre open door pockets

Heating and Ventilation

- Cabin particulate filter – removes dust, airborne particles and pollen
- Four-speed fan with illuminated controls
- Four adjustable facia vents
- Windscreen and side window demist vents

Exterior Convenience

- Solar heat-absorbing windscreen
- Two-speed windscreen wipers with variable intermittent wipe
- Electrically operated front and rear windows with safety autoreverse and one-touch facility
- Glazed tailgate with heated window and wash/wipe facility
- Twin electrically adjustable/heated door mirrors
- Remote control central door locking

Model Specific Features/Option

	SE	Griffin Edition	SRi	SRi Premium	Elite Edition	Elite Nav Premium	Ultimate Nav	Electric models		
								SE Nav Premium	SRi Nav Premium	Elite Nav Premium
Interior Convenience										
Front centre armrest with storage		●		●	●	●	●			●
LED ambient lighting		●			●	●	●			●
Rear USB connection							●			
Interior Style										
Black headliner			●	●			●		●	
Heating and Ventilation										
Air conditioning with air recirculation facility	●	●	●		●					
Electronic climate control				●		●	●	●	●	●
Heated front seats and steering wheel*		●		●	●	●	●			●
Exterior Convenience										
Fixed panoramic glass sunroof**			£500	£500	£500	£500	£500	£500	£500	£500

*Heated steering wheel on manual models only. **Optional at extra cost including VAT.

Exterior Style and Lighting

Standard Features – The following features are standard across the entire all-new Corsa range. Specific features by model are outlined in the separate tabular information.

Exterior Styling

- Body-colour front and rear bumpers
- Body-colour door handles and mirror housings
- Chrome logo bar

Exterior Lighting

- LED headlights
- High beam assist
- Lights-on audible warning
- LED daytime running lights
- Headlight levelling system

- Rear fog light
- Rear reversing light
- Centre rear brake light
- Hazard warning lights

Model Specific Features/Options

	SE	Griffin Edition	SRi	SRi Premium	Elite Edition	Elite Nav Premium	Ultimate Nav	Electric models		
								SE Nav Premium	SRi Nav Premium	Elite Nav Premium
Exterior Styling										
Black roof and A-pillars		●	●	●	●	●	●		●	●
Body-colour roof and A-pillars	●	No-cost	No-cost	No-cost	No-cost	No-cost	No-cost	●	No-cost	No-cost
Black lower side window mouldings	●		●	●				●	●	
Chrome-effect lower side window trim		●			●	●	●			●
Sports front and rear body styling			●	●					●	
High gloss black B-pillars		●	●	●	●	●	●	●	●	●
Chrome-effect exhaust tailpipe extension			●	●						
Solar heat-absorbing windows	●							●		
Dark-tinted rear side and tailgate windows		●	●	●	●	●	●		●	●
Exterior Lighting										
Automatic lighting control		●	●	●	●	●	●	●	●	●
LED front fog lights		●	●	●	●	●	●		●	●
Automatic headlight levelling system							●			●
IntelliLux LED® Matrix headlights							●			●
LED tail lights			●	●			●		●	●

Infotainment

Standard Features

Multimedia

Standard on SE, SRi, SRi Premium, Griffin Edition and Elite Edition models

Onboard features:

- 7-inch colour touchscreen
- DAB Digital radio
- RDS with Traffic Programme
- AM/FM stereo radio with 25 station presets
- Six speakers
- 20 watts per channel output

Media connections:

- USB connection with iPod control
- Bluetooth® A2DP audio streaming (Advanced Audio Distribution Profile)

Mobile phone portal:

- Bluetooth® connectivity
- Vehicle microphone
- Handsfree calls via steering wheel controls
- Phone book access – Contacts/last calls/missed calls etc. are mirrored on the display and are easily navigated using the touchscreen (features dependent on mobile phone).

Smartphone interface:

- Apple CarPlay
- Android Auto™
- Smartphone projection that allows operations via voice command, touchscreen and buttons to control apps and music playback.

Additional features:

- Steering wheel-mounted audio controls
- Flexible roof-mounted aerial



Please note that compatibility and certain functions may be different depending on the type of device and operating system you're using with the Multimedia systems. Apple CarPlay is a trademark of Apple Inc. Apple and iPhone are trademarks of Apple Inc., registered in the U.S. and other countries. Android is a trademark of Google Inc, also registered in the U.S. and other countries. *Services may require a subscription/fee and are subject to mobile network coverage and availability. Standard on Nav models only. Live navigation services are included for 3 years and thereafter are subject to an additional subscription fee.

Please note, Apple CarPlay screen illustrated on 10-inch colour touchscreen.

Infotainment

Nav Model Features

Multimedia Navi with 7-inch touchscreen

Optional on SE, SRi and Elite Edition models at £500 including VAT

Standard on Corsa-e SE Nav Premium and SRi Nav Premium models

Features as Multimedia, with the addition of navigation features:

Onboard features:

- 7-inch colour touchscreen

Navigation features:

- Satellite navigation system
- 2D/3D street level mapping
- European coverage
- Points-of-interest search
- Map updates via USB

Vauxhall Connect*

Standard on Elite Nav Premium and Ultimate Nav models

Standard on Corsa-e SE Nav Premium/ SRi Nav Premium and Elite Nav Premium models

e-Call and b-Call:

Help when you need it, 24/7, 365 days a year, that's what you get with new Vauxhall Connect. In an emergency or breakdown, you'll be put in touch with a trained advisor, with just the touch of a button.

Multimedia Navi Pro with 10-inch touchscreen

Standard on Elite Nav Premium and Ultimate Nav models

Standard on Corsa-e Elite Nav Premium models

Onboard features:

- 10-inch colour touchscreen

Navigation features:

- Satellite navigation system
- 2D/3D street level mapping
- European coverage
- Points-of-interest search
- Map updates via USB

Live navigation** and more:

You can also access live navigation services, receive regular vehicle diagnostic info plus there's a host of remote convenience features available through the MyVauxhall app.

- **Peace of mind:** emergency call, breakdown call and regular vehicle status and information
- **Convenience:** remote functions (e.g. lock/unlock the door).
- **Our additional services for electric vehicles:** trip planning, remote settings or public charging solutions – we keep you going!
- **Smart driving:** enjoy a relaxed ride thanks to live navigation and trip management



*Services may require a subscription/fee and are subject to mobile network coverage and availability. Standard on Nav models only. Live navigation services are included for 3 years and thereafter are subject to an additional subscription fee. **Only available on models with satellite navigation.

Interior Styling and Comfort



Steering wheel:

- Three-spoke design
- Flat-bottomed
- Leather-covered
- Satin chrome-effect bezel

Facia and door trim:

- Mistral facia
- Jet Black door panels
- Chrome-effect interior door handles

Seat trim:

- Fresez Marvel Black fabric seat trim inserts
- Mistral fabric side bolsters and surrounds

Seating:

- Comfort front seats
- Driver's seat (six-way adjustable):
 - Height (up/down)
 - Reach (fore/aft)
 - Backrest (upright/recline)
- Front passenger's seat (four-way adjustable):
 - Reach (fore/aft)
 - Backrest (upright/recline)
- 60/40 split folding rear seats

SE model illustrated.

Steering wheel:

- Three-spoke design
- Flat-bottomed
- Leather-covered
- Satin chrome-effect bezel

Facia and door trim:

- Liquid Palladium facia with Hot Red accents
- Liquid Palladium cloth inserts
- Chrome-effect interior door handles

Seat trim:

- Banda Marvel Black fabric seat trim inserts
- Mistral fabric side bolsters and surrounds
- Signal Red and Dark Titanium seat stitching

Seating:

- Sports-style front seats
- Driver's seat (six-way adjustable):
 - Height (up/down)
 - Reach (fore/aft)
 - Backrest (upright/recline)
- Front passenger's seat (four-way adjustable):
 - Reach (fore/aft)
 - Backrest (upright/recline)
- 60/40 split folding rear seats

Pedals:

- Sports, alloy-effect

SRi model with optional sat nav illustrated.

Interior Styling and Comfort

Griffin Edition/Elite Edition



Steering wheel:

- Three-spoke design
- Leather-covered
- Satin chrome-effect bezel
- Reach and rake adjustable

Facia and door trim:

- Silent Black facia with Galvano Chrome inserts
- Silent Black door panels
- Chrome-effect interior door handles

Seat trim:

- Deep Blue/Mistral fabric seat trim inserts
- Premium leather-effect side bolsters and surrounds

Seating:

- Comfort front seats
- Driver's seat (six-way adjustable):
 - Height (up/down)
 - Reach (fore/aft)
 - Backrest (upright/recline)
- Front passenger's seat (six-way adjustable):
 - Height (up/down)
 - Reach (fore/aft)
 - Backrest (upright/recline)
- 60/40 split folding rear seats

Ultimate Nav



Steering wheel:

- Three-spoke design
- Leather-covered
- Satin chrome-effect bezel
- Reach and rake adjustable

Facia and door trim:

- Jet Black facia with Galvano Chrome inserts
- Jet Black door panels
- Chrome-effect interior door handles

Seat trim:

- Alcantara seat trim inserts
- Jet black side bolsters and surrounds

Seating:

- Driver's seat with massage function
- Driver's seat (six-way adjustable):
 - Height (up/down)
 - Reach (fore/aft)
 - Backrest (upright/recline)
- Front passenger's seat (six-way manual adjustable):
 - Height (up/down)
 - Reach (fore/aft)
 - Backrest (upright/recline)
- 60/40 split folding rear seats

Effective 7 April 2021

All-new Corsa Model Year 2021D

Exterior Colours

Navy Blue (G4B)*
Two-coat metallic paint



VX_COR_30164

Jade White (G2o)†
Brilliant paint £320



VX_COR_30169

Quartz Grey (G4i)†
Two-coat metallic paint £550



VX_COR_30165

Voltaic Blue (G6L)†
Two-coat metallic paint £550



VX_COR_30167

Diamond Black (G7o)**
Two-coat metallic paint £550



VX_COR_30168

Power Orange (GPQ)†
Two-coat premium paint £650



VX_COR_30170

Hot Red (G1R)†
Two-coat premium paint £650







VX_COR_30163

The colours reproduced may vary slightly from the actual paint colour. As a result they should be used as a guide only. Your Vauxhall Retailer has a comprehensive display of our paint samples.

*Standard exterior paint. Not available on SRi, SRi Premium and Ultimate Nav. **Optional at extra cost including VAT. Standard on SRi, SRi Premium and Ultimate Nav. †Optional at extra cost including VAT.

Wheels and Tyres

		Electric models									
		SE	Griffin Edition	SRI	SRI Premium	Elite Edition	Elite Nav Premium	Ultimate Nav	SE Nav Premium	SRI Nav Premium	Elite Nav Premium
 VX_COR_30172	16-inch silver 8-spoke alloy wheels • 195/55 R 16 tyres. • Emergency tyre inflation kit (in lieu of spare wheel).	●									
 VX_COR_30174	16-inch silver bi-colour alloy wheels • 195/55 R 16 ultra low rolling resistance tyres. • Emergency tyre inflation kit (in lieu of spare wheel).								●		
 VX_COR_30177	17-inch diamond-cut gloss black 5-twin spoke alloy wheels • 205/45 R 17 tyres. • Emergency tyre inflation kit (in lieu of spare wheel).		●	●	●	●	●	●			
 VX_COR_30178	17-inch bi-colour alloy wheels • 205/45 R 17 tyres. • Emergency tyre inflation kit (in lieu of spare wheel).									●	●
Provision for spare wheel fitment (spare wheel is Retailer-fit)*		£20*	£20*	£20*	£20*	£20*	£20*	£20*			

*Optional at extra cost including VAT. Not available on Corsa-e electric models.

Petrol Engines

	1.2 (75PS)	1.2 (100PS) Turbo	1.2 (130PS) Turbo automatic
Capacity	1199cc	1199cc	1199cc
Maximum power	75PS (55kW) @ 5750rpm	100PS (74kW) @ 5500rpm	130PS (96kW) @ 5500rpm
Maximum torque	118Nm (87 lb.ft.) @ 2750rpm	205Nm (151 lb.ft.) @ 1750rpm	230Nm (169 lb.ft.) @1750rpm
Configuration	3 cylinders, 4 valves per cylinder, double overhead camshafts	3 cylinders, 4 valves per cylinder, double overhead camshafts	3 cylinders, 4 valves per cylinder, double overhead camshafts
Fuel/induction system	Naturally aspirated with Variable Valve Timing. Multi-point sequential fuel injection	Turbocharger. Multi-point sequential fuel injection	Turbocharger. Multi-point sequential fuel injection
Emission compliance	Euro 6d	Euro 6d	Euro 6d
Service interval	12,500 miles or 1 year (whichever occurs sooner)	12,500 miles or 1 year (whichever occurs sooner)	12,500 miles or 1 year (whichever occurs sooner)

Diesel Engine

	1.5 (102PS) Turbo D BlueInjection
Capacity	1499cc
Maximum power	102PS (75kW) @ 3500rpm
Maximum torque	250Nm (184lb.ft.) @ 1750rpm
Configuration	4 cylinders, 4 valves per cylinder, double overhead camshafts
Fuel/induction system	Turbocharger with intercooler. Variable Valve Timing. Multi-point sequential fuel injection
Emission compliance	Euro 6d
Service interval	20,000 miles or 1 year (whichever occurs sooner)

Performance, Fuel Economy and Emissions

	Performance (manufacturer's figures)		Fuel economy mpg (litres/100km) [#]		CO ₂ emissions g/km [#]		Vehicle Excise Duty*		BiK rates from – 2021/22 tax year
	Maximum speed (mph)	Acceleration 0–60mph (sec)	Combined Low	Combined High	Combined Low	Combined High	First year rate	Standard rate	
1.2 (75PS)	108	12.4	47.8 (5.9)	53.3 (5.3)	118	133	£180	£155	27%
1.2 (100PS) Turbo	121	9.3	47.9 (5.9)	52.3 (5.4)	117	134	£180	£155	27%
1.5 (102PS) Turbo D	117	9.6	62.8 (4.5)	70.6 (4.0)	105	107	£160	£155	25%
1.2 (100PS) Turbo automatic	119	10.2	45.7 (6.2)	48.7 (5.8)	121	140	£180	£155	28%
1.2 (130PS) Turbo automatic	129	8.2	47.1 (6.0)	50.4 (5.6)	123	136	£180	£155	28%

Weights and Towing Data_{kg}

	Gross vehicle weight	Maximum towing weights Trailer with brakes (without brakes)
1.2 (75PS)	1550	500 (500)
1.2 (100PS) Turbo	1620	1200 (580)
1.5 (102PS) Turbo D	1660	1200 (580)
1.2 (100PS) Turbo automatic	1645	1200 (580)
1.2 (130PS) Turbo automatic	1650	1200 (580)

[#]Figures shown are for comparison purposes and should only be compared to the fuel consumption and CO₂ values of other cars tested to the same technical standard. The fuel consumption achieved, and CO₂ produced, in real world conditions will depend upon a number of factors including, but not limited to: the accessories fitted (pre and post registration); variations in weather; driving styles and vehicle load. The WLTP (Worldwide Harmonised Light Vehicles Test Procedure) is used to measure fuel consumption and CO₂ figures. The CO₂ figures display a range to reflect the highest value for the highest emitting version with all available options added, through to a minimum value to represent the lowest emitting version in standard specification. *Correct at time of publication.

Please note: Gross vehicle weight is the total permissible weight of the vehicle including passengers and their luggage. The **maximum roof rack loading** should not exceed 70kg. The **maximum towing weights** are based on the ability of the car, with two occupants of 75kg each, to restart on a 12% gradient, which is approximately 1 in 8.3, at sea level. The permitted trailer load applies up to the specified incline and up to an altitude of 1000 metres above sea level. The permissible gross train weight decreases by 10% for every 1000 metres of additional altitude. At altitudes above 1500 metres, the engine output may drop with a corresponding reduction in towing capability. Any extra weight, such as luggage or additional passengers, should be deducted from the maximum towing weight. With a trailer fully loaded, **maximum noseweight** should not exceed 55kg. Always fit Vauxhall towing attachments and accessories available from your Vauxhall Retailer. They are designed specifically for Vauxhall models and carry a 12-month guarantee. During trailer towing do not exceed a maximum speed of 60mph. This speed limit is also applicable in countries with higher permitted speeds for trailer-vehicle combinations. Pay attention to the local speed limits. For trailers with low driving stability and caravans the use of an oscillation damper is strongly recommended.

Specifications

Transmission

- Front-wheel drive
- Five-speed manual gearbox
 - Available on 1.2 (75PS) models.
- Six-speed manual gearbox
 - Available on 1.2 (100PS) Turbo/1.5 (102PS) Turbo D models.
- Eight-speed automatic transmission
 - Available on 1.2 (100PS) Turbo /1.2 (130PS) Turbo models.

Steering

- Speed-sensitive power-assisted steering

Brakes

- Anti-lock Braking System (ABS)
- Electronic brakeforce distribution
- Emergency brake assist
- Cornering brake control
- Straight line stability control

1.2i (75PS)

Front ventilated discs: 356mm diameter

Rear drums: 203mm diameter

1.2i (100PS)/1.5 (102PS) Turbo D

Front ventilated discs: 381mm diameter

Rear discs: 356mm diameter

Fuel tank capacity

- 1.2 (75PS) 40 litres
- 1.2 (100PS) Turbo/1.2 (130PS) Turbo 44 litres
- 1.5 (102PS) Turbo D 41 litres

Start/Stop technology

New Corsa's Start/Stop system offers real benefits by improving fuel economy and reducing CO₂ emissions, particularly in town. It does this by automatically stopping the engine when you come to a standstill, and then restarting as you prepare to move off.

Before automatically stopping the engine a number of system checks are carried out to ensure that it is both safe and practical to do so. To ensure safety, the driver must depress the clutch pedal, shift in to neutral, and then release the clutch pedal.

System checks carried out before Auto Stop activates include:

- Start/Stop system is not manually deactivated via the facia button
- Sufficient brake vacuum is available to prevent the car rolling down an incline
- Battery is in good condition and charged
- Outside air temperature and engine temperature are above specified minima
- Electronic climate control (where fitted) is not in maximum heating or maximum cooling mode
- Self-cleaning function of the diesel particulate filter is not active

If all of these conditions are satisfied then the vehicle will Auto Stop.

When you are ready to pull away from standstill, Auto Restart is activated by depressing the clutch pedal.

Whilst at a standstill the vehicle is continually monitored. If necessary, the engine will automatically be restarted. Conditions that would initiate an Auto Restart include:

- Low battery level
- Brake vacuum below specified minimum
- Start/Stop system is manually deactivated
- Stationary for 5.5 minutes

All-new Corsa-e Specifications

Single-speed electronic drive selector

As the motor is an all-electric single-speed drive unit, there is no need for multiple gears. Instead, the shifter lets the driver select from the following:

- Park
- Reverse
- Neutral
- Drive
- Braking (for increased regenerative braking)

Drive Mode Selector

The driver can determine the driving style through selecting one of the following modes:

- **Sport:** for a dynamic drive with a responsive throttle and the highest top speed and torque
- **Normal:** for a balanced drive that offers a compromise between performance and energy efficiency
- **ECO:** for maximum range and energy efficiency. The ECO mode deactivates all unnecessary energy-consuming features and reduces the top speed, torque and overall performance.

Drivetrain	Corsa-e
CO ₂ emissions	0g/km
Maximum power kW/PS	100/136
Maximum torque Nm/lb. ft.	260/192
Acceleration 0-60mph (sec)	7.6
Maximum speed mph	93
Transmission	Automatic electric drive with fixed gear ratio
Kerbweight	1530kg
Service interval	Initial inspection at 8,000 miles/1 year (whichever comes sooner). Thereafter 16,000 miles/2 years (whichever comes sooner)

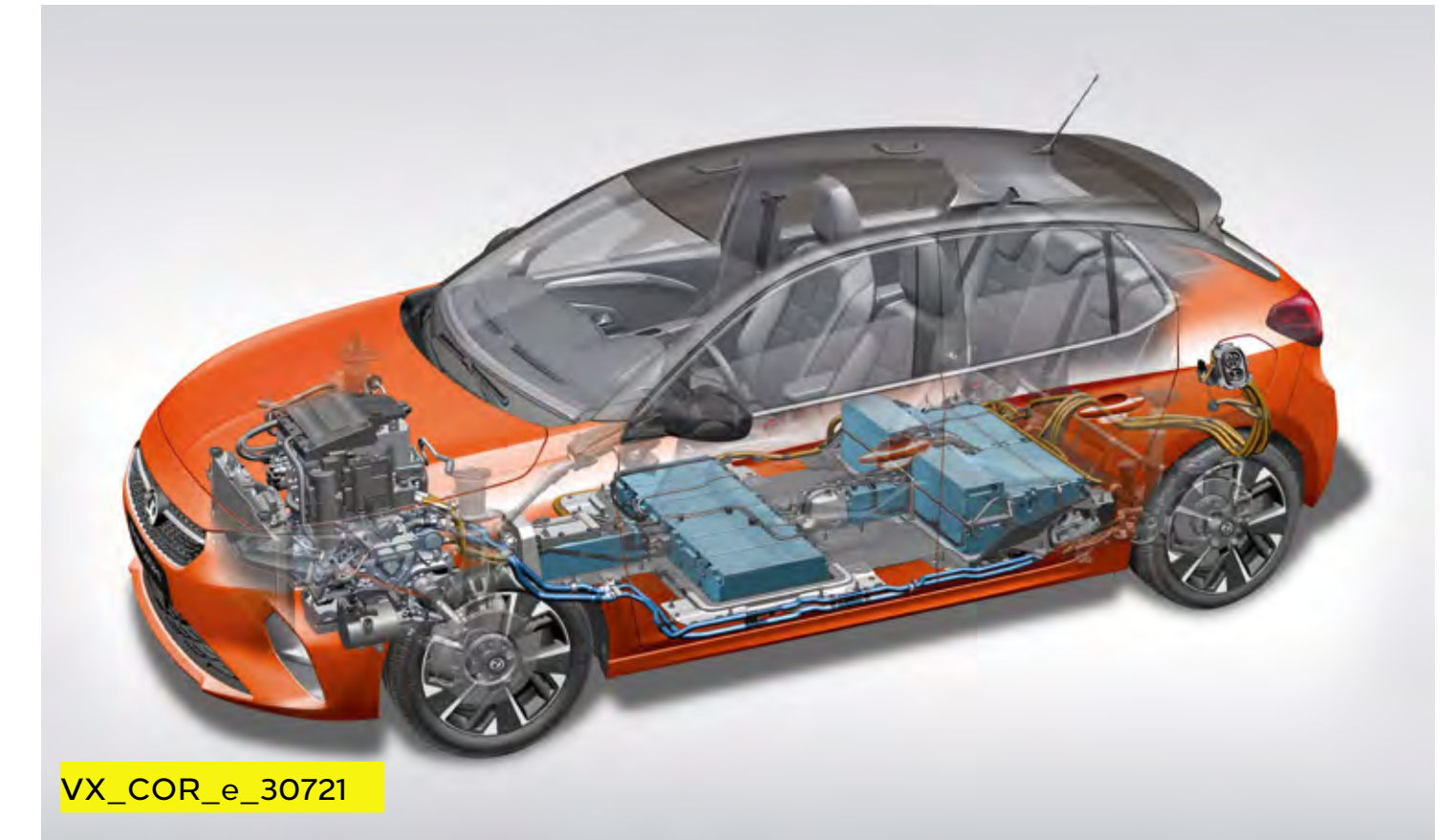

All-new Corsa-e Specifications*

Charging

With Corsa-e you have the choice of a 7.4kW or 11kW on-board charger, both equipped with Mode 3 cables as standard as shown below. Additional charging accessories are available at extra cost, see Accessories page for more details or consult your local Retailer.

	7.4kW on-board charger	11kW on-board charger
Mode 3, 1-phase 7.4kW cable	Standard	N/A
Mode 3, 3-phase 22kW cable	N/A	Standard
Mode 2, emergency charging cable	Optional accessory £584	Optional accessory £584

The charging flap's Padlock LED lights up when the cable is correctly plugged in and locked and then acts as a user interface to show the charging status via coloured LED lights:

- **White:** welcome light that helps to light up the area, especially useful in dark conditions
- **Flashing green:** charging in progress
- **Solid green:** charging complete
- **Solid blue:** delayed charging toggled; changes to flashing green when charging commences
- **Solid red:** malfunction

The driver may also choose from two settings:

- **Immediate charging (the standard setting):** Starts charging as soon as the vehicle is docked for charging
- **Delayed charging:** This is especially useful for when cheaper electric rates are desired, e.g. charging at night. Simply enter a charging start time.

Please note, EV range assumes that vehicle has been pre-conditioned prior to journey. This function can be accessed either via MyVauxhall App (standard with all Corsa-e) or by using the Multimedia Navi Pro infotainment system (standard on Elite Nav).

The Corsa-e is a battery electric vehicle requiring mains electricity for charging. Range data given has been determined according to WLTP test procedure methodology. The figures shown are intended for comparability purposes only and should only be compared to other cars tested to the same technical standard. The range you achieve under real world driving conditions will depend upon a number of factors, including but not limited to: the accessories fitted (pre and post registration); charging frequency; personal driving style; vehicle load and route characteristics; variations in weather; heating/air conditioning; pre-conditioning and battery condition. For more information, contact your local Vauxhall Retailer.

*Provisional data. **You can obtain 15-80% of the vehicle charge in 30 minutes from a 100kW rapid charging station. You can obtain 15-80% of the vehicle charge in 45 minutes from a 50kW rapid charging station. Rapid charging stations are widely available across the UK at various locations and their power rating varies, typically from 50kW and sometimes up to 350kW. †The charging time may vary according to the type and power of the charging station, the outside temperature at the charging point and the battery temperature.

Battery	7.4kW on-board charger		11kW on-board charger	
Battery energy kWh	50			
EV range (WLTP high)	209 miles			
Battery consumption (Combined low/high)	16.5-16.8kWh/100km			
Battery warranty	8 years/100,000 miles/70% capacity			
Time to charge	0-100%	15-80%	0-100%	15-80%
Domestic socket – 2.3kW (10A limit)	24h 20min	15h 50min	24h 20min	15h 50min
Domestic wallbox – Accelerated charger 7.4kW	7h 30min	5h	7h 30min	5h
Public charging – Accelerated charger 11kW	15h	10h	5h	3h 20min
Public charging – Accelerated charger 22kW	7h 30min	5h	5h	3h 20min
Rapid charger 50kW**	1h 10min [†]	45min [†]	1h 10min [†]	45min [†]
Rapid charger 100kW**	50min [†]	30min [†]	50min [†]	30min [†]



VX_COR_e_30328

Dimensions and Capacities All measurements in mm (inches) unless stated otherwise.

VX_COR_31767



VX_COR_30093

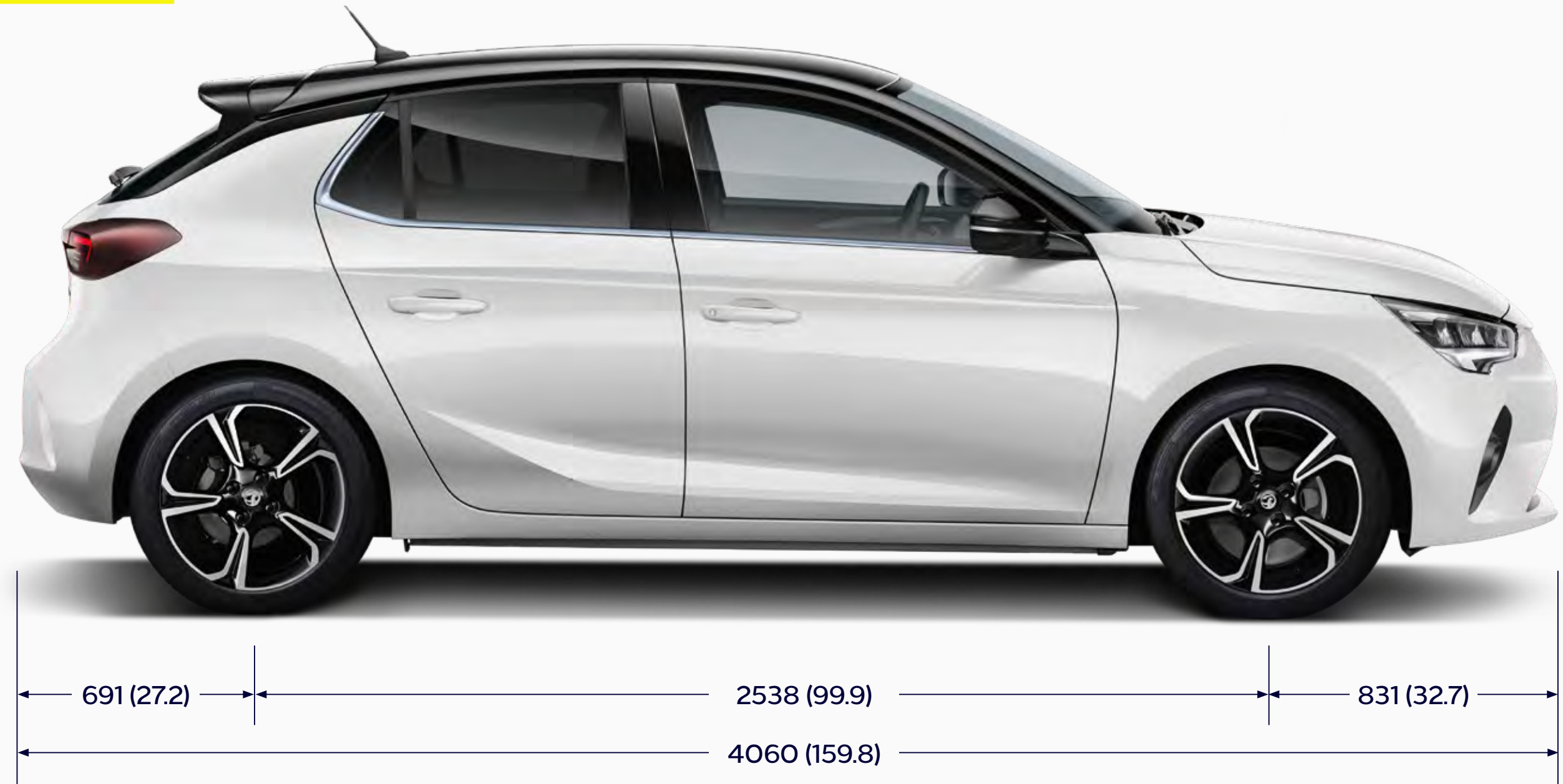

Loadspace Dimensions	Corsa	Corsa-e
Maximum length behind rear seats	885 (34.8)	885 (34.8)
Maximum length rear seats folded	1697 (66.8)	1697 (66.8)
Maximum width	867 (34.1)	867 (34.1)
Maximum height	574 (22.5)	574 (22.5)

Luggage Capacities Litres (cu.ft.)	Corsa	Corsa-e
Rear seats up (under luggage compartment cover)	309 (10.9)	267 (9.4)
Rear seats folded (to roof)	1118 (39.4)	1081 (38.1)

Accessories

Safety Total (inc. VAT)

Spare wheel kit with 15-inch emergency wheel and tool kit (petrol and diesel models only) ¹	£167
Philips ADR620 dash cam	£109
Front parking sensors	£405
Rear parking sensors	£430
Rear view camera	£726
Child seats ²	
– Age group 0 (approx. 24 months/ up to 13kg)	£182
– ISOFIX base for age group 0 ³	£230
– Age group 1 (approx. 1-3.5 years/9-18kg)	£510
– Age group 2/3 (approx. 3-12 years/ 15-36kg)	£186
Safety Pack – first aid kit, hi-vis vest and small warning triangle	£16
Warning triangle	£9
Hi-vis safety vest – adult	£4
Hi-vis safety vest – child 3-6 years (42cm)	£4
Hi-vis safety vest – child 7-12 years (52cm)	£4
First aid kit	£15
Emergency seat belt cutter and hammer	£18
Fire extinguisher (1kg) with strap	£32
Under seat bracket for fire extinguisher ⁴	£47

Protection Total (inc. VAT)

Floor mats (set of 4)	
– Carpet	£32
– Rubber	£52
– Velour	£75
Rubber boot tray	£49
Reversible boot liner (carpet/rubber)	£80
Rear bumper protection film	£36
Rear seat cover	£39
Boot area cover	£53
Front and rear splash guards ⁵	£82

Comfort

FlexConnect bracket	£20
FlexConnect hook	£27
FlexConnect coat hanger	£40
FlexConnect folding table	£65
FlexConnect iPad mini holder	£93
FlexConnect iPad holder	£103
FlexConnect iPad Air holder	£103
FlexConnect Samsung Galaxy holder	£93
Privacy shades for rear and side rear windows	£161
Front wind deflectors	£76
Foldable front armrest with storage	£146
Rear cup holder	£54
Smoker's pack	£52
Fragrance diffuser	£23
Fragrance cartridge (various)	£18
Wireless phone charger	£233

Style Total (inc. VAT)

Decal kit with roof and bonnet racing stripes, in black or white	£212
Sport pedal covers	
– Manual	£62
– Auto	£43
Body styling kit ⁵ with front and rear bumper attachments, and side skirts	£1,350
17-inch diamond-cut bi-colour alloy wheels (set of four) ⁴	£1,190
Available in Gloss Black, Summit White, Hot Red, Voltaic Blue or Carbon fibre-effect:	
– Exterior door mirror covers ⁶	£120 – £123
– Grille bar	£168
Wheel inserts ^{7,8}	
– Each	£20
– Set of four	£36
– Interior rear-view mirror covers ^{4,6,7}	£58 – £62
– Interior facia inserts ⁷	£174
– Manual gear knobs ⁹	£80

Transport solutions Total (inc. VAT)

Roof base carrier ¹⁰	£145
Roof carriers (requires base carrier)	
Roof box – Thule Ocean 80	£164
Roof box – Thule Ocean 200	£374
Roof box – Thule Touring 200	£428
Roof box – Thule Touring 700	£492
Roof box – Thule Motion 800	from £426
Bike carrier – Thule FreeRide 532	£81
Bike carrier – Thule Expert 298	£134
Surfboard carrier – Thule 833	£82
Ski/snowboard carrier	
– Thule Snow Pack 7324 (4 x pairs)	£143
Ski/snowboard carrier	
– Thule Snow Pack 7326 (6 x pairs)	£258
Towing	
Tow bar with removable tow ball ^{4,5}	£422
Electric	
Mode 2 emergency charging cable (Type G)	£584
Mode 3 charging cable	
– 7.4kW	£331
– 11kW	£371
– 22kW	£438
Cable bag	£49
Mode 2 Universal Charger UK kit (22kW)	£1,555
Accessories for Universal Charger	
– Wall bracket	£105
– Bag	£65
– Safety lock	£20
– Adapter Type 2	£318
– Adapter Type 3c	£358
– Adapter (various)	£120

Please note: Prices shown are fully fitted and painted, where applicable and include VAT. Please check with your local Vauxhall Retailer for details. It is advisable to ensure your insurance policy is adequate to cover additional fitted accessories. Prices correct at time of publication.

¹Vehicle must be ordered with spare wheel fixing option (T7Y) in order to accommodate the spare wheel. ²Restrictions apply to the use of child seats, please consult your vehicle user manual or Vauxhall Retailer. ³Restricted to rear seat usage only for vehicles with transponder deactivation of passenger airbag. ⁴Available on petrol and diesel models only. ⁵Not compatible with SRi models. ⁶Not available in Gloss Black. ⁷Not available in Carbon fibre-effect. ⁸Only available with 17-inch diamond-cut bi-colour alloy wheels. ⁹Available in red and blue only. ¹⁰T-Track adapters may be required for certain Thule roof attachments. Please consult your Vauxhall Retailer for details.

Company Car Driver and Fleet Information

Benefit in kind company car taxation*

The car benefit charge will be the car's list price (including VAT, options and accessories fitted, delivery to Retailer and number plates, but excluding Vehicle Excise Duty and new vehicle first registration fee) multiplied by the percentage charge for the CO₂ emissions band in which the car falls (see table opposite). Multiply this figure by your personal income tax rate (20%** for Basic Rate, 40%** for Higher Rate) to calculate your annual benefit in kind tax liability.

Example:

Corsa SE 1.5 (102PS) Turbo D Start/Stop (CO₂ emissions 105g/km)

On-the-road RRP	£18,805.00
Deduct: Vehicle Excise Duty	(£160.00)
New vehicle first registration fee	(£55.00)
Effective list price	£18,590.00
Add: Optional two-coat metallic paint	£550.00
List price for tax purposes (P11D value)	£19,140.00
Car benefit charge 2021-22 tax year (25%)	£4,785.00
Benefit in kind tax liability (2021-22 tax year)	
Basic Rate (20%) tax payer	£957.00
Higher Rate (40%) tax payer	£1,914.00

*Please note this Price Guide provides taxation information as a guide only. Vauxhall does not provide taxation guidance. Drivers should always take professional advice on their own tax position.
**Excludes residents of Scotland.

BiK for Scottish Residents

Effective 6 April 2018 the Scottish Government have introduced their own BiK taxation structure. This only applies to Company Car Drivers that are Scottish taxpayers. HMRC will determine whether or not an individual is a Scottish taxpayer based on where their main place of residence is.

The BiK rates for Scotland are:

- Over £12,570-£14,667 Starter Rate 19%
- Over £14,667-£25,296 Basic Rate 20%
- Over £25,296-£43,662 Intermediate Rate 21%
- Over £43,662-£150,000 Higher Rate 41%
- Above £150,000 Top Rate 46%

CO ₂ emissions (g/km)	Percentage of cars price to be taxed 2021-22 tax year
Up to 50	13%
51-54	14%
55-59	15%
60-64	16%
65-69	17%
70-74	18%
75-79	19%
80-84	20%
85-89	21%
90-94	22%
95-99	23%
100-104	24%
105-109	25%
110-114	26%
115-119	27%
120-124	28%
125-129	29%
130-134	30%
135-139	31%
140-144	32%
145-149	33%
150-154	34%
155-159	35%
160-164	36%
165-169	37%
170+	37%

CO ₂ emissions (g/km)	Electric range (miles)	Percentage of cars price to be taxed 2021-22 tax year
0	-	1%
1-50	130+	1%
1-50	70-129	4%
1-50	40-69	7%
1-50	30-39	11%
1-50	<30	13%

To calculate your own personal liability, search: **Vauxhall BiK**, or click the link below: [Vauxhall BiK Tool](#)

Company Car Driver Free 3 Day Test Drive

Our free[†] 3 Day Test Drive programme is open to all Company Car Drivers which allows you to choose any model in the current Vauxhall line-up (exclusions apply). With full insurance cover provided, it gives you a meaningful length of time to make an informed decision about your next company car.

Search Vauxhall 3DTD to book your free[†] test drive or click the link the below: [Vauxhall 3 Day Test Drive](#)

[†]The free 3 Day Test Drive programme is open to Company Car Drivers and Fleet Decision Makers. Available for UK Mainland only. Terms and conditions apply. Full terms and conditions can be found at vauxhallfleet.co.uk/testdrive/index/terms.

Fleet Toolbox

Discover the facts in our online Toolbox for both Company Car Drivers and Fleet Decision Makers. The Fleet Toolbox has a host of useful calculators, comparators, interactive listings and information. Search Vauxhall Fleet Tools or click the link below: [Vauxhall Fleet Tool Box](#)

Contact Vauxhall Fleet

Please contact one of our dedicated sales teams who will be happy to help with your particular enquiry.

Company Car Drivers

Call: 0345 111 2020

Email: company-car@vauxhallinfo.co.uk

Telephone lines are open

- Monday to Friday 8:00am-9:00pm
- Saturday and Sunday 9:00am-6:00pm

Fleet Decision Makers

Depending on the size of your fleet of vehicles, we have a dedicated team to handle your enquiries. The lines are open Monday to Friday excluding Bank Holidays.

1-24 vehicles

Call: 0845 076 2254 (8:30am-5:00pm)

25+ vehicles

Call: 0330 587 8222 (8:30am-5:00pm)

Email: vauxhallfleet@vauxhall.co.uk

Special Vehicles (Police, Fire and Ambulance)

Call: 01582 409999 (8:30am-5:00pm)

Email: vauxhallspecialvehicles@vauxhall.co.uk

Further Information

On-the-road prices

To eliminate uncertainty about hidden costs when buying a new car, Vauxhall publishes on-the-road recommended retail prices (RRP) and these are shown in the pricing tables within this price guide. These prices include VAT, number plates and delivery to Retailer of £700.00 (including £116.67 VAT), 12 months' Government Vehicle Excise Duty (see opposite for details) and the DVLA new vehicle first registration fee of £55.00.*

Please note: The on-the-road recommended retail price (RRP) does not include fuel supplied by the Retailer, motor insurance or any other goods or services supplied by agreement between the Retailer and the customer.

Price protection

Order a new Vauxhall for build in the current model year (as confirmed by your Retailer) for delivery no more than three months in advance and the price you are quoted is the price you pay. This is irrespective of any subsequent price rises between placing your order and delivery of your new car, but you must take delivery as soon as the car is available.

Please note: Price protection does not apply to Mokka-e/Corsa-e/Grandland X hybrid models. Vauxhall Motors Limited is not liable for price adjustments caused by Government changes in the rate of VAT (currently 20%), Vehicle Excise Duty, DVLA new vehicle first registration fee or by any other applicable legislation or regulations.

In the event of an accident

Vauxhall Accident Management helps keep you mobile following an accident. Benefits include vehicle recovery, Vauxhall-approved repairs and contacting your insurer. For more details, visit vauxhall.co.uk/AccidentManagement

Free2Move Lease

Whether you're a big company or a small business looking for vehicle financing, Free2Move Lease, our business finance specialists, can deliver exactly what you need.

Free2Move Lease is one of the UK's largest leasing companies and is also a member of the British Vehicle Rental and Leasing Association (BVRLA).

With over 60,000 vehicles in the Free2Move Lease portfolio, Free2Move Lease is able to offer competitive vehicle solutions. In addition, Free2Move Lease also offer innovative connected management of servicing and maintenance.

For further information, please contact your local Vauxhall Retailer or visit vauxhall.co.uk/offers-finance/business-leasing.html

Vehicle Excise Duty

The amount of Vehicle Excise Duty (road fund licence) payable on new cars varies depending on the level of carbon dioxide (CO₂) emissions produced by the vehicle. CO₂ emissions are measured in grams per kilometre (g/km) travelled and divided into 13 charging bands shown in the table opposite.

A 'first year rate' of Vehicle Excise Duty is payable on all new cars and in subsequent years the amount payable reverts to the 'standard rate'. From 1 April 2017 the breakpoints for each of these bands have been revised. Also, for vehicles with a list price over £40,000, including factory-fitted options, an additional £335 is payable for the first five years of standard rate payments.

Vehicle Excise Duty*

Band	CO ₂ emissions in grams per kilometre	First year rate Petrol/Diesel	Standard rate Petrol/Diesel	Standard rate Electric
A	0	£0	£0	£0
B	1-50	£10	£155	£0
C	51-75	£25	£155	£0
D	76-90	£115	£155	£0
E	91-100	£140	£155	£0
F	101-110	£160	£155	£0
G	111-130	£180	£155	£0
H	131-150	£220	£155	£0
I	151-170	£555	£155	£0
J	171-190	£895	£155	£0
K	191-225	£1,345	£155	£0
L	226-255	£1,910	£155	£0
M	Over 255	£2,245	£155	£0

*Correct at time of issue.

Further Information

Customer Care Commitment

For added peace of mind, Vauxhall has an innovative Customer Care Commitment that offers the following:

- Three-year vehicle warranty consisting of a one-year/unlimited mileage manufacturer's warranty and a second and third year manufacturer's warranty with a 60,000 miles limitation
- Vauxhall Assistance for 12 months from first registration
- Six years' body panel anti-perforation warranty

Please note: Warranty is only available on vehicles sourced from Vauxhall Motors Limited. Terms and conditions apply – please see your Vauxhall Retailer for details.

Vauxhall Assistance

Vauxhall Assistance is provided automatically with every new Vauxhall for 12 months from first registration and covers everything from accident assistance, roadside recovery and 'at home' service to flat tyres. For even more peace of mind, on Corsa-e models the cover is extended* to 8 years or 100,000 miles, whichever comes first. Even more reason for you to stay calm and let us take care of everything should the need arise. With Vauxhall Assistance help is literally just a free** phone call away, 24 hours a day, 365 days a year!

Protecting the environment

Vauxhall's commitment to the environment is demonstrated by our products' many environmental awards. For even more information on Vauxhall's efforts to achieve an environmentally sustainable future, and how to dispose of your end-of-life vehicle, see vauxhall.co.uk/recycling

Vauxhall Care

This all-inclusive service package is available on Vauxhalls under 10 months old (from date of first registration).

This package offers complete peace of mind for the first 3 years of your Vauxhall's life with fixed monthly payments for the plan duration.

- **3 years' Vauxhall servicing** – covers first, second and third annual services. Including a brake-fluid change in the second service
- **2 years' Vauxhall Roadside Assistance** – first year from us
- **First years' MOT[†]** – free of charge by your local Vauxhall Retailer

For full terms and conditions and to sign up, visit: vauxhall.co.uk/vauxhallcare

Vauxhall Service Club

Vauxhall Service Club is available for all Vauxhall owners, and it's free to join. Members benefit from the following:

- 15% off Vauxhall Approved Accessories
- Vauxhall's aged 2-3 Years = 15% off parts and labour
- Vauxhall's aged over 3 Years = 25% off parts and labour
- Half price MOT's (NI excluded)
- Free pre-MOT test inspection (NI only)
- Fixed price AdBlue[®] Refills
 - Car = £14.99
 - Van = £24.99
- Access to the Vauxhall Accident Management Programme
- Online service booking available 24/7 with servicing appointments available within 3 days – [Book Online](#)
- Collection and delivery/onward mobility options
- Complimentary 'Wash and Vac' with all routine services^{††}
- Vauxhall trained technicians
- Genuine Vauxhall parts
- Minimum 12 months warranty on parts and labour
- Regular newsletters with exclusive offers, discounts and competitions

Terms and conditions apply. To join visit: vauxhall.co.uk/serviceclub

Vauxhall Insurance with added reassurance

Comprehensive cover – Summary of benefits

- Competitive premiums
- Repairs by a Vauxhall-trained technician
- Genuine Vauxhall parts, guaranteed for five years when we repair your car within our Approved Repairer Network
- Free courtesy car as standard when using an Approved Repairer[‡]
- 24 hour claims helpline
- Personal Accident benefit
- Cover for audio equipment
- Windscreen cover

Call for a quote on **0330 678 1130^{‡‡}**

For more product information

For further information on the Vauxhall range or location of your nearest Vauxhall Retailer please call **0345 600 1500**. Alternatively, details can be found on our website at vauxhall.co.uk

For more information call **0345 600 1500**

For Fleet enquiries call **0330 587 8222**

Discover the full Vauxhall range at **[vauxhall.co.uk](https://www.vauxhall.co.uk)**

Join us online

The invoice price, including delivery to Retailer, factory-fitted options, accessories fitted by the Retailer and number plates, is subject to VAT. Some feature descriptions in this guide may refer to, and some illustrations may show, optional equipment not included in the standard delivery. The information contained in this guide was accurate at the time of publication. We reserve the right to make changes in design and equipment. Please note that Vauxhall Retailers are not the agents of Vauxhall Motors Limited and are not authorised to bind Vauxhall Motors Limited by any specific or implied undertaking or representation. It is advisable to ensure that your motor insurance policy provides adequate cover for additional fitted options and accessories. The colours in this guide are only approximate actual colours. Illustrated optional equipment is available at extra charge. Availability, technical features and equipment provided on our vehicles can vary by model. For precise information on the equipment provided on our vehicles, please contact your local Vauxhall Retailer.

VAUXHALL

Price and Specification Guide
7 April 2021 | Model Year 2021D



Astra

Contents

To find the information you want use the links below to navigate around the guide:

[Choose your Trim Level](#)

[Range Highlights](#)

[Models](#)

[Prices](#)

[Features/Options](#)

[Infotainment](#)

[Interior Style and Comfort](#)

[Exterior Colours](#)

[Wheels and Tyres](#)

[Engines and Technical Data](#)

[Performance, Economy and Emissions](#)

[Specifications](#)

[Dimensions and Capacities](#)

[Accessories](#)

[Company Car Information](#)

[Further Information](#)

Choose Your Trim Level

Business Edition Nav

Inject a little excitement into your commute with the Business Edition Nav, with plenty of 'must have' features as standard.



VX_AST_31166

SRi Nav

Step up to our sporty SRi Nav model. It's kitted out with a whole host of features that make it fun to drive, and great to look at.



VX_AST_31902

Griffin Edition

Get even more with the Griffin Edition. Boasting premium-class features, 18-inch bi-colour alloy wheels and state-of-the-art tech – the list goes on.



VX_AST_31791

Elite Nav Premium

Upgrade to the Elite Nav Premium for more comfort and more style, inside and out.



VX_AST_31900

Astra Range Highlights

Business Edition Nav

Standard features include:

- Multimedia Navi system
 - Satellite navigation
 - 7-inch colour touchscreen
 - AM/FM/DAB digital radio
 - Bluetooth® audio streaming
 - Bluetooth® mobile phone portal
 - Apple CarPlay/Android Auto™
 - USB audio connection
- 3.5-inch information monochrome display
- 16-inch five twin-spoke alloy wheels
- Six speakers • Air conditioning
- Multi-function trip computer
- Cruise control with speed limiter
- Steering wheel audio/phone/cruise controls
- Steering column adjustable for reach/rake
- Electrically operated front/rear windows
- Remote control central locking
- Electrically adjustable/heated door mirrors
- Electronic Stability Programme (ESP)
- ISOFIX child seat mounting points on outer rear seats
- Six airbags • Hill start assist
- Electronic engine deadlock immobiliser
- Black roof rails (Sports Tourer only)
- 60/40 split-folding rear seat back
- Front centre armrest
- Door-to-door illumination
- Leather-covered steering wheel
- Rain-sensitive windscreen wipers
- Automatic lighting control with tunnel detection
- Interior ambient lighting
- Rear reading spotlights

SRI Nav

Features over Business Edition Nav models:

- 17-inch five twin-spoke alloy wheels
- LED headlights
- Remote control ultrasonic security alarm system
- Automatic emergency braking
- Forward collision alert
- Following distance indicator
- Lane departure warning with lane assist
- Driver's ergonomic active sports-style seat (AGR approved*)
- Electronic parking brake
- Soundproofed insulated windscreen
- Front fog lights
- Automatic anti-dazzle rear-view mirror
- Dual-zone electronic climate control
- Humidity sensor
- Silver-effect roof rails (Sports Tourer only)

Griffin Edition

Features over SRI Nav models:

- 18-inch bi-colour, ten twin-spoke alloy wheels
- Dark-tinted rear windows
- Black roof
- Front and rear parking distance sensors
- Heated front seats
- Heated leather-covered steering wheel
- Rear floor heating ducts
- Griffin badge
- Front and rear floor mats (front Griffin-branded)
- Chrome-effect upper window surround

Elite Nav Premium

Features over SRI Nav models:

- Multimedia Navi Pro system
 - 8-inch colour touchscreen
- 8-inch colour digital instrument display
- Front and rear parking distance sensors
- Rear floor heating ducts
- Shark fin aerial
- Rear view camera, digital
- Keyless entry and start
- Heated front seats
- Heated leather-covered steering wheel
- Twin rear USB sockets
- Ergonomic active sports-style front seats (AGR-approved*)
- Perforated leather seat trim inserts
- Driver's seat with Wellness Functions
- Chrome-effect upper window surround

Please note: Elite Nav Premium models do not feature front fog lights.

Astra Business Edition Nav

VX_AST_31166



Business Edition Nav

OTR from
£20,035

Infotainment:

- Multimedia Navi system
 - Satellite navigation
 - 7-inch colour touchscreen
 - AM/FM/DAB digital radio
 - Bluetooth® audio streaming
 - Bluetooth® mobile phone portal
 - Apple CarPlay/Android Auto™
 - USB audio connection
- Six speakers

Interior convenience/styling:

- 3.5-inch monochrome information display
- Air conditioning
- Multi-function trip computer
- Cruise control with speed limiter
- Door-to-door illumination
- Steering wheel audio/phone/cruise controls
- Steering column adjustable for reach/rake
- 60/40 split-folding rear seat back
- Front centre armrest
- Leather-covered steering wheel
- Interior Light Pack
 - Interior ambient lighting
 - Illuminated vanity mirrors
 - Rear reading spotlights

Exterior convenience/styling:

- 16-inch five twin-spoke alloy wheels
- Electrically operated front/rear windows
- Electrically adjustable/heated door mirrors
- Black roof rails (Sports Tourer)
- Sight and Light Pack
 - Rain sensitive windscreen wipers
 - Automatic lighting control with tunnel detection

Safety/security:

- Electronic engine deadlock immobiliser
- Tyre pressure monitoring system
- Electronic Stability Programme (ESP)
- Anti-lock Braking System (ABS)
- Six airbags
- Hill start assist
- ISOFIX child seat mounting points, outer rear seats
- LED daytime running lights
- Remote control central locking

Astra SRi Nav

VX_AST_31902



SRi Nav OTR from £22,090

Infotainment:

- Multimedia Navi system
 - Satellite navigation
 - 7-inch colour touchscreen
 - AM/FM/DAB digital radio
 - Bluetooth® audio streaming
 - Bluetooth® mobile phone portal
 - Apple CarPlay/Android Auto™
 - USB audio connection
- Six speakers

Interior convenience/styling:

- 3.5-inch monochrome information display
- Dual-zone electronic climate control
- Humidity sensor
- Multi-function trip computer
- Cruise control with speed limiter
- Door-to-door illumination
- Steering wheel audio/phone/cruise controls
- Steering column adjustable for reach/rake
- 60/40 split-folding rear seat back
- Front centre armrest
- Leather-covered steering wheel
- Interior Light Pack
 - Interior ambient lighting
 - Illuminated vanity mirrors
 - Rear reading spotlights
- Driver's ergonomic active sports-style seat (AGR approved*)
- Soundproofed insulated windscreen
- Automatic anti-dazzle rear-view mirror
- Storage pockets on front seat backs

Exterior convenience/styling:

- 17-inch five twin-spoke alloy wheels
- Electrically operated front/rear windows
- Electrically adjustable/heated door mirrors
- LED headlights
- Sight and Light Pack
 - Rain-sensitive windscreen wipers
 - Automatic lighting control with tunnel detection
- Front fog lights
- Silver-effect roof rails (Sports Tourer only)

Safety/security:

- Electronic engine deadlock immobiliser
- Tyre pressure monitoring system
- Electronic Stability Programme (ESP)
- Anti-lock Braking System (ABS)
- Six airbags
- Hill start assist
- ISOFIX child seat mounting points, outer rear seats
- LED daytime running lights
- Remote control ultrasonic security alarm system
- Driving Assistance Pack
 - Following distance indicator
 - Forward collision alert
 - Lane departure warning with lane assist
 - Automatic emergency braking
- Electronic parking brake

Astra Griffin Edition

VX_AST_31791



Griffin Edition OTR from £19,540

Infotainment:

- Multimedia Navi system
 - Satellite navigation
 - 7-inch colour touchscreen
 - AM/FM/DAB digital radio
 - Bluetooth® audio streaming
 - Bluetooth® mobile phone portal
 - Apple CarPlay/Android Auto™
 - USB audio connection
- Six speakers

Interior convenience/styling:

- 3.5-inch monochrome information display
- Dual-zone electronic climate control
- Humidity sensor
- Multi-function trip computer
- Cruise control with speed limiter
- Door-to-door illumination
- Steering wheel audio/phone/cruise controls
- Steering column adjustable for reach/rake
- 60/40 split-folding rear seat back
- Front centre armrest
- Interior Light Pack
 - Interior ambient lighting
 - Illuminated vanity mirrors
 - Rear reading spotlights
- Driver's ergonomic active sports-style seat (AGR approved*)
- Soundproofed insulated windscreen
- Automatic anti-dazzle rear-view mirror
- Storage pockets on front seat backs
- Front and rear floor mats (front Griffin-branded)

- Winter Pack 1
 - Heated front seats
 - Rear floor heating ducts
 - Heated leather-covered steering wheel

Exterior convenience/styling:

- 18-inch bi-colour, ten twin-spoke alloy wheels
- Electrically operated front/rear windows
- Electrically adjustable/heated door mirrors
- Chrome-effect upper window surround
- LED headlights
- Sight and Light Pack
 - Rain-sensitive windscreen wipers
 - Automatic lighting control with tunnel detection
- Silver-effect roof rails (Sports Tourer only)
- Front fog lights
- Dark-tinted rear windows • Black roof
- Front and rear parking distance sensors
- Griffin badge

Safety/security:

- Electronic engine deadlock immobiliser
- Tyre pressure monitoring system
- Electronic Stability Programme (ESP)
- Anti-lock Braking System (ABS)
- Six airbags • Hill start assist
- ISOFIX child seat mounting points, outer rear seats
- LED daytime running lights
- Remote control ultrasonic security alarm system
- Driving Assistance Pack
 - Following distance indicator
 - Forward collision alert
 - Lane departure warning with lane assist
 - Automatic emergency braking
- Electronic parking brake

Astra Elite Nav Premium

VX_AST_31900



Elite Nav Premium

OTR from
£26,245

Infotainment:

- Multimedia Navi Pro system
 - Satellite navigation
 - 8-inch colour touchscreen
 - AM/FM/DAB digital radio
 - Bluetooth® audio streaming
 - Bluetooth® mobile phone portal
 - Apple CarPlay/Android Auto™
 - USB audio connection
- Six speakers

Interior convenience/styling:

- 8-inch colour digital instrument display
- Dual-zone electronic climate control
- Humidity sensor
- Multi-function trip computer
- Cruise control with speed limiter
- Door-to-door illumination
- Steering wheel audio/phone/cruise controls
- Steering column adjustable for reach/rake
- 60/40 split-folding rear seat back
- Front centre armrest
- Ergonomic active sports-style front seats (AGR-approved*)
- Perforated leather seat trim inserts
- Driver's seat with Wellness Functions
- Soundproofed insulated windscreen
- Interior Light Pack
 - Interior ambient lighting
 - Illuminated vanity mirrors
 - Rear reading spotlights
- Automatic anti-dazzle rear-view mirror
- Storage pockets on front seat backs

- Winter Pack 2
 - Heated front seats
 - Rear floor heating ducts
 - Twin rear USB sockets
 - Heated leather-covered steering wheel

Exterior convenience/styling:

- 17-inch five twin-spoke alloy wheels
- Electrically operated front/rear windows
- Electrically adjustable/heated door mirrors
- Chrome-effect upper window surround
- LED headlights
- Sight and Light Pack
 - Rain-sensitive windscreen wipers
 - Automatic lighting control with tunnel detection
- Front and rear parking distance sensors
- Shark fin aerial
- Rear view camera, digital

Safety/security:

- Electronic engine deadlock immobiliser
- Tyre pressure monitoring system
- Electronic Stability Programme (ESP)
- Anti-lock Braking System (ABS)
- Six airbags
- Hill start assist
- ISOFIX child seat mounting points, outer rear seats
- LED daytime running lights
- Remote control ultrasonic security alarm system
- Driving Assistance Pack
 - Following distance indicator
 - Forward collision alert
 - Lane departure warning with lane assist
 - Automatic emergency braking
- Electronic parking brake
- Keyless entry and start

Astra Hatchback Prices

	Pack Code	Fuel Type	Price (£)	VAT (£)	Total (£)	On-the-road RRP (£)	Financial Year 2021/22 BiK 20% (£)	WLTP Combined CO ₂ (g/km) [#] – pack code	Insurance groups
Business Edition Nav									
1.2 (110PS) Turbo	BG68 EJ61	Petrol	15,916.67	3,183.33	19,100.00	20,035.00	89.08	119	16E
1.2 (130PS) Turbo	BG68 EN61	Petrol	16,583.33	3,316.67	19,900.00	20,835.00	92.68	119	19A
1.5 (105PS) Turbo D	BG68 HO61	Diesel	16,916.67	3,383.33	20,300.00	21,235.00	90.98	113	16E
1.5 (122PS) Turbo D	BG68 HP61	Diesel	17,483.33	3,496.67	20,980.00	21,915.00	97.55	115	20A
1.5 (122PS) Turbo D Auto	BG68 HA91	Diesel	18,983.33	3,796.67	22,780.00	23,755.00	117.38	133	20A
SRI Nav									
1.2 (110PS) Turbo	BR68 EJ61	Petrol	17,629.17	3,525.83	21,155.00	22,090.00	98.33	119	14E
1.2 (145PS) Turbo	BR68 ES61	Petrol	18,795.83	3,759.17	22,555.00	23,490.00	104.63	119	17E
1.5 (105PS) Turbo D	BR68 HO61	Diesel	18,629.17	3,725.83	22,355.00	23,290.00	99.90	114	14E
1.5 (122PS) Turbo D	BR68 HP61	Diesel	19,195.83	3,839.17	23,035.00	23,970.00	106.80	115	17E
1.5 (122PS) Turbo D Auto	BR68 HA91	Diesel	20,695.83	4,139.17	24,835.00	25,810.00	127.67	133	17E
Griffin Edition									
1.2 (145PS) Turbo	BE68 ES61	Petrol	15,504.17	3,100.83	18,605.00	19,540.00	86.87	119	15E
1.5 (122PS) Turbo D	BE68 HP61	Diesel	15,904.17	3,180.83	19,085.00	20,020.00	89.02	115	16E
1.5 (122PS) Turbo D Auto	BE68 HA91	Diesel	17,404.17	3,480.83	20,885.00	21,860.00	107.92	133	15E
Elite Nav Premium									
1.2 (145PS) Turbo	BK68 ES61	Petrol	21,091.67	4,218.33	25,310.00	26,245.00	117.03	119	16E
1.5 (122PS) Turbo D	BK68 HP61	Diesel	21,491.67	4,298.33	25,790.00	26,725.00	119.20	115	18E
1.5 (122PS) Turbo D Auto	BK68 HA91	Diesel	22,991.67	4,598.33	27,590.00	28,565.00	141.43	133	16E

Astra's petrol and diesel engines meet the Real Driving Emissions Step 2 (RDE2) standards.

WLTP Combined CO₂ (g/km) figures are based on a configured vehicle as per pack code for UK with no options fitted.

[#]Fuel consumption and CO₂ figures are determined according to the WLTP test cycle. CO₂ figures, BiK values and RRP pricing shown above are for a standard vehicle without any additional optional equipment. CO₂ figures are used to calculate Vehicle Excise Duty (VED) for the first registration of the vehicle and BiK. The addition of optional extras could increase the certified CO₂ emission output. This in turn may affect the amount of VED payable upon registration, and, for company car drivers, the P11D value and the amount of Benefit in Kind (BiK) tax payable. Figures shown are for comparison purposes and should only be compared to the fuel consumption and CO₂ values of other cars tested to the same technical standard. The fuel consumption achieved, and CO₂ produced, in real world conditions will depend upon a number of factors including, but not limited to: the accessories fitted (pre and post registration); variations in weather; driving styles and vehicle load. The WLTP (Worldwide Harmonised Light Vehicles Test Procedure) is used to measure fuel consumption and CO₂ figures. Full data relating to WLTP test cycles can be found at: www.vauxhall.co.uk/wltp

Please note: On-the-road recommended retail prices (RRP) include number plates and delivery to Retailer of £700.00 (inc. £116.67 VAT), 12 months' Vehicle Excise Duty and new vehicle first registration fee of £55.00. Excludes fuel and insurance. Company Car Benefit in Kind (BiK) rates are monthly based on the standard paint price.

Astra Sport Tourer Prices

	Pack Code	Fuel Type	Price (£)	VAT (£)	Total (£)	On-the-road RRP (£)	Financial Year 2021/22 BiK 20% (£)	WLTP Combined CO ₂ (g/km) [#] – pack code	Insurance groups
Business Edition Nav									
1.2 (130PS) Turbo	BG35 EN61	Petrol	17,791.67	3,558.33	21,350.00	22,285.00	99.22	119	16E
1.5 (122PS) Turbo D	BG35 HP61	Diesel	18,691.67	3,738.33	22,430.00	23,365.00	104.08	116	16E
SRI Nav									
1.2 (145PS) Turbo	BR35 ES61	Petrol	20,004.17	4,000.83	24,005.00	24,940.00	111.17	119	16E
1.5 (122PS) Turbo D	BR35 HP61	Diesel	20,404.17	4,080.83	24,485.00	25,420.00	113.32	116	16E
1.5 (122PS) Turbo D Auto	BR35 HA91	Diesel	21,904.17	4,380.83	26,285.00	27,260.00	134.92	133	17E
Griffin Edition									
1.2 (145PS) Turbo	BE35 ES61	Petrol	16,712.50	3,342.50	20,055.00	20,990.00	93.38	119	15E

Astra's petrol and diesel engines meet the Real Driving Emissions Step 2 (RDE2) standards.

WLTP Combined CO₂ (g/km) figures are based on a configured vehicle as per pack code for UK with no options fitted.

[#]Fuel consumption and CO₂ figures are determined according to the WLTP test cycle. CO₂ figures, BiK values and RRP pricing shown above are for a standard vehicle without any additional optional equipment. CO₂ figures are used to calculate Vehicle Excise Duty (VED) for the first registration of the vehicle and BiK. The addition of optional extras could increase the certified CO₂ emission output. This in turn may affect the amount of VED payable upon registration, and, for company car drivers, the P11D value and the amount of Benefit in Kind (BiK) tax payable. Figures shown are for comparison purposes and should only be compared to the fuel consumption and CO₂ values of other cars tested to the same technical standard. The fuel consumption achieved, and CO₂ produced, in real world conditions will depend upon a number of factors including, but not limited to: the accessories fitted (pre and post registration); variations in weather; driving styles and vehicle load. The WLTP (Worldwide Harmonised Light Vehicles Test Procedure) is used to measure fuel consumption and CO₂ figures. Full data relating to WLTP test cycles can be found at: www.vauxhall.co.uk/wltp

Please note: On-the-road recommended retail prices (RRP) include number plates and delivery to Retailer of £700.00 (inc. £116.67 VAT), 12 months' Vehicle Excise Duty and new vehicle first registration fee of £55.00. Excludes fuel and insurance. Company Car Benefit in Kind (BiK) rates are monthly based on the standard paint price.

Safety

Standard Features – The following features are standard across the entire Astra range.

Airbags

- Driver's airbag
- Front passenger's airbag
- Front seat side-impact airbags
- Full-size curtain airbags

Seating

- Height-adjustable front head restraints
- Three height-adjustable rear seat head restraints
- Anti-submarining ramps in all seats

Seatbelts

- Front inertia-reel lap and diagonal seatbelts
- Three inertia-reel lap and diagonal rear seatbelts
- Front seatbelts with crash locking tongues
- Outer rear seatbelt pretensioner system
- Front and outer rear seatbelt force limiters
- 'Seatbelt unfastened' audible warning and warning light

Stability

- Electronic Stability Programme (ESP)
ESP monitors many different inputs to determine when the car starts to lose traction, it can then immediately respond by varying the brake pressure between up to three wheels and adjust the engine output to help correct the loss of traction and improve stability

Additional ESP features

- Traction control
- Cornering brake control
- Straight line stability control
- Drag torque control – Maintain stability on slippery roads when lifting off the accelerator or changing gear

Braking

- Anti-lock Braking System (ABS)
- Emergency brake assist – When emergency braking is detected the vehicle automatically applies the maximum possible braking assistance
- Electronic brakeforce distribution – Automatically apportions the optimum braking force to each wheel.

- Hill start assist – Briefly maintains rear brake pressure to stop the vehicle rolling back on an incline
- Adaptive brake lights – Automatically warns other road users of heavy braking

Tyre pressure

- Tyre pressure monitoring system

Child safety

- Deactivation switch for front passenger's front and side-impact airbags
- ISOFIX child seat mountings incorporating top tether anchor points located on outer rear seats (does not include child seat) – Allows ISOFIX child safety seats to be securely fixed into the car. The ISOFIX mounting system reduces forward movement in an accident and makes the child seat easier to install.
- Child-proof locks on rear doors

Pedestrian safety

- Active bonnet/headlight/wiper structure – Designed to reduce pedestrian head and upper body injuries
- Upper and lower bumper design – Reduces upper and lower leg injuries

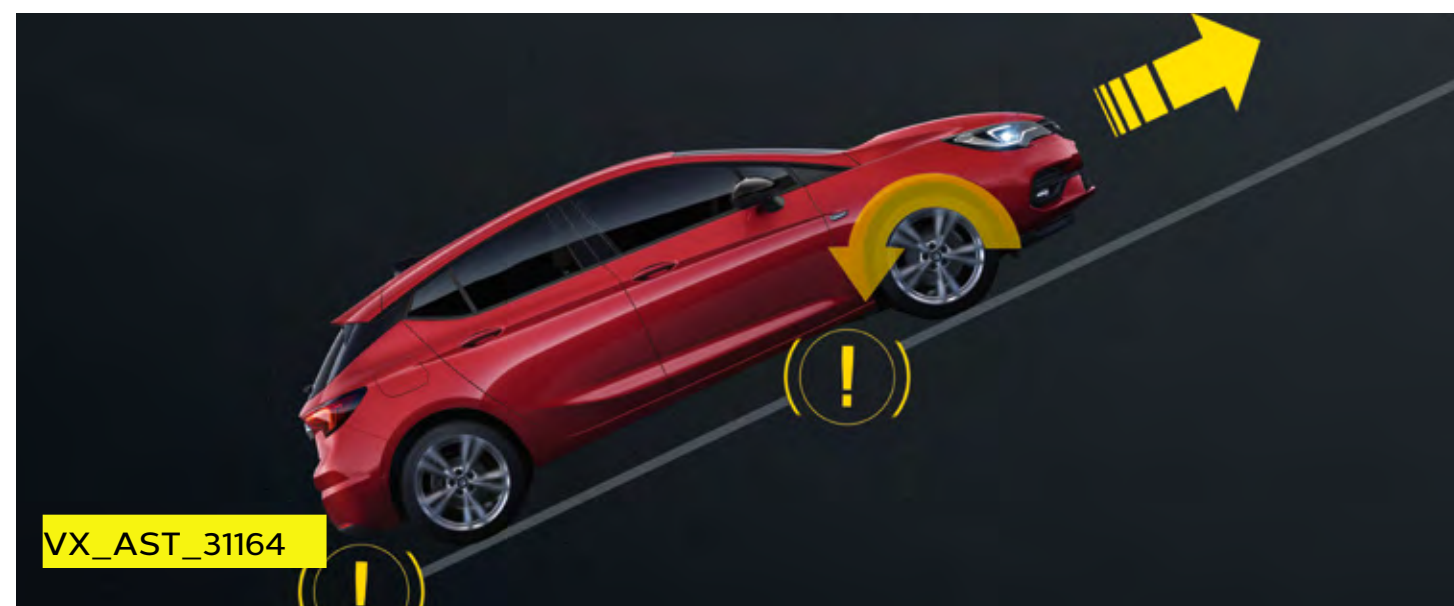

Hill start assist.



ISOFIX child seat mountings.



Automatic emergency braking (see next page as part of Driving Assistance Pack).

Driver Assistance

Standard Features – The following features are standard across the entire Astra range.
Specific features by model are outlined in the separate tabular information.

Cruise control with speed limiter

With steering wheel mounted controls. Enables you to maintain a constant speed, making it ideal for economical motorway driving.

Steering

- Speed sensitive electrically assisted power steering

Wipers

- Two-speed windscreen wipers with variable intermittent wipe
- Intermittent rear window wash/wipe
- Rain sensitive windscreen wipers

Model Specific Features/Options

	Business Edition Nav	SRI Nav	Griffin Edition	Elite Nav Premium
Driver Assistance				
Rear view camera, digital				●
Electronic parking brake		●	●	●
Manual parking brake	●			
Front and rear parking distance sensors	£480*	£480*	●	●
Driving Assistance Pack – Following distance indicator/Forward collision alert/ Lane departure warning with lane assist/Automatic emergency braking		●	●	●
Speed sign recognition		£275*		£275*

*Optional at extra cost including VAT.

Driver Information and Security

Standard Features – The following features are standard across the entire Astra range.
Specific features by model are outlined in the separate tabular information.

Driver Information

Instrumentation

- Speedometer and rev counter
- Digital fuel gauge with low fuel level warning light
- Digital water temperature gauge with warning light
- Shift-up/down indication light – Indicates when to change gear for optimum fuel economy

Driver information display

(centrally located in instrument cluster)

- Trip computer data
- Total mileage
- Service-due indicator
- Oil life
- Tyre pressure monitoring system

Multi-function trip computer

(displayed on driver information display)

- Trip mileage
- Vehicle range based on remaining fuel
- Average speed
- Average fuel economy
- Instantaneous fuel economy
- Driving time

Central facia display

(format dependent on infotainment unit)

- Audio information
- Digital clock with automatic RDS time adjustment
- Outside air temperature with ice warning function
- Additional features dependent on infotainment unit (see infotainment for details)

Security

- ‘Key left in ignition’ audible warning
- Electronically protected audio equipment
- Engine deadlock immobiliser
- Visible Vehicle Identification Number (VIN)
- Locking wheel bolts for alloy wheels
- Freewheeling door locks

Remote control central locking

- Operates on doors, tailgate and fuel filler flap
- Deadlocking
- Central locking activation switch on driver’s door

Model Specific Features/Option

	Business Edition Nav	SRI Nav	Griffin Edition	Elite Nav Premium
Driver Information				
Driver information display (centrally located in instrument cluster) – 3.5-inch monochrome display	●	●	●	
Driver information display (centrally located in instrument cluster) – 8-inch colour display incorporating speedometer and supplementary audio, phone and navigation information				●
Security				
Remote control ultrasonic security alarm system	£260*	●	●	●
Keyless entry and start				●

*Optional at extra cost including VAT.

Convenience

Standard Features – The following features are standard across the entire Astra range.
Specific features by model are outlined in the separate tabular information.

Interior Convenience

- Front 12-volt electrical accessory socket
- Driver's and front passenger's sunvisors
- Dipping rear-view mirror
- Reach and rake-adjustable steering
- Steering wheel audio/phone/cruise controls
- Front centre armrest with storage

Heating and Ventilation

- Four adjustable facia vents
- Windscreen and side window demist vents
- Heated rear screen with timed cut-off

Interior Storage

- Fold out storage box on driver's side lower facia
- Glovebox with lid
- Front door pockets
- Two drinks holders in centre console
- Rear door pockets
- Storage compartment in centre console

Model Specific Features/Options

	Business Edition Nav	SRI Nav	Griffin Edition	Elite Nav Premium
Interior Convenience				
Automatically dimming anti-dazzle rear-view mirror		●	●	●
Storage pockets on front seat backs		●	●	●
Twin rear USB sockets*		£50 [†]		£50 [†]
Soundproofed insulated windscreen		●	●	●
Heating and Ventilation				
Air conditioning	●			
Dual-zone electronic climate control with humidity sensor		●	●	●
Winter Pack 1 – Heated leather-covered steering wheel/Heated front seats/ Rear floor heating ducts		£460 [†]	●	No-cost ^{††}
Winter Pack 2** – Heated leather-covered steering wheel/Heated front seats/ Rear floor heating ducts/Twin rear USB sockets				●
Heated windscreen (Requires Dual-zone climate control and Winter Pack 1)		£320 [†]		£320 [†]

*Included with Winter Pack 2. Can only be ordered separately with optional Alcantara trim. **Not available with optional Alcantara trim. [†]Optional at extra cost including VAT. ^{††}Only available with optional Alcantara cloth trim.

Convenience

Standard Features – The following features are standard across the entire Astra range.
Specific features by model are outlined in the separate tabular information.

Luggage Area

- Luggage compartment cover (Hatchback only)
- Luggage compartment retractable cover (Sports Tourer only)
- Illuminated load area
- Fully carpeted load area
- Interior tailgate handle
- Four load restraint lashing eyes
- Twin gas-assisted tailgate struts

Interior Lighting

- Central front courtesy light
- Central rear courtesy light
- Fade up/fade down
- Interior Light Pack
 - Interior ambient lighting
 - Illuminated vanity mirrors
 - Rear reading spotlights

Exterior Convenience

Door mirrors

- Twin electrically adjustable/heated door mirrors
- Manually folding door mirrors

Windows

- Electrically operated front and rear windows with safety autoreverse and one-touch up/down facility
- Heated rear window
- Solar heat-absorbing windscreen
- Tinted windows

Model Specific Features

	Business Edition Nav	SRI Nav	Griffin Edition	Elite Nav Premium
Interior Lighting				
Ambient LED fascia/centre console downlighter		●	●	●
Ambient LED lighting in front doors		●	●	●

Exterior Style

Standard Features – The following features are standard across the entire Astra range.
Specific features by model are outlined in the separate tabular information.

Exterior Styling

- Chrome-effect headlight detail
- Black door mirrors
- Body-colour door handles
- Body-colour rear roof spoiler

Model Specific Features

	Business Edition Nav	SRI Nav	Griffin Edition	Elite Nav Premium
Exterior Styling				
Black upper window surround	●	●		
Chrome-effect upper window surround			●	●
Gloss black roof			●	
Body-colour roof	●	●	No-cost	●
Dark-tinted rear windows			●	
Black roof rails (Sports Tourer only)	●			
Silver-effect roof rails (Sports Tourer only)		●	●	
Matt black B-pillars/Gloss black C-pillars	●			
Gloss black B-pillars/Gloss black C-pillars		●	●	●
Shark fin aerial				●

Exterior Lighting

Standard Features – The following features are standard across the entire Astra range.
Specific features by model are outlined in the separate tabular information.

Exterior Lighting

- LED daytime running lights
- Automatic lighting control: When the automatic lighting control is switched on, the system switches between daytime running lights and headlights automatically depending on external lighting conditions
- LED side repeat indicators
- Lights-on audible warning – When driver's door is opened an audible warning sounds to alert the lights have been left on
- Manual headlight beam levelling. Use to adapt headlight range to the vehicle load to prevent dazzling*
- High-level LED centre rear brake light
- Rear fog light
- Reversing light
- Hazard warning lights
- Door-to-door illumination: Headlights illuminate the area for an adjustable time after leaving the vehicle

Model Specific Features/Options

	Business Edition Nav	SRI Nav	Griffin Edition	Elite Nav Premium
Exterior Lighting				
Halogen headlights	●			
LED headlights		●	●	●
Front fog lights	£180**	●	●	£180**
IntelliLux LED® Matrix headlights with anti glare high beam/LED tail lights/ Automatic headlight levelling system/Adaptive forward lighting		£1,500**		£1,500**



LED headlight.



IntelliLux LED® Matrix headlight.



LED tail lights.

*Not available when IntelliLux LED® Matrix is ordered. **Optional at extra cost including VAT.

Infotainment

Standard Features

Multimedia Navi with 7-inch touchscreen

Standard on Business Edition Nav, SRi Nav and Griffin Edition models

Onboard features:

- 7-inch colour touchscreen
- Satellite navigation system
- 2D/3D street level mapping
- European coverage
- Points-of-interest search
- Map updates via USB
- DAB Digital radio
- RDS with Traffic Programme
- AM/FM stereo radio with 36 station presets
- Six speakers

Media connections:

- USB connection with iPod control
- Bluetooth® A2DP audio streaming (Advanced Audio Distribution Profile)

Mobile phone portal:

- Bluetooth® connectivity
- Vehicle microphone
- Handsfree calls via steering wheel controls
- Phone book access – Contacts/last calls/missed calls etc are mirrored on the display and are easily navigated using the touchscreen (features dependent on mobile phone)
- SMS read out and reply

Smartphone interface

- Apple CarPlay
- Android Auto™
- Smartphone projection that allows operations via voice command, touchscreen and buttons to control apps and music playback

Additional features

- Steering wheel mounted audio controls
- Flexible roof-mounted aerial

Please note that compatibility and certain functions may be different depending on the type of device and operating system you're using with the Multimedia systems. Apple CarPlay is a trademark of Apple Inc. Apple and iPhone are trademarks of Apple Inc., registered in the U.S. and other countries. Android is a trademark of Google Inc, also registered in the U.S. and other countries.



VX_AST_30212

7-inch colour touchscreen.



VX_AST_30276

Satellite navigation system.

Infotainment

Standard Features

Multimedia Navi Pro with 8-inch touchscreen

Standard on Elite Nav Premium models

Features as Multimedia Navi, with the addition of:

Onboard features:

- 8-inch colour touchscreen
- 8-inch digital colour instrument display

Additional features:

- Shark fin aerial
- SD card slot

Optional at extra cost including VAT – £600

- Bose sound system



VX_AST_30279

8-inch colour digital information display.



VX_AST_31402

Bose sound system.

Interior Styling and Comfort

Business Edition Nav



Steering wheel:

- Three-spoke design
- Satin chrome-effect bezel

Facia and door trim:

- Black facia with Antelao Sand trim inserts
- Instrument panel bar Polar Silver
- Antelao Sand trim inserts on front doors
- Metallic silver Raute trim inserts
- Chrome-effect interior door handles

Seating:

- Driver's seat (six-way adjustable):
 - Height
 - Reach
 - Backrest
 - Head restraint
- Front passenger's seat (four-way adjustable):
 - Height
 - Reach
 - Backrest
 - Head restraint
- 60/40 split-folding rear seat back

Seat trim:

- Talino fabric seat trim inserts
- Plain black fabric side bolsters and surrounds

Optional seating at extra cost including VAT - £320

Seating:

- Driver's ergonomic active sports-style seat (AGR-approved*) (eight-way adjustable):
 - Height
 - Reach
 - Tilt
 - Backrest
 - Seat cushion extension
 - Head restraint
 - Lumbar adjustment (four-way electrical)
- Front passenger's sports-style seat (four-way adjustable):
 - Height
 - Reach
 - Backrest
 - Head restraint
- Storage pockets on front seat backs
- 60/40 split-folding rear seat back

Seat trim:

- Formula fabric seat trim inserts
- Plain black fabric side bolsters and surrounds

VX_AST_30212

Interior Styling and Comfort

SRi Nav/Griffin Edition



Steering wheel:

- Three-spoke design
- Heated leather-covered with accent stitching
- Satin chrome-effect bezel

Facia and door trim:

- Black facia with Piano Black trim inserts
- Instrument panel bar Satin Chrome
- Silver air vent surrounds
- Black door panels with black Atlantis cloth inserts
- Piano Black trim inserts on front doors
- Chrome-effect interior door handles

Seating:

- Ergonomic active sports-style driver's seat (AGR-approved*) (eight-way adjustable):
 - Height
 - Reach
 - Tilt
 - Backrest
 - Seat cushion extension
 - Head restraint
 - Lumbar adjustment (four-way electrical)
- Front passenger's seat (four-way adjustable - SRi Nav, six-way adjustable - Griffin Edition):
 - Height
 - Reach
 - Backrest
 - Head restraint
- 60/40 split-folding rear seat back
- Heated front seats

Seat trim:

- Elegance fabric seat trim inserts
- Premium leather-effect side bolsters and surrounds

VX_AST_31797

Interior Styling and Comfort

Elite Nav Premium



Steering wheel:

- Three-spoke design
- Heated leather-covered with accent stitching
- Satin chrome-effect bezel

Facia and door trim:

- Black facia with Piano black trim inserts
- Instrument panel bar Satin Chrome
- Silver air vent surrounds
- Black door panels with black leather-effect inserts
- Piano black trim inserts on front doors
- Chrome-effect interior door handles

Seating:

- Ergonomic active sports-style front seats (AGR-approved)*
- Driver's seat (eighteen-way adjustable)
 - Height (electrical) - Reach (electrical)
 - Tilt (electrical) - Backrest (electrical)
 - Seat cushion extension
 - Lumbar adjustment (four-way electrical)
 - Head restraint
 - Active ventilation
 - Pneumatically adjustable backrest side bolsters
 - Massage and memory seat adjuster functions

- Front passenger's seat (Eight-way adjustable)
 - Height - Reach - Backrest
 - Seat cushion extension
 - Head restraint
 - Lumbar adjustment (four-way electrical)
 - Active ventilation
- Heated front seats
- 60/40 split-folding rear seat back

Seat trim:

- Black Siena perforated leather seat trim inserts
- Black leather-effect side bolsters and surrounds

Optional seating (NO-COST OPTION)

- Ergonomic active sports-style front seats
- Driver's and front passenger's seat (eight-way adjustable):
 - Height
 - Reach
 - Backrest
 - Seat cushion extension
 - Head restraint
 - Lumbar adjustment (four-way electrical)

Seat trim:

- Black Alcantara cloth seat trim inserts
- Black leather-effect side bolsters and surrounds

VX_AST_31616

Exterior Colours

Sovereign Silver (GAN)*
Two-coat metallic paint £550



VX_AST_31172

Summit White (GAZ)**
Brilliant paint £320



VX_AST_31173

Cosmic Grey (GR5)**
Two-coat metallic paint £550



VX_AST_31177

Mineral Black (GB9)†
Two-coat metallic paint £550



VX_AST_31176

Navy Blue (G4B)††
Two-coat metallic paint £550



VX_AST_31175

Hot Red (G1R)**
Two-coat premium paint £650



VX_AST_31174



The colours reproduced may vary slightly from the actual paint colour. As a result they should be used as a guide only. Your Vauxhall Retailer has a comprehensive display of our paint samples.

Please note, vehicles illustrated are not model specific and are for illustrative purposes only.

*Standard exterior paint. Optional at extra cost including VAT on Griffin Edition models. **Optional at extra cost including VAT. †Standard exterior paint on Griffin Edition models. Optional extra cost including VAT on all other models.

††Optional at extra cost including VAT. Not available on Griffin Edition models.

Wheels and Tyres

		Business Edition Nav	SRI Nav	Griffin Edition	Elite Nav Premium
 VX_AST_31180	16-inch silver five twin-spoke alloy wheels • 205/55 R 16 tyres	●			
 VX_AST_30254_RM5	17-inch silver five twin-spoke alloy wheels • 225/45 R 17 tyres		●		●
 VX_AST_30256_5PC	18-inch bi-colour ten twin-spoke alloy wheels • 225/40 R 18 tyres			●	
 VX_AST_25649_5PB	18-inch silver five twin-spoke alloy wheels • 225/40 R 18 tyres			No-cost	
Steel emergency spare wheel (in lieu of emergency tyre inflation kit). Loadspace capacity is reduced		£110*	£110*	£110*	£110*

*Optional at extra cost including VAT.

Petrol Engines

	1.2 (110PS) Turbo	1.2 (130PS) Turbo	1.2 (145PS) Turbo
Capacity	1199cc	1199cc	1199cc
Maximum power	110PS (81kW) @ 4500rpm	130PS (96kW) @ 5500rpm	145PS (107kW) @ 5500rpm
Maximum torque	195Nm (143lb.ft.) @ 2000-3500rpm	225Nm (165lb.ft.) @ 2000-3500rpm	225Nm (165lb.ft.) @ 2000-3500rpm
Configuration	3 cylinders, 4 valves per cylinder, double overhead camshafts	3 cylinders, 4 valves per cylinder, double overhead camshafts	3 cylinders, 4 valves per cylinder, double overhead camshafts
Fuel/induction system	Turbocharger. Variable Valve Timing (VVT). Spark ignited direct injection (SIDI)	Turbocharger. Variable Valve Timing (VVT). Spark ignited direct injection (SIDI)	Turbocharger. Variable Valve Timing (VVT). Spark ignited direct injection (SIDI)
Emission compliance	Euro 6d (6.3)	Euro 6d (6.3)	Euro 6d (6.3)
Service interval	20,000 miles or 1 year (whichever occurs sooner)	20,000 miles or 1 year (whichever occurs sooner)	20,000 miles or 1 year whichever occurs sooner)

Diesel Engines

	1.5 (105PS) Turbo D	1.5 (122PS) Turbo D with 6-speed manual	1.5 (122PS) Turbo D with 9-speed automatic
Capacity	1496cc	1496cc	1496cc
Maximum power	105PS (77kW) @ 3250rpm	122PS (90kW) @ 3500rpm	122PS (90kW) @ 3500rpm
Maximum torque	260Nm (191lb.ft.) @ 1500-2500rpm	300Nm (221lb.ft.) @ 1750-2500rpm	285Nm (210lb.ft.) @ 1500-2750rpm
Configuration	3 cylinders, 4 valves per cylinder, double overhead camshafts	3 cylinders, 4 valves per cylinder, double overhead camshafts	3 cylinders, 4 valves per cylinder, double overhead camshafts
Fuel/induction system	Turbocharger. Common rail fuel injection	Turbocharger. Common rail fuel injection	Turbocharger. Common rail fuel injection
Emission compliance	Euro 6d (6.3)	Euro 6d (6.3)	Euro 6d (6.3)
Service interval	20,000 miles or 1 year (whichever occurs sooner)	20,000 miles or 1 year (whichever occurs sooner)	20,000 miles or 1 year (whichever occurs sooner)

Performance, Fuel Economy and Emissions

	Performance (manufacturer's figures)		Fuel economy mpg (litres/100km) [#]		CO ₂ emissions g/km [#]		Vehicle Excise Duty*		BiK rates from - 2021/22 tax year
	Maximum speed (mph)	Acceleration 0-60mph (sec)	Combined Low	Combined High	Combined Low	Combined High	First year rate	Standard rate	
Hatchback									
1.2 (110PS) Turbo	124	10.2	47.1 (6.0)	54.3 (5.2)	119	126	£180	£155	27%
1.2 (130PS) Turbo	134	9.9	47.1 (6.0)	54.3 (5.2)	119	125	£180	£155	27%
1.2 (145PS) Turbo	137	9.7	47.1 (6.0)	54.3 (5.2)	119	126	£180	£155	27%
1.5 (105PS) Turbo D	124	10.2	60.1 (4.7)	65.7 (4.3)	113	120	£180	£155	26%
1.5 (122PS) Turbo D	130	9.7	57.7 (4.9)	64.2 (4.4)	115	123	£180	£155	27%
1.5 (122PS) Turbo D auto	127	10.2	50.4 (5.6)	56.5 (5.0)	133	138	£220	£155	27%
Sports Tourer									
1.2 (130PS) Turbo	134	9.9	50.4 (5.6)	53.3 (5.3)	119	137	£180	£155	27%
1.2 (145PS) Turbo	137	9.7	50.4 (5.6)	54.3 (5.2)	119	137	£180	£155	27%
1.5 (122PS) Turbo D	130	9.9	60.1 (4.7)	64.2 (4.4)	116	128	£180	£155	27%
1.5 (122PS) Turbo D auto	127	10.4	50.4 (5.6)	55.4 (5.1)	133	147	£220	£155	30%

[#]Figures shown are for comparison purposes and should only be compared to the fuel consumption and CO₂ values of other cars tested to the same technical standard. The fuel consumption achieved, and CO₂ produced, in real world conditions will depend upon a number of factors including, but not limited to: the accessories fitted (pre and post registration); variations in weather; driving styles and vehicle load. The WLTP (Worldwide Harmonised Light Vehicles Test Procedure) is used to measure fuel consumption and CO₂ figures. The CO₂ figures display a range to reflect the highest value for the highest emitting version with all available options added, through to a minimum value to represent the lowest emitting version in standard specification.

*Correct at time of publication.

Weights and Towing Data^{kg}

	Gross vehicle weight		Maximum towing weights Trailer with brakes (without brakes)	
	Hatchback	Sports Tourer	Hatchback	Sports Tourer
1.2 (110PS) Turbo	1805	-	1220 (620)	-
1.2 (130PS) Turbo	1805	1870	1350 (620)	1250 (660)
1.2 (145PS) Turbo	1805	1870	1350 (620)	1250 (660)
1.5 (105PS) Turbo D	1880	-	1300 (660)	-
1.5 (122PS) Turbo D	1880	1945	1450 (660)	1450 (680)
1.5 (122PS) Turbo D 9-speed auto	1920	1980	1350 (660)	1250 (680)

Please note: Gross vehicle weight is the total permissible weight of the vehicle including passengers and their luggage. The maximum roof rack loading should not exceed 75kg. The maximum towing weights are based on the ability of the car, with two occupants of 75kg each, to restart on a 12% gradient, which is approximately 1 in 8.3, at sea level. The permitted trailer load applies up to the specified incline and up to an altitude of 1000 metres above sea level. The permissible gross train weight decreases by 10% for every 1000 metres of additional altitude. At altitudes above 1500 metres, the engine output may drop with a corresponding reduction in towing capability. Any extra weight, such as luggage or additional passengers, should be deducted from the maximum towing weight. With a trailer fully loaded, maximum noseweight should not exceed 75kg. Always fit Vauxhall towing attachments and accessories available from your Vauxhall Retailer. They are designed specifically for Vauxhall models and carry a 12-month guarantee.

Specifications

Transmission

Six-speed manual gearbox

Petrol engines: 1.2 (110/130/145PS) Turbo models
Diesel engines: 1.5 (105/122PS) Turbo D models

9-speed automatic transmission

Available on the 1.5 (122PS) Turbo D, the 9-speed automatic transmission enables increased drive comfort and improved fuel economy. For extra reliability the transmission has been engineered with reducing the amount of splash losses, hydraulic losses and the amount of torsional vibrations.

Body

Aerodynamic drag co-efficient:
Hatchback – Cd 0.26
Sports Tourer – Cd 0.25

Fuel Tank Capacity

48 litres (10.5 gallons)

Braking and stability

- Electronic Stability Programme (ESP)
- Cornering brake control
- Straight line stability control
- Rollover mitigation
- Drag torque control
- Hill start assist
- Anti-lock Braking System (ABS)
- Emergency brake assist
- Fading brake support
- Electronic brakeforce distribution
- Adaptive brake lights

All models

Front ventilated discs: 276mm diameter
Rear discs: 264mm diameter

Steering

- Power-assisted steering
- Turning circle (wall-to-wall): – 11.05m (36.2ft.)

Suspension

Front: Independent. Lightweight MacPherson struts with gas-pressure dampers and coil springs. Anti-roll bar.

Rear: Lightweight compound crank rear axle with one-piece, hollow cast trailing arms. Built-in anti-roll bar. Progressive-rate double conical mini-block springs and gas-pressure dampers.

Dimensions and Capacities

All measurements in mm (inches) unless stated otherwise.

Loadspace Dimensions	Hatchback	Sports Tourer
Load floor length (rear seats folded)	1575 (62.0)	1705 (67.1)
Load floor length (behind rear seats)	828 (32.5)	1065 (41.9)
Load area width	1001 (39.4)	1050 (41.3)
Load area height	841 (33.1)	822 (32.3)
Tailgate aperture width (maximum)	1015 (39.9)	1032 (40.6)
Tailgate aperture height	600 (23.6)	747 (29.4)

Luggage Capacities Litres (cu.ft.)	Hatchback	Sports Tourer
Rear seat up (under luggage compartment cover)	370 (13.0)	540 (19.0)
Rear seat down (measured to roof)	1210 (42.7)	1630 (57.5)

*Measured using the ECIE method. When a spare wheel is specified loadspace capacity is reduced due to a raised luggage compartment floor.

Hatchback



Sports Tourer



Accessories

Safety	Total (inc. VAT)	Protection	Total (inc. VAT)	Comfort	Total (inc. VAT)	Transport solutions	Total (inc. VAT)
Philips ADR620 dash cam	£109	Floor mats (set of 4)		FlexConnect bracket	£20	Roof base carrier (set of 2 bars)	
Front parking sensors	£378	- Carpet	£36	FlexConnect hook	£27	- Hatchback	£185
Rear parking sensors	£378	- Rubber	£55	FlexConnect coat hanger	£40	- Sports Tourer	£232
Child seats ¹		- Velour	£66	FlexConnect folding table	£65	Roof carriers (requires base carrier)	
- Age group 0 (approx. 24 months/ up to 13kg)	£182	Cargo liner		FlexConnect iPad mini holder	£93	Roof box - Thule Ocean 80	£164
- ISOFIX base for age group 0 ²	£230	- Hatchback ³	£85	FlexConnect iPad holder	£103	Roof box - Thule Ocean 200	£374
- Age group 1 (approx. 1-3.5 years/9-18kg)	£510	- Sports Tourer	£96	FlexConnect iPad Air holder	£103	Roof box - Thule Touring 200	£428
- Age group 2/3 (approx. 3-12 years/ 15-36kg)	£186	Cargo net		FlexConnect Samsung Galaxy holder	£93	Roof box - Thule Touring 700	£492
Safety Pack - first aid kit, hi-vis vest and small warning triangle	£16	- Horizontal	£21	Privacy shades for Hatchback models (set of 2)		Roof box - Thule Motion 800	from £426
Warning triangle	£9	- Side wall	£17	- Rear window	£76	Bike carrier - Thule FreeRide 532	£81
Hi-vis safety vest - adult	£4	- Vertical (Sports Tourer only)	£76	- Side rear windows	£86	Bike carrier - Thule Expert 298	£134
Hi-vis safety vest - child 3-6 years (42cm)	£4	Load compartment storage tray (Hatchback only) ⁴	£82	Privacy shades for Sports Tourer models (set of 2)		Surfboard carrier - Thule 833	£82
Hi-vis safety vest - child 7-12 years (52cm)	£4	Dog guard (Sports Tourer only)	£217	- Rear window	£75	Ski/snowboard carrier	
First aid kit	£15	Splash guards		- Side rear windows	£85	- Thule Snow Pack 7324 (4 x pairs)	£143
Emergency seat belt cutter and hammer	£18	- Front	£54	Cup holder insert		Ski/snowboard carrier	
Spare bulb kit	£60	- Rear (Hatchback)	£61	- Miscellaneous	£9	- Thule Snow Pack 7326 (6 x pairs)	£258
Tyre repair kit	£82	- Rear (Sports Tourer)	£58	- Pen	£15	Towing	
Stretch tow rope	£20	Rear bumper protection foil	£67	- Notepad	£15	Tow bar	
		Style		Smoker's kit	£20	- Fixed ⁵	£619
		Stainless steel pedal covers		Fragrance diffuser	£23	- Detachable	from £573
		- Manual	£140	Fragrance cartridge (various)	£18	Alloy wheels⁶	
		Door sill plates				17-inch 10 V-spoke	£1,055
		- Stainless steel	£41			18-inch 10 double-spoke	£1,660
		- Illuminated	£173				
		Door mirror caps					
		- Black	£110				
		- Carbon effect	£139				
		- Brushed aluminium	£239				
		Valve covers with Vauxhall logo (set of 4)	£16				

Please note: Prices shown are fully fitted and painted, where applicable and include VAT. Please check with your local Vauxhall Retailer for details. It is advisable to ensure your insurance policy is adequate to cover additional fitted accessories. Prices correct at time of publication.

¹Restrictions apply to the use of child seats, please consult your vehicle user manual or Vauxhall Retailer. ²Restricted to rear seat usage only for vehicles with transponder deactivation of passenger airbag. ³For vehicles with spare wheel. For vehicles without spare wheel, load compartment storage tray required to use cargo liner. ⁴Not compatible with spare wheel. ⁵Available with 13-pin electrics. ⁶Different tyres and locking wheel bolts/nuts may be required at extra cost. Price excludes new tyres and locking wheel bolts/nuts, includes static wheel balancing.

Company Car Driver and Fleet Information

High spec, low P11D

As a business and company car driver, you'll find all of our models are seriously fit for fleet; we're talking very low P11D values, generous standard specification and high-tech engines designed for great fuel economy and low emissions – and that's just to get you started.

To get access to even more spec as standard, simply take a step up in the range – low P11D values will continue to apply.

Drivers and businesses all have unique requirements and by taking advantage of low whole-life costs and low company car driver taxation you can get in the driving seat with the spec to suit.

Company Car Driver Free 3 Day Test Drive

Our free* 3 Day Test Drive programme is open to all Company Car Drivers which allows you to choose any model in the current Vauxhall line-up (exclusions apply). With full insurance cover provided, it gives you a meaningful length of time to make an informed decision about your next company car.

Search Vauxhall 3DTD to book your free* test drive or click the link the below:

[Vauxhall 3 Day Test Drive](#)

*The free 3 Day Test Drive programme is open to Company Car Drivers and Fleet Decision Makers. Available for UK Mainland only. Terms and conditions apply. Full terms and conditions can be found at vauxhallfleet.co.uk/testdrive/index/terms.

Benefit in kind company car taxation**

The car benefit charge will be the car's list price (including VAT, options and accessories fitted, delivery to Retailer and number plates, but excluding Vehicle Excise Duty and new vehicle first registration fee) multiplied by the percentage charge for the CO₂ emissions band in which the car falls (see table opposite). Multiply this figure by your personal income tax rate (20%[†] for Basic Rate, 40%** for Higher Rate) to calculate your annual benefit in kind tax liability.

Example:

Astra Business Edition Nav 1.5 (105PS) Turbo D 5-door hatchback (CO ₂ emissions 113g/km)	
On-the-road RRP	£21,235.00
Deduct: Vehicle Excise Duty	(£180.00)
New vehicle first registration fee	(£55.00)
Effective list price	£21,000.00
Add: Optional two-coat metallic paint	£550.00
List price for tax purposes (P11D value)	£21,550.00
Car benefit charge 2021-22 tax year (26%)	£5,603.00
Benefit in kind tax liability (2021-22 tax year)	
Basic Rate (20%) tax payer	£1,120.60
Higher Rate (40%) tax payer	£2,241.20

**Please note this Price Guide provides taxation information as a guide only. Vauxhall does not provide taxation guidance. Drivers should always take professional advice on their own tax position.
[†]Excludes residents of Scotland.

BiK for Scottish Residents

Effective 6 April 2018 the Scottish Government have introduced their own BiK taxation structure. This only applies to Company Car Drivers that are Scottish taxpayers. HMRC will determine whether or not an individual is a Scottish taxpayer based on where their main place of residence is.

The BiK rates for Scotland are:

- Over £12,570–£14,667 Starter Rate 19%
- Over £14,667–£25,296 Basic Rate 20%
- Over £25,296–£43,662 Intermediate Rate 21%
- Over £43,662–£150,000 Higher Rate 41%
- Above £150,000 Top Rate 46%

CO ₂ emissions (g/km)	Percentage of cars price to be taxed 2021-22 tax year
Up to 50	13%
51-54	14%
55-59	15%
60-64	16%
65-69	17%
70-74	18%
75-79	19%
80-84	20%
85-89	21%
90-94	22%
95-99	23%
100-104	24%
105-109	25%
110-114	26%
115-119	27%
120-124	28%
125-129	29%
130-134	30%
135-139	31%
140-144	32%
145-149	33%
150-154	34%
155-159	35%
160-164	36%
165-169	37%
170+	37%

Fleet Toolbox

Discover the facts in our online Toolbox for both Company Car Drivers and Fleet Decision Makers. The Fleet Toolbox has a host of useful calculators, comparators, interactive listings and information.

Search Vauxhall Fleet Tools or click the link below:

[Vauxhall Fleet Tool Box](#)

Contact Vauxhall Fleet

Please contact one of our dedicated sales teams who will be happy to help with your particular enquiry.

Company Car Drivers

Call: 0345 111 2020

Email: company-car@vauxhallinfo.co.uk

Telephone lines are open

– Monday to Friday 8:00am–9:00pm

– Saturday and Sunday 9:00am–6:00pm

Fleet Decision Makers

Depending on the size of your fleet of vehicles, we have a dedicated team to handle your enquiries. The lines are open Monday to Friday excluding Bank Holidays.

1-24 vehicles

Call: 0845 076 2254 (8:30am–5:00pm)

25+ vehicles

Call: 0330 587 8222 (8:30am–5:00pm)

Email: vauxhallfleet@vauxhall.co.uk

Special Vehicles (Police, Fire and Ambulance)

Call: 01582 409999 (8:30am–5:00pm)

Email: vauxhallspecialvehicles@vauxhall.co.uk

To calculate your own personal liability, search:

Vauxhall BiK, or click the link below:

[Vauxhall BiK Tool](#)

Further Information

On-the-road prices

To eliminate uncertainty about hidden costs when buying a new car, Vauxhall publishes on-the-road recommended retail prices (RRP) and these are shown in the pricing tables within this price guide. These prices include VAT, number plates and delivery to Retailer of £700.00 (including £116.67 VAT), 12 months' Government Vehicle Excise Duty (see opposite for details) and the DVLA new vehicle first registration fee of £55.00.*

Please note: The on-the-road recommended retail price (RRP) does not include fuel supplied by the Retailer, motor insurance or any other goods or services supplied by agreement between the Retailer and the customer.

Price protection

Order a new Vauxhall for build in the current model year (as confirmed by your Retailer) for delivery no more than three months in advance and the price you are quoted is the price you pay. This is irrespective of any subsequent price rises between placing your order and delivery of your new car, but you must take delivery as soon as the car is available.

Please note: Price protection does not apply to Mokka-e/Corsa-e/Grandland X hybrid models. Vauxhall Motors Limited is not liable for price adjustments caused by Government changes in the rate of VAT (currently 20%), Vehicle Excise Duty, DVLA new vehicle first registration fee or by any other applicable legislation or regulations.

In the event of an accident

Vauxhall Accident Management helps keep you mobile following an accident. Benefits include vehicle recovery, Vauxhall-approved repairs and contacting your insurer. For more details, visit vauxhall.co.uk/AccidentManagement

Free2Move Lease

Whether you're a big company or a small business looking for vehicle financing, Free2Move Lease, our business finance specialists, can deliver exactly what you need.

Free2Move Lease is one of the UK's largest leasing companies and is also a member of the British Vehicle Rental and Leasing Association (BVRLA).

With over 60,000 vehicles in the Free2Move Lease portfolio, Free2Move Lease is able to offer competitive vehicle solutions. In addition, Free2Move Lease also offer innovative connected management of servicing and maintenance.

For further information, please contact your local Vauxhall Retailer or visit vauxhall.co.uk/offers-finance/business-leasing.html

Vehicle Excise Duty

The amount of Vehicle Excise Duty (road fund licence) payable on new cars varies depending on the level of carbon dioxide (CO₂) emissions produced by the vehicle. CO₂ emissions are measured in grams per kilometre (g/km) travelled and divided into 13 charging bands shown in the table opposite.

A 'first year rate' of Vehicle Excise Duty is payable on all new cars and in subsequent years the amount payable reverts to the 'standard rate'. From 1 April 2017 the breakpoints for each of these bands have been revised. Also, for vehicles with a list price over £40,000, including factory-fitted options, an additional £335 is payable for the first five years of standard rate payments.

Vehicle Excise Duty*

Band	CO ₂ emissions in grams per kilometre	First year rate Petrol/Diesel	Standard rate Petrol/Diesel
A	0	£0	£0
B	1-50	£10	£155
C	51-75	£25	£155
D	76-90	£115	£155
E	91-100	£140	£155
F	101-110	£160	£155
G	111-130	£180	£155
H	131-150	£220	£155
I	151-170	£555	£155
J	171-190	£895	£155
K	191-225	£1,345	£155
L	226-255	£1,910	£155
M	Over 255	£2,245	£155

*Correct at time of issue.

Further Information

Customer Care Commitment

For added peace of mind, Vauxhall has an innovative Customer Care Commitment that offers the following:

- Three-year vehicle warranty consisting of a one-year/unlimited mileage manufacturer's warranty and a second and third year manufacturer's warranty with a 60,000 miles limitation
- Vauxhall Assistance for 12 months from first registration
- Six years' body panel anti-perforation warranty

Please note: Warranty is only available on vehicles sourced from Vauxhall Motors Limited. Terms and conditions apply – please see your Vauxhall Retailer for details.

Vauxhall Assistance

Vauxhall Assistance is provided automatically with every new Vauxhall for 12 months from first registration and covers everything from accident assistance, roadside recovery and 'at home' service to flat tyres. Even more reason for you to stay calm and let us take care of everything should the need arise. With Vauxhall Assistance help is literally just a free* phone call away, 24 hours a day, 365 days a year!

Protecting the environment

Vauxhall's commitment to the environment is demonstrated by our products' many environmental awards. For even more information on Vauxhall's efforts to achieve an environmentally sustainable future, and how to dispose of your end-of-life vehicle, see vauxhall.co.uk/recycling

Vauxhall Care

This all-inclusive service package is available on Vauxhalls under 10 months old (from date of first registration).

This package offers complete peace of mind for the first 3 years of your Vauxhall's life with fixed monthly payments for the plan duration.

- **3 years' Vauxhall servicing** – covers first, second and third annual services. Including a brake-fluid change in the second service
- **2 years' Vauxhall Roadside Assistance** – first year from us
- **First years' MOT**** – free of charge by your local Vauxhall Retailer

For full terms and conditions and to sign up, visit: vauxhall.co.uk/vauxhallcare

Vauxhall Service Club

Vauxhall Service Club is available for all Vauxhall owners, and it's free to join. Members benefit from the following:

- 15% off Vauxhall Approved Accessories
- Vauxhall's aged 2-3 Years = 15% off parts and labour
- Vauxhall's aged over 3 Years = 25% off parts and labour
- Half price MOT's (NI excluded)
- Free pre-MOT test inspection (NI only)
- Fixed price AdBlue® Refills
 - Car = £14.99
 - Van = £24.99
- Access to the Vauxhall Accident Management Programme
- Online service booking available 24/7 with servicing appointments available within 3 days – [Book Online](#)
- Collection and delivery/onward mobility options
- Complimentary 'Wash and Vac' with all routine services†
- Vauxhall trained technicians
- Genuine Vauxhall parts
- Minimum 12 months warranty on parts and labour
- Regular newsletters with exclusive offers, discounts and competitions

Terms and conditions apply. To join visit: vauxhall.co.uk/serviceclub

Vauxhall Insurance with added reassurance

Comprehensive cover – Summary of benefits

- Competitive premiums
- Repairs by a Vauxhall-trained technician
- Genuine Vauxhall parts, guaranteed for five years when we repair your car within our Approved Repairer Network
- Free courtesy car as standard when using an Approved Repairer††
- 24 hour claims helpline
- Personal Accident benefit
- Cover for audio equipment
- Windscreen cover

Call for a quote on **0330 678 1130‡**

For more product information

For further information on the Vauxhall range or location of your nearest Vauxhall Retailer please call **0345 600 1500**. Alternatively, details can be found on our website at vauxhall.co.uk

For more information call **0345 600 1500**

For Fleet enquiries call **0330 587 8222**

Discover the full Vauxhall range at **[vauxhall.co.uk](https://www.vauxhall.co.uk)**

Join us online

The invoice price, including delivery to Retailer, factory-fitted options, accessories fitted by the Retailer and number plates, is subject to VAT. Some feature descriptions in this guide may refer to, and some illustrations may show, optional equipment not included in the standard delivery. The information contained in this guide was accurate at the time of publication. We reserve the right to make changes in design and equipment. Please note that Vauxhall Retailers are not the agents of Vauxhall Motors Limited and are not authorised to bind Vauxhall Motors Limited by any specific or implied undertaking or representation. It is advisable to ensure that your motor insurance policy provides adequate cover for additional fitted options and accessories. The colours in this guide are only approximate actual colours. Illustrated optional equipment is available at extra charge. Availability, technical features and equipment provided on our vehicles can vary by model. For precise information on the equipment provided on our vehicles, please contact your local Vauxhall Retailer.

VAUXHALL

Price and Specification Guide
7 April 2021 | Model Year 2021D



New Insignia

Contents

To find the information you want use the links below to navigate around the guide:

[Choose your Trim Level](#)

[Range Highlights](#)

[Models](#)

[Prices](#)

[Features/Options](#)

[Infotainment](#)

[Interior Style and Comfort](#)

[Exterior Colours](#)

[Wheels and Tyres](#)

[Engines and Technical Data](#)

[Performance, Economy and Emissions](#)

[Specifications](#)

[Dimensions and Capacities](#)

[Accessories](#)

[Company Car Information](#)

[Further Information](#)

Choose Your Trim Level

SE Nav

VX_INS_30927



The SE Nav starts the line-up, giving you plenty of great features as standard.

SRi Nav

VX_INS_30928



The SRi Nav gives you a real sporty feel, with looks to match.

SRi VX-Line Nav

VX_INS_31906



Step up to the SRi VX-Line Nav and really turn heads. With a sporty attitude inside and out, and plenty of eye-catching features.

Ultimate Nav

VX_INS_30930



Look good and feel good in the Ultimate Nav, with striking looks and premium comfort features as standard.

GSi

VX_INS_30931



The GSi comes with plenty of extras and the most powerful engine in the range. Plus the reassurance of four-wheel drive.

New Insignia Range Highlights

SE Nav

Standard features include:

- Multimedia Navi infotainment system
 - Fully integrated sat nav system
 - 7-inch colour touchscreen
 - AM/FM/DAB digital radio
 - Bluetooth® audio streaming
 - Bluetooth® mobile phone portal
 - Apple CarPlay/Android Auto™
 - Twin front USB sockets and aux in
- Seven speakers (five front, two rear)
- Dual zone electronic climate control
- Multi-function trip computer
- Cruise control with intelligent speed limiter
- Front and rear parking sensors
- Ergonomic active driver's seat (AGR-approved*)
- Sports front seats
- Leather-covered steering wheel
- Front centre armrest
- Steering wheel audio/phone/cruise controls
- Steering column adjustable for reach/rake
- LED headlights and tail lights
- LED daytime running lights
- 17-inch five twin-spoke alloy wheels
- Electrically operated windows
- Electrically adjustable/heated door mirrors
- 60/40 split-folding rear seat back
- Automatic emergency braking
- Forward collision alert
- Following distance indicator
- Lane departure warning
- Electronic Stability Programme (ESP)
- Anti-lock Braking System (ABS)
- Six airbags • Hill start assist
- ISOFIX child seat mounting points, outer rear seats
- Remote control central locking
- Security alarm system
- Rain-sensitive windscreen wipers
- Auto-dimming rear-view mirror
- Automatic lighting control
- High beam assist • Front fog lights
- Traffic sign recognition
- 3.5-inch monochrome information display

SRi Nav

Features over SE Nav models:

- FlexFold 40/20/40 split-folding rear seat back with one touch release
- Ergonomic active front seats (AGR-approved*)
- Illuminated vanity mirrors
- LED ambient lighting
- Rear spoiler
- Gloss black lower side window trim
- Chrome-effect upper window trim
- Premium leather-effect side bolsters
- Rear centre armrest

SRi VX-Line Nav

Features over SRi Nav models:

- Multimedia Navi Pro infotainment system
 - 8-inch colour touchscreen
 - On-board voice control
- IntelliLux LED® Pixel headlights
- Leather seat facings
- Dark-tinted rear windows
- 20-inch bi-colour, five twin-spoke alloy wheels
- Keyless entry and start
- Twin rear USB sockets
- Wireless charger
- Sports-style front and rear bumpers
- Alloy sports pedals
- VX-Line, heated, flat-bottomed leather steering wheel
- 8-inch colour information display
- Shark fin aerial
- Heated front seats
- Driver's seat massage and memory functions
- Bose premium audio system

Ultimate Nav

Features over SE Nav models:

- Multimedia Navi Pro infotainment system
 - 8-inch colour touchscreen
 - On-board voice control
- IntelliLux LED® Pixel headlights with anti-glare high beam
- Heated front and outer rear seats
- Illuminated vanity mirrors
- LED ambient lighting
- Gloss black lower side window trim
- Chrome-effect upper window trim
- Door sill covers
- FlexFold 40/20/40 split-folding rear seat back
- 18-inch bi-colour, multi-spoke alloy wheels
- Keyless entry and start
- Dark-tinted rear windows
- Electrically foldable door mirrors
- Alloy sports pedals
- Heated, flat-bottomed leather steering wheel
- 8-inch colour information display
- Shark fin aerial
- Electrically foldable door mirrors
- Ergonomic active front seats (AGR-approved*)
- Heated windscreen
- Twin rear USB sockets
- Wireless charger
- Driver's seat massage and memory functions

GSi

Features over Ultimate Nav:

- Premium ergonomic active front seats (AGR-approved*)
- Front passenger's seat massage and memory functions
- 20-inch bi-colour, multi-spoke diamond-cut alloy wheels
- Four-wheel drive
- Red brake calipers
- Exterior Styling Pack
 - Sports-style front and rear bumpers
 - Side sills
 - Dual stainless steel exhaust tailpipes
- Leather seat facings
- Two additional rear side airbags
- FlexRide adaptive chassis
- Paddle shift
- GSi rear spoiler

Please note: GSi models do not feature front fog lights.

New Insignia SE Nav

VX_INS_30927



SE Nav

OTR from £24,130

Infotainment:

- Multimedia Navi system
 - Fully integrated European sat nav system
 - 7-inch colour touchscreen
 - AM/FM/DAB digital radio
 - Bluetooth® audio streaming
 - Bluetooth® mobile phone portal
 - Apple CarPlay/Android Auto™
 - Twin front USB sockets and aux in
- Seven speakers (five front, two rear)

Interior convenience/styling:

- Ergonomic active driver's seat (AGR-approved*)
- Sport front seats
- Dual-zone electronic climate control
- Multi-function trip computer
- Cruise control with intelligent speed limiter
- Leather-covered steering wheel
- Front centre armrest
- Steering wheel audio/phone/cruise controls
- Steering column adjustable for reach/rake
- 3.5-inch monochrome information display
- 60/40 split-folding rear seat back

Exterior convenience/styling:

- 17-inch five twin-spoke alloy wheels
- Electrically operated front/rear windows
- Electrically adjustable/heated door mirrors
- Front and rear parking sensors
- LED headlights and tail lights
- Front fog lights
- Ambient LED lighting
- Sight and Light pack
 - Rain sensitive windscreen wipers
 - Auto-dimming rear-view mirror
 - Automatic lighting control with tunnel detection
 - High beam assist

Safety/security:

- Driving Assistance Pack
 - Automatic emergency braking
 - Forward collision alert
 - Following distance indicator
 - Lane departure warning with lane assist
- Electronic Stability Programme (ESP)
- Anti-lock Braking System (ABS)
- Six airbags
- Hill start assist
- ISOFIX child seat mounting points, outer rear seats
- Tyre pressure monitoring system
- LED daytime running lights
- Remote control central locking
- Security alarm system
- Traffic sign recognition

New Insignia SRi Nav

VX_INS_30928



SRi Nav

OTR from £25,630

Infotainment:

- Multimedia Navi system
 - Fully integrated European sat nav system
 - 7-inch colour touchscreen
 - AM/FM/DAB digital radio
 - Bluetooth® audio streaming
 - Bluetooth® mobile phone portal
 - Apple CarPlay/Android Auto™
 - Twin front USB sockets and aux in
- Seven speakers (five front, two rear)

Interior convenience/styling:

- Ergonomic active sports front seats (AGR-approved*)
- Dual-zone electronic climate control
- Multi-function trip computer
- Cruise control with intelligent speed limiter
- Leather-covered steering wheel
- Front centre armrest
- Steering wheel audio/phone/cruise controls
- Steering column adjustable for reach/rake
- Illuminated vanity mirrors
- Storage pockets on front seat backs
- LED ambient lighting
- 3.5-inch monochrome information display
- FlexFold 40/20/40 split-folding rear seat back with one-touch release
- Rear centre armrest

Exterior convenience/styling:

- 17-inch five twin-spoke alloy wheels
- Front fog lights
- Gloss black side window trim
- Chrome-effect upper window trim
- Electrically operated front/rear windows
- Electrically adjustable/heated door mirrors
- Rear spoiler
- Front and rear parking sensors
- LED headlights and tail lights
- Sight and Light pack
 - Rain sensitive windscreen wipers
 - Auto-dimming rear-view mirror
 - Automatic lighting control with tunnel detection
 - High beam assist

Safety/security:

- Driving Assistance Pack
 - Automatic emergency braking
 - Forward collision alert
 - Following distance indicator
 - Lane departure warning with lane assist
- Electronic Stability Programme (ESP)
- Anti-lock Braking System (ABS)
- Six airbags
- Hill start assist
- ISOFIX child seat mounting points, outer rear seats
- Tyre pressure monitoring system
- LED daytime running lights
- Remote control central locking
- Security alarm system
- Traffic sign recognition

New Insignia SRi VX-Line Nav

VX_INS_31906



SRi VX-Line Nav

OTR from
£29,055

Infotainment:

- Multimedia Navi Pro system
 - Fully integrated European sat nav system
 - 8-inch colour touchscreen
 - AM/FM/DAB digital radio
 - Bluetooth® audio streaming
 - Bluetooth® mobile phone portal
 - Apple CarPlay/Android Auto™
 - Twin front USB sockets and aux in
- Seven speakers (five front, two rear)
- Bose premium audio system

Interior convenience/styling:

- Perforated leather seat facings
- Ergonomic active sports front seats (AGR-approved*)
- Dual-zone electronic climate control
- Heated front seats
- Multi-function trip computer
- Cruise control with intelligent speed limiter
- Steering wheel audio/phone/cruise controls
- Steering column adjustable for reach/rake
- Twin rear USB sockets
- Wireless charger
- Auto-dimming rear-view mirror
- Illuminated vanity mirrors
- LED ambient lighting
- 8-inch colour information display
- FlexFold 40/20/40 split-folding rear seat back with one-touch release
- Alloy sports pedals
- VX-Line, heated, flat-bottomed leather steering wheel
- Driver's seat massage functions
- Rear centre armrest

Exterior convenience/styling:

- 20-inch bi-colour high gloss black, five twin-spoke alloy wheels
- Sports-style front and rear bumpers
- Rear spoiler
- Gloss black side window trim
- Chrome-effect upper window trim
- Electrically operated front/rear windows
- Dark-tinted rear windows
- Front and rear parking sensors
- IntelliLux LED® Pixel headlights
- LED tail lights
- Sight and Light pack
 - Rain sensitive windscreen wipers
 - Auto-dimming rear-view mirror
 - Automatic lighting control with tunnel detection
 - High beam assist
- Illuminated vanity mirrors • Front fog lights
- Electrically adjustable/heated and foldable door mirrors
- Shark fin aerial

Safety/security:

- Driving Assistance Pack
 - Automatic emergency braking
 - Forward collision alert
 - Following distance indicator
 - Lane departure warning with lane assist
- Electronic Stability Programme (ESP)
- Anti-lock Braking System (ABS)
- Six airbags
- ISOFIX child seat mounting points, outer rear seats
- Tyre pressure monitoring system
- LED daytime running lights
- Keyless entry and start
- Security alarm system
- Traffic sign recognition

New Insignia Ultimate Nav

VX_INS_30930



Ultimate Nav OTR from £29,210

Infotainment:

- Multimedia Navi Pro system
 - Fully integrated European sat nav system
 - 8-inch colour touchscreen
 - AM/FM/DAB digital radio
 - Bluetooth® audio streaming
 - Bluetooth® mobile phone portal
 - Apple CarPlay/Android Auto™
 - Twin front USB sockets and aux in
- Seven speakers (five front, two rear)

Interior convenience/styling:

- Ergonomic active sports front seats (AGR-approved*)
- Dual-zone electronic climate control
- Multi-function trip computer
- Cruise control with intelligent speed limiter
- Front centre armrest
- Steering wheel audio/phone/cruise controls
- 8-inch colour information display
- Illuminated vanity mirrors
- LED ambient lighting
- Door sill covers
- Heated windscreen
- FlexFold 40/20/40 split-folding rear seat back with one-touch release
- Alloy sports pedals
- Heated, flat-bottomed leather steering wheel
- Heated front and outer rear seats
- Twin rear USB sockets
- Wireless charger
- Driver's seat massage functions
- Rear centre armrest

Exterior convenience/styling:

- 18-inch bi-colour high gloss black, multi-spoke diamond-cut alloy wheels
- Front fog lights
- Gloss black side window trim
- Chrome-effect upper window trim
- Dark-tinted rear windows
- Front and rear parking sensors
- IntelliLux LED® Pixel headlights
- LED tail lights
- Sight and Light pack
 - Rain sensitive windscreen wipers
 - Auto-dimming rear-view mirror
 - Automatic lighting control with tunnel detection
 - High beam assist
- Electrically adjustable/heated and foldable door mirrors
- Shark fin aerial

Safety/security:

- Driving Assistance Pack
 - Automatic emergency braking
 - Forward collision alert
 - Following distance indicator
 - Lane departure warning with lane assist
- Electronic Stability Programme (ESP)
- Anti-lock Braking System (ABS)
- Six airbags
- Hill start assist
- ISOFIX child seat mounting points, outer rear seats
- Tyre pressure monitoring system
- Security alarm system
- Keyless entry and start
- Traffic sign recognition

New Insignia GSi

VX_INS_30931



GSi

OTR £40,845

Infotainment:

- Multimedia Navi Pro system
 - Fully integrated European sat nav system
 - 8-inch colour touchscreen
 - AM/FM/DAB digital radio
 - Bluetooth® audio streaming
 - Bluetooth® mobile phone portal
 - Apple CarPlay/Android Auto™
 - Twin front USB sockets and aux in
- Seven speakers (five front, two rear)

Interior convenience/styling:

- Perforated leather seat facings
- Premium ergonomic active front seats (AGR-approved*)
- Dual-zone electronic climate control
- Heated front and outer rear seats
- Multi-function trip computer
- Cruise control with intelligent speed limiter
- Front centre armrest
- Steering wheel audio/phone/cruise controls
- 8-inch colour information display
- Illuminated vanity mirrors
- LED ambient lighting
- Heated windscreen
- Door sill covers
- FlexFold 40/20/40 split-folding rear seat back with one-touch release
- Driver's and front passenger's seat massage functions
- Paddle shift
- Alloy sports pedals
- Heated, flat-bottomed leather steering wheel
- Rear centre armrest
- Premium floor mats

Exterior convenience/styling:

- 20-inch bi-colour technical grey, multi-spoke alloy wheels
- GSi front and rear bumpers
- GSi side sills and rear spoiler
- Dual visible stainless steel exhaust tailpipes
- Red brake calipers
- Four-wheel drive sports chassis
- Gloss black side window trim
- Chrome-effect upper window trim
- Dark-tinted rear windows
- Front and rear parking sensors
- IntelliLux LED® Pixel headlights
- LED tail lights
- Sight and Light pack
 - Rain sensitive windscreen wipers
 - Auto-dimming rear-view mirror
 - Automatic lighting control with tunnel detection
 - High beam assist
- Electrically adjustable/heated and foldable door mirrors
- Shark fin aerial

Safety/security:

- Driving Assistance Pack
 - Automatic emergency braking
 - Forward collision alert
 - Following distance indicator
 - Lane departure warning with lane assist
- Electronic Stability Programme (ESP)
- Anti-lock Braking System (ABS)
- Eight airbags
- Hill start assist
- Tyre pressure monitoring system
- Keyless entry and start
- Security alarm system
- Traffic sign recognition
- FlexRide adaptive chassis

Effective 7 April 2021

New Insignia Model Year 2021D

New Insignia Prices

	Pack Code	Fuel Type	Price (£)	VAT (£)	Total (£)	On-the-road RRP (£)	Financial Year 2021/22 BiK 20% (£)	WLTP Combined CO ₂ (g/km) [#] - pack code	Insurance groups
SE Nav									
1.5 (122PS) Turbo D	JO68 HP61	Diesel	19,329.17	3,865.83	23,195.00	24,130.00	111.50	121	17E
1.5 (122PS) Turbo D auto	JO68 HG81	Diesel	20,745.83	4,149.17	24,895.00	25,830.00	127.97	130	16E
SRI Nav									
1.5 (122PS) Turbo D	JT68 HP61	Diesel	20,579.17	4,115.83	24,695.00	25,630.00	118.50	121	17E
1.5 (122PS) Turbo D auto	JT68 HG81	Diesel	21,995.83	4,399.17	26,395.00	27,330.00	135.47	130	17E
2.0 (174PS) Turbo D	JT68 MPP1	Diesel	22,745.83	4,549.17	27,295.00	28,230.00	130.63	121	23E
SRI VX-Line Nav									
2.0 (200PS) Turbo auto	JF68 ME91	Petrol	28,058.33	5,611.67	33,670.00	34,980.00	211.93	167	27E
1.5 (122PS) Turbo D	JF68 HP61	Diesel	23,433.33	4,686.67	28,120.00	29,055.00	134.48	121	19E
1.5 (122PS) Turbo D auto	JF68 HG81	Diesel	24,850.00	4,970.00	29,820.00	30,755.00	152.58	130	18E
2.0 (174PS) Turbo D	JF68 MPP1	Diesel	25,600.00	5,120.00	30,720.00	31,655.00	146.62	121	25E
2.0 (174PS) Turbo D auto	JF68 Mi81	Diesel	28,516.67	5,703.33	34,220.00	35,195.00	174.58	131	25E
Ultimate Nav									
1.5 (122PS) Turbo D	JV68 HP61	Diesel	23,562.50	4,712.50	28,275.00	29,210.00	135.20	121	19E
1.5 (122PS) Turbo D auto	JV68 HG81	Diesel	24,979.17	4,995.83	29,975.00	30,910.00	153.37	130	18E
2.0 (174PS) Turbo D	JV68 MPP1	Diesel	25,729.17	5,145.83	30,875.00	31,810.00	147.33	121	25E
GSi									
2.0 (230PS) Turbo 4X4 auto	JW68 MF91	Petrol	32,662.50	6,532.50	39,195.00	40,845.00	246.02	179	30E

New Insignia's petrol and diesel engines meet the Real Driving Emissions Step 2 (RDE2) standards.

WLTP Combined CO₂ (g/km) figures are based on a configured vehicle as per pack code for UK with no options fitted.

[#]Fuel consumption and CO₂ figures are determined according to the WLTP test cycle. CO₂ figures, BiK values and RRP pricing shown above are for a standard vehicle without any additional optional equipment. CO₂ figures are used to calculate Vehicle Excise Duty (VED) for the first registration of the vehicle and BiK. The addition of optional extras could increase the certified CO₂ emission output. This in turn may affect the amount of VED payable upon registration, and, for company car drivers, the P11D value and the amount of Benefit in Kind (BiK) tax payable. Figures shown are for comparison purposes and should only be compared to the fuel consumption and CO₂ values of other cars tested to the same technical standard. The fuel consumption achieved, and CO₂ produced, in real world conditions will depend upon a number of factors including, but not limited to: the accessories fitted (pre and post registration); variations in weather; driving styles and vehicle load. The WLTP (Worldwide Harmonised Light Vehicles Test Procedure) is used to measure fuel consumption and CO₂ figures. Full data relating to WLTP test cycles can be found at: www.vauxhall.co.uk/wltp

Please note: On-the-road recommended retail prices (RRP) include number plates and delivery to Retailer of £700.00 (inc. £116.67 VAT), 12 months' Vehicle Excise Duty and new vehicle first registration fee of £55.00. Excludes fuel and insurance. Company Car Benefit in Kind (BiK) rates are monthly based on the standard paint price.

Safety

Standard Features – The following features are standard across the entire New Insignia range.

Airbags

- Driver's airbag
- Front passenger's airbag
- Front seat side-impact airbags
- Full-size curtain airbags

Seating

- Height-adjustable front head restraints (excluding GSi models)
- Three height-adjustable rear seat head restraints

Seatbelts

- Inertia-reel lap and diagonal seatbelts
- 'Seatbelt unfastened' audible warning and warning light

Stability

- Electronic Stability Programme (ESP)
ESP monitors many different inputs to determine when the car starts to lose traction, it can then immediately respond by varying the brake pressure between up to three wheels and adjust the engine output to help correct the loss of traction and improve stability.

Additional ESP features

- Traction control
- Cornering brake control
- Straight line stability control
- Drag torque control – Maintain stability on slippery roads when lifting off the accelerator or changing gear.

Braking

- Automatic emergency city braking
- Anti-lock Braking System (ABS)
- Emergency brake assist – When emergency braking is detected the vehicle automatically applies the maximum possible braking assistance.
- Electronic brakeforce distribution – Automatically apportions the optimum braking force to each wheel.
- Hill start assist – Briefly maintains rear brake pressure to stop the vehicle rolling back on an incline.

Tyre pressure

- Tyre pressure monitoring system

Child safety

- Deactivation switch for front passenger's front and side-impact airbags
- ISOFIX child seat mountings incorporating top tether anchor points located on outer rear seats (does not include child seat) – Allows ISOFIX child safety seats to be securely fixed into the car. The ISOFIX mounting system reduces forward movement in an accident and makes the child seat easier to install.
- Child-proof locks on rear doors

Pedestrian safety

- Active bonnet/headlight/wiper structure – Designed to reduce pedestrian head and upper body injuries. The active bonnet travels backwards and upwards to help prevent impact between pedestrian's head and underbonnet components.
- Upper and lower bumper design – Reduces upper and lower leg injuries.

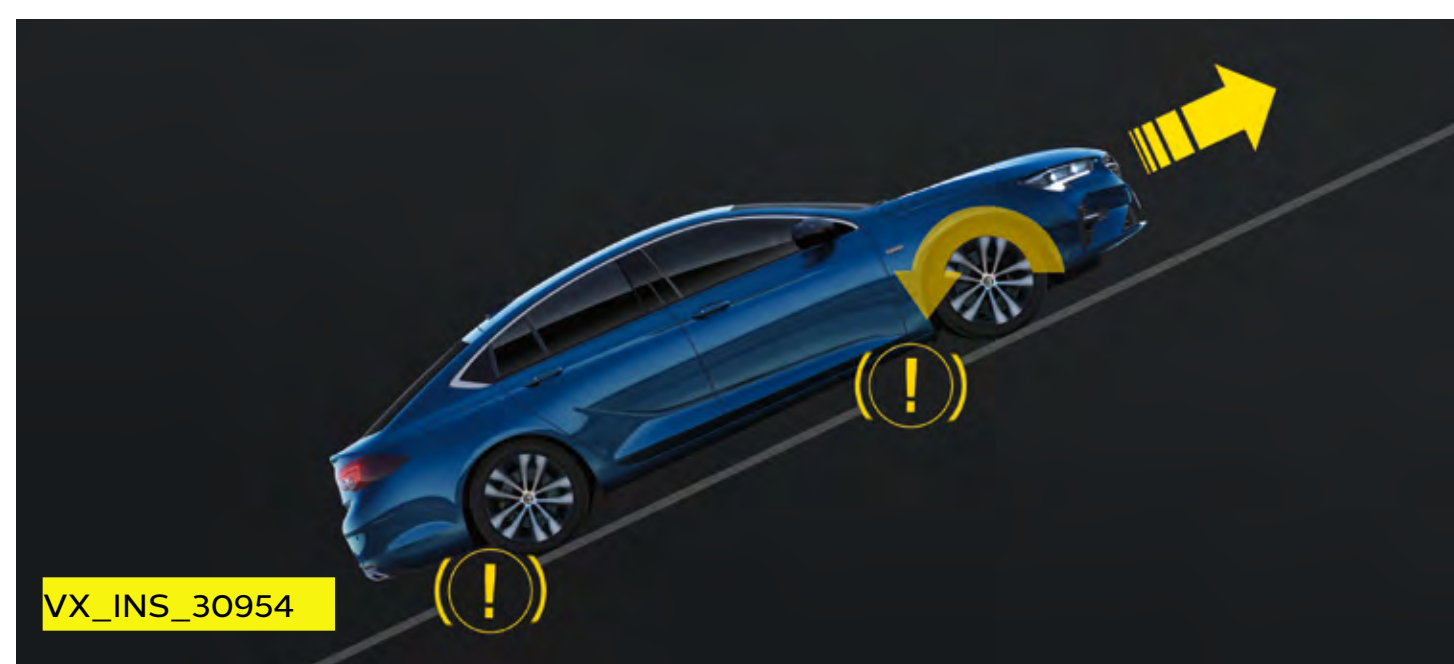

Hill start assist.



ISOFIX child seat mountings.



Automatic emergency city braking.

Driver Assistance

Standard Features – The following features are standard across the entire New Insignia range. Specific features by model are outlined in the separate tabular information.

Cruise control with speed limiter

With steering wheel mounted controls. Enables you to maintain a constant speed, making it ideal for economical motorway driving.

Front camera system

A range of class-leading driver assistance and safety features are controlled by the front camera system.

Forward collision alert

Calculates the distance of vehicles ahead and pedestrians and warns the driver in case of a possible collision. The driver can choose the preferred distance.

- Visual warnings – Red LEDs projected onto windscreen and visual warning shown in the instrument cluster.
- Audible warning

Parking sensors

- Front and rear parking distance sensors

Lane departure warning with lane assist

If the driver has not actively steered or signalled, the lane departure warning system provides gentle steering correction and warns when the car moves outside of lane markings at speeds above 40mph.

- Warning light in instrument cluster
- Facia on/off switch

Automatic emergency braking with pedestrian detection

Uses either the camera or radar to detect foreign objects and pedestrians and slows down or brakes the vehicle.

Helps prevent fatal collisions at lower speeds and lets drivers drive with greater reassurance.

Traffic sign recognition

Uses the front camera to detect all types of road signs.

- Informs and reminds drivers of current speed limits, conditions and laws
- Displays country-specific signs for Europe

Following distance indicator

Indicates how many seconds you are behind the vehicle in front – Helping you maintain a safe distance.

- Timings are shown in the driver information display
- Warning light in the instrument cluster if the gap to the vehicle ahead is below that set by the driver

Electric parking brake

- Centre console switch in lieu of handbrake lever
- Premium centre console featuring adjustable armrest

Steering

- Dual pinion electrical power steering

Wipers

- Rain-sensitive windscreen wipers

Vauxhall driver assistance systems are intended to support the driver within the system-imminent limitations. The driver remains responsible for the driving task at all times.

Model Specific Features/Options

	SE Nav	SRi Nav	SRi VX-Line Nav	Ultimate Nav	GSI
Driver Assistance					
Intermittent rear window wash/wipe	No-cost	No-cost	No-cost	No-cost	No-cost
Driving Assistance Pack 2 (manual) – Automatic cruise control/Head-up display/ Collision alert and intelligent braking/Forward collision alert/Following distance indicator/ Active lane change alert/Pedestrian detection.				£2,000*	
Driving Assistance Pack 2 (auto) – Adaptive cruise control with stop/go functionality/ Head-up display/Collision alert and intelligent braking/Forward collision alert/ Following distance indicator/Active lane change alert/Pedestrian detection.				£2,000*	£2,000*
Park & Go Pack – Rear cross traffic alert/Side obstacle detection sensor/Advanced park assist with semi automatic steering/rear view camera, digital.			£970*	£970*	£970*
FlexRide adaptive chassis – 2.0 (200/230PS) only.			●		●

*Optional at extra cost including VAT.

Driver Information and Security

Standard Features – The following features are standard across the entire New Insignia range. Specific features by model are outlined in the separate tabular information.

Driver Information

Instrumentation

- Speedometer and rev counter
- Digital fuel gauge with low fuel level warning light
- Digital water temperature gauge with warning light
- Shift-up/down indication light – Indicates when to change gear for optimum fuel economy.

Driver information display

(centrally located in instrument cluster)

- Trip computer data
- Total mileage
- Service-due indicator
- Oil life
- Tyre pressure monitoring system

Multi-function trip computer

(displayed on driver information display)

- Trip mileage
- Vehicle range based on remaining fuel
- Average speed
- Average fuel economy
- Instantaneous fuel economy
- Driving time

Central facia display

(format dependent on infotainment unit)

- Audio information
- Digital clock with automatic RDS time adjustment
- Outside air temperature with ice warning function
- Additional features dependent on infotainment unit (see infotainment for details)

Security

- Electronically protected audio equipment
- Engine deadlock immobiliser
- Visible Vehicle Identification Number (VIN)
- Locking wheel bolts for alloy wheels
- Freewheeling door locks

Remote control central locking

- Operates on doors, tailgate and fuel filler flap
- Deadlocking
- Central locking activation switch on driver's door

Remote control ultrasonic security alarm system

- Remote control (operates in conjunction with central locking)
- Ultrasonic interior sensors
- Tilt sensor
- Independent power supply
- Thatcham approved (T1)

Model Specific Features

	SE Nav	SRi Nav	SRi VX-Line Nav	Ultimate Nav	GSi
Driver Information					
Driver information display (centrally located in instrument cluster) – 3.5-inch monochrome display.	●	●			
Driver information display (centrally located in instrument cluster) – 8-inch colour display incorporating speedometer and supplementary audio, phone and navigation information.			●	●	●
Security					
Keyless entry and start with two transmitter fobs			●	●	●

Convenience

Standard Features – The following features are standard across the entire New Insignia range. Specific features by model are outlined in the separate tabular information.

Interior Convenience

- Front 12-volt electrical accessory socket
- Driver's and front passenger's sunvisors with vanity mirrors
- Reach and rake-adjustable steering
- Steering wheel audio/phone/cruise controls
- Automatically dimming anti-dazzle rear-view mirror

Heating and Ventilation

- Dual-zone electronic climate control
- Four adjustable facia vents
- Windscreen and side window demist vents

Interior Storage

- Illuminated glovebox with lid
- Front door pockets with 1.5-litre bottle holder
- Two drinks holders in centre console
- Rear door pockets with 1-litre bottle holder
- Front centre adjustable armrest with 4-litre storage capacity (2.8 litres on SRi VX-Line Nav models)

Luggage Area

- Luggage compartment cover
- Fully carpeted load area
- Interior tailgate handle
- Four load restraint lashing eyes
- Twin gas-assisted tailgate struts
- Storage tray in spare wheel well

Interior Lighting

- Central front and rear courtesy lights
- Illuminated load area
- Twin rear reading lights
- Twin front reading lights with illuminated switches

Model Specific Features/Option

	SE Nav	SRi Nav	SRi VX-Line Nav	Ultimate Nav	GSi
Interior Convenience					
Illuminated vanity mirrors		●	●	●	●
LED ambient lighting		●	●	●	●
Rear centre armrest		●	●	●	●
Wireless charger for mobile devices (Maximum device dimensions 75.7 x 23.6mm) and twin rear USB sockets			●	●	●
Premium floor mats					●
Heating and Ventilation					
Winter Pack – Heated steering wheel/heated front seats.	£250*	£250*	●	●	●
Heated outer rear seats				●	●
Heated windscreen				●	●

*Optional at extra cost including VAT.

Exterior Styling and Convenience

Standard Features – The following features are standard across the entire New Insignia range. Specific features by model are outlined in the separate tabular information.

Exterior Styling

- New front and rear bumper styling
- New front grille design
- Chrome-effect front grille bar
- Black door mirrors
- Body-colour door handles

Exterior Convenience

Door mirrors

- Twin electrically adjustable/heated door mirrors
- Manually folding door mirrors (Electrically foldable on SRi VX-Line Nav/Ultimate Nav/GSi)

Windows

- Electrically operated front and rear windows with safety autoreverse and one-touch up/down facility
- Heated rear window • Tinted windows
- Solar heat-absorbing windscreen

Model Specific Features/Option

	SE Nav	SRi Nav	SRi VX-Line Nav	Ultimate Nav	GSi
Exterior Styling					
Gloss black lower side window trim		●	●	●	●
Chrome-effect upper side window trim		●	●	●	●
Chrome grille surround		●	●	●	
Rear spoiler		●	●		●
Dark-tinted rear windows			●	●	●
Sports-style front and rear bumpers/side sills			●		
Shark fin aerial			●	●	●
Dual decorative rear exhaust bezels (2.0 200PS Turbo/2.0 174PS Turbo D engines only)		●	●	●	
Door sill covers				●	●
GSi front/rear bumpers/side sills/satin chrome grille surround					●
Dual visible stainless steel exhaust tailpipes					●
Exterior Convenience					
Tow bar	£600*	£600*	£600*	£600*	

*Optional at extra cost including VAT.

Exterior Lighting

Standard Features – The following features are standard across the entire New Insignia range. Specific features by model are outlined in the separate tabular information.

Exterior Lighting

- LED daytime running lights
- LED tail lights
- LED side repeat indicators
- Automatic lighting control with tunnel detection: When the automatic lighting control is switched on, the system switches between daytime running lights and headlights automatically depending on external lighting conditions.
- Lights-on audible warning: When driver's door is opened an audible warning sounds to alert the lights have been left on.
- Manual headlight beam levelling: Use to adapt headlight range to the vehicle load to prevent dazzling.
- High beam assist
- LED brake lights
- High-level LED centre rear brake light
- Rear fog light
- Reversing light
- Hazard warning lights
- Door-to-door illumination: Headlights illuminate the area for an adjustable time after leaving the vehicle.
- Welcome lighting: Headlights and tail lights illuminate when the vehicle is unlocked.

Model Specific Features/Option

	SE Nav	SRi Nav	SRi VX-Line Nav	Ultimate Nav	GSi
Exterior lighting					
Front fog lights	●	●	●	●	
LED headlights	●	●			
IntelliLux LED® Pixel headlights with anti-glare high beam		£1,215*	●	●	●



VX_INS_30963

LED headlight.**



VX_INS_30964

IntelliLux LED® Pixel headlight.**



VX_INS_30965

LED tail lights.**

*Optional at extra cost including VAT. **Please note, Navy Blue metallic paint is no longer available.

Infotainment

Standard Features

Multimedia Navi with 7-inch touchscreen

Standard on SE Nav and SRi Nav

Onboard features:

- 7-inch colour touchscreen
- DAB Digital radio
- RDS with Traffic Programme
- AM/FM stereo radio with 36 station presets
- Seven speakers
- 20 watts per channel output

Media connections:

- Twin front USB sockets and aux in
- Bluetooth® A2DP audio streaming (Advanced Audio Distribution Profile)

Mobile phone portal:

- Bluetooth® connectivity
- Vehicle microphone
- Handsfree calls via steering wheel controls
- Phone book access – Contacts/last calls/missed calls etc. are mirrored on the display and are easily navigated using the touchscreen (features dependent on mobile phone).

Smartphone interface:

- Apple CarPlay
- Android Auto™
- Smartphone projection that allows operations via voice command, touchscreen and buttons to control apps and music playback

Navigation features:

- Satellite navigation system
- 2D/3D street level mapping
- European coverage
- Points-of-interest search
- Map updates via USB

Multimedia Navi Pro with 8-inch touchscreen

Standard on SRi VX-Line Nav, Ultimate Nav and GSi

Features as Multimedia Navi, with the addition of the following features:

- 8-inch colour touchscreen
- 8-inch digital colour instrument display
- SD card slot
- Personalised profiles
- Shark fin aerial

SRi VX-Line Nav also includes:

- Bose premium audio system with external noise reduction package

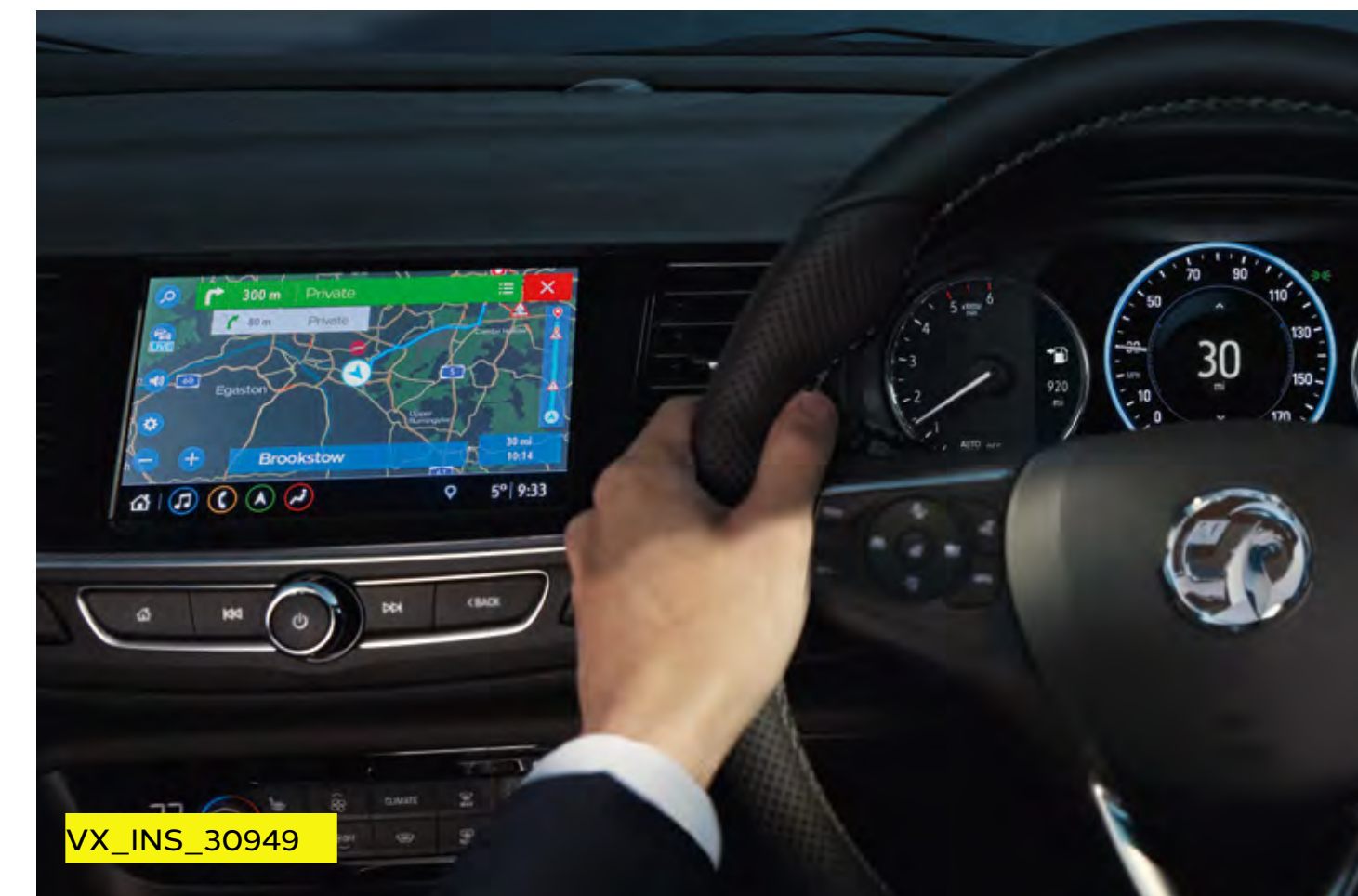

8-inch colour touchscreen and digital information display.



Bose sound system.

Please note that compatibility and certain functions may be different depending on the type of device and operating system you're using with the Multimedia systems. Apple CarPlay is a trademark of Apple Inc. Apple and iPhone are trademarks of Apple Inc., registered in the U.S. and other countries. Android is a trademark of Google Inc, also registered in the U.S. and other countries.

Interior Styling and Comfort



Steering wheel:

- Three-spoke design
- Leather-covered
- Satin chrome-effect bezel

Facia and door trim:

- Black facia
- Black door panels with black Atlantis cloth inserts
- Parallax trim inserts
- Chrome-effect interior door handles

Seating:

- Sports front seats
- Ergonomic active driver's seat (AGR-approved*)

- Driver's seat (eight-way adjustable):
 - Height – Reach – Tilt – Backrest
 - Seat cushion extension
 - Lumbar adjustment (four-way electrical)
 - Head restraint (four-way)
- Front passenger's seat (four-way adjustable):
 - Reach – Backrest
 - Head restraint (four-way)
- 60/40 split-folding rear seat back

Seat trim:

- Billy jet black cloth seat trim inserts
- Jet black fabric side bolsters

Steering wheel:

- Three-spoke design
- Leather-covered
- Satin chrome-effect bezel

Facia and door trim:

- Black facia
- Black door panels with black premium leather-effect inserts
- Dark metallic Hexagon trim inserts
- Chrome-effect interior door handles

Seating:

- Ergonomic active sports front seats (AGR-approved*)

- Driver's and front passenger's seat (eight-way adjustable):
 - Height – Reach – Tilt – Backrest
 - Seat cushion extension
 - Lumbar adjustment (four-way electrical)
 - Head restraint (four-way)
- FlexFold 40/20/40 split-folding rear seat back with one-touch release

Seat trim:

- Monita marvel black fabric seat trim inserts
- Jet black premium leather-effect side bolsters

Interior Styling and Comfort

SRi VX-Line Nav



Steering wheel:

- Three-spoke design
- VX-Line, heated, flat bottomed, leather-covered steering wheel
- Satin chrome-effect bezel

Facia and door trim:

- Black facia
- Black door panels with black premium leather-effect inserts
- Dark metallic Hexagon trim inserts
- Chrome-effect interior door handles

Pedals:

- Sports, alloy-effect

Seating:

- Ergonomic active sports front seats (AGR-approved*)
- Driver's seat (eight-way adjustable):
 - Height (electrical)
 - Reach (electrical)
 - Tilt (electrical)
 - Backrest (electrical)
 - Seat cushion extension
 - Lumbar adjustment (four-way electrical)
 - Head restraint (four-way)
 - Active ventilation
 - Pneumatically adjustable backrest side bolsters
 - Massage functions
 - Seat memory function, including door mirrors
- Front passenger's seat (eight-way adjustable):
 - Height – Reach – Tilt – Backrest
 - Seat cushion extension
 - Lumbar adjustment (four-way electrical)
 - Head restraint (four-way)
- Heated front seats
- FlexFold 40/20/40 split-folding rear seat back with one-touch release

Seat trim:

- Black Siena perforated leather seat trim inserts
- Black premium leather-effect side bolsters

VX_INS_30934

Interior Styling and Comfort

Ultimate Nav



Steering wheel:

- Three-spoke design
- Heated, flat bottomed, leather-covered steering wheel
- Satin chrome-effect bezel

Facia and door trim:

- Black facia
- Black door panels with black leather-effect inserts
- Brushed ice trim inserts

Pedals:

- Sports, alloy-effect

Seating:

- Ergonomic active sports front seats (AGR-approved*)
- Driver's seat (eight-way adjustable):
 - Height (electrical)
 - Reach (electrical)
 - Tilt (electrical)
 - Backrest (electrical)
 - Seat cushion extension
 - Lumbar adjustment (four-way electrical)
 - Head restraint (four-way)
 - Pneumatically adjustable backrest side bolsters
 - Massage functions
 - Seat memory function, including door mirrors
- Front passenger's seat (eight-way adjustable):
 - Height – Reach – Tilt – Backrest
 - Seat cushion extension
 - Lumbar adjustment (four-way electrical)
 - Head restraint (four-way)
- Heated front and outer rear seats
- FlexFold 40/20/40 split-folding rear seat back with one-touch release

Seat trim:

- Black Alcantara seat trim inserts
- Black premium leather effect side bolsters

VX_INS_30935

Interior Styling and Comfort

GSI



Steering wheel:

- Heated, flat bottomed, leather-covered steering wheel
- Satin chrome-effect bezel
- Paddle shift

Facia and door trim:

- Black facia
- Black door panels with black leather-effect inserts
- Brushed ice trim inserts

Pedals:

- Sports, alloy-effect

Seating:

- Premium ergonomic active sports front seats (AGR-approved*)
- Driver's and front passenger's seat (eight-way adjustable):
 - Height (electrical)
 - Reach (electrical)
 - Tilt (electrical)
 - Backrest (electrical)
 - Seat cushion extension
 - Lumbar adjustment (four-way electrical)
 - Massage functions
 - Active ventilation
 - Pneumatically adjustable backrest side bolsters
 - Driver's seat memory function, including door mirrors
 - Heated front and outer rear seats
 - FlexFold 40/20/40 split-folding rear seat back

Seat trim:

- Black Siena perforated leather seat trim inserts
- Black premium leather-effect side bolsters

VX_INS_30936

Exterior Colours

Carbon Brown (G1S)*
Two-coat metallic paint



VX_INS_30938_Carbon_Brown_G1S

Summit White (GAZ)**
Brilliant paint **£360**



VX_INS_30937_SummitWhite_GAZ

Sovereign Silver (GAN)**
Two-coat metallic paint **£600**



VX_INS_30943_Sovereign_Silver_GAN

Satin Steel Grey (GF6)†
Two-coat metallic paint **£600**



VX_INS_30942_Satin_Steel_Grey_GF6

Mineral Black (GB9)**
Two-coat metallic paint **£600**



VX_INS_30940_Mineral_Black_GB9

Hot Red (G1R)**
Two-coat premium paint **£710**





VX_INS_30939_Hot_Red_G1R

The colours reproduced may vary slightly from the actual paint colour. As a result they should be used as a guide only. Your Vauxhall Retailer has a comprehensive display of our paint samples.

*Standard exterior paint. Not available on GSi models. **Optional at extra cost including VAT. †Optional at extra cost including VAT. Standard on GSi models.

Wheels and Tyres

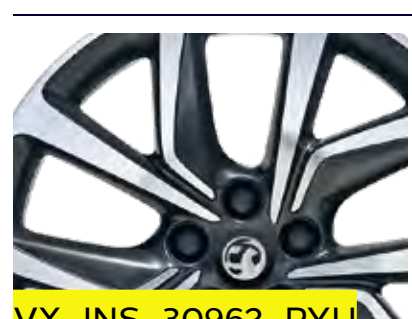
	SE Nav	SRi Nav	SRi VX-Line Nav	Ultimate Nav	GSI
 <p>17-inch silver five-twinspoke alloy wheels</p> <ul style="list-style-type: none"> • 215/55 R 17 tyres (1.5 (122PS) Turbo D) • 225/55 R 17 tyres (2.0 (174PS) Turbo D) • Emergency tyre inflation kit (in lieu of spare wheel) <p>VX_INS_30959_RSC</p>	●	●			
 <p>20-inch bi-colour high gloss black, five twin-spoke diamond-cut alloy wheels</p> <ul style="list-style-type: none"> • 245/35 R 20 tyres • Emergency tyre inflation kit (in lieu of spare wheel) <p>VX_INS_30960_RQ9</p>			●		
 <p>18-inch bi-colour high gloss black, multi-spoke diamond-cut alloy wheels</p> <ul style="list-style-type: none"> • 245/45 R 18 tyres • Emergency tyre inflation kit (in lieu of spare wheel) <p>VX_INS_30961_RQL</p>				●	
 <p>20-inch bi-colour technical grey, multi-spoke diamond-cut alloy wheels</p> <ul style="list-style-type: none"> • 245/35 R 20 tyres • Emergency tyre inflation kit (in lieu of spare wheel) <p>VX_INS_30962_PYU</p>					●
Provision for spare wheel fitment (spare wheel is Retailer-fit)	£20*	£20*		£20*	

*Optional at extra cost including VAT.

Petrol Engines

	2.0 (200PS) Turbo with 9-speed automatic	2.0 (230PS) Turbo with 9-speed automatic
Capacity	1998cc	1998cc
Maximum power	200PS (149kW) @ 4000–5500rpm	230PS (169kW) @ 5000rpm
Maximum torque	350Nm (258 lb.ft.) @ 1500–4000rpm	350Nm (258 lb.ft.) @ 1500–4000rpm
Configuration	4 cylinders, 4 valves per cylinder, double overhead camshafts	4 cylinders, 4 valves per cylinder, double overhead camshafts
Fuel/induction system	Twin scroll turbocharger. Variable camshaft control. Spark ignited direct injection (SIDI)	Twin scroll turbocharger. Variable camshaft control. Spark ignited direct injection (SIDI)
Emission compliance	Euro 6d	Euro 6d
Service interval	20,000 miles or 1 year (whichever occurs sooner)	20,000 miles or 1 year (whichever occurs sooner)

Diesel Engines

	1.5 (122PS) Turbo D with 6-speed manual	1.5 (122PS) Turbo D with 8-speed automatic	2.0 (174PS) Turbo D
Capacity	1496cc	1496cc	1995cc
Maximum power	122PS (90kW) @ 3500rpm	122PS (90kW) @ 3500rpm	174PS (128kW) @ 3500rpm
Maximum torque	300Nm (221lb.ft.) @ 1750–2500rpm	285Nm (210lb.ft.) @ 1500–2750rpm	381Nm (281 lb.ft.) @ 1500–2750rpm
Configuration	3 cylinders, 4 valves per cylinder, double overhead camshafts	3 cylinders, 4 valves per cylinder, double overhead camshafts	4 cylinders, 4 valves per cylinder, double overhead camshafts
Fuel/induction system	Variable geometry turbocharger with intercooler. Common rail fuel injection	Variable geometry turbocharger with intercooler. Common rail fuel injection	Variable geometry turbocharger with intercooler. Common rail fuel injection
Emission compliance	Euro 6d	Euro 6d	Euro 6d
Service interval	20,000 miles or 1 year (whichever occurs sooner)	20,000 miles or 1 year (whichever occurs sooner)	20,000 miles or 1 year (whichever occurs sooner)

Performance, Fuel Economy and Emissions

	Performance (manufacturer's figures)		Fuel economy mpg (litres/100km) [#]		CO ₂ emissions g/km [#]		Vehicle Excise Duty*		BiK rates from – 2021/22 tax year
	Maximum speed (mph)	Acceleration 0–60mph (sec)	Combined Low	Combined High	Combined Low	Combined High	First year rate	Standard rate	
2.0 (200PS) Turbo auto	146	7.2	33.1 (8.5)	37.7 (7.5)	167	188	£895	£155	37%
2.0 (230PS) Turbo 4X4 auto	147	7.0	31.7 (8.9)	35.8 (7.9)	179	200	£895	£155	38%
1.5 (122PS) Turbo D	127	10.7	51.4 (5.5)	61.4 (4.6)	121	145	£180	£155	28%
1.5 (122PS) Turbo D auto	124	11.5	49.6 (5.7)	56.5 (5.0)	130	150	£180	£155	30%
2.0 (174PS) Turbo D	142	8.2	51.4 (5.5)	61.4 (4.6)	121	144	£180	£155	28%
2.0 (174PS) Turbo D auto	140	8.4	49.6 (5.7)	56.5 (5.0)	131	149	£220	£155	30%

Weights and Towing Data_{kg}

	Gross vehicle weight	Maximum towing weights Trailer with brakes** (without brakes)	Maximum towing weights Trailer with brakes† (without brakes)
2.0 (200PS) Turbo	2160	2000 (750)	1500 (750)
2.0 (230PS) Turbo 4X4 auto	2240	–	1500 (750)
1.5 (122PS) Turbo D	2110	1500 (730)	1500 (730)
1.5 (122PS) Turbo D auto	2140	1500 (730)	1300 (730)
2.0 (174PS) Turbo D	2160	1950 (750)	1350 (750)
2.0 (174PS) Turbo D auto	2200	1650 (750)	1050 (750)

[#]Figures shown are for comparison purposes and should only be compared to the fuel consumption and CO₂ values of other cars tested to the same technical standard. The fuel consumption achieved, and CO₂ produced, in real world conditions will depend upon a number of factors including, but not limited to: the accessories fitted (pre and post registration); variations in weather; driving styles and vehicle load. The WLTP (Worldwide Harmonised Light Vehicles Test Procedure) is used to measure fuel consumption and CO₂ figures. The CO₂ figures display a range to reflect the highest value for the highest emitting version with all available options added, through to a minimum value to represent the lowest emitting version in standard specification. *Correct at time of publication. **Braked towing weight is applicable to vehicles fitted with optional Factory-fit tow bar.

†Braked towing weight is applicable to vehicles fitted with a Retailer-fit Accessory tow bar.

Please note: Gross vehicle weight is the total permissible weight of the vehicle including passengers and their luggage. The **maximum roof rack loading** should not exceed 100kg on all models. The **maximum towing weights** are based on the ability of the car, with two occupants of 75kg each, to restart on a 12% gradient, which is approximately 1 in 8.3, at sea level. The permitted trailer load applies up to the specified incline and up to an altitude of 1000 metres above sea level. The permissible gross train weight decreases by 10% for every 1000 metres of additional altitude. Any extra weight, such as luggage or additional passengers, should be deducted from the maximum towing weight. Always fit Vauxhall towing attachments and accessories available from your Vauxhall Retailer. They are designed specifically for Vauxhall models and carry a 12-month guarantee. During trailer towing do not exceed a maximum speed of 60mph. This speed limit is also applicable in countries with higher permitted speeds for trailer-vehicle combinations. Pay attention to the local speed limits. For trailers with low driving stability and caravans the use of an oscillation damper is strongly recommended.

Specifications

Transmission

Six-speed manual gearbox

Diesel engines: 1.5 (122PS) Turbo D and 2.0 (174PS) Turbo D

Eight-speed Automatic transmission

Available on 1.5 (122PS) Turbo D and 2.0 (174PS) Turbo D.

Nine-speed Automatic transmission

Available on 2.0 (200PS) Turbo and 2.0 (230PS) Turbo.

The new 9-speed automatic transmission enables increased drive comfort and improved fuel economy. For extra reliability the transmission has been engineered to help reduce the amount of splash losses, hydraulic losses and the amount of torsional vibrations.

Suspension

Front: Independent. Lightweight MacPherson struts with gas-pressure dampers and coil springs. Anti-roll bar.

Rear: Lightweight multi-link (FWD – 4-link; 4X4 – 5-link) with rising-rate mini-block coil springs and gas-pressure dampers. Anti-roll bar.

- GSi models feature an updated sports chassis with lower ride height and specially tuned dampers

GSi transmission/suspension

Performance Twinster® AWD system

The GKN Performance Twinster® AWD distributes torque across the axles using a twin clutch system for a dynamic yet safe and easy-to-manage driving experience. The GKN Performance Twinster® features:

- Lightweight compact design
- Up to a 100% of the available torque can be sent to rear wheels or distributed across all four wheels according to the situation
- Electronically controlled, hydraulically actuated wet clutches
- AWD system that monitors vehicle inputs from sensors 100 times per second

FlexRide (Adaptive Stability Technology) system

FlexRide offers drivers the choice of four distinct driving modes – Normal (default setting), Sport, Tour and Competition mode.

- Sport mode: This stiffens the car's suspension and sharpens steering and throttle responses. It also raises the threshold at which the ESP and traction control systems are activated, enhancing dynamic performance
- Tour mode: Ideal for long motorway journeys, the Tour mode adjusts the dampers to a softer setting to create a perceptibly smoother ride and further enhance Insignia's ride comfort
- Continuous damping control: Utilises data from up to 11 variables including acceleration, braking and cornering to constantly control the suspension for optimum stability, driver engagement and comfort. Operates in all three driving modes

Braking and stability

- Electronic Stability Programme (ESP)
- Cornering brake control
- Straight line stability control
- Rollover mitigation
- Drag torque control
- Hill start assist
- Anti-lock Braking System (ABS)
- Emergency brake assist
- Fading brake support
- Electronic brakeforce distribution
- Adaptive brake lights

Braking and stability

- Dual pinion electrical power steering

Fuel Tank Capacity

62 litres (13.6 gallons)

AdBlue® Tank Capacity

15 litres (3.3 gallons)

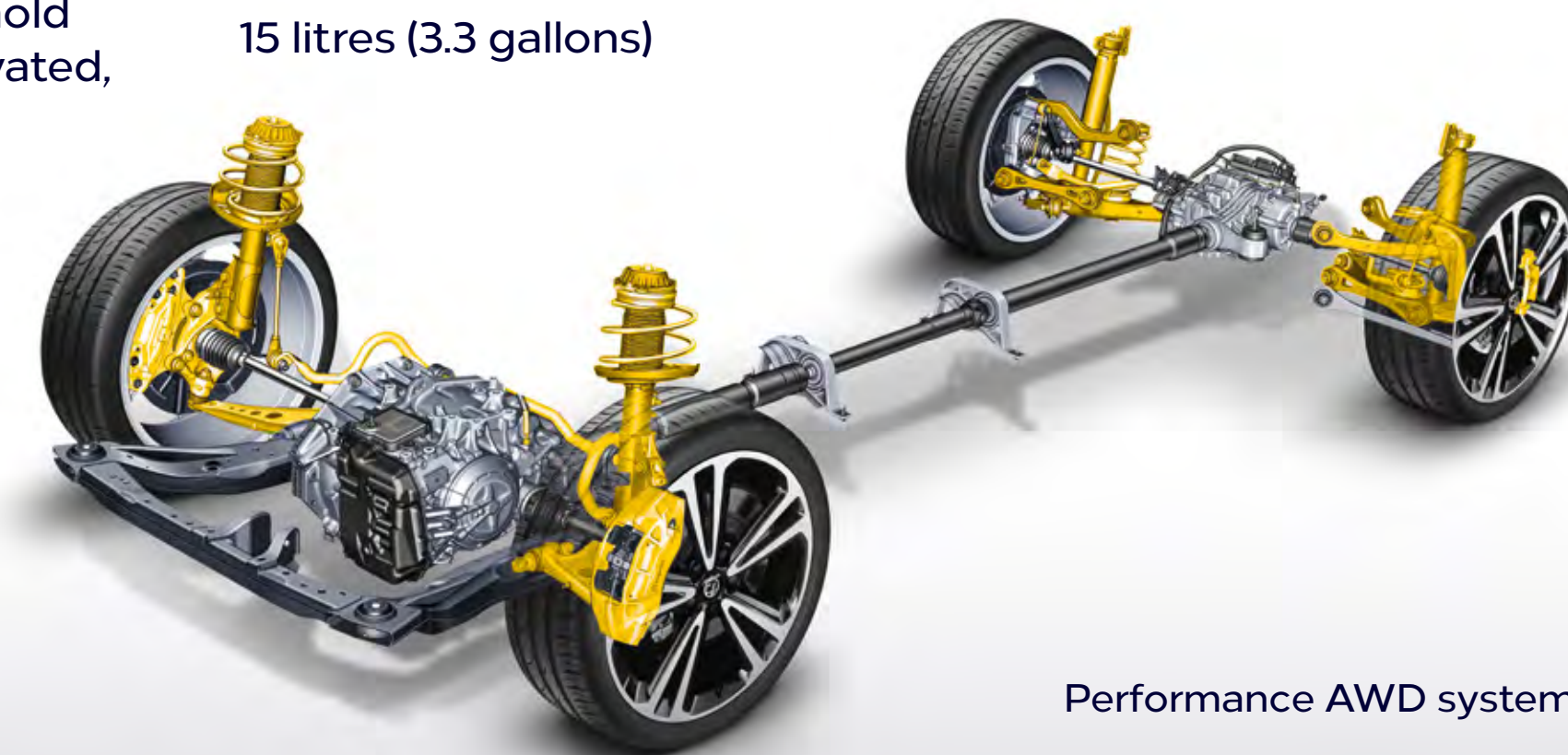

Performance AWD system.

Dimensions and Capacities All measurements in mm (inches) unless stated otherwise.

Loadspace Dimensions	
Load floor length (rear seats folded)	1937 (76.3)
Load floor length (behind rear seats)	1133 (44.6)
Load area width	1030 (40.5)
Load area height	722 (28.4)
Tailgate aperture height	557 (21.9)

Luggage Capacities Litres (cu.ft.)	
Rear seat up (under luggage compartment cover)	490 (17.3)
Rear seat down (measured to roof)	1450 (51.1)

*Measured using the ECIE method. When a spare wheel is specified loadspace capacity is reduced due to a raised luggage compartment floor.

All models except GSi

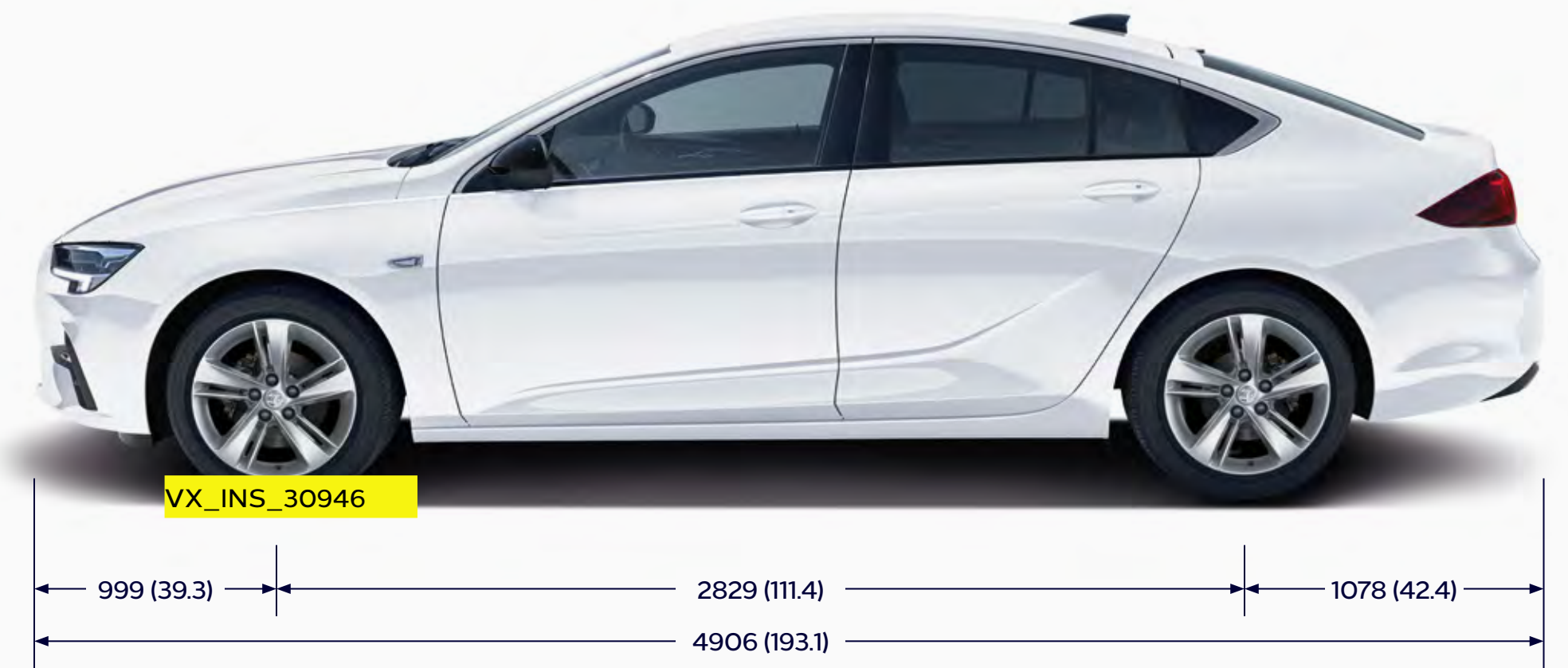

GSi

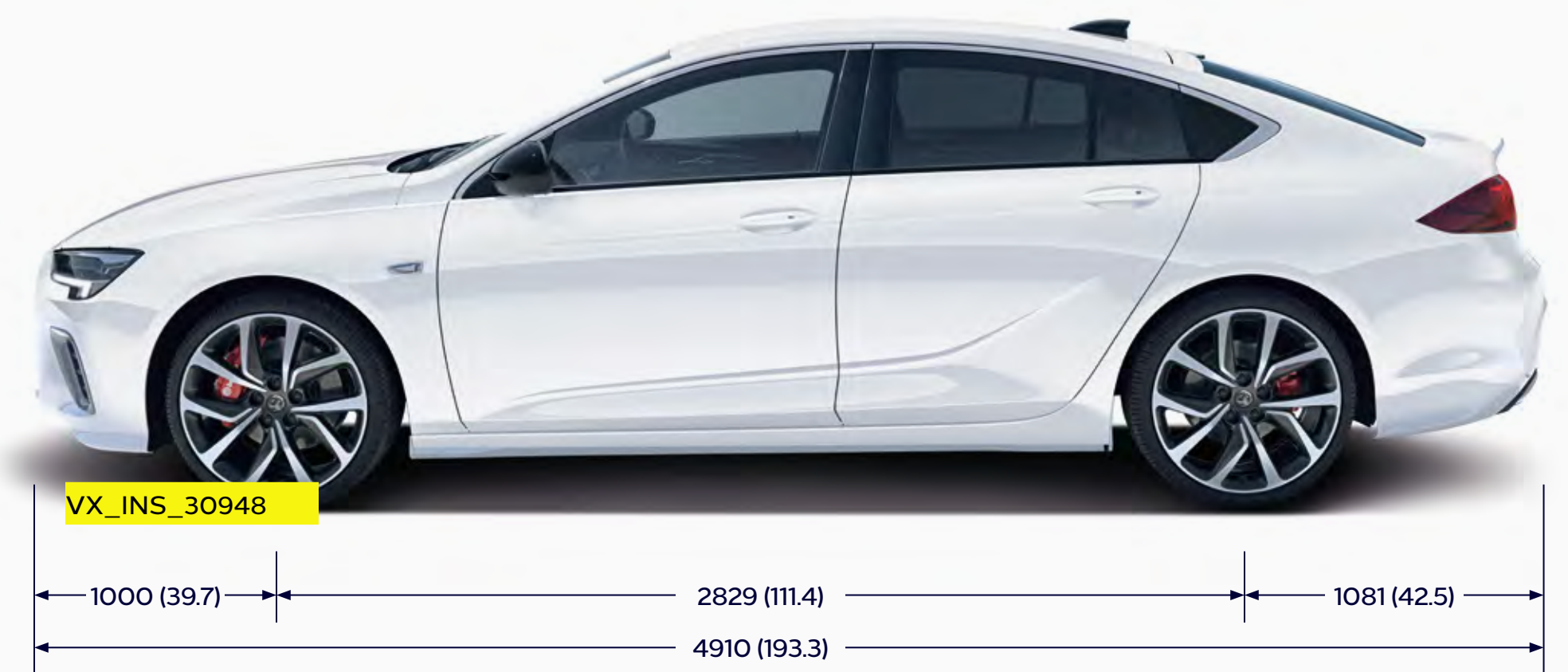

Accessories

Safety	Total (inc. VAT)
Spare wheel kit with 17-inch emergency wheel and tool kit ¹	£201
Philips ADR620 dash cam	£109
Front parking sensors	£363
Rear parking sensors	£407
Rear view camera	£320
Child seats ²	
– Age group 0 (approx. 24 months/ up to 13kg)	£182
– ISOFIX base for age group 0 ³	£230
– Age group 1 (approx. 1-3.5 years/9-18kg)	£510
– Age group 2/3 (approx. 3-12 years/ 15-36kg)	£186
Safety Pack – first aid kit, hi-vis vest and small warning triangle	£16
Warning triangle	£9
Hi-vis safety vest – adult	£4
Hi-vis safety vest – child 3-6 years (42cm)	£4
Hi-vis safety vest – child 7-12 years (52cm)	£4
First aid kit	£15
Emergency seat belt cutter and hammer	£18
Spare bulb kit	£60
Stretch tow rope	£20

Protection	Total (inc. VAT)
Floor mats (set of 4)	
– Carpet	£41
– Rubber	£51
– Velour	£64
Reversible cargo liner	£92
Splash guards	
– Front	£40
– Rear	£59
Rear bumper protector	£109
Style	
Door sill plates in stainless steel	£41
Door mirror caps	
– Carbon effect	£139
– Brushed aluminium	£239
Rear spoiler	£248

Comfort	Total (inc. VAT)
FlexConnect bracket	£20
FlexConnect hook	£27
FlexConnect coat hanger	£40
FlexConnect folding table	£65
FlexConnect iPad mini holder	£93
FlexConnect iPad holder	£103
FlexConnect iPad Air holder	£103
FlexConnect Samsung Galaxy holder	£93
Privacy shades for rear and side rear windows (set of 4)	£90
Cup holder insert	
– Miscellaneous	£9
– Pen	£15
– Notepad	£15
Smoker's kit	£20
Fragrance diffuser	£23
Fragrance cartridge (various)	£18

Transport solutions	Total (inc. VAT)
Roof base carrier (set of 2 bars)	£174
Roof carriers (requires base carrier)	
Roof box – Thule Ocean 80	£164
Roof box – Thule Ocean 200	£374
Roof box – Thule Touring 200	£428
Roof box – Thule Touring 700	£492
Roof box – Thule Motion 800	from £426
Bike carrier – Thule FreeRide 532	£81
Bike carrier – Thule Expert 298	£134
Surfboard carrier – Thule 833	£82
Ski/snowboard carrier	
– Thule Snow Pack 7324 (4 x pairs)	£143
Ski/snowboard carrier	
– Thule Snow Pack 7326 (6 x pairs)	£258
Towing	
Tow bar	
– Fixed	£478
– Detachable	£571
Alloy wheels ⁴	
18-inch high gloss black (set of 4, with centre caps)	£1,368

Please note: Prices shown are fully fitted and painted, where applicable and include VAT. Please check with your local Vauxhall Retailer for details. It is advisable to ensure your insurance policy is adequate to cover additional fitted accessories. Prices correct at time of publication.

¹Vehicle must be ordered with spare wheel fixing option (T7Y) in order to accommodate the spare wheel. ²Restrictions apply to the use of child seats, please consult your vehicle user manual or Vauxhall Retailer. ³Restricted to rear seat usage only for vehicles with transponder deactivation of passenger airbag. ⁴Different tyres and locking wheel bolts/nuts may be required at extra cost. Price excludes new tyres and locking wheel bolts/nuts, includes static wheel balancing.

Company Car Driver and Fleet Information

High spec, low P11D

As a business and company car driver, you'll find all of our models are seriously fit for fleet; we're talking very low P11D values, generous standard specification and high-tech engines designed for great fuel economy and low emissions – and that's just to get you started.

To get access to even more spec as standard, simply take a step up in the range – low P11D values will continue to apply.

Drivers and businesses all have unique requirements and by taking advantage of low whole-life costs and low company car driver taxation you can get in the driving seat with the spec to suit.

Company Car Driver Free 3 Day Test Drive

Our free* 3 Day Test Drive programme is open to all Company Car Drivers which allows you to choose any model in the current Vauxhall line-up (exclusions apply). With full insurance cover provided, it gives you a meaningful length of time to make an informed decision about your next company car.

Search Vauxhall 3DTD to book your free* test drive or click the link the below:

[Vauxhall 3 Day Test Drive](#)

*The free 3 Day Test Drive programme is open to Company Car Drivers and Fleet Decision Makers. Available for UK Mainland only. Terms and conditions apply. Full terms and conditions can be found at vauxhallfleet.co.uk/testdrive/index/terms.

Benefit in kind company car taxation**

The car benefit charge will be the car's list price (including VAT, options and accessories fitted, delivery to Retailer and number plates, but excluding Vehicle Excise Duty and new vehicle first registration fee) multiplied by the percentage charge for the CO₂ emissions band in which the car falls (see table opposite). Multiply this figure by your personal income tax rate (20%[†] for Basic Rate, 40%** for Higher Rate) to calculate your annual benefit in kind tax liability.

Example:

New Insignia SE Nav 1.5 (122PS) Turbo D (CO₂ emissions 120g/km)

On-the-road RRP	£25,830.00
Deduct: Vehicle Excise Duty	(£180.00)
New vehicle first registration fee	(£55.00)
Effective list price	£25,595.00
Add: Optional two-coat metallic paint	£600.00
List price for tax purposes (P11D value)	£26,195.00
Car benefit charge 2021-22 tax year (28%)	£7,335.00
Benefit in kind tax liability (2021-22 tax year)	
Basic Rate (20%) tax payer	£1,467.00
Higher Rate (40%) tax payer	£2,934.00

**Please note this Price Guide provides taxation information as a guide only. Vauxhall does not provide taxation guidance. Drivers should always take professional advice on their own tax position.
[†]Excludes residents of Scotland.

BiK for Scottish Residents

Effective 6 April 2018 the Scottish Government have introduced their own BiK taxation structure. This only applies to Company Car Drivers that are Scottish taxpayers. HMRC will determine whether or not an individual is a Scottish taxpayer based on where their main place of residence is.

The BiK rates for Scotland are:

- Over £12,570–£14,667 Starter Rate 19%
- Over £14,667–£25,296 Basic Rate 20%
- Over £25,296–£43,662 Intermediate Rate 21%
- Over £43,662–£150,000 Higher Rate 41%
- Above £150,000 Top Rate 46%

CO ₂ emissions (g/km)	Percentage of cars price to be taxed 2021-22 tax year
Up to 50	13%
51-54	14%
55-59	15%
60-64	16%
65-69	17%
70-74	18%
75-79	19%
80-84	20%
85-89	21%
90-94	22%
95-99	23%
100-104	24%
105-109	25%
110-114	26%
115-119	27%
120-124	28%
125-129	29%
130-134	30%
135-139	31%
140-144	32%
145-149	33%
150-154	34%
155-159	35%
160-164	36%
165-169	37%
170+	37%

Fleet Toolbox

Discover the facts in our online Toolbox for both Company Car Drivers and Fleet Decision Makers. The Fleet Toolbox has a host of useful calculators, comparators, interactive listings and information.

Search Vauxhall Fleet Tools or click the link below:

[Vauxhall Fleet Tool Box](#)

Contact Vauxhall Fleet

Please contact one of our dedicated sales teams who will be happy to help with your particular enquiry.

Company Car Drivers

Call: 0345 111 2020

Email: company-car@vauxhallinfo.co.uk

Telephone lines are open

– Monday to Friday 8:00am–9:00pm

– Saturday and Sunday 9:00am–6:00pm

Fleet Decision Makers

Depending on the size of your fleet of vehicles, we have a dedicated team to handle your enquiries. The lines are open Monday to Friday excluding Bank Holidays.

1-24 vehicles

Call: 0845 076 2254 (8:30am–5:00pm)

25+ vehicles

Call: 0330 587 8222 (8:30am–5:00pm)

Email: vauxhallfleet@vauxhall.co.uk

Special Vehicles (Police, Fire and Ambulance)

Call: 01582 409999 (8:30am–5:00pm)

Email: vauxhallspecialvehicles@vauxhall.co.uk

To calculate your own personal liability, search:

Vauxhall BiK, or click the link below:

[Vauxhall BiK Tool](#)

Further Information

On-the-road prices

To eliminate uncertainty about hidden costs when buying a new car, Vauxhall publishes on-the-road recommended retail prices (RRP) and these are shown in the pricing tables within this price guide. These prices include VAT, number plates and delivery to Retailer of £700.00 (including £116.67 VAT), 12 months' Government Vehicle Excise Duty (see opposite for details) and the DVLA new vehicle first registration fee of £55.00.*

Please note: The on-the-road recommended retail price (RRP) does not include fuel supplied by the Retailer, motor insurance or any other goods or services supplied by agreement between the Retailer and the customer.

Price protection

Order a new Vauxhall for build in the current model year (as confirmed by your Retailer) for delivery no more than three months in advance and the price you are quoted is the price you pay. This is irrespective of any subsequent price rises between placing your order and delivery of your new car, but you must take delivery as soon as the car is available.

Please note: Price protection does not apply to Mokka-e/Corsa-e/Grandland X hybrid models. Vauxhall Motors Limited is not liable for price adjustments caused by Government changes in the rate of VAT (currently 20%), Vehicle Excise Duty, DVLA new vehicle first registration fee or by any other applicable legislation or regulations.

In the event of an accident

Vauxhall Accident Management helps keep you mobile following an accident. Benefits include vehicle recovery, Vauxhall-approved repairs and contacting your insurer. For more details, visit www.vauxhall.co.uk/AccidentManagement

Free2Move Lease

Whether you're a big company or a small business looking for vehicle financing, Free2Move Lease, our business finance specialists, can deliver exactly what you need.

Free2Move Lease is one of the UK's largest leasing companies and is also a member of the British Vehicle Rental and Leasing Association (BVRLA).

With over 60,000 vehicles in the Free2Move Lease portfolio, Free2Move Lease is able to offer competitive vehicle solutions. In addition, Free2Move Lease also offer innovative connected management of servicing and maintenance.

For further information, please contact your local Vauxhall Retailer or visit www.vauxhall.co.uk/offers-finance/business-leasing.html

Vehicle Excise Duty

The amount of Vehicle Excise Duty (road fund licence) payable on new cars varies depending on the level of carbon dioxide (CO₂) emissions produced by the vehicle. CO₂ emissions are measured in grams per kilometre (g/km) travelled and divided into 13 charging bands shown in the table opposite.

A 'first year rate' of Vehicle Excise Duty is payable on all new cars and in subsequent years the amount payable reverts to the 'standard rate'. From 1 April 2017 the breakpoints for each of these bands have been revised. Also, for vehicles with a list price over £40,000, including factory-fitted options, an additional £335 is payable for the first five years of standard rate payments.

Vehicle Excise Duty*

Band	CO ₂ emissions in grams per kilometre	First year rate Petrol/Diesel	Standard rate Petrol/Diesel
A	0	£0	£0
B	1-50	£10	£155
C	51-75	£25	£155
D	76-90	£115	£155
E	91-100	£140	£155
F	101-110	£160	£155
G	111-130	£180	£155
H	131-150	£220	£155
I	151-170	£555	£155
J	171-190	£895	£155
K	191-225	£1,345	£155
L	226-255	£1,910	£155
M	Over 255	£2,245	£155

*Correct at time of issue.

Further Information

Customer Care Commitment

For added peace of mind, Vauxhall has an innovative Customer Care Commitment that offers the following:

- Three-year vehicle warranty consisting of a one-year/unlimited mileage manufacturer's warranty and a second and third year manufacturer's warranty with a 60,000 miles limitation
- Vauxhall Assistance for 12 months from first registration
- Six years' body panel anti-perforation warranty

Please note: Warranty is only available on vehicles sourced from Vauxhall Motors Limited. Terms and conditions apply – please see your Vauxhall Retailer for details.

Vauxhall Assistance

Vauxhall Assistance is provided automatically with every new Vauxhall for 12 months from first registration and covers everything from accident assistance, roadside recovery and 'at home' service to flat tyres. Even more reason for you to stay calm and let us take care of everything should the need arise. With Vauxhall Assistance help is literally just a free* phone call away, 24 hours a day, 365 days a year!

Protecting the environment

Vauxhall's commitment to the environment is demonstrated by our products' many environmental awards. For even more information on Vauxhall's efforts to achieve an environmentally sustainable future, and how to dispose of your end-of-life vehicle, see www.vauxhall.co.uk/recycling

Vauxhall Care

This all-inclusive service package is available on Vauxhalls under 10 months old (from date of first registration).

This package offers complete peace of mind for the first 3 years of your Vauxhall's life with fixed monthly payments for the plan duration.

- **3 years' Vauxhall servicing** – covers first, second and third annual services. Including a brake-fluid change in the second service
- **2 years' Vauxhall Roadside Assistance** – first year from us
- **First years' MOT**** – free of charge by your local Vauxhall Retailer

For full terms and conditions and to sign up, visit: vauxhall.co.uk/vauxhallcare

Vauxhall Service Club

Vauxhall Service Club is available for all Vauxhall owners, and it's free to join. Members benefit from the following:

- 15% off Vauxhall Approved Accessories
- Vauxhall's aged 2-3 Years = 15% off parts and labour
- Vauxhall's aged over 3 Years = 25% off parts and labour
- Half price MOT's (NI excluded)
- Free pre-MOT test inspection (NI only)
- Fixed price AdBlue® Refills
 - Car = £14.99
 - Van = £24.99
- Access to the Vauxhall Accident Management Programme
- Online service booking available 24/7 with servicing appointments available within 3 days – [Book Online](#)
- Collection and delivery/onward mobility options
- Complimentary 'Wash and Vac' with all routine services†
- Vauxhall trained technicians
- Genuine Vauxhall parts
- Minimum 12 months warranty on parts and labour
- Regular newsletters with exclusive offers, discounts and competitions

Terms and conditions apply. To join visit: vauxhall.co.uk/serviceclub

Vauxhall Insurance with added reassurance

Comprehensive cover – Summary of benefits

- Competitive premiums
- Repairs by a Vauxhall-trained technician
- Genuine Vauxhall parts, guaranteed for five years when we repair your car within our Approved Repairer Network
- Free courtesy car as standard when using an Approved Repairer††
- 24 hour claims helpline
- Personal Accident benefit
- Cover for audio equipment
- Windscreen cover

Call for a quote on **0330 678 1130‡**

For more product information

For further information on the Vauxhall range or location of your nearest Vauxhall Retailer please call **0345 600 1500**. Alternatively, details can be found on our website at vauxhall.co.uk

For more information call **0345 600 1500**

For Fleet enquiries call **0330 587 8222**

Discover the full Vauxhall range at **[vauxhall.co.uk](https://www.vauxhall.co.uk)**

Join us online

The invoice price, including delivery to Retailer, factory-fitted options, accessories fitted by the Retailer and number plates, is subject to VAT. Some feature descriptions in this guide may refer to, and some illustrations may show, optional equipment not included in the standard delivery. The information contained in this guide was accurate at the time of publication. We reserve the right to make changes in design and equipment. Please note that Vauxhall Retailers are not the agents of Vauxhall Motors Limited and are not authorised to bind Vauxhall Motors Limited by any specific or implied undertaking or representation. It is advisable to ensure that your motor insurance policy provides adequate cover for additional fitted options and accessories. The colours in this guide are only approximate actual colours. Illustrated optional equipment is available at extra charge. Availability, technical features and equipment provided on our vehicles can vary by model. For precise information on the equipment provided on our vehicles, please contact your local Vauxhall Retailer.

VAUXHALL

Price and Specification Guide
21 May 2021 | Model Year 2021D



All-new Mokka

Contents

To find the information you want use the links below to navigate around the guide:

[Choose your Trim Level](#)

[Range Highlights](#)

[Models](#)

[Prices](#)

[Features/Options](#)

[Infotainment](#)

[Interior Style and Comfort](#)

[Exterior Colours](#)

[Wheels and Tyres](#)

[Engines and Technical Data](#)

[Performance, Economy and Emissions](#)

[Specifications](#)

[Dimensions and Capacities](#)

[Accessories](#)

[Company Car Information](#)

[Further Information](#)

Choose Your Trim Level

SE

First in the line-up is the wonderfully well-equipped SE.

Mokka-e SE Nav Premium
Mokka-e's entry level trim which is highly equipped as standard.



SRI

This sporty number in the range also comes as a Nav Premium model for even more tech.

Mokka-e SRI Nav Premium
Stylish, sporty and 100% electric in more ways than one.



Elite Nav

Both Elite Nav models come with sat nav as standard, with Elite Nav Premium giving you even more styling and technology features.

Mokka-e Elite Nav Premium
e-mobility with more than a hint of style and technology thrown in.



Ultimate Nav

All you could ask for; our Ultimate Nav model has it all.

Mokka-e Ultimate Edition
All you could ask for and all-electric; the Ultimate Edition model is top-of-the range.



All-new Mokka Range Highlights

SE

Standard features include:

- Multimedia infotainment system
 - 7-inch colour touchscreen
 - DAB digital radio
 - Bluetooth®
 - Front USB connection
- Six speakers
- 7-inch digital instrument cluster
- 16-inch silver alloy wheels
- Body coloured front/rear skid plates
- Black painted rear spoiler
- Chrome-effect upper window moulding
- Air conditioning • Driver drowsiness alert
- Forward collision alert (low speed)
- Automatic emergency city braking
- Speed sign recognition
- Cruise control with speed limiter
- Lane departure warning with lane keep assist
- Flat bottomed leather-covered steering wheel
- Steering column adjustable for reach and rake
- Steering wheel mounted audio controls
- Tyre pressure monitoring system
- Remote control central locking
- Electrically adjustable/heated door mirrors
- LED headlights and tail lights
- LED daytime running lights
- Six airbags • Hill start assist
- Rain-sensitive windscreen wipers*
- Automatic anti-dazzle rear-view mirror*
- Automatic lighting control with tunnel detection*

SRI

Features over SE models:

- 18-inch bi-colour alloy wheels with red accents
- Black roof
- Red upper window moulding
- Black Griffin logo and vizor frame
- Black front/rear skid plates
- Black headliner with LED lights
- Dark-tinted rear windows
- Vauxhall Connect**
- Front centre armrest with storage
- 2 rear USB connections
- Forward collision alert (all speed)
- Adaptive cruise control
- Lane positioning assistant†
- Heated front seats
- Electronic climate control
- LED front fog lights
- Rear parking distance sensors
- Alloy sports pedals
- Storage pockets on front seat backs
- Panoramic rear-view camera
- Sports switch with engine sound enhancement

Elite Nav

Features over SE models:

- Multimedia Navi infotainment system
 - Satellite navigation
 - 2 rear USB connections
- 17-inch bi-colour alloy wheels
- Black roof
- Chrome-effect front/rear skid plates
- Vauxhall Connect
- Forward collision alert (all speed)
- Adaptive cruise control
- Lane positioning assistant (Automatic transmission only)
- Heated front seats
- Heated steering wheel††
- Electronic climate control
- LED front fog lights
- Rear parking distance sensors
- Storage pockets on front seat backs
- Panoramic rear-view camera
- Front centre armrest with storage

Ultimate Nav

Features over Elite Nav models:

- Multimedia Navi Pro infotainment system
 - 10-inch colour touchscreen
- 12-inch digital instrument cluster
- 18-inch bi-colour alloy wheels
- Alcantara seat trim
- Black headliner with LED lights
- Dark-tinted rear windows
- Side blind spot alert and flank guard
- Front and rear parking distance sensors
- Remote control security alarm system
- Keyless entry and start
- IntelliLux LED® Matrix headlights with advanced forward lighting
- Automatic headlight levelling system
- Alloy sports pedals
- Sports switch with engine sound enhancement
- Electrically foldable door mirrors

Launch Edition

Features over Ultimate Nav models:

- Leather seat trim
- Massage functionality for driver's seat
- Advanced park assist

All-new Mokka-e Range Highlights

SE Nav Premium

Standard features include:

- Multimedia Navi infotainment system
 - Satellite navigation
 - 7-inch colour touchscreen
 - DAB digital radio
 - Bluetooth® audio streaming
 - Bluetooth® mobile phone portal
 - Apple CarPlay/Android Auto™
 - Front USB connection
- Six speakers • Vauxhall Connect
- 7-inch digital instrument cluster
- 16-inch silver alloy wheels
- Chrome-effect upper window moulding
- Driver drowsiness alert
- Forward collision alert (all speed)
- Lane positioning assistant
- Speed sign recognition
- Automatic emergency city braking
- Adaptive cruise control
- Rear parking distance sensors
- Panoramic rear-view camera
- Electrically/adjustable/heated door mirrors
- Rain-sensitive windscreen wipers
- Automatic anti-dazzle rear-view mirror
- Automatic lighting control with tunnel detection
- Remote control ultrasonic security alarm system
- Flat bottomed leather-covered steering wheel
- Electronic climate control • Keyless start
- LED headlights and tail lights

SRI Nav Premium

Features over SE Nav Premium models:

- Multimedia Navi Pro infotainment system
 - 10-inch colour touchscreen
 - 2 rear USB connections
- 12-inch digital instrument cluster
- 18-inch bi-colour alloy wheels with red accents
- Black roof
- Red upper window moulding
- Black Griffin logo and vizor frame
- Black front/rear skid plates
- Black headliner with LED lights
- Dark-tinted rear windows
- Front centre armrest with storage
- Side blind spot alert and flank guard
- Front and rear parking distance sensors
- Storage pockets on front seat backs
- Keyless entry and start
- Heated steering wheel
- Heated front seats
- LED front fog lights
- Alloy sports pedals
- Electrically foldable door mirrors

Elite Nav Premium

Features over SE Nav Premium models:

- Multimedia Navi Pro infotainment system
 - 10-inch colour touchscreen
 - 2 rear USB connections
- 12-inch digital instrument cluster
- 17-inch bi-colour alloy wheels
- Black roof
- Chrome-effect front/rear skid plates
- Front centre armrest with storage
- Side blind spot alert and flank guard
- Front and rear parking distance sensors
- Storage pockets on front seat backs
- Keyless entry and start
- Heated steering wheel
- Heated front seats
- LED front fog lights
- Electrically foldable door mirrors

Ultimate Edition

Features over Elite Nav Premium models:

- 18-inch bi-colour alloy wheels
- Black headliner with LED lights
- Advanced park assist
- IntelliLux LED® Matrix headlights with advanced forward lighting
- Automatic headlight levelling system
- Alloy sports pedals
- Dark-tinted rear windows
- Leather seat trim
- Massage functionality for driver's seat

Effective 21 May 2021

All-new Mokka Model Year 2021D

All-new Mokka SE



VX_MOK_31240

SE

OTR from £20,740

Infotainment:

- Multimedia system
 - 7-inch colour touchscreen
 - DAB digital radio
 - Bluetooth® audio streaming
 - Bluetooth® mobile phone portal
 - Apple CarPlay/Android Auto™
 - Front USB connection
- Six speakers

Interior convenience/styling:

- 7-inch digital instrument cluster
- Air conditioning
- Flat bottomed leather-covered steering wheel
- Automatic anti-dazzle rear-view mirror*
- Steering column adjustable for reach and rake
- Steering wheel mounted audio controls
- Storage pockets on front seat backs

Exterior convenience/styling:

- 16-inch silver alloy wheels
- Body coloured front/rear skid plates
- Chrome-effect upper window moulding
- Electrically adjustable/heated door mirrors
- Rain-sensitive windscreen wipers*
- LED headlights
- LED daytime running lights
- High beam assist
- LED tail lights
- Automatic lighting control with tunnel detection*

Safety/security:

- Driver drowsiness alert
- Forward collision alert (low speed)
- Automatic emergency city braking
- Cruise control with speed limiter
- Lane departure warning with lane keep assist
- Tyre pressure monitoring system
- Remote control central locking
- Speed sign recognition
- Electronic Stability Programme (ESP)
- Anti-lock Braking System (ABS)
- Six airbags • Hill start assist

*Available from July 2021 on automatic transmission only.
This vehicle is covered by our Price Protection Guarantee.
See 'Further Information' page for details.

All-new Mokka SRi



VX_MOK_31235

SRi

OTR from £23,410

Infotainment:

- Multimedia system
 - 7-inch colour touchscreen
 - DAB digital radio
 - Bluetooth® audio streaming
 - Bluetooth® mobile phone portal
 - Apple CarPlay/Android Auto™
 - Front USB connection
- Six speakers • Vauxhall Connect*

Interior convenience/styling:

- 7-inch digital instrument cluster
- Black headliner with LED lights
- Flat bottomed leather-covered steering wheel
- Automatic anti-dazzle rear-view mirror
- Alloy sports pedals • Heated front seats
- Electronic climate control
- Front centre armrest with storage
- Storage pockets on front seat backs
- Sports switch with engine sound enhancement
- Steering column adjustable for reach and rake
- Steering wheel mounted audio controls

Exterior convenience/styling:

- 18-inch bi-colour alloy wheels with red accents
- Black roof • Red upper window moulding
- Black Griffin logo and vizer frame
- Black front/rear skid plates
- Dark-tinted rear windows
- Electrically adjustable/heated door mirrors
- Rain-sensitive windscreen wipers
- LED headlights • LED front fog lights
- LED daytime running lights
- High beam assist • LED tail lights
- Automatic lighting control with tunnel detection

Safety/security:

- Active Drive Assist Plus
 - Driver drowsiness alert
 - Forward collision alert (all speed)
 - Automatic emergency city braking
 - Cruise control with speed limiter
 - Lane departure warning with lane keep assist (Manual transmission only)
 - Lane positioning assistant (Automatic transmission only)
 - Vauxhall Connect with e-Call*
- Tyre pressure monitoring system
- Remote control central locking
- Speed sign recognition
- Adaptive cruise control
- Rear parking distance sensors
- Panoramic rear-view camera
- Six airbags • Hill start assist

SRi Nav Premium

OTR from
£24,615

Features over SRi

- Multimedia Navi Pro infotainment system
 - Satellite navigation
 - 10-inch colour touchscreen
 - 2 rear USB connections
- 12-inch digital instrument cluster
- Side blind spot alert and flank guard
- Front and rear parking distance sensors
- Remote control ultrasonic security alarm system
- Keyless entry and start
- Heated steering wheel**
- Electrically foldable door mirrors

*Available from May 2021. **Excluding automatic transmission.

This vehicle is covered by our Price Protection Guarantee. See 'Further Information' page for details.

All-new Mokka Elite Nav



VX_MOK_31242

Elite Nav OTR from £23,210

Infotainment:

- Multimedia Navi system
 - Satellite navigation
 - 7-inch colour touchscreen
 - DAB digital radio
 - Bluetooth® audio streaming
 - Bluetooth® mobile phone portal
 - Apple CarPlay/Android Auto™
 - Front USB connection
 - 2 rear USB connections
- Six speakers
- Vauxhall Connect

Interior convenience/styling:

- 7-inch digital instrument cluster
- Flat bottomed leather-covered steering wheel
- Automatic anti-dazzle rear-view mirror
- Heated front seats
- Heated steering wheel*
- Electronic climate control
- Storage pockets on front seat backs
- Front centre armrest with storage
- Steering column adjustable for reach and rake
- Steering wheel mounted audio controls

Exterior convenience/styling:

- 17-inch bi-colour alloy wheels
- Black painted rear spoiler • Black roof
- Chrome-effect upper window moulding
- Matt chrome-effect front/rear skid plates
- Electrically/adjustable/heated door mirrors
- Rain-sensitive windscreen wipers
- LED headlights
- LED daytime running lights
- High beam assist
- LED tail lights

- LED front fog lights
- Automatic lighting control with tunnel detection

Safety/security:

- Active Drive Assist Plus
 - Driver drowsiness alert
 - Forward collision alert (all speed)
 - Automatic emergency city braking
 - Cruise control with speed limiter
 - Lane departure warning with lane keep assist (Manual transmission only)
 - Lane positioning assistant (Automatic transmission only)
 - Vauxhall Connect with e-Call
- Tyre pressure monitoring system
- Remote control central locking
- Speed sign recognition
- Adaptive cruise control
- Rear parking distance sensors
- Panoramic rear-view camera
- Six airbags • Hill start assist

Elite Nav Premium

OTR from
£24,260

Features over Elite Nav

- Multimedia Navi Pro system
 - 10-inch colour touchscreen
- 12-inch digital instrument cluster
- Side blind spot alert and flank guard
- Front and rear parking distance sensors
- Remote control ultrasonic security alarm system
- Keyless entry and start
- Electrically foldable door mirrors

*Excluding automatic transmission.

This vehicle is covered by our Price Protection Guarantee. See 'Further Information' page for details.

Effective 21 May 2021

All-new Mokka Model Year 2021D

All-new Mokka Ultimate Nav



VX_MOK_31244

Ultimate Nav

OTR from
£27,420

Infotainment:

- Multimedia Navi Pro system
 - Satellite navigation
 - 10-inch colour touchscreen
 - DAB digital radio
 - Bluetooth® audio streaming
 - Bluetooth® mobile phone portal
 - Apple CarPlay/Android Auto™
 - Front USB connection
 - 2 rear USB connections
- Six speakers
- Vauxhall Connect

Interior convenience/styling:

- 12-inch digital instrument cluster
- Black headliner with LED lights
- Flat bottomed leather-covered steering wheel
- Automatic anti-dazzle rear-view mirror
- Heated front seats
- Heated steering wheel*
- Electronic climate control
- Alloy sports pedals
- Storage pockets on front seat backs
- Front centre armrest with storage
- Sports switch with engine sound enhancement
- Steering column adjustable for reach and rake
- Steering wheel mounted audio controls

Exterior convenience/styling:

- 18-inch bi-colour alloy wheels
- Black roof
- Chrome-effect upper window moulding
- Chrome-effect front/rear skid plates
- Dark-tinted rear windows

- Electrically foldable/adjustable/heated door mirrors
- Rain-sensitive windscreen wipers
- IntelliLux LED® Matrix headlights with advanced forward lighting
- LED daytime running lights
- High beam assist
- LED tail lights
- LED front fog lights
- Automatic headlight levelling system
- Automatic lighting control with tunnel detection

Safety/security:

- Active Drive Assist Plus
 - Driver drowsiness alert
 - Forward collision alert (all speed)
 - Automatic emergency city braking
 - Cruise control with speed limiter
 - Lane departure warning with lane keep assist (Manual transmission only)
 - Lane positioning assistant (Automatic transmission only)
 - Vauxhall Connect with e-Call
- Tyre pressure monitoring system
- Remote control ultrasonic security alarm system
- Speed sign recognition
- Adaptive cruise control
- Side blind spot alert and flank guard
- Front and rear parking distance sensors
- Panoramic rear-view camera
- Keyless entry and start
- Six airbags • Hill start assist

*Excluding automatic transmission.

This vehicle is covered by our Price Protection Guarantee. See 'Further Information' page for details.

All-new Mokka Launch Edition



VX_MOK_31245

Launch Edition OTR from **£28,650**

Infotainment:

- Multimedia Navi Pro system
 - Satellite navigation
 - 10-inch colour touchscreen
 - DAB digital radio
 - Bluetooth® audio streaming
 - Bluetooth® mobile phone portal
 - Apple CarPlay/Android Auto™
 - Front USB connection
 - 2 rear USB connections
- Six speakers • Vauxhall Connect

Interior convenience/styling:

- 12-inch digital instrument cluster
- Black headliner with LED lights
- Flat bottomed leather-covered steering wheel
- Automatic anti-dazzle rear-view mirror
- Heated front seats
- Heated steering wheel*
- Electronic climate control
- Alloy sports pedals
- Massage functionality for driver's seat
- Storage pockets on front seat backs
- Leather seat trim
- Front centre armrest with storage
- Sports switch with engine sound enhancement
- Steering column adjustable for reach and rake
- Steering wheel mounted audio controls

Exterior convenience/styling:

- 18-inch bi-colour alloy wheels
- Black roof
- Chrome-effect upper window moulding
- Chrome-effect front/rear skid plates

- Dark-tinted rear windows
- Electrically foldable/adjustable/heated door mirrors
- Rain-sensitive windscreen wipers
- IntelliLux LED® Matrix headlights with advanced forward lighting
- LED daytime running lights
- High beam assist
- LED tail lights
- LED front fog lights
- Automatic headlight levelling system
- Automatic lighting control with tunnel detection

Safety/security:

- Active Drive Assist Plus
 - Driver drowsiness alert
 - Forward collision alert (all speed)
 - Automatic emergency city braking
 - Cruise control with speed limiter
 - Lane departure warning with lane keep assist (Manual transmission only)
 - Lane positioning assistant (Automatic transmission only)
 - Vauxhall Connect with e-call
- Tyre pressure monitoring system
- Remote control ultrasonic security alarm system
- Speed sign recognition
- Adaptive cruise control
- Side blind spot alert and flank guard
- Front and rear parking distance sensors
- Panoramic rear-view camera
- Keyless entry and start
- Advanced park assist
- Six airbags • Hill start assist

*Excluding automatic transmission.

This vehicle is covered by our Price Protection Guarantee. See 'Further Information' page for details.

Effective 21 May 2021

All-new Mokka Model Year 2021D

All-new Mokka-e SE Nav Premium



VX_MOK_31241

SE Nav Premium OTR £30,540*

Infotainment:

- Multimedia Navi system
 - Satellite navigation
 - 7-inch colour touchscreen
 - DAB digital radio
 - Bluetooth® audio streaming
 - Bluetooth® mobile phone portal
 - Apple CarPlay/Android Auto™
 - Front USB connection
- Six speakers
- Vauxhall Connect
- 7-inch digital instrument cluster

Interior convenience/styling:

- Automatic anti-dazzle rear-view mirror
- Flat bottomed leather-covered steering wheel
- Electronic climate control
- Steering column adjustable for reach/rake

Exterior convenience/styling:

- 16-inch silver alloy wheels
- Chrome-effect upper window moulding
- Electrically/adjustable/heated door mirrors
- Rain-sensitive windscreen wipers
- LED headlights
- LED daytime running lights
- High beam assist
- LED tail lights
- Automatic lighting control with tunnel detection

Safety/security:

- Active driver Assist Plus
 - Driver drowsiness alert
 - Forward Collision alert (all speed)
 - Automatic emergency city braking
 - Adaptive cruise control
 - Lane positioning assistant
- Rear parking distance sensors
- Panoramic rear-view camera
- Speed sign recognition
- Remote control ultrasonic security alarm system
- Keyless start
- Tyre pressure monitoring system
- Hill start assist

*Price shown is after allowing for PiCG (Plug-in Car Grant).

Effective 21 May 2021

All-new Mokka Model Year 2021D

All-new Mokka-e SRi Nav Premium



VX_MOK_31238

SRi Nav Premium OTR £32,435*

Infotainment:

- Multimedia Navi Pro system
 - Satellite navigation
 - 10-inch colour touchscreen
 - DAB digital radio
 - Bluetooth® audio streaming
 - Bluetooth® mobile phone portal
 - Apple CarPlay/Android Auto™
 - Front USB connection
 - 2 rear USB connections
- Six speakers
- Vauxhall Connect
- 12-inch digital instrument cluster

Interior convenience/styling:

- Black headliner with LED lights
- Automatic anti-dazzle rear-view mirror
- Flat bottomed leather-covered steering wheel
- Electronic climate control
- Heated steering wheel
- Heated front seats
- Alloy sports pedals
- Front centre armrest with storage
- Storage pockets on front seat backs
- Steering column adjustable for reach/rake

Exterior convenience/styling:

- 18-inch bi-colour alloy wheels with red accents
- Black roof
- Red upper window moulding
- Black Griffin logo and vizer frame
- Black front/rear skid plates
- Dark-tinted rear windows
- Electrically foldable/adjustable/heated door mirrors
- Rain-sensitive windscreen wipers
- LED headlights
- LED daytime running lights
- High beam assist
- LED tail lights
- LED front fog lights
- Automatic lighting control with tunnel detection

Safety/security:

- Active Driver Assist Plus
 - Driver drowsiness alert
 - Forward collision alert (all speed)
 - Automatic emergency city braking
 - Adaptive cruise control
 - Lane positioning assistant
 - Vauxhall Connect with e-call
- Front and rear parking distance sensors
- Panoramic rear-view camera
- Speed sign recognition
- Remote control ultrasonic security alarm system
- Keyless entry and start
- Tyre pressure monitoring system
- Side blind spot alert and flank guard
- Hill start assist

*Price shown is after allowing for PiCG (Plug-in Car Grant).

Effective 21 May 2021

All-new Mokka Model Year 2021D

All-new Mokka-e Elite Nav Premium



VX_MOK_31243

Elite Nav Premium OTR £32,080*

Infotainment:

- Multimedia Navi Pro system
 - Satellite navigation
 - 10-inch colour touchscreen
 - DAB digital radio
 - Bluetooth® audio streaming
 - Bluetooth® mobile phone portal
 - Apple CarPlay/Android Auto™
 - Front USB connection
 - 2 rear USB connections
- Six speakers
- Vauxhall Connect
- 12-inch digital instrument cluster

Interior convenience/styling:

- Automatic anti-dazzle rear-view mirror
- Flat bottomed leather-covered steering wheel
- Electronic climate control
- Steering column adjustable for reach/rake
- Heated steering wheel
- Heated front seats
- Alloy sports pedals
- Front centre armrest with storage
- Storage pockets on front seat backs

Exterior convenience/styling:

- 17-inch bi-colour alloy wheels
- Black roof
- Chrome-effect upper window moulding
- Chrome-effect front/rear skid plates
- Electrically foldable/adjustable/heated door mirrors
- Rain-sensitive windscreen wipers
- LED headlights
- LED daytime running lights
- High beam assist
- LED tail lights
- LED front fog lights
- Automatic lighting control with tunnel detection

Safety/security:

- Active Driver Assist Plus
 - Driver drowsiness alert
 - Forward collision alert (all speed)
 - Automatic emergency city braking
 - Adaptive cruise control
 - Lane positioning assistant
 - Vauxhall Connect with e-Call
- Front and rear parking distance sensors
- Panoramic rear-view camera
- Speed sign recognition
- Remote control ultrasonic security alarm system
- Keyless entry and start
- Tyre pressure monitoring system
- Side blind spot alert and flank guard
- Hill start assist

*Price shown is after allowing for PiCG (Plug-in Car Grant).

Effective 21 May 2021

All-new Mokka Model Year 2021D

All-new Mokka-e Ultimate Edition



VX_MOK_31246

Ultimate Edition OTR £32,495*

Infotainment:

- Multimedia Navi Pro system
 - Satellite navigation
 - 10-inch colour touchscreen
 - DAB digital radio
 - Bluetooth® audio streaming
 - Bluetooth® mobile phone portal
 - Apple CarPlay/Android Auto™
 - Front USB connection
 - 2 rear USB connections
- Six speakers
- Vauxhall Connect
- 12-inch digital instrument cluster

Interior convenience/styling:

- Black headliner with LED lights
- Automatic anti-dazzle rear-view mirror
- Flat bottomed leather-covered steering wheel
- Electronic climate control
- Steering column adjustable for reach/rake
- Heated steering wheel
- Heated front seats
- Alloy sports pedals
- Front centre armrest with storage
- Massage functionality for driver's seat
- Storage pockets on front seat backs
- Leather seat trim

Exterior convenience/styling:

- 18-inch bi-colour alloy wheels
- Black roof
- Chrome-effect upper window moulding
- Chrome-effect front/rear skid plates
- Dark-tinted rear windows
- Electrically foldable/adjustable/heated door mirrors
- Rain-sensitive windscreen wipers
- IntelliLux LED® Matrix headlights with advanced forward lighting
- LED daytime running lights
- High beam assist
- LED tail lights
- LED front fog lights
- Automatic headlight levelling system
- Automatic lighting control with tunnel detection

Safety/security:

- Active Driver Assist Plus
 - Driver drowsiness alert
 - Forward collision alert (all speed)
 - Automatic emergency city braking
 - Adaptive cruise control
 - Lane positioning assistant
 - Vauxhall Connect with e-call
- Front and rear parking distance sensors
- Panoramic rear-view camera
- Speed sign recognition
- Remote control ultrasonic security alarm system
- Keyless entry and start
- Tyre pressure monitoring system
- Side blind spot alert and flank guard
- Advanced park assist
- Hill start assist

*Price shown is after allowing for PiCG (Plug-in Car Grant).

All-new Mokka Prices

	Pack Code	Fuel Type	Price (£)	VAT (£)	Total (£)	On-the-road RRP (£)	Financial Year 2021/22 BiK 20% (£)	WLTP Combined CO ₂ (g/km)* - pack code	Insurance groups
SE									
1.2 (100PS) Turbo	MC76 EU61	Petrol	16,504.17	3,300.83	19,805.00	20,740.00	99.10	125	13E
1.5 (110PS) Turbo D*	MC76 HZ61	Diesel	18,004.17	3,600.83	21,605.00	22,540.00	96.65	114	14E
SRI									
1.2 (100PS) Turbo	MT76 EU61	Petrol	18,729.17	3,745.83	22,475.00	23,410.00	112.00	127	14E
1.2 (130PS) Turbo*	MT76 EP61	Petrol	19,729.17	3,945.83	23,675.00	24,610.00	117.80	126	20D
1.2 (130PS) Turbo auto	MT76 EF81	Petrol	21,062.50	4,212.50	25,275.00	26,250.00	134.20	137	20D
1.5 (110PS) Turbo D*	MT76 HZ61	Diesel	20,229.17	4,045.83	24,275.00	25,210.00	112.38	116	15E
SRI Nav Premium									
1.2 (100PS) Turbo	MT76 EU6X	Petrol	19,733.33	3,946.67	23,680.00	24,615.00	117.83	127	14E
1.2 (130PS) Turbo*	MT76 EP6X	Petrol	20,733.34	4,146.67	24,880.00	25,815.00	123.63	126	18E
1.2 (130PS) Turbo auto	MT76 EF8X	Petrol	22,066.67	4,413.33	26,480.00	27,455.00	140.42	137	18E
1.5 (110PS) Turbo D*	MT76 HZ6X	Diesel	21,233.33	4,246.67	25,480.00	26,415.00	117.80	116	15E
Elite Nav									
1.2 (100PS) Turbo	ME76 EU61	Petrol	18,562.50	3,712.50	22,275.00	23,210.00	111.03	127	14E
1.2 (130PS) Turbo*	ME76 EP61	Petrol	19,562.50	3,912.50	23,475.00	24,410.00	116.83	126	20D
1.2 (130PS) Turbo auto	ME76 EF81	Petrol	20,895.84	4,179.17	25,075.00	26,050.00	133.17	137	20D
1.5 (110PS) Turbo D*	ME76 HZ61	Diesel	20,062.50	4,012.50	24,075.00	25,010.00	111.48	116	15E
Elite Nav Premium									
1.2 (100PS) Turbo	MJ76 EU61	Petrol	19,437.50	3,887.50	23,325.00	24,260.00	116.12	127	14E
1.2 (130PS) Turbo*	MJ76 EP61	Petrol	20,437.50	4,087.50	24,525.00	25,460.00	121.92	126	18E
1.2 (130PS) Turbo auto	MJ76 EF81	Petrol	21,770.84	4,354.17	26,125.00	27,100.00	138.58	137	18E
1.5 (110PS) Turbo D*	MJ76 HZ61	Diesel	20,937.50	4,187.50	25,125.00	26,060.00	116.20	116	15E

Mokka's petrol and diesel engines meet the Real Driving Emissions Step 2 (RDE2) standards.

*Fuel consumption and CO₂ figures are determined according to the WLTP test cycle. CO₂ figures, BiK values and RRP pricing shown above are for a standard vehicle without any additional optional equipment. CO₂ figures are used to calculate Vehicle Excise Duty (VED) for the first registration of the vehicle and BiK. The addition of optional extras could increase the certified CO₂ emission output. This in turn may affect the amount of VED payable upon registration, and, for company car drivers, the P11D value and the amount of Benefit in Kind (BiK) tax payable. Figures shown are for comparison purposes and should only be compared to the fuel consumption and CO₂ values of other cars tested to the same technical standard. The fuel consumption achieved, and CO₂ produced, in real world conditions will depend upon a number of factors including, but not limited to: the accessories fitted (pre and post registration); variations in weather; driving styles and vehicle load. The WLTP (Worldwide Harmonised Light Vehicles Test Procedure) is used to measure fuel consumption and CO₂ figures. Full data relating to WLTP test cycles can be found at: www.vauxhall.co.uk/wltp

Please note: On-the-road recommended retail prices (RRP) include number plates and delivery to Retailer of £700.00 (inc. £116.67 VAT), 12 months' Vehicle Excise Duty and new vehicle first registration fee of £55.00. Excludes fuel and insurance. Company Car Benefit in Kind (BiK) rates are monthly based on the standard paint price. On-the-road prices feature a VED based on preliminary CO₂ information.

*Available April 2021.

Effective 21 May 2021

All-new Mokka Model Year 2021D

All-new Mokka Prices

	Pack Code	Fuel Type	Price (£)	VAT (£)	Total (£)	On-the-road RRP (£)	Financial Year 2021/22 BiK 20% (£)	WLTP Combined CO ₂ (g/km)* - pack code	Insurance groups
Ultimate Nav									
1.2 (130PS) Turbo auto	MU76 EF81	Petrol	22,904.17	4,580.83	27,485.00	28,460.00	145.62	137	19E
1.5 (110PS) Turbo D*	MU76 HZ61	Diesel	22,070.84	4,414.17	26,485.00	27,420.00	122.32	116	16E
Launch Edition									
1.2 (130PS) Turbo auto	MU76 EF8X	Petrol	23,929.17	4,785.83	28,715.00	29,690.00	151.97	137	19E
1.5 (110PS) Turbo D*	MU76 HZ6X	Diesel	23,095.83	4,619.17	27,715.00	28,650.00	127.87	116	17E

Mokka's petrol and diesel engines meet the Real Driving Emissions Step 2 (RDE2) standards.

*Fuel consumption and CO₂ figures are determined according to the WLTP test cycle. CO₂ figures, BiK values and RRP pricing shown above are for a standard vehicle without any additional optional equipment. CO₂ figures are used to calculate Vehicle Excise Duty (VED) for the first registration of the vehicle and BiK. The addition of optional extras could increase the certified CO₂ emission output. This in turn may affect the amount of VED payable upon registration, and, for company car drivers, the P11D value and the amount of Benefit in Kind (BiK) tax payable. Figures shown are for comparison purposes and should only be compared to the fuel consumption and CO₂ values of other cars tested to the same technical standard. The fuel consumption achieved, and CO₂ produced, in real world conditions will depend upon a number of factors including, but not limited to: the accessories fitted (pre and post registration); variations in weather; driving styles and vehicle load. The WLTP (Worldwide Harmonised Light Vehicles Test Procedure) is used to measure fuel consumption and CO₂ figures. Full data relating to WLTP test cycles can be found at: www.vauxhall.co.uk/wltp

Please note: On-the-road recommended retail prices (RRP) include number plates and delivery to Retailer of £700.00 (inc. £116.67 VAT), 12 months' Vehicle Excise Duty and new vehicle first registration fee of £55.00. Excludes fuel and insurance. Company Car Benefit in Kind (BiK) rates are monthly based on the standard paint price. On-the-road prices feature a VED based on preliminary CO₂ information.

*Available April 2021.

Effective 21 May 2021

All-new Mokka Model Year 2021D

All-new Mokka-e Prices

	Pack Code	Price (£)	VAT (£)	Total (£)	On-the-road RRP before PiCG (£)	On-the-road RRP after PiCG (£)	Financial Year 2021/22 BiK 20% (£)	WLTP Combined CO ₂ (g/km) - pack code	Insurance groups
SE Nav Premium 11kw									
Electric Propulsion (136PS) auto	MD76 9CQ1	26,904.17	5,380.83	32,285.00	33,040.00	30,540.00	5.48	0	21E
SRI Nav Premium 11kw									
Electric Propulsion (136PS) auto	MN76 9CQ1	28,483.33	5,696.67	34,180.00	34,935.00	32,435.00	5.80	0	22E
Elite Nav Premium 11kw									
Electric Propulsion (136PS) auto	ML76 9CQ1	28,187.50	5,637.50	33,825.00	34,580.00	32,080.00	5.75	0	22E
Ultimate Edition 11kw									
Electric Propulsion (136PS) auto	MH76 9CQ1	28,533.33	5,706.67	34,240.00	34,995.00	32,495.00	5.82	0	23E

Please note: On-the-road recommended retail prices (RRP) include number plates and delivery to Retailer of £700.00 (inc. £116.67 VAT), 12 months' Vehicle Excise Duty and new vehicle first registration fee of £55.00. Excludes fuel and insurance. Company Car Benefit in Kind (BiK) rates are monthly based on the standard paint price. Price has been calculated using manufacturer estimates and includes a £2,500.00 OZEV grant which has been deducted from the price of the vehicle (OZEV Grant not available in the Isle of Man). New Mokka-e is expected to be a qualifying model for this grant subject to acceptance by OZEV. Please check with your Retailer for latest status. The grant is a government incentive and is subject to withdrawal prior to delivery of your vehicle. Retailers may be required to carry out more than one credit check during the course of the order process. You may be required to place a deposit when placing your order with your supplying Retailer. In the event of a price change, deposit refunds will be governed by your supplying Retailer's policy and as such must be discussed with the supplying Retailer.

Mokka-e is not covered by our Price Protection Guarantee. See 'Further Information' page for details.

Safety

Standard Features – The following features are standard across the entire Mokka range.

Airbags

- Driver's airbag
- Front passenger's airbag
- Front seat side-impact airbags
- Full-size curtain airbags

Seating

- Three height adjustable rear seat head restraints

Seatbelts

- Inertia-reel lap and diagonal seatbelts
- Seatbelt unfastened' audible warning and warning light

Braking

- Automatic emergency city braking – The system works automatically in conjunction with forward collision alert, at speeds between 3mph and 53mph, and detects both vehicles and pedestrians. If no avoiding action is taken by the driver, at speeds below 19mph the system automatically slows the vehicle to a full stop with emergency braking of 0.9g. At speeds from 19mph to 53mph it brakes automatically to reduce speed by a maximum of 14mph – to reduce speed even further the driver must brake him/herself.

- Anti-lock Braking System (ABS)
- Emergency brake assist – When emergency braking is detected the vehicle automatically applies the maximum possible braking assistance
- Electronic brakeforce distribution – Automatically apportions the optimum braking force to each wheel
- Hill start assist – Briefly maintains rear brake pressure to stop the vehicle rolling back on an incline
- Adaptive brake lights – Automatically warns other road users of heavy braking

Child Safety

- Deactivation switch for front passenger's front and side-impact airbags
- ISOFIX child seat mountings incorporating top tether anchor points located on outer rear seats (does not include child seat) – Allows ISOFIX child safety seats to be securely fixed into the car. The ISOFIX mounting system reduces forward movement in an accident and makes the child seat easier to install
- Child-proof locks on rear doors

Stability

- Electronic Stability Programme (ESP) – ESP monitors many different inputs to determine when the car starts to lose traction, it can then immediately respond by varying the brake pressure between up to three wheels and adjust the engine output to help correct the loss of traction and improve stability

Additional ESP features

- Traction control
- Cornering brake control
- Straight line stability control
- Drag torque control – Maintain stability on slippery roads when lifting off the accelerator or changing gear.

Tyre pressure

- Tyre pressure monitoring system.

Vauxhall driver assistance systems are intended to support the driver within the system-imminent limitations. The driver remains responsible for the driving task at all times.



Hill start assist.



ISOFIX child seat mountings.



Automatic emergency city braking.

Driver Assistance

Standard Features – The following features are standard across the entire Mokka range.
Specific features by model are outlined in the separate tabular information.

Cruise control with speed limiter

With steering wheel mounted controls. Enables you to maintain a constant speed, making it ideal for economical motorway driving.

Front camera system

A range of class-leading driver assistance and safety features are controlled by the front camera system.

Forward collision alert

The system operates automatically from 3mph and gives an audible warning as well as a visual warning when approaching another vehicle too quickly.

Steering

- Speed sensitive electrically assisted power steering
- Reach and rake adjustable steering

Speed sign recognition

Detects and then displays speed limits, reducing uncertainty and the risk of speeding.

- Recognises different speed signs, including temporary speed restrictions
- Displays reminder in the instrument cluster

Driver drowsiness alert

The system monitors driving time and driving behaviour to help prevent accidents caused by tiredness.

Lane departure warning with lane keep assist

If the driver has not actively steered or signalled, the lane departure warning system provides gentle steering correction and warns when the car moves outside of lane markings at speeds above 40mph.

- Warning light in instrument cluster
- Audible warning
- Facia on/off switch

Model Specific Features

								Electric models			
	SE	SRI	SRI Nav Premium	Elite Nav	Elite Nav Premium	Ultimate Nav	Launch Edition	SE Nav Premium	SRI Nav Premium	Elite Nav Premium	Ultimate Edition
Driver Assistance											
Forward collision alert (low speed)	●										
Forward collision alert (all speed)		●	●	●	●	●	●	●	●	●	●
Lane positioning assistant (automatics only)		●	●	●	●	●	●	●	●	●	●
Adaptive cruise control		●	●	●	●	●	●	●	●	●	●
Side blind spot alert and flank guard			●		●	●	●		●	●	●
Rear parking distance sensors		●		●				●			
Front and rear parking distance sensors			●		●	●	●		●	●	●
Panoramic rear-view camera		●	●	●	●	●	●	●	●	●	●
Advanced park assist							●				●
Sports switch with engine sound enhancement		●	●			●	●				

Convenience

Standard Features – The following features are standard across the entire Mokka range.
Specific features by model are outlined in the separate tabular information.

Interior Convenience

- Front 12-volt electrical accessory socket
- Driver's and front passengers sunvisors incorporating vanity mirrors with covers
- Dipping rear-view mirror
- Reach and rake-adjustable steering
- Steering wheel mounted audio controls
- Front USB connection

Heating and Ventilation

- Air recirculation facility
- Cabin particulate filter – Removes dust, airborne particles and pollen
- Four-speed fan
- Illuminated controls
- Four adjustable facia vents
- Windscreen demist vents
- Side window demist vents

Interior Storage

- Centre console with two cup holders at front and one in rear
- Interior courtesy light
- Front map reading lights
- Luggage compartment lighting
- Door pockets with two-litre capacity

Model Specific Features

									Electric models			
	SE	SRi	SRi Nav Premium	Elite Nav	Elite Nav Premium	Ultimate Nav	Launch Edition	SE Nav Premium	SRi Nav Premium	Elite Nav Premium	Ultimate Edition	
Interior Convenience and Storage												
Front centre armrest with storage		●	●	●	●	●	●		●	●	●	
Automatically dimming anti-dazzle rear-view mirror	●*	●	●	●	●	●	●		●	●	●	
Storage pockets on front seat backs		●	●	●	●	●	●		●	●	●	
2 rear USB connections		●	●	●	●	●	●		●	●	●	
Heating and Ventilation												
Air conditioning	●											
Electronic climate control		●	●	●	●	●	●	●	●	●	●	
Heated steering wheel**			●	●	●	●	●		●	●	●	
Heated front seats		●	●	●	●	●	●		●	●	●	

*Available from July 2021 on automatic transmission only. **Excluding automatic transmission.

Convenience

Standard Features – The following features are standard across the entire Mokka range.
Specific features by model are outlined in the separate tabular information.

Security

- ‘Key left in ignition’ audible warning
- Electronically protected audio equipment
- Engine deadlock immobiliser
- Visible Vehicle Identification Number (VIN)
- Locking wheel bolts for alloy wheels
- Freewheeling door locks

Remote control central locking

- Operates on doors, tailgate and fuel filler flap
- Deadlocking
- Central locking activation switch on driver’s door

Luggage Area

- Luggage compartment cover
- Illuminated load area
- Fully carpeted load area
- Interior tailgate handle
- Four load restraint lashing eyes
- Twin gas-assisted tailgate struts

Interior Lighting

- Central front courtesy light
- Central rear courtesy light
- Fade up/fade down

Exterior Convenience

Door mirrors

- Twin electrically adjustable/heated door mirrors

Windows

- Solar heat-absorbing windscreen
- Electrically operated front and rear windows with safety autoreverse and one-touch up/down facility
- Heated rear window and wash/wipe facility

Wipers

- Two-speed windscreen wipers with variable intermittent wipe
- Intermittent rear window wash/wipe

Model Specific Features

									Electric models			
	SE	SRI	SRI Nav Premium	Elite Nav	Elite Nav Premium	Ultimate Nav	Launch Edition	SE Nav Premium	SRI Nav Premium	Elite Nav Premium	Ultimate Edition	
Security												
Remote control ultrasonic security alarm system			●		●	●	●	●	●	●	●	
Keyless start								●				
Keyless entry and start			●		●	●	●		●	●	●	
Exterior Convenience												
Solar heat-absorbing windows	●			●	●			●		●		
Electrically foldable door mirrors			●		●	●	●		●	●	●	
Rain-sensitive windscreen wipers	●*	●	●	●	●	●	●	●	●	●	●	

*Available from July 2021 on automatic transmission only.

Exterior Style and Lighting

Standard Features – The following features are standard across the entire Mokka range.
Specific features by model are outlined in the separate tabular information.

Exterior Styling

- Body-colour front and rear bumpers
- Body-colour door handles
- Black door mirror housing
- Integrated black tailgate spoiler

Exterior Lighting

- LED daytime running lights
- LED side repeat indicators
- Lights-on audible warning – When driver's door is opened an audible warning sounds to alert the lights have been left on.
- LED tail lights
- Rear fog light
- Reversing light
- Hazard warning lights

Model Specific Features/Option

	SE	SRi	SRi Nav Premium	Elite Nav	Elite Nav Premium	Ultimate Nav	Launch Edition	Electric models			
								SE Nav Premium	SRi Nav Premium	Elite Nav Premium	Ultimate Edition
Exterior Styling											
Dark-tinted rear windows		●	●			●	●		●		●
Black Griffin logo and vizor frame		●	●						●		
Body coloured front/rear skid plates	●							●			
Black front/rear skid plates		●	●						●		
Chrome-effect front/rear skid plates				●	●	●	●			●	●
Exterior Lighting											
LED headlights	●	●	●	●	●			●	●	●	
IntelliLux Matrix LED® headlights with advanced forward lighting		£700*	£700*	£700*	£700*	●	●		£700*	£700*	●
Automatic lighting control with tunnel detection	●**	●	●	●	●	●	●	●	●	●	●
High beam assist	●	●	●	●	●			●	●	●	
High beam assist with anti-glare						●	●				●
LED front fog lights		●	●	●	●	●	●		●	●	●
Manual headlight levelling system	●	●	●	●	●			●	●	●	
Automatic headlight levelling system						●	●				●

*Optional at extra cost including VAT. **Available from July 2021 on automatic transmission only.

Pure Panel – Driver Information

Standard Features – The following features are standard across the entire Mokka range. Specific features by model are outlined in the separate tabular information.

Digital Display Information

Pure Panel technology makes driving more intuitive, with a flowing design that presents the information you need. With up to a 10-inch infotainment touchscreen and 12-inch digital instrument cluster right in front of you, you can stay focused on the road ahead.

Driver Information

Digital instrumentation

- Digital speedometer and rev counter
- Satellite Navigation display
- Digital fuel gauge with low fuel level warning light
- Digital water temperature gauge with warning light
- Shift-up/down indication light – Indicates when to change gear for optimum fuel economy.

Driver information display

(centrally located in digital instrument cluster)

- Total mileage
- Service-due indicator
- Oil life
- Tyre pressure monitoring system

Multi-function trip computer

(displayed on digital instrument cluster)

- Trip mileage
- Vehicle range based on remaining fuel
- Average speed
- Average fuel economy
- Instantaneous fuel economy
- Driving time

Digital central facia display (format dependent on infotainment unit)

- Audio information
- Digital clock with automatic RDS time adjustment
- Outside air temperature with ice warning function
- Additional features dependent on infotainment unit



Model Specific Features

	SE	SRI	SRI Nav Premium	Elite Nav	Elite Nav Premium	Ultimate Nav	Launch Edition	Electric models			
								SE Nav Premium	SRI Nav Premium	Elite Nav Premium	Ultimate Edition
Driver Information											
7-inch digital instrument cluster (centrally located in instrument panel)	●	●		●				●			
12-inch digital instrument cluster (centrally located in instrument panel)			●		●	●	●		●	●	●

Pure Panel – Infotainment

Standard Features

Multimedia with 7-inch touchscreen

Standard on SE and SRi

Onboard features:

- 7-inch colour touchscreen
- DAB Digital radio
- RDS with Traffic Programme
- AM/FM stereo radio with 36 station presets
- Six speakers

Media connections:

- USB connection
- Bluetooth® A2DP audio streaming (Advanced Audio Distribution Profile)

Mobile phone portal:

- Bluetooth® connectivity
- Vehicle microphone
- Handsfree calls via steering wheel controls
- Phone book access – Contacts/last calls/missed calls etc. are mirrored on the display and are easily navigated using the touchscreen (features dependent on mobile phone).
- SMS read out and reply

Smartphone interface:

- Apple CarPlay • Android Auto™
- Smartphone projection that allows operations via voice command, touchscreen and buttons to control apps and music playback

Additional features:

- Steering wheel mounted audio controls
- Flexible roof-mounted aerial

Please note that compatibility and certain functions may be different depending on the type of device and operating system you're using with the Multimedia systems. Apple CarPlay is a trademark of Apple Inc. Apple and iPhone are trademarks of Apple Inc., registered in the U.S. and other countries. Android is a trademark of Google Inc, also registered in the U.S. and other countries. *Standard on SRi (from May 2021) and Nav models only. Services may require a subscription/fee and are subject to mobile network coverage and availability. Standard on Nav models only. Live navigation services are included for 3 years and thereafter are subject to an additional subscription fee.

Multimedia Navi with 7-inch touchscreen

Standard on Elite Nav

Standard on Mokka-e SE Nav Premium models

Features as Multimedia, with the addition of:

- Satellite navigation system
- 2D/3D street level mapping
- European coverage
- Points-of-interest search
- Map updates via USB

Multimedia Navi Pro with 10-inch touchscreen

Standard on SRi Nav Premium, Elite Nav Premium, Ultimate Nav and Launch Edition

Standard on Mokka-e SRi Nav Premium, Elite Nav Premium and Ultimate Edition models

Features as Multimedia Navi, with the addition of:

- 10-inch colour touchscreen

Vauxhall Connect*

e-Call and b-Call:

Help when you need it, 24/7, 365 days a year, that's what you get with new Vauxhall Connect. In an emergency or breakdown, you'll be put in touch with a trained advisor, with just the touch of a button.

Live navigation and more:

You can also access live navigation services, receive regular vehicle diagnostic info plus there's a host of remote convenience features available through the MyVauxhall app.

- **Peace of mind:** emergency call, breakdown call and regular vehicle status and information
- **Convenience:** remote functions (e.g. lock/unlock the door).
- **Our additional services for electric vehicles:** trip planning, remote settings or public charging solutions – we keep you going!
- **Smart driving:** enjoy a relaxed ride thanks to live navigation and trip management



Please note, Apple CarPlay screen illustrated on 10-inch colour touchscreen on multimedia Navi Pro audio unit.

Interior Styling and Comfort

SE/SE Nav Premium



Steering wheel:

- Three-spoke design
- Flat bottomed leather-covered steering wheel
- Satin chrome-effect bezel

Facia and door trim:

- Black facia with silver trim inserts
- Instrument panel bar Light Gravel
- Atlantis black trim inserts on front doors
- Chrome-effect interior door handles

Seating:

- Driver's seat (six-way adjustable):
 - Height
 - Reach
 - Backrest
- Front passenger's seat (four-way adjustable)
 - Reach
 - Backrest

Seat trim:

- Jet black fabric seat trim inserts
- Jet black fabric side bolsters

SE model illustrated.

SRi/SRi Nav Premium



Steering wheel:

- Three-spoke design
- Flat bottomed leather-covered steering wheel. Heated for SRi Nav Premium
- Satin chrome-effect bezel

Facia and door trim:

- Black facia with red trim inserts
- Instrument panel bar Light Gravel
- Atlantis black trim inserts on front doors
- Chrome-effect interior door handles

Seating:

- Driver's and front passenger's seat (six-way adjustable):
 - Height
 - Reach
 - Backrest
- Heated front seats

Seat trim:

- Minstral and Jet black fabric leather-effect seat trim inserts
- Jet black fabric side bolsters

SRi model illustrated.

Interior Styling and Comfort

Elite Nav/Elite Nav Premium



Steering wheel:

- Three-spoke design
- Flat bottomed leather-covered steering wheel
- Satin chrome-effect bezel

Facia and door trim:

- Black facia with silver trim inserts
- Instrument panel bar Light Gravel
- Atlantis black trim inserts on front doors
- Chrome-effect interior door handles

Seating:

- Driver's and front passenger's seat (six-way adjustable):
 - Height
 - Reach
 - Backrest
- Heated front seats

Seat trim:

- Jet black fabric leather-effect seat trim inserts
- Jet black fabric side bolsters

Elite Nav Premium model illustrated.

Ultimate Nav



Steering wheel:

- Three-spoke design
- Heated flat bottomed leather-covered steering wheel
- Satin chrome-effect bezel

Facia and door trim:

- Black facia with silver trim inserts
- Instrument panel bar Light Gravel
- Atlantis black trim inserts on front doors
- Chrome-effect interior door handles

Seating:

- Driver's and front passenger's seat (six-way adjustable):
 - Height
 - Reach
 - Backrest
- Heated front seats

Seat trim:

- Alcantara seat trim inserts
- Jet black premium leather-effect side bolsters

Interior Styling and Comfort

Launch Edition/Ultimate Edition



Steering wheel:

- Three-spoke design
- Heated flat bottomed leather-covered steering wheel
- Satin chrome-effect bezel

Facia and door trim:

- Black facia with silver trim inserts
- Instrument panel bar Polar Silver
- Atlantis black trim inserts on front doors
- Chrome-effect interior door handles

Seating:

- Driver's and front passenger's seat (six-way adjustable):
 - Height
 - Reach
 - Backrest
- Heated front seats
- Driver's massage function

Seat trim:

- Black Sienna perforated leather seat trim inserts

Effective 21 May 2021

All-new Mokka Model Year 2021D

Exterior Colours

Quartz Grey (G4i)*
Two-coat metallic paint



VX_MOK_31268

White Jade (G2o)**
Brilliant paint £320



VX_MOK_31264

Voltaic Blue (G6l)†
Two-coat metallic paint £550



VX_MOK_31265

Diamond Black (G7o)**
Two-coat metallic paint £550



VX_MOK_31267

Mamba Green (GGl)†
Premium metallic paint £650



VX_MOK_31269

Power Red (GD6)**
Premium metallic paint £650



VX_MOK_31266

The colours reproduced may vary slightly from the actual paint colour. As a result they should be used as a guide only. Your Vauxhall Retailer has a comprehensive display of our paint samples.

*Standard exterior paint for Mokka. **Optional at extra cost including VAT. †Optional at extra cost including VAT. Not available on SRi models.

Roof, Bonnet and Window Moulding Colours

	SE	SRi	SRi Nav Premium	Elite Nav	Elite Nav Premium	Ultimate Nav	Launch Edition	Electric models			
								SE Nav Premium	SRi Nav Premium	Elite Nav Premium	Ultimate Edition
Roof Colours											
Body-coloured roof	●	No-cost	No-cost	No-cost	No-cost	No-cost	No-cost	●	No-cost	No-cost	No-cost
Black roof		●	●	●	●	●	●		●	●	●
White roof*		£300	£300	£300	£300	£300	£300		£300	£300	£300
Red roof**		£300							£300		
Bonnet Colours											
Black bonnet									£200	£200	£200
Window Moulding Colours											
Chrome-effect window moulding	●			●	●	●	●	●		●	●
Red upper window moulding†		●	●						●		
Black upper window moulding††		No-cost	No-cost					No-cost	No-cost		



VX_MOK_31270

Black roof (22T)



VX_MOK_31271

White roof (03T)*



VX_MOK_31272

Red roof (34V)**







VX_MOK_31273

Black bonnet (CNP)

*Optional at extra cost including VAT. Not available with White Jade/Voltaic Blue/Mamba Green. On SRi – only available from May 2021. **Optional at extra cost including VAT. Not available with Power Red/Voltaic Blue/Mamba Green body colours. On SRi – only available from May 2021. †Not available with Mamba Green/Power Red/Voltaic Blue body colours/white roof/red roof. ††Standard with Power Red body colour. Not available until May 2021.

Wheels and Tyres

								Electric models				
		SE	SRI	SRI Nav Premium	Elite Nav	Elite Nav Premium	Ultimate Nav	Launch Edition	SE Nav Premium	SRI Nav Premium	Elite Nav Premium	Ultimate Edition
	16-inch silver alloy wheels • 215/65 R 16 Tyres • Emergency tyre inflation kit (in lieu of spare wheel)	●							●			
	18-inch bi-colour alloy wheels with red accents • 215/55 R 18 tyres • Emergency tyre inflation kit (in lieu of spare wheel)		●	●						●		
	17-inch bi-colour alloy wheels • 215/60 R 17 tyres • Emergency tyre inflation kit (in lieu of spare wheel)				●	●					●	
	18-inch bi-colour alloy wheels • 215/55 R 18 tyres • Emergency tyre inflation kit (in lieu of spare wheel)						●	●				●
Provision for spare wheel fitment (spare wheel is Retailer-fit)		£20*	£20*	£20*	£20*	£20*	£20*	£20*				

*Optional at extra cost including VAT.

Petrol Engines

	1.2 (100PS) Turbo	1.2 (130PS) Turbo with 6-speed manual	1.2 (130PS) Turbo with 8-speed automatic
Capacity	1199cc	1199cc	1199cc
Maximum power	100PS (75kW) @ 5500rpm	130PS (96kW) @ 5500rpm	130PS (96kW) @ 5500rpm
Maximum torque	205Nm (151 lb.ft.) @1750rpm	230Nm (169 lb.ft.) @1750rpm	230Nm (169 lb.ft.) @1750rpm
Configuration	3 cylinders, 4 valves per cylinder, double overhead camshafts	3 cylinders, 4 valves per cylinder, double overhead camshafts	3 cylinders, 4 valves per cylinder, double overhead camshafts
Fuel/induction system	Turbocharger with intercooler. Multi-point sequential fuel injection	Turbocharger with intercooler. Multi-point sequential fuel injection	Turbocharger with intercooler. Multi-point sequential fuel injection
Emission compliance	Euro 6d	Euro 6d	Euro 6d
Service interval	12,500 miles or 1 year (whichever occurs sooner)*	12,500 miles or 1 year (whichever occurs sooner)*	12,500 miles or 1 year (whichever occurs sooner)*

Diesel Engine

	1.5 (110PS) Turbo D
Capacity	1499cc
Maximum power	110PS (81kW) @ 3500rpm
Maximum torque	250Nm (184lb.ft.) @ 1750rpm
Configuration	4 cylinders, 4 valves per cylinder, double overhead camshafts
Fuel/induction system	Turbocharger with intercooler. Variable Valve Timing (VVT). Spark ignited direct injection (SIDI)
Emission compliance	Euro 6d
Service interval	20,000 miles or 1 year (whichever occurs sooner)*

Performance, Fuel Economy and Emissions**

	Performance (manufacturer's figures)		Fuel economy mpg (litres/100km)#		CO ₂ emissions g/km#		Vehicle Excise Duty*		BiK rates from - 2021/22 tax year
	Maximum speed (mph)	Acceleration 0-60mph (sec)	Combined Low	Combined High	Combined Low	Combined High	First year rate	Standard rate	
1.2 (100PS) Turbo	116	10.6	49.6 (5.7)	51.4 (5.5)	124	128	£180	£155	29%
1.2 (130PS) Turbo	125	9.1	50.4 (5.6)	51.4 (5.5)	123	126	£180	£155	29%
1.2 (130PS) Turbo automatic	124	9.2	47.1 (6.0)	47.9 (5.9)	133	137	£220	£155	31%
1.5 (110PS) Turbo D	118	10.8	62.8 (4.5)	65.7 (4.3)	114	117	£180	£155	26%

Weights and Towing Data_{kg}**

	Gross vehicle weight	Maximum towing weights Trailer with brakes (without brakes)
1.2 (100PS) Turbo	1700	1200 (620)
1.2 (130PS) Turbo	1715	1200 (620)
1.2 (130PS) Turbo automatic	1740	1200 (640)
1.5 (110PS) Turbo D	1750	1200 (640)

#Figures shown are for comparison purposes and should only be compared to the fuel consumption and CO₂ values of other cars tested to the same technical standard. The fuel consumption achieved, and CO₂ produced, in real world conditions will depend upon a number of factors including, but not limited to: the accessories fitted (pre and post registration); variations in weather; driving styles and vehicle load. The WLTP (Worldwide Harmonised Light Vehicles Test Procedure) is used to measure fuel consumption and CO₂ figures. The CO₂ figures display a range to reflect the highest value for the highest emitting version with all available options added, through to a minimum value to represent the lowest emitting version in standard specification.

*Correct at time of publication. **Provisional data.

Please note: Gross vehicle weight is the total permissible weight of the vehicle including passengers and their luggage. The **maximum roof rack loading** should not exceed 70kg. The **maximum towing weights** are based on the ability of the car, with two occupants of 75kg each, to restart on a 12% gradient, which is approximately 1 in 8.3, at sea level. The permitted trailer load applies up to the specified incline and up to an altitude of 1000 metres above sea level. The permissible gross train weight decreases by 10% for every 1000 metres of additional altitude. At altitudes above 1500 metres, the engine output may drop with a corresponding reduction in towing capability. Any extra weight, such as luggage or additional passengers, should be deducted from the maximum towing weight. With a trailer fully loaded, **maximum nose weight** should not exceed 55kg. Always fit Vauxhall towing attachments and accessories available from your Vauxhall Retailer. They are designed specifically for Vauxhall models and carry a 12-month guarantee. During trailer towing do not exceed a maximum speed of 60mph. This speed limit is also applicable in countries with higher permitted speeds for trailer-vehicle combinations. Pay attention to the local speed limits. For trailers with low driving stability and caravans the use of an oscillation damper is strongly recommended.

Specifications

Transmission

- Front-wheel drive
- Six-speed manual gearbox
 - Available on 1.2 (100PS) Turbo/1.2 (130PS) Turbo/1.5 (110PS) Turbo D models.
- Eight-speed automatic transmission
 - Available on 1.2 (130PS) Turbo models.

Steering

- Single pinion electrical power steering

Brakes

- Anti-lock Braking System (ABS)
- Electronic brakeforce distribution
- Emergency brake assist
- Cornering brake control
- Straight line stability control

Petrol/diesel engines

Front ventilated discs: 283mm diameter

Rear drums: 249mm diameter

Electric engine

Front ventilated discs: 302mm diameter

Rear discs: 268mm diameter

Fuel tank capacity

– 1.2 (100PS) Turbo/1.2 (130PS) Turbo 44 litres (9.7 gallons)

– 1.5 (110PS) Turbo D 41 litres (9.0 gallons)

AdBlue® Tank Capacity

– 15 litres (3.3 gallons)

Start/Stop technology

New Mokka's Start/Stop system offers real benefits by improving fuel economy and reducing CO₂ emissions, particularly in town. It does this by automatically stopping the engine when you come to a standstill, and then restarting as you prepare to move off.

Before automatically stopping the engine a number of system checks are carried out to ensure that it is both safe and practical to do so. To ensure safety, the driver must depress the clutch pedal, shift in to neutral, and then release the clutch pedal.

System checks carried out before Auto Stop activates include:

- Start/Stop system is not manually deactivated via the facia button
- Sufficient brake vacuum is available to prevent the car rolling down an incline
- Battery is in good condition and charged
- Outside air temperature and engine temperature are above specified minima
- Electronic climate control (where fitted) is not in maximum heating or maximum cooling mode
- Self-cleaning function of the diesel particulate filter is not active

If all of these conditions are satisfied then the vehicle will Auto Stop.

When you are ready to pull away from standstill, Auto Restart is activated by depressing the clutch pedal.

Whilst at a standstill the vehicle is continually monitored.

If necessary, the engine will automatically be restarted.

Conditions that would initiate an Auto Restart include:

- Low battery level
- Brake vacuum below specified minimum
- Start/Stop system is manually deactivated
- Stationary for 5.5 minutes

All-new Mokka-e Specifications

Single-speed electronic drive selector

As the motor is an all-electric single-speed drive unit, there is no need for multiple gears. Instead, the shifter lets the driver select from the following:

- Park
- Reverse
- Neutral
- Drive
- Braking (for increased regenerative braking)

Drive Mode Selector

The driver can determine the driving style through selecting one of the following modes:

- **Sport:** for a dynamic drive with a responsive throttle and the highest top speed and torque
- **Normal:** for a balanced drive that offers a compromise between performance and energy efficiency
- **ECO:** for maximum range and energy efficiency. The ECO mode deactivates all unnecessary energy-consuming features and reduces the top speed, torque and overall performance.

Drivetrain	Mokka-e
CO ₂ emissions	0g/km
Maximum power kW/PS	100/136
Maximum torque Nm/lb. ft.	260/192
Acceleration 0-60mph (sec)	8.7
Maximum speed mph	93
Transmission	Automatic electric drive with fixed gear ratio
Service interval	Initial inspection at 8,000 miles/1 year (whichever comes sooner). Thereafter 16,000 miles/2 years (whichever comes sooner)*
Electric range	201 miles (WLTP preliminary)

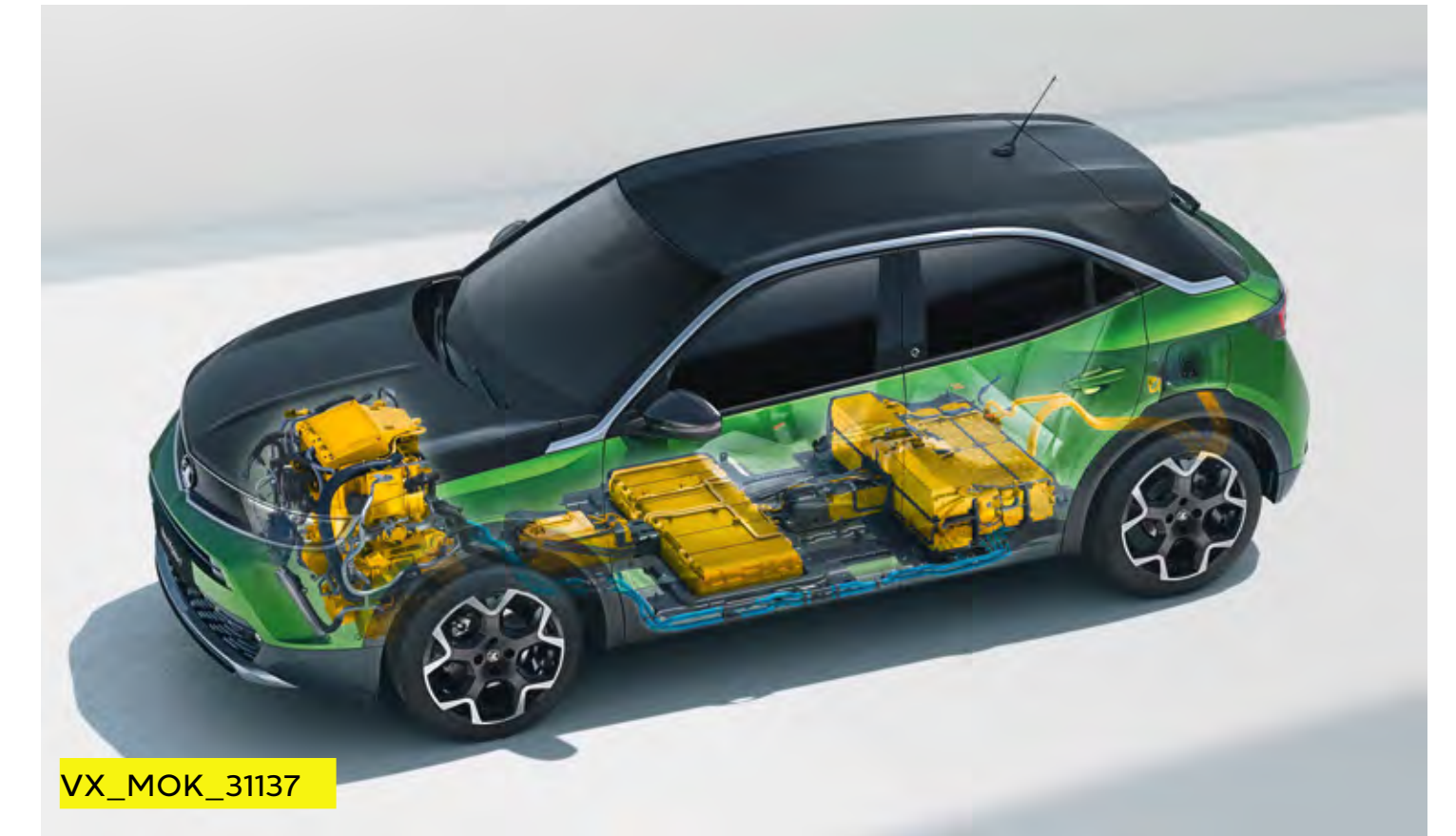

VX_MOK_31137

The Mokka-e is a battery electric vehicle requiring mains electricity for charging. Range data given has been determined according to WLTP test procedure methodology. The figures shown are intended for comparability purposes only and should only be compared to other cars tested to the same technical standard. The range you achieve under real world driving conditions will depend upon a number of factors, including but not limited to: the accessories fitted (pre and post registration); charging frequency; personal driving style; vehicle load and route characteristics; variations in weather; heating/air conditioning; pre-conditioning and battery condition. For more information, contact your local Vauxhall Retailer.

*Provisional figures to be confirmed.

All-new Mokka-e Specifications*

Charging

New Mokka-e comes fitted with an 11kW on-board charger and mode 3 cable.

The charging flap's Padlock LED lights up when the cable is correctly plugged in and locked and then acts as a user interface to show the charging status via coloured LED lights:

- **White:** welcome light that helps to light up the area, especially useful in dark conditions
- **Flashing green:** charging in progress
- **Solid green:** charging complete
- **Solid blue:** delayed charging toggled; changes to flashing green when charging commences
- **Solid red:** malfunction

The driver may also choose from two settings:

- **Immediate charging (the standard setting):** Starts charging as soon as the vehicle is docked for charging
- **Delayed charging:** This is especially useful for when cheaper electric rates are desired, e.g. charging at night. Simply enter a charging start time.

Please note, EV range assumes that vehicle has been pre-conditioned prior to journey. This function can be accessed either via MyVauxhall App (standard with all Mokka-e) or by using the Multimedia Navi Pro infotainment system (standard on SRi Nav Premium, Elite Nav Premium and Ultimate Edition).

Battery	11kW on-board charger
Battery energy kWh	50
EV range (WLTP high)	201 miles
Battery consumption (Combined low/high)	17.4-17.8kWh/100km
Battery warranty	8 years/100,000 miles/70% capacity
Time to charge	
Domestic Wallbox - Accelerated charger 7kW	7 h 35 min (0-100% battery capacity)
Public Charging - Accelerated charger 22kW	5hr 05 min (0-100%)
Rapid Charger 50kW**	45 min (15-80%)†
Rapid Charger 100kW**	30 min (15-80%)†



VX_MOK_31319

The Mokka-e is a battery electric vehicle requiring mains electricity for charging. Range data given has been determined according to WLTP test procedure methodology. The figures shown are intended for comparability purposes only and should only be compared to other cars tested to the same technical standard. The range you achieve under real world driving conditions will depend upon a number of factors, including but not limited to: the accessories fitted (pre and post registration); charging frequency; personal driving style; vehicle load and route characteristics; variations in weather; heating/air conditioning; pre-conditioning and battery condition. For more information, contact your local Vauxhall Retailer.

*Provisional data. **You can obtain 15-80% of the vehicle charge in 30 minutes from a 100kW rapid charging station. You can obtain 15-80% of the vehicle charge in 45 minutes from a 50kW rapid charging station. Rapid charging stations are widely available across the UK at various locations and their power rating varies, typically from 50kW and sometimes up to 350kW. †The charging time may vary according to the type and power of the charging station, the outside temperature at the charging point and the battery temperature.

Effective 21 May 2021

All-new Mokka Model Year 2021D

Dimensions and Capacities

All measurements in mm (inches) unless stated otherwise.



Loadspace Dimensions	Mokka	Mokka-e
Maximum length behind rear seats	667 (26.3)	667 (26.3)
Maximum length rear seats folded	1418 (55.8)	1418 (55.8)
Maximum width	1021 (40.2)	1021 (40.2)
Maximum height	780 (30.7)	780 (30.7)

Luggage Capacities Litres (cu.ft.)	Mokka	Mokka-e
Rear seats up (under luggage compartment cover)	350 (12.37)	310 (10.9)
Rear seats folded (to roof)	1105 (39.0)	1060 (37.4)

Accessories

Safety	Total (inc. VAT)
Spare wheel kit with 16-inch emergency wheel and tool kit (petrol and diesel models only) ¹	£167
Philips ADR620 dash cam	£109
Front parking sensors	£382
Rear parking sensors	£399
Child seats ²	
- Age group 0 (approx. 24 months/ up to 13kg)	£182
- ISOFIX base for age group 0 ³	£230
- Age group 1 (approx. 1-3.5 years/9-18kg)	£510
- Age group 2/3 (approx. 3-12 years/ 15-36kg)	£186
Safety Pack – first aid kit, hi-vis vest and small warning triangle	£16
Warning triangle	£9
Hi-vis safety vest – adult	£4
Hi-vis safety vest – child 3-6 years (42cm)	£4
Hi-vis safety vest – child 7-12 years (52cm)	£4
First aid kit	£15
Emergency seat belt cutter and hammer	£18
Fire extinguisher (1kg) with strap	£32
Under seat bracket for fire extinguisher	£47
Side steps ⁴	£tba

Protection	Total (inc. VAT)
Floor mats (set of 4)	
- Carpet	£42
- Rubber	£52
- Velour	£72
Rear seat cover	£39
Boot area cover	£53
Reversible boot tray	£79
Rear bumper protection	£97
Splash guards (front) ⁴	£49
Splash guards (rear) ⁴	£49
Comfort	
FlexConnect bracket	£20
FlexConnect hook	£27
FlexConnect coat hanger	£40
FlexConnect folding table	£65
FlexConnect iPad mini holder	£93
FlexConnect iPad holder	£103
FlexConnect iPad Air holder	£103
FlexConnect Samsung Galaxy holder	£93
Rear cup holder	£54
Cup holder organisers	
- Notepad insert	£8
- Pen and holder	£10
- Small items	£18
Smoker's pack	£52
Wireless phone charger	£233

Style	Total (inc. VAT)
Stainless steel door sill covers (front)	£41
Sport pedal covers – Auto	£43
Sport pedal covers – Manual	£62
Exterior door mirror covers	
- various colours	£108 – £111
Rear-view mirror cover	
- various colours ⁵	£58 – £62
Decal kit with roof and bonnet racing stripes	
- Black or White	£204
Decal kit with side stripes	
- Black or White	£189
18-inch diamond-cut bi-colour alloy wheels	
- set of 4	£1,462
Alloy wheel inserts ⁶ – various colours	
- Set of 4	£32 – £38
- Each	£20
Alloy wheel centre caps ⁶ – various colours	£23
Chrome valve caps	£9

Transport solutions	Total (inc. VAT)
Towing	
Tow bar with removable tow ball ⁷	£552
Tow bar wiring loom (13 track) ⁷	£219
Towing harness socket adaptor (13- to 7-pin)	£29
Electric	
Mode 2 emergency charging cable (Type G)	£584
Mode 3 charging cable	
- 7.4kW	£331
- 11kW	£371
- 22kW	£438
Cable bag	£49
Mode 2 Universal Charger UK kit (22kW)	£1,555
Accessories for Universal Charger	
- Wall bracket	£105
- Bag	£65
- Safety lock	£20
- Adapter Type 2	£318
- Adapter Type 3c	£358
- Adapter (various)	£120

Please note: Prices shown are fully fitted and painted, where applicable and include VAT. Please check with your local Vauxhall Retailer for details. It is advisable to ensure your insurance policy is adequate to cover additional fitted accessories. Prices correct at time of publication.

¹Vehicle must be ordered with spare wheel fixing option (T7Y) in order to accommodate the spare wheel. ²Restrictions apply to the use of child seats, please consult your vehicle user manual or Vauxhall Retailer. ³Restricted to rear seat usage only for vehicles with transponder deactivation of passenger airbag. ⁴Side steps and splash guards are not available together. ⁵Only available with anti-dazzle rear-view mirror. ⁶Only for use with 18-inch diamond-cut alloy wheels. ⁷Available on petrol and diesel models only.

Company Car Driver and Fleet Information

Benefit in kind company car taxation*

The car benefit charge will be the car's list price (including VAT, options and accessories fitted, delivery to Retailer and number plates, but excluding Vehicle Excise Duty and new vehicle first registration fee) multiplied by the percentage charge for the CO₂ emissions band in which the car falls (see table opposite). Multiply this figure by your personal income tax rate (20%** for Basic Rate, 40%** for Higher Rate) to calculate your annual benefit in kind tax liability.

Example:

Mokka SE 1.5 (110PS) Turbo D Start/Stop (CO₂ emissions 114g/km)

On-the-road RRP	£22,540.00
Deduct: Vehicle Excise Duty	(£180.00)
New vehicle first registration fee	(£55.00)
Effective list price	£22,305.00
Add: Optional two-coat metallic paint	£550.00
List price for tax purposes (P11D value)	£22,855.00
Car benefit charge 2021-22 tax year (26%)	£5,943.00
Benefit in kind tax liability (2021-22 tax year)	
Basic Rate (20%) tax payer	£1,188.60
Higher Rate (40%) tax payer	£2,377.20

*Please note this Price Guide provides taxation information as a guide only. Vauxhall does not provide taxation guidance. Drivers should always take professional advice on their own tax position.

**Excludes residents of Scotland.

BiK for Scottish Residents

Effective 6 April 2018 the Scottish Government have introduced their own BiK taxation structure. This only applies to Company Car Drivers that are Scottish taxpayers. HMRC will determine whether or not an individual is a Scottish taxpayer based on where their main place of residence is.

The BiK rates for Scotland are:

- Over £12,570-£14,667 Starter Rate 19%
- Over £14,667-£25,296 Basic Rate 20%
- Over £25,296-£43,662 Intermediate Rate 21%
- Over £43,662-£150,000 Higher Rate 41%
- Above £150,000 Top Rate 46%

CO ₂ emissions (g/km)	Percentage of cars price to be taxed 2021-22 tax year
Up to 50	13%
51-54	14%
55-59	15%
60-64	16%
65-69	17%
70-74	18%
75-79	19%
80-84	20%
85-89	21%
90-94	22%
95-99	23%
100-104	24%
105-109	25%
110-114	26%
115-119	27%
120-124	28%
125-129	29%
130-134	30%
135-139	31%
140-144	32%
145-149	33%
150-154	34%
155-159	35%
160-164	36%
165-169	37%
170+	37%

CO ₂ emissions (g/km)	Electric range (miles)	Percentage of cars price to be taxed 2021-22 tax year
0	-	1%
1-50	130+	1%
1-50	70-129	4%
1-50	40-69	7%
1-50	30-39	11%
1-50	<30	13%

To calculate your own personal liability, search: **Vauxhall BiK**, or click the link below: [Vauxhall BiK Tool](#)

Fleet Toolbox

Discover the facts in our online Toolbox for both Company Car Drivers and Fleet Decision Makers. The Fleet Toolbox has a host of useful calculators, comparators, interactive listings and information. Search Vauxhall Fleet Tools or click the link below: [Vauxhall Fleet Tool Box](#)

Contact Vauxhall Fleet

Please contact one of our dedicated sales teams who will be happy to help with your particular enquiry.

Company Car Drivers

Call: 0345 111 2020

Email: company-car@vauxhallinfo.co.uk

Telephone lines are open

- Monday to Friday 8:00am-9:00pm
- Saturday and Sunday 9:00am-6:00pm

Fleet Decision Makers

Depending on the size of your fleet of vehicles, we have a dedicated team to handle your enquiries. The lines are open Monday to Friday excluding Bank Holidays.

1-24 vehicles

Call: 0845 076 2254 (8:30am-5:00pm)

25+ vehicles

Call: 0330 587 8222 (8:30am-5:00pm)

Email: vauxhallfleet@vauxhall.co.uk

Special Vehicles (Police, Fire and Ambulance)

Call: 01582 409999 (8:30am-5:00pm)

Email: vauxhallspecialvehicles@vauxhall.co.uk

Further Information

On-the-road prices

To eliminate uncertainty about hidden costs when buying a new car, Vauxhall publishes on-the-road recommended retail prices (RRP) and these are shown in the pricing tables within this price guide. These prices include VAT, number plates and delivery to Retailer of £700.00 (including £116.67 VAT), 12 months' Government Vehicle Excise Duty (see opposite for details) and the DVLA new vehicle first registration fee of £55.00.*

Please note: The on-the-road recommended retail price (RRP) does not include fuel supplied by the Retailer, motor insurance or any other goods or services supplied by agreement between the Retailer and the customer.

Price protection

Order a new Vauxhall for build in the current model year (as confirmed by your Retailer) for delivery no more than three months in advance and the price you are quoted is the price you pay. This is irrespective of any subsequent price rises between placing your order and delivery of your new car, but you must take delivery as soon as the car is available.

Please note: Price protection does not apply to Mokka-e/Corsa-e/Grandland X hybrid models. Vauxhall Motors Limited is not liable for price adjustments caused by Government changes in the rate of VAT (currently 20%), Vehicle Excise Duty, DVLA new vehicle first registration fee or by any other applicable legislation or regulations.

In the event of an accident

Vauxhall Accident Management helps keep you mobile following an accident. Benefits include vehicle recovery, Vauxhall-approved repairs and contacting your insurer. For more details, visit vauxhall.co.uk/AccidentManagement

Free2Move Lease

Whether you're a big company or a small business looking for vehicle financing, Free2Move Lease, our business finance specialists, can deliver exactly what you need.

Free2Move Lease is one of the UK's largest leasing companies and is also a member of the British Vehicle Rental and Leasing Association (BVRLA).

With over 60,000 vehicles in the Free2Move Lease portfolio, Free2Move Lease is able to offer competitive vehicle solutions. In addition, Free2Move Lease also offer innovative connected management of servicing and maintenance.

For further information, please contact your local Vauxhall Retailer or visit vauxhall.co.uk/offers-finance/business-leasing.html

Vehicle Excise Duty

The amount of Vehicle Excise Duty (road fund licence) payable on new cars varies depending on the level of carbon dioxide (CO₂) emissions produced by the vehicle. CO₂ emissions are measured in grams per kilometre (g/km) travelled and divided into 13 charging bands shown in the table opposite.

A 'first year rate' of Vehicle Excise Duty is payable on all new cars and in subsequent years the amount payable reverts to the 'standard rate'. From 1 April 2017 the breakpoints for each of these bands have been revised. Also, for vehicles with a list price over £40,000, including factory-fitted options, an additional £335 is payable for the first five years of standard rate payments.

Vehicle Excise Duty*

Band	CO ₂ emissions in grams per kilometre	First year rate Petrol/Diesel	Standard rate Petrol/Diesel	Standard rate Electric
A	0	£0	£0	£0
B	1-50	£10	£155	£0
C	51-75	£25	£155	£0
D	76-90	£115	£155	£0
E	91-100	£140	£155	£0
F	101-110	£160	£155	£0
G	111-130	£180	£155	£0
H	131-150	£220	£155	£0
I	151-170	£555	£155	£0
J	171-190	£895	£155	£0
K	191-225	£1,345	£155	£0
L	226-255	£1,910	£155	£0
M	Over 255	£2,245	£155	£0

*Correct at time of issue.

Further Information

Customer Care Commitment

For added peace of mind, Vauxhall has an innovative Customer Care Commitment that offers the following:

- Three-year vehicle warranty consisting of a one-year/unlimited mileage manufacturer's warranty and a second and third year manufacturer's warranty with a 60,000 miles limitation
- Vauxhall Assistance for 12 months from first registration
- Six years' body panel anti-perforation warranty

Please note: Warranty is only available on vehicles sourced from Vauxhall Motors Limited. Terms and conditions apply – please see your Vauxhall Retailer for details.

Vauxhall Assistance

Vauxhall Assistance is provided automatically with every new Vauxhall for 12 months from first registration and covers everything from accident assistance, roadside recovery and 'at home' service to flat tyres. For even more peace of mind, on Mokka-e models the cover is extended* to 8 years or 100,000 miles, whichever comes first. Even more reason for you to stay calm and let us take care of everything should the need arise. With Vauxhall Assistance help is literally just a free** phone call away, 24 hours a day, 365 days a year!

Protecting the environment

Vauxhall's commitment to the environment is demonstrated by our products' many environmental awards. For even more information on Vauxhall's efforts to achieve an environmentally sustainable future, and how to dispose of your end-of-life vehicle, see vauxhall.co.uk/recycling

Vauxhall Care

This all-inclusive service package is available on Vauxhalls under 10 months old (from date of first registration).

This package offers complete peace of mind for the first 3 years of your Vauxhall's life with fixed monthly payments for the plan duration.

- **3 years' Vauxhall servicing** – covers first, second and third annual services. Including a brake-fluid change in the second service
- **2 years' Vauxhall Roadside Assistance** – first year from us
- **First years' MOT[†]** – free of charge by your local Vauxhall Retailer

For full terms and conditions and to sign up, visit: vauxhall.co.uk/vauxhallcare

Vauxhall Service Club

Vauxhall Service Club is available for all Vauxhall owners, and it's free to join. Members benefit from the following:

- 15% off Vauxhall Approved Accessories
- Vauxhall's aged 2-3 Years = 15% off parts and labour
- Vauxhall's aged over 3 Years = 25% off parts and labour
- Half price MOT's (NI excluded)
- Free pre-MOT test inspection (NI only)
- Fixed price AdBlue[®] Refills
 - Car = £14.99
 - Van = £24.99
- Access to the Vauxhall Accident Management Programme
- Online service booking available 24/7 with servicing appointments available within 3 days – [Book Online](#)
- Collection and delivery/onward mobility options
- Complimentary 'Wash and Vac' with all routine services^{††}
- Vauxhall trained technicians
- Genuine Vauxhall parts
- Minimum 12 months warranty on parts and labour
- Regular newsletters with exclusive offers, discounts and competitions

Terms and conditions apply. To join visit: vauxhall.co.uk/serviceclub

Vauxhall Insurance with added reassurance

Comprehensive cover – Summary of benefits

- Competitive premiums
- Repairs by a Vauxhall-trained technician
- Genuine Vauxhall parts, guaranteed for five years when we repair your car within our Approved Repairer Network
- Free courtesy car as standard when using an Approved Repairer[‡]
- 24 hour claims helpline
- Personal Accident benefit
- Cover for audio equipment
- Windscreen cover

Call for a quote on 0330 678 1130^{‡‡}

For more product information

For further information on the Vauxhall range or location of your nearest Vauxhall Retailer please call 0345 600 1500. Alternatively, details can be found on our website at vauxhall.co.uk

For more information call **0345 600 1500**

For Fleet enquiries call **0330 587 8222**

Discover the full Vauxhall range at **[vauxhall.co.uk](https://www.vauxhall.co.uk)**

Join us online

The invoice price, including delivery to Retailer, factory-fitted options, accessories fitted by the Retailer and number plates, is subject to VAT. Some feature descriptions in this guide may refer to, and some illustrations may show, optional equipment not included in the standard delivery. The information contained in this guide was accurate at the time of publication. We reserve the right to make changes in design and equipment. Please note that Vauxhall Retailers are not the agents of Vauxhall Motors Limited and are not authorised to bind Vauxhall Motors Limited by any specific or implied undertaking or representation. It is advisable to ensure that your motor insurance policy provides adequate cover for additional fitted options and accessories. The colours in this guide are only approximate actual colours. Illustrated optional equipment is available at extra charge. Availability, technical features and equipment provided on our vehicles can vary by model. For precise information on the equipment provided on our vehicles, please contact your local Vauxhall Retailer.

VAUXHALL

Price and Specification Guide
7 April 2021 | Model Year 2021D



New Crossland

Contents

To find the information you want use the links below to navigate around the guide:

[Choose your Trim Level](#)

[Range Highlights](#)

[Models](#)

[Prices](#)

[Features/Options](#)

[Infotainment](#)

[Interior Style and Comfort](#)

[Exterior Colours](#)

[Wheels and Tyres](#)

[Engines and Technical Data](#)

[Performance, Economy and Emissions](#)

[Specifications](#)

[Dimensions and Capacities](#)

[Accessories](#)

[Company Car Information](#)

[Further Information](#)

Choose Your Trim Level

SE

The range starts with a highly equipped SE.



SRi Nav

For the sporty choice opt for the SRi Nav with contrast colour roof, 17-inch bi-colour alloy wheels and much more.



Elite

Elite and Elite Nav models offer a premium look and feel with rear-view camera, heated front seats and steering wheel.



Ultimate Nav

Top of the range is the Ultimate Nav which builds on the features from the Elite models adding Alcantara seat trim, Silver roof rails and keyless entry and start.



New Crossland Range Highlights

SE

Standard features include:

- Multimedia infotainment system
 - 7-inch colour touchscreen
 - AM/FM/DAB digital radio
 - Bluetooth® audio streaming
 - Bluetooth® mobile phone portal
 - Apple CarPlay/Android Auto™
 - USB connection
- Six speakers
- Air conditioning
- Leather-covered steering wheel
- Cruise control with speed limiter
- Steering column adjustable for reach/rake
- Black upper window moulding
- 60/40 split-folding rear seat back
- Automatic lighting control
- Rain-sensitive windscreen wipers
- Automatic anti-dazzle rear-view mirror
- LED headlights
- 16-inch diamond-cut bi-colour five twin-spoke alloy wheels
- Black-painted door mirrors
- Electrically operated front and rear windows
- Electrically adjustable/heated door mirrors
- Hill start assist
- Speed sign recognition
- Lane departure warning

SRI Nav

Features over SE models:

- Multimedia Navi Pro infotainment system
 - 8-inch colour touchscreen
 - Satellite navigation
 - 2 x USB connections
- 3.5-inch colour instrument display
- Dual-zone electronic climate control
- Rear parking distance sensors
- Centre rear seat head restraint
- Sliding 60/40 rear seat with centre rear seat armrest
- Load floor compartment FlexFloor with cargo under floor divider
- Front centre armrest with storage
- Storage pockets on front seat backs
- Ambient lighting
- Automatic high beam control
- Automatic headlight levelling system
- Ergonomic active front seats (AGR-approved*)
- 17-inch diamond-cut bi-colour five twin-spoke alloy wheels
- Contrast colour roof
- Dark-tinted rear side and tailgate windows
- Silver-effect roof rails
- Red or chrome upper window moulding depending on exterior colour
- LED front fog lights
- Remote control security alarm system
- 12v rear seat power outlet

Elite

Features over SE models:

- Dual-zone electronic climate control
- Ergonomic active driver's seat (AGR-approved*)
- Automatic high beam control
- Automatic headlight levelling system
- Heated front seats
- Heated steering wheel
- Storage pockets on front seat backs
- Ambient lighting
- 3.5-inch colour instrument display
- Front and rear parking distance sensors
- Rear-view camera
- 17-inch diamond-cut bi-colour five twin-spoke alloy wheels
- Contrast colour roof
- Dark-tinted rear side and tailgate windows
- LED front fog lights
- Remote control security alarm system
- Chrome-effect upper window moulding
- Driver's seat armrest

Ultimate Nav

Features over Elite models:

- Multimedia Navi Pro infotainment system
 - 8-inch colour touchscreen
 - Satellite navigation
 - 2 x USB connections
- Silver-effect side door mouldings
- Alcantara interior trim
- Keyless entry and start
- Silver-effect roof rails
- Panoramic rear-view camera
- Centre rear seat head restraint
- Sliding 60/40 rear seat with centre rear seat armrest
- Load floor compartment FlexFloor with cargo under floor divider
- Front centre armrest with storage
- 12v rear seat power outlet

New Crossland SE



VX_CRO_31440

SE

OTR from £19,355

Infotainment:

- Multimedia system
 - 7-inch colour touchscreen
 - AM/FM/DAB digital radio
 - Bluetooth® audio streaming
 - Bluetooth® mobile phone portal
 - Apple CarPlay/Android Auto™
 - USB connection
- Six speakers

Interior convenience/styling:

- Air conditioning
- Leather-covered steering wheel
- Cruise control with speed limiter
- Trip computer
- Steering column adjustable for reach/rake
- 60/40 split-folding rear seat back
- Automatic lighting control
- Rain-sensitive windscreen wipers
- Automatic anti-dazzle rear-view mirror

Exterior convenience/styling:

- LED headlights
- 16-inch diamond-cut bi-colour five twin-spoke alloy wheels
- Black-painted door mirrors
- Electrically operated front and rear windows
- Electrically adjustable/heated door mirrors
- Black upper window moulding

Safety/security:

- Lane departure warning
- Speed sign recognition
- Hill start assist

New Crossland SRi Nav



VX_CRO_31442

SRi Nav

OTR from £21,705

Infotainment:

- Multimedia Navi Pro system
 - Satellite navigation
 - 8-inch colour touchscreen
 - AM/FM/DAB digital radio
 - Bluetooth® audio streaming
 - Bluetooth® mobile phone portal
 - Apple CarPlay/Android Auto™
 - 2 x USB connections
- Six speakers

Interior convenience/styling:

- 3.5-inch colour instrument display
- Dual-zone electronic climate control
- Leather-covered steering wheel
- Cruise control with speed limiter
- Trip computer
- Steering column adjustable for reach/rake
- Automatic lighting control
- Rain-sensitive windscreen wipers
- Automatic anti-dazzle rear-view mirror
- Versatility Pack
 - Sliding 60/40 rear seat with centre rear seat armrest
 - Centre rear seat head restraint
 - Load floor compartment FlexFloor with cargo under floor divider
- Front centre armrest with storage
- Storage pockets on front seat backs
- Ambient lighting
- Ergonomic active front seats (AGR-approved*)
- 12v rear seat power outlet

Exterior convenience/styling:

- LED headlights
- 17-inch diamond-cut bi-colour five twin-spoke alloy wheels
- Black-painted door mirrors
- Electrically operated front and rear windows
- Electrically adjustable/heated door mirrors
- Automatic high beam control
- Automatic headlight levelling system
- Contrast colour roof
- Dark-tinted rear side and tailgate windows
- Silver-effect roof rails
- Red or chrome upper window moulding depending on exterior colour
- LED front fog lights
- Rear parking distance sensors
- Alloy-effect skid plates

Safety/security:

- Lane departure warning
- Speed sign recognition
- Hill start assist
- Remote control security alarm system

New Crossland Elite



VX_CRO_31441

Elite

OTR from £21,855

Infotainment:

- Multimedia system
 - 7-inch colour touchscreen
 - AM/FM/DAB digital radio
 - Bluetooth® audio streaming
 - Bluetooth® mobile phone portal
 - Apple CarPlay/Android Auto™
 - USB connection
- Six speakers

Interior convenience/styling:

- 3.5-inch colour instrument display
- Dual-zone electronic climate control
- Cruise control with speed limiter
- Trip computer
- Steering column adjustable for reach/rake
- Automatic lighting control
- Rain-sensitive windscreen wipers
- Automatic anti-dazzle rear-view mirror
- Ergonomic active driver's seat (AGR-approved*)
- Winter Pack
 - Heated front seats
 - Heated leather-covered steering wheel
- Driver's seat armrest
- Storage pockets on front seat backs
- Ambient lighting

Exterior convenience/styling:

- LED headlights
- 17-inch diamond-cut bi-colour five twin-spoke alloy wheels
- Contrast colour roof
- Dark-tinted rear side and tailgate windows
- Black-painted door mirrors
- Electrically operated front and rear windows
- Electrically adjustable/heated door mirrors
- Automatic high beam control
- Automatic headlight levelling system
- Front and rear parking distance sensors
- Rear-view camera
- Chrome-effect upper window moulding
- LED front fog lights
- Alloy-effect skid plates

Safety/security:

- Lane departure warning
- Speed sign recognition
- Hill start assist
- Remote control security alarm system

Elite Nav

OTR from £22,405

Features over Elite

- Multimedia Navi Pro system
 - Satellite navigation
 - 8-inch colour touchscreen
 - 2 x USB connections
- Wireless mobile phone charger
- Panoramic rear-view camera

New Crossland Ultimate Nav



VX_CRO_31439

Ultimate Nav OTR from £25,790

Infotainment:

- Multimedia Navi Pro system
 - Satellite navigation
 - 8-inch colour touchscreen
 - AM/FM/DAB digital radio
 - Bluetooth® audio streaming
 - Bluetooth® mobile phone portal
 - Apple CarPlay/Android Auto™
 - 2 x USB connections
- Six speakers

Interior convenience/styling:

- 3.5-inch colour instrument display
- Dual-zone electronic climate control
- Cruise control with speed limiter
- Trip computer
- Steering column adjustable for reach/rake
- Automatic lighting control
- Rain-sensitive windscreen wipers
- Automatic anti-dazzle rear-view mirror
- Ergonomic active front seats (AGR-approved*)
- Versatility Pack
 - Sliding 60/40 rear seat with centre rear seat armrest
 - Centre rear seat head restraint
 - Load floor compartment FlexFloor with cargo under floor divider
- Winter Pack
 - Heated front seats
 - Heated leather-covered steering wheel

- Front centre armrest with storage
- Storage pockets on front seat backs
- Ambient lighting
- Alcantara interior seat trim
- 12v rear seat power outlet

Exterior convenience/styling:

- LED headlights
- 17-inch diamond-cut bi-colour five twin-spoke alloy wheels
- Contrast colour roof
- Dark-tinted rear side and tailgate windows
- Black-painted door mirrors
- Electrically operated front and rear windows
- Electrically adjustable/heated door mirrors
- Automatic high beam control
- Automatic headlight levelling system
- Front and rear parking distance sensors
- Panoramic rear-view camera
- LED front fog lights
- Silver-effect roof rails
- Silver-effect side door mouldings
- Chrome-effect upper window moulding
- Alloy-effect skid plates

Safety/security:

- Lane departure warning
- Speed sign recognition
- Hill start assist
- Remote control security alarm system
- Keyless entry and start

New Crossland Prices

	Pack Code	Fuel Type	Price (£)	VAT (£)	Total (£)	On-the-road RRP (£)	Financial Year 2021/22 BiK 20% (£)	WLTP Combined CO ₂ (g/km) [#] – pack code	Insurance groups
SE									
1.2 (83PS)	GD75 E1G1	Petrol	15,316.67	3,063.33	18,380.00	19,355.00	98.57	135	8E
1.2 (110PS) Turbo	GD75 EL61	Petrol	16,300.00	3,260.00	19,560.00	20,535.00	101.28	131	14E
1.2 (130PS) Turbo auto	GD75 EGF1	Petrol	18,133.33	3,626.67	21,760.00	22,735.00	116.03	137	19D
1.5 (110PS) Turbo D	GD75 HS61	Diesel	17,233.33	3,446.67	20,680.00	21,615.00	99.77	120	15E
1.5 (120PS) Turbo D auto	GD75 HCF1	Diesel	18,966.67	3,793.33	22,760.00	23,695.00	117.28	130	15E
SRI Nav									
1.2 (83PS)	GG75 E1G1	Petrol	17,275.00	3,455.00	20,730.00	21,705.00	110.72	137	10E
1.2 (110PS) Turbo	GG75 EL61	Petrol	18,258.33	3,651.67	21,910.00	22,885.00	113.03	134	16E
1.2 (130PS) Turbo	GG75 EK61	Petrol	18,925.00	3,785.00	22,710.00	23,685.00	117.03	132	19E
1.2 (130PS) Turbo auto	GG75 EGF1	Petrol	20,091.67	4,018.33	24,110.00	25,085.00	128.18	139	18E
1.5 (110PS) Turbo D	GG75 HS61	Diesel	19,191.67	3,838.33	23,030.00	23,965.00	110.73	123	17E
1.5 (120PS) Turbo D auto	GG75 HCF1	Diesel	20,925.00	4,185.00	25,110.00	26,085.00	129.03	133	16E
Elite									
1.2 (83PS)	GH75 E1G1	Petrol	17,400.00	3,480.00	20,880.00	21,855.00	111.48	136	10E
1.2 (110PS) Turbo	GH75 EL61	Petrol	18,383.33	3,676.67	22,060.00	23,035.00	113.78	133	16E
1.2 (130PS) Turbo	GH75 EK61	Petrol	19,050.00	3,810.00	22,860.00	23,835.00	117.78	131	19E
1.2 (130PS) Turbo auto	GH75 EGF1	Petrol	20,216.67	4,043.33	24,260.00	25,235.00	128.95	138	18E
1.5 (110PS) Turbo D	GH75 HS61	Diesel	19,316.67	3,863.33	23,180.00	24,115.00	111.43	122	17E
1.5 (120PS) Turbo D auto	GH75 HCF1	Diesel	21,050.00	4,210.00	25,260.00	26,235.00	129.78	132	16E

Crossland's petrol and diesel engines meet the Real Driving Emissions Step 2 (RDE2) standards.

[#]Fuel consumption and CO₂ figures are determined according to the WLTP test cycle. CO₂ figures, BiK values and RRP pricing shown above are for a standard vehicle without any additional optional equipment. CO₂ figures are used to calculate Vehicle Excise Duty (VED) for the first registration of the vehicle and BiK. The addition of optional extras could increase the certified CO₂ emission output. This in turn may affect the amount of VED payable upon registration, and, for company car drivers, the P11D value and the amount of Benefit in Kind (BiK) tax payable. Figures shown are for comparison purposes and should only be compared to the fuel consumption and CO₂ values of other cars tested to the same technical standard. The fuel consumption achieved, and CO₂ produced, in real world conditions will depend upon a number of factors including, but not limited to: the accessories fitted (pre and post registration); variations in weather; driving styles and vehicle load. The WLTP (Worldwide Harmonised Light Vehicles Test Procedure) is used to measure fuel consumption and CO₂ figures. Full data relating to WLTP test cycles can be found at: www.vauxhall.co.uk/wltp

Please note: On-the-road recommended retail prices (RRP) include number plates and delivery to Retailer of £700.00 (inc. £116.67 VAT), 12 months' Vehicle Excise Duty and new vehicle first registration fee of £55.00. Excludes fuel and insurance. Company Car Benefit in Kind (BiK) rates are monthly based on the standard paint price. On-the-road prices feature a VED based on preliminary CO₂ information.

New Crossland Prices

	Pack Code	Fuel Type	Price (£)	VAT (£)	Total (£)	On-the-road RRP (£)	Financial Year 2021/22 BiK 20% (£)	WLTP Combined CO ₂ (g/km) [#] – pack code	Insurance groups
Elite Nav									
1.2 (83PS)	Gi75 E1G1	Petrol	17,858.33	3,571.67	21,430.00	22,405.00	114.33	136	10E
1.2 (110PS) Turbo	Gi75 EL61	Petrol	18,841.67	3,768.33	22,610.00	23,585.00	116.53	133	16E
1.2 (130PS) Turbo	Gi75 EK61	Petrol	19,508.33	3,901.67	23,410.00	24,385.00	120.53	131	19E
1.2 (130PS) Turbo auto	Gi75 EGF1	Petrol	20,675.00	4,135.00	24,810.00	25,785.00	131.80	138	18E
1.5 (110PS) Turbo D	Gi75 HS61	Diesel	19,775.00	3,955.00	23,730.00	24,665.00	114.00	122	17E
1.5 (120PS) Turbo D auto	Gi75 HCF1	Diesel	21,508.33	4,301.67	25,810.00	26,785.00	132.53	132	16E
Ultimate Nav									
1.2 (130PS) Turbo	GU75 EK61	Petrol	20,820.83	4,164.17	24,985.00	25,960.00	128.42	132	19E
1.2 (130PS) Turbo auto	GU75 EGF1	Petrol	21,987.50	4,397.50	26,385.00	27,360.00	139.93	139	19E
1.5 (110PS) Turbo D	GU75 HS61	Diesel	20,712.50	4,142.50	24,855.00	25,790.00	119.25	123	17E
1.5 (120PS) Turbo D auto	GU75 HCF1	Diesel	22,333.33	4,466.67	26,800.00	27,775.00	137.48	133	17E

Crossland's petrol and diesel engines meet the Real Driving Emissions Step 2 (RDE2) standards.

[#]Fuel consumption and CO₂ figures are determined according to the WLTP test cycle. CO₂ figures, BiK values and RRP pricing shown above are for a standard vehicle without any additional optional equipment. CO₂ figures are used to calculate Vehicle Excise Duty (VED) for the first registration of the vehicle and BiK. The addition of optional extras could increase the certified CO₂ emission output. This in turn may affect the amount of VED payable upon registration, and, for company car drivers, the P11D value and the amount of Benefit in Kind (BiK) tax payable. Figures shown are for comparison purposes and should only be compared to the fuel consumption and CO₂ values of other cars tested to the same technical standard. The fuel consumption achieved, and CO₂ produced, in real world conditions will depend upon a number of factors including, but not limited to: the accessories fitted (pre and post registration); variations in weather; driving styles and vehicle load. The WLTP (Worldwide Harmonised Light Vehicles Test Procedure) is used to measure fuel consumption and CO₂ figures. Full data relating to WLTP test cycles can be found at: www.vauxhall.co.uk/wltp

Please note: On-the-road recommended retail prices (RRP) include number plates and delivery to Retailer of £700.00 (inc. £116.67 VAT), 12 months' Vehicle Excise Duty and new vehicle first registration fee of £55.00. Excludes fuel and insurance. Company Car Benefit in Kind (BiK) rates are monthly based on the standard paint price. On-the-road prices feature a VED based on preliminary CO₂ information.

Safety

Standard Features – The following features are standard across the entire New Crossland range.

Airbags

- Driver's airbag
- Front passenger's airbag
- Front seat side-impact airbags
- Full-size curtain airbags

Seating

- Height-adjustable front seat head restraints
- Height-adjustable outer rear seat head restraints
- Anti-submarining ramps in front seats

Seatbelts

- Inertia-reel lap and diagonal seatbelts for all seats
- Dual seatbelt pretensioners on front seats
- Pretensioners on outer rear seatbelt retractors
- Load limiters on front and outer rear seatbelt retractors
- Smart seatbelt reminder for front and rear seats

Braking

- Anti-lock Braking System (ABS)
- Electronic brakeforce distribution – Automatically apportions the optimum braking force to each wheel
- Hydraulic brake assist
- Hydraulic brake boost
- Hill start assist – Briefly maintains rear brake pressure to stop the vehicle rolling back on an incline



Hill start assist.

Child safety

- Deactivation switch for front passenger's front and side-impact airbags
- ISOFIX child seat mountings incorporating top tether anchor points located on outer rear seats (does not include child seat) – Allows ISOFIX child safety seats to be securely fixed into the car. The ISOFIX mounting system reduces forward movement in an accident and makes the child seat easier to install
- Child-proof locks on rear doors

Driver/passenger safety

- Energy-absorbing steering column
- Side-impact protection beams
- Reinforced passenger safety cell
- Deformation zones front and rear

Pedestrian safety

- Collapsible windscreen wiper system – Designed to reduce pedestrian head injuries.
- Upper and lower bumper design – Reduces upper and lower leg injuries.



ISOFIX child seat mountings.

Stability

- Electronic Stability Programme (ESP) – ESP monitors many different inputs to determine when the car starts to lose traction, it can then immediately respond by varying the brake pressure between up to three wheels and adjust the engine output to help correct the loss of traction and improve stability

Additional ESP features

- Traction control
- Corner stability control
- Engine drag torque control – Improves directional stability by preventing the driven wheels from locking on slippery surfaces under the influence of engine braking.

Tyre pressure

- Tyre pressure monitoring system

Vauxhall driver assistance systems are intended to support the driver within the system-imminent limitations. The driver remains responsible for the driving task at all times.



Lane departure warning (see next page for feature description).

Driver Assistance

Standard Features – The following features are standard across the entire New Crossland range. Specific features by model are outlined in the separate tabular information.

Cruise control with speed limiter

With steering wheel mounted controls. Enables you to maintain a constant speed, making it ideal for economical motorway driving.

Steering

- Speed sensitive power-assisted steering
- Reach and rake adjustable steering column

Wipers

- Rain-sensitive windscreen wipers
- Intermittent rear window wash/wipe

Automatic anti-dazzle rear-view mirror

- Automatically dimming anti-dazzle rear-view mirror

Speed sign recognition

Detects and then displays speed limits, reducing uncertainty and the risk of speeding.

- Recognises different speed signs, including temporary speed restrictions
- Displays reminder in the instrument cluster

Lane departure warning

If the driver has not actively steered or signalled, the lane departure warning system warns when the car moves outside of lane markings at speeds above 37mph.

- Warning light in instrument cluster
- Audible warning
- Facia on/off switch

Model Specific Features/Option

	SE	SRi Nav	Elite	Elite Nav	Ultimate Nav
Safety					
Driver drowsiness system/Forward collision alert/Automatic emergency braking with pedestrian detection		£500*	£500*	£500*	£500*
Driver Assistance					
Rear parking distance sensors		●			
Front and rear parking distance sensors			●	●	●
Rear-view camera			●		
Panoramic rear-view camera				●	●

*Optional at extra cost including VAT.

Driver Information and Security

Standard Features – The following features are standard across the entire New Crossland range. Specific features by model are outlined in the separate tabular information.

Driver Information

Instrumentation

- Speedometer and rev counter
- Fuel gauge with low fuel level warning light
- Water temperature gauge with warning light
- Shift-up/down indication light – Indicates when to change gear for optimum fuel economy.

Driver information display

(centrally located in instrument cluster)

- Trip computer data
- Total mileage
- Service-due indicator
- Oil life
- Tyre pressure monitoring system

Multi-function trip computer

(displayed on driver information display)

- Trip mileage
- Vehicle range based on remaining fuel
- Average speed
- Average fuel economy
- Instantaneous fuel economy

Central facia display

(format dependent on infotainment unit)

- Audio information
- Digital clock with automatic RDS time adjustment
- Outside air temperature with ice warning function
- Additional features dependent on infotainment unit (see infotainment for details)

Security

- Electronically protected audio equipment
- Engine deadlock immobiliser
- Visible Vehicle Identification Number (VIN)
- Locking wheel bolts for alloy wheels
- Luggage area cover

Remote control central locking

- Operates on doors, tailgate and fuel filler flap
- Deadlocking
- Central locking activation switch on driver's door

Model Specific Features

	SE	SRi Nav	Elite	Elite Nav	Ultimate Nav
Driver Information					
Segmented instrument display	●				
Driver information display (centrally located in instrument cluster) – 3.5-inch monochrome display		●	●	●	●
Security					
Remote control security alarm system		●	●	●	●
Keyless entry and start					●

Convenience

Standard Features – The following features are standard across the entire New Crossland range. Specific features by model are outlined in the separate tabular information.

Interior Convenience

- Front 12-volt electrical accessory socket
- Driver’s and front passenger’s illuminated vanity mirrors with flip-up cover
- Reach and rake-adjustable steering
- Steering wheel mounted audio/phone/cruise controls
- Front USB connection

Interior Storage

- Glovebox with lid
- Front door pockets with 1.5-litre bottle holder
- Two drinks holders in centre console
- Rear door pockets with 0.5-litre bottle holder
- Open storage compartment in centre console

Luggage Area

- Luggage compartment foldable cover
- Illuminated luggage area
- Fully carpeted luggage area

Interior Lighting

- Central front courtesy light
- Central rear courtesy lights
- Fade up/fade down

Model Specific Features

	SE	SRi Nav	Elite	Elite Nav	Ultimate Nav
Interior Convenience and Storage					
Driver’s seat armrest			●	●	
Front centre armrest with storage		●			●
12v rear seat power outlet		●			●
Storage pockets on front seat backs		●	●	●	●
2 x USB connections		●		●	●
Wireless charger for mobile devices				●	
Courtesy lighting	●				
Ambient lighting		●	●	●	●
60/40 split-folding rear seat back	●		●	●	
Versatility Pack - Sliding 60/40 rear seat back with centre rear seat armrest/Centre rear head restraint/Load floor compartment FlexFloor with cargo under floor divider		●			●

Convenience

Standard Features – The following features are standard across the entire New Crossland range. Specific features by model are outlined in the separate tabular information.

Heating and Ventilation

- Air recirculation facility
- Cabin particulate filter – Removes dust, airborne particles and pollen
- Multi-speed fan
- Illuminated controls
- Four adjustable facia vents
- Windscreen demist vents
- Side window demist vents

Exterior Convenience

Door mirrors

- Twin electrically adjustable/heated door mirrors

Windows

- Electrically operated front and rear windows with safety autoreverse and one-touch up/down facility
- Heated rear window
- Tinted windows
- Solar heat-absorbing windscreen

Model Specific Features/Option

	SE	SRi Nav	Elite	Elite Nav	Ultimate Nav
Heating and Ventilation					
Air conditioning	●				
Dual-zone electronic climate control		●	●	●	●
Winter Pack – Heated front seats/Heated steering wheel	£335*	£335*	●	●	●
Exterior Convenience					
Solar heat-absorbing windows	●				

*Optional at extra cost including VAT.

Exterior Style and Lighting

Standard Features – The following features are standard across the entire New Crossland range. Specific features by model are outlined in the separate tabular information.

Exterior Styling

- Body-colour front and rear bumpers
- Body-colour door handles
- Black painted door mirrors
- Integrated tailgate spoiler

Exterior Lighting

- LED headlights
- LED daytime running lights
- LED side repeat indicators
- Lights-on audible warning – When driver’s door is opened an audible warning sounds to alert the lights have been left on.

- Rear fog light
- Reversing light
- Hazard warning lights
- Automatic lighting control

Model Specific Features

	SE	SRi Nav	Elite	Elite Nav	Ultimate Nav
Exterior Styling					
Dark-tinted rear side and tailgate windows		●	●	●	●
Silver-effect side door mouldings					●
Silver-effect roof rails		●			●
Exterior Lighting					
Automatic high beam control with cornering light		●	●	●	●
Manual headlight levelling system	●				
Automatic headlamp levelling system		●	●	●	●
LED front fog lights		●	●	●	●

Infotainment

Standard Features

Multimedia with 7-inch touchscreen

Standard on SE and Elite

Onboard features:

- 7-inch colour touchscreen
- DAB Digital radio
- RDS with Traffic Programme
- AM/FM stereo radio with 36 station presets
- Six speakers

Media connections:

- USB connection
- Bluetooth® A2DP audio streaming (Advanced Audio Distribution Profile)

Mobile phone portal:

- Bluetooth® connectivity
- Vehicle microphone
- Handsfree calls via steering wheel controls
- Phone book access – Contacts/last calls/missed calls etc. are mirrored on the display and are easily navigated using the touchscreen (features dependent on mobile phone).
- SMS read out and reply

Smartphone interface:

- Apple CarPlay
- Android Auto™
- Smartphone projection that allows operations via voice command, touchscreen and buttons to control apps and music playback.

Additional features:

- Steering wheel mounted audio controls
- Flexible roof-mounted aerial

Multimedia Navi Pro with 8-inch Touchscreen

Standard on SRi Nav, Elite Nav and Ultimate Nav

Features as Multimedia, with the addition of:

- Satellite navigation system
- 2D/3D street level mapping
- European coverage
- Points-of-interest search
- Map updates via USB
- 1 extra USB connection

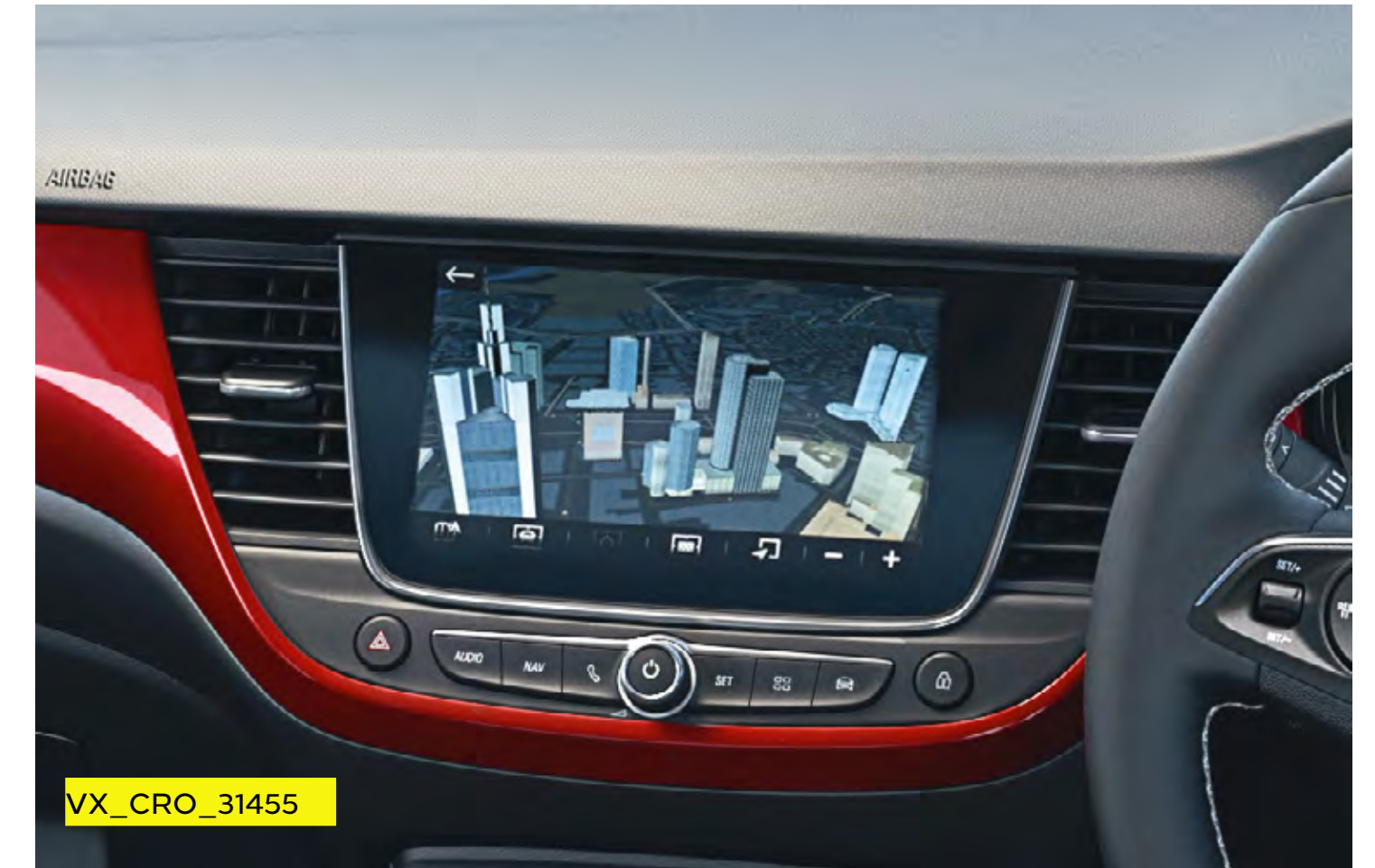

Please note that compatibility and certain functions may be different depending on the type of device and operating system you're using with the Multimedia systems. Apple CarPlay is a trademark of Apple Inc. Apple and iPhone are trademarks of Apple Inc., registered in the U.S. and other countries. Android is a trademark of Google Inc, also registered in the U.S. and other countries.

Please note, Apple CarPlay screen illustrated on 8-inch colour touchscreen on multimedia Navi Pro audio unit.

Interior Styling and Comfort



Steering wheel:

- Three-spoke design
- Leather-covered steering wheel
- Satin chrome-effect bezel

Facia and door trim:

- Black facia with silver trim inserts
- Black trim inserts on front doors

Seating:

- Driver's seat (four-way adjustable)
 - Height – Reach – Backrest
 - Head restraint
- Front passenger's seat (two-way adjustable)
 - Reach – Backrest – Head restraint
- 60/40 split-folding rear seat back

Seat trim:

- Jet black fabric seat trim inserts
- Jet black fabric side bolsters

Steering wheel:

- Three-spoke design
- Leather-covered steering wheel
- Satin chrome-effect bezel

Facia and door trim:

- Black facia with red trim inserts
- Red trim inserts on front doors

Seating:

- Ergonomic active driver's and front passenger's seat (AGR-approved*) (eight-way adjustable)
 - Height – Reach – Backrest
 - Seat cushion extension
 - Lumbar adjustment (four-way electrical)
 - Head restraint
- Sliding 60/40 split-folding rear seat back with centre rear seat armrest

Seat trim:

- Jet black/Rubar red fabric seat trim inserts
- Jet black premium leather-effect side bolsters

Interior Styling and Comfort

Elite/Elite Nav



Steering wheel:

- Three-spoke design
- Heated leather-covered steering wheel
- Satin chrome-effect bezel

Facia and door trim:

- Black facia with silver trim inserts
- Black trim inserts on front doors

Seating:

- Ergonomic active driver's seat (AGR-approved*) (eight-way adjustable)
 - Height - Reach - Backrest
 - Seat cushion extension
 - Lumbar adjustment (four-way electrical)
 - Head restraint
- Front passenger's seat (two-way adjustable)
- 60/40 split-folding rear seat back
- Heated front seats

Seat trim:

- Jet black fabric seat trim inserts
- Jet black premium leather-effect side bolsters

Elite Nav model illustrated.

Ultimate Nav



Steering wheel:

- Three-spoke design
- Heated leather-covered steering wheel
- Satin chrome-effect bezel

Facia and door trim:

- Black facia with silver trim inserts
- Black trim inserts on front doors

Seating:

- Ergonomic active driver's and front passenger's seat (AGR-approved*) (eight-way adjustable)
 - Height - Reach - Backrest
 - Seat cushion extension
 - Lumbar adjustment (four-way electrical)
 - Head restraint
- Sliding 60/40 split-folding rear seat back with centre rear seat armrest
- Heated front seats

Seat trim:

- Alcantara seat trim inserts
- Jet black premium leather-effect side bolsters

*AGR (The Campaign for Healthier Backs) is an independent centre of excellence for ergonomics, based in Germany.

Effective 7 April 2021

New Crossland Model Year 2021D

Exterior Colours

Navy Blue (G4B)*
Two-coat metallic paint



VX_CRO_31450

White Jade (G20)**
Brilliant paint £320



VX_CRO_31444

Quartz Grey (G4I)**
Two-coat metallic paint £550



VX_CRO_31445

Moonstone Grey (G4O)**
Two-coat metallic paint £550



VX_CRO_31446

Diamond Black (G7O)**
Two-coat metallic paint £550



VX_CRO_31447

Power Orange (GPQ)**
Two-coat premium paint £650



VX_CRO_31449

Hot Red (G1R)**
Two-coat premium paint £650



VX_CRO_31448

The colours reproduced may vary slightly from the actual paint colour. As a result they should be used as a guide only. Your Vauxhall Retailer has a comprehensive display of our paint samples.

*Standard exterior paint for New Crossland. **Optional at extra cost including VAT.

Roof, door mirrors and window moulding colours

	SE	SRi Nav	Elite	Elite Nav	Ultimate Nav
Roof Colours					
Body-coloured roof	●	No-cost	No-cost	No-cost	No-cost
Black roof*	£400‡	●	●	●	●
White roof and door mirrors**	£400‡	£400‡	£400‡	£400‡	£400‡
Window Moulding Colours					
Black upper window moulding	●				
Red upper window moulding		●†			
Chrome-effect upper window moulding		●††/No-cost‡‡	●	●	●



VX_CRO_31451

Black roof (22T)



VX_CRO_31452

White roof and door mirrors (03T)

*Standard with Diamond Black body colour. **Standard with White Jade (SE models) and Diamond Black (SRi Nav/Elite/Elite Nav/Ultimate Nav only) body colours. Not available on Hot Red and Power Orange body colours.

†Not available with Hot Red, Power Orange and Navy Blue body colours. ††Standard with Hot Red, Power Orange and Navy Blue body colours.

‡Optional at extra cost including VAT. ‡‡No cost option with White Jade, Diamond Black, Quartz Grey and Moonstone Grey exterior colours.

Wheels and Tyres

	SE	SRi Nav	Elite	Elite Nav	Ultimate Nav
 <p>VX_CRO_31466_WQS</p> <p>16-inch diamond-cut bi-colour five twin-spoke alloy wheels</p> <ul style="list-style-type: none"> • 195/60 R 16 Tyres • Emergency tyre inflation kit (in lieu of spare wheel) 	●				
 <p>VX_CRO_31465_PZE</p> <p>17-inch diamond-cut bi-colour five twin-spoke alloy wheels</p> <ul style="list-style-type: none"> • 215/50 R 17 tyres • Emergency tyre inflation kit (in lieu of spare wheel) 		●	●	●	●
 <p>VX_CRO_31509_PYX</p> <p>17-inch black five twin-spoke alloy wheels</p> <ul style="list-style-type: none"> • 215/50 R 17 tyres • Emergency tyre inflation kit (in lieu of spare wheel) 		No-cost			
Provision for spare wheel fitment (spare wheel is Retailer-fit)	£20*	£20*	£20*	£20*	£20*

*Optional at extra cost including VAT.

Petrol Engines

	1.2 (83PS)	1.2 (110PS) Turbo	1.2 (130PS) Turbo
Capacity	1199cc	1199cc	1199cc
Maximum power	83PS (61kW) @ 5750rpm	110PS (81kW) @ 5500rpm	130PS (96kW) @ 5500rpm
Maximum torque	118Nm (87 lb.ft.) @ 1750rpm	205Nm (151 lb.ft.) @ 1750rpm	230Nm (169 lb.ft.) @1750rpm
Configuration	3 cylinders, 4 valves per cylinder, double overhead camshafts	3 cylinders, 4 valves per cylinder, double overhead camshafts	3 cylinders, 4 valves per cylinder, double overhead camshafts
Fuel/induction system	Naturally aspirated with Variable Valve Timing. Multi-point sequential electronic fuel injection	Turbocharger. Variable Valve Timing. Direct fuel injection	Turbocharger with intercooler. Multi-point sequential fuel injection
Emission compliance	Euro 6d	Euro 6d	Euro 6d
Service interval	16,000 miles or 1 year (whichever occurs sooner)	16,000 miles or 1 year (whichever occurs sooner)	16,000 miles or 1 year (whichever occurs sooner)

Diesel Engines

	1.5 (110PS) Turbo D with 6-speed manual	1.5 (120PS) Turbo D with 6-speed automatic
Capacity	1499cc	1499cc
Maximum power	110PS (81kW) @ 3500rpm	120PS (88kW) @ 3750rpm
Maximum torque	250Nm (184lb.ft.) @ 1750rpm	250Nm (184lb.ft.) @ 1750rpm
Configuration	4 cylinders, 4 valves per cylinder, double overhead camshafts	4 cylinders, 4 valves per cylinder, double overhead camshafts
Fuel/induction system	Turbocharger. Direct fuel injection	Turbocharger. Direct fuel injection
Emission compliance	Euro 6d	Euro 6d
Service interval	20,000 miles or 1 year (whichever occurs sooner)	20,000 miles or 1 year (whichever occurs sooner)

Performance, Fuel Economy and Emissions

	Performance (manufacturer's figures)		Fuel economy mpg (litres/100km) [#]		CO ₂ emissions g/km [#]		Vehicle Excise Duty*		BiK rates from – 2021/22 tax year
	Maximum speed (mph)	Acceleration 0–60mph (sec)	Combined Low	Combined High	Combined Low	Combined High	First year rate	Standard rate	
1.2 (83PS)	106	14.0	46.3 (6.1)	47.9 (5.9)	135	137	£220	£155	31%
1.2 (110PS) Turbo	116	10.5	47.9 (5.9)	48.7 (5.8)	131	134	£220	£155	30%
1.2 (130PS) Turbo	125	9.5	48.7 (5.8)	49.5 (5.7)	130	132	£220	£155	30%
1.2 (130PS) Turbo auto	123	9.9	45.6 (6.2)	46.3 (6.1)	137	139	£220	£155	31%
1.5 (110PS) Turbo D	115	11.4	60.1 (4.7)	61.4 (4.6)	120	123	£180	£155	28%
1.5 (120PS) Turbo D auto	114	11.1	55.4 (5.1)	57.7 (4.9)	130	133	£180	£155	30%

Weights and Towing Data ^{kg} ^{**}

	Gross vehicle weight	Maximum towing weights Trailer with brakes (without brakes)
1.2 (83PS)	1690	650 (560)
1.2 (110PS) Turbo	1770	840 (600)
1.2 (130PS) Turbo	1790	840 (600)
1.2 (130PS) Turbo auto	1835	840 (600)
1.5 (110PS) Turbo D	1820	840 (620)
1.5 (120PS) Turbo D auto	1855	870 (650)

[#]Figures shown are for comparison purposes and should only be compared to the fuel consumption and CO₂ values of other cars tested to the same technical standard. The fuel consumption achieved, and CO₂ produced, in real world conditions will depend upon a number of factors including, but not limited to: the accessories fitted (pre and post registration); variations in weather; driving styles and vehicle load. The WLTP (Worldwide Harmonised Light Vehicles Test Procedure) is used to measure fuel consumption and CO₂ figures. The CO₂ figures display a range to reflect the highest value for the highest emitting version with all available options added, through to a minimum value to represent the lowest emitting version in standard specification. *Correct at time of publication. **Provisional data.

Please note: Gross vehicle weight is the total permissible weight of the vehicle including passengers and their luggage. The **maximum roof rack loading** should not exceed 70kg. The **maximum towing weights** are based on the ability of the car, with two occupants of 75kg each, to restart on a 12% gradient, which is approximately 1 in 8.3, at sea level. The permitted trailer load applies up to the specified incline and up to an altitude of 1000 metres above sea level. The permissible gross train weight decreases by 10% for every 1000 metres of additional altitude. At altitudes above 1500 metres, the engine output may drop with a corresponding reduction in towing capability. Any extra weight, such as luggage or additional passengers, should be deducted from the maximum towing weight. With a trailer fully loaded, **maximum noseweight** should not exceed 55kg. Always fit Vauxhall towing attachments and accessories available from your Vauxhall Retailer. They are designed specifically for Vauxhall models and carry a 12-month guarantee. During trailer towing do not exceed a maximum speed of 60mph. This speed limit is also applicable in countries with higher permitted speeds for trailer-vehicle combinations. Pay attention to the local speed limits. For trailers with low driving stability and caravans the use of an oscillation damper is strongly recommended.

Specifications

Transmission

Five-speed manual gearbox

Petrol engines: 1.2 (83PS)

Six-speed manual gearbox

Petrol engines: 1.2 (110/130PS) Turbo models

Diesel engines: 1.5 (110PS) Turbo D models

Six-speed automatic transmission

Petrol engines: 1.2 (130PS) Turbo models

Diesel engines: 1.5 (120PS) Turbo D models

Steering

- Speed-sensitive electric power-assisted steering
- Turning circle (wall-to-wall): 11.21m (36.7ft)

Suspension

Front: Independent. Lightweight MacPherson struts with gas-pressure dampers and coil springs. Anti-roll bar.

Rear: Compound crank with coil springs and hydraulic dampers.

Braking and stability

- Switchable Electronic Stability Programme (ESP)
- Anti-lock Braking System (ABS)
- Corner stability control
- Traction control
- Hill start assist
- Engine drag torque control
- Hydraulic brake assist
- Hydraulic brake boost
- Electronic brakeforce distribution

1.2 (83PS)/1.5 (102PS) Turbo D models

Front ventilated discs: 266mm diameter

Rear discs: 249mm diameter

1.2 (110PS) Turbo/1.2 (130PS) Turbo

Front ventilated discs: 283mm diameter

Rear discs: 249mm diameter

Fuel tank capacity

- 45 litres (9.9 gallons)

AdBlue® Tank Capacity

- 14.8 litres (3.2 gallons)

Body

- Aerodynamic drag co-efficient: Cd 0.31

Start/Stop technology

Crossland's Start/Stop system, fitted as standard to all models, offers real benefits by improving fuel economy and reducing CO₂ emissions, particularly in town. It does this by automatically stopping the engine when you come to a standstill, and then restarting as you prepare to move off.

Before automatically stopping the engine a number of system checks are carried out to ensure that it is both safe and practical to do so. To ensure safety, the driver must depress the clutch pedal, shift in to neutral, and then release the clutch pedal. System checks carried out before Auto Stop activates include:

- Start/Stop system is not manually deactivated via the facia button
- Sufficient brake vacuum is available to prevent the car rolling down an incline
- Battery is in good condition and charged
- Outside air temperature and engine temperature are above specified minima
- Electronic climate control (where fitted) is not in maximum heating or maximum cooling mode
- Self-cleaning function of the diesel particulate filter is not active

If all of these conditions are satisfied then the vehicle will Auto Stop.

When you are ready to pull away from standstill, Auto Restart is activated by depressing the clutch pedal.

Whilst at a standstill the vehicle is continually monitored. If necessary, the engine will automatically be restarted. Conditions that would initiate an Auto Restart include:

- Low battery level
- Brake vacuum below specified minimum
- Start/Stop system is manually deactivated
- Stationary for 5.5 minutes

Dimensions and Capacities All measurements in mm (inches) unless stated otherwise.



Loadspace Dimensions	
Maximum length behind rear seats	793 (31.2)
Maximum length rear seats folded	1483 (58.4)
Maximum width	1000 (39.4)
Maximum height	894 (35.2)

Luggage Capacities Litres (cu.ft.)	
Rear seats up (under luggage compartment cover)	410 (14.5)
Rear seats up with optional sliding rear seats in forward-most position	520 (18.4)
Rear seats folded (to roof)	1255 (44.3)

Accessories

Safety	Total (inc. VAT)	Protection	Total (inc. VAT)	Comfort	Total (inc. VAT)	Transport solutions	Total (inc. VAT)
Spare wheel kit with 16-inch emergency wheel and tool kit ¹	£167	Floor mats (set of 4)		FlexConnect bracket	£20	Roof base carrier (set of 2 bars) ⁶	
Philips ADR620 dash cam	£109	- Carpet	£42	FlexConnect hook	£27	- Without roof rails	£178
Front parking sensors ²	£363	- Velour	£53	FlexConnect coat hanger	£40	- With roof rails	£169
Rear parking sensors	£407	- Rubber	£60	FlexConnect folding table	£65	Roof carriers (requires base carrier)	
Rear view camera	£328	Boot carpet mat	£51	FlexConnect iPad mini holder	£93	Roof box - Thule Ocean 80	£164
Side steps	£636	Boot tray ⁵	£72	FlexConnect iPad holder	£103	Roof box - Thule Ocean 200	£374
Child seats ³		Vertical cargo net	£285	FlexConnect iPad Air holder	£103	Roof box - Thule Touring 200	£428
- Age group 0 (approx. 24 months/ up to 13kg)	£182	Dog guard	£201	FlexConnect Samsung Galaxy holder	£93	Roof box - Thule Touring 700	£492
- ISOFIX base for age group 0 ⁴	£230	Front and rear splash guards	£116	Privacy shades for rear and side rear windows (set of 4)	£100	Roof box - Thule Motion 800	from £426
- Age group 1 (approx. 1-3.5 years/9-18kg)	£510	Style		Cup holder insert		Bike carrier - Thule FreeRide 532	£81
- Age group 2/3 (approx. 3-12 years/ 15-36kg)	£186	Door sills		- Miscellaneous	£9	Bike carrier - Thule Expert 298	£134
Safety Pack - first aid kit, hi-vis vest and small warning triangle	£16	- Stainless steel	£41	- Pen	£15	Surfboard carrier - Thule 833	£82
Warning triangle	£9	- Illuminated kit	£173	- Notepad	£15	Ski/snowboard carrier	
Hi-vis safety vest - adult	£4	Sport pedal covers		Smoker's kit	£37	- Thule Snow Pack 7324 (4 x pairs)	£143
Hi-vis safety vest - child 3-6 years (42cm)	£4	- Manual	£114	Fragrance diffuser	£23	Ski/snowboard carrier	
Hi-vis safety vest - child 7-12 years (52cm)	£4	- Automatic	£114	Fragrance cartridge (various)	£18	- Thule Snow Pack 7326 (6 x pairs)	£258
First aid kit	£15					Towing	
Emergency seat belt cutter and hammer	£18					Tow bar	
Spare bulb kit	£60					- Fixed	from £613
Stretch tow rope	£20					- Detachable	from £492

Please note: Prices shown are fully fitted and painted, where applicable and include VAT. Please check with your local Vauxhall Retailer for details. It is advisable to ensure your insurance policy is adequate to cover additional fitted accessories. Prices correct at time of publication.

¹Vehicle must be ordered with spare wheel fixing option (T7Y) in order to accommodate the spare wheel. ²Can only be fitted with rear parking sensors. ³Restrictions apply to the use of child seats, please consult your vehicle user manual or Vauxhall Retailer. ⁴Restricted to rear seat usage only for vehicles with transponder deactivation of passenger airbag. ⁵Not compatible with spare wheel. ⁶A dedicated T-Track adapter (Thule 697-4 or Thule 697-6) is required for the installation of specific roof boxes, contact your local Vauxhall Retailer for details.

Company Car Driver and Fleet Information

High spec, low P11D

As a business and company car driver, you'll find all of our models are seriously fit for fleet; we're talking very low P11D values, generous standard specification and high-tech engines designed for great fuel economy and low emissions – and that's just to get you started.

To get access to even more spec as standard, simply take a step up in the range – low P11D values will continue to apply.

Drivers and businesses all have unique requirements and by taking advantage of low whole-life costs and low company car driver taxation you can get in the driving seat with the spec to suit.

Company Car Driver Free 3 Day Test Drive

Our free* 3 Day Test Drive programme is open to all Company Car Drivers which allows you to choose any model in the current Vauxhall line-up (exclusions apply). With full insurance cover provided, it gives you a meaningful length of time to make an informed decision about your next company car.

Search Vauxhall 3DTD to book your free* test drive or click the link the below:

[Vauxhall 3 Day Test Drive](#)

*The free 3 Day Test Drive programme is open to Company Car Drivers and Fleet Decision Makers. Available for UK Mainland only. Terms and conditions apply. Full terms and conditions can be found at vauxhallfleet.co.uk/testdrive/index/terms.

Benefit in kind company car taxation**

The car benefit charge will be the car's list price (including VAT, options and accessories fitted, delivery to Retailer and number plates, but excluding Vehicle Excise Duty and new vehicle first registration fee) multiplied by the percentage charge for the CO₂ emissions band in which the car falls (see table opposite). Multiply this figure by your personal income tax rate (20%† for Basic Rate, 40%** for Higher Rate) to calculate your annual benefit in kind tax liability.

Example:

New Crossland SE 1.5 (110PS) Turbo D Start/Stop (CO ₂ emissions 120g/km)	
On-the-road RRP	£21,615.00
Deduct: Vehicle Excise Duty	(£180.00)
New vehicle first registration fee	(£55.00)
Effective list price	£21,380.00
Add: Optional two-coat metallic paint	£550.00
List price for tax purposes (P11D value)	£21,930.00
Car benefit charge 2021-22 tax year (28%)	£6,141.00
Benefit in kind tax liability (2021-22 tax year)	
Basic Rate (20%) tax payer	£1,228.20
Higher Rate (40%) tax payer	£2,456.40

**Please note this Price Guide provides taxation information as a guide only. Vauxhall does not provide taxation guidance. Drivers should always take professional advice on their own tax position. †Excludes residents of Scotland.

BiK for Scottish Residents

Effective 6 April 2018 the Scottish Government have introduced their own BiK taxation structure. This only applies to Company Car Drivers that are Scottish taxpayers. HMRC will determine whether or not an individual is a Scottish taxpayer based on where their main place of residence is.

The BiK rates for Scotland are:

- Over £12,570–£14,667 Starter Rate 19%
- Over £14,667–£25,296 Basic Rate 20%
- Over £25,296–£43,662 Intermediate Rate 21%
- Over £43,662–£150,000 Higher Rate 41%
- Above £150,000 Top Rate 46%

CO ₂ emissions (g/km)	Percentage of cars price to be taxed 2021-22 tax year
Up to 50	13%
51-54	14%
55-59	15%
60-64	16%
65-69	17%
70-74	18%
75-79	19%
80-84	20%
85-89	21%
90-94	22%
95-99	23%
100-104	24%
105-109	25%
110-114	26%
115-119	27%
120-124	28%
125-129	29%
130-134	30%
135-139	31%
140-144	32%
145-149	33%
150-154	34%
155-159	35%
160-164	36%
165-169	37%
170+	37%

Fleet Toolbox

Discover the facts in our online Toolbox for both Company Car Drivers and Fleet Decision Makers. The Fleet Toolbox has a host of useful calculators, comparators, interactive listings and information.

Search Vauxhall Fleet Tools or click the link below:

[Vauxhall Fleet Tool Box](#)

Contact Vauxhall Fleet

Please contact one of our dedicated sales teams who will be happy to help with your particular enquiry.

Company Car Drivers

Call: 0345 111 2020

Email: company-car@vauxhallinfo.co.uk

Telephone lines are open

– Monday to Friday 8:00am–9:00pm

– Saturday and Sunday 9:00am–6:00pm

Fleet Decision Makers

Depending on the size of your fleet of vehicles, we have a dedicated team to handle your enquiries. The lines are open Monday to Friday excluding Bank Holidays.

1-24 vehicles

Call: 0845 076 2254 (8:30am–5:00pm)

25+ vehicles

Call: 0330 587 8222 (8:30am–5:00pm)

Email: vauxhallfleet@vauxhall.co.uk

Special Vehicles (Police, Fire and Ambulance)

Call: 01582 409999 (8:30am–5:00pm)

Email: vauxhallspecialvehicles@vauxhall.co.uk

To calculate your own personal liability, search:

Vauxhall BiK, or click the link below:

[Vauxhall BiK Tool](#)

Further Information

On-the-road prices

To eliminate uncertainty about hidden costs when buying a new car, Vauxhall publishes on-the-road recommended retail prices (RRP) and these are shown in the pricing tables within this price guide. These prices include VAT, number plates and delivery to Retailer of £700.00 (including £116.67 VAT), 12 months' Government Vehicle Excise Duty (see opposite for details) and the DVLA new vehicle first registration fee of £55.00.*

Please note: The on-the-road recommended retail price (RRP) does not include fuel supplied by the Retailer, motor insurance or any other goods or services supplied by agreement between the Retailer and the customer.

Price protection

Order a new Vauxhall for build in the current model year (as confirmed by your Retailer) for delivery no more than three months in advance and the price you are quoted is the price you pay. This is irrespective of any subsequent price rises between placing your order and delivery of your new car, but you must take delivery as soon as the car is available.

In the event of an accident

Vauxhall Accident Management helps keep you mobile following an accident. Benefits include vehicle recovery, Vauxhall-approved repairs and contacting your insurer. For more details, visit vauxhall.co.uk/AccidentManagement

Free2Move Lease

Whether you're a big company or a small business looking for vehicle financing, Free2Move Lease, our business finance specialists, can deliver exactly what you need.

Free2Move Lease is one of the UK's largest leasing companies and is also a member of the British Vehicle Rental and Leasing Association (BVRLA).

With over 60,000 vehicles in the Free2Move Lease portfolio, Free2Move Lease is able to offer competitive vehicle solutions. In addition, Free2Move Lease also offer innovative connected management of servicing and maintenance.

For further information, please contact your local Vauxhall Retailer or visit vauxhall.co.uk/offers-finance/business-leasing.html

Vehicle Excise Duty

The amount of Vehicle Excise Duty (road fund licence) payable on new cars varies depending on the level of carbon dioxide (CO₂) emissions produced by the vehicle. CO₂ emissions are measured in grams per kilometre (g/km) travelled and divided into 13 charging bands shown in the table opposite.

A 'first year rate' of Vehicle Excise Duty is payable on all new cars and in subsequent years the amount payable reverts to the 'standard rate'. From 1 April 2017 the breakpoints for each of these bands have been revised. Also, for vehicles with a list price over £40,000, including factory-fitted options, an additional £335 is payable for the first five years of standard rate payments.

Vehicle Excise Duty*

Band	CO ₂ emissions in grams per kilometre	First year rate Petrol/Diesel	Standard rate Petrol/Diesel
A	0	£0	£0
B	1-50	£10	£155
C	51-75	£25	£155
D	76-90	£115	£155
E	91-100	£140	£155
F	101-110	£160	£155
G	111-130	£180	£155
H	131-150	£220	£155
I	151-170	£555	£155
J	171-190	£895	£155
K	191-225	£1,345	£155
L	226-255	£1,910	£155
M	Over 255	£2,245	£155

*Correct at time of issue.

Further Information

Customer Care Commitment

For added peace of mind, Vauxhall has an innovative Customer Care Commitment that offers the following:

- Three-year vehicle warranty consisting of a one-year/unlimited mileage manufacturer's warranty and a second and third year manufacturer's warranty with a 60,000 miles limitation
- Vauxhall Assistance for 12 months from first registration
- Six years' body panel anti-perforation warranty

Please note: Warranty is only available on vehicles sourced from Vauxhall Motors Limited. Terms and conditions apply – please see your Vauxhall Retailer for details.

Vauxhall Assistance

Vauxhall Assistance is provided automatically with every new Vauxhall for 12 months from first registration and covers everything from accident assistance, roadside recovery and 'at home' service to flat tyres. Even more reason for you to stay calm and let us take care of everything should the need arise. With Vauxhall Assistance help is literally just a free* phone call away, 24 hours a day, 365 days a year!

Protecting the environment

Vauxhall's commitment to the environment is demonstrated by our products' many environmental awards. For even more information on Vauxhall's efforts to achieve an environmentally sustainable future, and how to dispose of your end-of-life vehicle, see vauxhall.co.uk/recycling

Vauxhall Care

This all-inclusive service package is available on Vauxhalls under 10 months old (from date of first registration).

This package offers complete peace of mind for the first 3 years of your Vauxhall's life with fixed monthly payments for the plan duration.

- **3 years' Vauxhall servicing** – covers first, second and third annual services. Including a brake-fluid change in the second service
- **2 years' Vauxhall Roadside Assistance** – first year from us
- **First years' MOT**** – free of charge by your local Vauxhall Retailer

For full terms and conditions and to sign up, visit: vauxhall.co.uk/vauxhallcare

Vauxhall Service Club

Vauxhall Service Club is available for all Vauxhall owners, and it's free to join. Members benefit from the following:

- 15% off Vauxhall Approved Accessories
- Vauxhall's aged 2-3 Years = 15% off parts and labour
- Vauxhall's aged over 3 Years = 25% off parts and labour
- Half price MOT's (NI excluded)
- Free pre-MOT test inspection (NI only)
- Fixed price AdBlue® Refills
 - Car = £14.99
 - Van = £24.99
- Access to the Vauxhall Accident Management Programme
- Online service booking available 24/7 with servicing appointments available within 3 days – [Book Online](#)
- Collection and delivery/onward mobility options
- Complimentary 'Wash and Vac' with all routine services†
- Vauxhall trained technicians
- Genuine Vauxhall parts
- Minimum 12 months warranty on parts and labour
- Regular newsletters with exclusive offers, discounts and competitions

Terms and conditions apply. To join visit: vauxhall.co.uk/serviceclub

Vauxhall Insurance with added reassurance

Comprehensive cover – Summary of benefits

- Competitive premiums
- Repairs by a Vauxhall-trained technician
- Genuine Vauxhall parts, guaranteed for five years when we repair your car within our Approved Repairer Network
- Free courtesy car as standard when using an Approved Repairer††
- 24 hour claims helpline
- Personal Accident benefit
- Cover for audio equipment
- Windscreen cover

Call for a quote on **0330 678 1130**‡

For more product information

For further information on the Vauxhall range or location of your nearest Vauxhall Retailer please call **0345 600 1500**. Alternatively, details can be found on our website at vauxhall.co.uk

For more information call **0345 600 1500**

For Fleet enquiries call **0330 587 8222**

Discover the full Vauxhall range at **[vauxhall.co.uk](https://www.vauxhall.co.uk)**

Join us online

The invoice price, including delivery to Retailer, factory-fitted options, accessories fitted by the Retailer and number plates, is subject to VAT. Some feature descriptions in this guide may refer to, and some illustrations may show, optional equipment not included in the standard delivery. The information contained in this guide was accurate at the time of publication. We reserve the right to make changes in design and equipment. Please note that Vauxhall Retailers are not the agents of Vauxhall Motors Limited and are not authorised to bind Vauxhall Motors Limited by any specific or implied undertaking or representation. It is advisable to ensure that your motor insurance policy provides adequate cover for additional fitted options and accessories. The colours in this guide are only approximate actual colours. Illustrated optional equipment is available at extra charge. Availability, technical features and equipment provided on our vehicles can vary by model. For precise information on the equipment provided on our vehicles, please contact your local Vauxhall Retailer.

VAUXHALL

Price and Specification Guide
7 April 2021 | Model Year 2021B



Grandland X

Including new Hybrid models

Contents

To find the information you want use the links below to navigate around the guide:

[Choose your Trim Level](#)

[Range Highlights](#)

[Models](#)

[Prices](#)

[Features/Options](#)

[Infotainment](#)

[Interior Style and Comfort](#)

[Exterior Colours](#)

[Wheels and Tyres](#)

[Engines and Technical Data](#)

[Performance, Economy and Emissions](#)

[Specifications](#)

[Dimensions and Capacities](#)

[Accessories](#)

[Company Car Information](#)

[Further Information](#)

Choose Your Trim Level

SE Premium

Starting the range is the wonderfully well-equipped SE Premium, with bold looks and smart tech as standard.



VX_GRA_31602

Business Edition Nav

Add a premium look and feel to your commute with the Business Edition Nav, with lots of 'must have' features.

Grandland Hybrid Business Edition Nav

And the Hybrid versions boast lower running costs. You can even upgrade to the Business Edition Nav Premium.



VX_GRA_31604

SRi Nav

For the sporty choice opt for the SRi Nav, and get head-turning good looks and seriously smart tech.



VX_GRA_31603

Griffin Edition

Get even more with the Griffin Edition. Our high-spec, great looking model with a great monthly price to match.



VX_GRA_31792

Elite Nav

Upgrade to the Elite Nav for more comfort and more style, inside and out.

Grandland Hybrid Elite Nav

Step inside and enjoy more comfort with tons of interior features.



VX_GRA_31605

Ultimate

All you could ask for; our range-topping Ultimate model completes the range.



VX_GRA_31601

Grandland X Range Highlights

SE Premium

Standard features include:

- Multimedia infotainment system
 - 7-inch colour touchscreen
 - AM/FM/DAB digital radio
 - Bluetooth® audio streaming
 - Bluetooth® mobile phone portal
 - Apple CarPlay/Android Auto™
 - USB connection
- Six speakers
- Dual-zone electronic climate control
- Leather-covered steering wheel
- Cruise control with speed limiter
- Trip computer
- Speed-sensitive power-assisted steering
- Steering column adjustable for reach/rake
- Steering wheel audio/phone/cruise controls
- Electric parking brake
- Driver's seat height adjuster
- Driver's armrest
- Automatic lighting control
- Rain-sensitive windscreen wipers
- Automatic anti-dazzle rear-view mirror
- 17-inch 5-twin spoke silver-effect alloy wheels
- LED headlights
- LED rear lights
- LED front fog lights
- LED daytime running lights
- Electrically operated front and rear windows
- Electrically adjustable/heated power folding door mirrors
- Chrome-effect side window trim
- Lane departure warning
- Front and rear parking distance sensors
- Speed sign recognition
- Remote control security alarm system
- Hill start assist
- ISOFIX child seat fixings on outer rear seats
- Electronic stability programme (ESP)

Business Edition Nav

Features over SE Premium models:

- Multimedia Navi Pro infotainment system
 - 8-inch colour touchscreen
 - Satellite navigation
- Vauxhall Connect
- Wireless charging for mobile devices
- 60/40 split-folding rear seat with centre rear seat armrest and load-through facility
- Illuminated luggage area
- Storage pocket on front seat backs
- Sports-style front seats
- Driver's ergonomic active seat (AGR approved*)
- Lane keep assist
- Rear-view camera
- Driver drowsiness system
- Automatic emergency braking
- Side blind spot alert
- Advanced park assist

SRI Nav

Features over SE Premium models:

- Multimedia Navi Pro infotainment system
 - 8-inch colour touchscreen
 - Satellite navigation
- Vauxhall Connect
- 60/40 split-folding rear seat with centre rear seat armrest and load-through facility
- Illuminated luggage area
- Storage pocket on front seat backs
- Driver's ergonomic active seat (AGR approved*)
- Sports-style front seats
- 18-inch 5-spoke high gloss black alloy wheels
- Black roof and door mirrors
- Dark-tinted rear windows
- Alloy-effect protective front and rear skid plates
- Lane keep assist
- Rear-view camera
- Driver drowsiness system
- Automatic emergency braking

Elite Nav

Features over SRI Nav models:

- Heated front seats
- Ergonomic active sports-style front seats (AGR approved*)
- Heated steering wheel
- Heated windscreen
- Leather seat facings
- Power driver's seat
- 19-inch diamond-cut multi-spoke bi-colour alloy wheels
- Panoramic glass roof

Please note: Grandland X Elite Nav does not have black roof and door mirrors, dark-tinted rear windows or rear-view camera.

Griffin Edition

Features over SRI Nav models:

- 18-inch 5-spoke diamond-cut bi-colour alloy wheels
- Keyless entry and start
- Power operated tailgate with foot sensor

- Front and rear floor mats (front Griffin-branded)
- Griffin badge
- Silver-effect roof rails

Please note: Grandland X Griffin Edition does not have rear-view camera.

Ultimate

Features over Elite Nav models:

- Alloy sports pedals
- 230-volt accessory socket
- Advanced park assist
- Side blind spot alert
- Panoramic rear-view camera
- Keyless entry and start
- Dark-tinted rear windows
- IntelliLux LED® headlights with Adaptive Forward Lighting
- Power operated tailgate with foot sensor
- Black roof and door mirrors

Grandland X Hybrid Range Highlights

Business Edition Nav

Standard features include:

- Multimedia Navi Pro system
 - 8-inch colour touchscreen
 - Satellite navigation
 - AM/FM/DAB digital radio
 - Bluetooth® audio streaming
 - Bluetooth® mobile phone portal
 - Apple CarPlay/Android Auto™
 - USB connection
- Six speakers
- Vauxhall Connect
- Wireless charging for mobile devices
- Dual-zone electronic climate control
- Flat bottomed leather-covered steering wheel
- Cruise control with speed limiter
- Trip computer
- Speed-sensitive power-assisted steering
- Steering column adjustable for reach/rake
- Steering wheel audio/phone/cruise controls
- Electric parking brake
- Driver's seat height adjuster
- Driver's armrest
- Automatic lighting control
- Rain-sensitive windscreen wipers
- Automatic anti-dazzle rear-view mirror
- Driver's ergonomic active seat (AGR approved*)
- Sports-style front seats
- 18-inch 5-spoke silver-effect alloy wheels
- LED headlights and tail lights
- Front fog lights
- Electrically operated front and rear windows
- Electrically adjustable/heated power folding door mirrors
- Chrome-effect side window trim
- LED daytime running lights
- High beam assist
- Front and rear parking distance sensors
- Rear-view camera
- Speed sign recognition
- Remote control security alarm system
- Hill start assist
- ISOFIX child seat fixings on outer rear seats
- Electronic stability programme (ESP)
- Anti-lock braking system (ABS)
- Six airbags
- Tyre pressure monitoring system
- Driver drowsiness system
- Lane departure warning with lane keep assist
- Forward collision alert
- Black roof and door mirrors
- Dark-tinted rear windows
- Alloy-effect protective front and rear skid plates
- Keyless start

Business Edition Nav Premium

Features over Business Edition Nav:

- 19-inch diamond-cut multi-spoke bi-colour alloy wheels
- IntelliLux LED® headlights with Adaptive Forward Lighting
- Keyless entry and start
- Power operated tailgate with foot sensor
- Heated front seats
- Panoramic rear-view camera
- Side blind spot alert
- Ergonomic active and ventilated front seats (AGR approved*)
- Power driver's seat
- Silver-effect roof rails
- 230-volt accessory socket
- Advanced park assist
- Adaptive cruise control

Elite Nav

Features over Business Edition Nav:

- 19-inch diamond-cut multi-spoke bi-colour alloy wheels
- IntelliLux LED® headlights with Adaptive Forward Lighting
- Keyless entry and start
- Power operated tailgate with foot sensor
- Heated front seats
- Panoramic rear-view camera
- Side blind spot alert
- Ergonomic active and ventilated front seats (AGR approved*)
- Power driver's seat
- 230-volt accessory socket
- Advanced park assist
- Adaptive cruise control

Effective 7 April 2021

Grandland X Model Year 2021B

Grandland X SE Premium

VX_GRA_31602



SE Premium OTR from £27,390

Infotainment:

- Multimedia system
 - 7-inch colour touchscreen
 - AM/FM/DAB digital radio
 - Bluetooth® audio streaming
 - Bluetooth® mobile phone portal
 - Apple CarPlay/Android Auto™
 - USB connection
- Six speakers

Interior convenience/styling:

- Dual-zone electronic climate control
- Leather-covered steering wheel
- Trip computer
- Speed-sensitive power-assisted steering
- Steering column adjustable for reach/rake
- Steering wheel audio/phone/cruise controls
- Electric parking brake
- Driver's seat height adjuster
- Driver's armrest
- Automatic lighting control
- Rain-sensitive windscreen wipers
- Automatic anti-dazzle rear-view mirror

Exterior convenience/styling:

- 17-inch 5-twin spoke silver-effect alloy wheels
- LED headlights
- LED rear lights
- LED front fog lights
- Electrically operated front and rear windows
- Electrically adjustable/heated power folding door mirrors
- Chrome-effect side window trim
- LED daytime running lights
- High beam assist

Safety/security:

- Lane departure warning
- Front and rear parking distance sensors
- Speed sign recognition
- Remote control security alarm system
- Hill start assist
- ISOFIX child seat fixings on outer rear seats
- Electronic stability programme (ESP)
- Anti-lock braking system (ABS)
- Six airbags
- Tyre pressure monitoring system
- Cruise control with speed limiter

This vehicle is covered by our Price Protection Guarantee. See 'Further Information' page for details.

Grandland X Business Edition Nav

VX_GRA_31604



Business Edition Nav

OTR from
£25,165

Infotainment:

- Multimedia Navi Pro system
 - 8-inch colour touchscreen
 - Satellite navigation
 - AM/FM/DAB digital radio
 - Bluetooth® audio streaming
 - Bluetooth® mobile phone portal
 - Apple CarPlay/Android Auto™
 - USB connection
- Six speakers
- Vauxhall Connect
- Wireless charging for mobile devices

Interior convenience/styling:

- Dual-zone electronic climate control
- Leather-covered steering wheel
- Cruise control with speed limiter
- Trip computer
- Speed-sensitive power-assisted steering
- Steering column adjustable for reach/rake
- Steering wheel audio/phone/cruise controls
- Electric parking brake
- Driver's seat height adjuster
- Driver's armrest
- Automatic lighting control
- Rain-sensitive windscreen wipers
- Automatic anti-dazzle rear-view mirror
- Versatility Pack
 - 60/40 split-folding rear seat with centre rear seat armrest and load-through facility
 - Illuminated luggage area
- Storage pocket on front seat backs
- Driver's ergonomic active seat (AGR approved*)
- Sports-style front seats

Exterior convenience/styling:

- 17-inch 5-twin spoke silver-effect alloy wheels
- LED headlights
- LED rear lights
- LED Front fog lights
- Electrically operated front and rear windows
- Electrically adjustable/heated power folding door mirrors
- Chrome-effect side window trim
- LED daytime running lights
- High beam assist

Safety/security:

- Front and rear parking distance sensors
- Rear-view camera
- Speed sign recognition
- Remote control security alarm system
- Hill start assist
- ISOFIX child seat fixings on outer rear seats
- Electronic stability programme (ESP)
- Anti-lock braking system (ABS)
- Six airbags
- Tyre pressure monitoring system
- Safety Pack
 - Driver drowsiness system
 - Automatic emergency braking
 - Lane departure warning with lane keep assist
- Side blind spot alert
- Advanced park assist

Grandland X SRi Nav

VX_GRA_31603



SRi Nav

OTR from £28,595

Infotainment:

- Multimedia Navi Pro system
 - 8-inch colour touchscreen
 - Satellite navigation
 - AM/FM/DAB digital radio
 - Bluetooth® audio streaming
 - Bluetooth® mobile phone portal
 - Apple CarPlay/Android Auto™
 - USB connection
- Six speakers
- Vauxhall Connect

Interior convenience/styling:

- Dual-zone electronic climate control
- Leather-covered steering wheel
- Cruise control with speed limiter
- Trip computer
- Speed-sensitive power-assisted steering
- Steering column adjustable for reach/rake
- Steering wheel audio/phone/cruise controls
- Electric parking brake
- Driver's seat height adjuster
- Driver's armrest
- Automatic lighting control
- Rain-sensitive windscreen wipers
- Automatic anti-dazzle rear-view mirror
- Versatility Pack
 - 60/40 split-folding rear seat with centre rear seat armrest and load-through facility
 - Illuminated luggage area
- Storage pocket on front seat backs
- Driver's ergonomic active front seat (AGR approved*)
- Sports-style front seats

Exterior convenience/styling:

- 18-inch 5-spoke high gloss black alloy wheels
- LED headlights
- LED rear lights
- LED front fog lights
- Electrically operated front and rear windows
- Electrically adjustable/heated power folding door mirrors
- Chrome-effect side window trim
- Black roof and door mirrors
- Dark-tinted rear windows
- Alloy-effect protective front and rear skid plates
- LED daytime running lights
- High beam assist

Safety/security:

- Front and rear parking distance sensors
- Speed sign recognition
- Remote control security alarm system
- Hill start assist
- ISOFIX child seat fixings on outer rear seats
- Electronic stability programme (ESP)
- Anti-lock braking system (ABS)
- Six airbags
- Tyre pressure monitoring system
- Rear-view camera
- Safety Pack
 - Driver drowsiness system
 - Automatic emergency braking
 - Lane departure warning with lane keep assist

*AGR (The Campaign for Healthier Backs) is an independent centre of excellence for ergonomics, based in Germany.

This vehicle is covered by our Price Protection Guarantee. See 'Further Information' page for details.

Grandland X Griffin Edition

VX_GRA_31792



Griffin Edition

OTR from
£25,765

Infotainment:

- Multimedia Navi Pro system
 - 8-inch colour touchscreen
 - Satellite navigation
 - AM/FM/DAB digital radio
 - Bluetooth® audio streaming
 - Bluetooth® mobile phone portal
 - Apple CarPlay/Android Auto™
 - USB connection
- Six speakers • Vauxhall Connect

Interior convenience/styling:

- Dual-zone electronic climate control
- Leather-covered steering wheel
- Cruise control with speed limiter
- Trip computer
- Speed-sensitive power-assisted steering
- Steering column adjustable for reach/rake
- Steering wheel audio/phone/cruise controls
- Electric parking brake • Driver's armrest
- Driver's seat height adjuster
- Automatic lighting control
- Rain-sensitive windscreen wipers
- Automatic anti-dazzle rear-view mirror
- Versatility Pack
 - 60/40 split-folding rear seat with centre rear seat armrest and load-through facility
 - Illuminated luggage area
- Storage pocket on front seat backs
- Driver's ergonomic active front seat (AGR approved*)
- Sports-style front seats
- Front and rear floor mats (front Griffin-branded)
- Ambient centre console downlighter
- Ambient lighting in front doors

Exterior convenience/styling:

- 18-inch 5-spoke diamond-cut bi-colour alloy wheels
- LED headlights
- LED rear lights
- LED front fog lights
- Electrically operated front and rear windows
- Electrically adjustable/heated power folding door mirrors
- Chrome-effect side window trim
- Black roof and door mirrors
- Dark-tinted rear windows
- Alloy-effect protective front and rear skid plates
- LED daytime running lights
- High beam assist
- Power operated tailgate with foot sensor
- Griffin badge
- Silver-effect roof rails

Safety/security:

- Front and rear parking distance sensors
- Speed sign recognition
- Remote control security alarm system
- Hill start assist
- ISOFIX child seat fixings on outer rear seats
- Electronic stability programme (ESP)
- Anti-lock braking system (ABS)
- Six airbags
- Tyre pressure monitoring system
- Keyless entry and start
- Safety Pack
 - Driver drowsiness system
 - Automatic emergency braking
 - Lane departure warning with lane keep assist

*AGR (The Campaign for Healthier Backs) is an independent centre of excellence for ergonomics, based in Germany.

This vehicle is covered by our Price Protection Guarantee. See 'Further Information' page for details.

Grandland X Elite Nav

VX_GRA_31605



Elite Nav

OTR from £29,715

Infotainment:

- Multimedia Navi Pro system
 - 8-inch colour touchscreen
 - Satellite navigation
 - AM/FM/DAB digital radio
 - Bluetooth® audio streaming
 - Bluetooth® mobile phone portal
 - Apple CarPlay/Android Auto™
 - USB connection
- Six speakers • Vauxhall Connect

Interior convenience/styling:

- Dual-zone electronic climate control
- Leather-covered steering wheel
- Cruise control with speed limiter
- Trip computer
- Speed-sensitive power-assisted steering
- Steering column adjustable for reach/rake
- Steering wheel audio/phone/cruise controls
- Electric parking brake
- Driver's seat height adjuster
- Driver's armrest
- Automatic lighting control
- Rain-sensitive windscreen wipers
- Automatic anti-dazzle rear-view mirror
- Versatility Pack
 - 60/40 split-folding rear seat with centre rear seat armrest and load through facility
 - Illuminated luggage area
- Storage pocket on front seat backs
- Ergonomic active sports-style front seats (AGR approved*)
- Power driver's seat
- Heated front seats
- Heated steering wheel
- Heated windscreen
- Leather seat facings

Exterior convenience/styling:

- 19-inch diamond-cut multi spoke bi-colour alloy wheels
- LED headlights
- LED rear lights
- LED front fog lights
- Electrically operated front and rear windows
- Electrically adjustable/heated power folding door mirrors
- Chrome-effect side window trim
- LED daytime running lights
- High beam assist
- Panoramic glass roof

Safety/security:

- Front and rear parking distance sensors
- Speed sign recognition
- Remote control security alarm system
- Hill start assist
- ISOFIX child seat fixings on outer rear seats
- Electronic stability programme (ESP)
- Anti-lock braking system (ABS)
- Six airbags
- Tyre pressure monitoring system
- Safety Pack
 - Driver drowsiness system
 - Automatic emergency braking
 - Lane departure warning with lane keep assist

*AGR (The Campaign for Healthier Backs) is an independent centre of excellence for ergonomics, based in Germany.

This vehicle is covered by our Price Protection Guarantee. See 'Further Information' page for details.

Grandland X Ultimate

VX_GRA_31601



Ultimate OTR from £31,585

Infotainment:

- Multimedia Navi Pro system
 - 8-inch colour touchscreen
 - Satellite navigation
 - AM/FM/DAB digital radio
 - Bluetooth® audio streaming
 - Bluetooth® mobile phone portal
 - Apple CarPlay/Android Auto™
 - USB connection
- Six speakers
- Vauxhall Connect

Interior convenience/styling:

- Dual-zone electronic climate control
- Leather-covered steering wheel
- Cruise control with speed limiter
- Trip computer
- Speed-sensitive power-assisted steering
- Steering column adjustable for reach/rake
- Steering wheel audio/phone/cruise controls
- Electric parking brake
- Driver's seat height adjuster
- Driver's armrest
- Automatic lighting control
- Rain-sensitive windscreen wipers
- Automatic anti-dazzle rear-view mirror
- Versatility Pack
 - Sliding 60/40 rear seat base with centre rear seat armrest
 - Illuminated luggage area
- Storage pocket on front seat backs
- Ergonomic active sports-style front seats (AGR approved*)
- Heated front seats • Heated steering wheel
- Heated windscreen • Leather seat facings
- Alloy sports pedals
- 230-volt accessory socket

Exterior convenience/styling:

- 19-inch diamond-cut multi spoke bi-colour alloy wheels
- IntelliLux LED® headlights with Adaptive Forward Lighting
- LED rear lights
- LED front fog lights
- Electrically operated front and rear windows
- Electrically adjustable/heated power folding door mirrors
- Chrome-effect side window trim
- Advanced park assist
- LED daytime running lights
- Panoramic glass roof
- Dark-tinted rear windows
- Power operated tailgate with foot sensor
- Black roof and door mirrors

Safety/security:

- Front and rear parking distance sensors
- Speed sign recognition
- Remote control security alarm system
- Hill start assist
- ISOFIX child seat fixings on outer rear seats
- Electronic stability programme (ESP)
- Anti-lock braking system (ABS)
- Six airbags
- Tyre pressure monitoring system
- Keyless entry and start
- Panoramic rear-view camera
- Safety Pack
 - Driver drowsiness system
 - Automatic emergency braking
 - Lane departure warning with lane keep assist
- Side blind spot alert

*AGR (The Campaign for Healthier Backs) is an independent centre of excellence for ergonomics, based in Germany.

This vehicle is covered by our Price Protection Guarantee. See 'Further Information' page for details.

Grandland X Hybrid Business Edition Nav

VX_GRA_PHEV_31670



**Business Edition
Nav**

**OTR from
£32,390**

Infotainment:

- Multimedia Navi Pro system
 - 8-inch colour touchscreen
 - Satellite navigation
 - AM/FM/DAB digital radio
 - Bluetooth® audio streaming
 - Bluetooth® mobile phone portal
 - Apple CarPlay/Android Auto™
 - USB connection
- Six speakers
- Vauxhall Connect
- Wireless charging for mobile devices

Interior convenience/styling:

- Dual-zone electronic climate control
- Flat bottomed leather-covered steering wheel
- Cruise control with speed limiter
- Keyless start
- Trip computer
- Speed-sensitive power-assisted steering
- Steering column adjustable for reach/rake
- Steering wheel audio/phone/cruise controls
- Electric parking brake
- Driver's seat height adjuster
- Driver's armrest
- Automatic lighting control
- Rain-sensitive windscreen wipers
- Automatic anti-dazzle rear-view mirror
- Driver's ergonomic active seat (AGR approved*)
- Sports-style front seats

Exterior convenience/styling:

- 18-inch 5-spoke silver-effect alloy wheels
- LED headlights and tail lights
- Front fog lights
- Electrically operated front and rear windows
- Electrically adjustable/heated power folding door mirrors
- Chrome-effect side window trim
- LED daytime running lights
- High beam assist
- Black roof and door mirrors
- Dark-tinted rear windows
- Alloy-effect protective front and rear skid plates

Safety/security:

- Front and rear parking distance sensors
- Rear-view camera
- Speed sign recognition
- Remote control security alarm system
- Hill start assist
- ISOFIX child seat fixings on outer rear seats
- Electronic stability programme (ESP)
- Anti-lock braking system (ABS)
- Six airbags
- Tyre pressure monitoring system
- Driver drowsiness system
- Lane departure warning with lane keep assist
- Forward collision alert

Grandland X Hybrid Business Edition Nav Premium

VX_GRA_PHEV_31671



**Business Edition
Nav Premium**

**OTR from
£34,900**

Infotainment:

- Multimedia Navi Pro system
 - 8-inch colour touchscreen
 - Satellite navigation
 - AM/FM/DAB digital radio
 - Bluetooth® audio streaming
 - Bluetooth® mobile phone portal
 - Apple CarPlay/Android Auto™
 - USB connection
- Six speakers
- Vauxhall Connect
- Wireless charging for mobile devices

Interior convenience/styling:

- Dual-zone electronic climate control
- Flat bottomed leather-covered steering wheel
- Adaptive cruise control
- Trip computer
- Speed-sensitive power-assisted steering
- Steering column adjustable for reach/rake
- Steering wheel audio/phone/cruise controls
- Electric parking brake
- Driver's seat height adjuster
- Driver's armrest
- Automatic lighting control
- Rain-sensitive windscreen wipers
- Automatic anti-dazzle rear-view mirror
- Ergonomic active and ventilated sports-style front seats (AGR approved*)
- Heated front seats
- Power driver's seat
- 230-volt accessory socket

Exterior convenience/styling:

- 19-inch diamond-cut multi spoke bi-colour alloy wheels
- IntelliLux LED® headlights with Adaptive Forward Lighting
- LED tail lights
- Front fog lights
- Electrically operated front and rear windows
- Electrically adjustable/heated power folding door mirrors
- Chrome-effect side window trim
- LED daytime running lights
- High beam assist
- Black roof and door mirrors
- Dark-tinted rear windows
- Alloy-effect protective front and rear skid plates
- Power operated tailgate with foot sensor
- Silver-effect roof rails

Safety/security:

- Front and rear parking distance sensors
- Panoramic rear-view camera
- Speed sign recognition
- Remote control security alarm system
- Hill start assist
- ISOFIX child seat fixings on outer rear seats
- Electronic stability programme (ESP)
- Anti-lock braking system (ABS)
- Six airbags
- Tyre pressure monitoring system
- Keyless entry and start
- Driver drowsiness system
- Lane departure warning with lane keep assist
- Forward collision alert
- Side blind spot alert
- Advanced park assist

*AGR (The Campaign for Healthier Backs) is an independent centre of excellence for ergonomics, based in Germany.

Grandland X Hybrid Elite Nav

VX_GRA_PHEV_31672



Elite Nav

OTR from £41,370

Infotainment:

- Multimedia Navi Pro system
 - 8-inch colour touchscreen
 - Satellite navigation
 - AM/FM/DAB digital radio
 - Bluetooth® audio streaming
 - Bluetooth® mobile phone portal
 - Apple CarPlay/Android Auto™
 - USB connection
- Six speakers
- Vauxhall Connect
- Wireless charging for mobile devices

Interior convenience/styling:

- Dual-zone electronic climate control
- Flat bottomed leather-covered steering wheel
- Adaptive cruise control
- Trip computer
- Speed-sensitive power-assisted steering
- Steering column adjustable for reach/rake
- Steering wheel audio/phone/cruise controls
- Electric parking brake
- Driver's seat height adjuster
- Driver's armrest
- Automatic lighting control
- Rain-sensitive windscreen wipers
- Automatic anti-dazzle rear-view mirror
- Ergonomic active and ventilated sports-style front seats (AGR approved*)
- Heated front seats
- Power driver's seat
- 230-volt accessory socket

Exterior convenience/styling:

- 19-inch diamond-cut multi spoke bi-colour alloy wheels
- IntelliLux LED® headlights with Adaptive Forward Lighting
- LED tail lights
- Front fog lights
- Electrically operated front and rear windows
- Electrically adjustable/heated power folding door mirrors
- Chrome-effect side window trim
- LED daytime running lights
- High beam assist
- Black roof and door mirrors
- Dark-tinted rear windows
- Alloy-effect protective front and rear skid plates
- Power operated tailgate with foot sensor

Safety/security:

- Front and rear parking distance sensors
- Panoramic rear-view camera
- Speed sign recognition
- Remote control security alarm system
- Hill start assist
- ISOFIX child seat fixings on outer rear seats
- Electronic stability programme (ESP)
- Anti-lock braking system (ABS)
- Six airbags
- Tyre pressure monitoring system
- Keyless entry and start
- Driver drowsiness system
- Lane departure warning with lane keep assist
- Forward collision alert
- Side blind spot alert
- Advanced park assist

Grandland X Prices

	Pack Code	Fuel Type	Price (£)	VAT (£)	Total (£)	On-the-road RRP (£)	Financial Year 2021/22 BiK 20% (£)	WLTP Combined CO ₂ (g/km) [#] – pack code	Insurance groups
SE Premium									
1.2 (130PS) Turbo	2K75 EP61	Petrol	22,012.50	4,402.50	26,415.00	27,390.00	144.60	140	20E
1.2 (130PS) Turbo auto	2K75 EF81	Petrol	23,529.17	4,705.83	28,235.00	29,210.00	159.13	146	21E
1.5 (130PS) Turbo D	2K75 HN61	Diesel	22,595.83	4,519.17	27,115.00	28,050.00	134.43	129	21E
1.5 (130PS) Turbo D auto	2K75 HE81	Diesel	24,383.33	4,876.67	29,260.00	30,235.00	154.78	136	21E
Business Edition Nav									
1.2 (130PS) Turbo	2Q75 EP61	Petrol	20,158.33	4,031.67	24,190.00	25,165.00	132.73	140	14E
1.2 (130PS) Turbo auto	2Q75 EF81	Petrol	21,675.00	4,335.00	26,010.00	26,985.00	146.90	146	14E
1.5 (130PS) Turbo D	2Q75 HN61	Diesel	20,733.33	4,146.67	24,880.00	25,815.00	127.88	130	15E
1.5 (130PS) Turbo D auto	2Q75 HE81	Diesel	22,520.83	4,504.17	27,025.00	28,000.00	143.23	136	15E
SRi Nav									
1.2 (130PS) Turbo	2L75 EP61	Petrol	23,016.67	4,603.33	27,620.00	28,595.00	151.03	141	15E
1.2 (130PS) Turbo auto	2L75 EF81	Petrol	24,533.33	4,906.67	29,440.00	30,415.00	165.77	146	15E
1.5 (130PS) Turbo D	2L75 HN61	Diesel	23,600.00	4,720.00	28,320.00	29,255.00	145.08	130	15E
1.5 (130PS) Turbo D auto	2L75 HE81	Diesel	25,387.50	5,077.50	30,465.00	31,440.00	161.02	137	15E

Grandland X's petrol and diesel engines meet the Real Driving Emissions Step 2 (RDE2) standards.

WLTP Combined CO₂ (g/km) figures are based on a configured vehicle as per pack code for UK with no options fitted.

[#]Fuel consumption and CO₂ figures are determined according to the WLTP test cycle. CO₂ figures, BiK values and RRP pricing shown above are for a standard vehicle without any additional optional equipment. CO₂ figures are used to calculate Vehicle Excise Duty (VED) for the first registration of the vehicle and BiK. The addition of optional extras could increase the certified CO₂ emission output. This in turn may affect the amount of VED payable upon registration, and, for company car drivers, the P11D value and the amount of Benefit in Kind (BiK) tax payable. Figures shown are for comparison purposes and should only be compared to the fuel consumption and CO₂ values of other cars tested to the same technical standard. The fuel consumption achieved, and CO₂ produced, in real world conditions will depend upon a number of factors including, but not limited to: the accessories fitted (pre and post registration); variations in weather; driving styles and vehicle load. The WLTP (Worldwide Harmonised Light Vehicles Test Procedure) is used to measure fuel consumption and CO₂ figures. Full data relating to WLTP test cycles can be found at: www.vauxhall.co.uk/wltp

Please note: On-the-road recommended retail prices (RRP) include number plates and delivery to Retailer of £700.00 (inc. £116.67 VAT), 12 months' Vehicle Excise Duty and new vehicle first registration fee of £55.00. Excludes fuel and insurance. Company Car Benefit in Kind (BiK) rates are monthly based on the standard paint price.

Grandland X Prices

	Pack Code	Fuel Type	Price (£)	VAT (£)	Total (£)	On-the-road RRP (£)	Financial Year 2021/22 BiK 20% (£)	WLTP Combined CO ₂ (g/km) [#] – pack code	Insurance groups
Griffin Edition									
1.2 (130PS) Turbo	2E75 EP61	Petrol	20,658.33	4,131.67	24,790.00	25,765.00	135.93	140	15E
1.2 (130PS) Turbo auto	2E75 EF81	Petrol	22,175.00	4,435.00	26,610.00	27,585.00	150.20	146	15E
1.5 (130PS) Turbo D	2E75 HN61	Diesel	21,241.67	4,248.33	25,490.00	26,425.00	130.93	130	15E
1.5 (130PS) Turbo D auto	2E75 HE81	Diesel	23,029.17	4,605.83	27,635.00	28,610.00	146.38	136	15E
Elite Nav									
1.2 (130PS) Turbo	2E75 EP63	Petrol	23,950.00	4,790.00	28,740.00	29,715.00	157.00	140	14E
1.2 (130PS) Turbo auto	2E75 EF83	Petrol	25,466.67	5,093.33	30,560.00	31,535.00	171.92	146	14E
1.5 (130PS) Turbo D	2E75 HN63	Diesel	24,525.00	4,905.00	29,430.00	30,365.00	150.63	130	15E
1.5 (130PS) Turbo D auto	2E75 HE83	Diesel	26,312.50	5,262.50	31,575.00	32,550.00	166.75	136	15E
Ultimate									
1.2 (130PS) Turbo	2U75 EP61	Petrol	25,508.33	5,101.67	30,610.00	31,585.00	166.98	141	17E
1.6 (180PS) Turbo auto	2U75 IB81	Petrol	28,725.00	5,745.00	34,470.00	35,780.00	205.15	156	23E
1.5 (130PS) Turbo D	2U75 HN61	Diesel	26,083.33	5,216.67	31,300.00	32,235.00	159.98	130	17E
1.5 (130PS) Turbo D auto	2U75 HE81	Diesel	27,870.83	5,574.17	33,445.00	34,420.00	176.40	137	17E

Grandland X's petrol and diesel engines meet the Real Driving Emissions Step 2 (RDE2) standards.

WLTP Combined CO₂ (g/km) figures are based on a configured vehicle as per pack code for UK with no options fitted.

[#]Fuel consumption and CO₂ figures are determined according to the WLTP test cycle. CO₂ figures, BiK values and RRP pricing shown above are for a standard vehicle without any additional optional equipment. CO₂ figures are used to calculate Vehicle Excise Duty (VED) for the first registration of the vehicle and BiK. The addition of optional extras could increase the certified CO₂ emission output. This in turn may affect the amount of VED payable upon registration, and, for company car drivers, the P11D value and the amount of Benefit in Kind (BiK) tax payable. Figures shown are for comparison purposes and should only be compared to the fuel consumption and CO₂ values of other cars tested to the same technical standard. The fuel consumption achieved, and CO₂ produced, in real world conditions will depend upon a number of factors including, but not limited to: the accessories fitted (pre and post registration); variations in weather; driving styles and vehicle load. The WLTP (Worldwide Harmonised Light Vehicles Test Procedure) is used to measure fuel consumption and CO₂ figures. Full data relating to WLTP test cycles can be found at: www.vauxhall.co.uk/wltp

Please note: On-the-road recommended retail prices (RRP) include number plates and delivery to Retailer of £700.00 (inc. £116.67 VAT), 12 months' Vehicle Excise Duty and new vehicle first registration fee of £55.00. Excludes fuel and insurance. Company Car Benefit in Kind (BiK) rates are monthly based on the standard paint price.

Grandland X Hybrid Prices

	Pack Code	Fuel Type	Price (£)	VAT (£)	Total (£)	On-the-road RRP (£)	Financial Year 2021/22 BiK 20% (£)	WLTP Combined CO ₂ (g/km) – pack code	Insurance groups
Hybrid									
Business Edition Nav									
1.6 (225PS) Turbo/Electric	2T75 ID81	Petrol/Electric	26,362.50	5,272.50	31,635.00	32,390.00	86.22	31	23E
Business Edition Nav Premium									
1.6 (225PS) Turbo/Electric	2N75 ID81	Petrol/Electric	28,454.17	5,690.83	34,145.00	34,900.00	92.92	31	23E
Elite Nav									
1.6 (225PS) Turbo/Electric	2N75 ID82	Petrol/Electric	33,845.83	6,769.17	40,615.00	41,370.00	110.17	31	24E
Hybrid4									
Business Edition Nav									
1.6 (300PS) Turbo/Electric	2T75 IC81	Petrol/Electric	28,862.50	5,772.50	34,635.00	35,390.00	94.22	29	30E
Business Edition Nav Premium									
1.6 (300PS) Turbo/Electric	2N75 IC81	Petrol/Electric	30,954.17	6,190.83	37,145.00	37,900.00	100.92	29	29E
Elite Nav									
1.6 (300PS) Turbo/Electric	2N75 IC82	Petrol/Electric	36,345.83	7,269.17	43,615.00	44,370.00	118.17	29	30E
OPTION						Price (£) exc. VAT	Price (£) inc. VAT		
7.4kW on-board charger (1 phase) – halves charging time when charging with a 7kW wallbox (see Hybrid Specifications for further details)						416.67	500.00		

WLTP Combined CO₂ (g/km) figures are based on a configured vehicle as per pack code for UK with no options fitted.

*Fuel consumption and CO₂ figures are determined according to the WLTP test cycle. CO₂ figures, BiK values and RRP pricing shown above are for a standard vehicle without any additional optional equipment. CO₂ figures are used to calculate Vehicle Excise Duty (VED) for the first registration of the vehicle and BiK. The addition of optional extras could increase the certified CO₂ emission output. This in turn may affect the amount of VED payable upon registration, and, for company car drivers, the P11D value and the amount of Benefit in Kind (BiK) tax payable. Figures shown are for comparison purposes and should only be compared to the fuel consumption and CO₂ values of other cars tested to the same technical standard. The fuel consumption achieved, and CO₂ produced, in real world conditions will depend upon a number of factors including, but not limited to: the accessories fitted (pre and post registration); variations in weather; driving styles and vehicle load. The WLTP (Worldwide Harmonised Light Vehicles Test Procedure) is used to measure fuel consumption and CO₂ figures. Full data relating to WLTP test cycles can be found at: www.vauxhall.co.uk/wltp

Please note: On-the-road recommended retail prices (RRP) include number plates and delivery to Retailer of £700.00 (inc. £116.67 VAT), 12 months' Vehicle Excise Duty and new vehicle first registration fee of £55.00. Excludes fuel and insurance. Company Car Benefit in Kind (BiK) rates are monthly based on the standard paint price.

Safety

Standard Features – The following features are standard across the entire Grandland X range.

Airbags

- Driver's airbag
- Front passenger's airbag
- Front seat side-impact airbags
- Full-size curtain airbags for driver, front seat passenger and outer rear seat passengers

Seating

- Height-adjustable front seat head restraints
- Height-adjustable rear seat head restraints
- Anti-submarining ramps in front seats

Seatbelts

- Inertia-reel lap and diagonal seatbelts for all seats
- Dual seatbelt pretensioners on front seats – these keep the pelvis better coupled to the vehicle in an impact; the pelvis and therefore the legs are allowed less forward movement, reducing the risk of hard knee contact with the fascia
- Pretensioners on outer rear seatbelt retractors
- Load limiters on outer rear seatbelt retractors
- Smart seatbelt reminder for front and rear seats – warning lights and audible warning

Braking

- Anti-lock Braking System (ABS)
- Hill start assist
- Hydraulic brake assist
- Electronic brakeforce distribution

Tyre pressure

- Deflation detection system

Child safety

- Deactivation switch for front passenger's front and side-impact airbags – permits the safe use of a child seat in the front passenger seat
- i-Size compatible child seat mountings located on front passenger's seat and outer rear seats (does not include child seat). Rear seat mountings incorporate top tether anchor points – allows i-Size child safety seats to be securely fixed into the car. The mounting system reduces forward movement in an accident and makes the child seat easier to install
- Child-proof locks on rear doors

Stability

- Switchable Electronic Stability Programme (ESP)

Additional ESP features

- Corner stability control
- Traction control
- Engine drag torque control – Improves directional stability by preventing the driven wheels from locking on slippery surfaces under the influence of engine braking

Driver/passenger safety

- Energy-absorbing steering column
- Side-impact protection beam
- Reinforced passenger safety cell
- Deformation zones front and rear

Pedestrian safety

- Collapsible windscreen wiper system – designed to reduce pedestrian head injuries
- Upper and lower bumper design – reduces upper and lower leg injuries



Hill start assist.



ISOFIX child seat mountings.



Automatic emergency braking (See driver assistance).

Driver Information and Security

Standard Features – The following features are standard across the entire Grandland X Hybrid range.

Driver Information

Instrumentation

- Speedometer and rev counter
- Fuel gauge with low fuel level warning light
- Water temperature gauge with warning light

Driver information display

(centrally located in instrument cluster)

- 3D instrument cluster
- Service-due indicator
- Deflation detection system
- 3.5-inch colour information display

EV information display

- Powerflow display – Informs drivers on the current state of charge and what is being used as the power source, petrol or electric
- Charge display – displays an image of the charge port with the corresponding LED charge indication lights

- e-Save – enables the driver to determine how much battery energy needs to be conserved to ensure that the vehicle reaches its destination when in a zero emission zone.

There are three options:

- 6 mile range reserve
- 12 mile range reserve
- Maximum reserve
- Statistics – The Statistics display the average consumption data over a period of time using colour coded graphs.
- Green: Energy recovered by braking phases and partial recharging by the petrol engine (kWh/mile)
- Blue: Energy consumed by the vehicle directly by the battery (kWh/mile)
- Orange: Fuel consumption (mpg)

Multi-function trip computer

(displayed on driver information display)

- Trip mileage
- Vehicle range based on remaining fuel
- Average speed
- Average fuel economy
- Instantaneous fuel economy

Central facia display

(format dependent on infotainment unit)

- Audio information
- Digital clock with automatic RDS time adjustment
- Outside air temperature with ice warning function
- Additional features dependent on infotainment unit (see infotainment for details)

Security

- Remote control security alarm system (operates in conjunction with central locking)
- Electronically protected audio equipment
- Engine deadlock immobiliser
- Visible Vehicle Identification Number (VIN)
- Locking wheel nuts
- Remote control central door locking
- Luggage compartment cover
- Keyless engine start/stop



VX_GRA_PHEV_29856

3D instrument cluster.



VX_GRA_30591

Vehicle charge display.

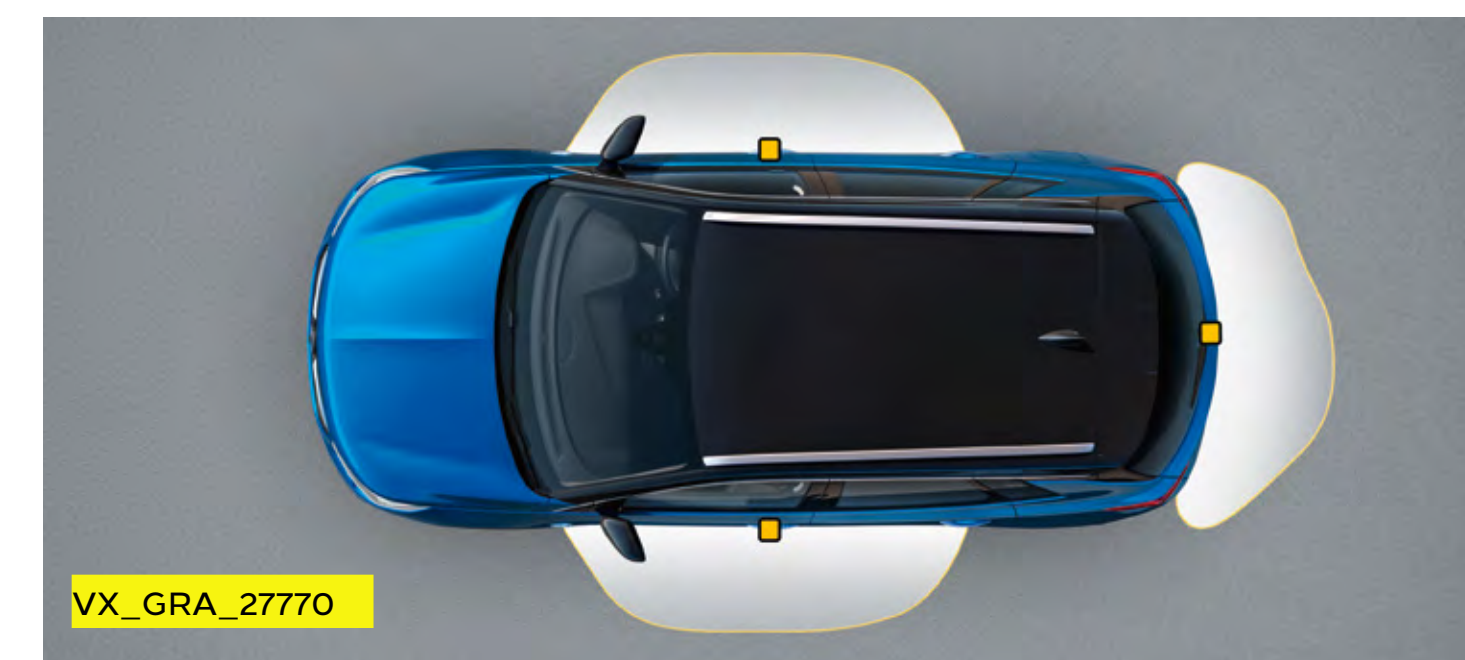

VX_GRA_27770

Keyless entry/engine start/stop (Keyless entry not available on Business Edition Nav).

Driver Assistance

Standard Features – The following features are standard across the entire Grandland X range. Specific features by model are outlined in the separate tabular information.

Automatic cruise control with speed limiter

With steering wheel mounted controls. Enables you to maintain a constant speed, making it ideal for economical motorway driving.

Lane departure warning

If the driver has not actively steered or signalled, the lane departure warning system warns when the car moves outside of lane markings at speeds above 37mph.

- Warning light in instrument cluster
- Audible warning
- Facia on/off switch

Automatically tilting door mirrors

Door mirrors automatically tilt downwards when reverse gear is selected to improve visibility of the back of the car.

Speed sign recognition

Detects and then displays speed limits, reducing uncertainty and the risk of speeding.

- Recognises different speed signs, including temporary speed restrictions
- Displays reminder in the instrument cluster
- On Nav models, where the front camera system is unable to detect any speed signs the speed limit stored in the navigation database will be displayed

Electric parking brake

Centre console switch in lieu of handbrake lever.

Steering

- Speed-sensitive electric power-assisted steering

Parking distance sensors

- Front and rear parking distance sensors

Vauxhall driver assistance systems are intended to support the driver within the system-imminent limitations. The driver remains responsible for the driving task at all times.

Model Specific Features/Option

	SE Premium	Business Edition Nav	SRi Nav	Griffin Edition	Elite Nav	Ultimate	Hybrid models		
							Business Edition Nav	Business Edition Nav Premium	Elite Nav
Driver Assistance									
Safety Pack – Driver drowsiness system/Automatic emergency braking/Lane keep assist		●	●	●	●	●			
Adaptive cruise control								●	●
Rear-view camera		●	●				●		
Park and Go Pack 2 – Side blind spot alert/Advanced park assist front and rear with semi-automatic steering	£800*	●	£800*		£800*		£800*		
Park and Go Pack 3 – Side blind spot alert/Advanced park assist front and rear with semi-automatic steering/Panoramic rear-view camera						●		●	●
Driver drowsiness system							●	●	●
Lane keep assist							●	●	●
Forward collision alert							●	●	●

*Optional at extra cost including VAT.

Driver Information and Security

Standard Features – The following features are standard across the entire Grandland X range. Specific features by model are outlined in the separate tabular information.

Driver Information

Instrumentation

- Speedometer and rev counter
- Fuel gauge with low fuel level warning light
- Water temperature gauge with warning light
- Shift-up indication light (manual models only)
 - Indicates when to change gear for optimum fuel economy

Driver information display (centrally located in instrument cluster)

- Displays trip computer data
- Total mileage
- Service-due indicator
- Deflation detection system
- 3.5-inch colour information display

Multi-function trip computer (displayed on driver information display)

- Trip mileage
- Vehicle range based on remaining fuel
- Average speed
- Average fuel economy
- Instantaneous fuel economy

Central facia display (format dependent on infotainment unit)

- Audio information
- Digital clock with automatic RDS time adjustment
- Outside air temperature with ice warning function
- Additional features dependent on infotainment unit (see infotainment for details)

Security

- Remote control security alarm system (operates in conjunction with central locking)
- Electronically protected audio equipment
- Engine deadlock immobiliser
- Visible Vehicle Identification Number (VIN)
- Locking wheel nuts
- Remote control central door locking
- Two folding keys with integral remote
- Luggage compartment cover

Model Specific Features/Option

	SE Premium	Business Edition Nav	SRi Nav	Griffin Edition	Elite Nav	Ultimate	Hybrid models		
							Business Edition Nav	Business Edition Nav Premium	Elite Nav
Security									
Keyless start							●		
Keyless entry/engine start/stop inc. power tailgate				●	£710*	●		●	●

*Optional at extra cost including VAT.

Convenience

Standard Features – The following features are standard across the entire Grandland X range.
Specific features by model are outlined in the separate tabular information.

Interior Convenience

- Front 12-volt electrical accessory socket
- 12-volt electrical accessory socket in luggage compartment
- Front and rear passenger assist handles
- Automatically dimming anti-dazzle rear-view mirror
- Interior courtesy lighting operated by door switches
- Ventilated glovebox with lid
- Front door pockets with 2.6-litre capacity
- Two drinks holders in centre console
- Rear door pockets with 1.8-litre capacity
- Covered storage compartment in centre console and in driver's armrest
- Luggage compartment foldable cover • Rear reading lights

Heating and Ventilation

- Electronic climate control incorporating air conditioning
- Dual-zone control – Allowing different temperature settings for driver and front passenger
- Advanced predictive logic control system using a sun sensor
- Charcoal filter – Removes dust, airborne particles, pollen and unpleasant odours
- Automatic air direction and fan speed with manual override
- Illuminated controls • Four adjustable facia vents
- Windscreen demist vents • Side window demist vents
- Rear passenger compartment heating ducts
- Heated rear screen with timed cut-off

Exterior Convenience

- Sound-absorbing windscreen
- Tinted windows
- Electrically operated front and rear windows with safety autoreverse and one-touch facility
- Electrically foldable door mirrors with puddle light
- Twin electrically adjustable/heated door mirrors (wide-angle on driver's side) with automatic timed cut-off
- Rain-sensitive windscreen wipers
- Intermittent rear window wash/wipe

Model Specific Features/Option

	SE Premium	Business Edition Nav	SRi Nav	Griffin Edition	Elite Nav	Ultimate	Hybrid models		
							Business Edition Nav	Business Edition Nav Premium	Elite Nav
Interior Convenience									
Driver's and front passenger's sunvisors with vanity mirrors	●	●							
Driver's and front passenger's sunvisors with illuminated vanity mirrors			●	●	●	●	●	●	●
Versatility Pack – 60/40 split-folding rear seat/ Centre rear armrest/Illuminated luggage area		●	●	●	●	●			
230-volt accessory socket					£120*	●	£120*	●	●
Premium lighting – Ambient centre console downlighter/Ambient lighting in front doors				●	●	●		●	●
Storage pocket on front seat backs		●	●	●	●	●	●	●	●
Wireless charger for mobile devices		●					●	●	●

*Optional at extra cost including VAT.

Convenience

Model Specific Features/Options

	SE Premium	Business Edition Nav	SRi Nav	Griffin Edition	Elite Nav	Ultimate	Hybrid models		
							Business Edition Nav	Business Edition Nav Premium	Elite Nav
Heating and Ventilation									
Winter Pack – Heated front seats/Heated steering wheel	£460*	£460*	£460*		●	●			
Heated front seats							£360*	●	●
Heated windscreen	£105*	£105*	£105*		●	●			
Exterior Convenience									
Dark-tinted rear windows			●	●	£275*	●	●	●	●
Fixed panoramic glass roof panel with electrically operated sunblind (not available in conjunction with silver-effect roof rails)					●	●			
Roof rails, silver-effect (in lieu of fixed panoramic glass roof panel on ICE models). Standard on Griffin Edition				●	£150*	£150*		●	
Power operated tailgate with foot sensor – Fitted as part of Keyless entry and start. Not available separately.				●	£710*	●		●	●

*Optional at extra cost including VAT.

Exterior Style and Lighting

Standard Features – The following features are standard across the entire Grandland X range.
Specific features by model are outlined in the separate tabular information.

Exterior Styling

- Side-protection mouldings
- Chrome-effect front grille bar
- Body-colour door mirrors
- Body-colour door handles
- Rear spoiler
- Chrome-effect side window trim

Exterior Lighting

- LED headlights
- LED daytime running lights
- Automatic lighting control
- Lights-on audible warning
- LED tail lights
- High-level centre rear brake light

- Front and rear LED fog lights
- Reversing light
- Hazard warning lights
- Door-to-door illumination
- Welcome lighting
- Manual beam levelling
- High beam assist

Model Specific Features/Options

	SE Premium	Business Edition Nav	SRi Nav	Griffin Edition	Elite Nav	Ultimate	Hybrid models		
							Business Edition Nav	Business Edition Nav Premium	Elite Nav
Exterior Styling									
Exterior Styling Pack – Dark-tinted rear-windows/ Alloy-effect protective front and rear skid plates	£600*	£600*	●	●		●	●	●	●
Gloss black B-pillars		●	●	●	●	●			
Black roof and door mirrors (not available with Diamond Black exterior colour)			●	●		●	●	●	●
Black bonnet (not available with Diamond Black exterior colour)							£400*	£400*	£400*
Exterior Lighting									
IntelliLux LED® headlights with Adaptive Forward Lighting			£800*		£800*	●	£800*	●	●

*Optional at extra cost including VAT.

Infotainment

Standard Features

Multimedia with 7-inch touchscreen

Standard on SE Premium models

Onboard features:

- 7-inch colour touchscreen
- DAB Digital radio
- RDS with Traffic Programme
- AM/FM stereo radio with 25 station presets

Media connections:

- USB connection
- Bluetooth® A2DP audio streaming (Advanced Audio Distribution Profile)
- Six speakers

Mobile phone portal:

- Bluetooth® connectivity
- Handsfree calls via steering wheel controls
- Vehicle microphone
- Phone book access – contacts/last calls/missed calls etc. are mirrored on IntelliLink's display and are easily navigated using the touchscreen (features dependent on mobile phone)

Smartphone interface:

- Apple CarPlay
- Android Auto™
- Smartphone projection that allows operations via voice command, touchscreen and buttons to control apps and music playback

Additional features:

- Steering wheel mounted audio controls
- Flexible roof-mounted aerial

Multimedia Navi Pro with 8-inch touchscreen

Standard on Business Edition Nav, SRi Nav, Griffin Edition, Elite Nav and Ultimate models

Standard on Business Edition Nav, Business Edition Nav Premium and Elite Nav Hybrid models

Features as Multimedia, with the addition of:

Onboard features:

- 8-inch colour touchscreen

Navigation features:

- Satellite navigation system
- 2D/3D street level mapping
- European coverage
- Points-of-interest search
- Map updates via USB

Additional features:

- Shark fin aerial

e-Call and b-Call:

Help when you need it, 24/7, 365 days a year, that's what you get with new Vauxhall Connect. In an emergency or breakdown, you'll be put in touch with a trained advisor, with just the touch of a button.

Live navigation** and more:

You can also access live navigation services, receive vehicle diagnostic info plus there's a host of remote convenience features available through the MyVauxhall app.

- **Peace of mind:** emergency call, breakdown call and regular vehicle status and information
- **Convenience:** remote functions (e.g. lock/unlock the door).
- **Smart driving:** enjoy a relaxed ride thanks to live navigation and trip management

Premium Denon sound system

Optional at extra cost including VAT on Ultimate Petrol/Diesel models and **Business Edition Nav Premium/Elite Nav Hybrid models – £1,000**



Please note that compatibility and certain functions may be different depending on the type of device and operating system you're using with the Multimedia systems. Apple CarPlay is a trademark of Apple Inc. Apple and iPhone are trademarks of Apple Inc., registered in the U.S. and other countries. Android is a trademark of Google Inc, also registered in the U.S. and other countries.

Interior Styling and Comfort

SE Premium



Steering wheel:

- Three-spoke design
- Leather-covered
- Satin chrome-effect bezel

Facia and door trim:

- Frosted silver facia and door panel inserts
- Black door panels with black Modene cloth inserts
- Chrome-effect interior door handles

Seat trim:

- Berson black fabric seat trim inserts
- Modene black fabric side bolsters

Seating:

- Driver's seat (four-way adjustable):
 - Height
 - Reach
 - Backrest
 - Head restraint
- Front passenger's seat (two-way adjustable):
 - Reach
 - Backrest
 - Head restraint

Business Edition Nav/SRi Nav/Griffin Edition



Steering wheel:

- Three-spoke design
- Leather-covered
- Satin chrome-effect bezel

Facia and door trim:

- Black door panels with black premium leather-effect inserts
- Chrome-effect interior door handles

Seat trim:

- Harlekin black fabric seat trim inserts
- Black premium leather-effect side bolsters

Seating:

- Ergonomic active driver's sports-style seat (AGR-approved*) (six-way adjustable)
 - Height
 - Reach
 - Backrest
 - Seat cushion extension
 - Lumbar adjustment (four-way electrical)
 - Head restraint (two-way)
- Front passenger's sports-style seat (two-way adjustable)
 - Reach
 - Backrest
 - Head restraint
- 60/40 split-folding rear seat back

*AGR (The Campaign for Healthier Backs) is an independent centre of excellence for ergonomics, based in Germany.

Interior Styling and Comfort

Business Edition Nav Premium/Elite Nav/Ultimate



Steering wheel:

- Three-spoke design
- Leather-covered
- Satin chrome-effect bezel
- Heated (Petrol/Diesel models only)

Facia and door trim:

- Black door panels with black premium leather-effect inserts
- Chrome-effect interior door handles
- Alloy-effect front door sill covers (Ultimate only)

Pedals:

- Sports, alloy-effect (Ultimate only)

Seat trim:

- Black Siena perforated leather seat trim inserts
- Black Siena leather side bolsters

Seating:

- Heated front seats
- Ergonomic active sports-style front seats (AGR-approved*) and power driver's seat (6-way adjustable):
 - Height (electrical)
 - Reach (electrical)
 - Tilt (electrical)
 - Backrest (electrical)
 - Seat cushion extension
 - Lumbar adjustment (four-way electrical)
 - Head restraint - Active ventilation
- 60/40 split-folding rear seat back

VX_GRA_27293

Exterior Colours

White Jade (G2o)*
Brilliant paint



VX_GRA_27708

Quartz Grey (G4i)**
Two-coat metallic paint £600



VX_GRA_27710

Moonstone Grey (G4o)**
Two-coat metallic paint £600



VX_GRA_27711

Diamond Black (G7o)**
Two-coat metallic paint £600



VX_GRA_27712

Dark Ruby Red (GDU)**
Two-coat premium paint £710



VX_GRA_27714

Topaz Blue (G8Z)**
Two-coat premium paint £710



VX_GRA_27716

Pearl White (G1o)**
Tri-coat premium paint £870







VX_GRA_27717

The colours reproduced may vary slightly from the actual paint colour. As a result they should be used as a guide only. Your Vauxhall Retailer has a comprehensive display of our paint samples.

*Standard exterior paint. **Optional at extra cost including VAT.

Please note, model shown for colour illustrative purposes only.

Wheels and Tyres

							Hybrid models			
		SE Premium	Business Edition Nav	SRi Nav	Griffin Edition	Elite Nav	Ultimate	Business Edition Nav	Business Edition Nav Premium	Elite Nav
 VX_GRA_27742_RSB	17-inch 5-twin spoke silver-effect alloy wheels • 215/65 R 17 tyres • Emergency tyre inflation kit (in lieu of spare wheel)	●	●							
 VX_GRA_31584_RT1	18-inch 5-spoke high gloss black alloy wheel • 225/55 R 18 tyres • Emergency tyre inflation kit (in lieu of spare wheel)			●						
 VX_GRA_27747_RQK	18-inch 5-spoke diamond-cut bi-colour alloy wheels • 225/55 R 18 tyres • Emergency tyre inflation kit (in lieu of spare wheel)				●					
 VX_GRA_27744_RSZ	18-inch 5-spoke silver-effect alloy wheels • 225/55 R 18 tyres • Emergency tyre inflation kit (in lieu of spare wheel)							●		
 VX_GRA_30925_RBM	19-inch diamond-cut multi-spoke bi-colour alloy wheels • 235/50 R 19 tyres • Emergency tyre inflation kit (in lieu of spare wheel)					●	●		●	●
Provision for spare wheel fitment (spare wheel is Retailer-fit)		£20*	£20*	£20*	£20*	£20*	£20*			

*Optional at extra cost including VAT.

Petrol Engines

	1.2 (130PS) Turbo	1.6 (180PS) Turbo automatic
Capacity	1199cc	1599cc
Maximum power	130PS (96kW) @ 5500rpm	180PS (134kW) @ 5500rpm
Maximum torque	230Nm (169 lb.ft.) @ 1750rpm	250Nm (184 lb.ft.) @ 1650rpm
Configuration	3 cylinders, 4 valves per cylinder, double overhead camshafts	4 cylinders, 4 valves per cylinder, double overhead camshafts
Fuel/induction system	Turbocharger. Variable Valve Timing. Common rail direct injection	Turbocharger. Variable Valve Timing. Common rail direct injection
Emission compliance	Euro 6d	Euro 6d
Service interval	16,000 miles or 1 year (whichever occurs sooner)	16,000 miles or 1 year (whichever occurs sooner)

Diesel Engine

	1.5 (130PS) Turbo D
Capacity	1499cc
Maximum power	130PS (96kW) @ 3750rpm
Maximum torque	300Nm (221 lb.ft.) @ 1750rpm
Configuration	4 cylinders, 4 valves per cylinder, double overhead camshafts
Fuel/induction system	Turbocharger with intercooler. Common rail direct injection
Emission compliance	Euro 6d Diesel Particulate Filter
Service interval	20,000 miles or 1 year (whichever occurs sooner)

Petrol Engines

	1.6 (225hp) Direct Injection Turbo/Electric FWD	1.6 (300hp) Direct Injection Turbo/Electric AWD
Maximum power	180hp (133kW) @ 6000rpm	200hp (147kW) @ 6000rpm
Combined power output	225hp (165kW)	300hp (221kW)
Maximum torque	300Nm (221 lb.ft.) @ 3000rpm	300Nm (221 lb.ft.) @ 3000rpm
Combined torque	360Nm (265lb.ft.)	520Nm (383lb.ft.)
Combined CO₂ emissions (WLTP)#	31g/km	29g/km
Combined fuel economy (WLTP)#	192 mpg (1.5 l/100km)	204 mpg (1.4 l/100km)
Maximum speed/electric only	140/84 mph	146/84 mph
0-60mph	8.6 secs	5.9 secs
Configuration	4 cylinders, 4 valves per cylinder, double overhead camshafts	4 cylinders, 4 valves per cylinder, double overhead camshafts
Fuel/induction system	Turbocharger. Variable Valve Timing. Common rail direct injection	Turbocharger. Variable Valve Timing. Common rail direct injection
Emission compliance	Euro 6d	Euro 6d

These figures were obtained using a combination of battery power and fuel. The Grandland X Hybrid is a plug-in hybrid vehicle requiring mains electricity for charging.

#WLTP Figures shown are for comparison purposes and should only be compared to the fuel consumption, CO₂ values and electric range of other cars tested to the same technical standard. The fuel consumption and electric range achieved, and CO₂ produced, in real world conditions will depend upon a number of factors including, but not limited to: the accessories fitted (pre and post registration); charging frequency; battery condition; variations in weather; driving styles and vehicle load. For more information contact your local Vauxhall Retailer.

Electric Motors

	Electric motor FWD	Electric motor AWD
Maximum power – front axle	110hp (81.2kW) @ 2500rpm	110hp (81.2kW) @ 2500rpm
Maximum power – rear axle	-	113hp (83kW) @ 14000rpm
Maximum torque – front axle	320Nm (236lb.ft.) @ 500-2500rpm	320Nm (236lb.ft.) @ 500-2500rpm
Maximum torque – rear axle	-	166Nm (122lb.ft.) @ 0-4760rpm
Autonomy (Electric-only range)#	34 miles (WLTP)	35 miles (WLTP)
Battery capacity	13.2kWh	13.2kWh
Electric energy consumption (Combined)	16.1kWh/100km (WLTP)	15.9kWh/100km (WLTP)
Charging times – Standard cable (Mode 3)	3h 30min @ 3.7kW (16A)	3h 30min @ 3.7kW (16A)
Charging times – Optional on-board charger	1h 45min @ 7.4kW (32A)	1h 45min @ 7.4kW (32A)

These figures were obtained using a combination of battery power and fuel. The Grandland X Hybrid is a plug-in hybrid vehicle requiring mains electricity for charging.

#WLTP Figures shown are for comparison purposes and should only be compared to the fuel consumption, CO₂ values and electric range of other cars tested to the same technical standard. The fuel consumption and electric range achieved, and CO₂ produced, in real world conditions will depend upon a number of factors including, but not limited to: the accessories fitted (pre and post registration); charging frequency; battery condition; variations in weather; driving styles and vehicle load. For more information contact your local Vauxhall Retailer.

Performance, Fuel Economy and Emissions

	Performance (manufacturer's figures)		Fuel economy mpg (litres/100km) [#]		CO ₂ emissions g/km [#]		Vehicle Excise Duty*		BiK rates from – 2021/22 tax year
	Maximum speed (mph)	Acceleration 0–60mph (sec)	Combined Low	Combined High	Combined Low	Combined High	First year rate	Standard rate	
1.2 (130PS) Turbo	117	9.5	44.8 (6.3)	45.6 (6.2)	140	142	£220	£155	32%
1.2 (130PS) Turbo auto	122	9.8	43.4 (6.5)	44.1 (6.4)	146	148	£220	£155	33%
1.6 (180PS) Turbo auto	137	8.3	40.4 (7.0)	40.9 (6.9)	156	157	£555	£155	35%
1.5 (130PS) Turbo D	119	10.2	56.5 (5.0)	57.7 (4.9)	129	131	£180	£155	29%
1.5 (130PS) Turbo D auto	119	9.9	53.3 (5.3)	54.3 (5.2)	136	138	£220	£155	31%

Weights and Towing Data^{kg}

	Gross vehicle weight	Maximum towing weights Trailer with brakes (without brakes)
1.2 (130PS) Turbo	1900	1400 (685)
1.2 (130PS) Turbo auto	2000	1300 (696)
1.6 (180PS) Turbo auto	2000	1600 (700)
1.5 (130PS) Turbo D	2000	1500 (715)
1.5 (130PS) Turbo D auto	2000	1300 (727)

[#]Figures shown are for comparison purposes and should only be compared to the fuel consumption and CO₂ values of other cars tested to the same technical standard. The fuel consumption achieved, and CO₂ produced, in real world conditions will depend upon a number of factors including, but not limited to: the accessories fitted (pre and post registration); variations in weather; driving styles and vehicle load. The WLTP (Worldwide Harmonised Light Vehicles Test Procedure) is used to measure fuel consumption and CO₂ figures. The CO₂ figures display a range to reflect the highest value for the highest emitting version with all available options added, through to a minimum value to represent the lowest emitting version in standard specification.

*Correct at time of publication.

Please note: Gross vehicle weight is the total permissible weight of the vehicle including passengers and their luggage. The **maximum roof rack loading** should not exceed 70kg. The **maximum towing weights** are based on the ability of the car, with two occupants of 75kg each, to restart on a 12% gradient, which is approximately 1 in 8.3, at sea level. The permitted trailer load applies up to the specified incline and up to an altitude of 1000 metres above sea level. The permissible gross train weight decreases by 10% for every 1000 metres of additional altitude. At altitudes above 1500 metres, the engine output may drop with a corresponding reduction in towing capability. Any extra weight, such as luggage or additional passengers, should be deducted from the maximum towing weight. With a trailer fully loaded, **maximum noseweight** should not exceed 75kg. Always fit Vauxhall towing attachments and accessories available from your Vauxhall Retailer. They are designed specifically for Vauxhall models and carry a 12-month guarantee. During trailer towing do not exceed a maximum speed of 60mph. This speed limit is also applicable in countries with higher permitted speeds for trailer-vehicle combinations. Pay attention to the local speed limits. For trailers with low driving stability and caravans the use of an oscillation damper is strongly recommended.

Specifications

Start/Stop technology

Grandland X's Start/Stop system, fitted as standard to all models, offers real benefits by improving fuel economy and reducing CO₂ emissions, particularly in town. It does this by automatically stopping the engine when you come to a standstill, and then restarting as you prepare to move off.

Before automatically stopping the engine a number of system checks are carried out to ensure that it is both safe and practical to do so. To ensure safety, the driver must depress the clutch pedal, shift in to neutral, and then release the clutch pedal. System checks carried out before Auto Stop activates include:

- Start/Stop system is not manually deactivated via the facia button
- Sufficient brake vacuum is available to prevent the car rolling down an incline
- Battery is in good condition and charged
- Outside air temperature and engine temperature are above specified minima
- Electronic climate control (where fitted) is not in maximum heating or maximum cooling mode
- Self-cleaning function of the diesel particulate filter is not active

If all of these conditions are satisfied then the vehicle will Auto Stop.

When you are ready to pull away from standstill, Auto Restart is activated by depressing the clutch pedal.

Whilst at a standstill the vehicle is continually monitored. If necessary, the engine will automatically be restarted. Conditions that would initiate an Auto Restart include:

- Low battery level
- Brake vacuum below specified minimum
- Start/Stop system is manually deactivated
- Stationary for 5.5 minutes

Fuel tank capacity

- 53 litres (11.6 gallons)

AdBlue[®] tank capacity

- 17 litres (3.7 gallons)

Transmissions

Six-speed manual gearbox

Standard on all models.

Eight-speed automatic transmission

Available at extra cost on all models.

Steering

- Speed-sensitive electric power-assisted steering

Suspension

Front: Independent. Decoupled MacPherson struts with gas-pressure dampers and coil springs.

Anti-roll bar.

Rear: Compound crank with coil springs and gas-pressure dampers.

Braking and stability

- Switchable Electronic Stability Programme (ESP)
- Anti-lock Braking System (ABS)
- Corner stability control
- Traction control
- Hill start assist
- Hydraulic brake assist
- Electronic brakeforce distribution

All models

Front ventilated discs: 304mm diameter

Rear discs: 268mm diameter

Hybrid Specifications

Electrified Transmission

The 8-speed electrified transmission system is standard and offers both smooth transition between gears. The 8-speed electrified gearbox includes the following content:

- Multi-disc wet clutch replaces removed torque converter
- Permanent electric motor that transforms electric energy into mechanical drive energy
- Electric motor installed into the gearbox and petrol engine
- Comes with intuitive and stylish Automatic gearbox with electric shifter with shift paddles

Drive Mode Selector

The Drive Mode selector is positioned next to the Automatic gearbox with electric shifter and enables drivers to select one of the following:

- Hybrid is the default mode and offers the best of both worlds between controlled fuel consumption and on-road performance
- On Hybrid4 models AWD activates the engine and electric engine to provide AWD and improve grip on rough surfaces
- Sport Mode, draws on the combined power of the engine and motor for a more dynamic drive
- Electric activates the electric engine only, for zero CO₂ emissions and complete silence

All-Wheel Drive Electrified Rear Axle

The Electrified Rear Axle is exclusive on the Hybrid4 AWD drivetrain and includes the following:

- Additional power of 80 kW and torque boost of 166 Nm for 10 seconds
- Contains an electric motor, inverter and reducer
- Rear axle cross member modified by an electrified multi-arm axle

Fuel tank capacity

- 43 litres (9.4 gallons)

Weights

- Kerbweight FWD: 1735kg
- Kerbweight AWD: 1800kg
- Maximum towing weight FWD/AWD:
Braked trailer 1250kg (without brakes 600kg)

Charging

- Grandland X Hybrid range comes fitted with a Mode 3, 7.4kW cable and a 3.3kW on-board charger as standard. Includes cable bag at no extra cost.
- A 7.4kW on-board charger can be purchased as an option for £500 inc VAT.

This option halves the vehicle charging time when charging with a 7kW wallbox.

Please note: A Mode 2 cable (standard UK socket*) would charge the vehicle in less than 8 hours.

Grandland X Hybrid range charging time examples are listed showing times dependant on the various powers of charge point which the vehicle is plugged into.



VX_GRA_PHEV_29853

On-board charger	Charge point		
	3.7kW AC (1 Phase)	7kW AC (1 Phase)	11kW AC (3 Phase)
3.3kW (1 phase) – Standard	3 ½ hours	3 ½ hours	3 ½ hours
7.4kW (1 phase) – Optional	3 ½ hours	1 ¾ hours	3 ½ hours

Preliminary data determined according to WLTP test procedure methodology. EG type approval and Certificate of Conformity are not yet available. Preliminary values may differ from official final type approval data. Charging rate depends on power source and charging cable used.

*Only use a domestic electrical socket that has been checked by a qualified electrician and is protected by a circuit breaker adapted to the amperage of the electrical circuit.

Dimensions and Capacities All measurements in mm (inches) unless stated otherwise.

VX_GRA_PHEV_30743



VX_GRA_PHEV_30744

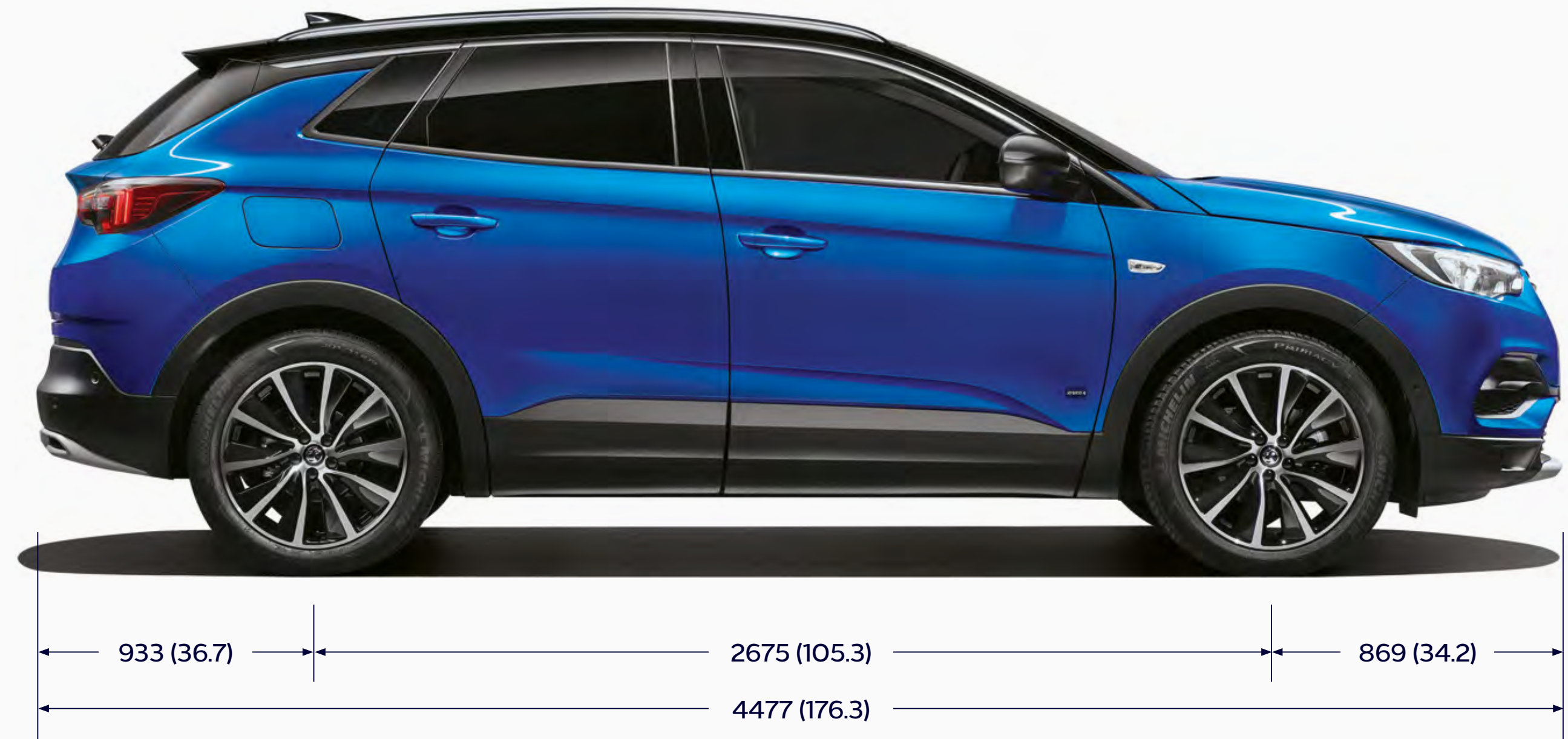

Loadspace Dimensions	Petrol/Diesel	Hybrid range
Maximum length (behind rear seats)	873 (34.4)	873 (34.4)
Maximum length (rear seats folded)	1696 (66.8)	1696 (66.8)
Maximum width	1053 (41.5)	1053 (41.5)
Maximum height	866 (34.1)	866 (34.1)

Luggage Capacities* Litres (cu.ft.)	Petrol/Diesel	Hybrid range
Rear seats up (under luggage compartment cover)	514 (18.1)	390 (13.7)
Rear seats folded (to roof)	1652 (58.3)	1528 (53.9)

*Measured using the ECIE method.

Accessories

Safety	Total (inc. VAT)	Protection	Total (inc. VAT)	Comfort	Total (inc. VAT)	Transport solutions	Total (inc. VAT)
Spare wheel kit with 18-inch emergency wheel and tool kit ^{1,2}	£193	Vertical cargo net	£27	FlexConnect bracket	£20	Roof base carrier (set of 2 bars) ⁵	
Side steps	£614	Dog guard	£227	FlexConnect hook	£27	- Without roof rails	£237
Philips ADR620 dash cam	£109	Front and rear splash guards	£113	FlexConnect coat hanger	£40	- With roof rails	£169
Front parking sensors	£406	Accessories for petrol/diesel models		FlexConnect folding table	£65	Roof carriers (requires base carrier)	
Rear parking sensors	£446	Floor mats (set of 4)		FlexConnect iPad mini holder	£93	Roof box – Thule Ocean 80	£164
Rear view camera ²	£373	- Carpet	£38	FlexConnect iPad holder	£103	Roof box – Thule Ocean 200	£374
Vehicle alarm system kit	£497	- Velour	£89	FlexConnect iPad Air holder	£103	Roof box – Thule Touring 200	£428
Child seats ³		- Rubber	£49	FlexConnect Samsung Galaxy holder	£93	Roof box – Thule Touring 700	£492
- Age group 0 (approx. 24 months/ up to 13kg)	£182	Boot mat	£132	Privacy shades for rear and side rear windows (set of 4)	£132	Roof box – Thule Motion 800	from £426
- ISOFIX base for age group 0 ⁴	£230	Boot tray	£71	Cup holder insert		Bike carrier – Thule FreeRide 532	£81
- Age group 1 (approx. 1-3.5 years/9-18kg)	£510	Accessories for Hybrid models		- Miscellaneous	£9	Bike carrier – Thule Expert 298	£134
- Age group 2/3 (approx. 3-12 years/ 15-36kg)	£186	Floor mats (set of 4)		- Pen	£15	Surfboard carrier – Thule 833	£82
Safety Pack – first aid kit, hi-vis vest and small warning triangle	£16	- Carpet	£40	- Notepad	£15	Ski/snowboard carrier	
Warning triangle	£9	- Velour	£73	Smoker's kit	£52	- Thule Snow Pack 7324 (4 x pairs)	£143
Hi-vis safety vest – adult	£4	- Rubber	£54	Fragrance diffuser	£23	Ski/snowboard carrier	
Hi-vis safety vest – child 3-6 years (42cm)	£4	Boot mat	£119	Fragrance cartridge (various)	£18	- Thule Snow Pack 7326 (6 x pairs)	£258
Hi-vis safety vest – child 7-12 years (52cm)	£4	Boot tray	£76			Towing	
First aid kit	£15	Style				Swan's neck towing ball	
Emergency seat belt cutter and hammer	£18	Door sills				- Petrol/diesel models	£295
Fire extinguisher (1kg) with strap	£32	- Front	£40			Tow bar with tow ball (removable without tools)	
Bracket for fire extinguisher	£49	- Rear	£67			- Petrol/diesel models	£424
Spare bulb kit – 11 x high-quality bulbs and 7 x fuses from Philips	£69	Sport pedal covers				- Hybrid models	£567
		- Manual	£71			13-pin to 7-pin adapter	£29
		- Automatic	£60				

Please note: Prices shown are fully fitted and painted, where applicable and include VAT. Please check with your local Vauxhall Retailer for details. It is advisable to ensure your insurance policy is adequate to cover additional fitted accessories. Prices correct at time of publication.

¹Vehicle must be ordered with spare wheel fixing option (T7Y) in order to accommodate the spare wheel. ²Petrol and diesel models only. ³Restrictions apply to the use of child seats, please consult your vehicle user manual or Vauxhall Retailer. ⁴Restricted to rear seat usage only for vehicles with transponder deactivation of passenger airbag. ⁵A dedicated T-Track adapter (Thule 697-4 or Thule 697-6) is required for the installation of specific roof boxes, contact your local Vauxhall Retailer for details.

Company Car Driver and Fleet Information

Benefit in kind company car taxation*

The car benefit charge will be the car's list price (including VAT, options and accessories fitted, delivery to Retailer and number plates, but excluding Vehicle Excise Duty and new vehicle first registration fee) multiplied by the percentage charge for the CO₂ emissions band in which the car falls (see table opposite). Multiply this figure by your personal income tax rate (20%** for Basic Rate, 40%** for Higher Rate) to calculate your annual benefit in kind tax liability.

Example:

Grandland X Business Edition Nav 1.5 (130PS) Turbo D (CO₂ emissions 130g/km)

On-the-road RRP	£25,815.00
Deduct: Vehicle Excise Duty	(£180.00)
New vehicle first registration fee	(£55.00)
Effective list price	£25,580.00
Add: Optional two-coat metallic paint	£600.00
List price for tax purposes (P11D value)	£26,180.00
Car benefit charge 2021-22 tax year (30%)	£7,854.00
Benefit in kind tax liability (2021-22 tax year)	
Basic Rate (20%) tax payer	£1,570.80
Higher Rate (40%) tax payer	£3,141.60

*Please note this Price Guide provides taxation information as a guide only. Vauxhall does not provide taxation guidance. Drivers should always take professional advice on their own tax position.
**Excludes residents of Scotland.

BiK for Scottish Residents

Effective 6 April 2018 the Scottish Government have introduced their own BiK taxation structure. This only applies to Company Car Drivers that are Scottish taxpayers. HMRC will determine whether or not an individual is a Scottish taxpayer based on where their main place of residence is.

The BiK rates for Scotland are:

- Over £12,570-£14,667 Starter Rate 19%
- Over £14,667-£25,296 Basic Rate 20%
- Over £25,296-£43,662 Intermediate Rate 21%
- Over £43,662-£150,000 Higher Rate 41%
- Above £150,000 Top Rate 46%

CO ₂ emissions (g/km)	Percentage of cars price to be taxed 2021-22 tax year
Up to 50	13%
51-54	14%
55-59	15%
60-64	16%
65-69	17%
70-74	18%
75-79	19%
80-84	20%
85-89	21%
90-94	22%
95-99	23%
100-104	24%
105-109	25%
110-114	26%
115-119	27%
120-124	28%
125-129	29%
130-134	30%
135-139	31%
140-144	32%
145-149	33%
150-154	34%
155-159	35%
160-164	36%
165-169	37%
170+	37%

CO ₂ emissions (g/km)	Electric range (miles)	Percentage of cars price to be taxed 2021-22 tax year
0	-	1%
1-50	130+	1%
1-50	70-129	4%
1-50	40-69	7%
1-50	30-39	11%
1-50	<30	13%

To calculate your own personal liability, search: **Vauxhall BiK**, or click the link below: [Vauxhall BiK Tool](#)

Company Car Driver Free 3 Day Test Drive

Our free[†] 3 Day Test Drive programme is open to all Company Car Drivers which allows you to choose any model in the current Vauxhall line-up (exclusions apply). With full insurance cover provided, it gives you a meaningful length of time to make an informed decision about your next company car.

Search Vauxhall 3DTD to book your free[†] test drive or click the link the below: [Vauxhall 3 Day Test Drive](#)

[†]The free 3 Day Test Drive programme is open to Company Car Drivers and Fleet Decision Makers. Available for UK Mainland only. Terms and conditions apply. Full terms and conditions can be found at vauxhallfleet.co.uk/testdrive/index/terms.

Fleet Toolbox

Discover the facts in our online Toolbox for both Company Car Drivers and Fleet Decision Makers. The Fleet Toolbox has a host of useful calculators, comparators, interactive listings and information. Search Vauxhall Fleet Tools or click the link below: [Vauxhall Fleet Tool Box](#)

Contact Vauxhall Fleet

Please contact one of our dedicated sales teams who will be happy to help with your particular enquiry.

Company Car Drivers

Call: 0345 111 2020

Email: company-car@vauxhallinfo.co.uk

Telephone lines are open

- Monday to Friday 8:00am-9:00pm
- Saturday and Sunday 9:00am-6:00pm

Fleet Decision Makers

Depending on the size of your fleet of vehicles, we have a dedicated team to handle your enquiries. The lines are open Monday to Friday excluding Bank Holidays.

1-24 vehicles

Call: 0845 076 2254 (8:30am-5:00pm)

25+ vehicles

Call: 0330 587 8222 (8:30am-5:00pm)

Email: vauxhallfleet@vauxhall.co.uk

Special Vehicles (Police, Fire and Ambulance)

Call: 01582 409999 (8:30am-5:00pm)

Email: vauxhallspecialvehicles@vauxhall.co.uk

For more information visit www.vauxhall.co.uk/fleet

Further Information

On-the-road prices

To eliminate uncertainty about hidden costs when buying a new car, Vauxhall publishes on-the-road recommended retail prices (RRP) and these are shown in the pricing tables within this price guide. These prices include VAT, number plates and delivery to Retailer of £700.00 (including £116.67 VAT), 12 months' Government Vehicle Excise Duty (see opposite for details) and the DVLA new vehicle first registration fee of £55.00.*

Please note: The on-the-road recommended retail price (RRP) does not include fuel supplied by the Retailer, motor insurance or any other goods or services supplied by agreement between the Retailer and the customer.

Price protection

Order a new Vauxhall for build in the current model year (as confirmed by your Retailer) for delivery no more than three months in advance and the price you are quoted is the price you pay. This is irrespective of any subsequent price rises between placing your order and delivery of your new car, but you must take delivery as soon as the car is available.

Please note: Price protection does not apply to electric/hybrid models. Vauxhall Motors Limited is not liable for price adjustments caused by Government changes in the rate of VAT (currently 20%), Vehicle Excise Duty, DVLA new vehicle first registration fee or by any other applicable legislation or regulations.

In the event of an accident

Vauxhall Accident Management helps keep you mobile following an accident. Benefits include vehicle recovery, Vauxhall-approved repairs and contacting your insurer. For more details, visit www.vauxhall.co.uk/AccidentManagement

Free2Move Lease

Whether you're a big company or a small business looking for vehicle financing, Free2Move Lease, our business finance specialists, can deliver exactly what you need.

Free2Move Lease is one of the UK's largest leasing companies and is also a member of the British Vehicle Rental and Leasing Association (BVRLA).

With over 60,000 vehicles in the Free2Move Lease portfolio, Free2Move Lease is able to offer competitive vehicle solutions. In addition, Free2Move Lease also offer innovative connected management of servicing and maintenance.

For further information, please contact your local Vauxhall Retailer or visit www.vauxhall.co.uk/offers-finance/business-leasing.html

Vehicle Excise Duty

The amount of Vehicle Excise Duty (road fund licence) payable on new cars varies depending on the level of carbon dioxide (CO₂) emissions produced by the vehicle. CO₂ emissions are measured in grams per kilometre (g/km) travelled and divided into 13 charging bands shown in the table opposite.

A 'first year rate' of Vehicle Excise Duty is payable on all new cars and in subsequent years the amount payable reverts to the 'standard rate'. From 1 April 2017 the breakpoints for each of these bands have been revised. Also, for vehicles with a list price over £40,000, including factory-fitted options, an additional £335 is payable for the first five years of standard rate payments.

Vehicle Excise Duty*

Band	CO ₂ emissions in grams per kilometre	First year rate Petrol/Diesel	Standard rate Petrol/Diesel	Standard rate Electric
A	0	£0	£0	£0
B	1-50	£10	£155	£0
C	51-75	£25	£155	£0
D	76-90	£115	£155	£0
E	91-100	£140	£155	£0
F	101-110	£160	£155	£0
G	111-130	£180	£155	£0
H	131-150	£220	£155	£0
I	151-170	£555	£155	£0
J	171-190	£895	£155	£0
K	191-225	£1,345	£155	£0
L	226-255	£1,910	£155	£0
M	Over 255	£2,245	£155	£0

*Correct at time of issue.

Further Information

Customer Care Commitment

For added peace of mind, Vauxhall has an innovative Customer Care Commitment that offers the following:

- Three-year vehicle warranty consisting of a one-year/unlimited mileage manufacturer's warranty and a second and third year manufacturer's warranty with a 60,000 miles limitation
- Vauxhall Assistance for 12 months from first registration
- Six years' body panel anti-perforation warranty

Please note: Warranty is only available on vehicles sourced from Vauxhall Motors Limited. Terms and conditions apply – please see your Vauxhall Retailer for details.

Vauxhall Assistance

Vauxhall Assistance is provided automatically with every new Vauxhall for 12 months from first registration and covers everything from accident assistance, roadside recovery and 'at home' service to flat tyres. For even more peace of mind, on the Grandland X Hybrid range the cover is extended* to 8 years or 100,000 miles, whichever comes first. Even more reason for you to stay calm and let us take care of everything should the need arise. With Vauxhall Assistance help is literally just a free** phone call away, 24 hours a day, 365 days a year!

Protecting the environment

Vauxhall's commitment to the environment is demonstrated by our products' many environmental awards. For even more information on Vauxhall's efforts to achieve an environmentally sustainable future, and how to dispose of your end-of-life vehicle, see www.vauxhall.co.uk/recycling

Vauxhall Care

This all-inclusive service package is available on Vauxhalls under 10 months old (from date of first registration).

This package offers complete peace of mind for the first 3 years of your Vauxhall's life with fixed monthly payments for the plan duration.

- **3 years' Vauxhall servicing** – covers first, second and third annual services. Including a brake-fluid change in the second service
- **2 years' Vauxhall Roadside Assistance** – first year from us
- **First years' MOT[†]** – free of charge by your local Vauxhall Retailer

For full terms and conditions and to sign up, visit: vauxhall.co.uk/vauxhallcare

Vauxhall Service Club

Vauxhall Service Club is available for all Vauxhall owners, and it's free to join. Members benefit from the following:

- 15% off Vauxhall Approved Accessories
- Vauxhall's aged 2-3 Years = 15% off parts and labour
- Vauxhall's aged over 3 Years = 25% off parts and labour
- Half price MOT's (NI excluded)
- Free pre-MOT test inspection (NI only)
- Fixed price AdBlue® Refills
 - Car = £14.99
 - Van = £24.99
- Access to the Vauxhall Accident Management Programme
- Online service booking available 24/7 with servicing appointments available within 3 days – [Book Online](#)
- Collection and delivery/onward mobility options
- Complimentary 'Wash and Vac' with all routine services^{††}
- Vauxhall trained technicians
- Genuine Vauxhall parts
- Minimum 12 months warranty on parts and labour
- Regular newsletters with exclusive offers, discounts and competitions

Terms and conditions apply. To join visit: vauxhall.co.uk/serviceclub

Vauxhall Insurance with added reassurance

Comprehensive cover – Summary of benefits

- Competitive premiums
- Repairs by a Vauxhall-trained technician
- Genuine Vauxhall parts, guaranteed for five years when we repair your car within our Approved Repairer Network
- Free courtesy car as standard when using an Approved Repairer[‡]
- 24 hour claims helpline
- Personal Accident benefit
- Cover for audio equipment
- Windscreen cover

Call for a quote on 0330 678 1130^{‡‡}

For more product information

For further information on the Vauxhall range or location of your nearest Vauxhall Retailer please call 0345 600 1500. Alternatively, details can be found on our website at vauxhall.co.uk

For more information call **0345 600 1500**

For Fleet enquiries call **0330 587 8222**

Discover the full Vauxhall range at **[vauxhall.co.uk](https://www.vauxhall.co.uk)**

Join us online

The invoice price, including delivery to Retailer, factory-fitted options, accessories fitted by the Retailer and number plates, is subject to VAT. Some feature descriptions in this guide may refer to, and some illustrations may show, optional equipment not included in the standard delivery. The information contained in this guide was accurate at the time of publication. We reserve the right to make changes in design and equipment. Please note that Vauxhall Retailers are not the agents of Vauxhall Motors Limited and are not authorised to bind Vauxhall Motors Limited by any specific or implied undertaking or representation. It is advisable to ensure that your motor insurance policy provides adequate cover for additional fitted options and accessories. The colours in this guide are only approximate actual colours. Illustrated optional equipment is available at extra charge. Availability, technical features and equipment provided on our vehicles can vary by model. For precise information on the equipment provided on our vehicles, please contact your local Vauxhall Retailer.

VAUXHALL

Price and Specification Guide
11 May 2021 | Model Year 2021C/22A



Combo Life

Including Combo-e Range (MY2022A)

Contents

To find the information you want use the links below to navigate around the guide:

[Choose your Trim Level](#)

[Range Highlights](#)

[Models](#)

[Prices](#)

[Features/Options](#)

[Infotainment](#)

[Interior Style and Comfort](#)

[Exterior Colours](#)

[Wheels and Tyres](#)

[Engines and Technical Data](#)

[Performance, Economy and Emissions](#)

[Specifications](#)

[Dimensions and Capacities](#)

[Accessories](#)

[Company Car Information](#)

[Further Information](#)

Choose Your Trim Level

Edition



VX_COM_31958

First up in the range is the Combo Life Edition, which is packed with plenty of practical features as standard. Choose from 5- or 7-seats.

SE



VX_COM_e_31961

The Combo-e Life SE is fully-electric that's heavy on features but light on your pocket. It's available with a choice of two lengths and 5- or 7-seats

SE models even come in your choice of lengths with either petrol automatic or diesel models.

Elite



VX_COM_31959

Combo Life Elite completes the range, with a little more exterior style and extra comfort features. Again, you can choose from 5- or 7-seats.

Combo Life Range Highlights

Edition

Standard features include:

- Multimedia system
 - 8-inch colour touchscreen
 - AM/FM/DAB digital radio
 - Bluetooth®
 - Apple CarPlay/Android Auto™
 - Front USB connection
- Six speakers
- 3.5-inch colour instrument display
- 60/40 split-folding rear seat back
- Air conditioning
- Steering wheel mounted audio controls
- Height-adjustable driver's seat
- Chrome-effect interior door handles
- Luggage compartment cover
- Electrically adjustable/heated door mirrors
- Electrically operated front windows
- Nearside and offside sliding side-access door with opening windows
- Daytime running lights
- Tailgate with heated rear window and wiper
- Body-colour front and rear bumpers
- Side-protection mouldings
- Emergency tyre inflation kit
- Front fog lights
- Body-colour exterior door handles and side-access door rail covers
- Rear parking distance sensors
- Automatic emergency braking with pedestrian detection
- Electronic stability programme with traction control
- Forward collision alert
- Lane departure warning with lane keep assist
- Automatic lighting control
- Cruise control with speed limiter
- Speed sign recognition
- Six airbags
- Driver drowsiness system
- Tyre pressure monitoring system

Edition 7-seat

7-seat models additionally feature:

- Two individual split-folding and removable third-row seats
- Sliding facility for third-row seats (XL models only)

Combo-e Life SE/SE

Features over Edition models:

- Chrome-effect instrument rings
- Leather-covered steering wheel
- Fold-flat front passenger seat with armrest
- Front-seat back pockets
- Two foldable tables with cupholders
- Body-colour door mirrors
- Body-colour side-protection mouldings
- 16-inch alloy wheels
- Rain-sensitive windscreen wipers
- High beam assist
- Electrically operated rear windows
- Electrically foldable door mirrors
- Dark-tinted rear windows
- Panoramic rear-view camera
- LED daytime running lights
- Opening tailgate window
- Vauxhall Connect (electric models only)
- Keyless entry (petrol automatic models only)

Combo-e Life SE/SE 7-seat

Elite

Features over SE models:

- Multimedia Navi Pro system
 - Satellite navigation
- Dual-zone electronic climate control
- 35/30/35 split-folding second-row seats with fold-flat facility
- Alloy-effect protective front skid plate
- Roof rails
- 17-inch alloy wheels
- Onyx black door mirrors
- Side blind spot alert
- Front and rear parking distance sensors
- Luggage restraint net

Elite 7-seat

Combo-e Life SE



VX_COM_e_31978

SE

OTR from £31,610*

Infotainment:

- Multimedia system
 - 8-inch colour touchscreen
 - DAB digital radio
 - Bluetooth®
 - Apple CarPlay/Android Auto™
 - Front USB connection
- Six speakers
- Vauxhall Connect

Interior convenience/styling:

- 3.5-inch colour instrument display
- Height-adjustable driver's seat
- Air conditioning
- Steering wheel mounted audio controls
- 60/40 split-folding rear seat back
- Chrome-effect interior door handles
- Luggage compartment cover
- Chrome-effect instrument rings
- Leather-covered steering wheel
- Fold-flat front passenger seat with armrest
- Front-seat back pockets
- Two foldable tables with cupholders
- Electronic parking brake

Exterior convenience/styling:

- Nearside and offside sliding side-access door with opening windows
- Tailgate with opening heated rear window and wiper
- Body-colour front and rear bumpers
- Body-colour side protection mouldings
- Body-colour door handles and side-access door rail covers
- Body-colour door mirrors
- Front fog lights
- 16-inch alloy wheels
- Emergency tyre inflation kit

- Electrically adjustable/foldable/heated door mirrors
- Sight and Light Pack
 - Rain-sensitive windscreen wipers
 - High beam assist
- Electrically operated front and rear windows
- Dark-tinted rear windows
- Panoramic rear-view camera
- LED daytime running lights

Safety/security:

- Rear parking distance sensors
- Automatic emergency braking with pedestrian detection
- Electronic stability programme with traction control
- Anti-lock braking system
- Forward collision alert
- Emergency brake assist
- Lane departure warning with lane keep assist
- Automatic lighting control
- Cruise control with speed limiter
- Speed sign recognition
- Six airbags
- Driver drowsiness system
- Tyre pressure monitoring system

SE 7-seat

OTR from £32,110*

7-seat models additionally feature:

- Two individual split-folding and removable third-row seats
- Sliding facility for third-row seats (XL models only)

*Price shown is after allowing for PiCG (Plug-in Car Grant).

Combo Life Edition



Edition OTR from £22,815

Infotainment:

- Multimedia system
 - 8-inch colour touchscreen
 - DAB digital radio
 - Bluetooth®
 - Apple CarPlay/Android Auto™
 - Front USB connection
- Six speakers

Interior convenience/styling:

- 3.5-inch colour instrument display
- Height-adjustable driver's seat
- Air conditioning
- Steering wheel mounted audio controls
- 60/40 split-folding rear seat back
- Chrome-effect interior door handles
- Luggage compartment cover

Exterior convenience/styling:

- Electrically operated front windows with safety autoreverse and one-touch up/down facility
- Nearside and offside sliding side-access door with opening windows
- Daytime running lights
- Tailgate with heated rear window and wiper
- Body-colour front and rear bumpers
- Body-colour door handles and side-access door rail covers
- Front fog lights
- Side-protection mouldings
- 16-inch steel wheels
- Full-diameter wheel covers
- Emergency tyre inflation kit
- Electrically adjustable/heated door mirrors

Safety/security:

- Rear parking distance sensors
- Automatic emergency braking with pedestrian detection
- Electronic stability programme with traction control
- Anti-lock braking system
- Forward collision alert
- Emergency brake assist
- Lane departure warning with lane keep assist
- Automatic lighting control
- Cruise control with speed limiter
- Speed sign recognition
- Six airbags
- Driver drowsiness system
- Tyre pressure monitoring system

Edition 7-seat OTR £24,750

7-seat models additionally feature:

- Two individual split-folding and removable third-row seats
- Sliding facility for third-row seats (XL models only)

Combo Life SE



VX_COM_31960

SE

OTR from £24,450

Infotainment:

- Multimedia system
 - 8-inch colour touchscreen
 - DAB digital radio – Bluetooth®
 - Apple CarPlay/Android Auto™
 - Front USB connection
- Six speakers

Interior convenience/styling:

- 3.5-inch colour instrument display
- Height-adjustable driver's seat
- Air conditioning
- Steering wheel mounted audio controls
- 60/40 split-folding rear seat back
- Chrome-effect interior door handles
- Luggage compartment cover
- Chrome-effect instrument rings
- Leather-covered steering wheel (heated on manual models)
- Fold-flat front passenger seat with armrest
- Front-seat back pockets
- Two foldable tables with cupholders
- Electronic parking brake (manual models only)

Exterior convenience/styling:

- Nearside and offside sliding side-access door with opening windows
- Tailgate with opening heated window and wash/wipe facility
- Body-colour front and rear bumpers
- Body-colour door handles and side-access door rail covers
- Body-colour door mirrors
- Body-colour side-protection mouldings
- Front fog lights
- 16-inch alloy wheels
- Emergency tyre inflation kit

- Sight and Light Pack
 - Rain-sensitive windscreen wipers
 - High beam assist
- Electrically operated front and rear windows
- Electrically adjustable/foldable/heated door mirrors
- Dark-tinted rear windows
- Panoramic rear-view camera
- LED daytime running lights

Safety/security:

- Rear parking distance sensors
- Automatic emergency braking with pedestrian detection
- Electronic stability programme with traction control
- Anti-lock braking system
- Forward collision alert
- Emergency brake assist
- Lane departure warning with lane keep assist
- Automatic lighting control
- Cruise control with speed limiter
- Speed sign recognition
- Six airbags
- Driver drowsiness system
- Tyre pressure monitoring system
- Keyless entry (automatic models only)

SE 7-seat

OTR from £24,950

7-seat models additionally feature:

- Two individual split-folding and removable third-row seats
- Sliding facility for third-row seats (XL models only)

Combo Life Elite



VX_COM_31959

Elite

OTR £28,260

Infotainment:

- Multimedia Navi Pro system
 - Satellite navigation
 - 8-inch colour touchscreen
 - DAB digital radio – Bluetooth®
 - Apple CarPlay/Android Auto™
 - Front USB connection
- Six speakers

Interior convenience/styling:

- 3.5-inch colour instrument display
- Height-adjustable driver's seat
- Dual-zone electronic climate control
- Steering wheel mounted audio controls
- Chrome-effect interior door handles
- Luggage compartment cover
- Chrome-effect instrument rings
- Leather-covered steering wheel
- Fold-flat front passenger seat with armrest
- Front-seat back pockets
- Two foldable tables with cupholders
- 35/30/35 split-folding second-row seats with fold-flat facility

Exterior convenience/styling:

- Nearside and offside sliding side-access door with opening windows
- Tailgate with opening heated window and wash/wipe facility
- Body-colour front and rear bumpers
- Body-colour door handles and side-access door rail covers
- Body-colour side-protection mouldings
- Front fog lights
- 17-inch alloy wheels
- Emergency tyre inflation kit
- Onyx black door mirrors

- Sight and Light Pack
 - Rain-sensitive windscreen wipers
 - High beam assist
- Electrically operated front and rear windows
- Electrically adjustable/foldable/heated door mirrors
- Dark-tinted rear windows
- LED daytime running lights
- Alloy-effect protective front skid plate
- Panoramic rear-view camera

Safety/security:

- Front and rear parking distance sensors
- Automatic emergency braking with pedestrian detection
- Electronic stability programme with traction control
- Anti-lock braking system
- Forward collision alert
- Emergency brake assist
- Lane departure warning with lane keep assist
- Automatic lighting control
- Cruise control with speed limiter
- Speed sign recognition
- Six airbags
- Driver drowsiness system
- Tyre pressure monitoring system
- Keyless entry • Side blind spot alert

Elite 7-seat

OTR from £28,760

7-seat models additionally feature:

- Two individual split-folding and removable third-row seats
- Sliding facility for third-row seats (XL models only)

Combo-e Life Prices

	Pack Code	Price (£)	VAT (£)	Total (£)	On-the-road RRP before PiCG (£)	On-the-road RRP after PiCG (£)	Financial Year 2021/22 BiK 20% (£)	WLTP Combined CO ₂ (g/km) - pack code	Insurance groups
SE (5-seat)									
100kW (136PS) auto - 50kWh battery	DS26 9EQW	27,795.83	5,559.17	33,355.00	34,110.00	31,610.00	5.67	0	tba
SE (7-seat)									
100kW (136PS) auto - 50kWh battery	DS26 9EQ1	28,212.50	5,642.50	33,855.00	34,610.00	32,110.00	5.75	0	tba
SE XL (7-seat)									
100kW (136PS) auto - 50kWh battery	DS26 9EQX	29,129.17	5,825.83	34,955.00	35,710.00	N/A*	5.93	0	tba

WLTP Combined CO₂ (g/km) figures are based on a configured vehicle as per pack code for UK with no options fitted.

Please note: On-the-road recommended retail prices (RRP) include number plates and delivery to Retailer of £700.00 (inc. £116.67 VAT), 12 months' Vehicle Excise Duty and new vehicle first registration fee of £55.00. Excludes fuel and insurance. Company Car Benefit in Kind (BiK) rates are monthly based on the standard paint price. Price has been calculated using manufacturer estimates and includes a £2,500.00 OZEV grant which has been deducted from the price of the vehicle (OZEV Grant not available in the Isle of Man). New Combo-e Life is expected to be a qualifying model for this grant subject to acceptance by OZEV. Please check with your Retailer for latest status. The grant is a government incentive and is subject to withdrawal prior to delivery of your vehicle. Retailers may be required to carry out more than one credit check during the course of the order process. You may be required to place a deposit when placing your order with your supplying Retailer. In the event of a price change, deposit refunds will be governed by your supplying Retailer's policy and as such must be discussed with the supplying Retailer.

New Combo-e Life is not covered by our Price Protection Guarantee. See 'Further Information' page for details.

*SE XL (7-seat) model is not eligible for the plug-in car grant.

Combo Life Prices

	Pack Code	Fuel Type	Price (£)	VAT (£)	Total (£)	On-the-road RRP (£)	Financial Year 2021/22 BiK 20% (£)	WLTP Combined CO ₂ (g/km) [#] – pack code	Insurance groups
Edition									
1.2 (110PS) Turbo	DL26 EQ6W	Petrol	18,200.00	3,640.00	21,840.00	22,815.00	123.97	145	9E
1.5 (100PS) Turbo D	DL26 HT6W	Diesel	18,366.67	3,673.33	22,040.00	23,015.00	117.48	135	10E
Edition XL									
1.2 (110PS) Turbo	DL26 EQ6Y	Petrol	18,950.00	3,790.00	22,740.00	23,715.00	128.92	146	9E
Edition XL (7-seat)									
1.2 (110PS) Turbo	DL26 EQ6X	Petrol	19,533.33	3,906.67	23,440.00	24,750.00	144.83	161	11E
SE									
1.2 (130PS) Turbo auto	DP26 EF8W	Petrol	21,312.50	4,262.50	25,575.00	26,885.00	148.88	153	11E
1.5 (100PS) Turbo D	DP26 HT6W	Diesel	19,562.50	3,912.50	23,475.00	24,450.00	124.90	137	11E
SE (7-seat)									
1.2 (130PS) Turbo auto	DP26 EF81	Petrol	21,729.17	4,345.83	26,075.00	27,385.00	156.18	157	11E
1.5 (100PS) Turbo D	DP26 HT61	Diesel	19,979.17	3,995.83	23,975.00	24,950.00	131.58	140	10E
SE XL									
1.5 (100PS) Turbo D	DP26 HT6Y	Diesel	20,312.50	4,062.50	24,375.00	25,350.00	129.55	138	10E
SE XL (7-seat)									
1.2 (130PS) Turbo auto	DP26 EF8X	Petrol	22,645.83	4,529.17	27,175.00	28,485.00	162.60	157	12E
1.5 (100PS) Turbo D	DP26 HT6X	Diesel	20,895.83	4,179.17	25,075.00	26,050.00	137.45	140	10E

Combo Life's petrol and diesel engines meet the Real Driving Emissions Step 2 (RDE2) standards.

WLTP Combined CO₂ (g/km) figures are based on a configured vehicle as per pack code for UK with no options fitted.

[#]Fuel consumption and CO₂ figures are determined according to the WLTP test cycle. CO₂ figures, BiK values and RRP pricing shown above are for a standard vehicle without any additional optional equipment. CO₂ figures are used to calculate Vehicle Excise Duty (VED) for the first registration of the vehicle and BiK. The addition of optional extras could increase the certified CO₂ emission output. This in turn may affect the amount of VED payable upon registration, and, for company car drivers, the P11D value and the amount of Benefit in Kind (BiK) tax payable. Figures shown are for comparison purposes and should only be compared to the fuel consumption and CO₂ values of other cars tested to the same technical standard. The fuel consumption achieved, and CO₂ produced, in real world conditions will depend upon a number of factors including, but not limited to: the accessories fitted (pre and post registration); variations in weather; driving styles and vehicle load. The WLTP (Worldwide Harmonised Light Vehicles Test Procedure) is used to measure fuel consumption and CO₂ figures. Full data relating to WLTP test cycles can be found at: www.vauxhall.co.uk/wltp

Please note: On-the-road recommended retail prices (RRP) include number plates and delivery to Retailer of £700.00 (inc. £116.67 VAT), 12 months' Vehicle Excise Duty and new vehicle first registration fee of £55.00. Excludes fuel and insurance. Company Car Benefit in Kind (BiK) rates are monthly based on the standard paint price.

Combo Life Prices

	Pack Code	Fuel Type	Price (£)	VAT (£)	Total (£)	On-the-road RRP (£)	Financial Year 2021/22 BiK 20% (£)	WLTP Combined CO ₂ (g/km) [#] – pack code	Insurance groups
Elite									
1.2 (130PS) Turbo auto	DN26 EF8W	Petrol	22,458.33	4,491.67	26,950.00	28,260.00	156.67	153	11E
Elite (7-seat)									
1.2 (130PS) Turbo auto	DN26 EF81	Petrol	22,875.00	4,575.00	27,450.00	28,760.00	164.20	157	12E
Elite XL (7-seat)									
1.2 (130PS) Turbo auto	DN26 EF8X	Petrol	23,791.67	4,758.33	28,550.00	29,860.00	170.62	157	14E

Combo Life's petrol and diesel engines meet the Real Driving Emissions Step 2 (RDE2) standards.

WLTP Combined CO₂ (g/km) figures are based on a configured vehicle as per pack code for UK with no options fitted.

[#]Fuel consumption and CO₂ figures are determined according to the WLTP test cycle. CO₂ figures, BiK values and RRP pricing shown above are for a standard vehicle without any additional optional equipment. CO₂ figures are used to calculate Vehicle Excise Duty (VED) for the first registration of the vehicle and BiK. The addition of optional extras could increase the certified CO₂ emission output. This in turn may affect the amount of VED payable upon registration, and, for company car drivers, the P11D value and the amount of Benefit in Kind (BiK) tax payable. Figures shown are for comparison purposes and should only be compared to the fuel consumption and CO₂ values of other cars tested to the same technical standard. The fuel consumption achieved, and CO₂ produced, in real world conditions will depend upon a number of factors including, but not limited to: the accessories fitted (pre and post registration); variations in weather; driving styles and vehicle load. The WLTP (Worldwide Harmonised Light Vehicles Test Procedure) is used to measure fuel consumption and CO₂ figures. Full data relating to WLTP test cycles can be found at: www.vauxhall.co.uk/wltp

Please note: On-the-road recommended retail prices (RRP) include number plates and delivery to Retailer of £700.00 (inc. £116.67 VAT), 12 months' Vehicle Excise Duty and new vehicle first registration fee of £55.00. Excludes fuel and insurance. Company Car Benefit in Kind (BiK) rates are monthly based on the standard paint price.

Safety

Standard Features – The following features are standard across the entire Combo Life range.

Airbags

- Driver's airbag
- Front passenger's airbag
- Two front seat side-impact airbags
- Full-size curtain airbags

Seating

- Three height adjustable rear seat head restraints

Seatbelts

- Lap and diagonal inertia-reel seatbelts
- 'Seatbelt unfastened' audible warning and warning light

Braking

- Automatic emergency braking – The system works automatically in conjunction with forward collision alert, at speeds between 3mph and 70mph, and detects both vehicles and pedestrians. If no avoiding action is taken by the driver, at speeds below 19mph the system automatically slows the vehicle to a full stop with emergency braking of 0.9g. At speeds from 19mph to 70mph it brakes automatically to reduce speed by a maximum of 30mph – to reduce speed even further the driver must brake themselves.

- Anti-lock Braking System (ABS)
- Electronic brakeforce distribution – Automatically apportions the optimum braking force to each wheel.
- Engine drag torque control – Improves directional stability by preventing the driven wheels from locking on slippery surfaces under the influence of engine braking.
- Hill start assist – Briefly maintains rear brake pressure to stop the vehicle rolling back on an incline.

Child safety

- Deactivation switch for front passenger's front and side-impact airbags
- ISOFIX child seat mountings incorporating top tether anchor points located on second-row rear seats (does not include child seat) – Allows ISOFIX child safety seats to be securely fixed into the car. The ISOFIX mounting system reduces forward movement in an accident and makes the child seat easier to install.
- Child-proof locks on rear doors

Stability

- Electronic Stability Programme (ESP) – ESP monitors many different inputs to determine when the car starts to lose traction, it can then immediately respond by varying the brake pressure between up to three wheels and adjust the engine output to help correct the loss of traction and improve stability.

Additional ESP features

- Traction control
- Cornering brake control
- Straight line stability control
- Drag torque control – Maintain stability on slippery roads when lifting off the accelerator or changing gear.

Tyre pressure

- Tyre pressure monitoring system



Automatic emergency braking.



ISOFIX child seat mountings.



Lane departure warning (see next page for feature description).

Driver Assistance

Standard Features – The following features are standard across the entire Combo Life range. Specific features by model are outlined in the separate tabular information.

Cruise control with speed limiter

With steering wheel mounted controls. Enables you to maintain a constant speed, making it ideal for economical motorway driving.

Steering

- Speed sensitive electrically assisted power steering
- Reach and rake adjustable steering column

Front camera system

A range of class-leading driver assistance and safety features are controlled by the front camera system

Forward collision alert

The system operates automatically from 3mph and gives an audible warning as well as a visual warning when approaching another vehicle too quickly

Speed sign recognition

Detects and then displays speed limits, reducing uncertainty and the risk of speeding.

- Recognises different speed signs, including temporary speed restrictions
- Displays reminder in the instrument cluster

Driver drowsiness system

The system monitors driving time and driving behaviour to help prevent accidents caused by tiredness.

Lane departure warning with lane keep assist

If the driver has not actively steered or signalled, the lane departure warning system provides gentle steering correction and warns when the car moves outside of lane markings at speeds above 40mph.

- Warning light in instrument cluster
- Audible warning
- Facia on/off switch

Wipers

- Intermittent rear window wash/wipe

Model Specific Features/Options

	Option code*	Electric model	Edition	SE	Elite
Driver Assistance					
Rear parking distance sensors		●	●	●	
Front and rear parking distance sensors	UD5			£400	●
Panoramic rear-view camera		●		●	●
Side blind spot alert					●
Adaptive cruise control (diesel manual models only)	K38			£250	
Advanced park assist	UFQ				£455
Head-up display	UV6	£355		£355	£355
Intelligrip	PS4	£410		£410	
Sight and Light Pack – High beam assist/Rain-sensitive windscreen wipers		●		●	●
11kW three-phase on-board charger	K29	£360			

*Optional at extra cost including VAT.

Driver Information and Security

Standard Features – The following features are standard across the entire Combo Life range. Specific features by model are outlined in the separate tabular information.

Driver Information

Instrumentation

- Speedometer and rev counter
- Digital fuel gauge with low fuel level warning light
- Digital water temperature gauge with warning light
- Shift-up/down indication light – Indicates when to change gear for optimum fuel economy

Driver information display

(centrally located in instrument cluster)

- 3.5-inch colour information display
- Trip computer data
- Total mileage
- Service-due indicator
- Oil life
- Tyre pressure monitoring system

Multi-function trip computer

(displayed on driver information display)

- Trip mileage
- Vehicle range based on remaining fuel
- Average speed
- Average fuel economy
- Instantaneous fuel economy
- Driving time

Central facia display

(format dependent on infotainment unit)

- Audio information
- Digital clock with automatic RDS time adjustment
- Outside air temperature with ice warning function
- Additional features dependent on infotainment unit (see infotainment for details)

Security

- ‘Key left in ignition’ audible warning
- Electronically protected audio equipment
- Engine deadlock immobiliser
- Visible Vehicle Identification Number (VIN)
- Locking wheel bolts for alloy wheels
- Freewheeling door locks

Remote control central locking

- Operates on doors, tailgate and fuel filler flap
- Deadlocking
- Central locking activation switch on driver’s door

Model Specific Features/Option

	Option code*	Electric model	Edition	SE	Elite
Security					
Keyless entry		●		Auto only	●
Remote control ultrasonic security alarm system	PS6	£200	£200	£200	£200

*Optional at extra cost including VAT.

Convenience

Standard Features – The following features are standard across the entire Combo Life range.
Specific features by model are outlined in the separate tabular information.

Interior Convenience

- Front 12-volt electrical accessory socket
- Driver's sun visor incorporating vanity mirror with cover
- Dipping rear-view mirror
- Steering wheel mounted audio controls
- Front USB connection

Interior Storage

- Two fascia-mounted drinks holders
- Two drinks holders in centre console
- Large open storage pocket behind infotainment screen
- Interior courtesy light
- Front map reading lights
- Luggage compartment lighting
- Small open storage compartment behind gear knob
- Two front large and small door pockets
- Two rear door pockets
- Open storage compartment below glovebox
- Full-width overhead storage shelf with ambient lighting

Luggage Area

- Luggage compartment cover
- Illuminated load area
- Fully carpeted load area
- Interior tailgate handle
- Four load restraint lashing eyes
- Twin gas-assisted tailgate struts

Interior Lighting

- Central front courtesy light
- Central rear courtesy light
- Fade up/fade down

Model Specific Features/Options

	Option code*	Electric model	Edition	SE	Elite
Interior Convenience					
Fold-flat front passenger seat with armrest		●		●	●
Panoramic sunroof/storage (not available on XL or 7-seat models)	C2K	£840		£840	
Child Pack – Rear-view child-minder mirror/Rear side window sunblind/ Second row storage (petrol/diesel models only)	WV6	£250		£250	£250
230-volt electrical accessory socket (in lieu of 12-volt electrical accessory socket)	KI5	£120		£120	£120
Electronic parking brake		●		Manual only	
Two foldable tables with cupholders		●		●	●
Front-seat back pockets		●		●	●

*Optional at extra cost including VAT.

Convenience

Standard Features – The following features are standard across the entire Combo Life range.
Specific features by model are outlined in the separate tabular information.

Heating and Ventilation

- Air recirculation facility
- Cabin particulate filter – Removes dust, airborne particles and pollen
- Four-speed fan
- Illuminated controls
- Four adjustable facia vents
- Windscreen demist vents
- Side window demist vents
- Rear heating duct

Exterior Convenience

Door mirrors

- Twin electrically adjustable/heated door mirrors

Windows

- Solar heat-absorbing windscreen
- Electrically operated front windows with safety autoreverse and one-touch up/down facility
- Tailgate with heated window and wash/wipe facility

Model Specific Features/Options

	Option code*	Electric model	Edition	SE	Elite
Heating and Ventilation					
Air conditioning		●	●	●	
Dual-zone electronic climate control	CJ2	£200		£200	●
Heated leather-covered steering wheel				Manual only	
Leather-covered steering wheel		●		Auto only	●
Exterior Convenience					
Electrically operated rear windows		●		●	●
Manually folding door mirrors			●		
Electrically foldable door mirrors		●		●	●
Opening tailgate window		●		●	●
Tow bar	VQ9		£600	£600	£600

*Optional at extra cost including VAT.

Exterior Style and Lighting

Standard Features – The following features are standard across the entire Combo Life range.
Specific features by model are outlined in the separate tabular information.

Exterior Styling

- Chrome-effect front grille bar
- Body-colour door handles
- Body-colour bumpers and sliding rail cover

Exterior Lighting

- Automatic lighting control
- Front fog lights
- LED side repeat indicators
- Lights-on audible warning – When driver’s door is opened an audible warning sounds to alert the lights have been left on.

- Manual headlight beam levelling. Use to adapt headlight range to the vehicle load to prevent dazzling.
- Rear fog light
- Reversing light
- Hazard warning lights

Model Specific Features

	Option code	Electric model	Edition	SE	Elite
Exterior Styling					
Black side protection mouldings			●		
Body-colour side protection mouldings		●		●	●
Dark-tinted rear windows		●		●	●
Black door mirrors			●		
Body-colour door mirrors		●		●	
Onyx black door mirrors					●
Roof rails					●
Alloy-effect protective front skid plate					●
Exterior Lighting					
Halogen daytime running lights			●		
LED daytime running lights		●		●	●

Infotainment

Standard Features

Multimedia with 8-inch touchscreen

Standard on Edition and SE models

Standard on Combo-e Life SE models

Onboard features:

- 7-inch colour touchscreen
- DAB Digital radio
- RDS with Traffic Programme
- AM/FM stereo radio with 36 station presets
- Six speakers

Media connections:

- USB connection
- Bluetooth® A2DP audio streaming (Advanced Audio Distribution Profile)

Mobile phone portal:

- Bluetooth® connectivity
- Vehicle microphone
- Handsfree calls via steering wheel controls
- Phone book access – Contacts/last calls/missed calls etc. are mirrored on the display and are easily navigated using the touchscreen (features dependent on mobile phone).
- SMS read out and reply

Smartphone interface:

- Apple CarPlay
- Android Auto™
- Smartphone projection that allows operations via voice command, touchscreen and buttons to control apps and music playback

Additional features:

- Steering wheel mounted audio controls
- Flexible roof-mounted aerial

Multimedia Navi Pro with 8-inch touchscreen (IO6)

Standard on Elite models and optional at extra cost on Edition and SE models at £700 inc. VAT

Optional on Combo-e Life SE models at £700 inc. VAT

Features as Multimedia, with the addition of:

- Satellite navigation system
- 2D/3D street level mapping
- European coverage
- Points-of-interest search
- Map updates via USB

Navi Pro on Combo-e Life also enables the ability to programme preconditioning. This can either be done through the MyVauxhall app or the touchscreen.

Vauxhall Connect*

Standard on Combo-e Life SE models

e-Call and b-Call:

Help when you need it, 24/7, 365 days a year, that's what you get with new Vauxhall Connect. In an emergency or breakdown, you'll be put in touch with a trained advisor, with just the touch of a button.

Live Navigation Plus and more:

You can also access live navigation services, receive regular vehicle diagnostic info plus there's a host of remote convenience features available through the MyVauxhall app.

- **Peace of mind:** emergency call, breakdown call and regular vehicle status and information
- **Convenience:** remote functions (e.g. lock/unlock the door).
- **Our additional services for electric vehicles:** trip planning, remote settings or public charging solutions – we keep you going!
- **Smart driving:** enjoy a relaxed ride thanks to live navigation and trip management
- **Traffic alerts:** Live Navigation Plus introduces speed camera, traffic light camera and accident hotspot alerts



VX_COM_28922



VX_COM_28486

Please note that compatibility and certain functions may be different depending on the type of device and operating system you're using with the Multimedia systems. Apple CarPlay is a trademark of Apple Inc. Apple and iPhone are trademarks of Apple Inc., registered in the U.S. and other countries. Android is a trademark of Google Inc, also registered in the U.S. and other countries. *Services may require a subscription/fee and are subject to mobile network coverage and availability. Live navigation services are included for 3 years and thereafter are subject to an additional subscription fee. Only available on models with satellite navigation.

Please note, Android smartphone projection illustrated on 8-inch colour touchscreen on Multimedia Navi Pro audio unit.

Interior Styling and Comfort

Combo-e Life SE



Steering wheel:

- Three-spoke flat-bottomed design
- Heated leather-covered
- Satin chrome-effect bezel

Seat trim:

- Mistral grey with Angora Striple fabric seat trim inserts

Front seating:

- Driver's seat (six-way adjustable):
 - Height – Reach – Backrest
 - Manual lumbar adjustment – Armrest
 - Under seat storage – Head restraint
- Passenger's Seat (four-way adjustable):
 - Reach – Backrest – Head restraint
 - Fold flat facility

Edition/SE/Elite



Steering wheel:

- Three-spoke flat-bottomed design
- Leather-covered (Automatic models only)
- Heated leather-covered (Manual SE models only)
- Satin chrome-effect bezel

Seat trim:

- Mistral Grey with Angora Striple fabric seat trim inserts

Front seating:

- Driver's seat (six-way adjustable):
 - Height – Reach – Backrest
 - Manual lumbar adjustment – Armrest
 - Under seat storage – Head restraint
- Passenger's Seat (four-way adjustable):
 - Reach – Backrest – Head restraint
 - Fold-flat facility (SE/Elite models only)

Interior Styling and Comfort – Rear seating

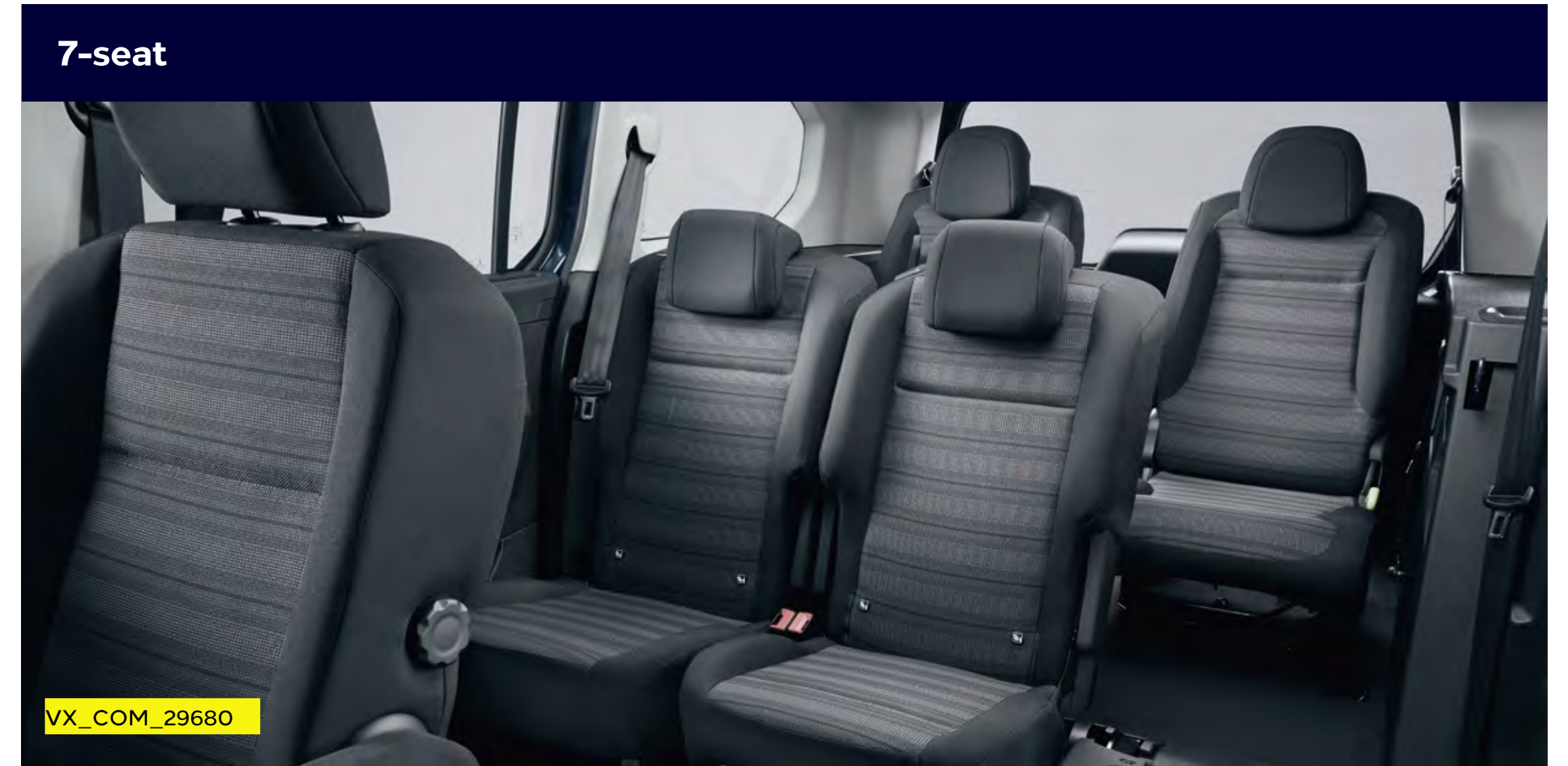

Model Specific Features/Option

	Option code*	Electric model	Edition	SE	Elite
Rear seating		SE			
Height-adjustable and removable head restraints		●	●	●	●
Second-row three-person layout 60/40 split-folding seats		●	●	●	
Second-row three-person layout 35/30/35 individual split-folding second-row seats with fold-flat facility	APS	£300		£300	●

*Optional at extra cost including VAT.

Exterior Colours

White Jade (G20)*
Solid paint



VX_COM_28545

Cool Grey (GAC)**
Two-coat metallic paint £570



VX_COM_28546

Moonstone Grey (G40)**
Two-coat metallic paint £570



VX_COM_28549

Night Blue (GBT)**
Two-coat metallic paint £570



VX_COM_28550

Quartz Silver (G4I)**
Two-coat metallic paint £570



VX_COM_28547

Copper Metallic (10K)**
Two-coat metallic paint £570



VX_COM_31981

Pearl Black (G70)**
Two-coat metallic paint £570





VX_COM_28548

The colours reproduced may vary slightly from the actual paint colour. As a result they should be used as a guide only. Your Vauxhall Retailer has a comprehensive display of our paint samples.

*Standard exterior paint. ** Optional at extra cost including VAT.

Wheels and Tyres

		Option code	Electric model	Edition	SE	Elite
	<p>16-inch steel wheels with full diameter wheel covers</p> <ul style="list-style-type: none"> • 205/60 R 16 tyres • Emergency tyre inflation kit (in lieu of spare wheel) 			●		
	<p>16-inch seven-spoke alloy wheels</p> <ul style="list-style-type: none"> • 205/60 R 16 tyres • Emergency tyre inflation kit (in lieu of spare wheel) 		●		●	
	<p>17-inch alloy wheels</p> <ul style="list-style-type: none"> • 205/55 R 17 tyres • Emergency tyre inflation kit (in lieu of spare wheel) 					●

Petrol Engines

	1.2 (110PS) Turbo	1.2 (130PS) Turbo
Capacity	1199cc	1199cc
Maximum power	110PS (81kW) @ 5500rpm	130PS (96kW) @ 5500rpm
Maximum torque	205Nm (151 lb.ft.) @1750rpm	230Nm (170 lb.ft.) @1750rpm
Configuration	3 cylinders, 4 valves per cylinder, double overhead camshafts	3 cylinders, 4 valves per cylinder, double overhead camshafts
Fuel/induction system	Turbocharger. Variable Valve Timing. Direct fuel injection	Turbocharger. Variable Valve Timing. Direct fuel injection
Emission compliance	Euro 6D (6.3)	Euro 6D (6.3)
Service interval	12,500 miles or 1 year (whichever occurs sooner)	12,500 miles or 1 year (whichever occurs sooner)

Diesel Engine

	1.5 (100PS) Turbo D
Capacity	1499cc
Maximum power	100PS (75kW) @ 3500rpm
Maximum torque	250Nm (184 lb.ft.) @ 1750rpm
Configuration	4 cylinders, 4 valves per cylinder, double overhead camshafts
Fuel/induction system	Variable-nozzle turbocharger with electric switching. Common rail direct injection
Emission compliance	Euro 6D (6.3) Diesel Particulate Filter
Service interval	20,000 miles or 1 year (whichever occurs sooner)

Performance, Fuel Economy and Emissions

	Performance (manufacturer's figures)		Fuel economy mpg (litres/100km) [#]		CO ₂ emissions g/km [#]		Vehicle Excise Duty*		BiK rates from - 2021/22 tax year
	Maximum speed (mph)	Acceleration 0-62mph (sec)	Combined Low	Combined High	Combined Low	Combined High	First year rate	Standard rate	
Combo Life									
1.2 (110PS) Turbo	108	13.0	44.1 (6.4)	44.1 (6.4)	145	146	£220	£155	33%
1.2 (130PS) Turbo automatic	115	12.3	40.9 (6.9)	41.6 (6.8)	153	155	£555	£155	34%
1.5 (100PS) Turbo D	107	12.7	53.3 (5.3)	55.4 (5.1)	135	139	£220	£155	31%
Combo Life XL									
1.2 (110PS) Turbo	108	13.2	43.4 (6.5)	44.1 (6.4)	145	147	£555	£155	33%
1.5 (100PS) Turbo D	107	12.9	53.3 (5.3)	53.3 (5.3)	138	139	£220	£155	31%
Combo Life (7-seat)									
1.2 (110PS) Turbo	108	13.6	44.1 (6.4)	44.1 (6.4)	145	146	£555	£155	33%
1.2 (130PS) Turbo automatic	115	12.3	40.4 (7.0)	40.9 (6.9)	157	158	£555	£155	35%
1.5 (100PS) Turbo D	106	12.7	52.3 (5.4)	53.3 (5.3)	140	141	£220	£155	32%
Combo Life XL (7-seat)									
1.2 (110PS) Turbo	108	13.9	39.2 (7.2)	39.8 (7.1)	161	163	£555	£155	36%
1.2 (130PS) Turbo automatic	115	12.3	40.4 (7.0)	40.4 (7.0)	157	159	£555	£155	35%
1.5 (100PS) Turbo D	106	13.0	52.3 (5.4)	53.3 (5.3)	140	141	£220	£155	32%

[#]Figures shown are for comparison purposes and should only be compared to the fuel consumption and CO₂ values of other cars tested to the same technical standard. The fuel consumption achieved, and CO₂ produced, in real world conditions will depend upon a number of factors including, but not limited to: the accessories fitted (pre and post registration); variations in weather; driving styles and vehicle load. The WLTP (Worldwide Harmonised Light Vehicles Test Procedure) is used to measure fuel consumption and CO₂ figures. The CO₂ figures display a range to reflect the highest value for the highest emitting version with all available options added, through to a minimum value to represent the lowest emitting version in standard specification. *Correct at time of publication.

Combo-e Life Specifications*

Single-speed electronic drive selector

As the motor is an all-electric single-speed drive unit, there is no need for multiple gears. Instead, the shifter lets the driver select from the following:

- Park
- Reverse
- Neutral
- Drive
- Braking (for increased regenerative braking)

Drive Mode Selector

The driver can determine the driving style through selecting one of the following modes:

- **Power:** with high power reserves for the highest top speed and torque. Recommended at full capacity.
- **Normal:** for a balanced drive that offers a compromise between performance and energy efficiency. WLTP range is validated in this mode.
- **ECO:** for maximum range and energy efficiency. The ECO mode deactivates all unnecessary energy-consuming features and reduces the top speed, torque and overall performance.

Braking

Energy recuperation

The regenerative braking system works when the vehicle is in motion, energy created by the resistance of the brakes against the drivetrain is converted into DC voltage to partially recharge the battery. The driver can also engage braking mode through the drive selector to increase the level of energy recuperation.

Single foot driving experience

The system not only utilises the energy when the brakes are being used, but also engages when the vehicle is coasting, recovering more energy and enabling single foot driving as the brakes automatically engage when the throttle pedal is released.



VX_COM_e_31963

Drivetrain	Combo-e Life	
CO ₂ emissions	0g/km	
Maximum power kW/PS	100/136	
Maximum torque Nm/lb. ft.	260/192	
Acceleration 0–62mph (sec)	11.7	
Maximum speed mph	84	
Transmission	Automatic electric drive with fixed gear ratio	
Service interval	Every 25,000 miles or 2 years (whichever comes sooner) Initial inspection at 12,500 miles or 1 year (whichever comes sooner)	
Electric range	174 miles (WLTP preliminary)	
Weights kg	SE	SE XL
Gross vehicle weight	2366 – 2387	2376 – 2396

The Combo-e Life is a battery electric vehicle requiring mains electricity for charging. Range data given has been determined according to WLTP test procedure methodology. The figures shown are intended for comparability purposes only and should only be compared to other cars tested to the same technical standard. The range you achieve under real world driving conditions will depend upon a number of factors, including but not limited to: the accessories fitted (pre and post registration); charging frequency; personal driving style; vehicle load and route characteristics; variations in weather; heating/air conditioning; pre-conditioning and battery condition. For more information, contact your local Vauxhall Retailer.

*Provisional data.

Combo-e Life Specifications*

Charging

Combo-e Life comes fitted with an 7.4kW on-board charger and mode 3 cable. An 11kW on-board charger is available as an extra cost option.

The charging flap's Padlock LED lights up when the cable is correctly plugged in and locked and then acts as a user interface to show the charging status via coloured LED lights:

- **White:** welcome light that helps to light up the area, especially useful in dark conditions
- **Flashing green:** charging in progress
- **Solid green:** charging complete
- **Solid blue:** delayed charging toggled; changes to flashing green when charging commences
- **Solid red:** malfunction

The driver may also choose from two settings:

- **Immediate charging (the standard setting):** Starts charging as soon as the vehicle is docked for charging
- **Delayed charging:** This is especially useful for when cheaper electric rates are desired, e.g. charging at night. Simply enter a charging start time.

Please note, EV range assumes that vehicle has been pre-conditioned prior to journey. This function can be accessed either via MyVauxhall App (standard with all Combo-e Life models or with optional Navi Pro).

Charging				
Supply	AC Current		DC Current	
	Domestic 13amp	Wallbox 32amp Single-phase	Wallbox 16amp Three-phase	Rapid charge** 0-80%
	1.8kWh	7.4kWh	11.kWh†	100kWh
50kWh battery	31h	7h 30m	5h	30m

Battery	7.4kW on-board charger
Battery energy kWh	50
EV range (WLTP preliminary)	174 miles
Battery consumption (Combined low/high)	17.5-19.4kWh/100km
Battery warranty	8 years/100,000 miles/70% capacity



The Combo-e Life is a battery electric vehicle requiring mains electricity for charging. Range data given has been determined according to WLTP test procedure methodology. The figures shown are intended for comparability purposes only and should only be compared to other cars tested to the same technical standard. The range you achieve under real world driving conditions will depend upon a number of factors, including but not limited to: the accessories fitted (pre and post registration); charging frequency; personal driving style; vehicle load and route characteristics; variations in weather; heating/air conditioning; pre-conditioning and battery condition. For more information, contact your local Vauxhall Retailer.

*Provisional data. **You can obtain 15-80% of the vehicle charge in 30 minutes from a 100kW rapid charging station. You can obtain 15-80% of the vehicle charge in 45 minutes from a 50kW rapid charging station. Rapid charging stations are widely available across the UK at various locations and their power rating varies, typically from 50kW and sometimes up to 350kW. The charging time may vary according to the type and power of the charging station, the outside temperature at the charging point and the battery temperature. †With optional 11kW on-board charger.

Specifications

Transmission

Six-speed manual gearbox

1.2 (110PS) Turbo models

1.5 (100PS) Turbo D models

Eight-speed automatic transmission

1.2 (130PS) Turbo models

Replacing the traditional lever, the automatic transmission selection-mode dial/drive wheel is an innovation solution that is both elegant and intuitive. By simply twisting the dial, the following modes can be selected:

- Park, for when the vehicle is stationary and the wheels are locked
- Drive, for automatic forward motion
- Neutral, for when the vehicle is stationary, wheels are free
- Reverse, for automatic backward motion

Fuel tank capacity

- 61 Litres (13.4 gallons) – Petrol models
- 50 Litres (10.9 gallons) – Diesel models

AdBlue® Tank Capacity

- 17 Litres (3.7 gallons)

Steering

Turning circle (kerb-to-kerb)

- 11.0m (36 ft) Life models
- 11.8m (38.7 ft) Life XL models

Weights and Towing Data kg

	Gross vehicle weight	Maximum towing weights Trailer with brakes (without brakes)
Combo Life		
1.2 (110PS) Turbo	2050	1150 (720)
1.2 (130PS) Turbo automatic	2090	1200 (750)
1.5 (100PS) Turbo D	2095	1300 (750)
1.2 (110PS) Turbo (7-seat)	2210	1000 (750)
Combo Life XL		
1.2 (110PS) Turbo	2070	1100 (750)
1.5 (100PS) Turbo D	2115	1250 (750)
1.2 (110PS) Turbo (7-seat)	2240	950 (750)
1.2 (130PS) Turbo automatic (7-seat)	2270	1000 (750)
1.5 (100PS) Turbo D (7-seat)	2285	1100 (750)

Please note: Gross vehicle weight is the total permissible weight of the vehicle including passengers and their luggage. The maximum roof rack loading should not exceed 100kg on all models. The maximum towing weights are based on the ability of the car, with two occupants of 75kg each, to restart on a 12% gradient, which is approximately 1 in 8.3, at sea level. The permitted trailer load applies up to the specified incline and up to an altitude of 1000 metres above sea level. The permissible gross train weight decreases by 10% for every 1000 metres of additional altitude. Any extra weight, such as luggage or additional passengers, should be deducted from the maximum towing weight. Always fit Vauxhall towing attachments and accessories available from your Vauxhall Retailer. They are designed specifically for Vauxhall models and carry a 12-month guarantee. During trailer towing do not exceed a maximum speed of 60mph. This speed limit is also applicable in countries with higher permitted speeds for trailer-vehicle combinations. Pay attention to the local speed limits. For trailers with low driving stability and caravans the use of an oscillation damper is strongly recommended.

Dimensions and Capacities All measurements in mm (inches) unless stated otherwise.

Loadspace Dimensions	Life	Life XL
Maximum load floor length – passenger seat folded	2700 (106.3)	3050 (120.1)
Maximum load length – behind front seats	1880 (74.0)	2230 (87.8)
Maximum load length – behind second-row seats	914 (36.0)	1350 (53.1)
Maximum load length – behind third-row seats	236 (9.3)	418 (16.5) – 566 (22.3)
Maximum load height	1126 (44.3)	1119 (44.0)
Maximum load width	1195 (47.0)	1195 (47.0)
Maximum width between wheel arches	1149 (45.2)	1129 (44.4)
Loading height	584 (23.0)	620 (24.4)
Maximum tailgate aperture width	1087 (42.8) – 1241 (48.9)	1087 (42.8) – 1241 (48.9)
Maximum tailgate aperture height	1126 (44.3)	1126 (44.3)
Maximum height under raised tailgate	1892 (74.5)	1892 (74.5)
Maximum side-access aperture width	640 (25.2) – 745 (29.3)	640 (25.2) – 745 (29.3)
Maximum side-access aperture height	1145 (45.1)	1145 (45.1)
Luggage Capacities* Litres (cu.ft.)		
Behind front-row seats to glassline	1414 (49.9)	1672 (59.0)
Behind front-row seats to roof	2126 (75.1)	2693 (95.1)
Behind second-row seats to glassline	597 (21.1)	850 (30.0)
Behind second-row seats to roof	983 (34.7)	1538 (54.3)
Behind third-row seats	571 (20.2)	806 (28.5)

*Measured using the ECIE method.

Life

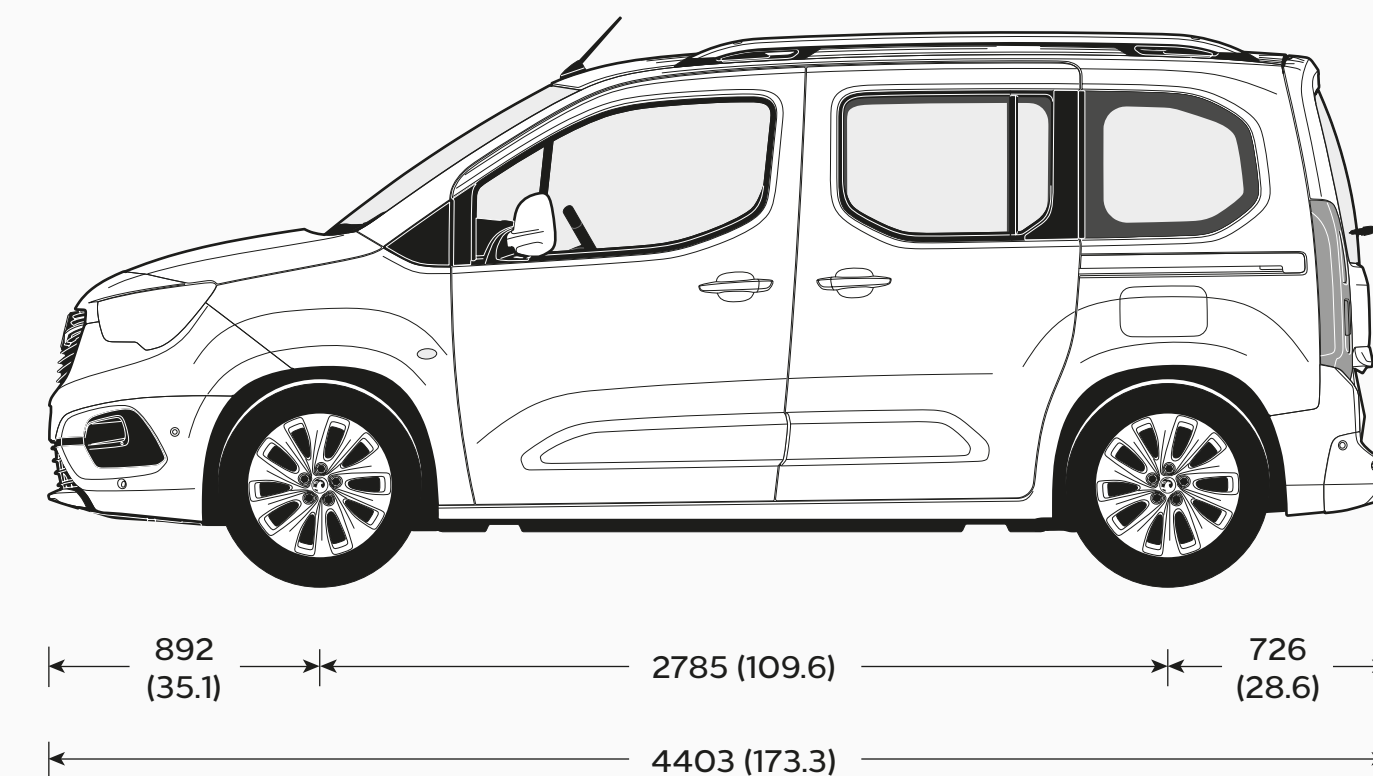
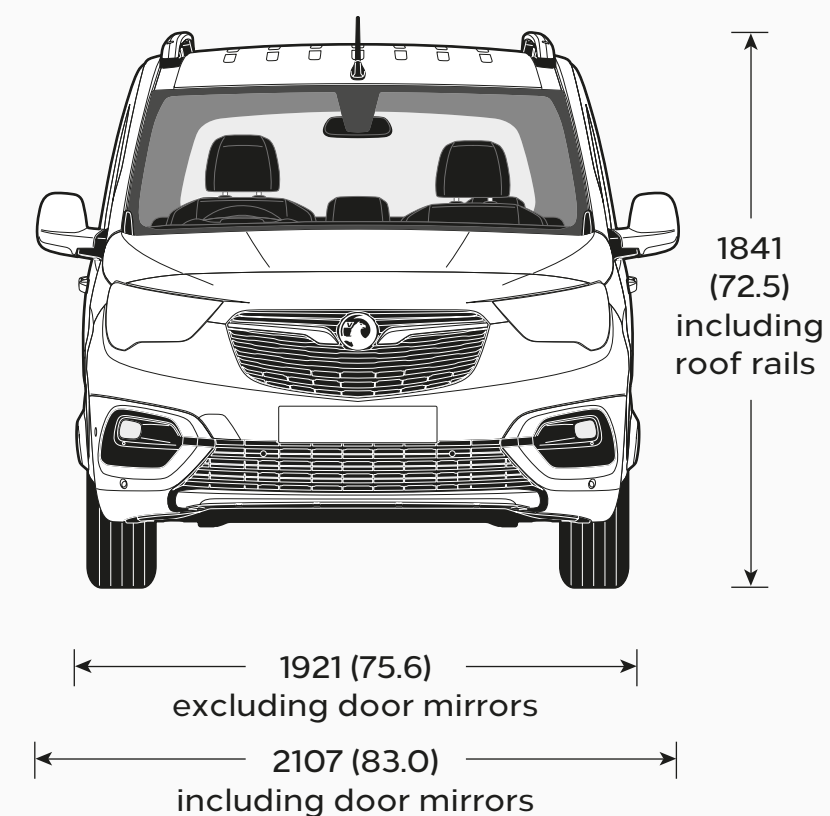

Life XL

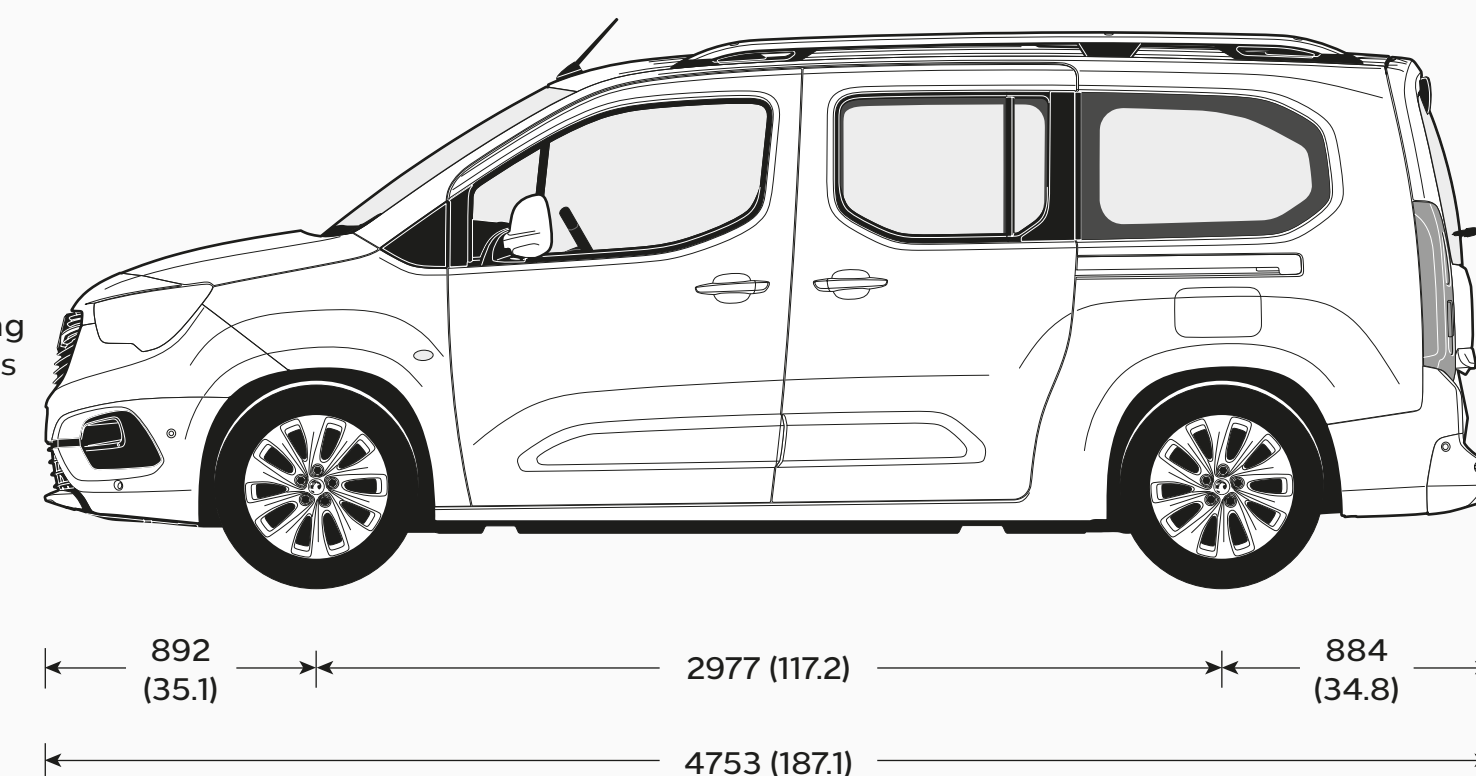
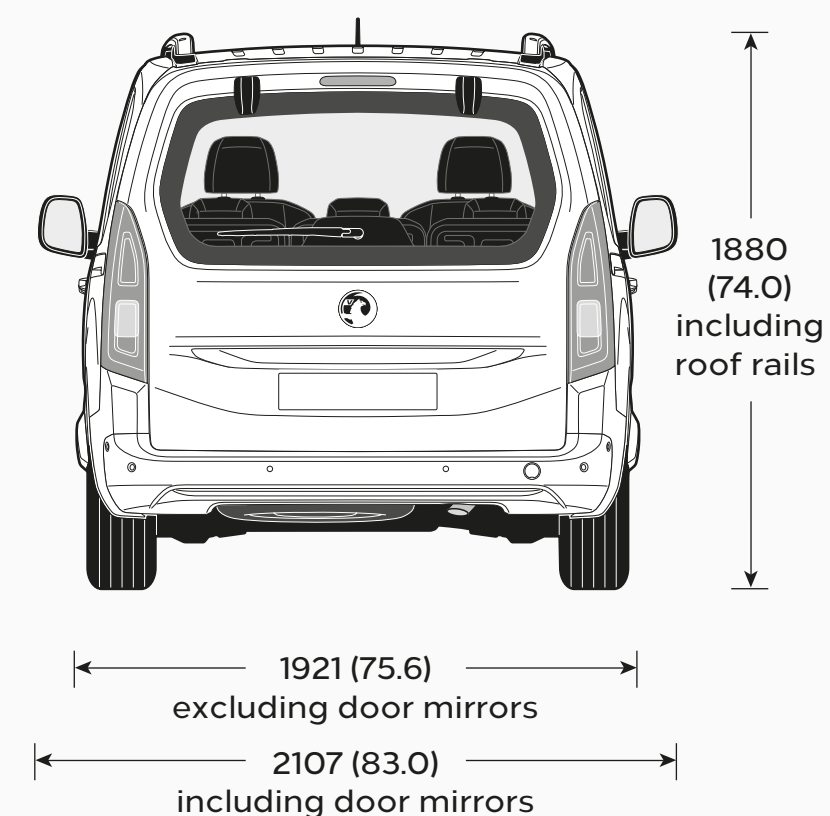

Accessories

Safety	Total (inc. VAT)	Protection	Total (inc. VAT)	Transport solutions	Total (inc. VAT)	Electric	Total (inc. VAT)
Spare wheel kit with 16-inch emergency wheel, tool kit and mounting basket	£247	Carpet mats (set of 4)	£60	Roof base carrier (set of 2 bars)		Mode 2 emergency charging cable (Type G)	£584
Philips ADR620 dash cam	£109	Carpet mats for third row seats (set of 2)	£21	- Without roof rails ³	£175	Mode 3 charging cable	
Front parking sensors	£466	Rubber mats (set of 4)	£47	- With roof rails	£213	- 7.4kW	£331
Rear parking sensors	£446	Boot tray	£63	Additional roof base carrier (1 bar)		- 11kW	£371
Child seats ¹		Vertical cargo net	£21	- Without roof rails ³	£102	- 22kW	£438
- Age group 0 (approx. 24 months/ up to 13kg)	£182	Dog guard - without sunroof	£276	Roof carriers (requires base carrier)		Cable bag	£49
- ISOFIX base for age group 0 ²	£230	Dog guard - with sunroof	£279	Roof box - Thule Ocean 80	£164	Mode 2 universal charger UK kit (22kW)	£1,555
- Age group 1 (approx. 1-3.5 years/9-18kg)	£510	Rear splash guards	£67	Roof box - Thule Ocean 200	£374	Accessories for universal charger	
- Age group 2/3 (approx. 3-12 years/ 15-36kg)	£186			Roof box - Thule Touring 200	£428	- Wall bracket	£105
Safety Pack - first aid kit, hi-vis vest and small warning triangle	£16	Comfort		Roof box - Thule Touring 700	£492	- Bag	£65
Warning triangle	£9	FlexConnect bracket	£32	Roof box - Thule Motion 800	from £426	- Safety lock	£20
Hi-vis safety vest - adult	£4	FlexConnect hook	£27	Bike carrier - Thule FreeRide 532	£81	- Adapter Type 2	£318
Hi-vis safety vest - child 3-6 years (42cm)	£4	FlexConnect coat hanger	£40	Bike carrier - Thule Expert 298	£134	- Adapter Type 3c	£358
Hi-vis safety vest - child 7-12 years (52cm)	£4	FlexConnect folding table	£65	Surfboard carrier - Thule 833	£82	- Adapter (various)	£120
First aid kit	£15	FlexConnect iPad mini holder	£93	Ski/snowboard carrier			
Emergency seat belt cutter and hammer	£18	FlexConnect iPad holder	£103	- Thule Snow Pack 7324 (4 x pairs)	£143		
Fire extinguisher (1kg) with strap	£32	FlexConnect iPad Air holder	£103	Ski/snowboard carrier			
Spare bulb kit - 11 x high-quality bulbs and 7 x fuses from Philips	£69	FlexConnect Samsung Galaxy holder	£93	- Thule Snow Pack 7326 (6 x pairs)	£258		
		Privacy shades (set of 2) for:		Towing			
		- side rear windows (tilt/turn window)	£59	Swan's neck towing ball for:			
		- side rear windows (electric window)	£57	- Life models	£253		
		- quarter side rear windows (Life models)	£55	- Life XL models	£253		
		- quarter side rear windows (Life XL models)	£59	Tow bar with tow ball			
		- rear window	£59	(removable without tools) for:			
		Cup holder insert		- Life models	£268		
		- Miscellaneous	£9	- Life XL models	£265		
		- Pen	£15	13-pin to 7-pin adaptor	£29		
		- Notepad	£15				
		Smoker's kit	£20				
		Fragrance diffuser	£23				
		Fragrance cartridge (various)	£18				

Please note: Prices shown are fully fitted and painted, where applicable and include VAT. Please check with your local Vauxhall Retailer for details. It is advisable to ensure your insurance policy is adequate to cover additional fitted accessories. Prices correct at time of publication.

¹Restrictions apply to the use of child seats, please consult your vehicle user manual or Vauxhall Retailer. ²Restricted to rear seat usage only for vehicles with transponder deactivation of passenger airbag. ³A dedicated T-Track adapter (Thule 697-4 or Thule 697-6) is required for the installation of specific roof boxes, contact your local Vauxhall Retailer for details.

Company Car Driver and Fleet Information

Benefit in kind company car taxation*

The car benefit charge will be the car's list price (including VAT, options and accessories fitted, delivery to Retailer and number plates, but excluding Vehicle Excise Duty and new vehicle first registration fee) multiplied by the percentage charge for the CO₂ emissions band in which the car falls (see table opposite). Multiply this figure by your personal income tax rate (20%** for Basic Rate, 40%** for Higher Rate) to calculate your annual benefit in kind tax liability.

Example:

Combo Life Edition 1.5 (100PS) Turbo D Start/Stop (CO ₂ emissions 135g/km)	
On-the-road RRP	£23,015.00
Deduct: Vehicle Excise Duty	(£220.00)
New vehicle first registration fee	(£55.00)
Effective list price	£22,740.00
Add: Optional two-coat metallic paint	£570.00
List price for tax purposes (P11D value)	£23,310.00
Car benefit charge 2021-22 tax year (31%)	£7,227.00
Benefit in kind tax liability (2021-22 tax year)	
Basic Rate (20%) tax payer	£1,445.40
Higher Rate (40%) tax payer	£2,890.80

*Please note this Price Guide provides taxation information as a guide only. Vauxhall does not provide taxation guidance. Drivers should always take professional advice on their own tax position.

**Excludes residents of Scotland.

BiK for Scottish Residents

Effective 6 April 2018 the Scottish Government have introduced their own BiK taxation structure. This only applies to Company Car Drivers that are Scottish taxpayers. HMRC will determine whether or not an individual is a Scottish taxpayer based on where their main place of residence is.

The BiK rates for Scotland are:

- Over £12,570-£14,667 Starter Rate 19%
- Over £14,667-£25,296 Basic Rate 20%
- Over £25,296-£43,662 Intermediate Rate 21%
- Over £43,662-£150,000 Higher Rate 41%
- Above £150,000 Top Rate 46%

CO ₂ emissions (g/km)	Percentage of cars price to be taxed 2021-22 tax year
Up to 50	13%
51-54	14%
55-59	15%
60-64	16%
65-69	17%
70-74	18%
75-79	19%
80-84	20%
85-89	21%
90-94	22%
95-99	23%
100-104	24%
105-109	25%
110-114	26%
115-119	27%
120-124	28%
125-129	29%
130-134	30%
135-139	31%
140-144	32%
145-149	33%
150-154	34%
155-159	35%
160-164	36%
165-169	37%
170+	37%

CO ₂ emissions (g/km)	Electric range (miles)	Percentage of cars price to be taxed 2021-22 tax year
0	-	1%
1-50	130+	1%
1-50	70-129	4%
1-50	40-69	7%
1-50	30-39	11%
1-50	<30	13%

To calculate your own personal liability, search: **Vauxhall BiK**, or click the link below: [Vauxhall BiK Tool](#)

Company Car Driver Free 3 Day Test Drive

Our free[†] 3 Day Test Drive programme is open to all Company Car Drivers which allows you to choose any model in the current Vauxhall line-up (exclusions apply). With full insurance cover provided, it gives you a meaningful length of time to make an informed decision about your next company car.

Search Vauxhall 3DTD to book your free[†] test drive or click the link the below: [Vauxhall 3 Day Test Drive](#)

[†]The free 3 Day Test Drive programme is open to Company Car Drivers and Fleet Decision Makers. Available for UK Mainland only. Terms and conditions apply. Full terms and conditions can be found at vauxhallfleet.co.uk/testdrive/index/terms.

Fleet Toolbox

Discover the facts in our online Toolbox for both Company Car Drivers and Fleet Decision Makers. The Fleet Toolbox has a host of useful calculators, comparators, interactive listings and information. Search Vauxhall Fleet Tools or click the link below: [Vauxhall Fleet Tool Box](#)

Contact Vauxhall Fleet

Please contact one of our dedicated sales teams who will be happy to help with your particular enquiry.

Company Car Drivers

Call: 0345 111 2020

Email: company-car@vauxhallinfo.co.uk

Telephone lines are open

- Monday to Friday 8:00am-9:00pm
- Saturday and Sunday 9:00am-6:00pm

Fleet Decision Makers

Depending on the size of your fleet of vehicles, we have a dedicated team to handle your enquiries. The lines are open Monday to Friday excluding Bank Holidays.

1-24 vehicles

Call: 0845 076 2254 (8:30am-5:00pm)

25+ vehicles

Call: 0330 587 8222 (8:30am-5:00pm)

Email: vauxhallfleet@vauxhall.co.uk

Special Vehicles (Police, Fire and Ambulance)

Call: 01582 409999 (8:30am-5:00pm)

Email: vauxhallspecialvehicles@vauxhall.co.uk

For more information visit vauxhall.co.uk/fleet

Further Information

On-the-road prices

To eliminate uncertainty about hidden costs when buying a new car, Vauxhall publishes on-the-road recommended retail prices (RRP) and these are shown in the pricing tables within this price guide. These prices include VAT, number plates and delivery to Retailer of £700.00 (including £116.67 VAT), 12 months' Government Vehicle Excise Duty (see opposite for details) and the DVLA new vehicle first registration fee of £55.00.*

Please note: The on-the-road recommended retail price (RRP) does not include fuel supplied by the Retailer, motor insurance or any other goods or services supplied by agreement between the Retailer and the customer.

Price protection

Order a new Vauxhall for build in the current model year (as confirmed by your Retailer) for delivery no more than three months in advance and the price you are quoted is the price you pay. This is irrespective of any subsequent price rises between placing your order and delivery of your new car, but you must take delivery as soon as the car is available.

Please note: Price protection does not apply to electric/hybrid models. Vauxhall Motors Limited is not liable for price adjustments caused by Government changes in the rate of VAT (currently 20%), Vehicle Excise Duty, DVLA new vehicle first registration fee or by any other applicable legislation or regulations.

In the event of an accident

Vauxhall Accident Management helps keep you mobile following an accident. Benefits include vehicle recovery, Vauxhall-approved repairs and contacting your insurer. For more details, visit vauxhall.co.uk/AccidentManagement

Free2Move Lease

Whether you're a big company or a small business looking for vehicle financing, Free2Move Lease, our business finance specialists, can deliver exactly what you need.

Free2Move Lease is one of the UK's largest leasing companies and is also a member of the British Vehicle Rental and Leasing Association (BVRLA).

With over 60,000 vehicles in the Free2Move Lease portfolio, Free2Move Lease is able to offer competitive vehicle solutions. In addition, Free2Move Lease also offer innovative connected management of servicing and maintenance.

For further information, please contact your local Vauxhall Retailer or visit vauxhall.co.uk/offers-finance/business-leasing.html

Vehicle Excise Duty

The amount of Vehicle Excise Duty (road fund licence) payable on new cars varies depending on the level of carbon dioxide (CO₂) emissions produced by the vehicle. CO₂ emissions are measured in grams per kilometre (g/km) travelled and divided into 13 charging bands shown in the table opposite.

A 'first year rate' of Vehicle Excise Duty is payable on all new cars and in subsequent years the amount payable reverts to the 'standard rate'. From 1 April 2017 the breakpoints for each of these bands have been revised. Also, for vehicles with a list price over £40,000, including factory-fitted options, an additional £335 is payable for the first five years of standard rate payments.

Vehicle Excise Duty*

Band	CO ₂ emissions in grams per kilometre	First year rate Petrol/Diesel	Standard rate Petrol/Diesel	Standard rate Electric
A	0	£0	£0	£0
B	1-50	£10	£155	£0
C	51-75	£25	£155	£0
D	76-90	£115	£155	£0
E	91-100	£140	£155	£0
F	101-110	£160	£155	£0
G	111-130	£180	£155	£0
H	131-150	£220	£155	£0
I	151-170	£555	£155	£0
J	171-190	£895	£155	£0
K	191-225	£1,345	£155	£0
L	226-255	£1,910	£155	£0
M	Over 255	£2,245	£155	£0

*Correct at time of issue.

Further Information

Customer Care Commitment

For added peace of mind, Vauxhall has an innovative Customer Care Commitment that offers the following:

- Three-year vehicle warranty consisting of a one-year/unlimited mileage manufacturer's warranty and a second and third year manufacturer's warranty with a 60,000 miles limitation
- Vauxhall Assistance for 12 months from first registration
- Six years' body panel anti-perforation warranty

Please note: Warranty is only available on vehicles sourced from Vauxhall Motors Limited. Terms and conditions apply – please see your Vauxhall Retailer for details.

Vauxhall Assistance

Vauxhall Assistance is provided automatically with every new Vauxhall for 12 months from first registration and covers everything from accident assistance, roadside recovery and 'at home' service to flat tyres. For even more peace of mind, on Combo-e life models the cover is extended* to 8 years or 100,000 miles, whichever comes first. Even more reason for you to stay calm and let us take care of everything should the need arise. With Vauxhall Assistance help is literally just a free** phone call away, 24 hours a day, 365 days a year!

Protecting the environment

Vauxhall's commitment to the environment is demonstrated by our products' many environmental awards. For even more information on Vauxhall's efforts to achieve an environmentally sustainable future, and how to dispose of your end-of-life vehicle, see vauxhall.co.uk/recycling

Vauxhall Care

This all-inclusive service package is available on Vauxhalls under 10 months old (from date of first registration).

This package offers complete peace of mind for the first 3 years of your Vauxhall's life with fixed monthly payments for the plan duration.

- **3 years' Vauxhall servicing** – covers first, second and third annual services. Including a brake-fluid change in the second service
- **2 years' Vauxhall Roadside Assistance** – first year from us
- **First years' MOT[†]** – free of charge by your local Vauxhall Retailer

For full terms and conditions and to sign up, visit: vauxhall.co.uk/vauxhallcare

Vauxhall Service Club

Vauxhall Service Club is available for all Vauxhall owners, and it's free to join. Members benefit from the following:

- 15% off Vauxhall Approved Accessories
- Vauxhall's aged 2-3 Years = 15% off parts and labour
- Vauxhall's aged over 3 Years = 25% off parts and labour
- Half price MOT's (NI excluded)
- Free pre-MOT test inspection (NI only)
- Fixed price AdBlue[®] Refills
 - Car = £14.99
 - Van = £24.99
- Access to the Vauxhall Accident Management Programme
- Online service booking available 24/7 with servicing appointments available within 3 days – [Book Online](#)
- Collection and delivery/onward mobility options
- Complimentary 'Wash and Vac' with all routine services^{††}
- Vauxhall trained technicians
- Genuine Vauxhall parts
- Minimum 12 months warranty on parts and labour
- Regular newsletters with exclusive offers, discounts and competitions

Terms and conditions apply. To join visit: vauxhall.co.uk/serviceclub

Vauxhall Insurance with added reassurance

Comprehensive cover – Summary of benefits

- Competitive premiums
- Repairs by a Vauxhall-trained technician
- Genuine Vauxhall parts, guaranteed for five years when we repair your car within our Approved Repairer Network
- Free courtesy car as standard when using an Approved Repairer[‡]
- 24 hour claims helpline
- Personal Accident benefit
- Cover for audio equipment
- Windscreen cover

Call for a quote on 0330 678 1130^{‡‡}

For more product information

For further information on the Vauxhall range or location of your nearest Vauxhall Retailer please call 0345 600 1500. Alternatively, details can be found on our website at vauxhall.co.uk

For more information call **0345 600 1500**

For Fleet enquiries call **0330 587 8222**

Discover the full Vauxhall range at **[vauxhall.co.uk](https://www.vauxhall.co.uk)**

Join us online

The invoice price, including delivery to Retailer, factory-fitted options, accessories fitted by the Retailer and number plates, is subject to VAT. Some feature descriptions in this guide may refer to, and some illustrations may show, optional equipment not included in the standard delivery. The information contained in this guide was accurate at the time of publication. We reserve the right to make changes in design and equipment. Please note that Vauxhall Retailers are not the agents of Vauxhall Motors Limited and are not authorised to bind Vauxhall Motors Limited by any specific or implied undertaking or representation. It is advisable to ensure that your motor insurance policy provides adequate cover for additional fitted options and accessories. The colours in this guide are only approximate actual colours. Illustrated optional equipment is available at extra charge. Availability, technical features and equipment provided on our vehicles can vary by model. For precise information on the equipment provided on our vehicles, please contact your local Vauxhall Retailer.

VAUXHALL

Price and Specification Guide
7 April 2021 | Model Year 2021C



Vivaro Life

Including Vivaro-e Range

CONTENTS

To find the information you want use the links below to navigate around the guide:

[Range Highlights](#)

[Models](#)

[Prices](#)

[Features/Options](#)

[Exterior Colours](#)

[Wheels and Tyres](#)

[Performance, Economy and Emissions](#)

[Dimensions and Capacities](#)

[Specifications](#)

[Accessories](#)

[Company Car Information](#)

[Further Information](#)

NEW VIVARO-E LIFE RANGE HIGHLIGHTS



VX_VIVL_31733



VX_VIVL_29503

EDITION/COMBI

OTR £32,495*

Standard features include:

- Electronic stability programme
- Traction control
- ABS with electronic brakeforce distribution
- Hill start assist
- Driver and front passengers' airbag
- Remote control central deadlocking
- Selective door locking
- Electronic engine deadlock immobiliser
- Multi-function trip computer
- Cruise control with speed limiter
- Air conditioning
- Vauxhall Connect box
- Digital radio/AM/FM stereo radio
- Bluetooth® connectivity
- Steering column mounted audio and phone controls
- Dual front passengers' seat with underseat storage
- Second-row three-passenger foldable 60/40 split bench seat
- Third-row three-passenger foldable bench seat
- Facia-mounted drinks holders
- Nearside and offside sliding side-access glazed doors
- Tailgate with wash/wipe and heated rear window
- Electrically operated front windows
- Electrically adjustable/heated door mirrors
- 16-inch steel wheels
- Automatic transmission with e-toggle shift
- Electronic parking brake
- Remote control security alarm system

ELITE

OTR £46,465

Features over Edition/Combi:

- Electrical operation of sliding side-access doors
- Multimedia Navi Pro infotainment unit with 3D satellite navigation system
- 7-inch colour touchscreen
- Head-up display
- One-touch up/down facility for front windows
- Leather seat trim
- Six-way electrically adjustable heated driver's seat with massage facility
- Four-way electrically adjustable heated passenger's seat with massage facility
- Dual-zone electronic climate control
- Roof-mounted rear heater controls
- Heat-reflective windscreen
- Rear parcel shelf
- Luggage floor net
- Rear seat back tables
- Rear-view child-minder mirror
- Rear side window blinds
- Body-colour front bumper
- Body-colour rear bumper
- Chrome-effect front grille
- Front fog lights
- Rear-view camera
- Rain-sensitive windscreen wipers
- Electro-chromatic rear-view mirror
- LED daytime running lights
- Xenon headlights
- Dark-tinted rear windows
- Electrically folding door mirrors
- Side blind spot alert
- Front and rear parking distance sensors
- Panoramic glass roof
- Curtain airbags for second-and third-row passengers
- Tailgate with separate opening rear window
- Keyless open and start
- 17-inch bi-colour alloy wheels
- Driver Assistance Pack

*Price shown is after allowing for PiCG (Plug-in Car Grant).

NEW VIVARO LIFE RANGE HIGHLIGHTS



VX_VIVL_31732



VX_VIVL_29460

EDITION OTR from £34,615

Standard features include:

- Electronic stability programme
- Traction control
- ABS with electronic brakeforce distribution
- Hill start assist
- Driver and front passengers' airbag
- Remote control central deadlocking
- Selective door locking
- Electronic engine deadlock immobiliser
- Multi-function trip computer
- Cruise control with speed limiter
- Air conditioning
- Vauxhall Connect box
- Digital radio/AM/FM stereo radio
- Bluetooth® connectivity
- Steering column mounted audio and phone controls
- Dual front passengers' seat with underseat storage
- Second-row three-passenger foldable 60/40 split bench seat
- Third-row three-passenger foldable bench seat
- Facia-mounted drinks holders
- Nearside and offside sliding side-access glazed doors
- Tailgate with wash/wipe and heated rear window
- Electrically operated front windows
- Electrically adjustable/heated door mirrors
- 16-inch steel wheels
- Remote control security alarm system

ELITE OTR from £45,985

Features over Edition:

- Electrical operation of sliding side-access doors
- Multimedia Navi Pro infotainment unit with 3D satellite navigation system
- 7-inch colour touchscreen
- Head-up display
- One-touch up/down facility for front windows
- Leather seat trim
- Six-way electrically adjustable heated driver's seat with massage facility
- Four-way electrically adjustable heated passenger's seat with massage facility
- Dual-zone electronic climate control
- Roof-mounted rear heater controls
- Automatic parking heater
- Heat-reflective windscreen
- Rear parcel shelf
- Luggage floor net
- Rear seat back tables
- Rear-view child-minder mirror
- Rear side window blinds
- Body-colour front bumper
- Body-colour rear bumper (L1 only)
- Chrome-effect front grille
- Front fog lights
- Rear-view camera
- Rain-sensitive windscreen wipers
- Electro-chromatic rear-view mirror
- LED daytime running lights
- Xenon headlights
- Dark-tinted rear windows
- Electrically folding door mirrors
- Side blind spot alert
- Front and rear parking distance sensors
- Panoramic glass roof
- Curtain airbags for second-and third-row passengers
- Tailgate with separate opening rear window
- Keyless open and start
- 17-inch bi-colour alloy wheels
- Driver Assistance Pack

VIVARO-E LIFE EDITION/COMBI



VX_VIVL_31733

EDITION/COMBI L (LONG) ON-THE-ROAD PRICES

	OTR RRP	Insurance Group
3100 100kW (136PS) Automatic	£32,495*	-

Please note: On-the-road recommended retail prices (RRP) include number plates and delivery to Retailer of £583.33, 12 months' Vehicle Excise Duty and new vehicle first registration fee of £55.00. Excludes fuel and insurance.

*Price shown is after allowing for PiCG (Plug-in Car Grant).

FEATURES

Infotainment:

- AM/FM/DAB digital radio
- Bluetooth® audio streaming
- Bluetooth® mobile phone portal
- USB audio connection

Interior convenience/styling:

- Air conditioning
- Multi-function trip computer
- Cruise control with speed limiter
- Vauxhall Connect box
- Steering column mounted audio and phone controls
- Dual front passengers' seat with underseat storage
- Second-row three-passenger foldable 60/40 split bench seat
- Third-row three-passenger foldable bench seat

Exterior convenience/styling:

- Electrically adjustable/heated door mirrors
- Electrically operated front windows
- Nearside and offside sliding side-access glazed doors
- Tailgate with wash/wipe and heated rear window
- Side-protection mouldings

Safety/security:

- Driver and front passenger's airbags
- Driver and front passenger's curtain and side-impact airbags
- Height-adjustable lap and diagonal inertia-reel seatbelts
- Electronic stability programme with traction control
- Anti-lock braking system
- Tyre pressure monitoring system
- Hill start assist
- Daytime running lights
- Remote control central deadlocking
- Selective door locking
- Electronic engine deadlock immobiliser
- Automatic transmission with e-toggle shift
- Electric parking brake
- Remote control security alarm system

VIVARO-E LIFE ELITE



VX_VIVL_29503

ELITE L (LONG) ON-THE-ROAD PRICES

	OTR RRP	Insurance Group
3100 100kW (136PS) Automatic	£49,465	36E

Please note: On-the-road recommended retail prices (RRP) include number plates and delivery to Retailer of £583.33, 12 months' Vehicle Excise Duty and new vehicle first registration fee of £55.00. Excludes fuel and insurance.

FEATURES

Infotainment:

- Multimedia Navi Pro
 - Fully integrated European sat nav system
 - 7-inch colour touchscreen
 - Voice control
 - AM/FM/DAB digital radio
 - Bluetooth® audio streaming
 - Bluetooth® mobile phone portal
 - USB audio connection
 - Second USB charging connection
 - Four speakers

Interior convenience/styling:

- Leather seat trim
- Six-way electrically adjustable heated driver's seat with massage facility
- Four-way electrically adjustable heated single front passenger's seat with massage facility
- Second-row three-passenger foldable 60/40 split bench seat
- Third-row three-passenger foldable 60/40 split individually sliding bench/single seat
- Dual-zone electronic climate control
- Roof-mounted rear heater controls
- Electro-chromatic rear-view mirror
- Head-up display
- Multi-function trip computer
- Cruise control with speed limiter
- Electronic parking brake
- Vauxhall Connect box
- Steering column mounted audio and phone controls
- Rear-view child-minder mirror
- Rear seat back tables
- Rear side window blinds
- Rear parcel shelf
- Luggage floor net

Exterior convenience/styling:

- Heat-reflective windscreen
- Front fog lights
- Panoramic glass roof
- Rear-view camera
- Rain-sensitive windscreen wipers
- Xenon headlights.
- Keyless entry/engine start/stop
- Electrically adjustable/heated door mirrors
- Electrically folding door mirrors
- Electrically operated front windows with one-touch facility
- Nearside and offside sliding side-access glazed doors
- Hands-free electrical operation of sliding side-access doors
- Tailgate with wash/wipe and heated opening rear window
- Body-colour front bumper
- Body-colour rear bumper (L1 only)
- Chrome-effect front grille
- Side-protection mouldings
- 17-inch bi-colour alloy wheels

Safety/security:

- Side blind spot alert
- Driver and front passenger's airbags
- Curtain airbags for second- and third-row passengers
- Height-adjustable front lap and diagonal inertia-reel seatbelts
- Electronic stability programme with traction control
- Anti-lock braking system
- Hill start assist
- LED daytime running lights
- Remote control central deadlocking
- Selective door locking
- Electronic engine deadlock immobiliser
- Remote control security alarm system
- Automatic transmission with e-toggle shift
- Driver Assistance Pack

EDITION



VX_VIVL_31732

EDITION M (MEDIUM) ON-THE-ROAD PRICES

	OTR RRP	CO ₂ (g/km)	Insurance Group
Diesel			
1.5 (120PS) Turbo D S/S	£34,615	167	20E

EDITION L (LONG) ON-THE-ROAD PRICES

	OTR RRP	CO ₂ (g/km)	Insurance Group
Diesel			
1.5 (120PS) Turbo D S/S	£34,975	168	21D

Please note: On-the-road recommended retail prices (RRP) include number plates and delivery to Retailer of £583.33, 12 months' Vehicle Excise Duty and new vehicle first registration fee of £55.00. Excludes fuel and insurance.

S/S = Start/Stop.

FEATURES

Infotainment:

- AM/FM/DAB digital radio
- Bluetooth® audio streaming
- Bluetooth® mobile phone portal
- USB audio connection

Interior convenience/styling:

- Air conditioning
- Multi-function trip computer
- Cruise control with speed limiter
- Vauxhall Connect box
- Steering column mounted audio and phone controls
- Dual front passengers' seat with underseat storage
- Second-row three-passenger foldable 60/40 split bench seat
- Third-row three-passenger foldable bench seat

Exterior convenience/styling:

- Electrically adjustable/heated door mirrors
- Electrically operated front windows
- Nearside and offside sliding side-access glazed doors
- Tailgate with wash/wipe and heated rear window
- Side-protection mouldings

Safety/security:

- Driver and front passenger's airbags
- Driver and front passenger's curtain and side-impact airbags
- Height-adjustable lap and diagonal inertia-reel seatbelts
- Electronic stability programme with traction control
- Anti-lock braking system
- Tyre pressure monitoring system
- Hill start assist
- Daytime running lights
- Remote control central deadlocking
- Selective door locking
- Electronic engine deadlock immobiliser
- Remote control security alarm system

ELITE



VX_VIVL_29460

ELITE M (MEDIUM) ON-THE-ROAD PRICES

	OTR RRP	CO ₂ (g/km)	Insurance Group
Diesel			
2.0 (180PS) Turbo D S/S automatic	£45,985	181	26E

ELITE L (LONG) ON-THE-ROAD PRICES

	OTR RRP	CO ₂ (g/km)	Insurance Group
Diesel			
2.0 (140PS) Turbo D S/S	£46,635	180	26E
2.0 (180PS) Turbo D S/S automatic	£46,965	182	27E

Please note: On-the-road recommended retail prices (RRP) include number plates and delivery to Retailer of £583.33, 12 months' Vehicle Excise Duty and new vehicle first registration fee of £55.00. Excludes fuel and insurance.

S/S = Start/Stop.

FEATURES

Infotainment:

- Multimedia Navi Pro
 - Fully integrated European sat nav system
 - 7-inch colour touchscreen
 - Voice control
 - AM/FM/DAB digital radio
 - Bluetooth® audio streaming
 - Bluetooth® mobile phone portal
 - USB audio connection
 - Second USB charging connection
 - Four speakers

Interior convenience/styling:

- Leather seat trim
- Six-way electrically adjustable heated driver's seat with massage facility
- Four-way electrically adjustable heated single front passenger's seat with massage facility
- Second-row three-passenger foldable 60/40 split bench seat
- Third-row three-passenger foldable 60/40 split individually sliding bench/single seat
- Dual-zone electronic climate control
- Roof-mounted rear heater controls
- Automatic parking heater
- Electro-chromatic rear-view mirror
- Head-up display
- Multi-function trip computer
- Cruise control with speed limiter
- Vauxhall Connect box
- Steering column mounted audio and phone controls
- Rear-view child-minder mirror
- Rear seat back tables
- Rear side window blinds
- Rear parcel shelf
- Luggage floor net

Exterior convenience/styling:

- Heat-reflective windscreen
- Front fog lights
- Panoramic glass roof
- Rear-view camera
- Rain-sensitive windscreen wipers
- Xenon headlights.
- Keyless entry/engine start/stop
- Electrically adjustable/heated door mirrors
- Electrically folding door mirrors
- Electrically operated front windows with one-touch facility
- Nearside and offside sliding side-access glazed doors
- Hands-free electrical operation of sliding side-access doors
- Tailgate with wash/wipe and heated opening rear window
- Body-colour front bumper
- Body-colour rear bumper (L1 only)
- Chrome-effect front grille
- Side-protection mouldings
- 17-inch bi-colour alloy wheels

Safety/security:

- Side blind spot alert
- Driver and front passenger's airbags
- Curtain airbags for second- and third-row passengers
- Height-adjustable front lap and diagonal inertia-reel seatbelts
- Electronic stability programme with traction control
- Anti-lock braking system
- Hill start assist
- LED daytime running lights
- Remote control central deadlocking
- Selective door locking
- Electronic engine deadlock immobiliser
- Remote control security alarm system
- Driver Assistance Pack

NEW VIVARO-E LIFE PRICES

	Pack Code	Propulsion	Price (£)	VAT (£)	Total (£)	On-the-road RRP before PiCG (£)	On-the-road RRP after PiCG (£)	Financial Year 2021/22 BiK 20% (£)	WLTP Combined CO ₂ (g/km)# - pack code	Insurance Groups
EDITION L (LONG)*										
100kW (136PS) auto – 50kWh battery	8F06 9CQ1	Electric	28,533.33	5,706.67	34,240.00	34,995.00	32,495.00	5.82	0	-
COMBI L (LONG)										
100kW (136PS) auto – 50kWh battery	8F06 9CQZ	Electric	28,533.33	5,706.67	34,240.00	34,995.00	32,495.00	5.82	0	-
ELITE L (LONG)										
100kW (136PS) auto – 50kWh battery	8RZ6 9CQ1	Electric	40,591.67	8,118.33	48,710.00	49,465.00	-	8.23	0	36E

WLTP Combined CO₂ (g/km) figures are based on a configured vehicle as per pack code for UK with no options fitted.

#The Vivaro-e Life is a battery electric vehicle requiring mains electricity for charging. Range data given has been determined according to WLTP test procedure methodology. The figures shown are intended for comparability purposes only and should only be compared other cars tested to the same technical standard. The range you achieve under real world driving conditions will depend upon a number of factors, including but not limited to: the accessories fitted (pre and post registration); charging frequency; personal driving style; vehicle load and route characteristics; variations in weather; heating/air conditioning; pre-conditioning and battery condition. For more information, contact your local Vauxhall Retailer.

Please note: On-the-road recommended retail prices (RRP) include number plates and delivery to Retailer of £700.00 (inc. £116.67 VAT), 12 months' Vehicle Excise Duty and new vehicle first registration fee of £55.00. Excludes fuel and insurance. Company Car Benefit in Kind (BiK) rates are monthly based on the standard paint price. Price has been calculated using manufacturer estimates and includes a £2,500.00 OZEV grant which has been deducted from the price of the vehicle (OZEV Grant not available in the Isle of Man). The grant is a government incentive and is subject to withdrawal prior to delivery of your vehicle. Retailers may be required to carry out more than one credit check during the course of the order process. You may be required to place a deposit when placing your order with your supplying Retailer. In the event of a price change, deposit refunds will be governed by your supplying Retailer's policy and as such must be discussed with the supplying Retailer.

*Please note, this model is available for Motability sold orders only.

NEW VIVARO LIFE PRICES

	Pack Code	Fuel Type	Price (£)	VAT (£)	Total (£)	On-the-road RRP (£)	Financial Year 2021/22 BiK 20% (£)	WLTP Combined CO ₂ (g/km)# - pack code	Insurance Groups
EDITION M (MEDIUM)									
1.5 (120PS) Turbo D	8C06 I4LW	Diesel	27,754.17	5,550.83	33,305.00	34,615.00	209.68	167	20E
EDITION L (LONG)									
1.5 (120PS) Turbo D	8C06 I4L1	Diesel	28,054.17	5,610.83	33,665.00	34,975.00	211.92	168	21D
ELITE M (MEDIUM)									
2.0 (180PS) Turbo D auto	8NZ6 ML8W	Diesel	36,945.83	7,389.17	44,335.00	45,985.00	277.70	181	26E
ELITE L (LONG)									
2.0 (140PS) Turbo D	8NZ6 MQP1	Diesel	37,487.50	7,497.50	44,985.00	46,635.00	281.72	180	26E
2.0 (180PS) Turbo D auto	8NZ6 ML81	Diesel	37,762.50	7,552.50	45,315.00	46,965.00	283.75	182	27E

New Vivaro Life's petrol and diesel engines meet the Real Driving Emissions Step 2 (RDE2) standards.

WLTP Combined CO₂ (g/km) figures are based on a configured vehicle as per pack code for UK with no options fitted.

#Fuel consumption and CO₂ figures are determined according to the WLTP test cycle. CO₂ figures, BiK values and RRP pricing shown above are for a standard vehicle without any additional optional equipment. CO₂ figures are used to calculate Vehicle Excise Duty (VED) for the first registration of the vehicle and BiK. The addition of optional extras could increase the certified CO₂ emission output. This in turn may affect the amount of VED payable upon registration, and, for company car drivers, the P11D value and the amount of Benefit in Kind (BiK) tax payable. Figures shown are for comparison purposes and should only be compared to the fuel consumption and CO₂ values of other cars tested to the same technical standard. The fuel consumption achieved, and CO₂ produced, in real world conditions will depend upon a number of factors including, but not limited to: the accessories fitted (pre and post registration); variations in weather; driving styles and vehicle load. The WLTP (Worldwide Harmonised Light Vehicles Test Procedure) is used to measure fuel consumption and CO₂ figures. Full data relating to WLTP test cycles can be found at: www.vauxhall.co.uk/wltp

Please note: On-the-road recommended retail prices (RRP) include number plates and delivery to Retailer of £700.00 (inc. £116.67 VAT), 12 months' Vehicle Excise Duty and new vehicle first registration fee of £55.00. Excludes fuel and insurance. Company Car Benefit in Kind (BiK) rates are monthly based on the standard paint price.

FEATURES/OPTIONS

SEATING

	Option code	Edition	Elite	Vivaro-e Life Edition/Combi	Vivaro-e Life Elite	Price (£) exc. VAT	Price (£) inc. VAT
Driver's seat • Reach • Backrest recline • Padded head restraint		●		●			
Dual front passengers' seat with underseat storage • Fixed position bench seat and backrest • Height-adjustable front padded head restraints		●		●			
Power driver's seat • Height • Reach • Backrest recline • Lumbar adjustment • Driver's seat armrest • Padded head restraint • Massage functions • Driver's seat memory function, including door mirrors			●		●		
Single front passenger's seat • Reach • Backrest recline • Padded head restraint • Folding backrest • Passenger's seat armrest • Massage functions • Driver's seat memory function, including door mirrors			●		●		

REAR SEATING

Second and third-row seating • Second-row three-passenger foldable 60/40 split bench seat • Third-row three-passenger foldable bench seat		●		●			
• Second-row three-passenger foldable 60/40 split bench seat			●		●		
• Third-row three-passenger foldable 60/40 split individually sliding bench /single seat			●		●		
• Two removable and reversible individual second-row seats	AW2		○		○	666.67	800.00
Foldable table on rails – Only in conjunction with AW2	TRD		○		○	412.50	495.00
Seat trim • Curitiba Tritone Grey fabric		●		●			
• Carla black leather			●		●		

● = Standard equipment. ○ = Optional at extra cost.

FEATURES/OPTIONS

SAFETY

	Option code	Edition	Elite	Vivaro-e Life Edition/Combi	Vivaro-e Life Elite	Price (£) exc. VAT	Price (£) inc. VAT
Driver Safety Pack <ul style="list-style-type: none"> • Semi-adaptive cruise control • Forward collision alert with automatic emergency braking and pedestrian detection • 3.5-inch colour information display 			●		●		
Airbag Driver and front passengers airbag: <ul style="list-style-type: none"> • Driver and front passenger's airbag with deactivation switch • Driver and front passengers' curtain and side-impact airbags 		●		●			
Driver and front passenger's airbags: <ul style="list-style-type: none"> • Driver and front passenger's airbag with deactivation switch • Driver and passenger's side-impact airbags • Full-length curtain airbags (first-, second- and third-row seating) 			●		●		
Stability Electronic Stability Programme-plus (ESP-plus) with traction control – Works in conjunction with the vehicle's electronic braking and engine systems to keep the vehicle stable in many different situations. ESP monitors a variety of inputs to determine when the vehicle starts to lose traction, it can then immediately respond by varying the brake pressure between up to three wheels and adjust the engine output to help correct the loss of traction and improve stability.		●	●	●	●		
Tyre pressure <ul style="list-style-type: none"> • Tyre pressure monitoring system 		●	●	●	●		
Braking Four-channel Anti-lock Braking System (ABS) – Prevents the vehicle's wheels from locking up under heavy braking by momentarily reducing brake pressure at the appropriate wheel, ensuring that you can maintain control of the steering. Emergency brake assist – When emergency braking is detected the vehicle automatically applies the maximum possible braking assistance. Electronic brakeforce distribution – Automatically apportions the optimum braking force to each wheel. Hill start assist – Briefly maintains rear brake pressure to stop the vehicle rolling back on an incline.		●	●	●	●		

● = Standard equipment.

FEATURES/OPTIONS

SECURITY

	Option code	Edition	Elite	Vivaro-e Life Edition/Combi	Vivaro-e Life Elite	Price (£) exc. VAT	Price (£) inc. VAT
Features • Electronic engine deadlock immobiliser • Steering column lock • Lockable fuel filler cap • Anti-theft spare wheel cradle		●	●	●	●		
Remote control door locking • Remote control door locking • Two keys with integral remote • Door deadlocks • Selective door locking		●	●	●	●		
Keyless open and start • Keyless open and start			●		●		
Security alarm system • System monitors doors, tailgate, bonnet and the passenger compartment		●	●	●	●		

● = Standard equipment.

FEATURES/OPTIONS

DRIVER ASSISTANCE

	Option code	Edition	Elite	Vivaro-e Life Edition/Combi	Vivaro-e Life Elite	Price (£) exc. VAT	Price (£) inc. VAT
Visibility Pack <ul style="list-style-type: none"> • Heat-reflective windscreen • Rain-sensitive windscreen wipers 			●		●		
Driver Assistance Pack <ul style="list-style-type: none"> • Lane departure warning • Speed Limit Information/Intelligent Speed Adaptation • Driver drowsiness system • White text Instrument panel • High beam assist 			●		●		
Electric Pack <ul style="list-style-type: none"> • Foldable electrically adjustable/heated door mirrors – When front and rear parking distance sensors are fitted. • 12v socket in saloon area • Remote key with three buttons • Electrically operated front windows with one-touch up/down facility 		●	●	●	●		
Head-up display – Projects key information onto the windscreen so that the driver's eyes remain on the road at all times. The display is adjustable for height and brightness.			●		●		
Multi-function trip computer <ul style="list-style-type: none"> • Trip odometer • Vehicle range based on remaining fuel • Average speed • Average fuel economy • Instantaneous fuel economy • Driving time 		●	●	●	●		
Parking assistance <ul style="list-style-type: none"> • Rear parking distance sensors 	UD7	○		○		183.33	220.00
<ul style="list-style-type: none"> • Front and rear parking distance sensors • Side blind spot alert • Front fog lights • Electrically folding door mirrors 	UD5		●		●		
<ul style="list-style-type: none"> • Electronic parking brake – Centre console switch in lieu of handbrake lever 				●	●		
Cruise control, speed limiter		●	●	●	●		
Instrumentation <ul style="list-style-type: none"> • Speedometer • Rev counter • Fuel gauge with low fuel warning light • Fuel economy gauge • Coolant temperature warning light 		●	●	●	●		

● = Standard equipment. ○ = Optional at extra cost.

FEATURES/OPTIONS

DRIVER ASSISTANCE CONTINUED

	Option code	Edition	Elite	Vivaro-e Life Edition/Combi	Vivaro-e Life Elite	Price (£) exc. VAT	Price (£) inc. VAT
Automatic transmission with e-toggle shift				●	●		
3.5-inch digital instrument cluster				●	●		
7.4kW single-phase on-board charger with 6m mode-3 7kW cable (added at POE)				●	●		
11kW three-phase on-board charger with mode-3 22kW cable (added at POE)	K29			○	○	300.00	360.00

COMFORT AND CONVENIENCE

Comfort • Reach and rake-adjustable steering wheel • Facia-mounted gear lever • Floor-mounted handbrake lever • Inertia-reel lap and diagonal seatbelts • Height-adjustable outer front seatbelts • Height-adjustable padded head restraints • Rear parcel shelf		●		●			
• Load area restraint net • Load area cover • Luggage floor net • Rear seat back tables • Rear-view child-minder mirror • Rear side-window blinds • Torch stowed in rear luggage area panel • 220 volt socket behind driver's seat			●		●		
Leather-covered steering wheel			●		●		

● = Standard equipment. ○ = Optional at extra cost.

FEATURES/OPTIONS

INFOTAINMENT

	Option code	Edition	Elite	Vivaro-e Life Edition/Combi	Vivaro-e Life Elite	Price (£) exc. VAT	Price (£) inc. VAT
<p>Radio BT</p> <p>Onboard features:</p> <ul style="list-style-type: none"> • AM/FM stereo radio • DAB Digital radio • RDS with Traffic Programme • 20 watts per channel output • Four speakers <p>Media connections:</p> <ul style="list-style-type: none"> • USB connection with iPod control • Bluetooth® A2DP audio streaming (Advanced Audio Distribution Profile) <p>Mobile phone portal:</p> <ul style="list-style-type: none"> • Bluetooth® connectivity • Handsfree calls via steering wheel controls • Vehicle microphone 		●		●			
<p>Multimedia</p> <p>Onboard features:</p> <ul style="list-style-type: none"> • 7-inch colour touchscreen • AM/FM stereo radio with 25 Station presets • DAB Digital radio • RDS with Traffic Programme • 20 watts per channel output • Four speakers <p>Media connections:</p> <ul style="list-style-type: none"> • USB connection with iPod control • Bluetooth® A2DP audio streaming (Advanced Audio Distribution Profile) <p>Mobile phone portal:</p> <ul style="list-style-type: none"> • Bluetooth® connectivity • Handsfree calls via steering wheel controls • Vehicle microphone • Phone book access – Contacts/last calls/missed calls etc. are mirrored on the display and are easily navigated using the touchscreen (features dependent on mobile phone). • Bluetooth® connectivity • Handsfree calls via steering wheel controls • Vehicle microphone <p>Smartphone interface:</p> <ul style="list-style-type: none"> • Apple CarPlay • Android Auto™ – Smartphone projection that allows operations via voice command, touchscreen and buttons to control apps and music playback. 	i05	○		○		400.00	480.00

● = Standard equipment. ○ = Optional at extra cost.

FEATURES/OPTIONS

INFOTAINMENT CONTINUED

	Option code	Edition	Elite	Vivaro-e Life Edition/Combi	Vivaro-e Life Elite	Price (£) exc. VAT	Price (£) inc. VAT
<p>Multimedia Navi Pro</p> <p>Onboard features:</p> <ul style="list-style-type: none"> • 7-inch colour touchscreen • AM/FM stereo radio with 15 Station presets • DAB Digital radio • RDS with Traffic Programme • 20 watts per channel output • Ten speakers <p>Navigation features:</p> <ul style="list-style-type: none"> • Satellite navigation system • 3D street level mapping • European coverage • Structured or one-box destination entry • Points-of-interest search • Eco routing • Map updates via USB <p>Wi-fi enabled connected navigation features:</p> <ul style="list-style-type: none"> • Three years subscription to TomTom Live* • On-line navigation services provided by TomTom® include: • TomTom® live traffic updates • Local weather information • Nearby fuel station display • Local address search and contact info for points of interest <p>Media connections:</p> <ul style="list-style-type: none"> • USB connection with iPod control • Bluetooth® A2DP audio streaming (Advanced Audio Distribution Profile) <p>Mobile phone portal:</p> <ul style="list-style-type: none"> • Bluetooth® connectivity • Handsfree calls via steering wheel controls • Vehicle microphone • Phone book access – Contacts/last calls/missed calls etc. are mirrored on the display and are easily navigated using the touchscreen (features dependent on mobile phone). <p>Smartphone interface:</p> <ul style="list-style-type: none"> • Apple CarPlay • Android Auto™ – Smartphone projection that allows operations via voice command, touchscreen and buttons to control apps and music playback. <p>Vivaro-e Life shortcut key: Provides dedicated shortcut key for LEV-specific pages:</p> <ul style="list-style-type: none"> • Energy flow visualization • Energy stats visualization • Deferred charging options • Thermal pre-conditioning • Battery/range check 	i06	○	●	○	●	541.67	650.00
<p>Additional features</p> <ul style="list-style-type: none"> • Steering column mounted audio controls • Flexible roof-mounted aerial 		●	●	●	●		
<p>Four speakers</p>		●		●			
<p>Ten speakers (HiFi Pack)</p>			●		●		

*Additional terms and conditions apply to connected services, including customer acceptance of location sharing prior to activation.

● = Standard equipment. ○ = Optional at extra cost.

FEATURES/OPTIONS

HEATING AND VENTILATION

	Option code	Edition	Elite	Vivaro-e Life Edition/Combi	Vivaro-e Life Elite	Price (£) exc. VAT	Price (£) inc. VAT
Air conditioning • Air recirculation facility • Pollen filter • Illuminated controls • Chilled glovebox facility		●	●	●	●		
Electronic climate control • LCD temperature display • Automatic air direction and fan speed with manual override • Illuminated controls • Pollen filter • Chilled glovebox facility			●		●		
Rear air conditioning • Multi-function overhead panel with separate controls for the rear cabin • Six multi-function air nozzles • Fixed side air vents			●		●		
Automatic parking heater			●				

LOAD ACCESS

Nearside and offside access Nearside and offside sliding side-access door with fixed windows: • Fixed window to nearside side-access door • Fixed window to offside side-access door		●	●	●	●		
Handsfree electrically operated sliding side-access doors: • Keyless open and start • Auto anti-dazzle rear-view mirror			●		●		
Rear access Rear glazed doors: • Glazed rear doors • 90°/180° opening • Heated rear windows with wash/wipe facility	J1X	○		○		200.00	240.00
Tailgate: • Glazed tailgate • Heated rear windows with wash/wipe facility		●		●			
• Glazed tailgate with opening window • Heated rear windows with wash/wipe facility			●		●		
Vertical safety net	APT	○	○	○	○	100.00	120.00

● = Standard equipment. ○ = Optional at extra cost.

FEATURES/OPTIONS

EXTERIOR LIGHTING

	Option code	Edition	Elite	Vivaro-e Life Edition/Combi	Vivaro-e Life Elite	Price (£) exc. VAT	Price (£) inc. VAT
Standard lighting • Lights-on audible warning • Reversing lights • Hazard warning lights • Rear fog lights • High-level brake light • Side-repeat indicators • Daytime running lights – LED on Elite models.		●	●	●	●		
• Xenon headlights			●		●		

EXTERIOR CONVENIENCE/STYLING

Appearance Pack • Body-colour front bumper • Body-colour rear bumper (L1 only) • Body-colour mirror housings and door handles • Body-colour side-protection mouldings • Chrome-effect front grille • Front fog lights • LED daytime running lights			●		●		
Full-length panoramic glass sunroof with manually-sliding sunblinds			●		●		
Dark-tinted rear glazing (opacity level approximately 70%)	AKO	○	●	○	●	100.00	120.00
Conversions Connector for conversions	WRF	○		○		90.00	108.00

TOWING

 Tow bar • Removable monoblock towing ball without tool	VQ9	○	○			250.00	300.00
--	-----	---	---	--	--	--------	--------

● = Standard equipment. ○ = Optional at extra cost.

NEW VIVARO-E LIFE FEATURES

TRANSMISSION

Single-speed electronic drive selector

All-electric single speed drive means there is no need for multiple gears. Instead the e-toggle enables the driver to select from the following:

- Park
- Reverse
- Neutral
- Drive
- Braking – for increased regenerative braking

Drive mode selector

The driver can determine the driving style through selecting one of the following modes:

- Power (136PS) – increased performance for use when transporting heavier loads
- Normal (109PS) – optimised performance for normal daily use
- Eco – (82PS) tailored to provide the lowest energy consumption

BRAKING

Energy recuperation

The regenerative braking system works when the vehicle is in motion, energy created by the resistance of the brakes against the drivetrain is converted into DC voltage to partially recharge the battery. The driver can also engage braking mode through the drive selector to increase the level of energy recuperation.

Single foot driving experience







The system not only utilises the energy when the brakes are being used, but also engages when the vehicle is coasting, recovering more energy and enabling single foot driving as the brakes automatically engage when the throttle pedal is released.

Vivaro-e Life
Edition/Combi

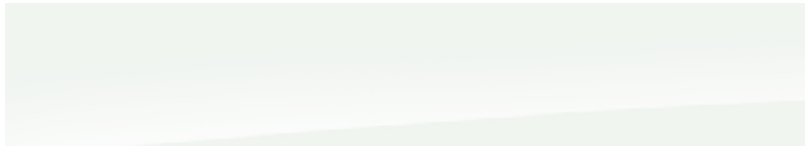
Vivaro-e
Elite

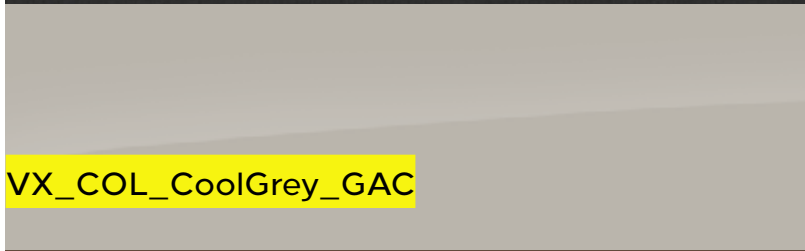
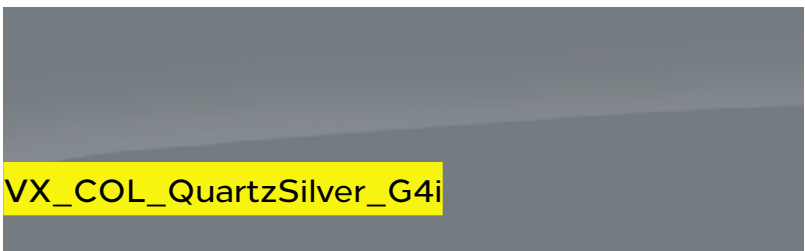



EXTERIOR COLOURS

		Edition	Elite	Vivaro-e Life Edition/Combi	Vivaro-e Life Elite	Price (£) exc. VAT	Price (£) inc. VAT
Solid	 <p>Jade White (G2o)</p> <p>VX_COL_White_Jade_G2o</p>	●	●	●	●		
	 <p>Moonstone Grey metallic (G4o)</p> <p>VX_COL_MoonstoneGrey_G4o</p>	○	○	○	○	500.00	600.00
 <p>Cool Grey metallic (GAC)</p> <ul style="list-style-type: none"> • Not available on Edition models <p>VX_COL_CoolGrey_GAC</p>	 <p>Quartz Grey metallic (G4i)</p> <p>VX_COL_QuartzSilver_G4i</p>						
 <p>Rich Oak Brown metallic (GoJ)</p> <ul style="list-style-type: none"> • Not available on Edition models <p>VX_COL_RichOakBrown_GoJ</p>	 <p>Amber Red metallic (GoX)</p> <ul style="list-style-type: none"> • Not available on Edition models <p>VX_COL_AmberRed_GoX</p>						
Two-coat	 <p>Diamond Black metallic (G7o)</p> <p>VX_COL_DiamondBlack_G7o</p>						

The colours reproduced may vary slightly from the actual paint colour. As a result they should be used as a guide only. Your Vauxhall Retailer has a comprehensive display of our paint samples.

● = Standard equipment. ○ = Optional at extra cost.

WHEELS AND TYRES



	Option code	Edition	Elite	Vivaro-e Life Edition/Combi	Vivaro-e Life Elite	Price (£) exc. VAT	Price (£) inc. VAT
Tyre inflation kit		●	●	●	●		
 <p>16-inch steel wheels with centre cap • 215/65 R 16 tyres</p> <p>VX_VIV_29655</p>		●		●			
 <p>17-inch diamond-cut alloy wheels • 215/60 R 17 tyres • Locking wheel bolts</p> <p>VX_VIV_29648_WQX</p>			●		●		

● = Standard equipment.

PERFORMANCE, FUEL ECONOMY AND EMISSIONS

	Performance (manufacturer's figures)		Fuel economy mpg (litres/100km) [#]		CO ₂ emissions g/km [#]		Vehicle Excise Duty*		BiK rates from - 2020/21 tax year
	Maximum speed (mph)	Acceleration 0-60mph (sec)	Combined Low	Combined High	Combined Low	Combined High	First year rate	Standard rate	
1.5 (120PS) Turbo D	100	14.3	42.2 (6.7)	44.1 (6.4)	167	176	£555	£155	37%
2.0 (140PS) Turbo D	105	12.0	38.7 (7.3)	40.9 (6.9)	180	191	£895	£155	37%
2.0 (180PS) Turbo D auto	105	10.4	38.2 (7.4)	40.9 (6.9)	181	195	£895	£155	37%

Tyre Rating

Tyre size	Type	Fuel efficiency group	Wet grip performance	External noise	
				Measured (dB)	Group
215/65 R 16	Summer	C	A	72	
215/60 R 17	Summer IntelliGrip	C	A	72	
215/60 R 17	All season	E	B	71	

Tyre rating according to EU Regulation 1222/2009

[#]Figures shown are for comparison purposes and should only be compared to the fuel consumption and CO₂ values of other cars tested to the same technical standard. The fuel consumption achieved, and CO₂ produced, in real world conditions will depend upon a number of factors including, but not limited to: the accessories fitted (pre and post registration); variations in weather; driving styles and vehicle load. The WLTP (Worldwide Harmonised Light Vehicles Test Procedure) is used to measure fuel consumption and CO₂ figures. The CO₂ figures display a range to reflect the highest value for the highest emitting version with all available options added, through to a minimum value to represent the lowest emitting version in standard specification.

*Correct at time of publication.

DIMENSIONS AND CAPACITIES

Loadspace Dimensions	M (MEDIUM)	L (LONG)
Maximum load length – Passenger’s seat folded	3161 (124.5)	3511 (138.2)
Maximum load length – Behind front seats	2413 (95.0)	2763 (108.8)
Maximum width	1618 (63.7)	1618 (63.7)
Width between wheel arches	1228 (48.3)	1228 (48.3)
Maximum height	1337 (52.6)	1339 (52.7)
Loadspace Access		
Side door aperture height	1181 (46.5)	1181 (46.5)
Side door aperture width	933 (36.7)	933 (36.7)
Rear door aperture height	1181 (46.5)	1181 (46.5)
Rear door aperture width	1212 (47.7)	1212 (47.7)
Loading height – Maximum	653 (25.7)	664 (26.1)
Loading height – Minimum	584 (23.0)	584 (23.0)

Loadspace Volumes cu.m (cu.ft.)	M (MEDIUM)	L (LONG)
Maximum volume to roof level	3.9 (137.7)	4.5 (158.9)
Maximum volume to seat back level	3.0 (105.9)	3.5 (123.6)
Exterior dimensions		
Overall length	4956 (195.1)	5306 (208.9)
Width – including door mirrors	2204 (86.8)	2204 (86.8)
Width – excluding door mirrors	1920 (75.6)	1920 (75.6)
Height – manual models	1925 (75.8)	1925 (75.8)
Height – automatic models	1935 (76.2)	1935 (76.2)
Wheelbase	3275 (129.0)	3275 (129.0)
Front overhang	881 (34.7)	881 (34.7)
Rear overhang	803 (31.6)	1153 (45.4)

NEW VIVARO-E SPECIFICATIONS

DRIVETRAIN

BATTERY ENERGY KWH	50
Location	under load floor – no impact to loading volume
CO ₂ emissions	0g/km
EV range (WLTP Combined) miles*	143
Battery consumption (Combined low/high)	23.0-28.2kWh/100km
Maximum power PS/kW	136/100
Maximum torque Nm/lb.ft	260/192
Maximum speed mph	81
Acceleration 0-62mph seconds	13.1
Battery warranty	8 years 100,000 miles/70% capacity
Service interval	Initial inspection at 12,500 miles/1 year (whichever comes sooner). Main service at 25,000 miles/2 year (whichever comes sooner)

Please note, EV range assumes that vehicle has been pre-conditioned prior to journey. This function can be accessed either via MyVauxhall App (standard with all Vivaro-e Life) or by using the Multimedia Navi Pro infotainment system (standard on Elite and optional on Edition).

CHARGING**

Supply	AC Current		DC Current	
	Domestic 8amp	Wallbox 32amp Single-phase	Wallbox 16amp Three-phase	Rapid charge [†] 0-80%
	1.8kWh	7.4kWh	11.kWh ^{††}	100kWh
50kWh battery	28h	7h 30m	4h 45m	30m

The Vivaro-e Life is fitted with a 7.4kW on-board charger as standard together with a mode-3 7kW 6m charging cable. An 11kW on-board charger is available as an extra cost option.

The charging flap's Padlock LED lights up when the cable is correctly plugged in and locked and then acts as a user interface to show the charging status via coloured LED lights:

- White – welcome light that helps to light up the area, especially useful in dark conditions
- Flashing green – charging in progress
- Solid green – charging complete
- Solid blue – delayed charging toggled; changes to flashing green when charging commences
- Solid red – malfunction

The driver may also choose from two settings:

- Immediate charging (the standard setting) – starts charging as soon as the vehicle is docked for charging
- Delayed charging – this is especially useful for when cheaper electric rates are desired, e.g. charging at night. Simply enter a charging start time

The Vivaro-e Life is a battery electric vehicle requiring mains electricity for charging. Range data given has been determined according to WLTP test procedure methodology. The figures shown are intended for comparability purposes only and should only be compared to other cars tested to the same technical standard. The range you achieve under real world driving conditions will depend upon a number of factors, including but not limited to: the accessories fitted (pre and post registration); charging frequency; personal driving style; vehicle payload and route characteristics; variations in weather; heating/air conditioning; pre-conditioning and battery condition. For more information, contact your local Vauxhall Retailer.

*WLTP figure includes 50% payload.

**Provisional data.

[†]You can obtain 0-80% of the vehicle charge in as low as 32 minutes from a 100kW rapid charging station. Rapid charging stations are widely available across the UK at various locations and their power rating varies, typically from 50kW and sometimes up to 350kW. The charging time may vary according to the type and power of the charging station, the outside temperature at the charging point and the battery temperature.

^{††}With optional 11kWh on-board charger.

SPECIFICATIONS

Transmission

Six-speed manual gearbox:

- Front-wheel drive • Transverse engine/gearbox

Eight-speed automatic transmission:

- Front-wheel drive • Transverse engine/gearbox

Replacing the traditional lever, the automatic transmission selection-mode dial/drive wheel is an innovative solution that is both elegant and intuitive.

By simply twisting the dial, the following modes can be selected:

- Park, for when the vehicle is stationary and the wheels are locked
- Drive, for automatic forward motion
- Neutral, for when the vehicle is stationary, wheels are free
- Reverse, for automatic backward motion

For an extra experience of dynamism, the shift paddles for automatic transmissions are located behind the steering wheel, offering drivers an extra level of control that is highly ergonomic and intuitive. The shift paddles function in the following way:

- To go up a gear, the driver must pull the right lever towards themselves
- To go down a gear, the driver must pull the left lever towards themselves – Please note: only consecutive gear changes are possible.

Steering

- Hydraulic power-assisted rack and pinion system
- Energy absorbing steering column
- Turning circle (kerb-to-kerb): 12.4m (40.7ft.)

Brakes

Front ventilated disc brakes:

- 304mm x 28mm

Rear disc brakes:

- 290mm x 12mm

Fuel tank capacity

- 70 litres (15.4 gallons)

AdBlue® tank capacity

- 22.5 litres (4.95 gallons)

Start/stop technology

New Vivaro Life's Start/Stop system, fitted as standard to all models offers real benefits by improving fuel economy and reducing CO₂ emissions, particularly in town. It does this by automatically stopping the engine when you come to a standstill, and then restarting as you prepare to move off.

Before automatically stopping the engine a number of system checks are carried out to ensure that it is both safe and practical to do so.

To ensure safety, the driver must depress the clutch pedal, shift in to neutral, and then release the clutch pedal. System checks carried out before Auto Stop activates include:

- Start/Stop system is not manually deactivated via the facia button
- Sufficient brake vacuum is available to prevent the car rolling down an incline
- Battery is in good condition and charged
- Outside air temperature and engine temperature are above specified minima
- Electronic climate control (where fitted) is not in maximum heating or maximum cooling mode
- Self-cleaning function of the diesel particulate filter is not active

If all of these conditions are satisfied then the vehicle will Auto Stop.

When you are ready to pull away from standstill, Auto Restart is activated by depressing the clutch pedal.

Whilst at a standstill the vehicle is continually monitored. If necessary, the engine will automatically be restarted. Conditions that would initiate an Auto Restart include:

- Low battery level
- Brake vacuum below specified minimum
- Start/Stop system is manually deactivated
- Stationary for 5.5 minutes

Weights and Towing Data kg

	Gross vehicle weight	Maximum towing weights Trailer with brakes
LIFE EDITION M (MEDIUM) EURO 6D TEMP (6.2)		
1.5 (100PS) Turbo D S/S	2830	1400
LIFE ELITE M (MEDIUM) EURO 6D TEMP (6.2)		
2.0 (140PS) Turbo D S/S	3100	1900
2.0 (180PS) Turbo D S/S automatic	3100	1800
LIFE EDITION L (LONG) EURO 6D TEMP (6.2)		
1.5 (120PS) Turbo D S/S	2830	1400
LIFE ELITE L (LONG) EURO 6D TEMP (6.2)		
2.0 (140PS) Turbo D S/S	3100	1900
2.0 (180PS) Turbo D S/S automatic	3100	1800

S/S = Start/Stop.

Gross vehicle weight is the total permissible weight of the vehicle including passengers and their luggage. The maximum roof rack loading should not exceed 170kg on all models. The maximum towing weights are based on the ability of the car, with two occupants of 75kg each, to restart on a 12% gradient, which is approximately 1 in 8.3, at sea level. The permitted trailer load applies up to the specified incline and up to an altitude of 1000 metres above sea level. The permissible gross train weight decreases by 10% for every 1000 metres of additional altitude. Any extra weight, such as luggage or additional passengers, should be deducted from the maximum towing weight. Always fit Vauxhall towing attachments and accessories available from your Vauxhall Retailer. They are designed specifically for Vauxhall models and carry a 12-month guarantee. During trailer towing do not exceed a maximum speed of 60mph. This speed limit is also applicable in countries with higher permitted speeds for trailer-vehicle combinations. Pay attention to the local speed limits. For trailers with low driving stability and caravans the use of an oscillation damper is strongly recommended.

DIESEL ENGINES

Engine	1.5 (120PS) Turbo D Start/Stop BlueInjection	2.0 (140PS) Turbo D Start/Stop BlueInjection
Capacity	1499cc	1997cc
Maximum power	120PS (88kW) @ 3500rpm	140PS (102kW) @ 3500rpm
Maximum torque	300Nm (221 lb.ft.) @ 1750rpm	370Nm (273 lb.ft.) @ 2000rpm
Configuration	4 cylinders, 4 valves per cylinder, double overhead camshafts	4 cylinders, 4 valves per cylinder, double overhead camshafts
Emission compliance	Euro 6d	Euro 6d
Service interval	25,000 miles or 2 years (whichever occurs sooner)	30,000 miles or 2 years (whichever occurs sooner)

Engine	2.0 (180PS) Turbo D Start/Stop BlueInjection
Capacity	1997cc
Maximum power	180PS (130kW) @ 3500rpm
Maximum torque	400Nm (295 lb.ft.) @ 2000rpm
Configuration	4 cylinders, 4 valves per cylinder, double overhead camshafts
Emission compliance	Euro 6d
Service interval	30,000 miles or 2 years (whichever occurs sooner)

ACCESSORIES

SAFETY	Total (inc. VAT)	PROTECTION	Total (inc. VAT)	COMFORT	Total (inc. VAT)	TRANSPORT SOLUTIONS	Total (inc. VAT)
Spare wheel kit with 16-inch emergency wheel, tool kit and mounting basket (Diesel models only)	£257	Rubber mat for first row	£20	Wind deflectors for front doors (set of 2)	£80	Aluminium roof bar – single (2 or 3 needed)	£147
Philips ADR620 dash cam	£109	Carpet mat for		FlexConnect bracket	£20	Roof carriers (requires base carrier)	
Front parking sensors	£382	– First row	£71	FlexConnect hook	£27	Roof box – Thule Ocean 80	£164
Rear parking sensors	£399	– Second row	£57 – £63	FlexConnect coat hanger	£40	Roof box – Thule Ocean 200	£374
Front foglamps kit	£541	– Third row	£57	FlexConnect folding table	£65	Roof box – Thule Touring 200	£428
Child seats ¹		Anti-slip, water-resistant boot liner	£79	FlexConnect iPad mini holder	£93	Roof box – Thule Touring 700	£492
– Age group 0 (approx. 24 months/ up to 13kg)	£182	Boot liner carpet	£38 – £54	FlexConnect iPad holder	£103	Roof box – Thule Motion 800	from £426
– ISOFIX base for age group 0 ²	£230	Waterproof boot cover in coated cloth	£53	FlexConnect iPad Air holder	£103	Bike carrier – Thule FreeRide 532	£81
– Age group 1 (approx. 1-3.5 years/9-18kg)	£510	Waterproof rear seat cover in coated cloth	£39	FlexConnect Samsung Galaxy holder	£93	Bike carrier – Thule Expert 298	£134
– Age group 2/3 (approx. 3-12 years/ 15-36kg)	£186	Cargo net	£29	USB charger – 2 front and 2 rear ports	£27	Surfboard carrier – Thule 833	£82
Safety Pack – first aid kit, hi-vis vest and small warning triangle	£16	Rear bumper protector	£37	Cup holder insert		Ski/snowboard carrier	
Warning triangle	£9	Front splash guards (set of 2)	£62	– Small items	£18	– Thule Snow Pack 7324 (4 x pairs)	£143
Hi-vis safety vest – adult	£4	Rear splash guards (set of 2)	£65	– Notepad insert	£8	Ski/snowboard carrier	
Hi-vis safety vest – child 3-6 years (42cm)	£4			– Pen and holder	£10	– Thule Snow Pack 7326 (6 x pairs)	£258
Hi-vis safety vest – child 7-12 years (52cm)	£4	STYLE		Smoker's kit	£52	Towing	
First aid kit	£15	5-speed gear lever knob		Fragrance diffuser	£23	Tow bar	
Emergency seat belt cutter and hammer	£18	– Black chrome and leather	£74	Fragrance cartridge (various)	£18	– With removable tow ball	£460
Fire extinguisher (1kg) with strap	£32	– Chrome and leather	£74			– With removable swan's neck tow ball	£325
		6-speed lever knob		ELECTRICAL		– Without tow ball	£325
		– Satin chrome	£68	Mode 2 emergency charging cable (Type G)	£584	13-pin to 7-pin adapter	£29
				Mode 3 charging cable			
				– 7.4kW	£331		
				– 11kW	£371		
				– 22kW	£438		
				Cable bag	£49		
				Mode 2 Universal Charger UK kit (22kW)	£1,555		
				Accessories for Universal Charger			
				– Wall bracket	£105		
				– Bag	£65		
				– Safety lock	£20		
				– Adapter Type 2	£318		
				– Adapter Type 3c	£358		
				– Adapter (various)	£120		

Please note: Prices shown are fully fitted and painted, where applicable and include VAT. Please check with your local Vauxhall Retailer for details. It is advisable to ensure your insurance policy is adequate to cover additional fitted accessories. Prices correct at time of publication.

¹Restrictions apply to the use of child seats, please consult your vehicle user manual or Vauxhall Retailer. ²Restricted to rear seat usage only for vehicles with transponder deactivation of passenger airbag.

COMPANY CAR DRIVER AND FLEET INFORMATION

Benefit in kind company car taxation*

The car benefit charge will be the car's list price (including VAT, options and accessories fitted, delivery to Retailer and number plates, but excluding Vehicle Excise Duty and new vehicle first registration fee) multiplied by the percentage charge for the CO₂ emissions band in which the car falls (see table opposite). Multiply this figure by your personal income tax rate (20%† for Basic Rate, 40%** for Higher Rate) to calculate your annual benefit in kind tax liability.

Example:

New Vivaro Life Edition L 1.5 (120PS) Turbo D Start/Stop (CO₂ emissions 168g/km)

On-the-road RRP	£34,975.00
Deduct: Vehicle Excise Duty	(£555.00)
New vehicle first registration fee	(£55.00)
Effective list price	£34,365.00
Add: Optional two-coat metallic paint	£600.00
List price for tax purposes (P11D value)	£34,965.00
Car benefit charge 2021-22 tax year (37%)	£12,938.00
Benefit in kind tax liability (2021-22 tax year)	
Basic Rate (20%) tax payer	£2,587.60
Higher Rate (40%) tax payer	£5,175.20

*Please note this Price Guide provides taxation information as a guide only. Vauxhall does not provide taxation guidance. Drivers should always take professional advice on their own tax position.

**Excludes residents of Scotland.

BiK for Scottish Residents

Effective 6 April 2018 the Scottish Government have introduced their own BiK taxation structure. This only applies to Company Car Drivers that are Scottish taxpayers. HMRC will determine whether or not an individual is a Scottish taxpayer based on where their main place of residence is.

The BiK rates for Scotland are:

- Over £12,570-£14,667 Starter Rate 19%
- Over £14,667-£25,296 Basic Rate 20%
- Over £25,296-£43,662 Intermediate Rate 21%
- Over £43,662-£150,000 Higher Rate 41%
- Above £150,000 Top Rate 46%

CO ₂ emissions (g/km)	Percentage of cars price to be taxed 2021-22 tax year
Up to 50	13%
51-54	14%
55-59	15%
60-64	16%
65-69	17%
70-74	18%
75-79	19%
80-84	20%
85-89	21%
90-94	22%
95-99	23%
100-104	24%
105-109	25%
110-114	26%
115-119	27%
120-124	28%
125-129	29%
130-134	30%
135-139	31%
140-144	32%
145-149	33%
150-154	34%
155-159	35%
160-164	36%
165-169	37%
170+	37%

CO ₂ emissions (g/km)	Electric range (miles)	Percentage of cars price to be taxed 2021-22 tax year
0	-	1%
1-50	130+	1%
1-50	70-129	4%
1-50	40-69	7%
1-50	30-39	11%
1-50	<30	13%

To calculate your own personal liability, search: **Vauxhall BiK**, or click the link below: [Vauxhall BiK Tool](#)

Company Car Driver Free 3 Day Test Drive

Our free† 3 Day Test Drive programme is open to all Company Car Drivers which allows you to choose any model in the current Vauxhall line-up (exclusions apply). With full insurance cover provided, it gives you a meaningful length of time to make an informed decision about your next company car.

Search Vauxhall 3DTD to book your free† test drive or click the link the below:

[Vauxhall 3 Day Test Drive](#)

†The free 3 Day Test Drive programme is open to Company Car Drivers and Fleet Decision Makers. Available for UK Mainland only. Terms and conditions apply. Full terms and conditions can be found at vauxhallfleet.co.uk/testdrive/index/terms.

Fleet Toolbox

Discover the facts in our online Toolbox for both Company Car Drivers and Fleet Decision Makers. The Fleet Toolbox has a host of useful calculators, comparators, interactive listings and information.

Search Vauxhall Fleet Tools or click the link below:

[Vauxhall Fleet Tool Box](#)

Contact Vauxhall Fleet

Please contact one of our dedicated sales teams who will be happy to help with your particular enquiry.

Company Car Drivers

Call: 0345 111 2020

Email: company-car@vauxhallinfo.co.uk

Telephone lines are open

- Monday to Friday 8:00am-9:00pm

- Saturday and Sunday 9:00am-6:00pm

Fleet Decision Makers

Depending on the size of your fleet of vehicles, we have a dedicated team to handle your enquiries. The lines are open Monday to Friday excluding Bank Holidays.

1-24 vehicles

Call: 0845 076 2254 (8:30am-5:00pm)

25+ vehicles

Call: 0330 587 8222 (8:30am-5:00pm)

Email: vauxhallfleet@vauxhall.co.uk

Special Vehicles (Police, Fire and Ambulance)

Call: 01582 409999 (8:30am-5:00pm)

Email: vauxhallspecialvehicles@vauxhall.co.uk

For more information visit www.vauxhall.co.uk/fleet

FURTHER INFORMATION

On-the-road prices

To eliminate uncertainty about hidden costs when buying a new car, Vauxhall publishes on-the-road recommended retail prices (RRP) and these are shown in the pricing tables within this price guide. These prices include VAT, number plates and delivery to Retailer of £700.00 (including £116.67 VAT), 12 months' Government Vehicle Excise Duty (see opposite for details) and the DVLA new vehicle first registration fee of £55.00.*

Please note: The on-the-road recommended retail price (RRP) does not include fuel supplied by the Retailer, motor insurance or any other goods or services supplied by agreement between the Retailer and the customer.

Price protection

Order a new Vauxhall for build in the current model year (as confirmed by your Retailer) for delivery no more than three months in advance and the price you are quoted is the price you pay. This is irrespective of any subsequent price rises between placing your order and delivery of your new car, but you must take delivery as soon as the car is available. Vauxhall Motors Limited is not liable for price adjustments caused by Government changes in the rate of VAT (currently 20%), Vehicle Excise Duty, DVLA new vehicle first registration fee or by any other applicable legislation or regulations.

In the event of an accident

Vauxhall Accident Management helps keep you mobile following an accident. Benefits include vehicle recovery, Vauxhall-approved repairs and contacting your insurer. For more details, visit www.vauxhall.co.uk/AccidentManagement

Free2Move Lease

Whether you're a big company or a small business looking for vehicle financing, Free2Move Lease, our business finance specialists, can deliver exactly what you need.

Free2Move Lease is one of the UK's largest leasing companies and is also a member of the British Vehicle Rental and Leasing Association (BVRLA).

With over 60,000 vehicles in the Free2Move Lease portfolio, Free2Move Lease is able to offer competitive vehicle solutions. In addition, Free2Move Lease also offer innovative connected management of servicing and maintenance.

For further information, please contact your local Vauxhall Retailer or visit www.vauxhall.co.uk/offers-finance/business-leasing.html

Vehicle Excise Duty

The amount of Vehicle Excise Duty (road fund licence) payable on new cars varies depending on the level of carbon dioxide (CO₂) emissions produced by the vehicle. CO₂ emissions are measured in grams per kilometre (g/km) travelled and divided into 13 charging bands shown in the table opposite.

A 'first year rate' of Vehicle Excise Duty is payable on all new cars and in subsequent years the amount payable reverts to the 'standard rate'. From 1 April 2017 the breakpoints for each of these bands have been revised. Also, for vehicles with a list price over £40,000, including factory-fitted options, an additional £335 is payable for the first five years of standard rate payments.

Vehicle Excise Duty*

Band	CO ₂ emissions in grams per kilometre	First year rate Petrol/Diesel	Standard rate Petrol/Diesel	Standard rate Electric
A	0	£0	£0	£0
B	1-50	£10	£155	£0
C	51-75	£25	£155	£0
D	76-90	£115	£155	£0
E	91-100	£140	£155	£0
F	101-110	£160	£155	£0
G	111-130	£180	£155	£0
H	131-150	£220	£155	£0
I	151-170	£555	£155	£0
J	171-190	£895	£155	£0
K	191-225	£1,345	£155	£0
L	226-255	£1,910	£155	£0
M	Over 255	£2,245	£155	£0

*Correct at time of issue.

FURTHER INFORMATION

Customer Care Commitment

For added peace of mind, Vauxhall has an innovative Customer Care Commitment that offers the following:

- Three-year vehicle warranty consisting of a one-year/unlimited mileage manufacturer's warranty and a second and third year manufacturer's warranty with a 60,000 miles limitation
- Vauxhall Assistance for 12 months from first registration
- Six years' body panel anti-perforation warranty

Please note: Warranty is only available on vehicles sourced from Vauxhall Motors Limited. Terms and conditions apply – please see your Vauxhall Retailer for details.

Vauxhall Assistance

Vauxhall Assistance is provided automatically with every new Vauxhall for 12 months from first registration and covers everything from accident assistance, roadside recovery and 'at home' service to flat tyres. For even more peace of mind, on Vivaro-e life models the cover is extended* to 8 years or 100,000 miles, whichever comes first. Even more reason for you to stay calm and let us take care of everything should the need arise. With Vauxhall Assistance help is literally just a free** phone call away, 24 hours a day, 365 days a year!

Protecting the environment

Vauxhall's commitment to the environment is demonstrated by our products' many environmental awards. For even more information on Vauxhall's efforts to achieve an environmentally sustainable future, and how to dispose of your end-of-life vehicle, see www.vauxhall.co.uk/recycling

Vauxhall Care

This all-inclusive service package is available on Vauxhalls under 10 months old (from date of first registration).

This package offers complete peace of mind for the first 3 years of your Vauxhall's life with fixed monthly payments for the plan duration.

- **3 years' Vauxhall servicing** – covers first, second and third annual services. Including a brake-fluid change in the second service
- **2 years' Vauxhall Roadside Assistance** – first year from us
- **First years' MOT[†]** – free of charge by your local Vauxhall Retailer

For full terms and conditions and to sign up, visit: vauxhall.co.uk/vauxhallcare

Vauxhall Service Club

Vauxhall Service Club is available for all Vauxhall owners, and it's free to join. Members benefit from the following:

- 15% off Vauxhall Approved Accessories
- Vauxhall's aged 2-3 Years = 15% off parts and labour
- Vauxhall's aged over 3 Years = 25% off parts and labour
- Half price MOT's (NI excluded)
- Free pre-MOT test inspection (NI only)
- Fixed price AdBlue[®] Refills
 - Car = £14.99
 - Van = £24.99
- Access to the Vauxhall Accident Management Programme
- Online service booking available 24/7 with servicing appointments available within 3 days – [Book Online](#)
- Collection and delivery/onward mobility options
- Complimentary 'Wash and Vac' with all routine services^{††}
- Vauxhall trained technicians
- Genuine Vauxhall parts
- Minimum 12 months warranty on parts and labour
- Regular newsletters with exclusive offers, discounts and competitions

Terms and conditions apply. To join visit: vauxhall.co.uk/serviceclub

Vauxhall Insurance with added reassurance

Comprehensive cover – Summary of benefits

- Competitive premiums
- Repairs by a Vauxhall-trained technician
- Genuine Vauxhall parts, guaranteed for five years when we repair your car within our Approved Repairer Network
- Free courtesy car as standard when using an Approved Repairer[‡]
- 24 hour claims helpline
- Personal Accident benefit
- Cover for audio equipment
- Windscreen cover

Call for a quote on 0330 678 1130^{##}

For more product information

For further information on the Vauxhall range or location of your nearest Vauxhall Retailer please call **0345 600 1500**. Alternatively, details can be found on our website at vauxhall.co.uk

For more information call **0345 600 1500**

For Fleet enquiries call **0330 587 8222**

Discover the full Vauxhall range at **[vauxhall.co.uk](https://www.vauxhall.co.uk)**

Join us online

The invoice price, including delivery to Retailer, factory-fitted options, accessories fitted by the Retailer and number plates, is subject to VAT. Some feature descriptions in this guide may refer to, and some illustrations may show, optional equipment not included in the standard delivery. The information contained in this guide was accurate at the time of publication. We reserve the right to make changes in design and equipment. Please note that Vauxhall Retailers are not the agents of Vauxhall Motors Limited and are not authorised to bind Vauxhall Motors Limited by any specific or implied undertaking or representation. It is advisable to ensure that your motor insurance policy provides adequate cover for additional fitted options and accessories. The colours in this guide are only approximate actual colours. Illustrated optional equipment is available at extra charge. Availability, technical features and equipment provided on our vehicles can vary by model. For precise information on the equipment provided on our vehicles, please contact your local Vauxhall Retailer.

VAUXHALL