

Manufacturer's recommended retail prices for Vauxhall cars and accessories

Car and Accessory Price Guide

Effective from 3 October 2008 Edition 1



Pricing information

On-the-road prices

To eliminate uncertainty about hidden costs when buying a new car, Vauxhall publishes on-the-road recommended retail prices (RRP) and these are shown in the pricing tables within this price guide. These prices include the recommended cost of number plates and delivery to a Vauxhall retailer of £623.00 (including £92.79 VAT), 12 months' Government Vehicle Excise Duty (see opposite for details) and the DVLA new vehicle first registration fee of £55.00*.

* = Correct at time of going to press.

Please note: The on-the-road recommended retail price (RRP) does not include fuel supplied by the retailer, motor insurance or any other goods or services supplied by agreement between the retailer and the customer.

Price protection

Order a new Vauxhall for build in the current model year (as confirmed by your retailer) for delivery no more than three months in advance and the price you are quoted is the price you pay. This is irrespective of any subsequent price rises between placing your order and delivery of your new car, but you must take delivery as soon as the car is available. Vauxhall Motors is not liable for price adjustments caused by Government changes in the rate of VAT (currently 17.5%), Vehicle Excise Duty, DVLA new vehicle first registration fee or by any other applicable legislation or regulations.

Benefit in kind company car taxation**

The car benefit charge will be the car's list price (including VAT, options and accessories fitted, delivery to retailer and number plates, but excluding Vehicle Excise Duty and new vehicle first registration fee) multiplied by the percentage charge for the CO₂ emissions band in which the car falls (see table opposite). Multiply this figure by your personal income tax rate (20% for Basic Rate, 40% for Higher Rate for 2008-09 tax year) to calculate your annual benefit in kind tax liability.

Example:

Astra Life 1.6i 16v manual 5-door hatchback (CO ₂ emissions 155g/km)	
On-the-road RRP	£14260.00
Deduct: Vehicle Excise Duty	(£145.00)
New vehicle first registration fee	(£55.00)
Effective list price	£14060.00
Add: Optional two-coat metallic paint	£375.00
List price for tax purposes (P11D value)	£14435.00
Car benefit charge	
2008-09 tax year (19%)	£2742.00
Benefit in kind tax liability (2008-09 tax year)	
Basic Rate (20%) tax payer	£548.00
Higher Rate (40%) tax payer	£1096.00

** = Please note this Price Guide provides taxation information as a guide only. Vauxhall does not purport to provide taxation guidance. Drivers should always take professional advice on their own tax position.

CO ₂ emissions in grams per kilometre	Percentage of car's price to be taxed	
	Petrol 2008-09 tax year	Diesel 2008-09 tax year
up to 120	10	13
121-139	15	18
140-144	16	19
145-149	17	20
150-154	18	21
155-159	19	22
160-164	20	23
165-169	21	24
170-174	22	25
175-179	23	26
180-184	24	27
185-189	25	28
190-194	26	29
195-199	27	30
200-204	28	31
205-209	29	32
210-214	30	33
215-219	31	34
220-224	32	35
225-229	33	35
230-234	34	35
235-239	35	35
240 and above	35	35

To calculate your own personal liability a car tax calculator is available at www.vauxhall.co.uk/bik

Vauxhall Internet Price (VIP)

All Vauxhall cars have a special Vauxhall internet price (VIP) as well as the on-the-road recommended retail price (RRP). See www.vauxhall.co.uk for details. It is Vauxhall's understanding that company car taxation will continue to be based on the on-the-road recommended retail price (RRP).

Vehicle Excise Duty

The amount of Vehicle Excise Duty (road fund licence) payable on new cars varies depending on the level of carbon dioxide (CO₂) emissions produced by the vehicle. CO₂ emissions are measured in grammes (g) per kilometre (km) travelled and divided into seven charging bands shown in the table below.

Vehicle Excise Duty*

	CO ₂ emissions	Petrol/Diesel
Band A	up to 100g/km	£0.00
Band B	101-120g/km	£35.00
Band C	121-150g/km	£120.00
Band D	151-165g/km	£145.00
Band E	166-185g/km	£170.00
Band F	186-225g/km	£210.00
Band G	over 225g/km	£400.00

* = Correct at time of going to press.

Protecting the environment

Vauxhall has always been at the forefront of environmental issues and our products are increasingly winning green automotive awards.

However, our commitment to preserving the environment goes even further. We have reduced manufacturing emissions and our new vehicles use more recycled materials in their construction and more recyclable parts than ever before.

Looking further into the future we are working on cleaner, alternative power sources, including zero-emission fuel cell technology.

For more information

For information on Vauxhall's efforts to achieve an environmentally sustainable future, including information on Design for Recycling, take-back of End-of-Life Vehicles (ELVs), and the recycling of ELVs, see www.vauxhall.co.uk/recycling.

EcoFlex £1000 Scrap Allowance

Further proof of our long-term commitment to the environment comes in the form of our EcoFlex Scrap Allowance programme. Buy a selected low-emission Vauxhall model and we'll offer you £1000 (£500 on New Agila)[†] to take your old, higher emission car off the road.

Should you want a car that's not included in the EcoFlex Scrap Allowance programme, we can still help you dispose of your old car. Our partners Autogreen Ltd offer free and easily accessible, environmentally friendly, end-of-life vehicle disposal.

[†] = Applies to selected New Agila, Corsa, Meriva, Astra and Zafira models only. Please see your retailer for further details.

Vauxhall supporting



Smarter driving tips

- Drive at an appropriate speed: – Staying within the speed limit increases driver safety, reduces CO₂ emissions and saves fuel. At 70mph you could be using up to 9% more fuel than at 60mph and up to 15% more fuel than at 50mph
- Drive smoothly at all times: – Anticipate the ebb and flow of the traffic to avoid harsh acceleration and braking
- Reduce your revs: – Change gear earlier to help reduce fuel consumption – try 2500rpm with petrol engines and 2000rpm with diesel
- Idling is wasting fuel: – If you're likely to be at a standstill for more than three minutes, switch off the engine to save fuel
- Regularly check your tyre pressures: – Under inflated tyres increase CO₂ emissions whilst over inflated tyres can be unsafe. Always check your handbook for the correct tyre pressure. This will also help to increase the life of your tyres
- Remove unnecessary items from the car: – Extra weight increases the engine's workload, whilst roof racks and bike carriers increase wind resistance. All burn more fuel and increase CO₂ emissions



Customer information	2
New Agila	4
Tigra	6
Corsa	8
Meriva	12
Astra Sport Hatch	14
Astra hatchback	16
Astra estate	20
Astra TwinTop	22
Zafira	24
Vectra hatchback	28
Vectra estate	32
Vectra saloon	36
Antara	38
VXR	39
Fuel consumption figures	45
Vivaro Combi	48
Movano Combi	49
Options explained	50
Accessories	54
Customer care	58



5-door MPC

Model	Price (£)	VAT (£)	Total (£)	On-the-road RRP (£)	CO ₂ * (g/km)
New Agila Expression					
1.0i 12v ecoFLEX	6027.23	1054.77	7082.00	7795.00	120
New Agila Club					
1.0i 12v ecoFLEX	6997.45	1224.55	8222.00	8935.00	120
1.2i 16v	7265.53	1271.47	8537.00	9335.00	131
1.2i 16v auto	8116.60	1420.40	9537.00	10335.00	142
1.0i 12v ecoFLEX (a/c)	7422.98	1299.02	8722.00	9435.00	120
1.2i 16v (a/c)	7691.06	1345.94	9037.00	9835.00	131
1.2i 16v auto (a/c)	8542.13	1494.87	10037.00	10835.00	142
Diesel					
1.3CDTi 16v ecoFLEX	8699.57	1522.43	10222.00	10935.00	120
1.3CDTi 16v ecoFLEX (a/c)	9125.11	1596.89	10722.00	11435.00	120

Model	Price (£)	VAT (£)	Total (£)	On-the-road RRP (£)	CO ₂ * (g/km)
New Agila Design					
1.2i 16v (a/c)	7861.28	1375.72	9237.00	10035.00	131
1.2i 16v auto (a/c)	8712.34	1524.66	10237.00	11035.00	142
Diesel					
1.3CDTi 16v ecoFLEX (a/c)	9295.32	1626.68	10922.00	11635.00	120

Please note: On-the-road recommended retail prices (RRP) include number plates and delivery to retailer of £623.00 (inc. £92.79 VAT), 12 months' Vehicle Excise Duty (see page 2) and new vehicle first registration fee of £55.00. Excludes fuel and insurance.

* = CO₂ emission figures. Vehicle Excise Duty is based on CO₂ emissions (see page 2 for details).

For benefit in kind taxation charges see page 2.

a/c = Air conditioning.



See pages 54-57 for accessory and styling products



See page 45 for fuel data



See page 59 for MasterFit Service Plan details

Option availability

	Expression	Club	Design	Price (£) exc. VAT	Total (£) inc. VAT
Safety option					
Electronic Stability Programme (ESP)	<input type="radio"/>	<input type="radio"/>	<input type="radio"/>	361.70	425.00
Exterior option					
Two-coat metallic or pearlescent paint	<input type="radio"/>	<input type="radio"/>	<input type="radio"/>	319.15	375.00

○ = Optional at extra cost.

Accessory highlights

New Agila accessories

	Price (£) exc. VAT	Total (£) inc. VAT
Travel Pack • First aid kit • Warning triangle • Hi-visibility vest	21.28	25.00
Protection Pack • Velour mats (four) • Mudflaps (four) • Cargo liner	123.40	145.00

For further details of accessories and styling products see pages 54-57.

2-door coupé roadster



Model	Price (£)	VAT (£)	Total (£)	On-the-road RRP (£)	CO ₂ * (g/km)
Tigra Air					
1.4i 16v	11950.64	2091.36	14042.00	14840.00	146
1.4i 16v Easytronic	12529.36	2192.64	14722.00	15520.00	144
1.4i 16v (a/c)	12401.70	2170.30	14572.00	15370.00	146
1.4i 16v Easytronic (a/c)	12954.89	2267.11	15222.00	16020.00	144
Diesel					
1.3CDTi 16v	12835.74	2246.26	15082.00	15880.00	124
1.3CDTi 16v (a/c)	13261.28	2320.72	15582.00	16380.00	124
Tigra Sport Rouge					
1.4i 16v	12984.68	2272.32	15257.00	16055.00	146
1.8i 16v	13648.51	2388.49	16037.00	16885.00	179
1.4i 16v (a/c)	13410.21	2346.79	15757.00	16555.00	146
1.8i 16v (a/c)	14074.04	2462.96	16537.00	17385.00	179
Diesel					
1.3CDTi 16v	13869.79	2427.21	16297.00	17095.00	124
1.3CDTi 16v (a/c)	14295.32	2501.68	16797.00	17595.00	124

Model	Price (£)	VAT (£)	Total (£)	On-the-road RRP (£)	CO ₂ * (g/km)
Tigra Exclusiv					
1.4i 16v (a/c)	12997.45	2274.55	15272.00	16070.00	146
1.4i 16v Easytronic (a/c)	13550.64	2371.36	15922.00	16720.00	144
1.8i 16v (a/c)	13661.28	2390.72	16052.00	16900.00	179

Please note: On-the-road recommended retail prices (RRP) include number plates and delivery to retailer of £623.00 (inc. £92.79 VAT), 12 months' Vehicle Excise Duty (see page 2) and new vehicle first registration fee of £55.00. Excludes fuel and insurance.

* = CO₂ emission figures. Vehicle Excise Duty is based on CO₂ emissions (see page 2 for details). For benefit in kind taxation charges see page 2.

a/c = Air conditioning.



See pages 54-57 for accessory and styling products



See page 45 for fuel data



See page 59 for MasterFit Service Plan details

Accessory highlights

Tigra accessories

	Price (£) exc. VAT	Total (£) inc. VAT
Travel Pack		
• First aid kit • Warning triangle • Hi-visibility vest	21.28	25.00
Protection Pack		
• Velour mats • Windbreak	169.36	199.00

For further details of accessories and styling products see pages 54-57.

Option availability

	Air	Sport Rouge	Exclusiv	Price (£) exc. VAT	Total (£) inc. VAT
Option packs					
VXR Styling Pack One • Body-colour front lower spoiler/rear lower skirt/boot lip spoiler and side sills	○	○	○	680.85	800.00
Leather Pack • Leather seat facings • Electrically heated sports seats	○	○	●	595.74	700.00
Travel Pack • Windbreak • Retaining net for storage area behind seats	○	●	●	127.66	150.00
Plus Pack ¹ • Cruise control • Driver information centre including trip computer	○	○	○	255.32	300.00
Safety options					
Electronic Stability Programme (ESP) ⓘ see page 53	○	○	○	361.70	425.00
Automatic seat occupancy detection for passenger's airbags	○	○	○	106.38	125.00
Exterior options					
17-inch five-spoke alloy wheels with 205/45 R 17 tyres ²	○	○	● ³	297.87	350.00
Rear parking distance sensor ⓘ see page 51	○	○	○	297.87	350.00
Targa roof bar in body colour	●	○	○ ⁴	85.11	100.00
Two-coat metallic or pearlescent paint	○	○	○	319.15	375.00
Audio and communication options					
CD 30 MP3 • CD player with MP3 format • Stereo radio • Auxiliary-in socket ⓘ see page 51	○	●	●	63.83	75.00
CD 70 • Satellite navigation system • CD player with MP3 format • Stereo radio • Auxiliary-in socket • Graphic display ⓘ see page 50	○	○	○	829.79	975.00

○ = Optional at extra cost. ● = Standard equipment.

¹ = Not available on 1.3CDTi 16v models. ² = The steel spare wheel is replaced by an emergency tyre inflation kit to effect a temporary 'get you home' repair. ³ = Exclusiv models feature 17-inch five-spoke alloy wheels with anthracite inner.

⁴ = Standard on models with optional Star Silver two-coat metallic paint.

3-door hatchback



Model	Price (£)	VAT (£)	Total (£)	On-the-road RRP (£)	CO ₂ * (g/km)
Corsa Expression					
1.0i 12v	6125.11	1071.89	7197.00	7995.00	134
Corsa Life					
1.0i 12v	7125.11	1246.89	8372.00	9170.00	134
1.2i 16v	7465.53	1306.47	8772.00	9570.00	139
1.2i 16v Easytronic	7891.06	1380.94	9272.00	10070.00	137
1.0i 12v (a/c)	7550.64	1321.36	8872.00	9670.00	134
1.2i 16v (a/c)	7891.06	1380.94	9272.00	10070.00	139
1.2i 16v Easytronic (a/c)	8316.60	1455.40	9772.00	10570.00	137
Diesel					
1.3CDTi 16v (75PS) ecoFLEX	8308.09	1453.91	9762.00	10475.00	119
1.3CDTi 16v (75PS) ecoFLEX (a/c)	8733.62	1528.38	10262.00	10975.00	119
Corsa Active (Special Edition model)					
1.0i 12v (a/c)	7733.62	1353.38	9087.00	9885.00	134
1.2i 16v (a/c)	8074.04	1412.96	9487.00	10285.00	139
1.2i 16v Easytronic (a/c)	8499.57	1487.43	9987.00	10785.00	137
Diesel					
1.3CDTi 16v (75PS) ecoFLEX (a/c)	8916.60	1560.40	10477.00	11190.00	119
Corsa Active Plus (Special Edition model)					
1.0i 12v (a/c)	8159.15	1427.85	9587.00	10385.00	134
1.2i 16v (a/c)	8499.57	1487.43	9987.00	10785.00	139
1.2i 16v Easytronic (a/c)	8925.11	1561.89	10487.00	11285.00	137
Diesel					
1.3CDTi 16v (75PS) ecoFLEX (a/c)	9342.13	1634.87	10977.00	11690.00	119
Corsa Club					
1.2i 16v	7895.32	1381.68	9277.00	10075.00	139
1.2i 16v Easytronic	8320.85	1456.15	9777.00	10575.00	137
1.4i 16v	8320.85	1456.15	9777.00	10575.00	146
1.4i 16v auto	9150.64	1601.36	10752.00	11575.00	154
1.2i 16v (a/c)	8320.85	1456.15	9777.00	10575.00	139
1.2i 16v Easytronic (a/c)	8746.38	1530.62	10277.00	11075.00	137
1.4i 16v (a/c)	8746.38	1530.62	10277.00	11075.00	146
1.4i 16v auto (a/c)	9576.17	1675.83	11252.00	12075.00	154
Diesel					
1.3CDTi 16v (75PS) ecoFLEX	8737.87	1529.13	10267.00	10980.00	119
1.3CDTi 16v (75PS) ecoFLEX (a/c)	9163.40	1603.60	10767.00	11480.00	119

Model	Price (£)	VAT (£)	Total (£)	On-the-road RRP (£)	CO ₂ * (g/km)
Corsa Design					
1.2i 16v (a/c)	9252.77	1619.23	10872.00	11670.00	139
1.4i 16v (a/c)	9678.30	1693.70	11372.00	12170.00	146
1.4i 16v auto (a/c)	10508.09	1838.91	12347.00	13170.00	154
Diesel					
1.3CDTi 16v (75PS) ecoFLEX (a/c)	10095.32	1766.68	11862.00	12575.00	119
1.3CDTi 16v (90PS) (a/c)	10350.64	1811.36	12162.00	12960.00	127
1.7CDTi 16v (a/c)	11244.26	1967.74	13212.00	14010.00	130
Corsa Design inTouch**					
1.2i 16v (a/c)	10201.70	1785.30	11987.00	12785.00	139
Corsa SXi					
1.2i 16v	8644.26	1512.74	10157.00	10955.00	146
1.4i 16v	9069.79	1587.21	10657.00	11455.00	146
1.4i 16v auto	9899.57	1732.43	11632.00	12455.00	154
1.2i 16v (a/c)	9069.79	1587.21	10657.00	11455.00	146
1.4i 16v (a/c)	9495.32	1661.68	11157.00	11955.00	146
1.4i 16v auto (a/c)	10325.11	1806.89	12132.00	12955.00	154
Diesel					
1.3CDTi 16v (75PS) ecoFLEX	9486.81	1660.19	11147.00	11860.00	119
1.3CDTi 16v (90PS)	9742.13	1704.87	11447.00	12245.00	127
1.3CDTi 16v (75PS) ecoFLEX (a/c)	9912.34	1734.66	11647.00	12360.00	119
1.3CDTi 16v (90PS) (a/c)	10167.66	1779.34	11947.00	12745.00	127
Corsa SXi inTouch**					
1.2i 16v (a/c)	9699.57	1697.43	11397.00	12195.00	146
Corsa SRI					
1.6i 16v Turbo (150PS)	11431.49	2000.51	13432.00	14320.00	189
1.6i 16v Turbo (150PS) (a/c)	11857.02	2074.98	13932.00	14820.00	189
Diesel					
1.7CDTi 16v (a/c)	12452.77	2179.23	14632.00	15430.00	130

Please note: On-the-road recommended retail prices (RRP) include number plates and delivery to retailer of £623.00 (inc. £92.79 VAT), 12 months' Vehicle Excise Duty (see page 2) and new vehicle first registration fee of £55.00. Excludes fuel and insurance.

* = CO₂ emission figures. Vehicle Excise Duty is based on CO₂ emissions (see page 2 for details). For benefit in kind taxation charges see page 2.

** = inTouch model features Pioneer AVIC-F900BT European DVD navigation unit. Two-coat metallic/pearlescent paint is the only option available on SXi inTouch, standard on Design inTouch. Please refer to the Corsa inTouch brochure for further details.
a/c = Air conditioning.



See page 39 for VXR model



See pages 54-57 for accessory and styling products



See page 45 for fuel data

Option availability

	Expression	Life	Active	Active Plus	Club	Design	SXi	SRI	Price (£) exc. VAT	Total (£) inc. VAT
Option packs										
VXR Styling Pack One ¹ • Body-colour front lower spoiler/side sills/rear lower skirt/rear roof spoiler							○ ²	●	680.85	800.00
Sight and Light Pack • Rain-sensitive windscreen wipers • Electro-chromatic anti-dazzle rear-view mirror • Automatic lighting control						●	○	○	170.21	200.00
Protection Pack • Front seat side-impact airbags • Full-size curtain airbags • Pyrotechnic front lap belt pretensioner system	○	○	○	○	●	●	●	●	340.43	400.00
Winter Pack • Electrically heated front seats • Electrically heated leather-covered steering wheel					○	○	○ ³	○ ³	170.21	200.00
Plus Pack • Driver's seat height adjuster • Steering column adjustable for reach and rake		○			●	●	●	●	85.11	100.00
Plus Pack • 15-inch alloy wheels (steel spare) • Front fog lights • Cruise control • Multi-function trip computer					○				382.98	450.00
Plus Pack • Electronic Climate Control (ECC) incorporating air conditioning ⓘ see page 52 • Cruise control • Multi-function trip computer • Graphic information display						○	○ ⁴	○ ⁴	382.98	450.00
Safety options										
Electronic Stability Programme-plus (ESP-plus) with traction control ⓘ see page 53	○	○	○	○	○	○	○	●	361.70	425.00
ISOFIX child seat restraint system for front passenger's seat (does not include child seat)		○	○	○	○	○	○	○	85.11	100.00
Exterior and convenience options										
17-inch alloy wheels with 215/45 R 17 ultra-low profile tyres						○ ⁵	○ ⁵	●	255.32	300.00
Adaptive Forward Lighting (AFL) – halogen ⓘ see page 52						○	○	○	212.77	250.00
Electrically operated sliding glass sunroof with interior blind ⁶				●	○	○	○	○	468.09	550.00
Flex-Fix® integrated carrier system (includes two-bicycle carrier attachment) ⁷					○	○	○		319.15	375.00
Rear parking distance sensors ⁸ ⓘ see page 51					○	○	○	○	212.77	250.00
Two-coat metallic or pearlescent paint		○	○	○	○	○ ⁹	○	○	319.15	375.00
Audio and communication options										
CD 60 • Satellite navigation system • CD player with MP3 format • Stereo radio • Auxiliary-in socket • Graphic display					○	○	○	○	829.79	975.00
Mobile phone system with Bluetooth® (does not include phone or cradle) and graphic display – see page 57 for details of mobile phone compatibility ⓘ see page 50					○	○	○	○	255.32	300.00

○ = Optional at extra cost. ● = Standard equipment.

¹ = Not available in conjunction with Flex-Fix® integrated carrier system. The spare wheel is replaced by an emergency tyre inflation kit. ² = Not available on 1.3CDTi 16v (75PS) models. ³ = Deletes sports steering wheel. ⁴ = Only available on models fitted with air conditioning. ⁵ = Not available on 1.3CDTi 16v (75PS) models. Includes sports suspension with lower ride height and progressive-rate variable ratio power-assisted steering. ⁶ = Also includes front passenger's seat height adjuster. Deletes front passenger's underseat storage tray. Roof panel is coloured black. ⁷ = Not available in conjunction with VXR Styling Pack One or rear parking distance sensors. The spare wheel is replaced by an emergency tyre inflation kit.

⁸ = Not available in conjunction with Flex-Fix® integrated carrier system. ⁹ = Standard on Design inTouch model only.

Accessory highlights

	Price (£) exc. VAT	Total (£) inc. VAT
Corsa accessories		
Travel Pack		
• First aid kit • Warning triangle • Hi-visibility vest	21.28	25.00
Protection Pack		
• Velour mats (four) • Mudflaps (four) • Cargo liner	135.32	159.00

For further details of accessories and styling products see pages 54-57.

5-door hatchback



Model	Price (£)	VAT (£)	Total (£)	On-the-road RRP (£)	CO ₂ * (g/km)
Corsa Life					
1.0i 12v	7742.13	1354.87	9097.00	9895.00	134
1.2i 16v	8082.55	1414.45	9497.00	10295.00	139
1.2i 16v Easytronic	8508.09	1488.91	9997.00	10795.00	137
1.0i 12v (a/c)	8167.66	1429.34	9597.00	10395.00	134
1.2i 16v (a/c)	8508.09	1488.91	9997.00	10795.00	139
1.2i 16v Easytronic (a/c)	8933.62	1563.38	10497.00	11295.00	137
Diesel					
1.3CDTi 16v (75PS) ecoFLEX	8925.11	1561.89	10487.00	11200.00	119
1.3CDTi 16v (75PS) ecoFLEX (a/c)	9350.64	1636.36	10987.00	11700.00	119
Corsa Active (Special Edition model)					
1.0i 12v (a/c)	8350.64	1461.36	9812.00	10610.00	134
1.2i 16v (a/c)	8691.06	1520.94	10212.00	11010.00	139
1.2i 16v Easytronic (a/c)	9116.60	1595.40	10712.00	11510.00	137
Diesel					
1.3CDTi 16v (75PS) ecoFLEX (a/c)	9533.62	1668.38	11202.00	11915.00	119
Corsa Active Plus (Special Edition model)					
1.0i 12v (a/c)	8776.17	1535.83	10312.00	11110.00	134
1.2i 16v (a/c)	9116.60	1595.40	10712.00	11510.00	139
1.2i 16v Easytronic (a/c)	9542.13	1669.87	11212.00	12010.00	137
Diesel					
1.3CDTi 16v (75PS) ecoFLEX (a/c)	9959.15	1742.85	11702.00	12415.00	119
Corsa Club					
1.2i 16v	8512.34	1489.66	10002.00	10800.00	139
1.2i 16v Easytronic	8937.87	1564.13	10502.00	11300.00	137
1.4i 16v	8937.87	1564.13	10502.00	11300.00	146
1.4i 16v auto	9767.66	1709.34	11477.00	12300.00	158
1.2i 16v (a/c)	8937.87	1564.13	10502.00	11300.00	139
1.2i 16v Easytronic (a/c)	9363.40	1638.60	11002.00	11800.00	137
1.4i 16v (a/c)	9363.40	1638.60	11002.00	11800.00	146
1.4i 16v auto (a/c)	10193.19	1783.81	11977.00	12800.00	158
Diesel					
1.3CDTi 16v (75PS) ecoFLEX	9354.89	1637.11	10992.00	11705.00	119
1.3CDTi 16v (75PS) ecoFLEX (a/c)	9780.43	1711.57	11492.00	12205.00	119

Model	Price (£)	VAT (£)	Total (£)	On-the-road RRP (£)	CO ₂ * (g/km)
Corsa Design					
1.2i 16v (a/c)	9869.79	1727.21	11597.00	12395.00	139
1.4i 16v (a/c)	10295.32	1801.68	12097.00	12895.00	146
1.4i 16v auto (a/c)	11125.11	1946.89	13072.00	13895.00	158
Diesel					
1.3CDTi 16v (75PS) ecoFLEX (a/c)	10712.34	1874.66	12587.00	13300.00	119
1.3CDTi 16v (90PS) (a/c)	10967.66	1919.34	12887.00	13685.00	127
1.7CDTi 16v (a/c)	11861.28	2075.72	13937.00	14735.00	132
Corsa SXi					
1.2i 16v	9261.28	1620.72	10882.00	11680.00	146
1.4i 16v	9686.81	1695.19	11382.00	12180.00	146
1.4i 16v auto	10516.60	1840.40	12357.00	13180.00	158
1.2i 16v (a/c)	9686.81	1695.19	11382.00	12180.00	146
1.4i 16v (a/c)	10112.34	1769.66	11882.00	12680.00	146
1.4i 16v auto (a/c)	10942.13	1914.87	12857.00	13680.00	158
Diesel					
1.3CDTi 16v (75PS) ecoFLEX	10103.83	1768.17	11872.00	12585.00	119
1.3CDTi 16v (90PS)	10359.15	1812.85	12172.00	12970.00	127
1.3CDTi 16v (75PS) ecoFLEX (a/c)	10529.36	1842.64	12372.00	13085.00	119
1.3CDTi 16v (90PS) (a/c)	10784.68	1887.32	12672.00	13470.00	127
Corsa SXi inTouch**					
1.2i 16v (a/c)	10316.60	1805.40	12122.00	12920.00	146
Corsa SRi					
1.6i 16v Turbo (150PS)	12048.51	2108.49	14157.00	15045.00	189
1.6i 16v Turbo (150PS) (a/c)	12474.04	2182.96	14657.00	15545.00	189
Diesel					
1.7CDTi 16v (a/c)	13069.79	2287.21	15357.00	16155.00	132

Please note: On-the-road recommended retail prices (RRP) include number plates and delivery to retailer of £623.00 (inc. £92.79 VAT), 12 months' Vehicle Excise Duty (see page 2) and new vehicle first registration fee of £55.00. Excludes fuel and insurance.

* = CO₂ emission figures. Vehicle Excise Duty is based on CO₂ emissions (see page 2 for details). For benefit in kind taxation charges see page 2.

** = inTouch model features Pioneer AVIC-F900BT European DVD navigation unit. Two-coat metallic/pearlescent paint is the only option available. Please refer to the Corsa inTouch brochure for further details.

a/c = Air conditioning.



See pages 54-57 for accessory and styling products



See page 45 for fuel data



See page 59 for MasterFit Service Plan details

Option availability

	Life	Active	Active Plus	Club	Design	SXi	SRI	Price (£) exc. VAT	Total (£) inc. VAT
Option packs									
VXR Styling Pack One ¹ • Body-colour front lower spoiler/side sills/rear lower skirt/rear roof spoiler						○ ²	●	680.85	800.00
Sight and Light Pack • Rain-sensitive windscreen wipers • Electro-chromatic anti-dazzle rear-view mirror • Automatic lighting control					●	○	○	170.21	200.00
Protection Pack • Front seat side-impact airbags • Full-size curtain airbags • Pyrotechnic front lap belt pretensioner system	○	○	○	●	●	●	●	340.43	400.00
Winter Pack • Electrically heated front seats • Electrically heated leather-covered steering wheel				○	○	○ ³	○ ³	170.21	200.00
Plus Pack • Driver's seat height adjuster • Steering column adjustable for reach and rake	○			●	●	●	●	85.11	100.00
Plus Pack • 15-inch alloy wheels (steel spare) • Front fog lights • Cruise control • Multi-function trip computer				○				382.98	450.00
Plus Pack • Electronic Climate Control (ECC) incorporating air conditioning ⓘ see page 52 • Cruise control • Multi-function trip computer • Graphic information display					○	○ ⁴	○ ⁴	382.98	450.00
Safety options									
Electronic Stability Programme-plus (ESP-plus) with traction control	○	○	○	○	○	○	●	361.70	425.00
ISOFIX child seat restraint system for front passenger's seat (does not include child seat)	○	○	○	○	○	○	○	85.11	100.00
Exterior and convenience options									
17-inch alloy wheels with 215/45 R 17 ultra-low profile tyres					○ ⁵	○ ⁵	●	255.32	300.00
Adaptive Forward Lighting (AFL) – halogen ⓘ see page 52					○	○	○	212.77	250.00
Electrically operated sliding glass sunroof with interior blind ⁶			●	○	○	○	○	468.09	550.00
Flex-Fix® integrated carrier system (includes two-bicycle carrier attachment) ⁷				○	○	○		319.15	375.00
Rear parking distance sensors ⁸ ⓘ see page 51				○	○	○	○	212.77	250.00
Two-coat metallic or pearlescent paint	○	○	○	○	○	○	○	319.15	375.00
Audio and communication options									
CD 60 • Satellite navigation system • CD player with MP3 format • Stereo radio • Auxiliary-in socket • Graphic display				○	○	○	○	829.79	975.00
Mobile phone system with Bluetooth® (does not include phone or cradle) and graphic display – see page 57 for details of mobile phone compatibility ⓘ see page 50				○	○	○	○	255.32	300.00

○ = Optional at extra cost. ● = Standard equipment.

¹ = Not available in conjunction with Flex-Fix® integrated carrier system. The spare wheel is replaced by an emergency tyre inflation kit. ² = Not available on 1.3CDTi 16v (75PS) models. ³ = Deletes sports steering wheel. ⁴ = Only available on models fitted with air conditioning. ⁵ = Not available on 1.3CDTi 16v (75PS) models. Includes sports suspension with lower ride height and progressive-rate variable ratio power-assisted steering. ⁶ = Also includes front passenger's seat height adjuster. Deletes front passenger's underseat storage tray. Roof panel is coloured black. ⁷ = Not available in conjunction with VXR Styling Pack One or rear parking distance sensors. The spare wheel is replaced by an emergency tyre inflation kit. ⁸ = Not available in conjunction with Flex-Fix® integrated carrier system.

Accessory highlights

Corsa accessories

	Price (£) exc. VAT	Total (£) inc. VAT
Travel Pack • First aid kit • Warning triangle • Hi-visibility vest	21.28	25.00
Protection Pack • Velour mats (four) • Mudflaps (four) • Cargo liner	135.32	159.00

For further details of accessories and styling products see pages 54-57.

5-door MPV

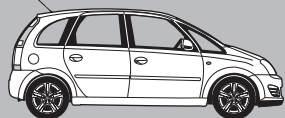

Model	Price (£)	VAT (£)	Total (£)	On-the-road RRP (£)	CO ₂ * (g/km)
Meriva Expression					
1.4i 16v	8678.30	1518.70	10197.00	10995.00	148
<i>Diesel</i>					
1.3CDTi 16v	9342.13	1634.87	10977.00	11775.00	135
Meriva Life					
1.4i 16v	9780.43	1711.57	11492.00	12290.00	148
1.6i 16v	10354.89	1812.11	12167.00	12990.00	159
1.6i 16v Easytronic	10780.43	1886.57	12667.00	13490.00	159
1.4i 16v (a/c)	10205.96	1786.04	11992.00	12790.00	148
1.6i 16v (a/c)	10780.43	1886.57	12667.00	13490.00	159
1.6i 16v Easytronic (a/c)	11205.96	1961.04	13167.00	13990.00	159
<i>Diesel</i>					
1.3CDTi 16v	10874.04	1902.96	12777.00	13575.00	135
1.3CDTi 16v (a/c)	11299.57	1977.43	13277.00	14075.00	135
1.7CDTi 16v (a/c)	11937.87	2089.13	14027.00	14825.00	139
Meriva Breeze (Special Edition model)					
1.4i 16v (a/c)	10665.53	1866.47	12532.00	13330.00	148
1.6i 16v (a/c)	11240.00	1967.00	13207.00	14030.00	159
1.6i 16v Easytronic (a/c)	11665.53	2041.47	13707.00	14530.00	159
<i>Diesel</i>					
1.3CDTi 16v (a/c)	11759.15	2057.85	13817.00	14615.00	135
Meriva Breeze Plus (Special Edition model)					
1.4i 16v (a/c)	11048.51	1933.49	12982.00	13780.00	148
1.6i 16v (a/c)	11622.98	2034.02	13657.00	14480.00	159
1.6i 16v Easytronic (a/c)	12048.51	2108.49	14157.00	14980.00	159
<i>Diesel</i>					
1.3CDTi 16v (a/c)	12142.13	2124.87	14267.00	15065.00	135
Meriva Club					
1.4i 16v (a/c)	11269.79	1972.21	13242.00	14040.00	148
1.6i 16v (a/c)	11844.26	2072.74	13917.00	14740.00	159
1.6i 16v Easytronic (a/c)	12269.79	2147.21	14417.00	15240.00	159
1.8i 16v (a/c)	12440.00	2177.00	14617.00	15465.00	174
1.8i 16v Easytronic (a/c)	12865.53	2251.47	15117.00	15965.00	174
<i>Diesel</i>					
1.3CDTi 16v (a/c)	12363.40	2163.60	14527.00	15325.00	135
1.7CDTi 16v (a/c)	13001.70	2275.30	15277.00	16075.00	139

Model	Price (£)	VAT (£)	Total (£)	On-the-road RRP (£)	CO ₂ * (g/km)
Meriva Design					
1.4i 16v (a/c)	11482.55	2009.45	13492.00	14290.00	148
1.6i 16v (a/c)	12057.02	2109.98	14167.00	14990.00	159
1.6i 16v Easytronic (a/c)	12482.55	2184.45	14667.00	15490.00	159
1.8i 16v (a/c)	12652.77	2214.23	14867.00	15715.00	174
1.8i 16v Easytronic (a/c)	13078.30	2288.70	15367.00	16215.00	174
<i>Diesel</i>					
1.7CDTi 16v (a/c)	13214.47	2312.53	15527.00	16325.00	139
Meriva Design with Exterior Pack**					
1.4i 16v (a/c)	12120.85	2121.15	14242.00	15040.00	148
1.6i 16v (a/c)	12695.32	2221.68	14917.00	15740.00	159
1.6i 16v Easytronic (a/c)	13120.85	2296.15	15417.00	16240.00	159
1.8i 16v (a/c)	13291.06	2325.94	15617.00	16465.00	174
1.8i 16v Easytronic (a/c)	13716.60	2400.40	16117.00	16965.00	174
<i>Diesel</i>					
1.7CDTi 16v (a/c)	13852.77	2424.23	16277.00	17075.00	139

Please note: On-the-road recommended retail prices (RRP) include number plates and delivery to retailer of £623.00 (inc. £92.79 VAT), 12 months' Vehicle Excise Duty (see page 2) and new vehicle first registration fee of £55.00. Excludes fuel and insurance.

* = CO₂ emission figures. Vehicle Excise Duty is based on CO₂ emissions (see page 2 for details).

For benefit in kind taxation charges see page 2.

** = Exterior Pack comprises 17-inch five-spoke alloy wheels and VXR Styling Pack One (see page 13 for details).

a/c = Air conditioning.



See page 40
for VXR model



See page 45
for fuel data



See page 59
for MasterFit
Service Plan
details

Accessory highlights

Meriva accessories

Travel Pack

• First aid kit • Warning triangle • Hi-visibility vest

21.28

25.00

Protection Pack

• Velour mats (four) • Mudflaps (four) • Cargo liner

135.32

159.00

For further details of accessories and styling products see pages 54-57.

Option availability

	Expression	Life	Breeze	Breeze Plus	Club	Design	Price (£) exc. VAT	Total (£) inc. VAT
Option packs								
VXR Styling Pack One • Body-colour front lower spoiler/side sills/rear lower skirt/rear roof spoiler					○	○ ¹	680.85	800.00
Protection Pack ² • Electronic Stability Programme (ESP) i see page 53 • Electronic traction control with two-way intervention • Front seat side-impact airbags • Full-size curtain airbags • Active-safety front seat head restraints • Automatic front seat occupancy detection • ISOFIX child seat restraint system for front passenger's seat (does not include child seat)	○	○	○	○	○	○ ³	510.64	600.00
Plus Pack • 15-inch Structure wheels • Front fog lights • Leather-covered steering wheel • Dark-tinted Solar Protect® glass (excludes windscreen and front door windows) • Cruise control • Tiltable steering column					○		425.53	500.00
Plus Pack • Electronic Climate Control (ECC) i see page 52 • Solar Reflect® windscreen • Electro-chromatic anti-dazzle rear-view mirror • Indirect night lighting						○	340.43	400.00
Interior option								
Tiltable steering column		○	●	●	○	●	80.85	95.00
Exterior and convenience options								
16-inch alloy wheels (emergency tyre inflation kit) with locking bolts and 205/50 R 16 ultra-low profile tyres						○	212.77	250.00
15-inch steel spare wheel/tyre (in lieu of emergency tyre inflation kit)	○	○	○	○	○	○ ⁴	85.11	100.00
Adaptive Forward Lighting (AFL) – halogen i see page 52			○	○	○	○	212.77	250.00
Electrically operated slide/tilt glass front sunroof and tiltable glass rear sunroof			○	○		●	510.64	600.00
Two-coat metallic or pearlescent paint		○	○	○	○	○	319.15	375.00
Audio and communication options								
CD 30 MP3 • CD player with MP3 format • Stereo radio • Auxiliary-in socket i see page 51		○	○	○	○	● ⁵	63.83	75.00
CDC 40 • Integral six-disc CD autochanger with MP3 format • Stereo radio • Graphic display			○	○	○	○	382.98	450.00
CD 70 • Satellite navigation system • CD player with MP3 format • Stereo radio • Auxiliary-in socket • Graphic display i see page 50			○	○	○	○	829.79	975.00
Rear seat Twin Audio® system with single headset i see page 50			○ ⁶	○ ⁶	○ ⁶	●	85.11	100.00
Mobile phone system with Bluetooth® (does not include phone or cradle) and graphic display ⁷ – see page 57 for details of mobile phone compatibility i see page 50			○	○	○		255.32	300.00

○ = Optional at extra cost. ● = Standard equipment.

¹ = Standard on Design with Exterior Pack models. ² = For details on the correct fitment of child seats when the vehicle is fitted with a front passenger's airbag or side-impact airbags please consult your Vauxhall retailer. ³ = Deletes driver's sunglasses holder. ⁴ = Not available on Design with Exterior Pack models, or in conjunction with VXR Styling Pack One. ⁵ = Does not include auxiliary-in socket. ⁶ = Only available in conjunction with optional audio units. Deletes auxiliary-in socket from CD 30 MP3. Not available in conjunction with mobile phone system with Bluetooth®. ⁷ = Not available in conjunction with rear seat Twin Audio®.



Sport Hatch

Model	Price (£)	VAT (£)	Total (£)	On-the-road RRP (£)	CO ₂ * (g/km)
Astra Breeze (Special Edition model)					
1.4i 16v	11831.49	2070.51	13902.00	14700.00	146
1.6i 16v VVT	12363.40	2163.60	14527.00	15350.00	155
1.8i 16v VVT auto	13742.13	2404.87	16147.00	16995.00	184
<i>Diesel</i>					
1.7CDTi 16v (100PS)	13478.30	2358.70	15837.00	16635.00	135
Astra Breeze Plus (Special Edition model)					
1.4i 16v	12214.47	2137.53	14352.00	15150.00	146
1.6i 16v VVT	12746.38	2230.62	14977.00	15800.00	155
1.8i 16v VVT auto	14125.11	2471.89	16597.00	17445.00	184
<i>Diesel</i>					
1.7CDTi 16v (100PS)	13861.28	2425.72	16287.00	17085.00	135
Astra Design					
1.6i 16v VVT	13057.02	2284.98	15342.00	16165.00	155
1.6i 16v VVT Easytronic	13482.55	2359.45	15842.00	16665.00	151
1.8i 16v VVT	13503.83	2363.17	15867.00	16715.00	169
1.8i 16v VVT auto	14440.00	2527.00	16967.00	17815.00	184
1.6i 16v Turbo	15444.26	2702.74	18147.00	18995.00	185
<i>Diesel</i>					
1.7CDTi 16v (100PS)	14171.91	2480.09	16652.00	17450.00	135
1.7CDTi 16v (110PS) ecoFLEX	14495.32	2536.68	17032.00	17745.00	119
1.9CDTi (120PS)	14899.57	2607.43	17507.00	18305.00	149
1.9CDTi (120PS) auto	16014.47	2802.53	18817.00	19705.00	186
1.9CDTi 16v (150PS)	15622.98	2734.02	18357.00	19155.00	149

Please note: On-the-road recommended retail prices (RRP) include number plates and delivery to retailer of £623.00 (inc. £92.79 VAT), 12 months' Vehicle Excise Duty (see page 2) and new vehicle first registration fee of £55.00. Excludes fuel and insurance.

* = CO₂ emission figures. Vehicle Excise Duty is based on CO₂ emissions (see page 2 for details). For benefit in kind taxation charges see page 2.

** = Exterior Pack comprises 18-inch five-spoke alloy wheels and VXR Styling Pack One (see page 15 for details).

Model	Price (£)	VAT (£)	Total (£)	On-the-road RRP (£)	CO ₂ * (g/km)
Astra SXi					
1.4i 16v	12222.98	2139.02	14362.00	15160.00	146
1.6i 16v VVT	12754.89	2232.11	14987.00	15810.00	155
1.6i 16v VVT Easytronic	13180.43	2306.57	15487.00	16310.00	151
<i>Diesel</i>					
1.7CDTi 16v (100PS)	13869.79	2427.21	16297.00	17095.00	135
1.7CDTi 16v (110PS) ecoFLEX	14193.19	2483.81	16677.00	17390.00	119
1.9CDTi (120PS)	13993.19	2448.81	16442.00	17240.00	149
Astra SRI					
1.8i 16v VVT	13784.68	2412.32	16197.00	17045.00	172
1.8i 16v VVT auto	14686.81	2570.19	17257.00	18145.00	186
1.6i 16v Turbo	15188.94	2658.06	17847.00	18695.00	185
<i>Diesel</i>					
1.7CDTi 16v (100PS)	14465.53	2531.47	16997.00	17795.00	138
1.9CDTi (120PS)	14937.87	2614.13	17552.00	18350.00	149
1.9CDTi (120PS) auto	16052.77	2809.23	18862.00	19750.00	186
1.9CDTi 16v (150PS)	15363.40	2688.60	18052.00	18850.00	149
Astra SRI with Exterior Pack**					
1.8i 16v VVT	14550.64	2546.36	17097.00	17945.00	172
1.8i 16v VVT auto	15452.77	2704.23	18157.00	19045.00	186
1.6i 16v Turbo	15954.89	2792.11	18747.00	19595.00	185
<i>Diesel</i>					
1.7CDTi 16v (100PS)	15231.49	2665.51	17897.00	18695.00	138
1.9CDTi (120PS)	15703.83	2748.17	18452.00	19250.00	149
1.9CDTi (120PS) auto	16818.72	2943.28	19762.00	20650.00	186
1.9CDTi 16v (150PS)	16129.36	2822.64	18952.00	19750.00	149

Accessory highlights

Astra Sport Hatch accessories

	Price (£) exc. VAT	Total (£) inc. VAT
Travel Pack		
• First aid kit • Warning triangle • Hi-visibility vest	21.28	25.00
Protection Pack		
• Velour mats (four) • Mudflaps (four) • Cargo liner	135.32	159.00

For further details of accessories and styling products see pages 54-57.



See page 41 for VXR model



See page 45 for fuel data



See page 59 for MasterFit Service Plan details

Option availability

	Breeze	Breeze Plus	Design	SXi	SRi	Price (£) exc. VAT	Total (£) inc. VAT
Option packs							
Sight and Light Pack¹ • Rain-sensitive windscreen wipers • Electro-chromatic anti-dazzle rear-view mirror • Automatic lighting control			●	○	○	170.21	200.00
Leather Pack • Leather seat facings • Electrically heated sports front seats with tilt and lumbar adjustment • Indirect door night lighting • Centre rear seat head restraint • Front passenger's seat height adjuster				○	○	851.06	1000.00
Sports Pack • 17-inch 10-spoke alloy wheels with 225/45 R 17 tyres • Uprated sports steering • Electronic Stability Programme-plus (ESP-plus) i see page 53 • Sport switch					○ ²	553.19	650.00
Premium Pack • 18-inch five-spoke alloy wheels with 225/40 R 18 ultra-low profile tyres • Leather seat facings in Saddle Brown • Electrically heated sports front seats • Zebrano-effect inserts on facia and doors					○ ³	1021.28	1200.00
VXR Styling Pack One • Body-colour front lower spoiler/rear lower skirt/rear roof spoiler (standard on SRi models) and side sills • Aerial adaptor				○ ⁴	● ⁵	680.85	800.00
Seat Comfort Pack One • Driver's seat with tilt and lumbar adjustment	○	○	●	○	○	127.66	150.00
Seat Comfort Pack Two • Front passenger's seat with height, tilt and lumbar adjustment	○ ⁶	○ ⁶	○	○ ⁶	○ ⁶	85.11	100.00
Safety and security options							
Electronic Stability Programme-plus (ESP-plus) i see page 53	○	○	○ ⁷	○	●	361.70	425.00
Keyless entry and start i see page 51	○	○	○	○	○	255.32	300.00
Remote control ultrasonic security alarm ⁸	○	○	○	○	●	191.49	225.00
Interior options							
Electronic Climate Control (ECC) incorporating air conditioning i see page 52			●	○	○	234.04	275.00
Cruise control	○	○	○	○	○	170.21	200.00
Mechanical option							
Interactive Driving System-plus (IDS-plus) with Continuous Damping Control (CDC) i see page 53				○ ⁹	○	340.43	400.00
Exterior and convenience options							
Panoramic windscreen ¹⁰				○	○	723.40	850.00
Electrically foldable door mirrors				○	○	127.66	150.00
Adaptive Forward Lighting (AFL) incorporating bi-xenon headlights with high-pressure washers i see page 52				○	○	638.30	750.00
18-inch five-spoke alloy wheels with 225/40 R 18 tyres					○ ⁵	255.32	300.00
Full-size steel spare wheel/tyre (in lieu of space-saver spare)	○	○	○ ¹²	○	○ ¹³	85.11	100.00
Rear parking distance sensor i see page 51				○	○	297.87	350.00
Two-coat metallic or pearlescent paint	○	○	○	○	○	319.15	375.00
Audio and communication options							
CDC 40 • Integral six-disc CD autochanger with MP3 format • Stereo radio • Graphic display ¹⁴				○	○	340.43	400.00
CDC 40 DAB • Integral six-disc CD autochanger with MP3 format • Stereo radio with Digital Audio Broadcast (DAB) • Graphic display ¹⁵	○	○	○	○	○	382.98	450.00
CD 70 • Satellite navigation system • CD player with MP3 format • Stereo radio • Auxiliary-in socket • Colour monitor i see page 50				○	○	1063.83	1250.00
Mobile phone system with Bluetooth® (does not include phone or cradle) ¹ – see page 57 for mobile phone compatibility i see page 50	○	○	○	○	○	255.32	300.00

○ = Optional at extra cost. ● = Standard equipment.

¹ = Not available in conjunction with panoramic windscreen. ² = Standard on 1.6i 16v Turbo and 1.9CDTi 16v (150PS) models. Not available on 1.7CDTi 16v (110PS) ecoFLEX models or on models fitted with Easytronic transmission. 17-inch alloy wheels will affect the Vehicle Excise Duty payable on 1.8i 16v VVT automatic models – see page 2 for details. In addition, due to increased CO₂ emissions, on certain engines there will be a slight increase in benefit in kind charges for company car drivers. CO₂ emissions figures: 1.8i 16v VVT (manual) – 172g/km; 1.8i 16v VVT (automatic) – 186g/km. ³ = Only available on 1.6i 16v Turbo and 1.9CDTi 16v (150PS) models. Not available in conjunction with Power Red solid paint. ⁴ = Not available on 1.7CDTi 16v (110PS) ecoFLEX models. ⁵ = Standard on SRi with Exterior Pack models. ⁶ = Only available in conjunction with Seat Comfort Pack One. ⁷ = Standard on 1.6i 16v Turbo and 1.9CDTi diesel models. ⁸ = If fitted in conjunction with panoramic windscreen, ultrasonic sensors are deleted. ⁹ = Only available in conjunction with Sports Pack (Sports Pack is standard on 1.6i 16v Turbo and 1.9CDTi 16v (150PS) models). Not available on 1.7CDTi 16v (110PS) ecoFLEX models. ¹⁰ = Not available in conjunction with Sight and Light Pack or mobile phone system with Bluetooth®. Roof panel is coloured black. Deletes illuminated driver's and front passenger's vanity mirrors, front map reading lights, body-colour roof mouldings and driver's sunglasses holder. Not available in conjunction with Glacier White solid paint. ¹¹ = Deletes ultrasonic sensors from remote control security alarm system. ¹² = 16-inch steel spare wheel/tyre supplied if ordered in conjunction with Sports Pack. Not available in conjunction with Premium Pack. ¹³ = 16-inch steel spare wheel/tyre. Not available on SRi with Exterior Pack models or in conjunction with optional 18-inch alloy wheels. ¹⁴ = Deletes auxiliary-in socket. ¹⁵ = Deletes auxiliary-in socket. Not available in conjunction with VXR Styling Pack One.

5-door hatchback

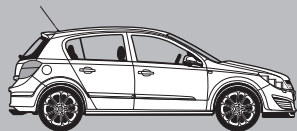

Model	Price (£)	VAT (£)	Total (£)	On-the-road RRP (£)	CO ₂ * (g/km)
Astra Expression					
1.4i 16v	9495.32	1661.68	11157.00	11955.00	146
Astra Life					
1.4i 16v	10903.83	1908.17	12812.00	13610.00	146
1.6i 16v VVT	11435.74	2001.26	13437.00	14260.00	155
1.6i 16v VVT Easytronic	11861.28	2075.72	13937.00	14760.00	151
1.8i 16v VVT	11882.55	2079.45	13962.00	14810.00	169
1.8i 16v VVT auto	12784.68	2237.32	15022.00	15910.00	186
1.4i 16v (a/c)	11329.36	1982.64	13312.00	14110.00	146
1.6i 16v VVT (a/c)	11861.28	2075.72	13937.00	14760.00	155
1.6i 16v VVT Easytronic (a/c)	12286.81	2150.19	14437.00	15260.00	151
1.8i 16v VVT (a/c)	12308.09	2153.91	14462.00	15310.00	169
1.8i 16v VVT auto (a/c)	13210.21	2311.79	15522.00	16410.00	186
Diesel					
1.3CDTi 16v (90PS)	12252.77	2144.23	14397.00	15195.00	130
1.3CDTi 16v (90PS) (a/c)	12678.30	2218.70	14897.00	15695.00	130
1.7CDTi 16v (100PS) (a/c)	12976.17	2270.83	15247.00	16045.00	135
1.7CDTi 16v (110PS) ecoFLEX (a/c)	13299.57	2327.43	15627.00	16340.00	119
Astra Club					
1.4i 16v	11797.45	2064.55	13862.00	14660.00	146
1.6i 16v VVT	12329.36	2157.64	14487.00	15310.00	155
1.6i 16v VVT Easytronic	12754.89	2232.11	14987.00	15810.00	151
1.8i 16v VVT	12776.17	2235.83	15012.00	15860.00	169
1.8i 16v VVT auto	13678.30	2393.70	16072.00	16960.00	186
Diesel					
1.3CDTi 16v (90PS)	13146.38	2300.62	15447.00	16245.00	130
1.7CDTi 16v (100PS)	13444.26	2352.74	15797.00	16595.00	138
1.7CDTi 16v (110PS) ecoFLEX	13767.66	2409.34	16177.00	16890.00	119



See pages 54-57 for accessory and styling products



See page 45 for fuel data



See page 59 for MasterFit Service Plan details

Model	Price (£)	VAT (£)	Total (£)	On-the-road RRP (£)	CO ₂ * (g/km)
Astra Breeze (Special Edition model)					
1.4i 16v	11831.49	2070.51	13902.00	14700.00	146
1.6i 16v VVT	12363.40	2163.60	14527.00	15350.00	155
1.8i 16v VVT auto	13708.09	2398.91	16107.00	16995.00	186
Diesel					
1.7CDTi 16v (100PS)	13478.30	2358.70	15837.00	16635.00	138
Astra Breeze Plus (Special Edition model)					
1.4i 16v	12214.47	2137.53	14352.00	15150.00	146
1.6i 16v VVT	12746.38	2230.62	14977.00	15800.00	155
1.8i 16v VVT auto	14091.06	2465.94	16557.00	17445.00	186
Diesel					
1.7CDTi 16v (100PS)	13861.28	2425.72	16287.00	17085.00	138
Astra Design					
1.6i 16v VVT	13057.02	2284.98	15342.00	16165.00	155
1.6i 16v VVT Easytronic	13482.55	2359.45	15842.00	16665.00	151
1.8i 16v VVT	13503.83	2363.17	15867.00	16715.00	169
1.8i 16v VVT auto	14405.96	2521.04	16927.00	17815.00	186
1.6i 16v Turbo	15444.26	2702.74	18147.00	18995.00	185
Diesel					
1.7CDTi 16v (100PS)	14171.91	2480.09	16652.00	17450.00	138
1.7CDTi 16v (110PS) ecoFLEX	14495.32	2536.68	17032.00	17745.00	119
1.9CDTi (120PS)	14899.57	2607.43	17507.00	18305.00	149
1.9CDTi (120PS) auto	16014.47	2802.53	18817.00	19705.00	189
1.9CDTi 16v (150PS)	15622.98	2734.02	18357.00	19155.00	149

Please note: On-the-road recommended retail prices (RRP) include number plates and delivery to retailer of £623.00 (inc. £92.79 VAT), 12 months' Vehicle Excise Duty (see page 2) and new vehicle first registration fee of £55.00. Excludes fuel and insurance.

* = CO₂ emission figures. Vehicle Excise Duty is based on CO₂ emissions (see page 2 for details).

For benefit in kind taxation charges see page 2.

a/c = Air conditioning.

Accessory highlights

Astra accessories

	Price (£) exc. VAT	Total (£) inc. VAT
Travel Pack		
• First aid kit • Warning triangle • Hi-visibility vest	21.28	25.00
Protection Pack		
• Velour mats (four) • Mudflaps (four) • Cargo liner	135.32	159.00

For further details of accessories and styling products see pages 54-57.

Option availability

	Expression	Life	Club	Breeze	Breeze Plus	Design	Price (£) exc. VAT	Total (£) inc. VAT
Option packs								
Protection Pack ¹ • Full-size curtain airbags • Active-safety front seat head restraints	○	○					170.21	200.00
Sports Pack • 17-inch 10-spoke alloy wheels with 225/45 R 17 tyres • Uprated sports suspension • Uprated sports steering • Electronic Stability Programme-plus (ESP-plus) i see page 53 • Sport switch						○ ²	553.19	650.00
VXR Styling Pack One ³ • Body-colour front lower spoiler/rear lower skirt/rear roof spoiler and side sills • Aerial adaptor			○			○	680.85	800.00
Seat Comfort Pack One • Driver's seat with tilt and lumbar adjustment			○	○	○	●	127.66	150.00
Seat Comfort Pack Two • Front passenger's seat with height, tilt and lumbar adjustment			○ ⁴	○ ⁴	○ ⁴	○	85.11	100.00
Safety and security options								
Electronic Stability Programme-plus (ESP-plus) i see page 53	○	○	○	○	○	○ ⁵	361.70	425.00
Keyless entry and start i see page 51			○	○	○	○	255.32	300.00
Remote control ultrasonic security alarm		○	○	○	○	○	191.49	225.00
Interior options								
Electronic Climate Control (ECC) incorporating air conditioning i see page 52			○		●	○	234.04	275.00
Cruise control			○	○	○	○	170.21	200.00
Mechanical option								
Interactive Driving System-plus (IDS-plus) with Continuous Damping Control (CDC) i see page 53						○ ⁶	340.43	400.00
Exterior and convenience options								
Electrically operated full-length slide/tilt sunroof			○			○	510.64	600.00
Electrically foldable door mirrors			○			○	127.66	150.00
Adaptive Forward Lighting (AFL) incorporating dark-style bi-xenon headlights with high-pressure washers i see page 52						○	638.30	750.00
Full-size steel spare wheel/tyre (in lieu of space-saver spare)	○	○	○	○	○	○ ⁷	85.11	100.00
Rear parking distance sensor i see page 51			○			○	297.87	350.00
Two-coat metallic or pearlescent paint	○	○	○	○	○	○	319.15	375.00
Audio and communication options								
CD 30 MP3 • CD player with MP3 format • Stereo radio • Auxiliary-in socket i see page 51		○ ⁸	○	●	●	●	63.83	75.00
CDC 40 • Integral six-disc CD autochanger with MP3 format • Stereo radio • Graphic display		○ ⁸	○			○ ⁹	340.43	400.00
CDC 40 DAB • Integral six-disc CD autochanger with MP3 format • Stereo radio with Digital Audio Broadcast (DAB) • Graphic display ¹⁰		○ ⁸	○	○ ⁹	○ ⁹	○ ⁹	382.98	450.00
CD 70 • Satellite navigation system • CD player with MP3 format • Stereo radio • Auxiliary-in socket • Colour monitor i see page 50		○ ⁸	○			○	1063.83	1250.00
Mobile phone system with Bluetooth® (does not include phone or cradle) – see page 57 for mobile phone compatibility i see page 50		○ ⁸	○	○	○	○	255.32	300.00

○ = Optional at extra cost. ● = Standard equipment.

¹ = For details on the correct fitment of child seats when the vehicle is fitted with a front passenger's airbag or side-impact airbags please consult your Vauxhall retailer. ² = Standard on 1.6i 16v Turbo and 1.9CDTi 16v (150PS) models. Not available on 1.7CDTi 16v (110PS) ecoFLEX models or on models fitted with Easytronic transmission. Due to increased CO₂ emissions, on certain engines there will be a slight increase in benefit in kind charges for company car drivers. CO₂ emissions figures: 1.8i 16v VVT (manual) – 172g/km. ³ = Not available on 1.7CDTi 16v (110PS) ecoFLEX models. ⁴ = Only available in conjunction with Seat Comfort Pack One. ⁵ = Standard on 1.6i 16v Turbo and 1.9CDTi diesel models. ⁶ = Only available in conjunction with Sports Pack (Sports Pack is standard on 1.6i 16v Turbo and 1.9CDTi 16v (150PS) models). Not available on 1.7CDTi 16v (110PS) ecoFLEX models. ⁷ = 16-inch steel spare wheel/tyre supplied if ordered in conjunction with Sports Pack. ⁸ = Includes steering wheel mounted audio controls. ⁹ = Deletes auxiliary-in socket. ¹⁰ = Not available in conjunction with VXR Styling Pack One.

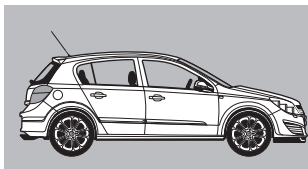

5-door hatchback

Model	Price (£)	VAT (£)	Total (£)	On-the-road RRP (£)	CO ₂ * (g/km)
Astra Elite					
1.6i 16v VVT	13946.38	2440.62	16387.00	17210.00	155
1.6i 16v VVT Easytronic	14371.91	2515.09	16887.00	17710.00	151
1.8i 16v VVT	14393.19	2518.81	16912.00	17760.00	169
1.8i 16v VVT auto	15295.32	2676.68	17972.00	18860.00	186
<i>Diesel</i>					
1.7CDTi 16v (100PS)	15061.28	2635.72	17697.00	18495.00	138
1.9CDTi (120PS)	15788.94	2763.06	18552.00	19350.00	149
1.9CDTi (120PS) auto	16903.83	2958.17	19862.00	20750.00	189
Astra SXi					
1.4i 16v	12222.98	2139.02	14362.00	15160.00	146
1.6i 16v VVT	12754.89	2232.11	14987.00	15810.00	155
1.6i 16v VVT Easytronic	13180.43	2306.57	15487.00	16310.00	151
<i>Diesel</i>					
1.7CDTi 16v (100PS)	13869.79	2427.21	16297.00	17095.00	138
1.7CDTi 16v (110PS) ecoFLEX	14193.19	2483.81	16677.00	17390.00	119
1.9CDTi (120PS)	13993.19	2448.81	16442.00	17240.00	149
Astra SRI					
1.8i 16v VVT	13784.68	2412.32	16197.00	17045.00	172
1.8i 16v VVT auto	14686.81	2570.19	17257.00	18145.00	189
1.6i 16v Turbo	15188.94	2658.06	17847.00	18695.00	185
<i>Diesel</i>					
1.7CDTi 16v (100PS)	14465.53	2531.47	16997.00	17795.00	138
1.9CDTi (120PS)	14937.87	2614.13	17552.00	18350.00	149
1.9CDTi (120PS) auto	16052.77	2809.23	18862.00	19750.00	189
1.9CDTi 16v (150PS)	15363.40	2688.60	18052.00	18850.00	149

Model	Price (£)	VAT (£)	Total (£)	On-the-road RRP (£)	CO ₂ * (g/km)
Astra SRI with Exterior Pack**					
1.8i 16v VVT	14550.64	2546.36	17097.00	17945.00	172
1.8i 16v VVT auto	15452.77	2704.23	18157.00	19045.00	189
1.6i 16v Turbo	15954.89	2792.11	18747.00	19595.00	185
<i>Diesel</i>					
1.7CDTi 16v (100PS)	15231.49	2665.51	17897.00	18695.00	138
1.9CDTi (120PS)	15703.83	2748.17	18452.00	19250.00	149
1.9CDTi (120PS) auto	16818.72	2943.28	19762.00	20650.00	189
1.9CDTi 16v (150PS)	16129.36	2822.64	18952.00	19750.00	149

Please note: On-the-road recommended retail prices (RRP) include number plates and delivery to retailer of £623.00 (inc. £92.79 VAT), 12 months' Vehicle Excise Duty (see page 2) and new vehicle first registration fee of £55.00. Excludes fuel and insurance.

* = CO₂ emission figures. Vehicle Excise Duty is based on CO₂ emissions (see page 2 for details). For benefit in kind taxation charges see page 2.

** = Exterior Pack comprises 18-inch five-spoke alloy wheels and VXR Styling Pack One (see page 19 for details).



See pages 54-57 for accessory and styling products



See page 45 for fuel data



See page 59 for MasterFit Service Plan details

Accessory highlights

Astra accessories

	Price (£) exc. VAT	Total (£) inc. VAT
Travel Pack		
• First aid kit • Warning triangle • Hi-visibility vest	21.28	25.00
Protection Pack		
• Velour mats (four) • Mudflaps (four) • Cargo liner	135.32	159.00

For further details of accessories and styling products see pages 54-57.

Option availability

	Elite	SXi	SRI	Price (£) exc. VAT	Total (£) inc. VAT
Option packs					
Sight and Light Pack • Rain-sensitive windscreen wipers • Electro-chromatic anti-dazzle rear-view mirror • Automatic lighting control	●	○	○	170.21	200.00
Leather Pack • Leather seat facings • Electrically heated sports front seats with tilt and lumbar adjustment • Indirect door night lighting • Centre rear seat head restraint • Front passenger's seat height adjuster	●	○	○	851.06	1000.00
VXR Styling Pack One • Body-colour front lower spoiler/rear lower skirt/rear roof spoiler (standard on SRI models) and side sills • Aerial adaptor	○	○ ¹	● ²	680.85	800.00
Seat Comfort Pack One • Driver's seat with tilt and lumbar adjustment	●	○	○	127.66	150.00
Seat Comfort Pack Two ³ • Front passenger's seat with height, tilt and lumbar adjustment	●	○	○	85.11	100.00
Safety and security options					
Electronic Stability Programme-plus (ESP-plus) ⓘ see page 53	○ ⁴	○	●	361.70	425.00
Keyless entry and start ⓘ see page 51	○	○	○	255.32	300.00
Remote control ultrasonic security alarm	○	○	●	191.49	225.00
Interior options					
Electronic Climate Control (ECC) incorporating air conditioning ⓘ see page 52	●	○	○	234.04	275.00
Cruise control	●	○	○	170.21	200.00
Mechanical option					
Interactive Driving System-plus (IDS-plus) with Continuous Damping Control (CDC) ⓘ see page 53			○	340.43	400.00
Exterior and convenience options					
Electrically operated full-length slide/tilt sunroof	○	○	○	510.64	600.00
Electrically foldable door mirrors	●	○	○	127.66	150.00
Adaptive Forward Lighting (AFL) incorporating dark-style bi-xenon headlights with high-pressure washers ⓘ see page 52	○	○	○	638.30	750.00
18-inch five-spoke alloy wheels with 225/40 R 18 tyres			○ ²	255.32	300.00
Full-size steel spare wheel/tyre (in lieu of space-saver spare)	○	○	○ ⁵	85.11	100.00
Rear parking distance sensor ⓘ see page 51	○	○	○	297.87	350.00
Two-coat metallic or pearlescent paint	○	○	○	319.15	375.00
Audio and communication options					
CDC 40 • Integral six-disc CD autochanger with MP3 format • Stereo radio • Graphic display ⁶	○	○	○	340.43	400.00
CDC 40 DAB • Integral six-disc CD autochanger with MP3 format • Stereo radio with Digital Audio Broadcast (DAB) • Graphic display ⁷	○	○		382.98	450.00
CD 70 • Satellite navigation system • CD player with MP3 format • Stereo radio • Auxiliary-in socket • Colour monitor ⓘ see page 50	○	○	○	1063.83	1250.00
Mobile phone system with Bluetooth® (does not include phone or cradle) – see page 57 for mobile phone compatibility ⓘ see page 50	○	○	○	255.32	300.00

○ = Optional at extra cost. ● = Standard equipment.

¹ = Not available on 1.7CDTi 16v (110PS) ecoFLEX models. ² = Standard on SRI with Exterior Pack models. ³ = Only available in conjunction with Seat Comfort Pack One. ⁴ = Standard on 1.9CDTi diesel models. ⁵ = 16-inch steel spare wheel/tyre. Not available on SRI with Exterior Pack models or in conjunction with optional 18-inch alloy wheels. ⁶ = Deletes auxiliary-in socket. ⁷ = Deletes auxiliary-in socket. Not available in conjunction with VXR Styling Pack One.

5-door estate

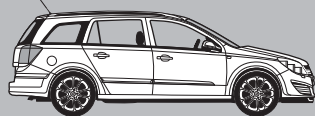

Model	Price (£)	VAT (£)	Total (£)	On-the-road RRP (£)	CO ₂ * (g/km)
Astra Life					
1.4i 16v	11669.79	2042.21	13712.00	14510.00	146
1.6i 16v VVT	12201.70	2135.30	14337.00	15160.00	158
1.6i 16v VVT Easytronic	12627.23	2209.77	14837.00	15660.00	153
1.8i 16v VVT	12635.74	2211.26	14847.00	15695.00	172
1.8i 16v VVT auto	13537.87	2369.13	15907.00	16795.00	186
1.4i 16v (a/c)	12095.32	2116.68	14212.00	15010.00	146
1.6i 16v VVT (a/c)	12627.23	2209.77	14837.00	15660.00	158
1.6i 16v VVT Easytronic (a/c)	13052.77	2284.23	15337.00	16160.00	153
1.8i 16v VVT (a/c)	13061.28	2285.72	15347.00	16195.00	172
1.8i 16v VVT auto (a/c)	13963.40	2443.60	16407.00	17295.00	186
Diesel					
1.3CDTi 16v (90PS)	13018.72	2278.28	15297.00	16095.00	130
1.3CDTi 16v (90PS) (a/c)	13444.26	2352.74	15797.00	16595.00	130
1.7CDTi 16v (100PS) (a/c)	13742.13	2404.87	16147.00	16945.00	135
1.7CDTi 16v (110PS) ecoFLEX (a/c)	14065.53	2461.47	16527.00	17240.00	119
Astra Club					
1.4i 16v	12563.40	2198.60	14762.00	15560.00	146
1.6i 16v VVT	13095.32	2291.68	15387.00	16210.00	158
1.6i 16v VVT Easytronic	13520.85	2366.15	15887.00	16710.00	153
1.8i 16v VVT	13529.36	2367.64	15897.00	16745.00	172
1.8i 16v VVT auto	14431.49	2525.51	16957.00	17845.00	186
Diesel					
1.3CDTi 16v (90PS)	13912.34	2434.66	16347.00	17145.00	130
1.7CDTi 16v (100PS)	14210.21	2486.79	16697.00	17495.00	138
1.7CDTi 16v (110PS) ecoFLEX	14533.62	2543.38	17077.00	17790.00	119

Please note: On-the-road recommended retail prices (RRP) include number plates and delivery to retailer of £623.00 (inc. £92.79 VAT), 12 months' Vehicle Excise Duty (see page 2) and new vehicle first registration fee of £55.00. Excludes fuel and insurance.

* = CO₂ emission figures. Vehicle Excise Duty is based on CO₂ emissions (see page 2 for details). For benefit in kind taxation charges see page 2.

** = Exterior Pack comprises 18-inch five-spoke alloy wheels and VXR Styling Pack One (see page 21 for details).

a/c = Air conditioning.

Model	Price (£)	VAT (£)	Total (£)	On-the-road RRP (£)	CO ₂ * (g/km)
Astra Design					
1.6i 16v VVT	13822.98	2419.02	16242.00	17065.00	158
1.6i 16v VVT Easytronic	14248.51	2493.49	16742.00	17565.00	153
1.8i 16v VVT	14257.02	2494.98	16752.00	17600.00	172
1.8i 16v VVT auto	15159.15	2652.85	17812.00	18700.00	186
1.6i 16v Turbo	16210.21	2836.79	19047.00	19895.00	185
Diesel					
1.7CDTi 16v (100PS)	14937.87	2614.13	17552.00	18350.00	138
1.7CDTi 16v (110PS) ecoFLEX	15261.28	2670.72	17932.00	18645.00	119
1.9CDTi (120PS)	15644.26	2737.74	18382.00	19205.00	151
1.9CDTi (120PS) auto	16780.43	2936.57	19717.00	20605.00	189
1.9CDTi 16v (150PS)	16367.66	2864.34	19232.00	20055.00	151
Astra SXi					
1.4i 16v	12988.94	2273.06	15262.00	16060.00	146
1.6i 16v VVT	13520.85	2366.15	15887.00	16710.00	158
1.6i 16v VVT Easytronic	13946.38	2440.62	16387.00	17210.00	153
Diesel					
1.7CDTi 16v (100PS)	14635.74	2561.26	17197.00	17995.00	138
1.7CDTi 16v (110PS) ecoFLEX	14959.15	2617.85	17577.00	18290.00	119
1.9CDTi (120PS)	14737.87	2579.13	17317.00	18140.00	151
Astra SRI					
1.8i 16v VVT	14550.64	2546.36	17097.00	17945.00	174
1.8i 16v VVT auto	15452.77	2704.23	18157.00	19045.00	189
1.6i 16v Turbo	15954.89	2792.11	18747.00	19595.00	185
Diesel					
1.7CDTi 16v (100PS)	15231.49	2665.51	17897.00	18695.00	138
1.9CDTi (120PS)	15682.55	2744.45	18427.00	19250.00	151
1.9CDTi (120PS) auto	16818.72	2943.28	19762.00	20650.00	189
1.9CDTi 16v (150PS)	16108.09	2818.91	18927.00	19750.00	151
Astra SRI with Exterior Pack**					
1.8i 16v VVT	15316.60	2680.40	17997.00	18845.00	174
1.8i 16v VVT auto	16218.72	2838.28	19057.00	19945.00	189
1.6i 16v Turbo	16720.85	2926.15	19647.00	20495.00	185
Diesel					
1.7CDTi 16v (100PS)	15997.45	2799.55	18797.00	19595.00	138
1.9CDTi (120PS)	16448.51	2878.49	19327.00	20150.00	151
1.9CDTi (120PS) auto	17584.68	3077.32	20662.00	21550.00	189
1.9CDTi 16v (150PS)	16874.04	2952.96	19827.00	20650.00	151



See pages 54-57 for accessory and styling products



See page 46 for fuel data



See page 59 for MasterFit Service Plan details

Option availability

	Life	Club	Design	SXi	SRi	Price (£) exc. VAT	Total (£) inc. VAT
Option packs							
Protection Pack ¹ • Full-size curtain airbags • Active-safety front seat head restraints	○					170.21	200.00
Leather Pack • Leather seat facings • Electrically heated sports front seats with tilt and lumbar adjustment • Indirect door night lighting • Centre rear seat head restraint • Front passenger's seat height adjuster				○	○	851.06	1000.00
Sports Pack • 17-inch 10-spoke alloy wheels with 225/45 R 17 tyres • Uprated sports suspension • Uprated sports steering • Electronic Stability Programme-plus (ESP-plus) 1 see page 53 • Sport switch			○ ²			553.19	650.00
VXR Styling Pack One • Body-colour front lower spoiler/rear lower skirt/rear roof spoiler (standard on SRi models) and side sills • Aerial adaptor	○ ³	○ ³	○ ³	● ⁴		680.85	800.00
Seat Comfort Pack One • Driver's seat with tilt and lumbar adjustment	○	●	○	○		127.66	150.00
Seat Comfort Pack Two • Front passenger's seat with height, tilt and lumbar adjustment	○ ⁵	○	○ ⁵	○ ⁵		85.11	100.00
Convenience Pack • Vertical load-restraining net • 12-volt auxiliary power socket in luggage area	○	○	○	○		144.68	170.00
FlexOrganiser® Organiser Pack • Four side rails • Divider net • Elasticated bag with four clips	○	○	○	○		42.55	50.00
Safety and security options							
Electronic Stability Programme-plus (ESP-plus) 1 see page 53	○	○	○ ⁶	○	●	361.70	425.00
Keyless entry and start 1 see page 51		○	○	○	○	255.32	300.00
Remote control ultrasonic security alarm	○	○	○	○	●	191.49	225.00
Interior options							
Electronic Climate Control (ECC) incorporating air conditioning 1 see page 52		○	○	○	○	234.04	275.00
Cruise control		○	○	○	○	170.21	200.00
Vertical load-restraining net	○	○	○	○	○	127.66	150.00
Mechanical option							
Interactive Driving System-plus (IDS-plus) with Continuous Damping Control (CDC) 1 see page 53			○ ⁷		○	340.43	400.00
Exterior and convenience options							
Electrically operated full-length slide/tilt sunroof		○	○	○	○	510.64	600.00
Electrically foldable door mirrors		○	○	○	○	127.66	150.00
Adaptive Forward Lighting (AFL) incorporating dark-style bi-xenon headlights with high-pressure washers 1 see page 52				○	○	638.30	750.00
18-inch five-spoke alloy wheels with 225/40 R 18 tyres					○ ⁴	255.32	300.00
Full-size steel spare wheel/tyre (in lieu of space-saver spare)	○	○	○ ⁸	○	○ ⁹	85.11	100.00
Rear parking distance sensor 1 see page 51		○	○	○	○	297.87	350.00
Two-coat metallic or pearlescent paint	○	○	○	○	○	319.15	375.00
Audio and communication options							
CD 30 MP3 • CD player with MP3 format • Stereo radio • Auxiliary-in socket 1 see page 51	○ ¹⁰	○	●	●	●	63.83	75.00
CDC 40 • Integral six-disc CD autochanger with MP3 format • Stereo radio • Graphic display	○ ¹⁰	○	○ ¹¹	○ ¹¹	○ ¹¹	340.43	400.00
CDC 40 DAB • Integral six-disc CD autochanger with MP3 format • Stereo radio with Digital Audio Broadcast (DAB) • Graphic display ¹²	○ ¹⁰	○	○	○		382.98	450.00
CD 70 • Satellite navigation system • CD player with MP3 format • Stereo radio • Auxiliary-in socket • Colour monitor 1 see page 50	○ ¹⁰	○	○	○	○	1063.83	1250.00
Mobile phone system with Bluetooth® (does not include phone or cradle) – see page 57 for mobile phone compatibility 1 see page 50	○ ¹⁰	○	○	○	○	255.32	300.00

○ = Optional at extra cost. ● = Standard equipment. **1** = For details on the correct fitment of child seats when the vehicle is fitted with a front passenger's airbag or side-impact airbags please consult your Vauxhall retailer. **2** = Standard on 1.6i 16v Turbo and 1.9CDTi 16v (150PS) models. Not available on 1.7CDTi 16v (110PS) ecoFLEX models or on models fitted with Easytronic transmission. **3** = Not available on 1.7CDTi 16v (110PS) ecoFLEX models. **4** = Standard on SRi with Exterior Pack models. **5** = Only available in conjunction with Seat Comfort Pack One. **6** = Standard on 1.6i 16v Turbo and 1.9CDTi diesel models. **7** = Only available in conjunction with Sports Pack (Sports Pack is standard on 1.6i 16v Turbo and 1.9CDTi 16v (150PS) models). Not available on 1.7CDTi 16v (110PS) ecoFLEX models. **8** = 16-inch steel spare wheel/tyre supplied if ordered in conjunction with Sports Pack. **9** = 16-inch steel spare wheel/tyre. Not available on SRi with Exterior Pack models or in conjunction with optional 18-inch alloy wheels. **10** = Includes steering wheel mounted audio controls. **11** = Deletes auxiliary-in socket. **12** = Deletes auxiliary-in socket. Not available in conjunction with VXR Styling Pack One.

2-door coupé convertible

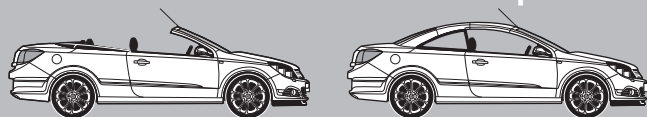

Model	Price (£)	VAT (£)	Total (£)	On-the-road RRP (£)	CO ₂ * (g/km)
Astra TwinTop Air					
1.6i 16v VVT	14776.17	2585.83	17362.00	18185.00	163
1.8i 16v VVT	15180.43	2656.57	17837.00	18685.00	177
1.8i 16v VVT auto	16048.51	2808.49	18857.00	19745.00	191
<i>Diesel</i>					
1.9CDTi 16v (150PS)	16903.83	2958.17	19862.00	20685.00	159
Astra TwinTop Sport					
1.6i 16v VVT	15499.57	2712.43	18212.00	19035.00	163
1.8i 16v VVT	15903.83	2783.17	18687.00	19535.00	177
1.8i 16v VVT auto	16771.91	2935.09	19707.00	20595.00	191
<i>Diesel</i>					
1.9CDTi 16v (150PS)	17627.23	3084.77	20712.00	21535.00	159
Astra TwinTop Design					
1.8i 16v VVT	16669.79	2917.21	19587.00	20435.00	177
1.8i 16v VVT auto	17537.87	3069.13	20607.00	21495.00	191
2.0i 16v Turbo (200PS)	18388.94	3218.06	21607.00	22685.00	228
<i>Diesel</i>					
1.9CDTi 16v (150PS)	18393.19	3218.81	21612.00	22435.00	159

Please note: On-the-road recommended retail prices (RRP) include number plates and delivery to retailer of £623.00 (inc. £92.79 VAT), 12 months' Vehicle Excise Duty (see page 2) and new vehicle first registration fee of £55.00. Excludes fuel and insurance.

* = CO₂ emission figures. Vehicle Excise Duty is based on CO₂ emissions (see page 2 for details).

For benefit in kind taxation charges see page 2.

** = Exterior Pack comprises VXR Styling Pack One (see page 23 for details).

Model	Price (£)	VAT (£)	Total (£)	On-the-road RRP (£)	CO ₂ * (g/km)
Astra TwinTop Exclusiv (Special Edition model)					
1.8i 16v VVT	16099.57	2817.43	18917.00	19765.00	177
1.8i 16v VVT auto	16967.66	2969.34	19937.00	20825.00	191
2.0i 16v Turbo (200PS)	17818.72	3118.28	20937.00	22015.00	228
<i>Diesel</i>					
1.9CDTi 16v (150PS)	17822.98	3119.02	20942.00	21765.00	159
Astra TwinTop Exclusiv with Exterior Pack** (Special Edition model)					
1.8i 16v VVT	16695.32	2921.68	19617.00	20465.00	177
1.8i 16v VVT auto	17563.40	3073.60	20637.00	21525.00	191
2.0i 16v Turbo (200PS)	18414.47	3222.53	21637.00	22715.00	228
<i>Diesel</i>					
1.9CDTi 16v (150PS)	18418.72	3223.28	21642.00	22465.00	159

Accessory highlights

	Price (£) exc. VAT	Total (£) inc. VAT
Astra accessories		
Travel Pack		
• First aid kit • Warning triangle • Hi-visibility vest	21.28	25.00
Protection Pack		
• Velour mats (four) • Mudflaps (four) • Cargo liner	135.32	159.00

For further details of accessories and styling products see pages 54-57.



See pages 54-57 for accessory and styling products



See page 46 for fuel data



See page 59 for MasterFit Service Plan details

Option availability

	Air	Sport	Design	Exclusiv	Price (£) exc. VAT	Total (£) inc. VAT
Option packs						
Leather Pack • Leather seat facings • Electrically heated sports front seats with driver's tilt and lumbar adjustment • Indirect door night lighting			○	●	638.30	750.00
Plus Pack • 17-inch five-spoke alloy wheels with 225/45 R 17 ultra-low profile tyres • Cruise control		○			297.87	350.00
Plus Pack • 18-inch 11-spoke alloy wheels with 225/40 R 18 ultra-low profile tyres • Cruise control			○	●	382.98	450.00
Premium Pack • 18-inch 11-spoke alloy wheels with 225/40 R 18 ultra-low profile tyres • Cruise control • Satellite navigation with colour monitor/CD player with MP3 format/auxiliary-in socket/stereo radio (CD 70) i see page 50			○		1191.49	1400.00
VXR Styling Pack One • Body-colour front lower spoiler/rear lower skirt/rear lip spoiler and side sills		○	○	● ¹	680.85	800.00
Safety option						
Electronic Stability Programme-plus (ESP-plus) with traction control i see page 53	○ ²	○ ²	●	●	361.70	425.00
Interior options						
Electronic Climate Control (ECC) incorporating air conditioning i see page 52			○		234.04	275.00
Cruise control	○	○	○	●	170.21	200.00
Exterior and convenience options						
Adaptive Forward Lighting (AFL) incorporating dark-style bi-xenon headlights with dynamic beam levelling and high-pressure washers i see page 52			○	○	638.30	750.00
Steel space-saver spare wheel/tyre (in lieu of emergency tyre inflation kit)	○	○	○		85.11	100.00
Rear parking distance sensor i see page 51	○	○	○	○	297.87	350.00
Windbreak	○	○	●	●	127.66	150.00
Two-coat metallic or pearlescent paint	○	○	○	○	319.15	375.00
Audio and communication options						
CDC 40 • Integral six-disc CD autochanger with MP3 format • Stereo radio • Graphic display		○ ³	○ ³		382.98	450.00
CD 70 • Satellite navigation system • CD player with MP3 format • Stereo radio • Auxiliary-in socket • Colour monitor i see page 50		○	○	○	1063.83	1250.00
Mobile phone system with Bluetooth® (does not include phone or cradle) – see page 57 for details of mobile phone compatibility i see page 50	○ ⁴	○	○		255.32	300.00

○ = Optional at extra cost. ● = Standard equipment.

¹ = Standard on Exclusiv with Exterior Pack models. ² = Standard on 1.9CDTi 16v models only. ³ = Deletes auxiliary-in socket. ⁴ = Includes graphic information display.



5-door MPV

Model	Price (£)	VAT (£)	Total (£)	On-the-road RRP (£)	CO ₂ * (g/km)
Zafira Expression					
1.6i 16v	10695.32	1871.68	12567.00	13415.00	172
Zafira Life					
1.6i 16v	12725.11	2226.89	14952.00	15800.00	172
1.6i 16v (a/c)	13150.64	2301.36	15452.00	16300.00	172
1.8i 16v VVT	13767.66	2409.34	16177.00	17025.00	177
1.8i 16v VVT Easytronic	14193.19	2483.81	16677.00	17525.00	172
2.2i 16v Direct	14712.34	2574.66	17287.00	18175.00	197
2.2i 16v Direct auto	15691.06	2745.94	18437.00	19325.00	204
<i>Diesel</i>					
1.9CDTi (120PS)	14865.53	2601.47	17467.00	18290.00	159
1.9CDTi (120PS) auto	16001.70	2800.30	18802.00	19690.00	194
Zafira Exclusiv					
1.6i 16v	11788.94	2063.06	13852.00	14700.00	172
1.8i 16v VVT	12405.96	2171.04	14577.00	15425.00	177
1.8i 16v VVT Easytronic	12831.49	2245.51	15077.00	15925.00	172
2.2i 16v Direct	13350.64	2336.36	15687.00	16575.00	197
2.2i 16v Direct auto	14329.36	2507.64	16837.00	17725.00	204
<i>Diesel</i>					
1.9CDTi (120PS)	13503.83	2363.17	15867.00	16690.00	159
1.9CDTi (120PS) auto	14640.00	2562.00	17202.00	18090.00	194

Accessory highlights

Zafira accessories

	Price (£) exc. VAT	Total (£) inc. VAT
Travel Pack		
• First aid kit • Warning triangle • Hi-visibility vest	21.28	25.00
Protection Pack		
• Velour mats (four) • Mudflaps (four) • Cargo liner	135.32	159.00

For further details of accessories and styling products see pages 54-57.

Model	Price (£)	VAT (£)	Total (£)	On-the-road RRP (£)	CO ₂ * (g/km)
Zafira Breeze (Special Edition model)					
1.6i 16v	13235.74	2316.26	15552.00	16400.00	172
1.8i 16v VVT	13852.77	2424.23	16277.00	17125.00	177
2.2i 16v Direct auto	15776.17	2760.83	18537.00	19425.00	204
<i>Diesel</i>					
1.9CDTi (120PS)	14950.64	2616.36	17567.00	18390.00	159
1.9CDTi (120PS) auto	16086.81	2815.19	18902.00	19790.00	194
Zafira Breeze Plus (Special Edition model)					
1.6i 16v	13618.72	2383.28	16002.00	16850.00	172
1.8i 16v VVT	14235.74	2491.26	16727.00	17575.00	177
2.2i 16v Direct auto	16159.15	2827.85	18987.00	19875.00	204
<i>Diesel</i>					
1.9CDTi (120PS)	15333.62	2683.38	18017.00	18840.00	159
1.9CDTi (120PS) auto	16469.79	2882.21	19352.00	20240.00	194

Please note: On-the-road recommended retail prices (RRP) include number plates and delivery to retailer of £623.00 (inc. £92.79 VAT), 12 months' Vehicle Excise Duty (see page 2) and new vehicle first registration fee of £55.00. Excludes fuel and insurance.

* = CO₂ emission figures. Vehicle Excise Duty is based on CO₂ emissions (see page 2 for details).

For benefit in kind taxation charges see page 2.

a/c = Air conditioning.



See page 42
for VXR model



See pages
54-57 for
accessory and
styling products



See page 46
for fuel data



See page 59
for MasterFit
Service Plan
details

Option availability

Option packs

	Expression	Life	Exclusiv	Breeze	Breeze Plus	Price (£) exc. VAT	Total (£) inc. VAT
VXR Styling Pack One • Body-colour lower front spoiler/rear lower skirt/rear roof spoiler and side sills			○			680.85	800.00
Seat Comfort Pack One • Driver's seat with tilt and lumbar adjustment			○			127.66	150.00
Seat Comfort Pack Two ¹ • Front passenger's seat with height, tilt and lumbar adjustment			○ ²			85.11	100.00
Panoramic Roof Pack ³ • Four glass roof panels • Roof-mounted storage console for front and rear passengers • Alloy-effect roof rails • Heat-reflective windscreen			○ ⁴			723.40	850.00
Towing Pack ⁴ • Trailer stability programme • Hill Start Assist (HSA) ⁵ ⓘ see page 53 • Deflation Detection System (DDS) ⁵ • Cruise control • Detachable tow bar			○ ⁶			297.87	350.00
FlexOrganiser® Organiser Pack • 3D storage net • Side net pocket • Four side rail hooks • Four side rails			○	○	○	42.55	50.00

Safety and security options

Electronic Stability Programme-plus (ESP-plus) (1.6i 16v/1.8i 16v/1.9CDTi (120PS) only) ⓘ see page 53	○	○ ⁷	○ ⁷	○ ⁷	○ ⁷	361.70	425.00
Keyless entry and start ⓘ see page 51			○	○	○	255.32	300.00
Remote control ultrasonic security alarm system		○	○	○	○	191.49	225.00

Interior options

Electronic Climate Control (ECC) ⓘ see page 52			○		●	234.04	275.00
Cruise control			○	○	○	170.21	200.00
Vertical load-restraining net		○	○	○	○	127.66	150.00

Exterior and convenience options

Adaptive Forward Lighting (AFL) incorporating bi-xenon headlights with dynamic beam levelling and high-pressure washers ⓘ see page 52			○ ⁸			638.30	750.00
17-inch 10-spoke alloy wheels with 225/45 R 17 ultra-low profile tyres			○ ⁹			340.43	400.00
Full-size steel spare wheel (in lieu of emergency tyre inflation kit)	○	○	○	○	○	85.11	100.00
Front and rear parking distance sensors ⓘ see page 51			○	○	○	297.87	350.00
Two-coat metallic or pearlescent paint	○	○	○	○	○	319.15	375.00

Audio and communication options

CD 30 MP3 • CD player with MP3 format • Stereo radio • Auxiliary-in socket ⓘ see page 51		○	○			63.83	75.00
CDC 40 • Integral six-disc CD autochanger with MP3 format • Stereo radio • Graphic display			○ ¹⁰			340.43	400.00
CDC 40 DAB • Integral six-disc CD autochanger with MP3 format • Stereo radio with Digital Audio Broadcast (DAB) • Graphic display			○ ¹¹	○	○	382.98	450.00
CD 70 • Satellite navigation system • CD player with MP3 format • Stereo radio • Auxiliary-in socket • Colour monitor ⓘ see page 50		○	○			1063.83	1250.00
Rear seat Twin Audio® system with single headset ¹² ⓘ see page 50			○	○	○	85.11	100.00
Mobile phone system with Bluetooth® (does not include phone or cradle) – see page 57 for details of mobile phone compatibility ⓘ see page 50		○	○	○	○	255.32	300.00

○ = Optional at extra cost. ● = Standard equipment.

¹ = Deletes front passenger's underseat storage tray. ² = Only available in conjunction with Seat Comfort Pack One. ³ = Deletes sunglasses holder. ⁴ = Only available in conjunction with Electronic Stability Programme-plus. ⁵ = Not available on models fitted with automatic transmission. ⁶ = Requires 13-pin adaptor (available as a Vauxhall accessory). ⁷ = Standard on 2.2i 16v Direct model. ⁸ = Includes front fog lights. ⁹ = Includes Electronic Stability Programme-plus. ¹⁰ = Only available in conjunction with VXR Styling Pack One. Deletes auxiliary-in socket (where fitted). ¹¹ = Not available in conjunction with VXR Styling Pack One. Deletes auxiliary-in socket (where fitted). ¹² = Only available in conjunction with optional audio units. Deletes auxiliary-in socket (where fitted).



5-door MPV

Model	Price (£)	VAT (£)	Total (£)	On-the-road RRP (£)	CO ₂ * (g/km)
Zafira Design					
1.8i 16v VVT	15397.45	2694.55	18092.00	18940.00	177
1.8i 16v VVT Easytronic	15822.98	2769.02	18592.00	19440.00	172
2.2i 16v Direct	16554.89	2897.11	19452.00	20340.00	197
2.2i 16v Direct auto	17533.62	3068.38	20602.00	21490.00	204
2.0i 16v Turbo (200PS)	17788.94	3113.06	20902.00	21980.00	228
<i>Diesel</i>					
1.9CDTi (120PS)	16495.32	2886.68	19382.00	20205.00	159
1.9CDTi (120PS) auto	17631.49	3085.51	20717.00	21605.00	194
1.9CDTi 16v (150PS)	17452.77	3054.23	20507.00	21330.00	165
1.9CDTi 16v (150PS) auto	18588.94	3253.06	21842.00	22730.00	194
Zafira Elite					
1.8i 16v VVT	16248.51	2843.49	19092.00	19940.00	177
1.8i 16v VVT Easytronic	16674.04	2917.96	19592.00	20440.00	172
2.2i 16v Direct	17405.96	3046.04	20452.00	21340.00	197
2.2i 16v Direct auto	18384.68	3217.32	21602.00	22490.00	204
2.0i 16v Turbo (200PS)	18640.00	3262.00	21902.00	22980.00	228
<i>Diesel</i>					
1.9CDTi (120PS)	17346.38	3035.62	20382.00	21205.00	159
1.9CDTi (120PS) auto	18482.55	3234.45	21717.00	22605.00	194
1.9CDTi 16v (150PS)	18303.83	3203.17	21507.00	22330.00	165
1.9CDTi 16v (150PS) auto	19440.00	3402.00	22842.00	23730.00	194

Accessory highlights

Zafira accessories

	Price (£) exc. VAT	Total (£) inc. VAT
Travel Pack		
• First aid kit • Warning triangle • Hi-visibility vest	21.28	25.00
Protection Pack		
• Velour mats (four) • Mudflaps (four) • Cargo liner	135.32	159.00

For further details of accessories and styling products see pages 54-57.

Model	Price (£)	VAT (£)	Total (£)	On-the-road RRP (£)	CO ₂ * (g/km)
Zafira SRI					
1.8i 16v VVT	15567.66	2724.34	18292.00	19140.00	177
2.2i 16v Direct	16171.91	2830.09	19002.00	19890.00	197
2.2i 16v Direct auto	17150.64	3001.36	20152.00	21040.00	204
2.0i 16v Turbo (200PS)	17405.96	3046.04	20452.00	21530.00	228
<i>Diesel</i>					
1.9CDTi (120PS)	16665.53	2916.47	19582.00	20405.00	159
1.9CDTi (120PS) auto	17801.70	3115.30	20917.00	21805.00	194
1.9CDTi 16v (150PS)	17069.79	2987.21	20057.00	20880.00	165
1.9CDTi 16v (150PS) auto	18205.96	3186.04	21392.00	22280.00	194
Zafira SRI with Exterior Pack**					
1.8i 16v VVT	16248.51	2843.49	19092.00	19940.00	177
2.2i 16v Direct	16852.77	2949.23	19802.00	20690.00	197
2.2i 16v Direct auto	17831.49	3120.51	20952.00	21840.00	204
2.0i 16v Turbo (200PS)	18086.81	3165.19	21252.00	22330.00	228
<i>Diesel</i>					
1.9CDTi (120PS)	17346.38	3035.62	20382.00	21205.00	159
1.9CDTi (120PS) auto	18482.55	3234.45	21717.00	22605.00	194
1.9CDTi 16v (150PS)	17750.64	3106.36	20857.00	21680.00	165
1.9CDTi 16v (150PS) auto	18886.81	3305.19	22192.00	23080.00	194

Please note: On-the-road recommended retail prices (RRP) include number plates and delivery to retailer of £623.00 (inc. £92.79 VAT), 12 months' Vehicle Excise Duty (see page 2) and new vehicle first registration fee of £55.00. Excludes fuel and insurance.

* = CO₂ emission figures. Vehicle Excise Duty is based on CO₂ emissions (see page 2 for details).

For benefit in kind taxation charges see page 2.

** = Exterior Pack comprises 18-inch five-spoke alloy wheels and VXR Styling Pack One (see page 27 for details).



See page 42
for VXR model



See pages
54-57 for
accessory and
styling products



See page 46
for fuel data



See page 59
for MasterFit
Service Plan
details

Option availability

	Design	Elite	SRI	Price (£) exc. VAT	Total (£) inc. VAT
Option packs					
VXR Styling Pack One • Body-colour lower front spoiler/rear lower skirt/rear roof spoiler and side sills	○	○	○ ¹	680.85	800.00
Leather Pack ² • Leather seat facings • Electrically heated sports front seats with tilt and lumbar adjustment • Driver's armrest • Front passenger's seat height adjuster		●	○	936.17	1100.00
Seat Comfort Pack Two ² • Front passenger's seat with height, tilt and lumbar adjustment	○	●	○	85.11	100.00
Panoramic Roof Pack ³ • Four glass roof panels • Roof-mounted storage console for front and rear passengers • Alloy-effect roof rails • Heat-reflective windscreen	○ ⁴	○ ⁴	○	723.40	850.00
Towing Pack ⁴ • Trailer stability programme • Hill Start Assist (HSA) ⁵ 1 see page 53 • Deflation Detection System (DDS) ⁵ • Cruise control • Detachable tow bar	○ ⁶	○ ⁶	○ ⁶	297.87	350.00
FlexOrganiser® Organiser Pack • 3D storage net • Side net pocket • Four side rail hooks • Four side rails	○	○	○	42.55	50.00
Safety and security options					
Electronic Stability Programme-plus (ESP-plus) (1.8i 16v/1.9CDTi (120PS) only) 1 see page 53	○ ⁷	○ ⁷	●	361.70	425.00
Keyless entry and start 1 see page 51	○	○	○	255.32	300.00
Remote control ultrasonic security alarm system	○	○	●	191.49	225.00
Interior options					
Electronic Climate Control (ECC) 1 see page 52		●	○	234.04	275.00
Cruise control	○	●	○	170.21	200.00
Vertical load-restraining net		○	○	127.66	150.00
Mechanical option					
Interactive Driving System-plus (IDS-plus) with Continuous Damping Control (CDC) 1 see page 53			○	340.43	400.00
Exterior and convenience options					
Electrically foldable door mirrors	○	○	○	127.66	150.00
Adaptive Forward Lighting (AFL) incorporating bi-xenon headlights with dynamic beam levelling and high-pressure washers 1 see page 52	○	○	○	638.30	750.00
18-inch five-spoke alloy wheels with 225/40 R 18 ultra-low profile tyres (different style to optional SRI alloy wheels)	○ ^{8,9}			255.32	300.00
18-inch five-spoke alloy wheels with 225/40 R 18 ultra-low profile tyres			○ ^{1,8}	255.32	300.00
Full-size steel spare wheel (in lieu of emergency tyre inflation kit) ¹⁰	○	○	○	85.11	100.00
Front and rear parking distance sensors 1 see page 51	○	○	○	297.87	350.00
Two-coat metallic or pearlescent paint	○	○	○	319.15	375.00
Audio and communication options					
CD 30 MP3 • CD player with MP3 format • Stereo radio • Auxiliary-in socket 1 see page 51	○	●	○	63.83	75.00
CDC 40 • Integral six-disc CD autochanger with MP3 format • Stereo radio • Graphic display	○ ¹¹	○ ¹¹	○	340.43	400.00
CDC 40 DAB • Integral six-disc CD autochanger with MP3 format • Stereo radio with Digital Audio Broadcast (DAB) • Graphic display	○ ¹²	○ ¹²		382.98	450.00
CD 70 • Satellite navigation system • CD player with MP3 format • Stereo radio • Auxiliary-in socket • Colour monitor 1 see page 50	○	○	○	1063.83	1250.00
Rear seat Twin Audio® system with single headset ¹³ 1 see page 50	○	○	○	85.11	100.00
Mobile phone system with Bluetooth® (does not include phone or cradle) – see page 57 for details of mobile phone compatibility 1 see page 50	○	○	○	255.32	300.00

○ = Optional at extra cost. ● = Standard equipment.

1 = Standard on SRI with Exterior Pack models. **2** = Deletes front passenger's underseat storage tray. **3** = Deletes sunglasses holder. Not available on 1.9CDTi 16v (150PS) automatic SRI with Exterior Pack models. **4** = Only available in conjunction with Electronic Stability Programme-plus. **5** = Not available on models fitted with automatic transmission. **6** = Requires 13-pin adaptor (available as a Vauxhall accessory). **7** = Standard on 2.2i 16v Direct, 2.0i 16v Turbo and 1.9CDTi 16v (150PS) models. **8** = Not available on 1.9CDTi 16v (150PS) automatic model with Panoramic Roof Pack. **9** = Not available on 1.8i 16v VVT and 1.9CDTi (120PS) models. **10** = Not available on 2.0i 16v Turbo models, SRI with Exterior Pack models and 18-inch alloy wheels. **11** = Only available in conjunction with VXR Styling Pack One. Deletes auxiliary-in socket (where fitted). **12** = Not available in conjunction with VXR Styling Pack One. Deletes auxiliary-in socket (where fitted). **13** = Only available in conjunction with optional audio units. Deletes auxiliary-in socket (where fitted).

5-door hatchback

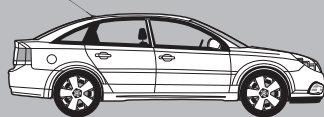

Model	Price (£)	VAT (£)	Total (£)	On-the-road RRP (£)	CO ₂ * (g/km)
Vectra Life					
1.8i 16v VVT	13891.06	2430.94	16322.00	17170.00	173
<i>Diesel</i>					
1.9CDTi (120PS)	15188.94	2658.06	17847.00	18670.00	154
1.9CDTi 16v (150PS)	15614.47	2732.53	18347.00	19170.00	154
1.9CDTi 16v (150PS) auto	17018.72	2978.28	19997.00	20885.00	186
Vectra Life Nav**					
1.8i 16v VVT	14529.36	2542.64	17072.00	17920.00	173
<i>Diesel</i>					
1.9CDTi (120PS)	15827.23	2769.77	18597.00	19420.00	154
1.9CDTi 16v (150PS)	16252.77	2844.23	19097.00	19920.00	154
1.9CDTi 16v (150PS) auto	17657.02	3089.98	20747.00	21635.00	186
Vectra Exclusiv					
1.8i 16v VVT	12827.23	2244.77	15072.00	15920.00	173
<i>Diesel</i>					
1.9CDTi (120PS)	13699.57	2397.43	16097.00	16920.00	154
1.9CDTi 16v (150PS)	14125.11	2471.89	16597.00	17420.00	154
1.9CDTi 16v (150PS) auto	15529.36	2717.64	18247.00	19135.00	186
Vectra Exclusiv Nav**					
1.8i 16v VVT	13465.53	2356.47	15822.00	16670.00	173
<i>Diesel</i>					
1.9CDTi (120PS)	14337.87	2509.13	16847.00	17670.00	154
1.9CDTi 16v (150PS)	14763.40	2583.60	17347.00	18170.00	154
1.9CDTi 16v (150PS) auto	16167.66	2829.34	18997.00	19885.00	186

Accessory highlights

Vectra accessories

	Price (£) exc. VAT	Total (£) inc. VAT
Travel Pack • First aid kit • Warning triangle • Hi-visibility vest	21.28	25.00
Protection Pack • Velour mats (four) • Mudflaps (four) • Cargo liner	135.32	159.00

For further details of accessories and styling products see pages 54-57.

Model	Price (£)	VAT (£)	Total (£)	On-the-road RRP (£)	CO ₂ * (g/km)
Vectra Design					
1.8i 16v VVT	15422.98	2699.02	18122.00	18970.00	173
2.2i 16v Direct	15933.62	2788.38	18722.00	19570.00	180
2.2i 16v Direct auto	17040.00	2982.00	20022.00	20910.00	192
<i>Diesel</i>					
1.9CDTi (120PS)	16720.85	2926.15	19647.00	20470.00	154
1.9CDTi 16v (150PS)	17146.38	3000.62	20147.00	20970.00	154
1.9CDTi 16v (150PS) auto	18550.64	3246.36	21797.00	22685.00	186
Vectra Design Nav†					
1.8i 16v VVT	16061.28	2810.72	18872.00	19720.00	173
2.2i 16v Direct	16571.91	2900.09	19472.00	20320.00	180
2.2i 16v Direct auto	17678.30	3093.70	20772.00	21660.00	192
<i>Diesel</i>					
1.9CDTi (120PS)	17359.15	3037.85	20397.00	21220.00	154
1.9CDTi 16v (150PS)	17784.68	3112.32	20897.00	21720.00	154
1.9CDTi 16v (150PS) auto	19188.94	3358.06	22547.00	23435.00	186
Vectra Elite Nav†					
2.2i 16v Direct	17967.66	3144.34	21112.00	21960.00	180
2.2i 16v Direct auto	19074.04	3337.96	22412.00	23300.00	192
2.8i V6 24v Turbo auto	20818.72	3643.28	24462.00	25540.00	262
<i>Diesel</i>					
1.9CDTi 16v (150PS)	19159.15	3352.85	22512.00	23335.00	154
1.9CDTi 16v (150PS) auto	20563.40	3598.60	24162.00	25050.00	186
3.0CDTi V6 24v	21712.34	3799.66	25512.00	26400.00	186
3.0CDTi V6 24v auto	22818.72	3993.28	26812.00	27700.00	192

Please note: On-the-road recommended retail prices (RRP) include number plates and delivery to retailer of £623.00 (inc. £92.79 VAT), 12 months' Vehicle Excise Duty (see page 2) and new vehicle first registration fee of £55.00. Excludes fuel and insurance.

* = CO₂ emission figures. Vehicle Excise Duty is based on CO₂ emissions (see page 2 for details).

For benefit in kind taxation charges see page 2.

** = Fitted with satellite navigation with monochromatic display/CD player with MP3 format/auxiliary-in socket/stereo radio (CD 70).

† = Fitted with satellite navigation with colour monitor/CD player with MP3 format/auxiliary-in socket/stereo radio (CD 70).



See page 43 for VXR model



See page 46 for fuel data



See page 59 for MasterFit Service Plan details

Option availability

Option packs

Plus Pack • 17-inch alloy wheels (steel space-saver spare) with 215/50 R 17 tyres • Integral six-disc CD autochanger with MP3 format/stereo radio with Digital Audio Broadcast (DAB)/graphic display (CDC 40) • Front fog lights

Plus Pack¹ • 18-inch alloy wheels (steel space-saver spare) with 225/45 R 18 tyres • Electrically operated slide/tilt glass sunroof with multi-position pre-select facility

VXR Styling Pack One • Body-colour front lower spoiler/side sills/rear lower skirt and rear spoiler • Visible stainless steel exhaust tailpipe

Safety option

Electronic Stability Programme-plus (ESP-plus) incorporating traction control (standard on V6 models) **i** see page 53

Mechanical options

Interactive Driving System-plus (IDS-plus) with Continuous Damping Control (CDC) and Sport switch (V6 models only) **i** see page 53

Interactive Driving System-plus (IDS-plus) with Continuous Damping Control (CDC) and Sport switch incorporating Electronic Stability Programme-plus (ESP-plus) with traction control (not available on 1.8i 16v VVT, 1.9CDTi (120PS) or V6 models) **i** see page 53

Exterior and convenience options

Electrically operated slide/tilt glass sunroof with multi-position pre-select facility²

16-inch alloy wheels (steel space-saver spare)

17-inch seven-spoke alloy wheels (steel space-saver spare)

18-inch 11-spoke alloy wheels (steel space-saver spare)³

18-inch multi-spoke alloy wheels (steel space-saver spare)³

Adaptive Forward Lighting (AFL) incorporating bi-xenon headlights with high-pressure headlight washers **i** see page 52

Front and rear parking distance sensors **i** see page 51

Two-coat metallic or pearlescent paint

Audio and communication options

CDC 40 DAB • Integral six-disc CD autochanger with MP3 format • Stereo radio with Digital Audio Broadcast (DAB) • Graphic display

Colour monitor in lieu of monochromatic display on CD 70

Mobile phone system with Bluetooth® (does not include phone or cradle)⁵
– see page 57 for details of mobile phone compatibility **i** see page 50

	Life	Life Nav	Exclusiv	Exclusiv Nav	Design	Design Nav	Elite Nav	Price (£) exc. VAT	Total (£) inc. VAT
Plus Pack			○					553.19	650.00
Plus Pack ¹							○	638.30	750.00
VXR Styling Pack One			○	○	○	○	○	680.85	800.00
Electronic Stability Programme-plus (ESP-plus) incorporating traction control (standard on V6 models) i see page 53	○	○	○	○	○	○	○	340.43	400.00
Interactive Driving System-plus (IDS-plus) with Continuous Damping Control (CDC) and Sport switch (V6 models only) i see page 53							○	425.53	500.00
Interactive Driving System-plus (IDS-plus) with Continuous Damping Control (CDC) and Sport switch incorporating Electronic Stability Programme-plus (ESP-plus) with traction control (not available on 1.8i 16v VVT, 1.9CDTi (120PS) or V6 models) i see page 53			○	○	○	○	○	765.96	900.00
Electrically operated slide/tilt glass sunroof with multi-position pre-select facility ²			○	○	○	○	○	510.64	600.00
16-inch alloy wheels (steel space-saver spare)	○	○			●	●		255.32	300.00
17-inch seven-spoke alloy wheels (steel space-saver spare)			○	○	○	○		255.32	300.00
18-inch 11-spoke alloy wheels (steel space-saver spare) ³					○	○		340.43	400.00
18-inch multi-spoke alloy wheels (steel space-saver spare) ³							○	255.32	300.00
Adaptive Forward Lighting (AFL) incorporating bi-xenon headlights with high-pressure headlight washers i see page 52			○	○	○	○	○	723.40	850.00
Front and rear parking distance sensors i see page 51			○	○	○	○	○	361.70	425.00
Two-coat metallic or pearlescent paint	○	○	○	○	○	○	○	319.15	375.00
CDC 40 DAB • Integral six-disc CD autochanger with MP3 format • Stereo radio with Digital Audio Broadcast (DAB) • Graphic display	○		○		●		N/C ⁴	382.98	450.00
Colour monitor in lieu of monochromatic display on CD 70		○		○		●	●	212.77	250.00
Mobile phone system with Bluetooth® (does not include phone or cradle) ⁵ – see page 57 for details of mobile phone compatibility i see page 50	○	○	○	○	○	○	○	255.32	300.00

○ = Optional at extra cost. ● = Standard equipment. N/C = No-cost option.

1 = Includes sports suspension. Sunroof deletes storage pocket between sunvisors. **2** = Deletes storage pocket between sunvisors. **3** = Includes sports suspension. **4** = Fitted in lieu of CD 70 audio system. Deletes the satellite navigation function and auxiliary-in socket. **5** = Deletes drinks holders in centre console.

5-door hatchback

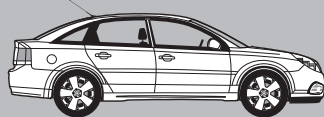

Model	Price (£)	VAT (£)	Total (£)	On-the-road RRP (£)	CO ₂ * (g/km)
Vectra SRi					
1.8i 16v VVT	14827.23	2594.77	17422.00	18270.00	173
2.2i 16v Direct	15337.87	2684.13	18022.00	18870.00	180
2.2i 16v Direct auto	16444.26	2877.74	19322.00	20210.00	192
2.0i 16v Turbo	15678.30	2743.70	18422.00	19310.00	206
<i>Diesel</i>					
1.9CDTi (120PS)	16125.11	2821.89	18947.00	19770.00	154
1.9CDTi 16v (150PS)	16550.64	2896.36	19447.00	20270.00	154
1.9CDTi 16v (150PS) auto	17954.89	3142.11	21097.00	21985.00	186
3.0CDTi V6 24v	19103.83	3343.17	22447.00	23335.00	186
3.0CDTi V6 24v auto	20210.21	3536.79	23747.00	24635.00	192

Please note: On-the-road recommended retail prices (RRP) include number plates and delivery to retailer of £623.00 (inc. £92.79 VAT), 12 months' Vehicle Excise Duty (see page 2) and new vehicle first registration fee of £55.00. Excludes fuel and insurance.

* = CO₂ emission figures. Vehicle Excise Duty is based on CO₂ emissions (see page 2 for details). For benefit in kind taxation charges see page 2.

** = Fitted with satellite navigation with colour monitor/CD player with MP3 format/auxiliary-in socket/stereo radio (CD 70).

† = Exterior Pack comprises 18-inch multi-spoke alloy wheels, body-colour sports front bumper/air dam/side sills/rear lower skirt/rear spoiler, VXR-style leather-covered sports steering wheel and VXR-style leather-covered gear knob (excluding 1.8i 16v VVT and auto models).



See page 43 for VXR model



See pages 54-57 for accessory and styling products



See page 46 for fuel data



See page 59 for MasterFit Service Plan details

Model	Price (£)	VAT (£)	Total (£)	On-the-road RRP (£)	CO ₂ * (g/km)
Vectra SRi Nav**					
1.8i 16v VVT	15499.57	2712.43	18212.00	19060.00	173
2.2i 16v Direct	16010.21	2801.79	18812.00	19660.00	180
2.2i 16v Direct auto	17116.60	2995.40	20112.00	21000.00	192
2.0i 16v Turbo	16350.64	2861.36	19212.00	20100.00	206
<i>Diesel</i>					
1.9CDTi (120PS)	16797.45	2939.55	19737.00	20560.00	154
1.9CDTi 16v (150PS)	17222.98	3014.02	20237.00	21060.00	154
1.9CDTi 16v (150PS) auto	18627.23	3259.77	21887.00	22775.00	186
3.0CDTi V6 24v	19776.17	3460.83	23237.00	24125.00	186
3.0CDTi V6 24v auto	20882.55	3654.45	24537.00	25425.00	192
Vectra SRi Nav** with Exterior Pack†					
1.8i 16v VVT	16274.04	2847.96	19122.00	19970.00	173
2.2i 16v Direct	16784.68	2937.32	19722.00	20570.00	180
2.2i 16v Direct auto	17891.06	3130.94	21022.00	21910.00	192
2.0i 16v Turbo	17125.11	2996.89	20122.00	21010.00	206
<i>Diesel</i>					
1.9CDTi (120PS)	17571.91	3075.09	20647.00	21470.00	154
1.9CDTi 16v (150PS)	17997.45	3149.55	21147.00	21970.00	154
1.9CDTi 16v (150PS) auto	19401.70	3395.30	22797.00	23685.00	186
3.0CDTi V6 24v	20550.64	3596.36	24147.00	25035.00	186
3.0CDTi V6 24v auto	21657.02	3789.98	25447.00	26335.00	192

Accessory highlights

	Price (£) exc. VAT	Total (£) inc. VAT
Vectra accessories		
Travel Pack		
• First aid kit • Warning triangle • Hi-visibility vest	21.28	25.00
Protection Pack		
• Velour mats (four) • Mudflaps (four) • Cargo liner	135.32	159.00

For further details of accessories and styling products see pages 54-57.

Option availability

	SRI	SRI Nav	SRI Nav XP	Price (£) exc. VAT	Total (£) inc. VAT
Option packs					
Plus Pack ¹ • 19-inch alloy wheels (steel space-saver spare) with 235/35 R 19 tyres • Integral six-disc CD autochanger with MP3 format/stereo radio with Digital Audio Broadcast (DAB)/graphic display (CDC 40)	○			676.60	795.00
VXR Styling Pack One • Body-colour front lower spoiler/side sills/rear lower skirt and rear spoiler	○	○		680.85	800.00
Safety option					
Electronic Stability Programme-plus (ESP-plus) incorporating traction control (standard on V6 models) 1 see page 53	○	○	○	340.43	400.00
Mechanical options					
Interactive Driving System-plus (IDS-plus) with Continuous Damping Control (CDC) and Sport switch (V6 models only) 1 see page 53	○	○	○	425.53	500.00
Interactive Driving System-plus (IDS-plus) with Continuous Damping Control (CDC) and Sport switch incorporating Electronic Stability Programme-plus (ESP-plus) with traction control (not available on 1.8i 16v VVT, 1.9CDTi (120PS) or V6 models) 1 see page 53	○	○	○	765.96	900.00
Exterior and convenience options					
Electrically operated slide/tilt glass sunroof with multi-position pre-select facility ²	○	○	○	510.64	600.00
19-inch five-spoke alloy wheels (steel space-saver spare) ¹	○	○	○	340.43	400.00
Adaptive Forward Lighting (AFL) incorporating bi-xenon headlights with high-pressure headlight washers 1 see page 52	○	○	○	723.40	850.00
Front and rear parking distance sensors 1 see page 51	○	○	○	361.70	425.00
Two-coat metallic or pearlescent paint	○	○	○	319.15	375.00
Audio and communication options					
CDC 40 DAB • Integral six-disc CD autochanger with MP3 format • Stereo radio with Digital Audio Broadcast (DAB) • Graphic display	○			382.98	450.00
Mobile phone system with Bluetooth® (does not include phone or cradle) ³ – see page 57 for details of mobile phone compatibility 1 see page 50	○	○	○	255.32	300.00

○ = Optional at extra cost. XP = Models with Exterior Pack

¹ = Not available on 3.0CDTi V6 24v models. Due to increased CO₂ emissions, on certain engines there will be a slight increase in benefit in kind charges for company car drivers. CO₂ emissions figures: 1.8i 16v VVT (hatch) – 175g/km; 1.9CDTi (120PS) (hatch) – 157g/km; 1.9CDTi 16v (150PS) (manual hatch) – 157g/km. ² = Deletes storage pocket between sunvisors. ³ = Deletes drinks holders in centre console.

5-door estate

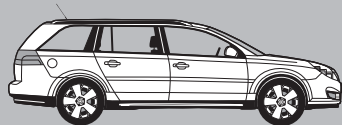

Model	Price (£)	VAT (£)	Total (£)	On-the-road RRP (£)	CO ₂ * (g/km)
Vectra Life					
1.8i 16v VVT	14827.23	2594.77	17422.00	18270.00	180
<i>Diesel</i>					
1.9CDTi (120PS)	16422.98	2874.02	19297.00	20120.00	157
1.9CDTi 16v (150PS)	16848.51	2948.49	19797.00	20620.00	157
1.9CDTi 16v (150PS) auto	17954.89	3142.11	21097.00	21985.00	189
Vectra Life Nav**					
1.8i 16v VVT	15465.53	2706.47	18172.00	19020.00	180
<i>Diesel</i>					
1.9CDTi (120PS)	17061.28	2985.72	20047.00	20870.00	157
1.9CDTi 16v (150PS)	17486.81	3060.19	20547.00	21370.00	157
1.9CDTi 16v (150PS) auto	18593.19	3253.81	21847.00	22735.00	189
Vectra Exclusiv					
1.8i 16v VVT	13763.40	2408.60	16172.00	17020.00	180
<i>Diesel</i>					
1.9CDTi (120PS)	14933.62	2613.38	17547.00	18370.00	157
1.9CDTi 16v (150PS)	15359.15	2687.85	18047.00	18870.00	157
1.9CDTi 16v (150PS) auto	16465.53	2881.47	19347.00	20235.00	189
Vectra Exclusiv Nav**					
1.8i 16v VVT	14401.70	2520.30	16922.00	17770.00	180
<i>Diesel</i>					
1.9CDTi (120PS)	15571.91	2725.09	18297.00	19120.00	157
1.9CDTi 16v (150PS)	15997.45	2799.55	18797.00	19620.00	157
1.9CDTi 16v (150PS) auto	17103.83	2993.17	20097.00	20985.00	189

Accessory highlights

Vectra accessories

	Price (£) exc. VAT	Total (£) inc. VAT
Travel Pack • First aid kit • Warning triangle • Hi-visibility vest	21.28	25.00
Protection Pack • Velour mats (four) • Mudflaps (four) • Cargo liner	135.32	159.00

For further details of accessories and styling products see pages 54-57.

Model	Price (£)	VAT (£)	Total (£)	On-the-road RRP (£)	CO ₂ * (g/km)
Vectra Design					
1.8i 16v VVT	16359.15	2862.85	19222.00	20070.00	180
2.2i 16v Direct	16869.79	2952.21	19822.00	20710.00	187
2.2i 16v Direct auto	17976.17	3145.83	21122.00	22010.00	197
<i>Diesel</i>					
1.9CDTi (120PS)	17954.89	3142.11	21097.00	21920.00	157
1.9CDTi 16v (150PS)	18380.43	3216.57	21597.00	22420.00	157
1.9CDTi 16v (150PS) auto	19486.81	3410.19	22897.00	23785.00	189
Vectra Design Nav†					
1.8i 16v VVT	16997.45	2974.55	19972.00	20820.00	180
2.2i 16v Direct	17508.09	3063.91	20572.00	21460.00	187
2.2i 16v Direct auto	18614.47	3257.53	21872.00	22760.00	197
<i>Diesel</i>					
1.9CDTi (120PS)	18593.19	3253.81	21847.00	22670.00	157
1.9CDTi 16v (150PS)	19018.72	3328.28	22347.00	23170.00	157
1.9CDTi 16v (150PS) auto	20125.11	3521.89	23647.00	24535.00	189
Vectra Elite Nav†					
2.2i 16v Direct	18903.83	3308.17	22212.00	23100.00	187
2.2i 16v Direct auto	20010.21	3501.79	23512.00	24400.00	197
2.8i V6 24v Turbo auto	21754.89	3807.11	25562.00	26640.00	269
<i>Diesel</i>					
1.9CDTi 16v (150PS)	20393.19	3568.81	23962.00	24785.00	157
1.9CDTi 16v (150PS) auto	21499.57	3762.43	25262.00	26150.00	189
3.0CDTi V6 24v	22648.51	3963.49	26612.00	27500.00	186
3.0CDTi V6 24v auto	23754.89	4157.11	27912.00	28800.00	194

Please note: On-the-road recommended retail prices (RRP) include number plates and delivery to retailer of £623.00 (inc. £92.79 VAT), 12 months' Vehicle Excise Duty (see page 2) and new vehicle first registration fee of £55.00. Excludes fuel and insurance.

* = CO₂ emission figures. Vehicle Excise Duty is based on CO₂ emissions (see page 2 for details).

For benefit in kind taxation charges see page 2.

** = Fitted with satellite navigation with monochromatic display/CD player with MP3 format/auxiliary-in socket/stereo radio (CD 70).

† = Fitted with satellite navigation with colour monitor/CD player with MP3 format/auxiliary-in socket/stereo radio (CD 70).



See page 43 for VXR model



See pages 46-47 for fuel data



See page 59 for MasterFit Service Plan details

Option availability

	Life	Life Nav	Exclusiv	Exclusiv Nav	Design	Design Nav	Elite Nav	Price (£) exc. VAT	Total (£) inc. VAT
Option packs									
Plus Pack • 17-inch alloy wheels (steel space-saver spare) with 215/50 R 17 tyres • Integral six-disc CD autochanger with MP3 format/stereo radio with Digital Audio Broadcast (DAB)/graphic display (CDC 40) • Front fog lights			○					553.19	650.00
Plus Pack¹ • 18-inch alloy wheels (steel space-saver spare) with 225/45 R 18 tyres • Electrically operated slide/tilt glass sunroof with multi-position pre-select facility							○	638.30	750.00
VXR Styling Pack One • Body-colour front lower spoiler/side sills/rear lower skirt and rear spoiler			○	○	○	○	○	680.85	800.00
Towing Pack • Electronic Stability Programme-plus (ESP-plus) incorporating traction control 1 see page 53 • Trailer stability programme • Automatic self-levelling rear suspension ² • Retractable tow bar ³	○	○	○	○	○	○	○ ⁴	595.74	700.00
FlexOrganiser® Organiser Pack • 3D storage net • Side net pocket • Four side rail hooks	○	○	○	○	○	○	○	42.55	50.00
Safety option									
Electronic Stability Programme-plus (ESP-plus) incorporating traction control (standard on V6 models) 1 see page 53	○	○	○	○	○	○	○	340.43	400.00
Mechanical options									
Interactive Driving System-plus (IDS-plus) with Continuous Damping Control (CDC) and Sport switch (V6 models only) 1 see page 53							○	425.53	500.00
Interactive Driving System-plus (IDS-plus) with Continuous Damping Control (CDC) and Sport switch incorporating Electronic Stability Programme-plus (ESP-plus) with traction control (not available on 1.8i 16v VVT, 1.9CDTi (120PS) or V6 models) 1 see page 53			○	○	○	○	○	765.96	900.00
Interior option									
Vertical load-restraining net ⁵	○	○	○	○	○	○	○	127.66	150.00
Exterior and convenience options									
Electrically operated slide/tilt glass sunroof with multi-position pre-select facility ⁶			○	○	○	○	○	510.64	600.00
16-inch alloy wheels (steel space-saver spare)	○	○			●	●		255.32	300.00
17-inch seven-spoke alloy wheels (steel space-saver spare)			○	○	○	○		255.32	300.00
18-inch 11-spoke alloy wheels (steel space-saver spare) ⁷					○	○		340.43	400.00
18-inch multi-spoke alloy wheels (steel space-saver spare) ⁷							○	255.32	300.00
Adaptive Forward Lighting (AFL) incorporating bi-xenon headlights with high-pressure headlight washers 1 see page 52			○	○	○	○	○	723.40	850.00
Roof rails ⁸	○	○	○	○	○	○	●	85.11	100.00
Front and rear parking distance sensors 1 see page 51			○	○	○	○	○	361.70	425.00
Two-coat metallic or pearlescent paint	○	○	○	○	○	○	○	319.15	375.00
Audio and communication options									
CDC 40 DAB • Integral six-disc CD autochanger with MP3 format • Stereo radio with Digital Audio Broadcast (DAB) • Graphic display	○		○		●		N/C ⁹	382.98	450.00
Colour monitor in lieu of monochromatic display on CD 70		○		○		●	●	212.77	250.00
Mobile phone system with Bluetooth® (does not include phone or cradle) ¹⁰ – see page 57 for details of mobile phone compatibility 1 see page 50	○	○	○	○	○	○	○	255.32	300.00

○ = Optional at extra cost. ● = Standard equipment. N/C = No-cost option.

1 = Includes sports suspension. Sunroof deletes storage pocket between sunvisors. **2** = Not available on Exclusiv, Exclusiv Nav, Design, Design Nav or Elite Nav models with optional IDS-plus or 18-inch alloy wheels. **3** = Please note: a separate electrical adaptor (13-pin to 7-pin) is required – available as an accessory at extra cost. This adaptor does not allow for supplementary trailer power requirements. **4** = ESP-plus incorporating traction control is standard on 2.8i V6 24v Turbo/3.0CDTi V6 24v models. **5** = Includes fixing points for accessory dog guard. **6** = Deletes storage pocket between sunvisors. **7** = Includes sports suspension. **8** = Must be used with separate base carrier (available as a Vauxhall accessory) if luggage is to be carried on the roof. **9** = Fitted in lieu of CD 70 audio system. Deletes the satellite navigation function and auxiliary-in socket. **10** = Deletes drinks holders in centre console.

5-door estate

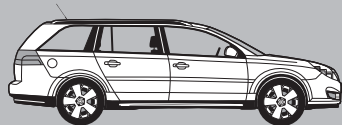

Model	Price (£)	VAT (£)	Total (£)	On-the-road RRP (£)	CO ₂ * (g/km)
Vectra SRi					
1.8i 16v VVT	15763.40	2758.60	18522.00	19370.00	180
2.2i 16v Direct	16274.04	2847.96	19122.00	20010.00	187
2.2i 16v Direct auto	17380.43	3041.57	20422.00	21310.00	197
2.0i 16v Turbo	16614.47	2907.53	19522.00	20410.00	211
<i>Diesel</i>					
1.9CDTi (120PS)	17359.15	3037.85	20397.00	21220.00	157
1.9CDTi 16v (150PS)	17784.68	3112.32	20897.00	21720.00	157
1.9CDTi 16v (150PS) auto	18891.06	3305.94	22197.00	23085.00	189
3.0CDTi V6 24v	20040.00	3507.00	23547.00	24435.00	186
3.0CDTi V6 24v auto	21146.38	3700.62	24847.00	25735.00	194

Please note: On-the-road recommended retail prices (RRP) include number plates and delivery to retailer of £623.00 (inc. £92.79 VAT), 12 months' Vehicle Excise Duty (see page 2) and new vehicle first registration fee of £55.00. Excludes fuel and insurance.

* = CO₂ emission figures. Vehicle Excise Duty is based on CO₂ emissions (see page 2 for details). For benefit in kind taxation charges see page 2.

** = Fitted with satellite navigation with colour monitor/CD player with MP3 format/auxiliary-in socket/stereo radio (CD 70).

† = Exterior Pack comprises 18-inch multi-spoke alloy wheels, body-colour sports front bumper/air dam/side sills/rear lower skirt/rear spoiler, VXR-style leather-covered sports steering wheel and VXR-style leather-covered gear knob (excluding 1.8i 16v VVT and auto models).



See page 43 for VXR model



See pages 54-57 for accessory and styling products



See pages 46-47 for fuel data



See page 59 for MasterFit Service Plan details

Model	Price (£)	VAT (£)	Total (£)	On-the-road RRP (£)	CO ₂ * (g/km)
Vectra SRi Nav**					
1.8i 16v VVT	16435.74	2876.26	19312.00	20160.00	180
2.2i 16v Direct	16946.38	2965.62	19912.00	20800.00	187
2.2i 16v Direct auto	18052.77	3159.23	21212.00	22100.00	197
2.0i 16v Turbo	17286.81	3025.19	20312.00	21200.00	211
<i>Diesel</i>					
1.9CDTi (120PS)	18031.49	3155.51	21187.00	22010.00	157
1.9CDTi 16v (150PS)	18457.02	3229.98	21687.00	22510.00	157
1.9CDTi 16v (150PS) auto	19563.40	3423.60	22987.00	23875.00	189
3.0CDTi V6 24v	20712.34	3624.66	24337.00	25225.00	186
3.0CDTi V6 24v auto	21818.72	3818.28	25637.00	26525.00	194
Vectra SRi Nav** with Exterior Pack†					
1.8i 16v VVT	17210.21	3011.79	20222.00	21070.00	180
2.2i 16v Direct	17720.85	3101.15	20822.00	21710.00	187
2.2i 16v Direct auto	18827.23	3294.77	22122.00	23010.00	197
2.0i 16v Turbo	18061.28	3160.72	21222.00	22110.00	211
<i>Diesel</i>					
1.9CDTi (120PS)	18805.96	3291.04	22097.00	22920.00	157
1.9CDTi 16v (150PS)	19231.49	3365.51	22597.00	23420.00	157
1.9CDTi 16v (150PS) auto	20337.87	3559.13	23897.00	24785.00	189
3.0CDTi V6 24v	21486.81	3760.19	25247.00	26135.00	186
3.0CDTi V6 24v auto	22593.19	3953.81	26547.00	27435.00	194

Accessory highlights

	Price (£) exc. VAT	Total (£) inc. VAT
Vectra accessories		
Travel Pack		
• First aid kit • Warning triangle • Hi-visibility vest	21.28	25.00
Protection Pack		
• Velour mats (four) • Mudflaps (four) • Cargo liner	135.32	159.00

For further details of accessories and styling products see pages 54-57.

Option availability

	SRI	SRI Nav	SRI Nav XP	Price (£) exc. VAT	Total (£) inc. VAT
Option packs					
Plus Pack ¹ • 19-inch alloy wheels (steel space-saver spare) with 235/35 R 19 tyres • Integral six-disc CD autochanger with MP3 format/stereo radio with Digital Audio Broadcast (DAB)/graphic display (CDC 40)	○			676.60	795.00
VXR Styling Pack One • Body-colour front lower spoiler/side sills/rear lower skirt and rear spoiler	○	○		680.85	800.00
Towing Pack • Electronic Stability Programme-plus (ESP-plus) incorporating traction control ² ⓘ see page 53 • Trailer stability programme • Retractable tow bar ³	○	○	○	595.74	700.00
FlexOrganiser® Organiser Pack • 3D storage net • Side net pocket • Four side rail hooks	○	○	○	42.55	50.00
Safety option					
Electronic Stability Programme-plus (ESP-plus) incorporating traction control (standard on V6 models) ⓘ see page 53	○	○	○	340.43	400.00
Mechanical options					
Interactive Driving System-plus (IDS-plus) with Continuous Damping Control (CDC) and Sport switch (V6 models only) ⓘ see page 53	○	○	○	425.53	500.00
Interactive Driving System-plus (IDS-plus) with Continuous Damping Control (CDC) and Sport switch incorporating Electronic Stability Programme-plus (ESP-plus) with traction control (not available on 1.8i 16v VVT, 1.9CDTi (120PS) or V6 models) ⓘ see page 53	○	○	○	765.96	900.00
Interior option					
Vertical load-restraining net ⁴	○	○	○	127.66	150.00
Exterior and convenience options					
Electrically operated slide/tilt glass sunroof with multi-position pre-select facility ⁵	○	○	○	510.64	600.00
19-inch five-spoke alloy wheels (steel space-saver spare) ¹	○	○	○	340.43	400.00
Adaptive Forward Lighting (AFL) incorporating bi-xenon headlights with high-pressure headlight washers ⓘ see page 52	○	○	○	723.40	850.00
Roof rails ⁶	○	○	○	85.11	100.00
Front and rear parking distance sensors ⓘ see page 51	○	○	○	361.70	425.00
Two-coat metallic or pearlescent paint	○	○	○	319.15	375.00
Audio and communication options					
CDC 40 DAB • Integral six-disc CD autochanger with MP3 format • Stereo radio with Digital Audio Broadcast (DAB) • Graphic display	○			382.98	450.00
Mobile phone system with Bluetooth® (does not include phone or cradle) ³ – see page 57 for details of mobile phone compatibility ⓘ see page 50	○	○	○	255.32	300.00

○ = Optional at extra cost. XP = Models with Exterior Pack

¹ = Not available on 3.0CDTi V6 24v models. Due to increased CO₂ emissions, on certain engines there will be a slight increase in benefit in kind charges for company car drivers. CO₂ emissions figures: 2.2i 16v Direct (manual estate) – 190g/km; 1.9CDTi 16v (150PS) (automatic estate) – 192g/km. ² = ESP-plus incorporating traction control is standard on 3.0CDTi V6 24v models. ³ = Please note: a separate electrical adaptor (13-pin to 7-pin) is required – available as an accessory at extra cost. This adaptor does not allow for supplementary trailer power requirements. ⁴ = Includes fixing points for accessory dog guard. ⁵ = Deletes storage pocket between sunvisors. ⁶ = Must be used with separate base carrier (available as a Vauxhall accessory) if luggage is to be carried on the roof. ⁷ = Deletes drinks holders in centre console.



Model	Price (£)	VAT (£)	Total (£)	On-the-road RRP (£)	CO ₂ * (g/km)
Vectra Life					
1.8i 16v VVT	13891.06	2430.94	16322.00	17170.00	173
<i>Diesel</i>					
1.9CDTi (120PS)	15188.94	2658.06	17847.00	18670.00	154
1.9CDTi 16v (150PS)	15614.47	2732.53	18347.00	19170.00	154
1.9CDTi 16v (150PS) auto	17018.72	2978.28	19997.00	20845.00	184
Vectra Life Nav**					
1.8i 16v VVT	14529.36	2542.64	17072.00	17920.00	173
<i>Diesel</i>					
1.9CDTi (120PS)	15827.23	2769.77	18597.00	19420.00	154
1.9CDTi 16v (150PS)	16252.77	2844.23	19097.00	19920.00	154
1.9CDTi 16v (150PS) auto	17657.02	3089.98	20747.00	21595.00	184

Please note: On-the-road recommended retail prices (RRP) include number plates and delivery to retailer of £623.00 (inc. £92.79 VAT), 12 months' Vehicle Excise Duty (see page 2) and new vehicle first registration fee of £55.00. Excludes fuel and insurance.

* = CO₂ emission figures. Vehicle Excise Duty is based on CO₂ emissions (see page 2 for details).

For benefit in kind taxation charges see page 2.

** = Fitted with satellite navigation with monochromatic display/CD player with MP3 format/auxiliary-in socket/stereo radio (CD 70).

† = Fitted with satellite navigation with colour monitor/CD player with MP3 format/auxiliary-in socket/stereo radio (CD 70).

Model	Price (£)	VAT (£)	Total (£)	On-the-road RRP (£)	CO ₂ * (g/km)
Vectra Design					
1.8i 16v VVT	15422.98	2699.02	18122.00	18970.00	173
2.2i 16v Direct	15933.62	2788.38	18722.00	19570.00	180
2.2i 16v Direct auto	17040.00	2982.00	20022.00	20910.00	192
<i>Diesel</i>					
1.9CDTi (120PS)	16720.85	2926.15	19647.00	20470.00	154
1.9CDTi 16v (150PS)	17146.38	3000.62	20147.00	20970.00	154
1.9CDTi 16v (150PS) auto	18550.64	3246.36	21797.00	22645.00	184
Vectra Design Nav†					
1.8i 16v VVT	16061.28	2810.72	18872.00	19720.00	173
2.2i 16v Direct	16571.91	2900.09	19472.00	20320.00	180
2.2i 16v Direct auto	17678.30	3093.70	20772.00	21660.00	192
<i>Diesel</i>					
1.9CDTi (120PS)	17359.15	3037.85	20397.00	21220.00	154
1.9CDTi 16v (150PS)	17784.68	3112.32	20897.00	21720.00	154
1.9CDTi 16v (150PS) auto	19188.94	3358.06	22547.00	23395.00	184

Accessory highlights

	Price (£) exc. VAT	Total (£) inc. VAT
Vectra accessories		
Travel Pack • First aid kit • Warning triangle • Hi-visibility vest	21.28	25.00
Protection Pack • Velour mats (four) • Mudflaps (four) • Cargo liner	135.32	159.00

For further details of accessories and styling products see pages 54-57.



See pages 54-57 for accessory and styling products



See page 46 for fuel data



See page 59 for MasterFit Service Plan details

Option availability

Safety option

Electronic Stability Programme-plus (ESP-plus) incorporating traction control **i** see page 53

Life Life Nav Design Design Nav Price (£) Total (£)
exc. VAT inc. VAT

Mechanical option

Interactive Driving System-plus (IDS-plus) with Continuous Damping Control (CDC) and Sport switch incorporating Electronic Stability Programme-plus (ESP-plus) with traction control (available on 2.2i 16v Direct and 1.9CDTi 16v (150PS) models only) **i** see page 53

Exterior and convenience options

Electrically operated slide/tilt glass sunroof with multi-position pre-select facility¹

16-inch alloy wheels (steel space-saver spare)

17-inch seven-spoke alloy wheels (steel space-saver spare)

18-inch 11-spoke alloy wheels (steel space-saver spare)²

Adaptive Forward Lighting (AFL) incorporating bi-xenon headlights with high-pressure headlight washers **i** see page 52

Front and rear parking distance sensors **i** see page 51

Two-coat metallic or pearlescent paint

Audio and communication options

CDC 40 DAB • Integral six-disc CD autochanger with MP3 format • Stereo radio with Digital Audio Broadcast (DAB) • Graphic display

Colour monitor in lieu of monochromatic display on CD 70

Mobile phone system with Bluetooth® (does not include phone or cradle)³ – see page 57 for details of mobile phone compatibility **i** see page 50

○ = Optional at extra cost. ● = Standard equipment.

1 = Deletes storage pocket between sunvisors. **2** = Includes sports suspension. **3** = Deletes drinks holders in centre console.

	Life	Life Nav	Design	Design Nav	Price (£) exc. VAT	Total (£) inc. VAT
Electronic Stability Programme-plus (ESP-plus) incorporating traction control i see page 53	○	○	○	○	340.43	400.00
Interactive Driving System-plus (IDS-plus) with Continuous Damping Control (CDC) and Sport switch incorporating Electronic Stability Programme-plus (ESP-plus) with traction control (available on 2.2i 16v Direct and 1.9CDTi 16v (150PS) models only) i see page 53			○	○	765.96	900.00
Electrically operated slide/tilt glass sunroof with multi-position pre-select facility ¹			○	○	510.64	600.00
16-inch alloy wheels (steel space-saver spare)	○	○	●	●	255.32	300.00
17-inch seven-spoke alloy wheels (steel space-saver spare)			○	○	255.32	300.00
18-inch 11-spoke alloy wheels (steel space-saver spare) ²			○	○	340.43	400.00
Adaptive Forward Lighting (AFL) incorporating bi-xenon headlights with high-pressure headlight washers i see page 52			○	○	723.40	850.00
Front and rear parking distance sensors i see page 51			○	○	361.70	425.00
Two-coat metallic or pearlescent paint	○	○	○	○	319.15	375.00
CDC 40 DAB • Integral six-disc CD autochanger with MP3 format • Stereo radio with Digital Audio Broadcast (DAB) • Graphic display	○		●		382.98	450.00
Colour monitor in lieu of monochromatic display on CD 70		○		●	212.77	250.00
Mobile phone system with Bluetooth® (does not include phone or cradle) ³ – see page 57 for details of mobile phone compatibility i see page 50	○	○	○	○	255.32	300.00



5-door SUV

Model	Price (£)	VAT (£)	Total (£)	On-the-road RRP (£)	CO ₂ * (g/km)
Antara E					
<i>Diesel</i>					
2.0CDTi 16v	17227.23	3014.77	20242.00	21130.00	198
2.0CDTi 16v auto	18401.70	3220.30	21622.00	22510.00	225
Antara S					
<i>Diesel</i>					
2.0CDTi 16v	18525.11	3241.89	21767.00	22655.00	198
2.0CDTi 16v auto	19699.57	3447.43	23147.00	24035.00	225
Antara SE					
<i>Diesel</i>					
2.0CDTi 16v	21674.04	3792.96	25467.00	26355.00	198
2.0CDTi 16v auto	22848.51	3998.49	26847.00	27735.00	225

Please note: On-the-road recommended retail prices (RRP) include number plates and delivery to retailer of £623.00 (inc. £92.79 VAT), 12 months' Vehicle Excise Duty (see page 2) and new vehicle first registration fee of £55.00. Excludes fuel and insurance.

* = CO₂ emission figure. Vehicle Excise Duty is based on CO₂ emissions (see page 2 for details). For benefit in kind taxation charges see page 2.



See pages 54-57 for accessory and styling products



See page 47 for fuel data



See page 59 for MasterFit Service Plan details

Option availability

Exterior options

	Antara E	Antara S	Antara SE	Price (£) exc. VAT	Total (£) inc. VAT
Front and rear parking distance sensors ¹		○	●	297.87	350.00
Two-coat metallic or pearlescent paint	○	○	○	340.43	400.00

○ = Optional at extra cost. ● = Standard equipment.

¹ = Restricted option availability, please consult your retailer for details.

Accessory highlights

Antara accessories

	Price (£) exc. VAT	Total (£) inc. VAT
Travel Pack ● First aid kit ● Warning triangle ● Hi-visibility vest	21.28	25.00
Protection Pack ● Velour mats (four) ● Mudflaps (four) ● Cargo liner	135.32	159.00

For further details of accessories and styling products see pages 54-57.

3-door hatchback

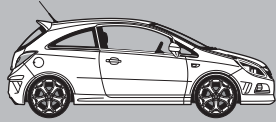

Model	Price (£)	VAT (£)	Total (£)	On-the-road RRP (£)	CO ₂ * (g/km)
Corsa VXR					
1.6i 16v Turbo (192PS)	13031.49	2280.51	15312.00	16200.00	190
Corsa VXR Arctic Edition					
1.6i 16v Turbo (192PS)	13708.09	2398.91	16107.00	16995.00	190

Please note: On-the-road recommended retail prices (RRP) include number plates and delivery to retailer of £623.00 (inc. £92.79 VAT), 12 months' Vehicle Excise Duty (see page 2) and new vehicle first registration fee of £55.00. Excludes fuel and insurance.

* = CO₂ emission figure. Vehicle Excise Duty is based on CO₂ emissions (see page 2 for details). For benefit in kind taxation charges see page 2.



See pages 54-57 for accessory and styling products



See page 47 for fuel data



See page 59 for MasterFit Service Plan details

Option availability

Option packs

	VXR	Arctic	Price (£) exc. VAT	Total (£) inc. VAT
Leather Pack • Leather seat facings • Electrically heated Recaro shell-backed sports front seats	<input type="radio"/>	<input type="radio"/>	851.06	1000.00
Sight and Light Pack • Rain-sensitive windscreen wipers • Electro-chromatic anti-dazzle rear-view mirror • Automatic lighting control	<input type="radio"/>	<input type="radio"/>	170.21	200.00

Interior option

Electronic Climate Control (ECC) incorporating air conditioning 1 see page 52	<input type="radio"/>	<input type="radio"/>	234.04	275.00
--	-----------------------	-----------------------	--------	---------------

Mechanical option

Remus stainless steel 65mm sports exhaust system, incorporating front de-cat downpipe and rear silencer – retailer-fit (excluding fitting) 1 see below for ordering details	<input type="radio"/>	<input checked="" type="radio"/>	361.70	425.00
--	-----------------------	----------------------------------	--------	---------------

Exterior and convenience options

18-inch V-spoke alloy wheels with anthracite inner, 225/35 R 18 ultra-low profile tyres	<input type="radio"/>	<input type="radio"/>	404.26	475.00
Adaptive Forward Lighting (AFL) – halogen 1 see page 52	<input type="radio"/>	<input type="radio"/>	212.77	250.00
Dark-tinted windows (excludes windscreen and front door windows)	<input type="radio"/>	<input checked="" type="radio"/>	212.77	250.00
Rear parking distance sensors 1 see page 51	<input type="radio"/>	<input type="radio"/>	212.77	250.00
Two-coat metallic or pearlescent paint	<input type="radio"/>	<input type="radio"/>	319.15	375.00

Audio and communication options

CDC 40 • Integral six-disc CD autochanger with MP3 format • Stereo radio • Graphic display 1	<input type="radio"/>	<input type="radio"/>	340.43	400.00
CD 60 • Satellite navigation system • CD player with MP3 format • Stereo radio • Auxiliary-in socket • Graphic display	<input type="radio"/>	<input type="radio"/>	829.79	975.00
Mobile phone system with Bluetooth® (does not include phone or cradle) – see page 57 for details of mobile phone compatibility 1 see page 50	<input type="radio"/>	<input type="radio"/>	255.32	300.00

○ = Optional at extra cost. ● = Standard equipment. 1 = Deletes auxiliary-in socket.



Performance Centre

Vauxhall has teamed up with Triple Eight Race Engineering to make genuine VXR-style performance available to every Vauxhall owner. Located at VXRacing's BTCC team headquarters, the new VXR Performance Centre offers proven engine, brake, suspension and body styling upgrades. For more details, visit www.vxrperformance.co.uk, telephone 01295 768880 or contact your local Vauxhall retailer.





5-door MPV

Model	Price (£)	VAT (£)	Total (£)	On-the-road RRP (£)	CO ₂ * (g/km)
Meriva VXR					
1.6i 16v Turbo (180PS)	13793.19	2413.81	16207.00	17095.00	187

Please note: On-the-road recommended retail prices (RRP) include number plates and delivery to retailer of £623.00 (inc. £92.79 VAT), 12 months' Vehicle Excise Duty (see page 2) and new vehicle first registration fee of £55.00. Excludes fuel and insurance.

* = CO₂ emission figure. Vehicle Excise Duty is based on CO₂ emissions (see page 2 for details). For benefit in kind taxation charges see page 2.



See pages 54-57 for accessory and styling products



See page 47 for fuel data



See page 59 for MasterFit Service Plan details

Option availability

	VXR	Price (£) exc. VAT	Total (£) inc. VAT
Option pack			
Leather Pack • Leather seat facings • Electrically heated Recaro sports front seats	○	851.06	1000.00
Exterior and convenience options			
Adaptive Forward Lighting (AFL) – halogen ⓘ see page 52	○	212.77	250.00
Two-coat metallic or pearlescent paint	○	319.15	375.00
Audio and communication options			
CDC 40 • Integral six-disc CD autochanger with MP3 format • Stereo radio • Graphic display ¹	○	382.98	450.00
CD 70 • Satellite navigation system • CD player with MP3 format • Stereo radio • Auxiliary-in socket • Graphic display ⓘ see page 50	○	829.79	975.00
Rear seat Twin Audio® system with single headset ⓘ see page 50	○ ²	85.11	100.00
Mobile phone system with Bluetooth® (does not include phone or cradle) – see page 57 for details of mobile phone compatibility ⓘ see page 50	○	255.32	300.00

○ = Optional at extra cost.

¹ = Deletes auxiliary-in socket. ² = Not available in conjunction with mobile phone system with Bluetooth®. Deletes auxiliary-in socket.

3-door hatchback

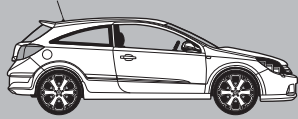

Model	Price (£)	VAT (£)	Total (£)	On-the-road RRP (£)	CO ₂ * (g/km)
Astra VXR					
2.0i 16v Turbo (240PS)	16261.28	2845.72	19107.00	19995.00	221
Astra VXR Nürburgring Edition					
2.0i 16v Turbo (240PS)	17703.83	3098.17	20802.00	21690.00	221

Please note: On-the-road recommended retail prices (RRP) include number plates and delivery to retailer of £623.00 (inc. £92.79 VAT), 12 months' Vehicle Excise Duty (see page 2) and new vehicle first registration fee of £55.00. Excludes fuel and insurance.

* = CO₂ emission figure. Vehicle Excise Duty is based on CO₂ emissions (see page 2 for details). For benefit in kind taxation charges see page 2.



See pages 54-57 for accessory and styling products



See page 47 for fuel data



See page 59 for MasterFit Service Plan details

Option availability

Option packs

	VXR	Nürburgring	Price (£) exc. VAT	Total (£) inc. VAT
Leather Pack • Leather seat facings • Electrically heated Recaro sports front seats • Indirect door night lighting • Centre rear seat head restraint • Front passenger's seat height adjuster	○		851.06	1000.00
Sight and Light Pack • Rain-sensitive windscreen wipers • Electro-chromatic anti-dazzle rear-view mirror • Automatic lighting control	○	○	170.21	200.00

Interior options

Electronic Climate Control (ECC) incorporating air conditioning 1 see page 52	○	○	234.04	275.00
Cruise control	○	○	170.21	200.00

Mechanical options

Interactive Driving System-plus (IDS-plus) with Continuous Damping Control (CDC) 1 see page 53	○		340.43	400.00
Remus stainless steel 70mm sports exhaust system, incorporating front de-cat downpipe, centre section and sport catalyts, with straight through link pipe, single rear silencer and chrome oval tailpipe with embossed VXR logo - retailer-fit (excluding fitting) 1 see page 39 for ordering details	○		723.40	850.00

Exterior and convenience options

Electrically foldable door mirrors	○	○	127.66	150.00
Adaptive Forward Lighting (AFL) incorporating bi-xenon headlights with dynamic beam levelling and high-pressure washers 1 see page 52	○	○	638.30	750.00
19-inch multi-spoke alloy wheels with anthracite inner, 235/35 R 19 ultra-low profile tyres	○	○	531.91	625.00
Dark-tinted windows (excludes windscreen and front door windows)	○	●	212.77	250.00
Rear parking distance sensor 1 see page 51	○		297.87	350.00
Two-coat metallic or pearlescent paint	○		319.15	375.00

Audio and communication options

CDC 40 • Integral six-disc CD autochanger with MP3 format • Stereo radio • Graphic display ¹	○		340.43	400.00
CD 70 • Satellite navigation system • CD player with MP3 format • Stereo radio • Auxiliary-in socket • Colour monitor 1 see page 50	○	○	1063.83	1250.00
Mobile phone system with Bluetooth® (does not include phone or cradle) - see page 57 for details of mobile phone compatibility 1 see page 50	○	○	255.32	300.00

○ = Optional at extra cost. ● = Standard equipment.

¹ = Deletes auxiliary-in socket.



5-door MPV

Model	Price (£)	VAT (£)	Total (£)	On-the-road RRP (£)	CO ₂ * (g/km)
Zafira VXR					
2.0i 16v Turbo (240PS)	18525.11	3241.89	21767.00	22845.00	230

Please note: On-the-road recommended retail prices (RRP) include number plates and delivery to retailer of £623.00 (inc. £92.79 VAT), 12 months' Vehicle Excise Duty (see page 2) and new vehicle first registration fee of £55.00. Excludes fuel and insurance.

* = CO₂ emission figure. Vehicle Excise Duty is based on CO₂ emissions (see page 2 for details). For benefit in kind taxation charges see page 2.



See pages 54-57 for accessory and styling products



See page 47 for fuel data



See page 59 for MasterFit Service Plan details

Option availability

	VXR	Price (£) exc. VAT	Total (£) inc. VAT
Option packs			
Leather Pack¹ • Leather seat facings • Electrically heated Recaro sports front seats with tilt and lumbar adjustment • Front passenger's seat height adjuster • Centre rear seat head restraint	<input type="radio"/>	936.17	1100.00
Sight and Light Pack • Rain-sensitive windscreen wipers • Electro-chromatic anti-dazzle rear-view mirror • Automatic lighting control	<input type="radio"/>	170.21	200.00
FlexOrganiser® Organiser Pack • 3D storage net • Side net pocket • Four side rail hooks	<input type="radio"/>	42.55	50.00
Interior options			
Electronic Climate Control (ECC) 1 see page 52	<input type="radio"/>	234.04	275.00
Cruise control	<input type="radio"/>	170.21	200.00
Exterior and convenience options			
Electrically foldable door mirrors	<input type="radio"/>	127.66	150.00
Adaptive Forward Lighting (AFL) incorporating bi-xenon headlights with dynamic beam levelling and high-pressure washers 1 see page 52	<input type="radio"/>	638.30	750.00
Alloy-effect roof rails ²	<input type="radio"/>	85.11	100.00
19-inch multi-spoke alloy wheels with anthracite inner; 235/35 R 19 ultra-low profile tyres	<input type="radio"/>	531.91	625.00
Front and rear parking distance sensors 1 see page 51	<input type="radio"/>	297.87	350.00
Two-coat metallic or pearlescent paint	<input type="radio"/>	319.15	375.00
Audio and communication options			
CDC 40 • Integral six-disc CD autochanger with MP3 format • Stereo radio • Graphic display ³	<input type="radio"/>	340.43	400.00
CD 70 • Satellite navigation system • CD player with MP3 format • Stereo radio • Auxiliary-in socket • Colour monitor 1 see page 50	<input type="radio"/>	1063.83	1250.00
Rear seat Twin Audio® system with single headset 1 see page 50	<input type="radio"/>	85.11	100.00
Mobile phone system with Bluetooth® (does not include phone or cradle) – see page 57 for details of mobile phone compatibility 1 see page 50	<input type="radio"/>	255.32	300.00

O = Optional at extra cost.

1 = Deletes front passenger's underseat storage tray. **2** = Must be used with separate base carrier (available as a Vauxhall accessory) if luggage is to be carried on the roof. **3** = Deletes auxiliary-in socket.

5-door hatchback/estate

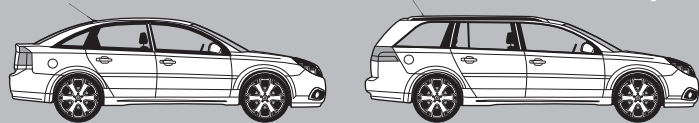

Model	Price (£)	VAT (£)	Total (£)	On-the-road RRP (£)	CO ₂ * (g/km)
Vectra VXR 5-door hatchback					
2.8i V6 24v Turbo (280PS)	21035.74	3681.26	24717.00	25795.00	250
2.8i V6 24v Turbo (280PS) auto	22142.13	3874.87	26017.00	27095.00	264
Vectra VXR 5-door estate					
2.8i V6 24v Turbo (280PS)	21971.91	3845.09	25817.00	26895.00	252
2.8i V6 24v Turbo (280PS) auto	23078.30	4038.70	27117.00	28195.00	271

Please note: On-the-road recommended retail prices (RRP) include number plates and delivery to retailer of £623.00 (inc. £92.79 VAT), 12 months' Vehicle Excise Duty (see page 2) and new vehicle first registration fee of £55.00. Excludes fuel and insurance.

* = CO₂ emission figure. Vehicle Excise Duty is based on CO₂ emissions (see page 2 for details). For benefit in kind taxation charges see page 2.



See pages 54-57 for accessory and styling products



See page 47 for fuel data

Option availability

	VXR	Price (£) exc. VAT	Total (£) inc. VAT
Option packs			
Leather Pack • Leather seat facings • Electrically heated Recaro sports front seats • Eight-way electrical adjustment for driver's and front passenger's seats	<input type="radio"/>	1276.60	1500.00
Towing Pack ¹ (estate) • Trailer stability programme • Retractable tow bar	<input type="radio"/>	595.74	700.00
FlexOrganiser® Organiser Pack (estate) • 3D storage net • Side net pocket • Four side rail hooks	<input type="radio"/>	42.55	50.00
Interior option			
Electronic Climate Control (ECC) incorporating air conditioning 1 see page 52	<input type="radio"/>	234.04	275.00
Vertical load-restraining net (estate only) ²	<input type="radio"/>	127.66	150.00
Exterior and convenience options			
19-inch multi-spoke alloy wheels with anthracite inner. 235/35 R 19 ultra-low profile tyres	<input type="radio"/>	510.64	600.00
Adaptive Forward Lighting (AFL) incorporating bi-xenon headlights with beam levelling and high-pressure headlight washers 1 see page 52	<input type="radio"/>	723.40	850.00
Power tailgate (estate only)	<input type="radio"/>	425.53	500.00
Alloy-effect roof rails (estate only) ³	<input type="radio"/>	85.11	100.00
Front and rear parking distance sensors 1 see page 51	<input type="radio"/>	361.70	425.00
Two-coat metallic or pearlescent paint	<input type="radio"/>	319.15	375.00
Audio and communication options			
CD 70 • Satellite navigation system • CD player with MP3 format • Stereo radio • Auxiliary-in socket • Colour monitor 1 see page 50	<input type="radio"/>	680.85	800.00
Mobile phone system with Bluetooth® (does not include phone or cradle) ⁴ – see page 57 for details of mobile phone compatibility 1 see page 50	<input type="radio"/>	255.32	300.00

○ = Optional at extra cost.

1 = Please note: a separate electrical adaptor (13-pin to 7-pin) is required – available as an accessory at extra cost. This adaptor does not allow for supplementary trailer power requirements. **2** = Includes fixing points for accessory dog guard.

3 = Must be used with separate base carrier (available as a Vauxhall accessory) if luggage is to be carried on the roof.

4 = Deletes drinks holders in centre console.

4-door saloon

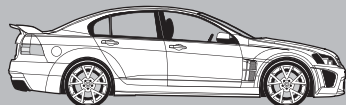

Model	Price (£)	VAT (£)	Total (£)	On-the-road RRP (£)	CO ₂ * (g/km)
VXR8					
6.2i V8 (431PS)	29716.60	5200.40	34917.00	35995.00	364
6.2i V8 (431PS) auto	30929.36	5412.64	36342.00	37420.00	345

Please note: On-the-road recommended retail prices (RRP) include number plates and delivery to retailer of £623.00 (inc. £92.79 VAT), 12 months' Vehicle Excise Duty (see page 2) and new vehicle first registration fee of £55.00. Excludes fuel and insurance.

* = CO₂ emission figure. Vehicle Excise Duty is based on CO₂ emissions (see page 2 for details). For benefit in kind taxation charges see page 2.

Option availability

	VXR8	Price (£) exc. VAT	Total (£) inc. VAT
Exterior options			
Two-coat metallic or pearlescent paint	N/C	No-cost option	
WPP stainless steel sports exhaust system incorporating single centre box and twin rear silencers complete with WPP embossed oval tailpipes – includes fitting 1 see below for ordering details	○	948.09	1114.00
Audio and communication options			
Integrated satellite navigation system ¹	○	1276.60	1500.00
Integrated satellite navigation system (retailer-fit) ²	○	1276.60	1500.00

○ = Optional at extra cost. N/C = No-cost option.

¹ = Total price comprises £1383.00 inc. VAT for the factory-fit satellite navigation system plus £117.00 for the accessory satellite navigation disc. ² = Total price includes satellite navigation system, fitting and accessory satellite navigation disc.



See pages 54-57 for accessory and styling products



See page 47 for fuel data



walkinshaw
PERFORMANCE

Walkinshaw Performance has a simple and passionate vision – to bring your car to life with the very best in high performance upgrades. As the Vauxhall approved supplier for VXR8 enhancements, they offer a range of performance options. For more details, visit www.walkinshawperformance.co.uk, telephone 01608 672922 or contact your local VXR8 retailer.



	Trans- mission	Fuel economy mpg (litres/100km)		
		Urban driving	Extra-urban driving	Combined figure

New Agila

1.0i 12v ecoFLEX	manual	47.9 (5.9)	64.2 (4.4)	56.5 (5.0)
1.2i 16v	manual	40.9 (6.9)	60.1 (4.7)	51.4 (5.5)
1.2i 16v	automatic	36.2 (7.8)	57.6 (4.9)	47.9 (5.9)
1.3CDTi 16v ecoFLEX	manual	51.4 (5.5)	70.6 (4.0)	62.8 (4.5)

Tigra

1.4i 16v	manual	34.9 (8.1)	56.5 (5.0)	46.3 (6.1)
1.4i 16v	Easytronic	35.3 (8.0)	57.6 (4.9)	47.1 (6.0)
1.8i 16v	manual	27.2 (10.4)	48.7 (5.8)	37.7 (7.5)
1.3CDTi 16v	manual	48.7 (5.8)	72.4 (3.9)	61.4 (4.6)

Corsa

1.0i 12v	manual	38.7 (7.3)	61.4 (4.6)	50.4 (5.6)
1.2i 16v exc. SXi	manual	36.7 (7.7)	60.1 (4.7)	48.7 (5.8)
1.2i 16v SXi	manual	35.3 (8.0)	56.5 (5.0)	46.3 (6.1)
1.2i 16v exc. SXi	Easytronic	37.2 (7.6)	61.4 (4.6)	49.6 (5.7)
1.4i 16v	manual	35.3 (8.0)	56.5 (5.0)	46.3 (6.1)
1.4i 16v 3-dr hatch	automatic	33.2 (8.5)	53.3 (5.3)	43.5 (6.5)
1.4i 16v 5-dr hatch	automatic	32.8 (8.6)	52.3 (5.4)	42.8 (6.6)
1.6i 16v Turbo (150PS)	manual	26.9 (10.5)	44.1 (6.4)	35.8 (7.9)
1.3CDTi 16v (75PS) ecoFLEX	manual	49.6 (5.7)	74.3 (3.8)	62.8 (4.5)
1.3CDTi 16v (90PS)	manual	45.6 (6.2)	70.6 (4.0)	58.9 (4.8)
1.7CDTi 16v 3-dr hatch	manual	45.6 (6.2)	70.6 (4.0)	58.9 (4.8)
1.7CDTi 16v 5-dr hatch	manual	44.8 (6.3)	68.9 (4.1)	57.6 (4.9)

	Trans- mission	Fuel economy mpg (litres/100km)		
		Urban driving	Extra-urban driving	Combined figure

Meriva

1.4i 16v	manual	34.9 (8.1)	55.4 (5.1)	45.6 (6.2)
1.6i 16v	manual	31.7 (8.9)	52.3 (5.4)	42.2 (6.7)
1.6i 16v	Easytronic	31.7 (8.9)	52.3 (5.4)	42.2 (6.7)
1.8i 16v	manual	27.4 (10.3)	50.4 (5.6)	38.7 (7.3)
1.8i 16v	Easytronic	28.0 (10.1)	49.6 (5.7)	38.7 (7.3)
1.3CDTi 16v	manual	45.6 (6.2)	65.7 (4.3)	56.5 (5.0)
1.7CDTi 16v	manual	42.8 (6.6)	64.2 (4.4)	54.3 (5.2)

Astra Sport Hatch

1.4i 16v	manual	35.3 (8.0)	56.5 (5.0)	46.3 (6.1)
1.6i 16v VVT ¹	manual	32.5 (8.7)	54.3 (5.2)	43.5 (6.5)
1.6i 16v VVT ²	manual	32.1 (8.8)	53.3 (5.3)	42.8 (6.6)
1.6i 16v VVT	Easytronic	33.2 (8.5)	56.5 (5.0)	44.8 (6.3)
1.8i 16v VVT ¹	manual	29.1 (9.7)	50.4 (5.6)	39.8 (7.1)
1.8i 16v VVT ²	manual	28.8 (9.8)	49.6 (5.7)	39.2 (7.2)
1.8i 16v VVT ¹	automatic	27.2 (10.4)	46.3 (6.1)	36.7 (7.7)
1.8i 16v VVT ²	automatic	26.9 (10.5)	45.6 (6.2)	36.2 (7.8)
1.6i 16v Turbo	manual	27.4 (10.3)	45.6 (6.2)	36.7 (7.7)
1.7CDTi 16v (100PS) ¹	manual	44.1 (6.4)	67.3 (4.2)	56.5 (5.0)
1.7CDTi 16v (100PS) ²	manual	43.5 (6.5)	65.7 (4.3)	55.4 (5.1)
1.7CDTi 16v (110PS) ecoFLEX	manual	50.4 (5.6)	72.4 (3.9)	62.8 (4.5)
1.9CDTi (120PS)	manual	39.2 (7.2)	60.1 (4.7)	50.4 (5.6)
1.9CDTi (120PS)	automatic	29.4 (9.6)	53.3 (5.3)	40.9 (6.9)
1.9CDTi 16v (150PS)	manual	39.2 (7.2)	60.1 (4.7)	50.4 (5.6)

The fuel consumption figures shown comply with EC directive 1999/100 to provide a realistic indication of fuel consumption by taking into account everyday driving conditions, such as cold starts, acceleration and braking. These figures take account of the vehicle's kerbweight, ascertained in accordance with the above regulation. **Important:** the results given relate to the particular car tested. Variations in trim level and equipment may result in slightly higher fuel consumption and CO₂ emission levels than those quoted. Driving style, road and traffic conditions, vehicle mileage and standard of maintenance may also affect fuel consumption; therefore the results do not express or imply any guarantee of fuel consumption attainable.

¹ = Figures apply to vehicles fitted with wheels up to 16 inches in diameter.

² = Figures apply to vehicles fitted with 17-inch or 18-inch wheels.

	Transmission	Fuel economy mpg (litres/100km)		
		Urban driving	Extra-urban driving	Combined figure
Astra				
1.4i 16v	manual	35.3 (8.0)	56.5 (5.0)	46.3 (6.1)
1.6i 16v VVT ¹	manual	32.5 (8.7)	54.3 (5.2)	43.5 (6.5)
1.6i 16v VVT ²	manual	32.1 (8.8)	53.3 (5.3)	42.8 (6.6)
1.6i 16v VVT	Easytronic	33.2 (8.5)	56.5 (5.0)	44.8 (6.3)
1.8i 16v VVT ¹	manual	29.1 (9.7)	50.4 (5.6)	39.8 (7.1)
1.8i 16v VVT ²	manual	28.8 (9.8)	49.6 (5.7)	39.2 (7.2)
1.8i 16v VVT ¹	automatic	26.9 (10.5)	45.6 (6.2)	36.2 (7.8)
1.8i 16v VVT ²	automatic	26.6 (10.6)	44.8 (6.3)	35.8 (7.9)
1.6i 16v Turbo	manual	27.4 (10.3)	45.6 (6.2)	36.7 (7.7)
1.3CDTi 16v (90PS)	manual	44.8 (6.3)	68.9 (4.1)	57.6 (4.9)
1.7CDTi 16v (100PS) Life	manual	44.1 (6.4)	67.3 (4.2)	56.5 (5.0)
1.7CDTi 16v (100PS) (exc. Life)	manual	43.5 (6.5)	65.7 (4.3)	55.4 (5.1)
1.7CDTi 16v (110PS) ecoFLEX	manual	50.4 (5.6)	72.4 (3.9)	62.8 (4.5)
1.9CDTi (120PS)	manual	39.2 (7.2)	60.1 (4.7)	50.4 (5.6)
1.9CDTi (120PS)	automatic	29.1 (9.7)	52.3 (5.4)	40.4 (7.0)
1.9CDTi 16v (150PS)	manual	39.2 (7.2)	60.1 (4.7)	50.4 (5.6)

Astra estate

1.4i 16v	manual	35.3 (8.0)	56.5 (5.0)	46.3 (6.1)
1.6i 16v VVT ¹	manual	32.1 (8.8)	53.3 (5.3)	42.8 (6.6)
1.6i 16v VVT ²	manual	31.7 (8.9)	52.3 (5.4)	42.2 (6.7)
1.6i 16v VVT	Easytronic	32.8 (8.6)	55.4 (5.1)	44.1 (6.4)
1.8i 16v VVT ¹	manual	28.8 (9.8)	49.6 (5.7)	39.2 (7.2)
1.8i 16v VVT ²	manual	28.5 (9.9)	48.7 (5.8)	38.7 (7.3)
1.8i 16v VVT ¹	automatic	26.9 (10.5)	45.6 (6.2)	36.2 (7.8)
1.8i 16v VVT ²	automatic	26.6 (10.6)	44.8 (6.3)	35.8 (7.9)
1.6i 16v Turbo	manual	27.4 (10.3)	45.6 (6.2)	36.7 (7.7)
1.3CDTi 16v (90PS)	manual	44.8 (6.3)	68.9 (4.1)	57.6 (4.9)
1.7CDTi 16v (100PS) Life	manual	44.1 (6.4)	67.3 (4.2)	56.5 (5.0)
1.7CDTi 16v (100PS) (exc. Life)	manual	43.5 (6.5)	65.7 (4.3)	55.4 (5.1)
1.7CDTi 16v (110PS) ecoFLEX	manual	50.4 (5.6)	72.4 (3.9)	62.8 (4.5)
1.9CDTi (120PS)	manual	38.7 (7.3)	58.9 (4.8)	49.6 (5.7)
1.9CDTi (120PS)	automatic	29.1 (9.7)	52.3 (5.4)	40.4 (7.0)
1.9CDTi 16v (150PS)	manual	38.7 (7.3)	58.9 (4.8)	49.6 (5.7)

	Transmission	Fuel economy mpg (litres/100km)		
		Urban driving	Extra-urban driving	Combined figure
Astra TwinTop				
1.6i 16v VVT	manual	31.4 (9.0)	51.4 (5.5)	41.5 (6.8)
1.8i 16v VVT	manual	28.2 (10.0)	47.9 (5.9)	38.2 (7.4)
1.8i 16v VVT	automatic	26.4 (10.7)	44.1 (6.4)	35.3 (8.0)
2.0i 16v Turbo (200PS)	manual	21.2 (13.3)	38.7 (7.3)	29.7 (9.5)
1.9CDTi 16v (150PS)	manual	37.2 (7.6)	55.4 (5.1)	47.1 (6.0)

Zafira

1.6i 16v	manual	30.1 (9.4)	47.9 (5.9)	39.2 (7.2)
1.8i 16v VVT	manual	28.5 (9.9)	47.1 (6.0)	38.2 (7.4)
1.8i 16v VVT	Easytronic	29.1 (9.7)	48.7 (5.8)	39.2 (7.2)
2.2i 16v Direct	manual	25.0 (11.3)	44.1 (6.4)	34.4 (8.2)
2.2i 16v Direct	automatic	24.4 (11.6)	42.2 (6.7)	33.2 (8.5)
2.0i 16v Turbo	manual	21.2 (13.3)	38.7 (7.3)	29.7 (9.5)
1.9CDTi (120PS)	manual	37.2 (7.6)	55.4 (5.1)	47.1 (6.0)
1.9CDTi (120PS)	automatic	28.8 (9.8)	49.6 (5.7)	39.2 (7.2)
1.9CDTi 16v (150PS)	manual	36.7 (7.7)	54.3 (5.2)	46.3 (6.1)
1.9CDTi 16v (150PS)	automatic	28.8 (9.8)	49.6 (5.7)	39.2 (7.2)

Vectra hatchback/saloon

1.8i 16v VVT ³	manual	28.0 (10.1)	51.4 (5.5)	39.2 (7.2)
1.8i 16v VVT ⁴	manual	27.7 (10.2)	50.4 (5.6)	38.7 (7.3)
2.2i 16v Direct ³	manual	27.4 (10.3)	47.9 (5.9)	37.7 (7.5)
2.2i 16v Direct ⁴	manual	27.2 (10.4)	47.1 (6.0)	37.2 (7.6)
2.2i 16v Direct ³	automatic	25.0 (11.3)	46.3 (6.1)	35.3 (8.0)
2.2i 16v Direct ⁴	automatic	24.8 (11.4)	45.6 (6.2)	34.9 (8.1)
2.0i 16v Turbo hatch ³	manual	22.6 (12.5)	44.8 (6.3)	32.8 (8.6)
2.0i 16v Turbo hatch ⁴	manual	22.4 (12.6)	44.1 (6.4)	32.5 (8.7)
2.8i V6 24v Turbo hatch	automatic	16.5 (17.1)	38.7 (7.3)	25.9 (10.9)
1.9CDTi (120PS) ³	manual	38.2 (7.4)	60.1 (4.7)	49.6 (5.7)
1.9CDTi (120PS) ⁴	manual	37.7 (7.5)	58.9 (4.8)	48.7 (5.8)
1.9CDTi 16v (150PS) ³	manual	38.2 (7.4)	60.1 (4.7)	49.6 (5.7)
1.9CDTi 16v (150PS) ⁴	manual	37.7 (7.5)	58.9 (4.8)	48.7 (5.8)
1.9CDTi 16v (150PS) hatch ³	automatic	29.7 (9.5)	52.3 (5.4)	40.9 (6.9)
1.9CDTi 16v (150PS) saloon ³	automatic	30.1 (9.4)	53.3 (5.3)	41.5 (6.8)
1.9CDTi 16v (150PS) hatch ⁴	automatic	29.4 (9.6)	51.4 (5.5)	40.4 (7.0)
1.9CDTi 16v (150PS) saloon ⁴	automatic	29.7 (9.5)	52.3 (5.4)	40.9 (6.9)

	Trans- mission	Fuel economy mpg (litres/100km)		
		Urban driving	Extra-urban driving	Combined figure

Vectra hatchback/saloon (continued)

3.0CDTi V6 24v hatch	manual	28.8 (9.8)	54.3 (5.2)	40.9 (6.9)
3.0CDTi V6 24v hatch	automatic	27.7 (10.2)	53.3 (5.3)	39.8 (7.1)

Vectra estate

1.8i 16v VVT ³	manual	27.4 (10.3)	47.9 (5.9)	37.7 (7.5)
1.8i 16v VVT ⁴	manual	27.2 (10.4)	47.1 (6.0)	37.2 (7.6)
2.2i 16v Direct ³	manual	26.6 (10.6)	45.6 (6.2)	36.2 (7.8)
2.2i 16v Direct ⁴	manual	26.4 (10.7)	44.8 (6.3)	35.8 (7.9)
2.2i 16v Direct ³	automatic	24.6 (11.5)	44.8 (6.3)	34.4 (8.2)
2.2i 16v Direct ⁴	automatic	24.4 (11.6)	44.1 (6.4)	34.0 (8.3)
2.0i 16v Turbo ³	manual	22.2 (12.7)	43.5 (6.5)	32.1 (8.8)
2.0i 16v Turbo ⁴	manual	22.1 (12.8)	42.8 (6.6)	31.7 (8.9)
2.8i V6 24v Turbo	automatic	16.2 (17.4)	37.2 (7.6)	25.2 (11.2)
1.9CDTi (120PS) ³	manual	37.7 (7.5)	58.9 (4.8)	48.7 (5.8)
1.9CDTi (120PS) ⁴	manual	37.2 (7.6)	57.6 (4.9)	47.9 (5.9)
1.9CDTi 16v (150PS) ³	manual	37.7 (7.5)	58.9 (4.8)	48.7 (5.8)
1.9CDTi 16v (150PS) ⁴	manual	37.2 (7.6)	57.6 (4.9)	47.9 (5.9)
1.9CDTi 16v (150PS) ³	automatic	29.4 (9.6)	51.4 (5.5)	40.4 (7.0)
1.9CDTi 16v (150PS) ⁴	automatic	29.1 (9.7)	50.4 (5.6)	39.8 (7.1)
3.0CDTi V6 24v	manual	28.8 (9.8)	54.3 (5.2)	40.9 (6.9)
3.0CDTi V6 24v	automatic	27.4 (10.3)	52.3 (5.4)	39.2 (7.2)

	Trans- mission	Fuel economy mpg (litres/100km)		
		Urban driving	Extra-urban driving	Combined figure

Antara

2.0CDTi 16v	manual	32.5 (8.7)	41.5 (6.8)	37.2 (7.6)
2.0CDTi 16v	automatic	25.9 (10.9)	38.7 (7.3)	32.8 (8.6)

VXR

Corsa 1.6i 16v Turbo (192PS)	manual	26.9 (10.5)	44.1 (6.4)	35.8 (7.9)
Meriva 1.6i 16v Turbo (180PS)	manual	27.2 (10.4)	44.8 (6.3)	36.2 (7.8)
Zafira 2.0i 16v Turbo (240PS)	manual	21.1 (13.4)	38.2 (7.4)	29.4 (9.6)
Astra 2.0i 16v Turbo (240PS)	manual	21.7 (13.0)	40.4 (7.0)	30.7 (9.2)
Vectra hatchback 2.8i V6 24v Turbo (280PS)	manual	18.2 (15.5)	38.2 (7.4)	27.2 (10.4)
Vectra hatchback 2.8i V6 24v Turbo (280PS)	automatic	16.4 (17.2)	38.2 (7.4)	25.7 (11.0)
Vectra estate 2.8i V6 24v Turbo (280PS)	manual	18.1 (15.6)	37.7 (7.5)	26.9 (10.5)
Vectra estate 2.8i V6 24v Turbo (280PS)	automatic	16.1 (17.5)	36.7 (7.7)	25.0 (11.3)
VXR8 6.2i V8 (431PS)	manual	12.7 (22.3)	25.4 (11.1)	18.6 (15.2)
VXR8 6.2i V8 (431PS)	automatic	13.6 (20.8)	26.2 (10.8)	19.5 (14.5)

The fuel consumption figures shown comply with EC directive 1999/100 to provide a realistic indication of fuel consumption by taking into account everyday driving conditions, such as cold starts, acceleration and braking. These figures take account of the vehicle's kerbweight, ascertained in accordance with the above regulation. **Important:** the results given relate to the particular car tested. Variations in trim level and equipment may result in slightly higher fuel consumption and CO₂ emission levels than those quoted. Driving style, road and traffic conditions, vehicle mileage and standard of maintenance may also affect fuel consumption; therefore the results do not express or imply any guarantee of fuel consumption attainable.

- 1 = Figures apply to vehicles fitted with wheels up to 16 inches in diameter.
- 2 = Figures apply to vehicles fitted with 17-inch or 18-inch wheels.
- 3 = Figures apply to vehicles fitted with wheels up to 18 inches in diameter.
- 4 = Figures apply to vehicles fitted with 19-inch wheels.

SWB Combi

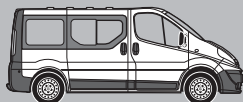

Model	Price (£)	VAT (£)	Total (£)	On-the-road RRP (£)	CO ₂ * (g/km)
Vivaro SWB 9-seat combi					
2900 2.0CDTI 16v (90PS)	17295.00	3026.63	20321.63	21209.63	214

LWB Combi

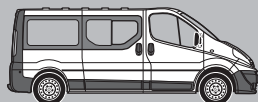

Model	Price (£)	VAT (£)	Total (£)	On-the-road RRP (£)	CO ₂ * (g/km)
Vivaro LWB 9-seat combi					
2900 2.0CDTI 16v (115PS)	18710.00	3274.25	21984.25	22872.25	224
2900 2.0CDTI 16v (115PS) Tecshift	19510.00	3414.25	22924.25	23812.25	213

Please note: On-the-road recommended retail prices (RRP) include number plates and delivery to retailer of £623.00 (inc. £92.79 VAT), 12 months' Vehicle Excise Duty (£210.00) and new vehicle first registration fee of £55.00. Excludes fuel and insurance.

* = CO₂ emission figures. Vehicle Excise Duty is based on CO₂ emissions (see page 2 for details). For benefit in kind taxation charges see page 2.

Fuel consumption figures

	Trans-mission	Fuel economy mpg (litres/100km)		
		Urban driving	Extra-urban driving	Combined figure
Vivaro 9-seat combi				
2.0CDTI 16v (90PS)	manual	28.8 (9.8)	40.4 (7.0)	35.8 (7.9)
2.0CDTI 16v (115PS)	manual	27.7 (10.2)	38.2 (7.4)	33.6 (8.4)
2.0CDTI 16v (115PS)	Tecshift	31.0 (9.1)	38.2 (7.4)	35.3 (8.0)

Option availability

	Combi	Price (£) exc. VAT	Total (£) inc. VAT
Option pack			
Vision Pack • Rain-sensitive windscreen wipers • Front fog lights • Selective door locking	<input type="radio"/>	125.00	146.87
Safety and security options			
Front passengers' twin airbag	<input type="radio"/>	235.00	276.12
Electronic Stability Programme-plus (ESP-plus) i see page 53	<input type="radio"/>	400.00	470.00
Remote control ultrasonic security alarm system	<input type="radio"/>	150.00	176.25
Interior and seating options			
Driver's seat with lumbar adjustment and armrest	<input type="radio"/>	50.00	58.75
Driver's seat and single front passenger's seat with lumbar adjustment and armrest	<input type="radio"/>	100.00	117.50
Air conditioning – cab area only	<input type="radio"/>	600.00	705.00
Solar Reflect® windscreen	<input type="radio"/>	50.00	58.75
Additional rear heating ¹	<input type="radio"/>	200.00	235.00
Front and rear air conditioning	<input type="radio"/>	1200.00	1410.00
Mechanical option			
Speed limiter	<input type="radio"/>	75.00	88.12
Rear door option			
Glazed twin rear doors with heated windows and wash/wipe facility	<input type="radio"/>	150.00	176.25
Exterior options			
16-inch recessed alloy wheels (steel spare) with 215/65 R 16 tyres	<input type="radio"/>	400.00	470.00
16-inch alloy wheels (steel spare) with 215/65 R 16 tyres	<input type="radio"/>	400.00	470.00
Two-coat metallic or pearlescent paint	<input type="radio"/>	370.00	434.75
Special paint (restrictions apply – please consult your retailer for availability)	<input type="radio"/>	415.00	487.62
Rear parking distance sensors	<input type="radio"/>	250.00	293.75
Audio and communication options			
CD 70 • Satellite navigation system • CD player with MP3 format • Stereo radio • Auxiliary-in socket • Colour monitor • Steering wheel mounted audio controls	<input type="radio"/>	850.00	998.75
Steering wheel mounted audio controls	<input type="radio"/>	50.00	58.75
Factory-fit telephone pre-wiring	<input type="radio"/>	75.00	88.12

○ = Optional at extra cost.

¹ = Only available in conjunction with front and rear air conditioning on LWB models.

SWB Combi

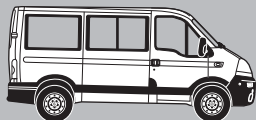

Model	Price (£)	VAT (£)	Total (£)	On-the-road RRP (£)	CO ₂ * (g/km)
Movano SWB 6-seat semi-glazed combi					
2800 2.5CDTI 16v (100PS)	18785.00	3287.38	22072.38	23150.38	230
Movano SWB 9-seat fully glazed combi					
2800 2.5CDTI 16v (100PS)	19285.00	3374.88	22659.88	23737.88	230
2800 2.5CDTI 16v (146PS)	21685.00	3794.88	25479.88	26557.88	235

Please note: On-the-road recommended retail prices (RRP) include number plates and delivery to retailer of £623.00 (inc. £92.79 VAT), 12 months' Vehicle Excise Duty (£400.00) and new vehicle first registration fee of £55.00. Excludes fuel and insurance.

* = CO₂ emission figures. Vehicle Excise Duty is based on CO₂ emissions (see page 2 for details). For benefit in kind taxation charges see page 2.

Fuel consumption figures

	Trans- mission	Fuel economy mpg (litres/100km)		
		Urban driving	Extra-urban driving	Combined figure
Movano 6-/9-seat SWB combi				
2.5CDTI 16v (100PS)	manual	26.6 (10.6)	36.7 (7.7)	32.5 (8.7)
2.5CDTI 16v (146PS)	manual	25.9 (10.9)	36.7 (7.7)	31.7 (8.9)

Option availability

	Combi	Price (£) exc. VAT	Total (£) inc. VAT
Option packs			
Electric Pack • Electrically operated front windows • Electrically adjustable/heated door mirrors	○	275.00	323.12
Technical Pack • Cruise control with driver controllable speed limiter • Trip computer	○	500.00	587.50
Safety and security options			
Front passengers' twin airbag and pyrotechnic body-lock seatbelt pretensioners	○ ¹	250.00	293.75
Remote control ultrasonic security alarm system	○	100.00	117.50
Electronic Stability Programme-plus (ESP-plus) i see page 53	○	750.00	881.25
Interior and seating options			
Single front passenger's seat	N/C ¹	No-cost option	
Single fully adjustable 'comfort' front passenger's seat with armrest	○	50.00	58.75
Multi-function front passenger's bench seat with underseat storage facility	○	100.00	117.50
Tyre inflation kit in lieu of spare wheel	N/C	No-cost option	
Trip computer	○	300.00	352.50
Tilting glass sunroof for saloon area	○	200.00	235.00
Mechanical options			
Digital tachograph ²	○	500.00	587.50
Six-pin connection in battery compartment	○	50.00	58.75
Speed limiter	○	75.00	88.12
Height-adjustable pneumatic rear suspension (not available with ESP-plus)	○	1500.00	1762.50
Tow bar	○ ³	350.00	411.25
Exterior options			
Rain-sensitive windscreen wipers and Automatic Lighting Control (ALC)	○	250.00	293.75
Two-coat metallic paint	○	370.00	434.75
Special paint (restrictions apply - please consult your retailer for availability)	○	415.00	487.62
Rear parking distance sensors	○	250.00	293.75
Audio and communication options			
• Stereo radio/cassette player • Traffic Programme	N/C	No-cost option	
• Satellite navigation system • CD player • Stereo radio • Monochromatic display	○	750.00	881.25

○ = Optional at extra cost. N/C = No-cost option.

¹ = Front passengers' twin airbag not available with single front passenger's seat options. ² = Option price for digital tachograph does not include calibration which must be carried out at an approved tachograph centre within 14 days of the vehicles registration. **Please note:** The legislation regarding the use of tachographs is complex and operators should seek independent advice or speak to the Commercial Vehicle specialist at your Vauxhall retailer to ensure compliance. Alternatively your local DVLA office will also be able to provide clarification of the relevant legislation. ³ = Not available with rear parking distance sensors.

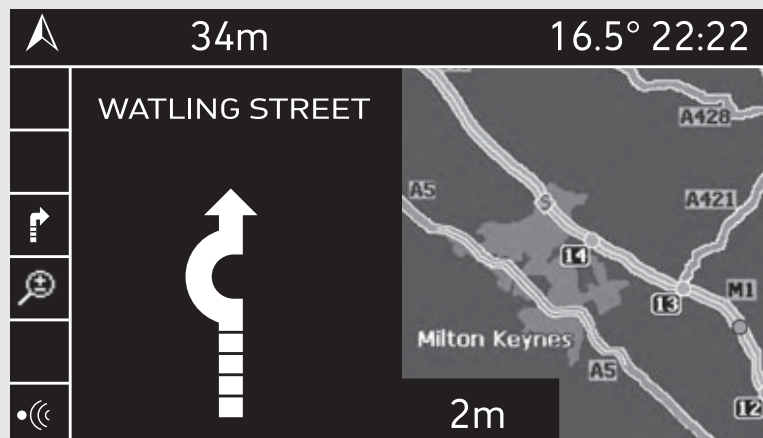

Satellite navigation

Vauxhall's satellite navigation systems are designed for ease of use and extremely high levels of information. Some systems are fitted with the latest Traffic Message Channel (TMC), broadcasting real-time traffic information, delivered either visually or verbally – alerting the driver to a problem on the planned route and then offering an alternative route to avoid the incident.

The systems use the international network of GPS (Global Positioning System) satellites linked to a comprehensive CD-ROM mapping system to determine your precise location and guide you to your chosen destination virtually anywhere in mainland Britain. Additional discs can be purchased for all major European countries, which means that making a cross-European trip can now be as simple as changing a CD.

All units are simple to operate, using a range of menu-driven options which are easily accessed from the central control button or via the steering wheel mounted audio controls. The audible direction guidance prompts give details of road numbers and motorway junction numbers. There are a number of options that enable you to plan your journey – for example by avoiding motorways.

The CD 60 units feature verbal instructions together with schematic arrows displayed in the centrally mounted monochrome graphic information display. CD 70 units additionally feature a colour monitor (shown above) on most models with a mapping function in addition to the directional arrows.

Mobile phone system with Bluetooth®

Vauxhall's factory-fit dual-band mobile phone system provides integration with the audio and communication system, it also features voice control and will connect wirelessly to phones with Bluetooth® technology.

All the required information is shown on the fascia display when a mobile phone is in use, while the menus are easily navigated by either the steering wheel audio controls or the multi-function button on the radio. Certain functions can also be controlled by voice activation.

The phone system base unit must be fitted with a cradle (available as an accessory) mounted on the centre console – see page 57 for a list of compatible mobile phones.



Rear seat Twin Audio®

Vauxhall's Twin Audio® system provides peace and quiet on long journeys! The system comes with a single headphone set and separate rear controls so front and rear passengers can listen to the radio or a CD totally independently of each other. The rear seat control module sits at the end of the centre console between the two front seats. This provides an on/off switch, independent volume controls for each headset, switching between CD and radio tuner and a scan function.

The system even mutes the rear speakers when any headphones are in use. Additional headphone sets for a second rear seat passenger are available as accessories – contact your Vauxhall retailer for information.

Please note:

Not all of these features are available on all models. Please see model pages for details.



MP3 CD player

An MP3 is a compressed sound or music file which, due to its small size, takes up less space on a compact disc, which means that more tracks can be recorded onto a CD. It's possible to fit almost 10 hours of music onto one CD, and, in a way, turns a single-disc CD/MP3 player into a multi-disc autochanger. Providing you have access to a compatible computer to create the MP3 tracks, you can compress your CD collection and create your own compilations – and you won't have to drive around with all your original CDs in the car.

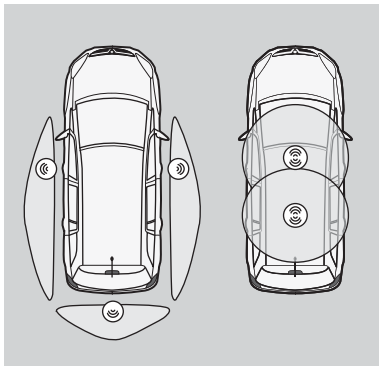

Keyless entry and start

Keyless entry and start system means that the driver need never remove their key fob from their pocket. When approaching the car, sensors in the front door handles and rear bumper detect the driver's proximity and automatically unlock the doors or boot when the handle is pulled.

When in the car, two internal sensors activate the ignition and release the electronic steering lock, enabling the driver to start or stop the engine merely by pressing the facia-mounted Start/Stop button.

Upon leaving the vehicle, the driver can lock it by either pressing a button on the key fob like a conventional system, or by simply touching one of the sensors on the external handles of the front doors.

Additionally, the system offers excellent theft protection by its use of sophisticated cryptographic algorithms, while a back-up key is also included for emergency use.



Easytronic transmission

Choose any model with Easytronic transmission and you'll get a five speed manual gearbox with a fully automatic mode. In manual mode, you simply push the lever forward or back to shift gears up or down. The facia display tells you what gear you're in – 1 to 5, N for Neutral or A

for Auto. Switch to fully automatic mode and it has many of the features of a regular automatic including a kickdown function. There's no clutch pedal so you can drive it on an automatic-only driving licence.

Automatic transmissions

A range of four, five and six-speed automatic transmissions are matched to the model and engine size. Many use an electronically controlled adaptive driving programme to tailor gearchanges to suit driving conditions and your driving style. And to reduce the chance of wheelspin in icy conditions, the Winter mode selects a higher than normal gear for standing starts. On five and six-speed transmissions the Active Select manual mode allows the gearlever to be used like a manual gearbox in order to change gear exactly when you want – you simply push the lever forward or back to change up or down the gears.

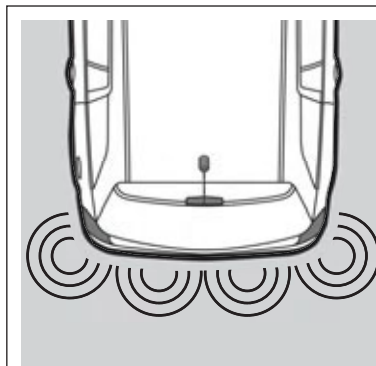

Parking distance sensors

This system helps safeguard your car and pedestrians by providing an audible warning to the driver when an object is detected by one of the sensors. Rear parking distance sensors are operated when reverse gear is selected. Zafira, Vectra and Antara models also feature front parking distance sensors. Additionally there are a range of accessory rear sensors available for fitment by your retailer.

Air conditioning

Air conditioning provides chilled air on hot days and a lot more besides. By dehumidifying the atmosphere inside the car, air conditioning can also increase your comfort and safety with faster window demisting on wet days and an altogether fresher travelling environment the whole year round.



Electronic Climate Control (ECC)

Electronic Climate Control (ECC) offers significant benefits over regular air conditioning by allowing you to set your preferred interior temperature and maintain it, regardless of external temperature and vehicle speed. Switch the system to automatic and it will achieve the desired temperature as swiftly as possible.

A sunlight sensor even accounts for rapid changes in temperature caused by driving in and out of direct sunlight. On Vectra the system also allows you to choose different cabin temperatures on each side of the car.



Electronic Climate Control (ECC) display as featured on Vectra.

Adaptive Forward Lighting (AFL)

Adaptive Forward Lighting is a sophisticated lighting system that allows you to see around corners by adjusting the headlights to follow the direction of the front wheels. And on some models the 'Cornering light' illuminates kerbs, street signs and tight bends. In fact, *Autocar* magazine were so impressed that they described it as a 'must-have' feature.

Corsa and Meriva models feature AFL with halogen headlights, whilst Astra, Zafira and Vectra models with AFL additionally feature more powerful xenon headlights with dynamic beam-levelling, high pressure washers and the 'Motorway light' function.

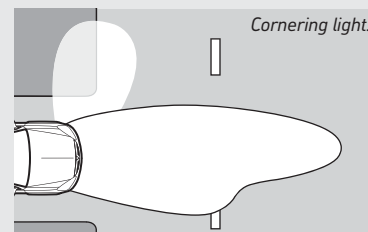

The 'Cornering light' uses an additional bulb and reflector to project a beam of light approximately 90° to the direction of travel when required – for example when turning at junctions or even negotiating tight roundabouts.

The 'Curve light' function is activated by movements of the steering wheel and allows the headlight beam to move up to 15 degrees left or right of the straight ahead position. This ensures that the headlight beams are always aimed in the direction you're about to go – and not necessarily the direction the front of the car is already pointing in!

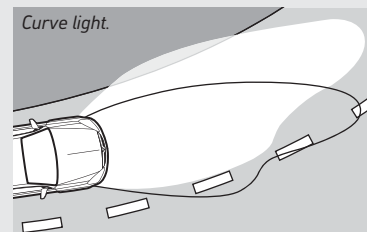

At speeds above 65mph, AFL's 'Motorway light' function raises the dipped headlight beam to extend the range of vision for increased safety at higher speed. The beam automatically returns to its normal position when the car falls below that speed.

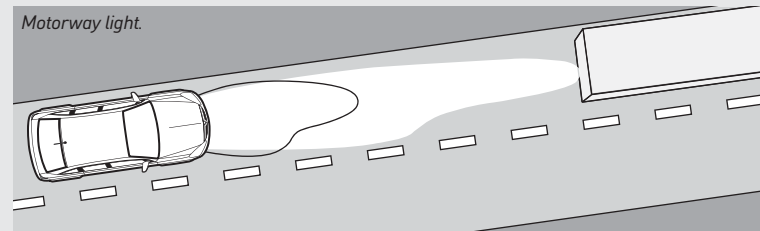

Please note:

Not all of these features are available on all models. Please see model pages for details.

Electronic Stability Programme (ESP)

Electronic Stability Programme has been developed to help the driver maintain control in adverse or emergency situations. ESP compares the direction of the front and rear of the vehicle compared to the driver's steering wheel input. If either the front or rear of the vehicle begins to slide, ESP gently applies corrective braking to the appropriate individual road wheel, controlling and minimising the slide. ESP is utilised in conjunction with Traction Control to

promote safer driving under all road conditions. The latest generation of the system, ESP-plus is an advanced development which features an enhanced yaw compensation system for reducing understeer. This means that ESP-plus has the ability to apply corrective braking to all four road wheels if necessary; a clear advantage over the standard ESP system where only one wheel is retarded in any given situation.

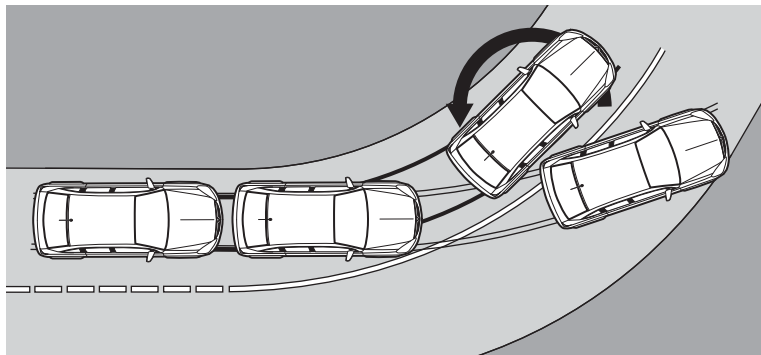

Hill Start Assist (HSA)

As its name suggests, Hill Start Assist helps prevent the vehicle from rolling down gradients of more than five percent immediately after the brake pedal has been released. Brake pressure is maintained for up to 1.5 seconds after the driver releases the pedal, the brakes are released as soon as the driver presses the accelerator and the car moves forward.

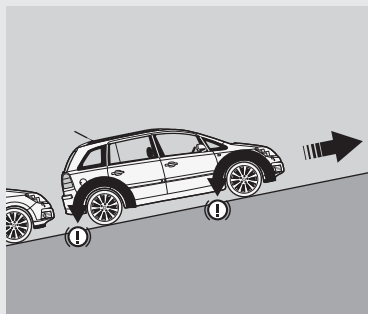

Interactive Driving System-plus (IDS-plus) with Continuous Damping Control (CDC)

The Interactive Driving System (IDS-plus) provides an even sportier driving experience thanks to electronic damping control together with sharper throttle and steering responses. Pressing the 'Sport' switch activates the CDC function which constantly adjusts the rate of damping on

each wheel – effectively stiffening the suspension when required. This means that the vehicle will exhibit a reduced rate of roll and pitch, making it more responsive during direction changes and more settled during the braking/turn-in/acceleration transition when cornering.

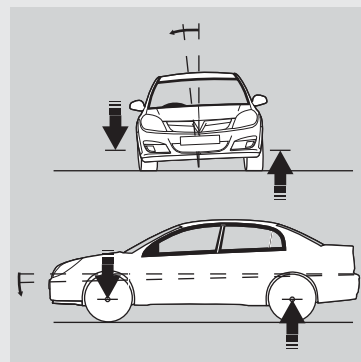

The Sport switch additionally provides a sharper engine response and crisper acceleration, while the power assisted steering is also adjusted, giving the driver a more positive initial turn-in to corners.

Vectra VXR models feature an updated system – IDS²-plus.



Vauxhall accessories are comprehensively researched and tested to ensure the same high quality as the vehicle for which they are intended making them the right choice for your Vauxhall. Not all accessories are listed, for further details please contact your Vauxhall retailer and ask for a copy of the Car Accessories brochure or Lo-call 0845 600 1500.



Alternatively, you can find all the details on our website www.vauxhall-accessories.com

VXR exterior styling



Corsa model illustrated features VXR styling front lower spoiler, side sills, rear lower skirt and roof spoiler and optional factory-fitted 17-inch alloy wheels.

	Total (inc.VAT)
VXR Corsa styling (painted and fitted*)	
Styling Pack • Front lower spoiler • Rear lower skirt • Rear roof spoiler • Side sills • Tyre inflation kit	£1399.00
Rear roof spoiler ¹	£299.00

	Total (inc.VAT)
VXR Tigra styling (painted and fitted*)	
Styling Pack • Front lower spoiler • Rear lower skirt • Rear lip spoiler • Side sills	£1399.00
Rear lip spoiler	£299.00

	Total (inc.VAT)
VXR Astra styling (painted and fitted*)	
Styling Pack A • Front lower spoiler • Rear lower skirt • Rear roof spoiler ¹ • Side sills	£1399.00
- Sport Hatch/hatchback/estate	£1150.00
Styling Pack B • Front lower spoiler • Rear lower skirt • Side sills	£1150.00
- Sport Hatch/hatchback/estate	£1150.00
Rear roof spoiler ¹	£299.00
- Sport Hatch/hatchback/estate	£299.00

	Total (inc.VAT)
VXR TwinTop styling (painted and fitted*)	
Styling Pack • Front lower spoiler • Rear lower skirt • Rear lip spoiler • Side sills	£1399.00
Rear lip spoiler	£299.00

	Total (inc.VAT)
VXR Meriva styling (painted and fitted*)	
Styling Pack • Front lower spoiler • Rear lower skirt • Rear roof spoiler • Side sills	£1399.00
Rear roof spoiler ¹	£299.00

	Total (inc.VAT)
VXR Zafira styling (painted and fitted*)	
Styling Pack • Front lower spoiler • Rear lower skirt • Rear roof spoiler • Side sills	£1399.00
Rear roof spoiler ¹	£299.00

	Total (inc.VAT)
VXR Vectra styling (painted and fitted*)	
Styling Pack • Front lower spoiler • Rear lower skirt • Rear spoiler • Side sills	£1399.00
Rear spoiler	£299.00
- hatchback/saloon/estate	£299.00

¹ = Not suitable for SRI models. Requires additional aerial adaptor at extra cost. Please consult your retailer for details.

Please note:

* Prices shown are a special fully fitted (and painted, where applicable) price at participating retailers only. Please check with your local Vauxhall retailer for details. All other prices exclude fitting.

It is advisable to ensure your insurance policy is adequate to cover additional fitted accessories.

Prices correct at time of going to press.

Vauxhall retailers regularly feature special offers from our Accessory range.

Speak to your local retailer for more details.

	Agila	Corsa	Meriva	Tigra	Astra	Zafira	Vectra	Antara
Exterior styling*								
Front lower spoiler		£432	£465		£385	£493	£468	£587
Front lower skirt extensions	£325			£442	£477			
Front and rear lower skirt inserts – matt aluminium-effect	£179							
Cross hatch grille with 'Irmischer' badge	£156	£225	£148	£177	from £299	£160	£229	£160
Cross hatch grille with aluminium upper and laser-etched 'Irmischer' badge	£206 ²	£193	£182	£196	from £356	£224	£264	£221
Stainless steel mesh grille – upper/lower set		£212					£212 ⁴	
Door mirror covers – chrome-effect – pair			£126		£156		£168	
Stainless steel door handle cover – pair		£61		£61	£61			
Stainless steel door handle cover – set of four		£102			£102	£102	£102	£102
Side sills – pair		£564	£605		£583	£583	from £561	
Stainless steel side running boards – pair								£622
Rear lower skirt			£458				from £483	
Rear bumper sports insert		£301 ³			from £309		£497	
Rear hood spoiler		£420						
Rear roof spoiler	£343		£340		£384	£397	from £366	£415
Rear wing spoiler				£449	from £399		from £459	
Up-rated and lowered spring kit		£283	£398	£359	£405	£416	£413	
Interior styling*								
'Irmischer' tax disc holder – anodised aluminium with twist-off back	£24	£24	£24	£24	£24	£24	£24	£24
Aluminium ventilation panel set – LH and RH vents					£67			
Interior door handle covers – matt chrome-effect – pair				£50	£50	£50		
Stainless steel interior door sill covers – pair					£160		£164	
Velour floor mats with heel protector and 'Irmischer' logo – set of four	£70	£70	£150	£61 ⁵	£70	£70	£70	£70
Aluminium pedals with 'Irmischer' logo (manual transmission)		£125	£125	£125	£125	£125	£125	
Three spoke steering wheels – leather/various effects ⁶		£287	£476	£476	£557	£557	£557	
Handbrake levers – various effects			£94	£94	£94		£94	
Foldable front centre armrest		£132			£132 ⁷	£132		
Sports silencers*								
Split oval design chrome-plated tailpipes		£358 ⁸		£324	£412	£402		
Twin round stainless steel tailpipes				£324				
Twin rectangular stainless steel tailpipes ⁹			£481				£475	
Dual branched split oval design chrome-plated tailpipes ⁹		£535			£554			
Dual branched twin split oval design chrome-plated tailpipes								£612
Dual branched twin rectangular stainless steel tailpipes ⁹							£901	

² = Matt aluminium-effect upper with moulded 'Irmischer' badge. ³ = Not to be fitted in conjunction with Flex-Fix® rear integrated carrier system. ⁴ = Not suitable for SRI Nav with Exterior Pack models. ⁵ = Set of two. ⁶ = Available with and without audio controls. ⁷ = Not suitable for vehicles with mobile phone system with Bluetooth® and only suitable for vehicles fitted with optional Smoker Pack. ⁸ = Not suitable for SRI models or models fitted with VXR Styling Pack One. SXi models require rear bumper sports insert. ⁹ = Must be used in conjunction with Irmischer rear bumper sports insert (Corsa and Astra) or rear lower skirt (Vectra). ¹⁰ = Certain wheel/tyre combinations may also require modification to the wheel arches.



Softstar
6J x 14 £604



Stila
6½J x 15 £667
6½J x 16 £738
8J x 18 £1443



Signa
6½J x 16 £738
8J x 18 £1443



GT Star
6½J x 16 £738
8J x 19 £1744



Sport Star
7J x 17 £1183¹⁰
8J x 18 £1640



Evo Star
7½J x 18 £1443
Vectra
8½J x 20 £1850
Antara
8½J x 20 £1876

Please note: Fully fitted price, excluding tyres, includes static wheel balancing. Fitting larger diameter wheels than standard will require the fitment of new tyres at extra cost. Many other styles and finishes are available, see website for details.

Safety

	Total (inc.VAT)
Rear parking distance sensor – bumper mounted (fitted*)	
– Astra/Zafira/Vectra	£399.00

Security

	Total (inc.VAT)
Steering wheel security bar	
– all models (except Antara)	£58.99

Practical

	Total (inc.VAT)
Hi-visibility vest	£5.49
Spare bulb kit ¹¹	
– all models except Agila/VXR8	£15.99
Fuel can – 5-litre – all models	£13.99
Stretch tow rope (2 tonne rated)	
– all models	£21.40
Fire extinguisher – all models – 1kg	£22.99
First aid kit	£9.49
Warning triangle	£11.90

Please note:

* Prices shown are a special fully fitted (and painted, where applicable) price at participating retailers only. Please check with your local Vauxhall retailer for details. All other prices exclude fitting.

It is advisable to ensure your insurance policy is adequate to cover additional fitted accessories.

Prices correct at time of going to press.

Protection

	Total (inc.VAT)
Rubber floor mats (front pair)	
– Corsa/Meriva/Tigra/Astra/Astra TwinTop/Zafira/Vectra	£20.49
Rubber floor mats (rear pair)	
– Corsa/Meriva/Astra/Astra TwinTop/Vectra	from £14.80
Rubber floor mats (set of four)	
– Agila	£34.99
– Zafira (second/third row)	£20.49
– Antara	£36.99
Economy floor mats (set of four)	
– all models except Antara/VXR8	£18.91
Velour floor mats (set of four; Zafira set of six)	
– all models except VXR8	£40.95
Deluxe velour floor mats (set of four)	
– Meriva/Astra/Astra TwinTop/Zafira (set of six)/Vectra	from £49.99
Contoured velour floor mats (set of four)	
– Meriva/Astra/Vectra	from £54.99
Dog guard (fitted*) ¹²	
– Meriva (behind front seats only)/Astra estate/Vectra estate	£103.85
– Zafira	£132.85
Space divider grid (for use with dog guard)	
– Astra estate/Vectra estate	£87.70
– Zafira	£116.30
FlexOrganiser® divider mesh – Antara	£87.54
Load-restraining floor net	
– Astra estate/Zafira/Vectra	£27.50
Bootliner – flexible liner with storage bag	
– Tigra	£67.99
Cargo liner – rigid moulded plastic liner	
– Agila	£34.99
– Corsa/Meriva/Astra/Sport Hatch/Zafira/Vectra/Antara	£49.99
Cargo liner – reversible anti-slip – Antara	£78.00
Headlight protectors – standard	
– Corsa/Tigra/Astra/Zafira/Meriva (includes continental touring convertor decals)	£38.99
Headlight protectors – carbon fibre-effect	
– Corsa/Meriva/Tigra/Astra/Zafira/Vectra	£38.99



Floor mat sets from: **£18.91**

	Total (inc.VAT)
Mudflaps (set of four – fitted*) ¹³	
– all models except Tigra/Astra TwinTop/VXR8	£75.00

Windbreak	
– Tigra	£161.99
– Astra TwinTop	£203.99

¹¹ = Not for vehicles with xenon headlights or Adaptive Forward Lighting.

¹² = Requires additional fitting kit at £99.86 (fitted*) for Astra estate and Zafira. £92.00 (fitted*) for Vectra estate, if vehicle is not equipped with the factory-fit vertical load restraining net option or dog guard fixing points.

¹³ = Not available on some models when fitted with exterior styling accessories.

Load carriers

	Total (inc.VAT)
Roof carrier system ¹⁴ – all models except Tigra/Astra TwinTop/VXR8	
Base carrier	
– all models except Antara	£98.70
– Antara	£128.08
Premium bicycle carrier	
– all models ¹⁵	£69.00
Side loading bicycle carrier ¹⁶	
– Corsa/Astra/Vectra	£149.99
– Agila/Meriva/Zafira	£179.99
Alloy ski/snowboard carrier-fixed ¹⁵	£56.00
Roof box	
– Agila	£170.38
Sport roof box (450 litres) ¹⁵	£279.65
Travel roof box (450 litres) ¹⁵	£251.99

¹⁴ = Roof carrier systems vary dependent on model. Please consult your retailer for details.

¹⁵ = Must be used in conjunction with a base carrier.
¹⁶ = Must be used in conjunction with a base carrier. Requires installation kit at extra cost of £16.68.

Tow bar carrier system – all models except Tigra/Antara/VXR8

Bicycle carrier – tow bar mounted two bicycle carrier with rear lights (excludes number plate)

£254.99
 Additional bicycle carrier (for use with two bicycle carrier) – all models except Corsa £69.40



Sport roof box: **£279.65**

Mobile phones/Navigation

	Total (inc.VAT)
Hands-free Bluetooth® mobile phone cradle – only available with factory-fit option on Corsa/ Meriva/Astra/Zafira/Vectra/Antara. Suitable for the following mobile phones:	
– Motorola V400/500/525/550/600/620/635/ L2/L6/L7/SLVR	
– Nokia 3100/6100/6020/6021/6151/6220/6230/ 6233/6234/6310(i)/6610/6820/7210/7250(i)	
– Siemens C65/CX65/M55/M65/S55/S65/S68/C55/ CX70/SP65/C75/CX75/M75/S75	
– Sony-Ericsson K510i/K610i/K700i/K750i/K800i/T610/ T630/W310i/W510i/W700i/W800i/W810i	
	from £101.99

Interior

	Total (inc.VAT)
Sunblinds – rear doors (pair)	
– Agila/Antara	£62.90
Sunblind – tailgate	
– Agila	£70.10
Sunblinds – tailgate and side glass set	
– Antara	£76.50

Essential accessory packs

	Total (inc.VAT and fitting*)
Travel Pack – First aid kit/Warning triangle/ Hi-visibility vest	
– all models	£25.00
Protection Pack – Velour mats (four)/ Mudflaps (four)/Cargo liner	
– all models except Agila/Tigra/Astra TwinTop/ VXR8	£159.00
– Agila	£145.00
Protection Pack – Velour mats/Windbreak	
– Tigra	£199.00
Protection Pack – Deluxe velour mats/Windbreak	
– Astra TwinTop	£249.00

Child seats¹⁷ – all models except VXR8

	Total (inc.VAT)
Vauxhall child seats – all models except VXR8	
Vauxhall BABY-SAFE (0-13kg/birth to 15 months)	£89.36
Vauxhall DUO ISOFIX (9-18kg/9 months to 4 years)	£200.16
Vauxhall KID (15-36kg/4 to 12 years)	£75.95
Vauxhall baby mirror – all models except VXR8	£12.80

¹⁷ = Restrictions apply to the use of child seats, please consult your Vauxhall retailer or request a copy of the Child seats brochure.



Child seats from: **£75.95**

Towing

	Total (inc.VAT)
Corsa	
Detachable tow bar (fitted*)	
– 12N electrics	£460.00
Meriva	
Detachable tow bar (fitted*)	
– 12N electrics	£460.00
– 12N/12S electrics	£521.62
Towing mirrors (pair)	£132.60
Astra¹⁸	
Fixed tow bar (fitted*)	
– 12N electrics	£240.58
– 12N/12S electrics	£322.27
– 13-pin electrics	£282.95
Detachable tow bar (Sport Hatch/hatch) (fitted*)	
– 12N electrics	£460.00
– 12N/12S electrics	£478.29
– 13-pin electrics	£438.95
Detachable tow bar (estate) (fitted*)	
– 12N electrics	£460.00
– 12N/12S electrics	£533.28
– 13-pin electrics	£493.95
Astra TwinTop	
Detachable tow bar (fitted*)	
– 12N electrics	£460.00
– 12N/12S electrics	£505.28
– 13-pin electrics	£465.95
Towing mirrors (pair)	£132.60



Towing mirrors from: **£132.60 (pair)**

	Total (inc.VAT)
Zafira	
Fixed tow bar (fitted*)	
– 12N electrics	£332.57
– 12N/12S electrics	£414.28
– 13-pin electrics	£374.95
Detachable tow bar (fitted*)	
– 12N electrics	£460.00
– 12N/12S electrics	£539.28
– 13-pin electrics	£499.96
Vectra	
Fixed tow bar (hatch/saloon) (fitted*)	
– 12N electrics	£302.29
– 12N/12S electrics	£381.00
– 13-pin electrics	£349.96
Fixed tow bar (estate) (fitted*)	
– 12N electrics	£296.28
– 12N/12S electrics	£375.00
– 13-pin electrics	£343.95
Detachable tow bar (hatch/saloon) (fitted*)	
– 12N electrics	£460.00
– 12N/12S electrics	£513.00
– 13-pin electrics	£481.96
Detachable tow bar (estate) (fitted*)	
– 12N electrics	£460.00
– 12N/12S electrics	£558.00
– 13-pin electrics	£526.95
13-pin to 7-pin adaptor for 12N/12S electrics (estate) (for use with factory-fitted retractable tow bar)	£51.00
Towing mirrors (pair)	£132.60
Antara	
Detachable tow bar	
– 12N electrics (fitted)	£460.00
– 13-pin electrics	£812.22
Towing mirrors (pair)	£132.60

¹⁸ = Astra 1.4/1.6 models require additional components at extra cost. Please consult your retailer for further details and prices.

Our commitment to innovation, quality and reliability helps make every Vauxhall both enjoyable to drive and easy to live with. Invest in a new Vauxhall, however, and you'll get far more than a great drive. You also gain access to a range of customer-led products and services that set high standards for customer care and support.

Customer Care Commitment

For added peace of mind, Vauxhall has an innovative Customer Care Commitment* that offers the following:

- A one-year unlimited mileage manufacturer's warranty
- Second and third year no-fee customer option warranty up to 60,000 miles (100,000 miles Vivaro/Movano combi models) from first registration
- Vauxhall Assistance for 12 months from first registration
- Six years body panel anti-perforation warranty

* *Warranty is only on vehicles sourced from Vauxhall Motors Ltd. Terms and conditions apply – please see your Vauxhall retailer for details.*

Protecting the environment

Vauxhall's commitment to the environment is demonstrated by our products' many environmental awards. Further details, including new initiatives such as our innovative EcoFlex Scrap Allowance programme, are available on page 3. For even more information on Vauxhall's efforts to achieve an environmentally sustainable future, see www.vauxhall.co.uk/recycling

Vauxhall Assistance**

Vauxhall Assistance is provided automatically with every new Vauxhall for 12 months from first registration and covers everything from accident assistance, roadside recovery and 'at home' service to flat tyres. With Vauxhall Assistance help is literally just a free† phone call away, 24 hours a day, 365 days a year!

** *Conditions may apply to combi/minibus models.*

† *Mobile phone users will be charged at their standard tariff.*

In the event of an accident...

Vauxhall Accident Support helps keep you mobile following an accident. Benefits include scene-of-accident advice, message service, assistance with claims and vehicle recovery. For further details call **0800 010 304**.

Alternatively, details can be found on our website at www.vauxhall.co.uk

MasterFit

Vauxhall's MasterFit retailers offer a great service for owners of all Vauxhall cars. Value for money, regular offers and free check-ups, combined with the peace of mind that comes from using trained technicians and genuine parts, help keep your car in peak condition at all times. Every MasterFit retailer supports our customer promise:

- **Convenience** for our customers in every aspect of the MasterFit experience
 - **Professional** advice on what work is essential and what is desirable
 - **Value** assured by our monthly local price check
 - **Transparent** pricing and invoicing. Any amendments or variations to work will be agreed with the customer before it is started
 - **Latest diagnostic equipment** used on your Vauxhall to maintain its safety, reliability, emissions and performance
 - **Vehicle and software enhancements** advised on Vauxhall's database will be carried out free-of-charge
- www.vauxhall.co.uk/masterfit

For more product information

For a brochure on any Vauxhall model (up to a maximum of three per caller) or location of your nearest Vauxhall retailer please **Lo-call 0845 600 1500**. Alternatively, details can be found on our website at www.vauxhall.co.uk



MasterFit Service Plan



- Fixed monthly payments for the plan duration
- Easy to budget and interest-free
- Genuine parts fitted by trained technicians

Plus on Gold plans:

- Valet and courtesy car
- Full AA cover
- Engine flush and fuel treatments
- Litre of oil for top ups between services

Full details can be obtained from your local participating Vauxhall retailer.

Vauxhall Insurance only fits genuine replacement parts

Cover shaped to suit your car from Vauxhall

- Approved Vauxhall repair centres
- Genuine Vauxhall replacement parts
- Repairs guaranteed for three years
- Courtesy car when you use an approved repairer
- Keycare cover for lost or stolen keys

Buy online and SAVE UP TO 15%

www.vauxhall.co.uk/insurance

OR call for a quote on **0870 024 0240**

Lines open 8am – 8pm Monday to Friday 9am – 5pm Saturdays

We'll keep your car all Vauxhall

Maximum call charge from a BT landline is 8p per minute. Calls from other networks may vary.

Sureguard protection

Should you wish to enjoy Vauxhall Assistance for a full three years from first registration, then new Sureguard Assistance is for you. Both Warranty and Assistance products now come with the added peace of mind of Sureguard MOT Warranty. For details contact your Vauxhall retailer or call **0870 752 7020**.

	Sureguard Assistance (inc. MOT Warranty) 36 months††	Sureguard Warranty (includes Assistance and MOT Warranty)‡
		48 months††/ 60,000 miles††
New Agila / Corsa / Meriva	£139.00	£325.00
Astra / TwinTop / Zafira / Tigra	£139.00	£375.00
Vectra / Signum	£139.00	£425.00
Antara	£139.00	£599.00
Vivaro / Movano	£225.00	£635.00

Prices quoted include VAT or IPT (Sureguard Assistance only) at 17.5% and were correct at time of going to press but are subject to change without prior notice. †† From date of vehicle's first registration. Cover will expire at the end of the cover period/mileage limit whichever is the sooner. ‡ Assistance cover year 4 only.

Trust Vauxhall

Fleet Customer Services

Our dedicated support services for fleet managers includes factory demonstrators, a three-day test drive programme and information on whole life costs, company car taxation and finance. For further information please call **0870 010 0651**.

Vauxhall Rental

A nationwide network guarantees well prepared and maintained Vauxhalls for rental at competitive rates which include insurance and Vauxhall Assistance. For further information please call **0870 442 1567**.

Specialist Mobility advice

Motability accredited Vauxhall retailers can provide special mobility help and advice. Blue badge holders are entitled to very favourable discounts on new vehicles. Contact your local Motability accredited Vauxhall retailer or Freephone **0800 731 5267**.

Buying your car

GMAC offers one of the most comprehensive and competitive ranges of financing plans in the UK. Contact your local Vauxhall retailer for details or call the GMAC customer service centre on **0845 712 3444**.

Vauxhall Leasing

As Vauxhall's own contract hire and fleet management operation, Vauxhall Leasing provides a one-stop-shop for competitive car and van leasing solutions – for business users and private individuals. Working with the Vauxhall retailer network, we combine the support of a national contract with the convenience of a local contact. For further information, please see your local Vauxhall retailer or call us on **0870 737 2557**. Alternatively, you can visit our website at www.vauxhall-leasing.co.uk



- Save up to £1500* on a new Vauxhall with The GM Card
- 100 Rebate Points worth £100 when you use The GM Card for the first time
- Rebate Point saving is on top of any discount or offer negotiated with the Retailer
- Earn 3 Rebate Points (£3) for every £100 you spend

Typical 14.9% APR variable

To apply call **0845 746 2777** or visit www.gmcard.co.uk



When you have finished with this brochure please recycle it

The GM Platinum Card is issued by HFC Bank Limited and is available to persons aged 18 years or over and resident in the UK (or 21 and over in the Channel Islands) and is subject to status and conditions. Written quotations are available upon request from The GM Platinum Card, PO Box 3615, Birmingham B3 2RJ. The typical APR quoted is the rate for new customers. Rebate Points are earned on purchases using The GM Platinum Card. Rebate Points are not earned on Balance Transfers or Cash Advances. You earn money off a new Vauxhall/Saab by accumulating Rebate Points under the Rebate Points Programme. General Motors UK Limited is solely responsible for the operation of the Rebate Points Programme, which is subject to the Rebate Points Programme Rules. *You can redeem up to 2500 Rebate Points subject to the Model Line Maximum which will vary in amount in relation to different Vauxhall/Saab vehicle model lines and unlimited Partner Points. Rebate Points and unlimited Partner Points are redeemable as discounts on a new Vauxhall/Saab vehicle and must be redeemed four years from the issue date. Rebate Points may not be redeemed by Motability Contract Hire customers. The GM Card is a trading name and style of both HFC Bank Limited and General Motors UK Limited. HFC Bank registered in England No. 1117305. Registered Office: North Street, Winkfield, Windsor, Berkshire SL4 4TD is authorised and regulated by the Financial Services Authority. Member HSBC Group. HFC Bank Limited is not a member of the same group of companies as General Motors UK Limited, Saab GB Limited or GMAC UK plc. General Motors UK Limited, Registered Office: Griffin House, Osborne Road, Luton, Bedfordshire LU1 3YT. Registered in England number 135767. – CN6/0987.

Every effort has been made to ensure that the contents of this publication were accurate and up-to-date at the time of going to press (September 2008). The invoice price, including delivery to retailer factory-fitted options, accessories fitted by the retailer and number plates, is subject to VAT. The right is reserved to alter specifications and prices, and withdraw products from sale, without notice. Please note that Vauxhall retailers are not the agents of General Motors UK Limited and are not authorised to bind the Company by any specific or implied undertaking or representation. It is advisable to ensure that your motor insurance policy provides adequate cover for additional fitted options and accessories. As part of Vauxhall's policy of environmental care, this brochure is printed on paper manufactured using Elemental Chlorine Free pulps from specially farmed, sustainable timber resources. All rights reserved. No part of this publication may be reproduced in any form or by any means, without the prior written permission of General Motors UK Limited.

