



## 1 August 2017

### **Contents:**

**Model Year 2018 (pages 2-103)**

**Model Year 2017 (pink pages 2-104)**

# MY 2018

# Range pricing information

## Contents

Corsavan Prices	3
Corsavan Equipment/Options	4
Combo Prices	14
Combo Equipment/Options	18
Vivaro Prices	26
Vivaro Equipment/Options	30
Movano Prices	43
Movano Equipment/Options	56
Movano One-Invoice Approved Conversions	71
Glossary of Terms	75
Customer Care	76
Corsavan Specifications	77
Combo Specifications	78
Vivaro Specifications	81
Movano Specifications	86
Accessories	100

### Vauxhall on-the-road recommended retail prices (RRP)

To eliminate uncertainty about hidden costs incurred when buying a new commercial vehicle, Vauxhall publishes on-the-road prices and these are shown in the pricing tables within this price guide. The prices shown are manufacturer's recommended retail prices (RRP) unless otherwise stated, exclusive of VAT (currently at a rate of 20% which may be payable). These prices include the recommended cost of number plates, delivery to a Vauxhall Retailer of £583.33 (£700.00 including VAT), 12 months' Government Vehicle Excise Duty\* (shown on each model page) and the DVLA new vehicle first registration fee of £55.00\*.

**Please note:** The RRP does not include fuel supplied by the Retailer, motor insurance or any other goods or services supplied by agreement between the Retailer and customer.

\*Correct at time of publication.

### Price protection for all Vauxhalls

Order a new Vauxhall for build in the current model year (as confirmed by your Retailer) for delivery no more than three months in advance and the price you are quoted is the price you pay. This is irrespective of any subsequent price rises between placing your order and delivery of your new commercial vehicle, but you must take delivery as soon as the commercial vehicle is available. General Motors UK Limited is not liable for price adjustments caused by Government changes in the rate of VAT (currently 20%), Vehicle Excise Duty, DVLA new vehicle first registration fee or by any other applicable legislation or regulations.

# CORSAVAN PRICES



Model	Minimum Mass (kg)*	Payload (kg)*	Fuel economy mpg (litres/100km)#			CO <sub>2</sub> emissions (g/km)#	Price (£) exc. VAT	On-the-road RRP (£) exc. VAT
			Urban driving	Extra-urban driving	Combined figure			
<b>CORSAVAN (EURO 6)</b>								
1.2i (70PS)	1045	560	42.2 (6.7)	61.4 (4.6)	52.3 (5.4)	126	11830.00	<b>12708.33</b>
1.3CDTi (75PS) Start/Stop	1124	571	55.4 (5.1)	83.1 (3.4)	70.6 (4.0)	107	13080.00	<b>13958.33</b>
1.3CDTi (95PS) Start/Stop ecoTEC	1124	571	68.9 (4.1)	88.3 (3.2)	78.5 (3.6)	94	13530.00	<b>14408.33</b>
1.3CDTi (95PS) Start/Stop ecoTEC Easytronic	1124	581	70.6 (4.0)	91.1 (3.1)	83.1 (3.4)	91	14150.00	<b>15028.33</b>
<b>CORSAVAN SPORTIVE (EURO 6)</b>								
1.3CDTi (95PS) Start/Stop	1177	543	57.6 (4.9)	78.5 (3.6)	68.9 (4.1)	108	14530.00	<b>15408.33</b>

**Please note:** On-the-road recommended retail prices (RRP) include number plates and delivery to Retailer of £583.33 (exc. VAT), 12 months' Vehicle Excise Duty at £240.00 and new vehicle first registration fee of £55.00. Excludes fuel and insurance.

\* = For definitions please refer to Glossary of Terms.

# = Fuel consumption information is official government environmental data, tested in accordance with the relevant EU directive. Official EU-regulated test data is provided for comparison purposes and actual performance will depend on driving style, road conditions and other non-technical factors.

# CORSAVAN EQUIPMENT / OPTIONS

## SAFETY

	Corsavan	Sportive	Price (£) exc. VAT
<b>Airbags:</b> <ul style="list-style-type: none"> <li>• Driver's dual-stage airbag</li> <li>• Passenger's dual-stage airbag with deactivation switch</li> <li>• Side-impact airbags</li> <li>• Full-size-curtain airbags</li> </ul>	●	●	
<b>Seating:</b> <ul style="list-style-type: none"> <li>• Height-adjustable seat head restraints</li> <li>• Anti-submarining ramps – <i>Helps prevent occupants sliding underneath the lap belt during a collision.</i></li> </ul>	●	●	
<b>Seatbelts:</b> <ul style="list-style-type: none"> <li>• Inertia-reel lap and diagonal seatbelts</li> <li>• Height-adjustable seatbelts</li> <li>• Seatbelt pretensioner system – <i>Pretensioners tighten the seatbelt in the event of an accident limiting forward movement.</i></li> <li>• Seatbelt force limiters – <i>Reduces potential upper body injuries during a frontal impact.</i></li> <li>• Seatbelt unfastened audible warning and warning light</li> </ul>	●	●	
<b>Body:</b> <ul style="list-style-type: none"> <li>• Pedal release system – <i>Reduces potential injury to the driver's legs and feet during a severe frontal impact.</i></li> <li>• Laminated windscreen</li> <li>• Side-impact protection beams</li> <li>• Reinforced passenger safety cell</li> <li>• Fuel tank located ahead of rear axle</li> </ul>	●	●	
<b>Stability:</b> <p><i>Electronic Stability Programme-plus (ESP-plus) with traction control – Works in conjunction with the vehicle's electronic braking and engine systems to keep the vehicle stable in many different situations. ESP monitors a variety of inputs to determine when the vehicle starts to lose traction, it can then immediately respond by varying the brake pressure between up to three wheels and adjust the engine output to help correct the loss of traction and improve stability.</i></p> <p><i>Drag torque control – Helps maintain stability when suddenly lifting off the accelerator.</i></p>	●	●	
<b>Tyre pressure:</b> <ul style="list-style-type: none"> <li>• Tyre pressure monitoring system</li> </ul>	●	●	
<b>Braking:</b> <p><i>Four-channel Anti-lock Braking System (ABS) – Prevents the vehicle's wheels from locking up under heavy braking by momentarily reducing brake pressure at the appropriate wheel, ensuring that you can maintain control of the steering.</i></p> <p><i>Emergency brake assist – When emergency braking is detected the vehicle automatically applies the maximum possible braking assistance.</i></p> <p><i>Electronic brakeforce distribution – Automatically apportions the optimum braking force to each wheel.</i></p> <p><i>Hill start assist – Briefly maintains rear brake pressure to stop the vehicle rolling back on an incline.</i></p> <p><i>Cornering brake control / Straight line stability control – Senses the different speeds of each wheel and applies differing braking levels to each one to ensure the whole vehicle remains under control.</i></p>	●	●	

## SECURITY

<b>Features:</b> <ul style="list-style-type: none"> <li>• Electronic engine deadlock immobiliser</li> <li>• Steering column lock</li> <li>• Electronic theft protection for audio equipment</li> <li>• 'Key left in ignition' audible warning</li> <li>• Visible Vehicle Identification Number (VIN)</li> <li>• Locking wheel bolts for alloy wheels</li> </ul>	●	●	
<b>Remote control door locking (doors, tailgate and fuel flap):</b> <ul style="list-style-type: none"> <li>• Remote control door locking</li> <li>• Two folding keys with integral remote</li> <li>• Door deadlocks</li> </ul>	●	●	
<b>Security alarm system:</b> <ul style="list-style-type: none"> <li>• Remote control – <i>Operates in conjunction with central locking.</i></li> <li>• Tilt sensor</li> <li>• Thatcham approved</li> </ul> <p style="text-align: right;">Option code: XIC5</p>	○	○	220.00

● = Standard equipment.

# CORSAVAN EQUIPMENT / OPTIONS

## COMFORT AND SEATING

	Corsavan	Sportive	Price (£) exc. VAT
<b>Comfort:</b> <ul style="list-style-type: none"> <li>Steering column adjustable for reach and rake</li> <li>Leather-covered steering wheel (Sportive models)</li> <li>Floor-mounted handbrake lever</li> <li>Spot Shimmer black cloth seat trim (Standard models)</li> <li>Lace cloth seat trim (Sportive models)</li> <li>Height-adjustable seatbelts</li> </ul>	●	●	
<b>Seating:</b> <ul style="list-style-type: none"> <li>Reach</li> <li>Backrest recline</li> <li>Easy-entry seats with memory function</li> </ul>	●	●	
<ul style="list-style-type: none"> <li>Driver's seat height adjuster</li> </ul>	○	●	70.00
<ul style="list-style-type: none"> <li>Sports-style seats</li> </ul>		●	

## INTERIOR CONVENIENCE

<b>Accessory sockets:</b> <ul style="list-style-type: none"> <li>Facia-mounted 12-volt accessory socket</li> </ul>	●	●	
<b>Interior:</b> <ul style="list-style-type: none"> <li>Storage box on driver's side lower facia</li> <li>Illuminated glovebox with lid</li> <li>Coin holder</li> <li>Drinks holder in centre console</li> <li>Door pockets</li> <li>Dipping rear-view mirror</li> <li>Twin sunvisors, driver's with vanity mirror and cover</li> <li>Chrome-effect door handles and handbrake button</li> <li>Driver and passenger's tiltable assist handles</li> </ul>	●	●	
<ul style="list-style-type: none"> <li>Automatic anti-dazzle rear-view mirror</li> </ul>		●	
<b>Lighting:</b> <ul style="list-style-type: none"> <li>Centre fade up/fade down courtesy light</li> <li>Map reading lights</li> </ul>	●	●	
<ul style="list-style-type: none"> <li>Ambient lighting</li> </ul>		●	

● = Standard equipment. ○ = Optional at extra cost.

# CORSAVAN EQUIPMENT / OPTIONS

## DRIVER ASSISTANCE

	Corsavan	Sportive	Price (£) exc. VAT
<p><b>Driving Assistance Pack (deletes City mode steering):</b>  <i>A wide range of class-leading driver assistance and safety features are controlled by the front camera system.</i>  <b>Forward collision alert:</b>  <i>The system warns you when approaching another vehicle too quickly – operates at speeds above 25mph.</i>                      • Visual warnings – projected onto windscreen and shown in the instrument cluster • Audible warning                      • Sensitivity can be adjusted via a steering wheel mounted control  <b>Traffic sign recognition:</b>  <i>Detects and then displays speed limits, reducing uncertainty and the risk of speeding.</i>                      • Recognises different road signs, including temporary speed restrictions • Displays reminder in the instrument cluster  <b>Following distance indicator:</b>  <i>At speeds above 25mph indicates how many seconds you are behind the vehicle in front – helping you maintain a safe distance.</i>                      • Timings are shown in the instrument cluster  <b>Lane departure warning:</b>  <i>If the driver has not actively steered or signalled, the lane departure warning system warns when the car moves outside of lane markings at speeds above 37mph.</i>                      • Warning light in instrument cluster • Audible warning • Facia on/off switch                      – On Corsavan, Driving Assistance Pack is only available in conjunction with optional cruise control.                      Option code: OBG</p>	○	○	1110.00
<p>Cruise control, includes leather-covered steering wheel                      Option code: N34</p>	○	●	120.00
<p><b>Speed limiter:</b>                      • Choice of two speeds: 62mph / 68mph – Only available on 1.3CDTi (95PS) manual models.                      Option code: (62mph) KYK                      Option code: (68mph) KYL</p>	○		85.00
<p><b>Windscreen wipers:</b>                      • Two-speed windscreen wipers • Variable intermittent wipe • Electric screenwash • Intermittent rear windows wash/wipe                      • Rain-sensitive windscreen wipers</p>	●	●	
<p><b>Parking assistance:</b>                      • Rear parking distance sensors • Audible warning • Distance warning graphic showing in driver information display                      Option code: UD7</p>	○	○	260.00
<p>• Rear-view camera • Camera view appears in infotainment screen                      • Rear bumper and one-metre grid lines shown as reference points – Activated when reverse gear selected. Requires rear parking distance sensors and IntelliLink.                      Option code: UVC</p>		○	235.00

● = Standard equipment. ○ = Optional at extra cost.

# CORSAVAN EQUIPMENT / OPTIONS

## DRIVER INFORMATION

	Corsavan	Sportive	Price (£) exc. VAT
<b>Instrumentation:</b> • Speedometer • Rev counter • Fuel gauge with low fuel warning light • Fuel economy gauge • Coolant temperature warning light	●	●	
<b>ECO features:</b> • Shift-up indicator – Indicates when to change gear for optimum fuel economy.	●	●	
<b>Driver information display:</b> • Monochrome display located in instrument cluster • Odometer • Service-due indicator	●	●	
<b>Central fascia display:</b> • Audio information • Digital clock with automatic RDS time adjustment • Outside air temperature with ice warning function • Additional features and location dependent on infotainment unit (see Infotainment for details)	●	●	
<b>Warning indicators:</b> • Low oil level, low brake fluid, brake pad wear, battery, seatbelt warning, doors open, headlight / brake light failure and handbrake on	●	●	





## INFOTAINMENT

<b>CD 30 BT:</b> <i>Onboard features:</i> • CD/MP3 CD player • DAB digital radio • AM/FM stereo radio with 36-station presets • RDS with Traffic Programme • Four speakers • 20 watts per channel output <i>Media connections:</i> • USB connection with iPod control • Aux-in socket <i>Mobile phone portal:</i> • Bluetooth® connectivity • Handsfree calls via steering wheel controls • Vehicle microphone • Phone book access – <i>Contacts / last calls / missed calls etc. (features dependent on mobile phone)</i>	●	●	
<b>R4.0 IntelliLink touchscreen infotainment system:</b> <i>Onboard features:</i> • DAB digital radio • AM/FM stereo radio with 36-station presets • 7-inch fascia-mounted colour touchscreen • RDS with Traffic Programme • Four speakers • 20 watts per channel output <i>Media connections:</i> • USB connection with iPod control • Bluetooth® audio streaming (A2DP Profile) <i>Mobile phone portal:</i> • Bluetooth® connectivity • Handsfree calls via steering wheel controls • Vehicle microphone • Phone book access – <i>Contacts / last calls / missed calls etc. are mirrored on the display and are easily navigated using the touchscreen (features dependent on mobile phone)</i> Option code: CR03	○	○	<b>760.00</b>
<b>Additional features:</b> • Steering wheel mounted audio controls • Flexible roof-mounted aerial	●	●	

● = Standard equipment. ○ = Optional at extra cost.

# CORSAVAN EQUIPMENT / OPTIONS

## ONSTAR

					Corsavan	Sportive	Total (£) inc. VAT
							
Automatic Crash Response	Wi-Fi Hotspot	Smartphone App	Stolen Vehicle Assistance	Vehicle Diagnostics			
<p><b>Vauxhall OnStar – your personal on board assistant*</b></p> <p><i>Many brands talk about innovation as soon as they improve their cup holders but this innovative system, now available on selected models**, is revolutionary: 24/7, 365 days a year, Vauxhall OnStar puts you in touch with a trained advisor, not a machine. With OnStar you have access to a host of innovations, from Vehicle Diagnostics and Smartphone Function to a fully integrated 4G Wi-Fi Hotspot†. In the event of an accident, Vauxhall OnStar even automatically calls for help, for an incomparable feeling of safety.</i></p> <p><small>* = Includes 12 months of OnStar services from date of first registration and a 3 month/3 GB Wi-Fi free trial period (whichever comes first) effective from the date the customer accepts the nominated network operator Wi-Fi T's&amp;C's. Does not include destination download feature. Theft alert feature only operates on models fitted with security alarm system.</small></p> <p><small>** = The OnStar Services require activation and are subject to mobile network coverage and availability. Wi-Fi Hotspot service requires account with nominated network operator.</small></p> <p><small>† = 4G is subject to mobile network coverage and availability. Charges apply after the free trial period. The OnStar subscription packages could be different from the services included in the free trial package. Check <a href="http://www.vauxhall.co.uk/onstar">www.vauxhall.co.uk/onstar</a> for terms and conditions, details of availability, coverage and charges.</small></p>					○	○	<b>360.00</b>
					Option code: UE1		



○ = Optional at extra cost.



# CORSAVAN EQUIPMENT / OPTIONS

## HEATING AND VENTILATION

	Corsavan	Sportive	Price (£) exc. VAT
<b>Air blend heater:</b> • Four-speed fan • Illuminated controls • Four adjustable facia vents • Windscreen demist vents • Side window demist vents	●	●	
<b>Air conditioning:</b> • Air recirculation facility • Cabin particulate filter – <i>Removes dust, airborne particles and pollen</i> • Illuminated controls	○	●	435.00
<b>Electronic climate control:</b> • Incorporating air conditioning • Single-zone control • Six-speed fan • Advanced predictive logic control system using sun sensor • Cabin particulate filter • LCD temperature display • Automatic air direction and fan speed with manual override • Illuminated controls • Pollen filter – <i>On Corsavan, only in conjunction with air conditioning.</i>	○	○	360.00
<b>Winter Pack:</b> • Heated leather-covered steering wheel • Heated seats – <i>On Corsavan, only available in conjunction with cruise control.</i>	○	○	205.00

## LOAD ACCESS

<b>Rear glazed tailgate:</b> • Heated rear window with wash/wipe facility • Interior tailgate handle	●	●	
---	---	---	--

## LOAD RESTRAINT / PROTECTION

<b>Load anchorage:</b> • Load restraint lashing eyes	●	●	
• Cargo net	○	○	35.00
• Fixing points for cargo net	○	○	35.00
<b>Load lining:</b> • Half-height plastic side load lining panels	●	●	
<b>Bulkhead:</b> • Half-height steel bulkhead	●	●	
Load area rubber floor mat	○	○	55.00
Upper load restraint mesh	○	○	75.00
Load compartment cover	○	○	55.00
Illuminated load area	●	●	

● = Standard equipment. ○ = Optional at extra cost.

**Please note:** The air conditioning in vehicles with N1 type approval relies upon fluorinated greenhouse gases (R134a) for its functioning. The front system contains a quantity of overall 580g of R 134a, which corresponds to a CO<sub>2</sub> equivalent of 0.83 tons. The front and rear system contains a quantity of overall 890g of R 134a, which corresponds to a CO<sub>2</sub> equivalent of 1.27 tons. The global warming potential amounts to 1430. Information acc. to R (EU) No. 517/2014.

# CORSAVAN EQUIPMENT / OPTIONS

## EXTERIOR CONVENIENCE / STYLING

	Corsavan	Sportive	Price (£) exc. VAT
<b>Windows:</b>			
• Heated windscreen	○	●	100.00
• Electrically operated windows • Tinted windows • Heated rear window	●	●	
<b>Door mirrors:</b>			
• Foldable electrically adjustable door mirrors – <i>Heated on Sportive models.</i> • Wide-angle mirror on driver's side	●	●	
• Body colour door mirrors		●	





## EXTERIOR LIGHTING

<b>Standard lighting:</b>		
• Halogen headlights • Welcome lighting • Lights-on audible warning • Electric headlight beam levelling • Reversing lights • Hazard warning lights	●	●
• Rear fog light • Adaptive brake lights • High-level LED centre brake light • Side-repeat indicators • Daytime running lights – <i>LED on Sportive models.</i>		●
• Front fog lights – <i>With chrome-effect surround.</i>		●
Automatic lighting control		●

● = Standard equipment. ○ = Optional at extra cost.

# CORSAVAN EQUIPMENT / OPTIONS

## EXTERIOR COLOURS

		Corsavan	Sportive	Price (£) exc. VAT		
	<b>Summit White (GAZ)</b> • Solid paint		<b>Royal Blue (GEK)</b> • Solid paint	●	N/C	
	<b>Lava Red (GG7)</b> • Brilliant paint			○	N/C	<b>260.00</b>
	<b>Mineral Black (GB9)</b> • Two-coat metallic paint		<b>Satin Steel Grey (GF6)</b> • Two-coat metallic paint			
	<b>Sovereign Silver (GAN)</b> • Two-coat metallic paint		<b>Quantum Grey (GK3)</b> • Two-coat metallic paint	○	N/C	<b>390.00</b>
	<b>Darkmoon Blue (GDY)</b> • Two-coat metallic paint					

● = Standard equipment. ○ = Optional at extra cost. N/C = No-cost option.

The colours reproduced may vary slightly from the actual paint colour. As a result they should be used as a guide only. Your Vauxhall Retailer has a comprehensive display of our paint samples.

# CORSAVAN EQUIPMENT / OPTIONS



## WHEELS AND TYRES

	Corsavan	Sportive	Price (£) exc. VAT
Full-size steel spare wheel	●		
Steel space-saver spare wheel		●	
 <b>14-inch steel wheels with flush covers – Petrol models:</b> <ul style="list-style-type: none"> <li>• 185/70 R 14 tyres</li> <li>• Full-size steel spare wheel</li> </ul>	●		
 <b>15-inch steel wheels with flush covers – Diesel models:</b> <ul style="list-style-type: none"> <li>• 185/65 R 15 tyres</li> <li>• Full-size steel spare wheel</li> </ul>	●		
 <b>16-inch alloy wheels:</b> <ul style="list-style-type: none"> <li>• 195/55 R 16 tyres</li> <li>• Steel space-saver spare wheel</li> </ul>		●	
 <b>16-inch black alloy wheels:</b> <ul style="list-style-type: none"> <li>• 195/55 R 16 tyres</li> <li>• Steel space-saver spare wheel</li> </ul>		○	110.00

Option code: RV5

● = Standard equipment. ○ = Optional at extra cost.

## TYRE RATINGS

Tyre size	Fuel efficiency group	Wet grip performance	External noise	
			Measured (dB)	Group
185/70 R 14	B	B	70	
185/65 R 15	B-C	B	69-70	
195/55 R 16	B-C	B	68-71	

Tyre rating according to EU Regulation 1222/2009

# CORSAVAN EQUIPMENT / OPTIONS

## MECHANICAL

	Corsavan	Sportive	Price (£) exc. VAT
<b>Standard features:</b> • Front-wheel drive • Transverse engine / gearbox • Gas-pressure dampers • Front anti-roll bar	●	●	
<b>Transmissions:</b> • Five-speed manual gearbox	●		
• Six-speed manual gearbox		●	
• Five-speed Easytronic transmission – Available on 1.3CDTi (95PS) ecoTEC models	○		See prices page
<b>Steering:</b> • Speed-sensitive electrically assisted power steering – <i>Variable rate on diesel models.</i> • Rack and pinion • City-mode button providing lighter steering at parking speeds – <i>Deleted if Driving Assistance Pack is specified.</i>	●	●	
<b>Turning circle:</b> <b>Kerb-to-kerb</b> All models                      10.6m (34.8ft.)			
<b>Brakes:</b> <i>Front ventilated disc brakes:</i> • 257mm diameter (1.2i models) • 284mm diameter (1.3CDTi models)	●	●	
<i>Rear drum brakes:</i> • 228mm diameter (all models)			
<b>Fuel tank:</b> • 45 litres (9.9 gallons) capacity	●	●	
<b>Electrical:</b> <i>Maintenance-free battery:</i> • 40Ah (1.2i models) • 60Ah (1.3CDTi models)	●	●	
<i>Alternator:</i> • 130A (1.2i models) • 140A (1.3CDTi models)			
<b>Front suspension:</b> • Independent lightweight MacPherson struts • Coil springs • Telescopic gas-pressure dampers	●	●	
<b>Rear suspension:</b> • Compound crank • Coil springs • Gas pressure dampers	●	●	

● = Standard equipment. ○ = Optional at extra cost.

# COMBO PANEL VAN PRICES

**BEST SMALL TRADES VAN**  
Vauxhall Combo 1.3CDTi  
2300LH1 95ps Eu6  
ecoFlex S/Stop



Model	Minimum Mass (kg)*	Payload (kg)*	Fuel economy mpg (litres/100km)#			CO <sub>2</sub> emissions (g/km)#	Price (£) exc. VAT	On-the-road RRP (£) exc. VAT
			Urban driving	Extra-urban driving	Combined figure			
<b>L1 H1 PANEL VAN (EURO 6)</b>								
2000 1.4i (95PS) Start/Stop	1355	740	30.7 (9.2)	49.6 (5.7)	40.4 (7.0)	163	14340.00	<b>15218.33</b>
2000 1.3CDTi (95PS)	1365	740	43.5 (6.5)	67.3 (4.2)	56.5 (5.0)	133	15625.00	<b>16503.33</b>
2000 1.3CDTi (95PS) Start/Stop	1365	740	52.3 (5.4)	68.9 (4.1)	61.4 (4.6)	120	15910.00	<b>16788.33</b>
2000 1.6CDTi (105PS)	1395	768	44.8 (6.3)	64.2 (4.4)	55.4 (5.1)	134	16615.00	<b>17493.33</b>
2000 1.6CDTi (105PS) Start/Stop	1395	768	53.3 (5.3)	68.9 (4.1)	62.8 (4.5)	120	16900.00	<b>17778.33</b>
2300 1.3CDTi (95PS)	1395	990	43.5 (6.5)	67.3 (4.2)	56.5 (5.0)	133	15820.00	<b>16698.33</b>
2300 1.3CDTi (95PS) Start/Stop	1395	990	52.3 (5.4)	68.9 (4.1)	61.4 (4.6)	120	16105.00	<b>16983.33</b>
2300 1.6CDTi (105PS)	1465	1018	43.5 (6.5)	64.2 (4.4)	54.3 (5.2)	135	16810.00	<b>17688.33</b>
2300 1.6CDTi (105PS) Start/Stop	1465	1018	53.3 (5.3)	67.3 (4.2)	61.4 (4.6)	121	17095.00	<b>17973.33</b>
<b>L1 H1 SPORTIVE PANEL VAN (EURO 6)</b>								
2000 1.3CDTi (95PS)	1365	695	43.5 (6.5)	67.3 (4.2)	56.5 (5.0)	133	16895.00	<b>17773.33</b>
2000 1.3CDTi (95PS) Start/Stop	1365	695	52.3 (5.4)	68.9 (4.1)	61.4 (4.6)	120	17180.00	<b>18058.33</b>
2000 1.6CDTi (105PS) Start/Stop	1395	723	53.3 (5.3)	68.9 (4.1)	62.8 (4.5)	120	18170.00	<b>19048.33</b>
2300 1.3CDTi (95PS)	1395	945	43.5 (6.5)	67.3 (4.2)	56.5 (5.0)	133	17090.00	<b>17968.33</b>
2300 1.3CDTi (95PS) Start/Stop	1395	945	52.3 (5.4)	68.9 (4.1)	61.4 (4.6)	120	17375.00	<b>18253.33</b>
2300 1.6CDTi (105PS) Start/Stop	1465	973	53.3 (5.3)	67.3 (4.2)	61.4 (4.6)	121	18365.00	<b>19243.33</b>
<b>L1 H2 PANEL VAN (EURO 6)</b>								
2000 1.6CDTi (105PS) Start/Stop	1445	740	53.3 (5.3)	60.1 (4.7)	57.6 (4.9)	131	17650.00	<b>18528.33</b>
2300 1.6CDTi (105PS) Start/Stop	1475	1018	53.3 (5.3)	60.1 (4.7)	57.6 (4.9)	131	17845.00	<b>18723.33</b>
<b>L1 H2 SPORTIVE PANEL VAN (EURO 6)</b>								
2000 1.6CDTi (105PS) Start/Stop	1445	695	53.3 (5.3)	60.1 (4.7)	57.6 (4.9)	131	18920.00	<b>19798.33</b>
2300 1.6CDTi (105PS) Start/Stop	1475	973	53.3 (5.3)	60.1 (4.7)	57.6 (4.9)	131	19115.00	<b>19993.33</b>

**Please note:** On-the-road recommended retail prices (RRP) include number plates and delivery to Retailer of £583.33 (exc. VAT), 12 months' Vehicle Excise Duty at £240.00 and new vehicle first registration fee of £55.00. Excludes fuel and insurance.

\* = For definitions please refer to Glossary of Terms.

# = Fuel consumption information is official government environmental data, tested in accordance with the relevant EU directive. Official EU-regulated test data is provided for comparison purposes and actual performance will depend on driving style, road conditions and other non-technical factors.

# COMBO PANEL VAN PRICES



Model	Minimum Mass (kg)*	Payload (kg)*	Fuel economy mpg (litres/100km)#			CO <sub>2</sub> emissions (g/km)#	Price (£) exc. VAT	On-the-road RRP (£) exc. VAT
			Urban driving	Extra-urban driving	Combined figure			
<b>L2 H1 PANEL VAN (EURO 6)</b>								
2300 1.4i (95PS) Start/Stop	1360	920	30.7 (9.2)	49.6 (5.7)	40.4 (7.0)	163	15340.00	<b>16218.33</b>
2300 1.3CDTi (95PS)	1460	990	42.8 (6.6)	65.7 (4.3)	55.4 (5.1)	136	16625.00	<b>17503.33</b>
2300 1.3CDTi (95PS) Start/Stop	1460	990	51.4 (5.5)	67.3 (4.2)	60.1 (4.7)	123	16910.00	<b>17788.33</b>
2300 1.6CDTi (105PS)	1505	1018	43.5 (6.5)	64.2 (4.4)	54.3 (5.2)	135	17615.00	<b>18493.33</b>
2300 1.6CDTi (105PS) Start/Stop	1505	1018	53.3 (5.3)	67.3 (4.2)	61.4 (4.6)	121	17900.00	<b>18778.33</b>
<b>L2 H1 SPORTIVE PANEL VAN (EURO 6)</b>								
2300 1.3CDTi (95PS)	1460	960	42.8 (6.6)	65.7 (4.3)	55.4 (5.1)	136	17710.00	<b>18588.33</b>
2300 1.3CDTi (95PS) Start/Stop	1460	960	51.4 (5.5)	67.3 (4.2)	60.1 (4.7)	123	17995.00	<b>18873.33</b>
2300 1.6CDTi (105PS) Start/Stop	1505	988	53.3 (5.3)	67.3 (4.2)	61.4 (4.6)	121	18985.00	<b>19863.33</b>
<b>L2 H2 PANEL VAN (EURO 6)</b>								
2300 1.6CDTi (105PS) Start/Stop	1535	1018	50.4 (5.6)	60.1 (4.7)	56.5 (5.0)	133	18900.00	<b>19778.33</b>

**Please note:** On-the-road recommended retail prices (RRP) include number plates and delivery to Retailer of £583.33 (exc. VAT), 12 months' Vehicle Excise Duty at £240.00 and new vehicle first registration fee of £55.00. Excludes fuel and insurance.

\* = For definitions please refer to Glossary of Terms.

# = Fuel consumption information is official government environmental data, tested in accordance with the relevant EU directive. Official EU-regulated test data is provided for comparison purposes and actual performance will depend on driving style, road conditions and other non-technical factors.

# COMBO CREW VAN PRICES



Model	Minimum Mass (kg)*	Payload (kg)*	Fuel economy mpg (litres/100km)#			CO <sub>2</sub> emissions (g/km)#	Price (£) exc. VAT	On-the-road RRP (£) exc. VAT
			Urban driving	Extra-urban driving	Combined figure			
<b>L1 H1 CREW VAN (EURO 6)</b>								
2300 1.3CDTi (95PS)	1485	804	42.8 (6.6)	65.7 (4.3)	55.4 (5.1)	136	16620.00	<b>17498.33</b>
2300 1.3CDTi (95PS) Start/Stop	1485	804	51.4 (5.5)	67.3 (4.2)	60.1 (4.7)	123	16905.00	<b>17783.33</b>
2300 1.6CDTi (105PS)	1505	804	44.1 (6.4)	62.8 (4.5)	54.3 (5.2)	136	17610.00	<b>18488.33</b>
2300 1.6CDTi (105PS) Start/Stop	1505	804	54.3 (5.2)	65.7 (4.3)	61.4 (4.6)	122	17895.00	<b>18773.33</b>
<b>L1 H1 SPORTIVE CREW VAN (EURO 6)</b>								
2300 1.3CDTi (95PS)	1485	784	42.8 (6.6)	65.7 (4.3)	55.4 (5.1)	136	17705.00	<b>18583.33</b>
2300 1.3CDTi (95PS) Start/Stop	1485	784	51.4 (5.5)	67.3 (4.2)	60.1 (4.7)	123	17990.00	<b>18868.33</b>
2300 1.6CDTi (105PS) Start/Stop	1505	784	54.3 (5.2)	65.7 (4.3)	61.4 (4.6)	122	18980.00	<b>19858.33</b>
<b>L2 H1 CREW VAN (EURO 6)</b>								
2300 1.3CDTi (95PS)	1505	804	42.8 (6.6)	65.7 (4.3)	55.4 (5.1)	136	17425.00	<b>18303.33</b>
2300 1.3CDTi (95PS) Start/Stop	1505	804	51.4 (5.5)	67.3 (4.2)	60.1 (4.7)	123	17710.00	<b>18588.33</b>
2300 1.6CDTi (105PS)	1600	804	43.5 (6.5)	61.4 (4.6)	53.3 (5.3)	139	18415.00	<b>19293.33</b>
2300 1.6CDTi (105PS) Start/Stop	1600	804	53.3 (5.3)	64.2 (4.4)	60.1 (4.7)	125	18700.00	<b>19578.33</b>
<b>L2 H1 SPORTIVE CREW VAN (EURO 6)</b>								
2300 1.3CDTi (95PS)	1505	784	42.8 (6.6)	65.7 (4.3)	55.4 (5.1)	136	18510.00	<b>19388.33</b>
2300 1.3CDTi (95PS) Start/Stop	1505	784	51.4 (5.5)	67.3 (4.2)	60.1 (4.7)	123	18795.00	<b>19673.33</b>
2300 1.6CDTi (105PS) Start/Stop	1600	784	53.3 (5.3)	64.2 (4.4)	60.1 (4.7)	125	19785.00	<b>20663.33</b>

Model	Minimum Mass (kg)*	Payload (kg)*	Fuel economy mpg (litres/100km)#			CO <sub>2</sub> emissions (g/km)#	Price (£) exc. VAT	On-the-road RRP (£) inc. VAT
			Urban driving	Extra-urban driving	Combined figure			
<b>L1 H1 GLAZED CREW VAN (EURO 6)</b>								
2300 1.3CDTi (95PS)	1485	764	42.8 (6.6)	65.7 (4.3)	55.4 (5.1)	136	16820.00	<b>21179.00</b>
2300 1.3CDTi (95PS) Start/Stop	1485	764	51.4 (5.5)	67.3 (4.2)	60.1 (4.7)	123	17105.00	<b>21521.00</b>
2300 1.6CDTi (105PS) Start/Stop	1505	764	54.3 (5.2)	65.7 (4.3)	61.4 (4.6)	122	18095.00	<b>22709.00</b>
<b>L2 H1 GLAZED CREW VAN (EURO 6)</b>								
2300 1.3CDTi (95PS)	1505	764	42.8 (6.6)	65.7 (4.3)	55.4 (5.1)	136	17625.00	<b>22145.00</b>
2300 1.3CDTi (95PS) Start/Stop	1505	764	51.4 (5.5)	67.3 (4.2)	60.1 (4.7)	123	17910.00	<b>22487.00</b>
2300 1.6CDTi (105PS) Start/Stop	1600	764	53.3 (5.3)	64.2 (4.4)	60.1 (4.7)	125	18900.00	<b>23675.00</b>

**Please note:** On-the-road recommended retail prices (RRP) include number plates and delivery to Retailer of £583.33 (exc. VAT), 12 months' Vehicle Excise Duty at £240.00 and new vehicle first registration fee of £55.00. Excludes fuel and insurance.

\* = For definitions please refer to Glossary of Terms.

# = Fuel consumption information is official government environmental data, tested in accordance with the relevant EU directive. Official EU-regulated test data is provided for comparison purposes and actual performance will depend on driving style, road conditions and other non-technical factors.



# COMBO COLORADO PRICES

Model	Minimum Mass (kg)*	Payload (kg)*	Fuel economy mpg (litres/100km)#			CO <sub>2</sub> emissions (g/km)#	Price (£) exc. VAT	On-the-road RRP (£) inc. VAT
			Urban driving	Extra-urban driving	Combined figure			
<b>L2 H1 COLORADO CREW VAN (EURO 6)</b>								
2300 1.3CDTi (95PS)	1505	814	42.8 (6.6)	65.7 (4.3)	55.4 (5.1)	136	18710.00	<b>23447.00</b>

**Please note:** On-the-road recommended retail prices (RRP) include number plates and delivery to Retailer of £583.33 (exc. VAT), 12 months' Vehicle Excise Duty at £240.00 and new vehicle first registration fee of £55.00. Excludes fuel and insurance.

\* = For definitions please refer to Glossary of Terms.

# = Fuel consumption information is official government environmental data, tested in accordance with the relevant EU directive. Official EU-regulated test data is provided for comparison purposes and actual performance will depend on driving style, road conditions and other non-technical factors.

The Combo Colorado is a fully glazed crew van without bulkhead suitable for conversion into a wheelchair accessible vehicle by a third-party Converter. The Colorado includes basic Type Approval for registration as a Category N\* Commercial Vehicle and 2nd stage Type Approval must be completed by the Converter to enable registration. Available as an L2 H1 the Colorado is fitted with the highly efficient and economical 1.3CDTi (95PS) engine and includes second-row seats and interior trim.

**Feature highlights:**

- Type-approved for Euro 6 Category N\* emissions
- Glazed between C- and D-pillars
- Air conditioning
- Two-coat metallic/Brilliant paint
- Body-coloured mirrors and bumpers
- Height-adjustable driver's seat with armrest and lumbar support
- Nearside and offside side-access doors with sliding windows
- Glazed tailgate with wash/wipe facility

\* = As a Category N Commercial Vehicle, the Colorado is subject to speed restrictions not applicable to a Passenger Vehicle. Please consult the DVSA website for further details.

# COMBO EQUIPMENT / OPTIONS

## SAFETY

	Combo	Sportive	Colorado	Price (£) exc. VAT
<b>Airbags:</b>	●	●	●	
• Driver's dual-stage airbag				
• Front passenger's airbag with deactivation switch	○	○	○	235.00
Option code: AK5				
• Front passenger's airbag with deactivation switch • Driver and front passenger's side-impact airbags	○	○	○	385.00
Option code: AJ7				
<b>Seating:</b>	●	●	●	
• Height-adjustable head restraints				
• Active safety head restraints – <i>Front seats only.</i>	○	○	○	45.00
Option code: AJF				
<b>Seatbelts:</b>	●	●	●	
• Inertia-reel lap and diagonal seatbelts • Height-adjustable front seatbelts • Seatbelt pretensioner system – <i>Pretensioners tighten the seatbelt in the event of an accident limiting forward movement.</i> • Front seatbelt force limiters – <i>Reduces potential upper body injuries during a frontal impact.</i> • Seatbelt unfastened audible warning and warning light				
<b>Body:</b>	●	●	●	
• Laminated windscreen • Side-impact protection beams • Reinforced passenger safety cell • Fuel tank located ahead of rear axle				
<b>Stability:</b>	●	●	●	
<i>Electronic Stability Programme-plus (ESP-plus) with traction control – Works in conjunction with the vehicle's electronic braking and engine systems to keep the vehicle stable in many different situations. ESP monitors a variety of inputs to determine when the vehicle starts to lose traction, it can then immediately respond by varying the brake pressure between up to three wheels and adjust the engine output to help correct the loss of traction and improve stability.</i>				
<i>Drag torque control – Helps maintain stability when suddenly lifting off the accelerator.</i>				
<b>Anti-lock braking:</b>	●	●	●	
<i>Four-channel Anti-lock Braking System (ABS) – Prevents the vehicle's wheels from locking up under heavy braking by momentarily reducing brake pressure at the appropriate wheel, ensuring that you can maintain control of the steering.</i>				
<i>Emergency brake assist – When emergency braking is detected the vehicle automatically applies the maximum possible braking assistance.</i>				
<i>Electronic brakeforce distribution – Automatically apportions the optimum braking force to each wheel.</i>				
<i>Hill start assist – Briefly maintains rear brake pressure to stop the vehicle rolling back on an incline.</i>				
<b>Fire protection system:</b>	●	●	●	
• Fire protection system • Fuel cut-off				

## SECURITY

<b>Features:</b>	●	●	●	
• Electronic engine deadlock immobiliser • Steering column lock • Electronic theft protection for audio equipment • 'Key left in ignition' audible warning				
• Lockable glovebox • Lockable fuel filler cap				
<b>Remote control door locking (doors, tailgate and fuel flap):</b>	●	●	●	
• Remote control door locking • Two folding keys with integral remote • Door deadlocks				
• Alarm pre-installation kit – <i>Accessory alarm available at extra cost.</i>	○	○	○	60.00
Option code: TJD				
• Third key	○	○	○	60.00
Option code: KTN				
• Third key with remote control – <i>Panel Vans only.</i>	○	○		85.00
Option code: Z1V				

● = Standard equipment. ○ = Optional at extra cost.

# COMBO EQUIPMENT / OPTIONS

## COMFORT AND SEATING

	Combo	Sportive	Colorado	Price (£) exc. VAT
<b>Comfort:</b> • Steering column adjustable for reach and rake • Floor-mounted handbrake lever • Cube cloth seat trim • Height-adjustable front seatbelts	●	●	●	
<b>Seating:</b> • Reach • Backrest recline	●	●	●	
• Driver's seat height adjuster • Armrest • Lumbar support – <i>Not available with vinyl seat trim.</i>	○	●	●	Option code: DCW 75.00
• Front passenger's seat with under cushion storage compartment – <i>Panel Van only. Not available with vinyl seat trim.</i>	○	○	○	Option code: BA8 35.00
<b>Rear seating – Crew Van:</b> • Three passenger rear seat • 'Fold and tumble' facility • 60/40 split seat back and cushion	●	●	●	
<b>Vinyl seat trim:</b> • Black vinyl seat trim – <i>Base models only. Not available with driver's seat height adjuster or front passenger's seat with under cushion storage compartment.</i>	○			Option code: TAiB 60.00

## INTERIOR CONVENIENCE

<b>Accessory sockets:</b> • Facia-mounted 12-volt accessory socket	●	●	●	
<b>Interior:</b> • Storage compartment on driver's side facia • Illuminated glovebox with lid • Door storage pockets • Dipping rear-view mirror – <i>When glazed bulkhead and glazed rear doors / tailgate are specified.</i> • Twin sunvisors, front passenger's with vanity mirror • Driver and front passenger's tiltable assist handles • Two coat hooks • Door armrests	●	●	●	
• Overhead shelf – <i>Standard on H2 and Crew Van models.</i>	○	●	●	Option code: VVM 40.00
• Rear side panel storage (fully trimmed L1, part trimmed L2) and 12-volt accessory socket – <i>Crew Van models.</i>	●	●	●	
<b>Lighting:</b> • Centre fade up/fade down courtesy light • Illuminated load area	●	●	●	
<b>Load Compartment Pack:</b> • Overhead shelf • PVC load floor covering • 12-volt accessory socket in load area • Removable load area courtesy light – <i>Panel Van only.</i>	○			Option code: LPVX 130.00
<b>Smoker Pack:</b> • Removable ashtray • Illuminated cigar lighter	○	○	○	Option code: DT4 55.00

## DRIVER ASSISTANCE

<b>Multi-function trip computer:</b> • Overall distance • Trip distance • Average fuel consumption • Instantaneous fuel consumption • Vehicle range based on remaining fuel • Distance and average speed since last reset	●	●	●	
<b>Windscreen wipers:</b> • Two-speed windscreen wipers • Variable intermittent wipe • Electric screenwash	●	●	●	
<b>Parking assistance:</b> • Rear parking distance sensors • Audible warning • Distance warning graphic shown in driver information display	○	○	○	Option code: UD7 205.00
Cruise control	○	○	○	Option code: K34 185.00

● = Standard equipment. ○ = Optional at extra cost.

# COMBO EQUIPMENT / OPTIONS

## DRIVER INFORMATION

	Combo	Sportive	Colorado	Price (£) exc. VAT
<b>Instrumentation:</b> • Speedometer • Rev counter • Trip odometer • Fuel gauge with low fuel warning light • Coolant temperature warning light	●	●	●	
<b>ECO features:</b> • Shift-up indicator – Indicates when to change gear for optimum fuel economy.	●	●	●	
<b>Driver information display:</b> • Monochrome display located in instrument cluster • Odometer • Service-due indicator	●	●	●	
<b>Central fascia display:</b> • Audio information • Digital clock with automatic RDS time adjustment • Outside air temperature with ice warning function • Additional features and location dependent on infotainment unit (see Infotainment for details)	●	●	●	
<b>Warning indicators:</b> • Low oil level, low brake fluid, brake pad wear, battery, seatbelt reminder, airbag failure / deactivation, charging system and emission control system failure	●	●	●	
<b>Driver Pack:</b> • CD/MP3 CD player / stereo radio / Bluetooth® connectivity for compatible mobile phones / aux-in socket / USB connectivity / AM/FM stereo radio with 24 station presets / RDS with Traffic Programme / steering wheel mounted audio controls • Leather-covered steering wheel • Leather-covered gear knob • Pre-installation for TomTom navigation system – Excludes sat nav / cradle. <i>Accessory sat nav and bespoke cradle combination available at extra cost.</i> Option code: LPW1	○	○	○	<b>670.00</b>

## INFOTAINMENT

<b>CD player / stereo radio:</b> <i>Onboard features:</i> • CD player • AM/FM stereo radio with 24-station presets • RDS with Traffic Programme • Four speakers • 20 watts per channel output	●	●	●	
<b>CD 50 multimedia:</b> <i>Onboard features:</i> • CD/MP3 CD player • AM/FM stereo radio with 24-station presets • RDS with Traffic Programme • Four speakers • 20 watts per channel output • Steering wheel mounted audio controls <i>Media connections:</i> • USB connection • Aux-in socket <i>Mobile phone portal:</i> • Bluetooth® connectivity • Vehicle microphone Option code: UGi	○	○	○	<b>495.00</b>
<b>Additional features:</b> • Flexible roof-mounted aerial	●	●	●	

● = Standard equipment. ○ = Optional at extra cost.

# COMBO EQUIPMENT / OPTIONS

## HEATING AND VENTILATION

	Combo	Sportive	Colorado	Price (£) exc. VAT
<b>Air blend heater:</b> • Four-speed fan • Illuminated controls • Four adjustable facia vents • Windscreen demist vents • Side window demist vents	●	●	●	
<b>Air conditioning:</b> • Air recirculation facility • Cabin particulate filter – <i>Removes dust, airborne particles and pollen.</i> • Illuminated controls – <i>Standard on Colorado models.</i>	○	●	●	600.00 Option code: C60
<b>Electronic climate control:</b> • Incorporating air conditioning • Single-zone control • Six-speed fan • Advanced predictive logic control system using sun sensor • Cabin particulate filter • LCD temperature display • Automatic air direction and fan speed with manual override • Illuminated controls • Pollen filter – <i>Mandates electrically adjustable / heated door mirrors with exterior temperature sensor at extra cost.</i>		○	○	840.00 Option code: C68

## SIDE ACCESS

<b>Nearside access:</b> • Nearside sliding side-access door • Unglazed – <i>Standard on L2 H1 models.</i>	▲	●		255.00
<b>Offside access:</b> • Offside sliding side-access door • Unglazed – <i>Standard on L2 H1 models.</i>		▲		200.00
<b>Nearside and offside access:</b> <b>Side-access doors:</b> • Nearside sliding side-access door • Unglazed • Offside sliding side-access door • Unglazed – <i>Standard on L2 and Crew Van models.</i>	▲			445.00
<b>Side-access panel / doors with fixed windows:</b> • Glazed nearside sliding side-access door • Glazed offside sliding side-access panel / door	▲	▲		300.00
<b>Side-access doors with sliding windows:</b> • Sliding windows to nearside sliding side-access door • Sliding window to offside sliding side-access door – <i>Standard on Glazed Crew Van.</i>	●		●	

## REAR ACCESS

<b>Rear doors:</b> • Asymmetric rear doors • Unglazed • 90°/180° opening – <i>Not available on Glazed Crew Van / Colorado models.</i>	●	●		
• Asymmetric rear doors • Glazed • 90°/180° opening • Heated windows • Wash/wipe facility – <i>Only available when bulkhead with window is specified. Not available on non-glazed Crew Van.</i>	○	○		155.00 Option code: J1X
<b>Tailgate:</b> • Glazed • Heated window • Wash/wipe facility – <i>H1 models only.</i> – <i>Only available when bulkhead with window is specified. Standard on Glazed Crew Van.</i>	○	○	●	135.00 Option code: J1U

● = Standard equipment. ○ = Optional at extra cost. ▲ = Please refer to ordering guide.

**Please note:** The air conditioning in vehicles with N1 type approval relies upon fluorinated greenhouse gases (R134a) for its functioning. The front system contains a quantity of overall 580g of R 134a, which corresponds to a CO<sub>2</sub> equivalent of 0.83 tons. The front and rear system contains a quantity of overall 890g of R 134a, which corresponds to a CO<sub>2</sub> equivalent of 1.27 tons. The global warming potential amounts to 1430. Information acc. to R (EU) No. 517/2014.

# COMBO EQUIPMENT / OPTIONS

## LOAD RESTRAINT / PROTECTION

	Combo	Sportive	Colorado	Price (£) exc. VAT
<b>Load anchorage:</b> • Load restraint lashing eyes – <i>Panel Van -6, Crew Van / Colorado -4.</i>	●	●	●	
<b>Bulkhead:</b> • Full-height steel bulkhead – <i>Soundproofed on Sportive models. Not available on Crew Van / Colorado models.</i>	●	●		
• Full-height steel bulkhead with window – <i>Only available when glazed rear doors / tailgate are specified. Not available on Crew Van / Colorado models.</i>	○	○		60.00
Option code: AX9				
• Protective ladder frame behind driver – <i>Base Panel Van only. In lieu of full-height steel bulkhead. Only available when Load Compartment Pack is specified.</i>	N/C			No-cost
• Full-width ladder frame bulkhead behind second-row seats – <i>Crew Vans only.</i>	N/C	N/C	N/C	No-cost
PVC load floor covering – <i>Not available on Crew Van models.</i>	○	●		45.00
Option code: VT9				
Carpeted load floor covering – <i>Crew Van models.</i>	●	●	●	
Internal ladder storage bars – <i>Panel Van only. Not available with Load Compartment Pack or rear roof flap.</i>	○	○		165.00
Option code: SOW				

## EXTERIOR CONVENIENCE / STYLING

Body side-protection mouldings	●	●	●	
Body colour door mirrors and bumpers		●	●	
<b>Windows:</b> • Electrically operated front windows • Tinted windows	●	●	●	
<b>Door mirrors:</b> • Foldable door mirrors • Wide-angle mirror on driver's side	●	●	●	
• Electrically adjustable / heated door mirrors	○	○	○	135.00
Option code: DL8				
• Electrically adjustable / heated door mirrors • Exterior temperature sensor	○	○	○	195.00
Option code: UGM				
<b>Winter Pack:</b> • Headlight washers • Front fog lights • Exterior temperature sensor • Electrically adjustable / heated door mirrors		○		265.00
Option code: LPW0				
Roof rails – <i>H1 Panel Van models only. Not available when the rear roof flap is specified.</i>	○	○		135.00
Option code: E2R				
Rear roof flap – <i>L1 H1 Panel Van models only. Only available when Load Compartment Pack is specified. Not available when roof rails or glazed tailgate options are specified</i>	○	○		410.00
Option code: AD3				









## EXTERIOR LIGHTING

<b>Standard lighting:</b> • Halogen headlights • Daytime running lights • Lights-on audible warning • Electric headlight beam levelling • Reversing light • Hazard warning lights • Rear fog light • High-level LED centre brake light • Side-repeat indicators	●	●	●	
• Front fog lights	○	○	○	115.00
Option code: T3U				

● = Standard equipment. ○ = Optional at extra cost. N/C = No-cost option.

# COMBO EQUIPMENT / OPTIONS

## EXTERIOR COLOURS





				Combo	Sportive	Colorado	Price (£) exc. VAT
	<b>Polar White (5PU)</b> • Solid paint		<b>Deep Blue (4DU)</b> • Solid paint	●	●	●	
	<b>Tomato Red (G6Z)</b> • Brilliant paint			○	N/C	N/C	260.00
	<b>Magnetic Silver (20U)</b> • Two-coat metallic paint		<b>Ruby Red (4VU)</b> • Two-coat metallic paint				
	<b>Twilight Blue (GTG)</b> • Two-coat metallic paint		<b>Marine Blue (4EU)</b> • Two-coat metallic paint	○	N/C	N/C	390.00
	<b>Midnight Black (3AU)</b> • Two-coat metallic paint		<b>Pepperdust (GJM)</b> • Two-coat metallic paint				

● = Standard equipment. ○ = Optional at extra cost. N/C = No-cost option.

The colours reproduced may vary slightly from the actual paint colour. As a result they should be used as a guide only. Your Vauxhall Retailer has a comprehensive display of our paint samples.

# COMBO EQUIPMENT / OPTIONS

## WHEELS AND TYRES

		Combo	Sportive	Colorado	Price (£) exc. VAT
	<b>15-inch steel wheels with centre covers – 2000 models (excluding 1.4i).</b> <ul style="list-style-type: none"> <li>• 185/65 R 15 tyres</li> <li>• Tyre inflation kit</li> </ul>	●			
	<b>15-inch steel wheels with full-diameter wheel trims – 2000 models.</b> <ul style="list-style-type: none"> <li>• 185/65 R 15 tyres</li> <li>• Tyre inflation kit</li> </ul>		●		
	<b>16-inch steel wheels with centre covers – 2300 and 1.4i models.</b> <ul style="list-style-type: none"> <li>• 195/65 R 16 tyres</li> <li>• Tyre inflation kit</li> </ul>	●			
	<b>16-inch steel wheels with full-diameter wheel trims – 2300 models.</b> <ul style="list-style-type: none"> <li>• 195/60 R 16 tyres</li> <li>• Tyre inflation kit</li> </ul>		●	●	
	<b>16-inch alloy wheels</b> <ul style="list-style-type: none"> <li>• 195/60 R 16 tyres</li> <li>• Tyre inflation kit</li> <li>• Locking wheel bolts</li> </ul>		○		405.00
					Option code: NWQ
<b>Winter tyres – Goodyear Ultragrip-7:</b> <ul style="list-style-type: none"> <li>• 195/65 R 15 – 2000 models.</li> <li>• 195/60 R 16 – 2300 models.</li> </ul>		○	○		235.00
Full-size spare wheel in lieu of tyre inflation kit		○	○		Option code: PHM
		○	○		Option code: QQ5
		N/C	N/C	N/C	No-cost

● = Standard equipment. ○ = Optional at extra cost. N/C = No-cost option.



# COMBO EQUIPMENT / OPTIONS

## MECHANICAL

	Combo	Sportive	Colorado	Price (£) exc. VAT	
<b>Standard features:</b>	●	●	●		
• Front-wheel drive • Transverse engine / gearbox					
<b>Transmissions:</b>	●	●	●		
• Five-speed manual gearbox (1.4i / 1.3CDTi models)					
• Six-speed manual gearbox (1.6CDTi models)	●	●	●		
<b>Steering:</b>					
• Hydraulic power-assisted rack and pinion system • Energy-absorbing steering column					
<b>Turning circle: Kerb-to-kerb</b>	●	●	●		
L1 11.3m (36.7ft.)					
L2 12.5m (41.0ft.)					
<b>Brakes:</b>					
<i>Front ventilated disc brakes:</i>					
• 284mm diameter (1.3CDTi / 1.6CDTi / 2000 models)					
• 305mm diameter (1.4i / 2300 models)	●	●	●		
<i>Rear self-adjusting drum brakes:</i>					
• 228mm diameter (1.3CDTi / 1.6CDTi)					
• 254mm diameter (1.4i)					
<b>Fuel tank:</b>	●	●	●		
• 60 litres (13.2 gallons) capacity					
<b>Electrical:</b>					
<i>Maintenance-free battery:</i>					
• 63Ah (1.4i / 1.3CDTi) • 72Ah (1.6CDTi)	●	●	●		
<i>Alternator:</i>					
• 105A (1.4i / 1.3CDTi) • 100A (1.6CDTi)					
• 120A – Models with air conditioning.					
• Uprated alternator					
	Option code: KX3	○	○	○	55.00
<b>Front suspension:</b>	●	●	●		
• Independent lightweight MacPherson struts • Coil springs • Telescopic gas-pressure dampers • Anti-roll bar					
<b>Rear suspension:</b>	●	●	●		
• Independent bi-link suspension • Coil springs • Gas pressure dampers • Anti-roll bar					

● = Standard equipment. ○ = Optional at extra cost.

## TYRE RATINGS

Tyre size	Fuel efficiency group	Wet grip performance	External noise	
			Measured (dB)	Group
185/65 R 15	C-E	A-C	68-69	
195/65 R 15	C-E	C-E	68-71	
195/60 R 16	C-E	B-C	70-72	

Tyre rating according to EU Regulation 1222/2009

# VIVARO PANEL VAN PRICES



Model	Minimum Mass (kg)*	Payload (kg)*	Fuel economy mpg (litres/100km)#			CO <sub>2</sub> emissions (g/km)#	Price (£) exc. VAT	On-the-road RRP (£) exc. VAT
			Urban driving	Extra-urban driving	Combined figure			
<b>L1 H1 PANEL VAN (EURO 6)</b>								
2700 1.6CDTi (95PS) BlueInjection	1800	1060	36.2 (7.8)	48.7 (5.8)	43.4 (6.5)	170	20970.00	<b>21848.33</b>
2700 1.6CDTi (95PS) S/S BlueInjection	1800	1060	39.2 (7.2)	50.4 (5.6)	46.3 (6.1)	160	21165.00	<b>22043.33</b>
2700 1.6CDTi (120PS) BlueInjection	1800	1060	36.2 (7.8)	48.7 (5.8)	43.4 (6.5)	170	21570.00	<b>22448.33</b>
2700 1.6CDTi BiTurbo (125PS) S/S ecoTEC BlueInjection	1818	1062	40.9 (6.9)	51.4 (5.5)	47.0 (6.0)	155	21970.00	<b>22848.33</b>
2900 1.6CDTi (95PS) BlueInjection	1800	1220	36.2 (7.8)	48.7 (5.8)	43.4 (6.5)	170	21470.00	<b>22348.33</b>
2900 1.6CDTi (95PS) S/S BlueInjection	1800	1220	39.2 (7.2)	50.4 (5.6)	46.3 (6.1)	160	21665.00	<b>22543.33</b>
2900 1.6CDTi (120PS) BlueInjection	1800	1220	36.2 (7.8)	48.7 (5.8)	43.4 (6.5)	170	22070.00	<b>22948.33</b>
2900 1.6CDTi BiTurbo (125PS) S/S ecoTEC BlueInjection	1818	1222	40.9 (6.9)	51.4 (5.5)	47.0 (6.0)	155	22470.00	<b>23348.33</b>
<b>L1 H1 SPORTIVE PANEL VAN (EURO 6)</b>								
2700 1.6CDTi (120PS) BlueInjection	1800	1030	36.2 (7.8)	48.7 (5.8)	43.4 (6.5)	170	22770.00	<b>23648.33</b>
2700 1.6CDTi BiTurbo (125PS) S/S ecoTEC BlueInjection	1818	1032	40.9 (6.9)	51.4 (5.5)	47.0 (6.0)	155	23170.00	<b>24048.33</b>
2700 1.6CDTi BiTurbo (145PS) S/S BlueInjection	1818	1032	39.8 (7.1)	50.4 (5.6)	46.3 (6.1)	160	23970.00	<b>24848.33</b>
2900 1.6CDTi (120PS) BlueInjection	1800	1190	36.2 (7.8)	48.7 (5.8)	43.4 (6.5)	170	23270.00	<b>24148.33</b>
2900 1.6CDTi BiTurbo (125PS) S/S ecoTEC BlueInjection	1818	1192	40.9 (6.9)	51.4 (5.5)	47.0 (6.0)	155	23670.00	<b>24548.33</b>
2900 1.6CDTi BiTurbo (145PS) S/S BlueInjection	1818	1192	39.8 (7.1)	50.4 (5.6)	46.3 (6.1)	160	24470.00	<b>25348.33</b>
<b>L1 H1 LIMITED EDITION NAV PANEL VAN (EURO 6)</b>								
2700 1.6CDTi BiTurbo (125PS) S/S ecoTEC BlueInjection	1818	1017	40.9 (6.9)	51.4 (5.5)	47.0 (6.0)	155	24370.00	<b>25248.33</b>
2700 1.6CDTi BiTurbo (145PS) S/S BlueInjection	1818	1017	39.8 (7.1)	50.4 (5.6)	46.3 (6.1)	160	25170.00	<b>26048.33</b>
<b>L1 H2 PANEL VAN (EURO 6)</b>								
2900 1.6CDTi BiTurbo (125PS) S/S ecoTEC BlueInjection	1897	1143	38.7 (7.3)	43.5 (6.5)	41.5 (6.8)	175	23870.00	<b>24748.33</b>

**Please note:** On-the-road recommended retail prices (RRP) include number plates and delivery to Retailer of £583.33 (exc. VAT), 12 months' Vehicle Excise Duty at £240.00 and new vehicle first registration fee of £55.00. Excludes fuel and insurance.

S/S = Start/Stop.

Vehicles with BlueInjection technology will need regular AdBlue® top-ups also between servicing requirements. An indicator integrated into the on-board computer will warn you when you need to top up. More information under [www.vauxhall.co.uk/blueinjection](http://www.vauxhall.co.uk/blueinjection). In accordance with regulations R (EC) No. 715/2007 and R (EC) No. 692/2008 (in the versions respectively applicable).

\* = For definitions please refer to Glossary of Terms.

# = Fuel consumption information is official government environmental data, tested in accordance with the relevant EU directive. Official EU-regulated test data is provided for comparison purposes and actual performance will depend on driving style, road conditions and other non-technical factors.

# VIVARO PANEL VAN PRICES



Model	Minimum Mass (kg)*	Payload (kg)*	Fuel economy mpg (litres/100km)#			CO <sub>2</sub> emissions (g/km)#	Price (£) exc. VAT	On-the-road RRP (£) exc. VAT
			Urban driving	Extra-urban driving	Combined figure			
<b>L2 H1 PANEL VAN (EURO 6)</b>								
2900 1.6CDTi (95PS) BlueInjection	1825	1265	35.3 (8.0)	47.0 (6.0)	42.1 (6.7)	174	22270.00	<b>23148.33</b>
2900 1.6CDTi (95PS) S/S BlueInjection	1825	1265	38.7 (7.3)	48.7 (5.8)	44.8 (6.3)	164	22465.00	<b>23343.33</b>
2900 1.6CDTi (120PS) BlueInjection	1825	1265	35.3 (8.0)	47.0 (6.0)	42.1 (6.7)	174	22870.00	<b>23748.33</b>
2900 1.6CDTi BiTurbo (125PS) S/S ecoTEC BlueInjection	1835	1265	40.3 (7.0)	50.4 (5.6)	46.3 (6.1)	159	23270.00	<b>24148.33</b>
<b>L2 H1 SPORTIVE PANEL VAN (EURO 6)</b>								
2900 1.6CDTi (120PS) BlueInjection	1825	1235	35.3 (8.0)	47.0 (6.0)	42.1 (6.7)	174	24070.00	<b>24948.33</b>
2900 1.6CDTi BiTurbo (125PS) S/S ecoTEC BlueInjection	1835	1235	40.3 (7.0)	50.4 (5.6)	46.3 (6.1)	159	24470.00	<b>25348.33</b>
2900 1.6CDTi BiTurbo (145PS) S/S BlueInjection	1835	1235	39.2 (7.2)	48.7 (5.8)	44.8 (6.3)	164	25270.00	<b>26148.33</b>
<b>L2 H1 LIMITED EDITION NAV PANEL VAN (EURO 6)</b>								
2900 1.6CDTi BiTurbo (125PS) S/S ecoTEC BlueInjection	1835	1220	40.3 (7.0)	50.4 (5.6)	46.3 (6.1)	159	25670.00	<b>26548.33</b>
2900 1.6CDTi BiTurbo (145PS) S/S BlueInjection	1835	1220	39.2 (7.2)	48.7 (5.8)	44.8 (6.3)	164	26470.00	<b>27348.33</b>
<b>L2 H2 PANEL VAN (EURO 6)</b>								
2900 1.6CDTi BiTurbo (125PS) S/S ecoTEC BlueInjection	1945	1185	38.2 (7.4)	42.8 (6.6)	40.9 (6.9)	178	24670.00	<b>25548.33</b>

**Please note:** On-the-road recommended retail prices (RRP) include number plates and delivery to Retailer of £583.33 (exc. VAT), 12 months' Vehicle Excise Duty at £240.00 and new vehicle first registration fee of £55.00. Excludes fuel and insurance.

S/S = Start/Stop.

Vehicles with BlueInjection technology will need regular AdBlue® top-ups also between servicing requirements. An indicator integrated into the on-board computer will warn you when you need to top up. More information under [www.vauxhall.co.uk/blueinjection](http://www.vauxhall.co.uk/blueinjection). In accordance with regulations R (EC) No. 715/2007 and R (EC) No. 692/2008 (in the versions respectively applicable).

\* = For definitions please refer to Glossary of Terms.

# = Fuel consumption information is official government environmental data, tested in accordance with the relevant EU directive. Official EU-regulated test data is provided for comparison purposes and actual performance will depend on driving style, road conditions and other non-technical factors.

# VIVARO DOUBLECAB PRICES



Model	Minimum Mass (kg)*	Payload (kg)*	Fuel economy mpg (litres/100km)#			CO <sub>2</sub> emissions (g/km)#	Price (£) exc. VAT	On-the-road RRP (£) exc. VAT	On-the-road RRP (£) inc. VAT
			Urban driving	Extra-urban driving	Combined figure				
<b>L1 H1 DOUBLECAB (EURO 6)</b>									
2900 1.6CDTi (95PS) BlueInjection	1920	974	35.3 (8.0)	47.0 (6.0)	42.1 (6.7)	174	22970.00	<b>23848.33</b>	<b>28559.00</b>
2900 1.6CDTi (95PS) S/S BlueInjection	1920	974	38.7 (7.3)	48.7 (5.8)	44.8 (6.3)	164	23165.00	<b>24043.33</b>	<b>28793.00</b>
2900 1.6CDTi (120PS) BlueInjection	1920	974	35.3 (8.0)	47.0 (6.0)	42.1 (6.7)	174	23570.00	<b>24448.33</b>	<b>29279.00</b>
2900 1.6CDTi BiTurbo (125PS) S/S ecoTEC BlueInjection	1930	974	40.3 (7.0)	50.4 (5.6)	46.3 (6.1)	159	23970.00	<b>24848.33</b>	<b>29759.00</b>
<b>L1 H1 SPORTIVE DOUBLECAB (EURO 6)</b>									
2900 1.6CDTi (120PS) BlueInjection	1920	934	35.3 (8.0)	47.0 (6.0)	42.1 (6.7)	174	24920.00	<b>25798.33</b>	<b>30899.00</b>
2900 1.6CDTi BiTurbo (125PS) S/S ecoTEC BlueInjection	1930	934	40.3 (7.0)	50.4 (5.6)	46.3 (6.1)	159	25320.00	<b>26198.33</b>	<b>31379.00</b>
2900 1.6CDTi BiTurbo (145PS) S/S BlueInjection	1930	934	39.2 (7.2)	48.7 (5.8)	44.8 (6.3)	164	26120.00	<b>26998.33</b>	<b>32339.00</b>
<b>L1 H1 LIMITED EDITION NAV DOUBLECAB (EURO 6)</b>									
2900 1.6CDTi BiTurbo (125PS) S/S ecoTEC BlueInjection	1930	919	40.3 (7.0)	50.4 (5.6)	46.3 (6.1)	159	26520.00	<b>27398.33</b>	<b>32819.00</b>
2900 1.6CDTi BiTurbo (145PS) S/S BlueInjection	1930	919	39.2 (7.2)	48.7 (5.8)	44.8 (6.3)	164	27320.00	<b>28198.33</b>	<b>33779.00</b>
<b>L2 H1 DOUBLECAB (EURO 6)</b>									
2900 1.6CDTi (95PS) BlueInjection	1975	1025	35.3 (8.0)	47.0 (6.0)	42.1 (6.7)	174	23770.00	<b>24648.33</b>	<b>29519.00</b>
2900 1.6CDTi (95PS) S/S BlueInjection	1975	1025	38.7 (7.3)	48.7 (5.8)	44.8 (6.3)	164	23965.00	<b>24843.33</b>	<b>29753.00</b>
2900 1.6CDTi (120PS) BlueInjection	1975	1025	35.3 (8.0)	47.0 (6.0)	42.1 (6.7)	174	24370.00	<b>25248.33</b>	<b>30239.00</b>
2900 1.6CDTi BiTurbo (125PS) S/S ecoTEC BlueInjection	1985	1025	40.3 (7.0)	50.4 (5.6)	46.3 (6.1)	159	24770.00	<b>25648.33</b>	<b>30719.00</b>
<b>L2 H1 SPORTIVE DOUBLECAB (EURO 6)</b>									
2900 1.6CDTi (120PS) BlueInjection	1975	985	35.3 (8.0)	47.0 (6.0)	42.1 (6.7)	174	25720.00	<b>26598.33</b>	<b>31859.00</b>
2900 1.6CDTi BiTurbo (125PS) S/S ecoTEC BlueInjection	1985	985	40.3 (7.0)	50.4 (5.6)	46.3 (6.1)	159	26120.00	<b>26998.33</b>	<b>32339.00</b>
2900 1.6CDTi BiTurbo (145PS) S/S BlueInjection	1985	985	39.2 (7.2)	48.7 (5.8)	44.8 (6.3)	164	26920.00	<b>27798.33</b>	<b>33299.00</b>
<b>L2 H1 LIMITED EDITION NAV DOUBLECAB (EURO 6)</b>									
2900 1.6CDTi BiTurbo (125PS) S/S ecoTEC BlueInjection	1985	970	40.3 (7.0)	50.4 (5.6)	46.3 (6.1)	159	27320.00	<b>28198.33</b>	<b>33779.00</b>
2900 1.6CDTi BiTurbo (145PS) S/S BlueInjection	1985	970	39.2 (7.2)	48.7 (5.8)	44.8 (6.3)	164	28120.00	<b>28998.33</b>	<b>34739.00</b>

**Please note:** On-the-road recommended retail prices (RRP) include number plates and delivery to Retailer of £583.33 (exc. VAT), 12 months' Vehicle Excise Duty at £240.00 and new vehicle first registration fee of £55.00. Excludes fuel and insurance.

S/S = Start/Stop.

Vehicles with BlueInjection technology will need regular AdBlue® top-ups also between servicing requirements. An indicator integrated into the on-board computer will warn you when you need to top up. More information under [www.vauxhall.co.uk/blueinjection](http://www.vauxhall.co.uk/blueinjection). In accordance with regulations R (EC) No. 715/2007 and R (EC) No. 692/2008 (in the versions respectively applicable).

\* = For definitions please refer to Glossary of Terms.

# = Fuel consumption information is official government environmental data, tested in accordance with the relevant EU directive. Official EU-regulated test data is provided for comparison purposes and actual performance will depend on driving style, road conditions and other non-technical factors.

VAT reclaimable status requires a 1-tonne payload for Doublecabs according to HMRC. This payload calculation should take into consideration local UK Specification and Trim Level. Details enabling this determination are shown in the notes immediately below the weight tables shown in brochures and Price Guides. Ordered options may also impact available payload. Regarding VAT reclaimable status it is advisable that customers consult their local HMRC office or visit [www.hmrc.co.uk](http://www.hmrc.co.uk) for further details.

# VIVARO COMBI / PLATFORM CAB PRICES



Model	Minimum Mass (kg)*	Payload (kg)*	Fuel economy mpg (litres/100km)#			CO <sub>2</sub> emissions (g/km)#	Price (£) exc. VAT	On-the-road RRP (£) inc. VAT
			Urban driving	Extra-urban driving	Combined figure			
<b>L1 H1 9-SEAT COMBI (EURO 6)</b>								
2900 1.6CDTi (95PS) S/S BlueInjection	1872	1068	41.5 (6.8)	52.3 (5.4)	47.1 (6.0)	155	23683.33	<b>29675.00</b>
2900 1.6CDTi BiTurbo (125PS) S/S ecoTEC BlueInjection	1882	1148	44.1 (6.4)	55.4 (5.1)	50.4 (5.6)	145	24516.67	<b>30375.00</b>
<b>L2 H1 9-SEAT COMBI (EURO 6)</b>								
2900 1.6CDTi (95PS) S/S BlueInjection	1913	1157	41.5 (6.8)	52.3 (5.4)	47.1 (6.0)	155	24483.33	<b>30635.00</b>
2900 1.6CDTi BiTurbo (125PS) S/S ecoTEC BlueInjection	1923	1157	44.1 (6.4)	55.4 (5.1)	50.4 (5.6)	145	25316.67	<b>31335.00</b>

**Please note:** On-the-road recommended retail prices (RRP) include number plates and delivery to Retailer of £583.33 (exc. VAT), 12 months' Vehicle Excise Duty at £200.00 on BiTurbo (125PS) models, £500.00 on (95PS) models and new vehicle first registration fee of £55.00. Excludes fuel and insurance.

S/S = Start/Stop.

Vehicles with BlueInjection technology will need regular AdBlue® top-ups also between servicing requirements. An indicator integrated into the on-board computer will warn you when you need to top up. More information under [www.vauxhall.co.uk/blueinjection](http://www.vauxhall.co.uk/blueinjection). In accordance with regulations R (EC) No. 715/2007 and R (EC) No. 692/2008 (in the versions respectively applicable).

\* = For definitions please refer to Glossary of Terms.

# = Fuel consumption information is official government environmental data, tested in accordance with the relevant EU directive. Official EU-regulated test data is provided for comparison purposes and actual performance will depend on driving style, road conditions and other non-technical factors.

Model	Minimum Mass (kg)*	Payload and Body Allowance (kg)*	Fuel economy mpg (litres/100km)#			CO <sub>2</sub> emissions (g/km)#	Price (£) exc. VAT	On-the-road RRP (£) exc. VAT
			Urban driving	Extra-urban driving	Combined figure			
<b>L2 H1 PLATFORM CAB (EURO 6)</b>								
2900 1.6CDTi BiTurbo (125PS) S/S ecoTEC BlueInjection	1616	1474	37.7 (7.5)	42.2 (6.7)	40.4 (7.0)	181	23170.00	<b>24048.33</b>
2900 1.6CDTi BiTurbo (145PS) S/S BlueInjection	1616	1474	37.7 (7.5)	42.2 (6.7)	40.4 (7.0)	181	23970.00	<b>24848.33</b>

**Please note:** On-the-road recommended retail prices (RRP) include number plates and delivery to Retailer of £583.33 (exc. VAT), 12 months' Vehicle Excise Duty at £240.00 and new vehicle first registration fee of £55.00. Excludes fuel and insurance.

S/S = Start/Stop.

Vehicles with BlueInjection technology will need regular AdBlue® top-ups also between servicing requirements. An indicator integrated into the on-board computer will warn you when you need to top up. More information under [www.vauxhall.co.uk/blueinjection](http://www.vauxhall.co.uk/blueinjection). In accordance with regulations R (EC) No. 715/2007 and R (EC) No. 692/2008 (in the versions respectively applicable).

All conversions must follow 'Vauxhall Converter Requirements' including recommended dimensional data, detailed within Part 1, available at: [www.vauxhall.co.uk/conversiondata](http://www.vauxhall.co.uk/conversiondata). The weight of any fitted conversion body will have to be deducted from these figures to establish actual payload and is subject to correct weight distribution. Variations from the recommended dimensions or weights may affect the vehicle's overall centre of gravity and stability. From 29 April 2013 conversion of N1 vehicles was affected by changes to type approval – for further information refer to the VCA website (N2 vehicles were affected from 29 October 2014). For further information please contact [conversions@vauxhall.co.uk](mailto:conversions@vauxhall.co.uk)

\* = For definitions please refer to Glossary of Terms.

# = Fuel consumption information is official government environmental data, tested in accordance with the relevant EU directive. Official EU-regulated test data is provided for comparison purposes and actual performance will depend on driving style, road conditions and other non-technical factors.

All conversions must follow 'Conversion Requirements' available on: [www.vauxhall.co.uk/conversiondata](http://www.vauxhall.co.uk/conversiondata)

# VIVARO EQUIPMENT / OPTIONS

## SAFETY

	Vivaro	Sportive	Limited Edition	Combi	Price (£) exc. VAT	Total (£) inc. VAT
<b>Airbags:</b>						
<i>Driver's airbag</i>	●	●	●	●		
<i>Front passengers' airbag:</i>						
• Front passengers' airbag with deactivation switch Option code: AK5	○	○	○	●	245.00	
• Driver and front passenger's curtain airbags and driver's side-impact airbag Option code: AWH	○	○	○	○	410.00	<b>492.00</b>
• Driver and single front passenger's curtain and side-impact airbags – <i>Mandates single passenger seat.</i> Option code: AY0	○	○	○	○	610.00	<b>732.00</b>
<b>Stability:</b>						
<i>Electronic Stability Programme-plus (ESP-plus) with traction control</i> – Works in conjunction with the vehicle's electronic braking and engine systems to keep the vehicle stable in many different situations. ESP monitors a variety of inputs to determine when the vehicle starts to lose traction, it can then immediately respond by varying the brake pressure between up to three wheels and adjust the engine output to help correct the loss of traction and improve stability.	●	●	●	●		
<b>Tyre pressure:</b>						
• Tyre pressure monitoring system Option code: UJ0	○	○	○	●	210.00	
<b>Anti-lock braking:</b>						
<i>Four-channel Anti-lock Braking System (ABS) – Prevents the vehicle's wheels from locking up under heavy braking by momentarily reducing brake pressure at the appropriate wheel, ensuring that you can maintain control of the steering.</i>	●	●	●	●		
<i>Emergency brake assist – When emergency braking is detected the vehicle automatically applies the maximum possible braking assistance.</i>	●	●	●	●		
<i>Electronic brakeforce distribution – Automatically apportions the optimum braking force to each wheel.</i>	●	●	●	●		
<i>Hill start assist – Briefly maintains rear brake pressure to stop the vehicle rolling back on an incline.</i>	●	●	●	●		
<b>Bulkhead:</b>						
• Full-height steel bulkhead without window – <i>Optional on Platform Cab models.</i>	●					
• Full-height ABS plastic bulkhead with window – <i>Doublecab only.</i>	●	●	●			
• Full-height steel bulkhead with window Option code: AX9	○				75.00	
• Vertical luggage restraint – <i>Half-height solid with black upper mesh.</i> Option code: AQ2				○		<b>168.00</b>
<b>FlexCargo load-through bulkhead:</b>						
• Dual front passengers' seat with storage, rotating clipboard and fold-flat centre • Load-through bulkhead – <i>Panel Van models only</i> Option code: AYW	○	●	●		265.00	
• Dual front passengers' seat with storage, rotating clipboard and fold-flat centre • Load-through bulkhead with window Option code: AYV	○				330.00	
• Dual front passengers' seat with storage, rotating clipboard and fold-flat centre • Load-through bulkhead with window Option code: AYV		○	○		75.00	

● = Standard equipment. ○ = Optional at extra cost.

# VIVARO EQUIPMENT / OPTIONS

## SECURITY

	Vivaro	Sportive	Limited Edition	Combi	Price (£) exc. VAT	Total (£) inc. VAT
<b>Features:</b>	●	●	●	●		
• Electronic engine deadlock immobiliser • Steering column lock • Secure fuel filler flap	●	●	●	●		
• Internal lockable rear and sliding side-access doors • Anti-theft spare wheel cradle	●	●	●	●		
<b>Remote control door locking (features depending on body type):</b>	●	●	●	●		
• Remote control door locking • Two keys with integral remote • Door deadlocks	●	●	●	●		
• Selective door locking • Two three-button keys with integral remote – <i>Only available with one-touch facility for electrically operated windows.</i>	○	●	●	○	205.00	<b>246.00</b>
Option code: AUX	○	●	●	○		
• Third key with integral remote	○	○	○	○	115.00	<b>138.00</b>
Option code: K69	○	○	○	○		
<b>Keyless entry and start:</b>						
• Keyless entry and start						
– <i>H1 models only.</i>						
– <i>Start/Stop models. Only available with electronic climate control (all models excluding Combi). Adds one-touch facility for electrically operated front-windows.</i>						
Option code: AVT	○	○	○	○	260.00	<b>312.00</b>
<b>Security alarm system:</b>						
• Engine compartment protection • Ultrasonic detectors in load area • Siren						
• Thatcham Category 1 approved (TUL3-180/0116)						
– <i>H1 models only.</i>						
Option code: XBGY	○	○	○	○	325.00	<b>390.00</b>
<b>Luggage cover:</b>						
• Rigid luggage cover • 50kg load – <i>Two-part on L2 models.</i>				○		<b>540.00</b>
Option code: D42				○		

● = Standard equipment. ○ = Optional at extra cost.

# VIVARO EQUIPMENT / OPTIONS

## COMFORT AND SEATING

	Vivaro	Sportive	Limited Edition	Combi	Price (£) exc. VAT	Total (£) inc. VAT
<b>Comfort:</b> <ul style="list-style-type: none"> <li>Height-adjustable steering wheel</li> <li>Leather-covered steering wheel (Sportive/Limited Edition models)</li> <li>Facia-mounted gear lever</li> <li>Floor-mounted handbrake lever</li> <li>Blue Tricess cloth seat trim (Standard models). Black Connect embossed cloth seat trim (Sportive / Limited Edition models)</li> <li>Vinyl floor covering</li> <li>Inertia-reel lap and diagonal seatbelts</li> <li>Height-adjustable outer front seatbelts</li> </ul>	●	●	●	●		
<b>Driver's seat:</b> <ul style="list-style-type: none"> <li>Height</li> <li>Reach</li> <li>Backrest recline</li> <li>Driver's active safety head restraint</li> <li>Height-adjustable padded head restraint</li> <li>Driver's seat armrest</li> </ul>	●	●	●	●		
<b>Dual front passengers' bench seat:</b> <ul style="list-style-type: none"> <li>Fixed position bench seat and backrest</li> <li>Height-adjustable outer front padded head restraint</li> <li>Fixed centre seat padded head restraint</li> </ul>	●			●		
<b>Dual front passengers' seat with underseat storage</b> <ul style="list-style-type: none"> <li>Fixed position bench seat and backrest</li> <li>Height-adjustable outer front padded head restraint</li> <li>Fixed centre seat padded head restraint – <i>Doublecab / Combi models.</i></li> </ul> Option code: AGE	○	●	●	○	175.00	<b>210.00</b>
<b>Single front passenger's seat:</b> <ul style="list-style-type: none"> <li>Lumbar adjustment</li> <li>Height</li> <li>Reach</li> <li>Backrest recline</li> <li>Height-adjustable padded head restraint</li> <li>Armrest – <i>Sportive / Limited Edition models will be supplied with full-height steel bulkhead when this option is specified.</i></li> </ul> Option code: AGD	○	○	○	○	155.00	<b>186.00</b>
<b>Heated front seats:</b> <ul style="list-style-type: none"> <li>Electrically heated driver and single front passenger seats</li> <li><i>– Only available with either single front passenger seat and curtain airbags / side-impact airbag options</i></li> </ul> Option code: KA1	○	○	○	○	160.00	<b>192.00</b>

## SEATING – DOUBLECAB

<b>Second-row seating:</b> <ul style="list-style-type: none"> <li>Three-individually contoured rear seats</li> <li>Inertia-reel lap and diagonal seatbelts</li> <li>Padded head restraints</li> </ul>	●	●	●			
<ul style="list-style-type: none"> <li>Underseat storage</li> <li>12-volt accessory socket</li> </ul>		●	●			

## SEATING – COMBI

<b>Second-row seating:</b> <ul style="list-style-type: none"> <li>Three-passenger second-row bench seat</li> <li>60/40 split-folding seat back for easier access to third-row bench seat</li> <li>Removable second-row bench seats</li> <li>Inertia-reel lap and diagonal seatbelts</li> </ul>				●		
<b>Third-row seating:</b> <ul style="list-style-type: none"> <li>Three passenger bench seat</li> <li>Fold and tumble feature for creating extra load area without removing seats</li> <li>Removable rear seats</li> <li>Inertia-reel lap and diagonal seatbelts</li> </ul>				●		

● = Standard equipment. ○ = Optional at extra cost.



# VIVARO EQUIPMENT / OPTIONS

## CABIN STORAGE

	Vivaro	Sportive	Limited Edition	Combi	Price (£) exc. VAT	Total (£) inc. VAT
<b>Accessory sockets:</b> • Facia-mounted 12-volt accessory socket	●	●	●	●		
<b>Facia storage:</b> • Nine facia storage spaces offering more than 24 litres of storage • Open storage compartment above glovebox (lidded on Sportive / Limited Edition models) • Illuminated glovebox • Three drinks holders • Coin holder	●	●	●	●		
<b>Front door pockets:</b> • Large door pockets with drinks holder	●	●	●	●		
<b>Smoker Pack:</b> • Removable ashtray • Illuminated cigar lighter Option code: DT4	○	○	○	○	55.00	<b>66.00</b>

## DRIVER ASSISTANCE

<b>Windscreen wipers:</b> • Two-speed windscreen wipers • Variable intermittent wipe • Electric screenwash	●	●	●	●		
<b>Multi-function trip computer:</b> • Trip odometer • Vehicle range based on remaining fuel • Average speed • Average fuel economy • Instantaneous fuel economy • Driving time	●	●	●	●		
<b>Parking assistance:</b> • Rear parking distance sensors Option code: UD7	○	●	●	○	235.00	<b>282.00</b>
• Rear-view camera - H1 models only. Not available on Platform Cab models. - Requires Sight and Light Pack (Sportive models). Option code: UDS		○	○		295.00	
• Rear-view camera • Rear parking distance sensors - H1 models only. Not available on Platform Cab models. - Requires Lighting Pack. Option code: UDS	○			○	520.00	<b>624.00</b>
• Nearside blind-spot / junction mirror located in front passenger sunvisor	●	●	●	●		
Cruise control, speed limiter Option code: K34	○	●	●	○	260.00	<b>312.00</b>
<b>Speed limiter:</b> • Choice of three speeds: 56mph / 62mph / 68mph Option code: (56mph) KYJ Option code: (62mph) KYK Option code: (68mph) KYL	○	○	○	○	85.00	<b>102.00</b>

● = Standard equipment. ○ = Optional at extra cost.

# VIVARO EQUIPMENT / OPTIONS

## DRIVER INFORMATION

	Vivaro	Sportive	Limited Edition	Combi	Price (£) exc. VAT	Total (£) inc. VAT
<b>Instrumentation:</b> <ul style="list-style-type: none"> <li>• Speedometer • Rev counter • Fuel gauge with low fuel warning light • Fuel economy gauge • Coolant temperature warning light</li> </ul>	●	●	●	●		
<b>ECO features:</b> <ul style="list-style-type: none"> <li>• Shift-up indicator</li> <li>- Indicates when to change gear for optimum fuel economy.</li> </ul>	●	●	●	●		
<b>Driver information display:</b> <ul style="list-style-type: none"> <li>• Monochrome display located in instrument cluster • Odometer • Service-due indicator • Displays trip computer data</li> </ul>	●	●	●	●		
<b>Central fascia display:</b> <ul style="list-style-type: none"> <li>• Audio information • Digital clock with automatic RDS time adjustment • Outside air temperature with ice warning function • Additional features and location dependent on infotainment unit (see Audio, Communication and Navigation for details)</li> </ul>	●	●	●	●		
<b>Warning indicators:</b> <ul style="list-style-type: none"> <li>• Low oil level, low brake fluid, brake pad wear, battery, fuel filter, low AdBlue® level, seatbelt warning and doors open</li> </ul>	●	●	●	●		
<b>Digital tachograph:</b> <ul style="list-style-type: none"> <li>• Odometer display is changed from miles to kilometres – <i>Digital tachograph only available with R 16 audio unit.</i></li> <li>- <i>Important: The digital tachograph must be specified at time of ordering as it cannot be fitted retrospectively. Option price does not include calibration which must be carried out at an approved tachograph centre within 14 days of the vehicle's registration. Please note: The legislation regarding the use of tachographs is complex and operators should seek independent advice or speak to the Commercial Vehicle specialist at your Vauxhall retailer to ensure compliance. Alternatively your local DVLA office will also be able to provide clarification of the relevant legislation.</i></li> </ul> <p style="text-align: right;">Option code: TGP</p>	○			○	535.00	<b>642.00</b>

## PACKS

<b>Navigation Pack:</b> <ul style="list-style-type: none"> <li>• Satellite navigation – NAVI 50 IntelliLink • Rear parking distance sensors • Rear-view camera • One-touch electrically operated front windows • Three-button key • Selective door locking</li> <li>- <i>H1 models only. Not available on Platform Cab models. Requires Lighting Pack.</i></li> </ul> <p style="text-align: right;">Option code: 0EC</p>	○			○	1005.00	<b>1206.00</b>
<b>Navigation Pack:</b> <ul style="list-style-type: none"> <li>• Satellite navigation – NAVI 50 IntelliLink • Rear-view camera – <i>Requires Sight and Light Pack.</i></li> </ul> <p style="text-align: right;">Option code: 0EC</p>		○			860.00	

● = Standard equipment. ○ = Optional at extra cost.

# VIVARO EQUIPMENT / OPTIONS

## INFOTAINMENT

	Vivaro	Sportive	Limited Edition	Combi	Price (£) exc. VAT	Total (£) inc. VAT
<b>R 16 BT USB:</b> <i>Onboard features:</i> • DAB digital radio • AM/FM stereo radio with 6-station presets • RDS with Traffic Programme • Two speakers – <i>Four on Combi models</i> • 20 watts per channel output <i>Media connections:</i> • USB connection with iPod control • Aux-in socket • Bluetooth® audio streaming (A2DP Profile) <i>Mobile phone portal:</i> • Bluetooth® connectivity • Handsfree calls via steering wheel controls • Vehicle microphone • Phone book access – <i>Contacts / last calls / missed calls etc. (features dependent on mobile phone).</i>	●	N/C	N/C	●		
<b>CD 18 BT USB:</b> <i>Onboard features:</i> • DAB digital radio • AM/FM stereo radio with 6-station presets • CD/MP3 CD player • RDS with Traffic Programme • Two Speakers – <i>Four on Combi models</i> • 20 watts per channel output <i>Media connections:</i> • USB connection with iPod control • Aux-in socket • Bluetooth® audio streaming (A2DP Profile) <i>Mobile phone portal:</i> • Bluetooth® connectivity • Handsfree calls via steering wheel controls • Vehicle microphone • Phone book access – <i>Contacts / last calls / missed calls etc. (features dependent on mobile phone).</i>	○	●		○	295.00	<b>354.00</b>
<b>NAVI 50 IntelliLink – Not available when tachograph is specified:</b> <i>Onboard features:</i> • DAB digital radio • AM/FM stereo radio with 18-station presets • 7-inch facia-mounted colour touchscreen • RDS with Traffic Programme • Two speakers – <i>Four on Combi models.</i> • 20 watts per channel output <i>Navigation features:</i> • Satellite navigation system • 3D street level mapping • Major route mapping for Western Europe <i>Media connections:</i> • USB connection with iPod control • Aux-in socket • Bluetooth® audio streaming (A2DP Profile) • Siri voice control <i>Mobile phone portal:</i> • Bluetooth® connectivity • Handsfree calls via steering wheel controls • Vehicle microphone • Phone book access – <i>Contacts / last calls / missed calls etc. are mirrored on the display and are easily navigated using the touchscreen (features dependent on mobile phone).</i>	○	○	●	○	660.00	<b>792.00</b>
<b>NAVI 80 IntelliLink – Only available in conjunction with cruise control. Not available when tachograph is specified:</b> <i>Onboard features:</i> • DAB digital radio • AM/FM stereo radio with 18-station presets • 7-inch facia-mounted colour touchscreen • RDS with Traffic Programme • Two speakers – <i>Four on Combi models.</i> • 20 watts per channel output <i>Navigation features:</i> • Satellite navigation system • TomTom LIVE services • 3D street level mapping • Major route mapping for Europe • Traffic Information <i>Media connections:</i> • USB connection with iPod control • Aux-in socket • Bluetooth® audio streaming (A2DP Profile) • Integrated voice control <i>Mobile phone portal:</i> • Bluetooth® connectivity • Handsfree calls via steering wheel controls • Vehicle microphone • Phone book access – <i>Contacts / last calls / missed calls etc. are mirrored on the display and are easily navigated using the touchscreen (features dependent on mobile phone).</i>	○	○	○	○	1080.00	<b>1296.00</b>
<b>Flexdock for smartphone / tablet:</b> • Universal smartphone docking station (up to 4.7-inch)	○	○	●	○	50.00	<b>60.00</b>
• Tablet docking station (up to 4.8 – 10.6 inch) – <i>Only available with R 16 audio unit.</i>	○			○	70.00	<b>84.00</b>
<b>Additional features:</b> • Steering column mounted audio controls • Flexible roof-mounted aerial	●	●	●	●		

● = Standard equipment. ○ = Optional at extra cost. N/C = No-cost option.

# VIVARO EQUIPMENT / OPTIONS

## HEATING AND VENTILATION

	Vivaro	Sportive	Limited Edition	Combi	Price (£) exc. VAT	Total (£) inc. VAT
<b>Cab heating:</b> • Four-speed fan • Illuminated controls • Four adjustable facia vents • Windscreen demist vents • Side window demist vents	●	●	●	●		
<b>Climate and Cruise Pack:</b> • Air conditioning with air recirculation facility (cab only) • CD 18 BT USB audio unit • Cruise control Option code: XAEB	○			○	770.00	<b>924.00</b>
<b>Air conditioning – Cab only:</b> • Air recirculation facility • Pollen filter • Illuminated controls • Chilled glovebox facility Option code: C60	○	●	●	○	750.00	<b>900.00</b>
<b>Electronic climate control:</b> • Incorporating air conditioning • LCD temperature display • Automatic air direction and fan speed with manual override • Illuminated controls • Pollen filter • Chilled glovebox facility – <i>Requires Lighting Pack.</i> Option code: C68	○				890.00	
<b>Electronic climate control:</b> • LCD temperature display • Automatic air direction and fan speed with manual override • Illuminated controls • Pollen filter • Chilled glovebox facility – <i>Requires Sight and Light Pack.</i> Option code: C68		○	○		260.00	
<b>Air conditioning – Cab and saloon:</b> • Air recirculation facility • Pollen filter • Illuminated controls • Chilled glovebox facility • Auxiliary heater Option code: CJ5				○		<b>1272.00</b>
<b>Auxiliary heating:</b> • Fuel-fired – <i>In cold conditions rapidly warms engine coolant which in turn quickly provides warm air for the cabin when engine turned on.</i> Option code: K08				○		<b>894.00</b>

● = Standard equipment. ○ = Optional at extra cost.

Please note: The air conditioning in vehicles with N1 type approval relies upon fluorinated greenhouse gases (R134a) for its functioning. The front system contains a quantity of overall 580g of R 134a, which corresponds to a CO<sub>2</sub> equivalent of 0.83 tons. The front and rear system contains a quantity of overall 890g of R 134a, which corresponds to a CO<sub>2</sub> equivalent of 1.27 tons. The global warming potential amounts to 1430. Information acc. to R (EU) No. 517/2014.

# VIVARO EQUIPMENT / OPTIONS

## LOAD ACCESS

	Vivaro	Sportive	Limited Edition	Combi	Price (£) exc. VAT	Total (£) inc. VAT
Illuminated load area	●	●	●	●		
<b>Nearside access:</b>						
<i>Nearside side-access door:</i>						
• Nearside sliding side-access door • Unglazed	●	●	●	●		
<b>Offside access – Panel Van only:</b>						
<i>Offside side-access door</i>						
• Offside sliding side-access door • Unglazed	○	○	○		300.00	
Option code: BSJ						
<b>Nearside and offside access:</b>						
<i>Side-access doors with fixed windows – Standard on Doublecab:</i>						
• Fixed window to standard nearside side-access door						
• Offside side-access door						
• Fixed window to offside side-access door	○	○	○	●	380.00	
Option code: BSB						
<i>Side-access doors with sliding windows. Panel Van models – Only available with glazed rear doors / tailgate:</i>						
• Sliding window to standard nearside side-access door						
• Offside side-access door						
• Sliding window to offside side-access door	○	○	○		430.00	
Option code: BSC						
<i>Side-access doors with sliding windows – Doublecab / Combi models. Only available with glazed rear doors / tailgate:</i>						
• Sliding window to standard glazed nearside side-access door						
• Sliding window to standard glazed offside side-access door	○	○	○	○	60.00	<b>72.00</b>
Option code: BSC						
<b>Rear access:</b>						
<i>Rear solid doors:</i>						
• Twin rear doors • 90°/180° opening	●	●	●			
• Twin rear doors • 270° opening						
– Not available on L1 models.	○	○	○		250.00	
Option code: 7U4						
<i>Rear glazed doors:</i>						
• Glazed rear doors • 90°/180° opening						
– Only available with glazed bulkhead options.	○	○	○	○	85.00	<b>102.00</b>
Option code: J1X						
• Glazed rear doors • 270° opening						
– Not available on L1 models.	○	○	○		250.00	
Option code: J1T						
• Glazed tailgate						
– Not available on H2 models. Only with glazed bulkhead and heated rear windows with wash/wipe facility options.	○	○	○	●	120.00	
Option code: J1U						
• Heated rear windows with wash/wipe facility – Only with glazed rear door and tailgate options.	○	○	○	●	60.00	
Option code: C25						

● = Standard equipment. ○ = Optional at extra cost.

# VIVARO EQUIPMENT / OPTIONS

## LOAD RESTRAINT

	Vivaro	Sportive	Limited Edition	Combi	Price (£) exc. VAT	Total (£) inc. VAT
<b>Load anchorage:</b>						
<ul style="list-style-type: none"> <li>Fixed floor-mounted load restraint lashing eyes (Panel Van: L1 x 8, L2 x 10)</li> <li>Load restraint lashing eyes (Panel Van: L1 x 8 / L2 x 10)</li> </ul>	●	●	●			
<b>Loading Pack with cargo lining:</b>						
<ul style="list-style-type: none"> <li>Unglazed steel bulkhead with FlexCargo load-through facility</li> <li>Dual passenger's seat with storage, rotating clipboard, fold-flat centre and load through compatibility</li> <li>Resin-coated plywood load floor covering</li> <li>Half-height plastic load lining panels</li> </ul> Option code: XYA9	○				430.00	
<b>Bott® Vario Racking System – Pack One – H1 Panel Van only</b>						
<b>Offside unit 1525mm wide x 320mm deep x 1000mm high</b>						
<ul style="list-style-type: none"> <li>End frames with corner protection</li> <li>2 x low front shelf with anti-slip mat</li> <li>Base compartment with lashing rail and ratchet strap</li> <li>Resin-coated, non-slip moisture repellent 9mm birch multiplex flooring</li> </ul>	L1 ○	L1 ○	L1 ○		1095.00	
<b>Nearside unit 1025mm wide x 420mm deep x 900mm high</b>						
<ul style="list-style-type: none"> <li>End frames with corner protection</li> <li>1 x low front shelf with anti-slip mat and divider</li> <li>1 x low front shelf</li> <li>Base compartment with lashing rail and ratchet strap</li> <li>Resin-coated, non-slip moisture repellent 9mm birch multiplex flooring</li> </ul> – Not available with floor covering, offside sliding side-access door or tailgate options. Option code: XCAA	L2 ○	L2 ○	L2 ○		1195.00	
<b>Bott® Vario Racking System – Pack Two – H1 Panel Van only</b>						
<b>Offside unit 2050mm wide x 320mm deep x 1000mm high</b>						
<ul style="list-style-type: none"> <li>End frames with corner protection</li> <li>1 x 2000mm wide low front shelf with 2 dividers</li> <li>1 x low front shelf with 4 x Bott storage boxes</li> <li>1 x low front shelf with 7 x Bott storage boxes</li> <li>1 x low front shelf with anti-slip mat</li> <li>1 x low front shelf with anti-slip mat and divider</li> <li>Base compartment with lashing rail and ratchet strap</li> <li>Full-height white plastic load lining</li> <li>Resin-coated, non-slip moisture repellent 9mm birch multiplex flooring</li> </ul>	L1 ○	L1 ○	L1 ○		1495.00	
<b>Nearside unit 1025mm wide x 420mm deep x 900mm high</b>						
<ul style="list-style-type: none"> <li>End frames with corner protection</li> <li>1 x low front shelf with anti-slip mat</li> <li>1 x low front shelf with 7 x Bott storage boxes</li> <li>A4 aluminium document pocket</li> <li>Base compartment with lashing rail and ratchet strap</li> <li>Full-height white plastic load lining</li> <li>Resin-coated, non-slip moisture repellent 9mm birch multiplex flooring</li> </ul> – Not available with load lining, floor covering, offside sliding side-access door or tailgate options. Option code: XBGT	L2 ○	L2 ○	L2 ○		1595.00	
<b>Load lining:</b>						
<ul style="list-style-type: none"> <li>Half-height plastic side load lining panels – Panel Van only.</li> </ul> Option code: B48	○	○	○		90.00	
<ul style="list-style-type: none"> <li>Full-height coated wooden load lining panels – H1 Panel Van only.</li> </ul> Option code: ERK	○	○	○		310.00	
<ul style="list-style-type: none"> <li>Full-height light plastic honeycomb load lining panels – H1 only.</li> </ul> Option code: B6H	○	○	○		305.00	
<ul style="list-style-type: none"> <li>Resin-coated laminate plywood load floor covering – H1 only.</li> </ul> Option code: B68	○	○	○		345.00	
<ul style="list-style-type: none"> <li>Rubber-coated reinforced wooden load floor covering – Panel Van only.</li> </ul> Option code: BIW	○	○	○		345.00	
<ul style="list-style-type: none"> <li>Resin-coated laminate plywood wheel arch protection – H1 only.</li> </ul> Option code: B65	○	○	○		210.00	

● = Standard equipment. ○ = Optional at extra cost.

# VIVARO EQUIPMENT / OPTIONS

## EXTERIOR CONVENIENCE / STYLING

	Vivaro	Sportive	Limited Edition	Combi	Price (£) exc. VAT	Total (£) inc. VAT
<b>Exterior features:</b> • Unique styled graphics – <i>Black or silver dependent on exterior colour. Please see Exterior Colours page.</i>			●			
<b>Appearance Pack One:</b> • Body-colour front bumper • Body-colour rear quarter bumpers – <i>Not available when Ink Blue paint is specified. H2 models are only available when Glacier White or Platinum Silver colours are specified.</i> Option code: 5LK	○			○	310.00	<b>372.00</b>
<b>Appearance Pack Two:</b> • Leather-covered steering wheel • Black Connect embossed cloth seat trim • Chrome instrument surrounds • Lidded storage compartment above glovebox • LED daytime running lights • Front fog lights • Full-diameter wheel trims • Body-colour front bumper • Body-colour rear quarter bumpers – <i>Not available when Ink Blue paint is specified.</i> Option code: XADR				○		<b>1200.00</b>
<b>Windows:</b> • Electrically operated front windows • One-touch facility for electrically operated windows Option code: AXG	●	●	●	●	50.00	<b>60.00</b>
• Dark-tinted rear glazing – <i>H1 models only. Only available with glazed rear doors / tailgate with heated windows and wash / wipe facility.</i> – <i>Excludes Platform Cab.</i> Option code: AJS	○	○	○	○	360.00	<b>432.00</b>
<b>Door mirrors:</b> • Foldable electrically adjustable/heated door mirrors • Wide-angle mirror on driver's side • Electrically adjustable / heated long arm exterior door mirrors – <i>Platform Cab only. Long arm exterior mirrors should be applied to any vehicle with an overall width of 2.17 to 2.35 metres.</i> Option code: DCI	●	●	●	●	170.00	
<b>Paint finish:</b> • Special paint – <i>Restrictions apply, please consult your Retailer for details.</i>	○			○		<b>At extra cost</b>

## GLAZED PACK – PANEL VAN

• Fixed window to standard nearside side-access door • Fixed window to opposite offside side-access door • Rear glazed doors • Rear glazed side panels – <i>Panel Van only. Only available when the offside sliding side-access door is specified.</i> Option code: A10	○	○	○		420.00	
---	---	---	---	--	--------	--











## EXTERIOR LIGHTING

<b>Standard lighting:</b> • Lights-on audible warning • Electric headlight beam levelling • Twin reversing lights • Hazard warning lights • Rear fog lights • High-level brake light • High-level tail lights • Side-repeat indicators • Daytime running lights – <i>LED on Sportive models.</i> • Front fog lights. Option code: T3U	●	●	●	●	120.00	<b>144.00</b>
<b>Lighting Pack:</b> • Static cornering lights • Front fog lights • Automatic lighting control • Rain-sensitive windscreen wipers • Door-to-door illumination Option code: XAEG	○			○	260.00	<b>312.00</b>
<b>Sight and Light Pack:</b> • Automatic lighting control • Rain-sensitive windscreen wipers Option code: 5BT		○	●		245.00	

● = Standard equipment. ○ = Optional at extra cost.

# VIVARO EQUIPMENT / OPTIONS

## EXTERIOR COLOURS

			Vivaro	Sportive	Limited Edition	Combi	Price (£) exc. VAT	Total (£) inc. VAT
	<b>Glacier White (10U)</b> <ul style="list-style-type: none"> <li>• Solid paint</li> <li>• Black alloy wheels / graphics on Limited Edition models</li> </ul>							
	<b>Flame Red (79U / 79Z)</b> <ul style="list-style-type: none"> <li>• Brilliant paint</li> <li>• Black or silver alloy wheels / graphics on Limited Edition models</li> </ul>							
	<b>Spring Green (10G / 10Z)</b> <ul style="list-style-type: none"> <li>• Brilliant paint</li> <li>• Black alloy wheels / graphics on Limited Edition models</li> </ul>		○	N/C	N/C	○	320.00	<b>384.00</b>
	<b>Panorama Blue (4UU)</b> <ul style="list-style-type: none"> <li>• Two-coat pearlescent paint</li> <li>• Silver alloy wheels / graphics on Limited Edition models</li> </ul>							
	<b>Cassiopeia Silver (10J)</b> <ul style="list-style-type: none"> <li>• Two-coat pearlescent paint</li> <li>• Silver alloy wheels / graphics on Limited Edition models</li> </ul>							
	<b>Jasper Brown (10E)</b> <ul style="list-style-type: none"> <li>• Two-coat pearlescent paint</li> <li>• Silver alloy wheels / graphics on Limited Edition models</li> </ul>		○	N/C	N/C	○	450.00	<b>540.00</b>
	<b>Platinum Silver (10H)</b> <ul style="list-style-type: none"> <li>• Two-coat pearlescent paint</li> <li>• Black alloy wheels / graphics on Limited Edition models</li> </ul>							





● = Standard equipment. ○ = Optional at extra cost. N/C = No-cost option.

The colours reproduced may vary slightly from the actual paint colour. As a result they should be used as a guide only. Your Vauxhall Retailer has a comprehensive display of our paint samples.





# VIVARO EQUIPMENT / OPTIONS

## WHEELS AND TYRES

	Vivaro	Sportive	Limited Edition	Combi	Price (£) exc. VAT	Total (£) inc. VAT
 <p><b>16-inch steel wheels with centre cap:</b></p> <ul style="list-style-type: none"> <li>• 205/65 R 16 tyres (1.6CDTi 95/120/125PS engines)</li> <li>• 215/65 R 16 tyres (1.6CDTi 145PS engines)</li> <li>• Full-size spare wheel</li> </ul>	●			●		
 <p><b>16-inch steel wheels with wheel trims:</b></p> <ul style="list-style-type: none"> <li>• 205/65 R 16 tyres (1.6CDTi 95/120/125PS engines)</li> <li>• 215/65 R 16 tyres (1.6CDTi 145PS engines)</li> <li>• Full-size spare wheel</li> </ul>		●				
 <p><b>17-inch black alloy wheels:</b></p> <ul style="list-style-type: none"> <li>• 215/60 R 17 tyres</li> <li>• 16-inch steel spare wheel</li> <li>- On Limited Edition models, wheel finish dependent on body colour. Please see Exterior Colours page.</li> </ul>			●			
 <p><b>17-inch silver alloy wheels:</b></p> <ul style="list-style-type: none"> <li>• 215/60 R 17 tyres</li> <li>• 16-inch steel spare wheel</li> <li>- Not available on H2 or Platform Cab models.</li> <li>- On Limited Edition models, wheel finish dependent on body colour. Please see Exterior Colours page.</li> </ul>	○	○	●	○	630.00	<b>756.00</b>
						Option code: RS6
<p><b>All-season tyres:</b></p> <ul style="list-style-type: none"> <li>• 205/65 R 16 (All engines)</li> </ul>	○	○		○	215.00	<b>258.00</b>
						Option code: NRK
<p>Tyre inflation kit in lieu of spare wheel - Not available on L2 Combi models.</p>	N/C	N/C	N/C	N/C	<b>No-cost option</b>	
						Option code: WTC

● = Standard equipment. ○ = Optional at extra cost. N/C = No-cost option.

## TYRE RATINGS

Tyre size	Fuel efficiency group	Wet grip performance	External noise	
			Measured (dB)	Group
205/65 R 16	C-E	B-E	71-72	
215/65 R 16	C	B	70	
215/60 R 17	C	B	70	

Tyre rating according to EU Regulation 1222/2009

# VIVARO EQUIPMENT / OPTIONS

## MECHANICAL

	Vivaro	Sportive	Limited Edition	Combi	Price (£) exc. VAT	Total (£) inc. VAT
<b>Transmission:</b> <i>Six-speed manual gearbox:</i> • Front-wheel drive • Transverse engine/gearbox	●	●	●	●		
<b>Steering:</b> • Hydraulic power-assisted rack and pinion system • Energy absorbing steering column <b>Turning circles:</b> <b>Kerb-to-kerb</b> FWD L1                      11.8m (38.7ft.) FWD L2                      13.2m (43.3ft.)	●	●	●	●		
<b>Brakes:</b> <i>Front ventilated disc brakes:</i> • 296mm x 28mm <i>Rear disc brakes:</i> • 280mm x 12mm	●	●	●	●		
<b>Power take-off</b> • Engine driven power take-off • Six-pin / two-pin connector for conversions Option code: V66 Option code: KPD	○	○	○	○	220.00	
<b>Fuel tank:</b> • 80 litres (17.6 gallons) capacity	●	●	●	●		
<b>AdBlue tank:</b> • 22 litres (4.8 gallons) capacity	●	●	●	●		
<b>Towing:</b> • Tow bar with 13-pin electrics • Trailer stability programme <i>– Excludes Platform Cab models. Does not suit trailers with LED lights. For trailers with LED lights use genuine Vauxhall Accessory tow bars which also include trailer stability programme. Unless specific exemptions apply, vehicles operated with a trailer, where the combined weight of the vehicle, trailer and payload exceeds 3500kg, require a digital tachograph.</i> Option code: VR2	○	○	○	○	325.00	<b>390.00</b>
<b>Electrical:</b> • 80Ah maintenance-free battery (70Ah on air conditioned models) • 185A alternator (150A on air conditioned models)	●	●	●	●		
<b>CANbus interface:</b> <i>Allows the vehicle's electrical systems to integrate with additional equipment.</i> Option code: KC6	○	○	○	○	135.00	<b>162.00</b>
Six-pin / two pin electrical connector for conversions Option code: KPD	○	○	○	○	60.00	<b>72.00</b>
<b>Front suspension:</b> • MacPherson type • Independent double wishbones • Coil springs • Gas-pressure dampers	●	●	●	●		
<b>Rear suspension:</b> • Independent four-link, progressive-rate mini-block springs • Gas-pressure dampers	●	●	●	●		

● = Standard equipment. ○ = Optional at extra cost.

# MOVANO PANEL VAN PRICES



Model	Minimum Mass (kg)*	Payload (kg)*	Fuel economy mpg (litres/100km)#			CO <sub>2</sub> emissions (g/km)#	Price (£) exc. VAT	On-the-road RRP (£) exc. VAT
			Urban driving	Extra-urban driving	Combined figure			
<b>L1 H1 FWD PANEL VAN (EURO 6)</b>								
2800 2.3CDTi (110PS) BlueInjection	1927	858	32.1 (8.8)	40.4 (7.0)	36.7 (7.7)	201	23775.00	<b>24653.33</b>
2800 2.3CDTi (130PS) BlueInjection	1927	858	32.1 (8.8)	40.4 (7.0)	36.7 (7.7)	201	24575.00	<b>25453.33</b>
3300 2.3CDTi (110PS) BlueInjection	1932	1353	32.1 (8.8)	40.4 (7.0)	36.7 (7.7)	201	25025.00	<b>25903.33</b>
3300 2.3CDTi (130PS) BlueInjection	1932	1353	32.1 (8.8)	40.4 (7.0)	36.7 (7.7)	201	25825.00	<b>26703.33</b>
3500 2.3CDTi (110PS) BlueInjection	1937	1548	32.1 (8.8)	40.4 (7.0)	36.7 (7.7)	201	25675.00	<b>26553.33</b>
3500 2.3CDTi (130PS) BlueInjection	1937	1548	32.1 (8.8)	40.4 (7.0)	36.7 (7.7)	201	26475.00	<b>27353.33</b>
3500 2.3CDTi BiTurbo (145PS) S/S BlueInjection	1946	1539	38.2 (7.4)	42.8 (6.6)	40.9 (6.9)	179	27585.00	<b>28463.33</b>
<b>L1 H2 FWD PANEL VAN (EURO 6)</b>								
2800 2.3CDTi (110PS) BlueInjection	1955	830	31.7 (8.9)	39.8 (7.1)	36.2 (7.8)	204	24375.00	<b>25253.33</b>
2800 2.3CDTi (130PS) BlueInjection	1955	830	31.7 (8.9)	39.8 (7.1)	36.2 (7.8)	204	25175.00	<b>26053.33</b>
3300 2.3CDTi (110PS) BlueInjection	1960	1325	31.7 (8.9)	39.8 (7.1)	36.2 (7.8)	204	25625.00	<b>26503.33</b>
3300 2.3CDTi (130PS) BlueInjection	1960	1325	31.7 (8.9)	39.8 (7.1)	36.2 (7.8)	204	26425.00	<b>27303.33</b>
3500 2.3CDTi (110PS) BlueInjection	1965	1520	31.7 (8.9)	39.8 (7.1)	36.2 (7.8)	204	26275.00	<b>27153.33</b>
3500 2.3CDTi (130PS) BlueInjection	1965	1520	31.7 (8.9)	39.8 (7.1)	36.2 (7.8)	204	27075.00	<b>27953.33</b>
3500 2.3CDTi BiTurbo (145PS) S/S BlueInjection	1974	1511	37.2 (7.6)	42.2 (6.7)	40.4 (7.0)	183	28185.00	<b>29063.33</b>
<b>L2 H2 FWD PANEL VAN (EURO 6)</b>								
3300 2.3CDTi (110PS) BlueInjection	2004	1281	31.7 (8.9)	39.8 (7.1)	36.2 (7.8)	204	26980.00	<b>27858.33</b>
3300 2.3CDTi (130PS) BlueInjection	2004	1281	31.7 (8.9)	39.8 (7.1)	36.2 (7.8)	204	27780.00	<b>28658.33</b>
3500 2.3CDTi (110PS) BlueInjection	2009	1476	31.7 (8.9)	39.8 (7.1)	36.2 (7.8)	204	27630.00	<b>28508.33</b>
3500 2.3CDTi (110PS) S/S BlueInjection	2009	1476	34.9 (8.1)	39.8 (7.1)	37.7 (7.5)	194	27920.00	<b>28798.33</b>
3500 2.3CDTi (130PS) BlueInjection	2009	1476	31.7 (8.9)	39.8 (7.1)	36.2 (7.8)	204	28430.00	<b>29308.33</b>
3500 2.3CDTi BiTurbo (145PS) S/S BlueInjection	2018	1467	37.2 (7.6)	42.2 (6.7)	40.4 (7.0)	183	29540.00	<b>30418.33</b>
3500 2.3CDTi BiTurbo (170PS) S/S Tecshift BlueInjection	2018	1467	36.2 (7.8)	40.9 (6.9)	39.2 (7.2)	187	31665.00	<b>32543.33</b>
<b>L2 H3 FWD PANEL VAN (EURO 6)</b>								
3500 2.3CDTi (110PS) BlueInjection	2050	1435	31.7 (8.9)	39.8 (7.1)	36.2 (7.8)	204	28330.00	<b>29208.33</b>
3500 2.3CDTi (130PS) BlueInjection	2050	1435	31.7 (8.9)	39.8 (7.1)	36.2 (7.8)	204	29130.00	<b>30008.33</b>
3500 2.3CDTi BiTurbo (145PS) S/S BlueInjection	2059	1426	37.2 (7.6)	42.2 (6.7)	40.4 (7.0)	183	30240.00	<b>31118.33</b>
3500 2.3CDTi BiTurbo (170PS) S/S Tecshift BlueInjection	2059	1426	36.2 (7.8)	40.9 (6.9)	39.2 (7.2)	187	32365.00	<b>33243.33</b>

Please note: On-the-road recommended retail prices (RRP) include number plates and delivery to Retailer of £583.33 (exc. VAT), 12 months' Vehicle Excise Duty at £240.00 and new vehicle first registration fee of £55.00. Excludes fuel and insurance.

S/S = Start/Stop.

Vehicles with BlueInjection technology will need regular AdBlue® top-ups also between servicing requirements. An indicator integrated into the on-board computer will warn you when you need to top up. More information under [www.vauxhall.co.uk/blueinjection](http://www.vauxhall.co.uk/blueinjection). In accordance with regulations R (EC) No. 715/2007 and R (EC) No. 692/2008 (in the versions respectively applicable).

\* = For definitions please refer to Glossary of Terms.

# = Fuel consumption information is official government environmental data, tested in accordance with the relevant EU directive. Official EU-regulated test data is provided for comparison purposes and actual performance will depend on driving style, road conditions and other non-technical factors.

# MOVANO PANEL VAN PRICES

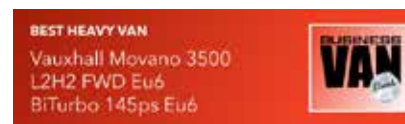

Model	Minimum Mass (kg)*	Payload (kg)*	Fuel economy mpg (litres/100km)#			CO <sub>2</sub> emissions (g/km)#	Price (£) exc. VAT	On-the-road RRP (£) exc. VAT
			Urban driving	Extra-urban driving	Combined figure			
<b>L3 H2 FWD PANEL VAN (EURO 6)</b>								
3500 2.3CDTi (110PS) BlueInjection	2090	1395	31.4 (9.0)	39.2 (7.2)	35.8 (7.9)	207	28330.00	<b>29208.33</b>
3500 2.3CDTi (110PS) S/S BlueInjection	2090	1395	34.4 (8.2)	39.2 (7.2)	37.2 (7.6)	197	28620.00	<b>29498.33</b>
3500 2.3CDTi (130PS) BlueInjection	2090	1395	31.4 (9.0)	39.2 (7.2)	35.8 (7.9)	207	29130.00	<b>30008.33</b>
3500 2.3CDTi BiTurbo (145PS) S/S BlueInjection	2099	1386	36.2 (7.8)	41.5 (6.8)	39.2 (7.2)	186	30240.00	<b>31118.33</b>
3500 2.3CDTi BiTurbo (170PS) S/S BlueInjection	2099	1386	36.7 (7.7)	40.4 (7.0)	38.7 (7.3)	189	31490.00	<b>32368.33</b>
3500 2.3CDTi BiTurbo (170PS) S/S Tecshift BlueInjection	2099	1386	35.8 (7.9)	40.4 (7.0)	38.7 (7.3)	189	32365.00	<b>33243.33</b>
<b>L3 H3 FWD PANEL VAN (EURO 6)</b>								
3500 2.3CDTi (110PS) BlueInjection	2130	1355	31.4 (9.0)	39.2 (7.2)	35.8 (7.9)	207	29030.00	<b>29908.33</b>
3500 2.3CDTi (130PS) BlueInjection	2130	1355	31.4 (9.0)	39.2 (7.2)	35.8 (7.9)	207	29830.00	<b>30708.33</b>
3500 2.3CDTi BiTurbo (145PS) S/S BlueInjection	2139	1346	36.2 (7.8)	41.5 (6.8)	39.2 (7.2)	186	30940.00	<b>31818.33</b>
<b>L3 H2 RWD PANEL VAN (EURO VIc)</b>								
3500 2.3CDTi BiTurbo (130PS) BlueInjection	2356	1129	30.4 (9.3)	32.5 (8.7)	31.4 (9.0)	232	30430.00	<b>31308.33</b>
3500 2.3CDTi BiTurbo (145PS) S/S BlueInjection	2356	1129	34.4 (8.2)	34.9 (8.1)	34.4 (8.2)	212	31540.00	<b>32418.33</b>
3500 HD 2.3CDTi BiTurbo (130PS) BlueInjection	2375	1110	29.4 (9.6)	30.7 (9.2)	30.4 (9.3)	242	31030.00	<b>31908.33</b>
3500 HD 2.3CDTi BiTurbo (145PS) S/S BlueInjection	2375	1110	33.2 (8.5)	32.8 (8.6)	32.8 (8.6)	222	32140.00	<b>33018.33</b>
4500 HD 2.3CDTi BiTurbo (130PS) Tacho BlueInjection	2375	2110	N/A	N/A	N/A	N/A	32505.00	<b>33308.33</b>
4500 HD 2.3CDTi BiTurbo (163PS) S/S Tacho BlueInjection	2375	2110	N/A	N/A	N/A	N/A	34865.00	<b>35668.33</b>
<b>L3 H3 RWD PANEL VAN (EURO VIc)</b>								
3500 2.3CDTi BiTurbo (130PS) BlueInjection	2356	1129	30.4 (9.3)	32.5 (8.7)	31.4 (9.0)	232	31130.00	<b>32008.33</b>
3500 2.3CDTi BiTurbo (145PS) S/S BlueInjection	2356	1129	34.4 (8.2)	34.9 (8.1)	34.4 (8.2)	212	32240.00	<b>33118.33</b>
3500 HD 2.3CDTi BiTurbo (130PS) BlueInjection	2408	1077	29.4 (9.6)	30.7 (9.2)	30.4 (9.3)	242	31730.00	<b>32608.33</b>
3500 HD 2.3CDTi BiTurbo (145PS) S/S BlueInjection	2408	1077	33.2 (8.5)	32.8 (8.6)	32.8 (8.6)	222	32840.00	<b>33718.33</b>
4500 HD 2.3CDTi BiTurbo (130PS) Tacho BlueInjection	2408	2077	N/A	N/A	N/A	N/A	33205.00	<b>34008.33</b>
4500 HD 2.3CDTi BiTurbo (163PS) S/S Tacho BlueInjection	2408	2077	N/A	N/A	N/A	N/A	35565.00	<b>36368.33</b>

Please note: On-the-road recommended retail prices (RRP) include number plates and delivery to Retailer of £583.33 (exc. VAT), 12 months' Vehicle Excise Duty at £240.00 and new vehicle first registration fee of £55.00. Excludes fuel and insurance.

S/S = Start/Stop.

Vehicles with BlueInjection technology will need regular AdBlue® top-ups also between servicing requirements. An indicator integrated into the on-board computer will warn you when you need to top up. More information under [www.vauxhall.co.uk/blueinjection](http://www.vauxhall.co.uk/blueinjection). In accordance with regulations R (EC) No. 715/2007 and R (EC) No. 692/2008 (in the versions respectively applicable).

\* = For definitions please refer to Glossary of Terms.

# = Fuel consumption information is official government environmental data, tested in accordance with the relevant EU directive. Official EU-regulated test data is provided for comparison purposes and actual performance will depend on driving style, road conditions and other non-technical factors.

# MOVANO PANEL VAN PRICES

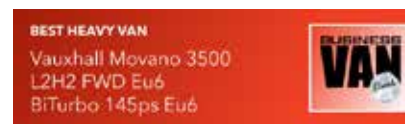

Model	Minimum Mass (kg)*	Payload (kg)*	Fuel economy mpg (litres/100km)#			CO <sub>2</sub> emissions (g/km)#	Price (£) exc. VAT	On-the-road RRP (£) exc. VAT
			Urban driving	Extra-urban driving	Combined figure			
<b>L4 H2 RWD PANEL VAN (EURO VIc)</b>								
3500 2.3CDTi BiTurbo (130PS) BlueInjection	2398	1087	30.4 (9.3)	32.5 (8.7)	31.4 (9.0)	232	31330.00	<b>32208.33</b>
3500 2.3CDTi BiTurbo (145PS) S/S BlueInjection	2398	1087	34.4 (8.2)	34.9 (8.1)	34.4 (8.2)	212	32440.00	<b>33318.33</b>
3500 2.3CDTi BiTurbo (163PS) S/S BlueInjection	2398	1087	34.4 (8.2)	34.9 (8.1)	34.4 (8.2)	212	33690.00	<b>34568.33</b>
3500 HD 2.3CDTi BiTurbo (130PS) BlueInjection	2453	1032	29.4 (9.6)	30.7 (9.2)	30.4 (9.3)	242	31930.00	<b>32808.33</b>
3500 HD 2.3CDTi BiTurbo (145PS) S/S BlueInjection	2453	1032	33.2 (8.5)	32.8 (8.6)	32.8 (8.6)	222	33040.00	<b>33918.33</b>
4500 HD 2.3CDTi BiTurbo (130PS) Tacho BlueInjection	2453	2032	N/A	N/A	N/A	N/A	33405.00	<b>34208.33</b>
4500 HD 2.3CDTi BiTurbo (163PS) S/S Tacho BlueInjection	2453	2032	N/A	N/A	N/A	N/A	35765.00	<b>36568.33</b>
<b>L4 H3 RWD PANEL VAN (EURO VIc)</b>								
3500 2.3CDTi BiTurbo (130PS) BlueInjection	2429	1056	30.4 (9.3)	32.5 (8.7)	31.4 (9.0)	232	32030.00	<b>32908.33</b>
3500 2.3CDTi BiTurbo (145PS) S/S BlueInjection	2429	1056	34.4 (8.2)	34.9 (8.1)	34.4 (8.2)	212	33140.00	<b>34018.33</b>
3500 2.3CDTi BiTurbo (163PS) S/S BlueInjection	2429	1056	34.4 (8.2)	34.9 (8.1)	34.4 (8.2)	212	34390.00	<b>35268.33</b>
3500 HD 2.3CDTi BiTurbo (130PS) BlueInjection	2495	990	29.4 (9.6)	30.7 (9.2)	30.4 (9.3)	242	32630.00	<b>33508.33</b>
3500 HD 2.3CDTi BiTurbo (145PS) S/S BlueInjection	2495	990	33.2 (8.5)	32.8 (8.6)	32.8 (8.6)	222	33740.00	<b>34618.33</b>
4500 HD 2.3CDTi BiTurbo (130PS) Tacho BlueInjection	2495	1990	N/A	N/A	N/A	N/A	34105.00	<b>34908.33</b>
4500 HD 2.3CDTi BiTurbo (163PS) S/S Tacho BlueInjection	2495	1990	N/A	N/A	N/A	N/A	36465.00	<b>37268.33</b>

Please note: On-the-road recommended retail prices (RRP) include number plates and delivery to Retailer of £583.33 (exc. VAT), 12 months' Vehicle Excise Duty at £240.00 and new vehicle first registration fee of £55.00. Excludes fuel and insurance.

S/S = Start/Stop.

Vehicles with BlueInjection technology will need regular AdBlue® top-ups also between servicing requirements. An indicator integrated into the on-board computer will warn you when you need to top up. More information under [www.vauxhall.co.uk/blueinjection](http://www.vauxhall.co.uk/blueinjection). In accordance with regulations R (EC) No. 715/2007 and R (EC) No. 692/2008 (in the versions respectively applicable).

\* = For definitions please refer to Glossary of Terms.

# = Fuel consumption information is official government environmental data, tested in accordance with the relevant EU directive. Official EU-regulated test data is provided for comparison purposes and actual performance will depend on driving style, road conditions and other non-technical factors.

# MOVANO DOUBLECAB PRICES

Model	Minimum Mass (kg)*	Payload (kg)*	Fuel economy mpg (litres/100km)#			CO <sub>2</sub> emissions (g/km)#	Price (£) exc. VAT	On-the-road RRP (£) exc. VAT
			Urban driving	Extra-urban driving	Combined figure			
<b>L2 H2 FWD DOUBLECAB (EURO 6)</b>								
3500 2.3CDTi (130PS) BlueInjection	2205	1305	31.4 (9.0)	39.2 (7.2)	35.8 (7.9)	207	30080.00	<b>30958.33</b>
3500 2.3CDTi BiTurbo (145PS) S/S BlueInjection	2205	1305	36.2 (7.8)	41.5 (6.8)	39.2 (7.2)	186	31190.00	<b>32068.33</b>
3500 2.3CDTi BiTurbo (170PS) S/S Tecshift BlueInjection	2205	1305	36.7 (7.7)	40.4 (7.0)	38.7 (7.3)	189	33315.00	<b>34193.33</b>
<b>L3 H2 FWD DOUBLECAB (EURO 6)</b>								
3500 2.3CDTi (130PS) BlueInjection	2286	1224	31.4 (9.0)	39.2 (7.2)	35.8 (7.9)	207	30780.00	<b>31658.33</b>
3500 2.3CDTi BiTurbo (145PS) S/S BlueInjection	2286	1224	36.2 (7.8)	41.5 (6.8)	39.2 (7.2)	186	31890.00	<b>32768.33</b>
3500 2.3CDTi BiTurbo (170PS) S/S Tecshift BlueInjection	2286	1224	36.7 (7.7)	40.4 (7.0)	38.7 (7.3)	189	34015.00	<b>34893.33</b>
<b>L3 H2 RWD DOUBLECAB (EURO VIc)</b>								
3500 2.3CDTi BiTurbo (130PS) BlueInjection	2553	957	30.4 (9.3)	32.5 (8.7)	31.4 (9.0)	232	32080.00	<b>32958.33</b>
3500 2.3CDTi BiTurbo (145PS) S/S BlueInjection	2553	957	34.4 (8.2)	34.9 (8.1)	34.4 (8.2)	212	33190.00	<b>34068.33</b>

Please note: On-the-road recommended retail prices (RRP) include number plates and delivery to Retailer of £583.33 (exc. VAT), 12 months' Vehicle Excise Duty at £240.00 and new vehicle first registration fee of £55.00. Excludes fuel and insurance.

S/S = Start/Stop.

Vehicles with BlueInjection technology will need regular AdBlue® top-ups also between servicing requirements. An indicator integrated into the on-board computer will warn you when you need to top up. More information under [www.vauxhall.co.uk/blueinjection](http://www.vauxhall.co.uk/blueinjection). In accordance with regulations R (EC) No. 715/2007 and R (EC) No. 692/2008 (in the versions respectively applicable).

\* = For definitions please refer to Glossary of Terms.

# = Fuel consumption information is official government environmental data, tested in accordance with the relevant EU directive. Official EU-regulated test data is provided for comparison purposes and actual performance will depend on driving style, road conditions and other non-technical factors.

# MOVANO CHASSIS CAB PRICES

Model	Minimum Mass (kg)*	Payload and Body Allowance (kg)*	Fuel economy mpg (litres/100km)#			CO <sub>2</sub> emissions (g/km)#	Price (£) exc. VAT	On-the-road RRP (£) exc. VAT
			Urban driving	Extra-urban driving	Combined figure			
<b>L2 H1 FWD CHASSIS CAB (EURO 6)</b>								
3500 2.3CDTi (110PS) BlueInjection	1784	1756	30.4 (9.3)	37.7 (7.5)	34.4 (8.2)	212	25930.00	<b>26808.33</b>
3500 2.3CDTi (130PS) BlueInjection	1784	1756	30.4 (9.3)	37.7 (7.5)	34.4 (8.2)	212	26730.00	<b>27608.33</b>
3500 2.3CDTi BiTurbo (145PS) S/S BlueInjection	1793	1747	35.8 (7.9)	39.8 (7.1)	38.2 (7.4)	192	27840.00	<b>28718.33</b>
<b>L3 H1 FWD CHASSIS CAB (EURO 6)</b>								
3500 2.3CDTi (110PS) BlueInjection	1810	1730	30.4 (9.3)	37.7 (7.5)	34.4 (8.2)	212	26430.00	<b>27308.33</b>
3500 2.3CDTi (130PS) BlueInjection	1810	1730	30.4 (9.3)	37.7 (7.5)	34.4 (8.2)	212	27230.00	<b>28108.33</b>
3500 2.3CDTi BiTurbo (145PS) S/S BlueInjection	1819	1721	35.8 (7.9)	39.8 (7.1)	38.2 (7.4)	192	28340.00	<b>29218.33</b>
<b>L2 H1 RWD CHASSIS CAB (EURO Vic)</b>								
3500 2.3CDTi (130PS) BlueInjection	1928	1612	30.4 (9.3)	32.5 (8.7)	31.4 (9.0)	232	28030.00	<b>28908.33</b>
3500 2.3CDTi BiTurbo (145PS) S/S BlueInjection	1928	1612	34.4 (8.2)	34.9 (8.1)	34.4 (8.2)	212	29140.00	<b>30018.33</b>
3500 HD 2.3CDTi (130PS) BlueInjection	2095	1445	29.4 (9.6)	30.7 (9.2)	30.4 (9.3)	242	28645.00	<b>29523.33</b>
3500 HD 2.3CDTi BiTurbo (145PS) S/S BlueInjection	2095	1445	33.2 (8.5)	32.8 (8.6)	32.8 (8.6)	222	29755.00	<b>30633.33</b>
4500 HD 2.3CDTi (130PS) BlueInjection	2095	2445	N/A	N/A	N/A	N/A	30120.00	<b>30923.33</b>
4500 HD 2.3CDTi BiTurbo (163PS) S/S Tacho BlueInjection	2095	2445	N/A	N/A	N/A	N/A	32480.00	<b>33283.33</b>
<b>L3 H1 RWD CHASSIS CAB (EURO Vic)</b>								
3500 2.3CDTi BiTurbo (130PS) BlueInjection	1979	1561	30.4 (9.3)	32.5 (8.7)	31.4 (9.0)	232	28530.00	<b>29408.33</b>
3500 2.3CDTi BiTurbo (145PS) S/S BlueInjection	1979	1561	34.4 (8.2)	34.9 (8.1)	34.4 (8.2)	212	29640.00	<b>30518.33</b>
3500 HD 2.3CDTi BiTurbo (130PS) BlueInjection	2103	1437	29.4 (9.6)	30.7 (9.2)	30.4 (9.3)	242	29130.00	<b>30008.33</b>
3500 HD 2.3CDTi BiTurbo (145PS) S/S BlueInjection	2103	1437	33.2 (8.5)	32.8 (8.6)	32.8 (8.6)	222	30240.00	<b>31118.33</b>
4500 HD 2.3CDTi BiTurbo (130PS) Tacho BlueInjection	2095	2445	N/A	N/A	N/A	N/A	30605.00	<b>31408.33</b>
4500 HD 2.3CDTi BiTurbo (163PS) S/S Tacho BlueInjection	2095	2445	N/A	N/A	N/A	N/A	32965.00	<b>33768.33</b>
<b>L4 H1 RWD CHASSIS CAB (EURO Vic)</b>								
3500 HD 2.3CDTi BiTurbo (130PS) BlueInjection	2133	1407	29.4 (9.6)	30.7 (9.2)	30.4 (9.3)	242	29830.00	<b>30708.33</b>
3500 HD 2.3CDTi BiTurbo (145PS) S/S BlueInjection	2133	1407	33.2 (8.5)	32.8 (8.6)	32.8 (8.6)	222	30940.00	<b>31818.33</b>
4500 HD 2.3CDTi BiTurbo (130PS) Tacho BlueInjection	2133	2407	N/A	N/A	N/A	N/A	31305.00	<b>32108.33</b>
4500 HD 2.3CDTi BiTurbo (163PS) S/S Tacho BlueInjection	2133	2407	N/A	N/A	N/A	N/A	33665.00	<b>34468.33</b>

**Please note:** On-the-road recommended retail prices (RRP) include number plates and delivery to Retailer of £583.33 (exc. VAT), 12 months' Vehicle Excise Duty at £240.00 and new vehicle first registration fee of £55.00. Excludes fuel and insurance.

S/S = Start/Stop.

Vehicles with BlueInjection technology will need regular AdBlue® top-ups also between servicing requirements. An indicator integrated into the on-board computer will warn you when you need to top up. More information under [www.vauxhall.co.uk/blueinjection](http://www.vauxhall.co.uk/blueinjection). In accordance with regulations R (EC) No. 715/2007 and R (EC) No. 692/2008 (in the versions respectively applicable).

All conversions must follow 'Vauxhall Convertor Requirements' including recommended dimensional data, detailed within Part 1, available at: [www.vauxhall.co.uk/conversiondata](http://www.vauxhall.co.uk/conversiondata). The weight of any fitted conversion body will have to be deducted from these figures to establish actual payload and is subject to correct weight distribution. Variations from the recommended dimensions or weights may affect the vehicle's overall centre of gravity and stability. From 29 April 2013 conversion of N1 vehicles was affected by changes to type approval – for further information refer to the VCA website (N2 vehicles were affected from 29 October 2014). For further information please contact [conversions@vauxhall.co.uk](mailto:conversions@vauxhall.co.uk)

\* = For definitions please refer to Glossary of Terms.

# = Fuel consumption information is official government environmental data, tested in accordance with the relevant EU directive. Official EU-regulated test data is provided for comparison purposes and actual performance will depend on driving style, road conditions and other non-technical factors.

**All conversions must follow 'Conversion Requirements' available on: [www.vauxhall.co.uk/conversiondata](http://www.vauxhall.co.uk/conversiondata)**

# MOVANO CREW CAB PRICES

Model	Minimum Mass (kg)*	Payload and Body Allowance (kg)*	Fuel economy mpg (litres/100km)#			CO <sub>2</sub> emissions (g/km)#	Price (£) exc. VAT	On-the-road RRP (£) exc. VAT
			Urban driving	Extra-urban driving	Combined figure			
<b>L2 H1 FWD CREW CAB (EURO 6)</b>								
3500 2.3CDTi (130PS) BlueInjection	1990	1550	30.4 (9.3)	37.7 (7.5)	34.4 (8.2)	212	27630.00	<b>28508.33</b>
3500 2.3CDTi BiTurbo (145PS) S/S BlueInjection	1999	1541	35.8 (7.9)	39.8 (7.1)	38.2 (7.4)	192	28740.00	<b>29618.33</b>
<b>L3 H1 FWD CREW CAB (EURO 6)</b>								
3500 2.3CDTi (130PS) BlueInjection	2034	1506	30.4 (9.3)	37.7 (7.5)	34.4 (8.2)	212	28130.00	<b>29008.33</b>
3500 2.3CDTi BiTurbo (145PS) S/S BlueInjection	2043	1497	35.8 (7.9)	39.8 (7.1)	38.2 (7.4)	192	29240.00	<b>30118.33</b>
<b>L2 H1 RWD CREW CAB (EURO VIc)</b>								
3500 2.3CDTi BiTurbo (130PS) BlueInjection	2164	1376	30.4 (9.3)	32.5 (8.7)	31.4 (9.0)	232	28930.00	<b>29808.33</b>
3500 2.3CDTi BiTurbo (145PS) S/S BlueInjection	2164	1376	34.4 (8.2)	34.9 (8.1)	34.4 (8.2)	212	30040.00	<b>30918.33</b>
<b>L3 H1 RWD CREW CAB (EURO VIc)</b>								
3500 2.3CDTi BiTurbo (130PS) BlueInjection	2197	1343	30.4 (9.3)	32.5 (8.7)	31.4 (9.0)	232	29430.00	<b>30308.33</b>
3500 2.3CDTi BiTurbo (145PS) S/S BlueInjection	2197	1343	34.4 (8.2)	34.9 (8.1)	34.4 (8.2)	212	30540.00	<b>31418.33</b>
3500 HD 2.3CDTi BiTurbo (130PS) BlueInjection	2283	1257	29.4 (9.6)	30.7 (9.2)	30.4 (9.3)	242	30030.00	<b>30908.33</b>
3500 HD 2.3CDTi BiTurbo (145PS) S/S BlueInjection	2283	1257	33.2 (8.5)	32.8 (8.6)	32.8 (8.6)	222	31140.00	<b>32018.33</b>
4500 HD 2.3CDTi BiTurbo (130PS) Tacho BlueInjection	2283	2257	N/A	N/A	N/A	N/A	31505.00	<b>32308.33</b>
4500 HD 2.3CDTi BiTurbo (163PS) S/S Tacho BlueInjection	2283	2257	N/A	N/A	N/A	N/A	33865.00	<b>34668.33</b>
<b>L4 H1 RWD CREW CAB (EURO VIc)</b>								
3500 HD 2.3CDTi BiTurbo (130PS) BlueInjection	2352	1188	29.4 (9.6)	30.7 (9.2)	30.4 (9.3)	242	30730.00	<b>31608.33</b>
3500 HD 2.3CDTi BiTurbo (145PS) S/S BlueInjection	2352	1188	33.2 (8.5)	32.8 (8.6)	32.8 (8.6)	222	31840.00	<b>32718.33</b>
4500 HD 2.3CDTi BiTurbo (130PS) Tacho BlueInjection	2352	2188	N/A	N/A	N/A	N/A	32205.00	<b>33008.33</b>
4500 HD 2.3CDTi BiTurbo (163PS) S/S Tacho BlueInjection	2352	2188	N/A	N/A	N/A	N/A	34565.00	<b>35368.33</b>

**Please note:** On-the-road recommended retail prices (RRP) include number plates and delivery to Retailer of £583.33 (exc. VAT), 12 months' Vehicle Excise Duty at £240.00 (£165.00 on 4500kg models) and new vehicle first registration fee of £55.00. Excludes fuel and insurance.

S/S = Start/Stop.

Vehicles with BlueInjection technology will need regular AdBlue® top-ups also between servicing requirements. An indicator integrated into the on-board computer will warn you when you need to top up. More information under [www.vauxhall.co.uk/blueinjection](http://www.vauxhall.co.uk/blueinjection). In accordance with regulations R (EC) No. 715/2007 and R (EC) No. 692/2008 (in the versions respectively applicable).

All conversions must follow 'Vauxhall Converter Requirements' including recommended dimensional data, detailed within Part 1, available at: [www.vauxhall.co.uk/conversiondata](http://www.vauxhall.co.uk/conversiondata). The weight of any fitted conversion body will have to be deducted from these figures to establish actual payload and is subject to correct weight distribution. Variations from the recommended dimensions or weights may affect the vehicle's overall centre of gravity and stability. From 29 April 2013 conversion of N1 vehicles was affected by changes to type approval – for further information refer to the VCA website (N2 vehicles were affected from 29 October 2014). For further information please contact [conversions@vauxhall.co.uk](mailto:conversions@vauxhall.co.uk)

\* = For definitions please refer to Glossary of Terms.

# = Fuel consumption information is official government environmental data, tested in accordance with the relevant EU directive. Official EU-regulated test data is provided for comparison purposes and actual performance will depend on driving style, road conditions and other non-technical factors.

All conversions must follow 'Conversion Requirements' available on: [www.vauxhall.co.uk/conversiondata](http://www.vauxhall.co.uk/conversiondata)



# MOVANO PLATFORM CAB PRICES

Model	Minimum Mass (kg)*	Payload and Body Allowance (kg)*	Fuel economy mpg (litres/100km)#			CO <sub>2</sub> emissions (g/km)#	Price (£) exc. VAT	On-the-road RRP (£) exc. VAT
			Urban driving	Extra-urban driving	Combined figure			
<b>L2 H1 FWD PLATFORM CAB (EURO 6)</b>								
3500 2.3CDTi (130PS) BlueInjection	1697	1843	31.4 (9.0)	39.2 (7.2)	35.8 (7.9)	207	26730.00	<b>27608.33</b>
<b>L2 H2 FWD PLATFORM CAB (EURO 6)</b>								
3500 2.3CDTi (130PS) BlueInjection	1711	1829	31.4 (9.0)	39.2 (7.2)	35.8 (7.9)	207	27330.00	<b>28208.33</b>
<b>L3 H1 FWD PLATFORM CAB (EURO 6)</b>								
3500 2.3CDTi (110PS) BlueInjection	1719	1821	31.4 (9.0)	39.2 (7.2)	35.8 (7.9)	207	26430.00	<b>27308.33</b>
3500 2.3CDTi (130PS) BlueInjection	1719	1821	31.4 (9.0)	39.2 (7.2)	35.8 (7.9)	207	27230.00	<b>28108.33</b>
3500 2.3CDTi BiTurbo (145PS) S/S BlueInjection	1728	1812	35.8 (7.9)	39.8 (7.1)	38.2 (7.4)	192	28340.00	<b>29218.33</b>
<b>L3 H2 FWD PLATFORM CAB (EURO 6)</b>								
3500 2.3CDTi (130PS) BlueInjection	1735	1805	30.4 (9.3)	37.7 (7.5)	34.4 (8.2)	212	27830.00	<b>28708.33</b>
3500 2.3CDTi BiTurbo (145PS) S/S BlueInjection	1744	1796	35.8 (7.9)	39.8 (7.1)	38.2 (7.4)	192	28940.00	<b>29818.33</b>

Please note: On-the-road recommended retail prices (RRP) include number plates and delivery to Retailer of £583.33 (exc. VAT), 12 months' Vehicle Excise Duty at £240.00 and new vehicle first registration fee of £55.00. Excludes fuel and insurance.

S/S = Start/Stop.

Vehicles with BlueInjection technology will need regular AdBlue® top-ups also between servicing requirements. An indicator integrated into the on-board computer will warn you when you need to top up. More information under [www.vauxhall.co.uk/blueinjection](http://www.vauxhall.co.uk/blueinjection). In accordance with regulations R (EC) No. 715/2007 and R (EC) No. 692/2008 (in the versions respectively applicable).

All conversions must follow 'Vauxhall Converter Requirements' including recommended dimensional data, detailed within Part 1, available at: [www.vauxhall.co.uk/conversiondata](http://www.vauxhall.co.uk/conversiondata). The weight of any fitted conversion body will have to be deducted from these figures to establish actual payload and is subject to correct weight distribution. Variations from the recommended dimensions or weights may affect the vehicle's overall centre of gravity and stability. From 29 April 2013 conversion of N1 vehicles was affected by changes to type approval – for further information refer to the VCA website (N2 vehicles were affected from 29 October 2014). For further information please contact [conversions@vauxhall.co.uk](mailto:conversions@vauxhall.co.uk)

\* = For definitions please refer to Glossary of Terms.

# = Fuel consumption information is official government environmental data, tested in accordance with the relevant EU directive. Official EU-regulated test data is provided for comparison purposes and actual performance will depend on driving style, road conditions and other non-technical factors.

All conversions must follow 'Conversion Requirements' available on: [www.vauxhall.co.uk/conversiondata](http://www.vauxhall.co.uk/conversiondata)

# MOVANO TIPPER PRICES

Model	Minimum Mass (kg)*	Payload (kg)*	Fuel economy mpg (litres/100km)#			CO <sub>2</sub> emissions (g/km)#	Price (£) exc. VAT	On-the-road RRP (£) exc. VAT
			Urban driving	Extra-urban driving	Combined figure			
<b>L2 H1 FWD CHASSIS CAB TIPPER (EURO 6)</b>								
3500 2.3CDTi (130PS) BlueInjection	2381	1159	31.4 (9.0)	39.2 (7.2)	35.8 (7.9)	207	30480.00	<b>31358.33</b>
3500 2.3CDTi BiTurbo (145PS) S/S BlueInjection	2391	1149	36.2 (7.8)	40.4 (7.0)	38.7 (7.3)	189	31590.00	<b>32468.33</b>
3500 2.3CDTi BiTurbo (170PS) S/S BlueInjection	2391	1149	35.8 (7.9)	39.8 (7.1)	38.2 (7.4)	192	32840.00	<b>33718.33</b>
<b>L2 H1 RWD CHASSIS CAB TIPPER (EURO VIc)</b>								
3500 HD 2.3CDTi BiTurbo (130PS) BlueInjection	2661	879	29.4 (9.6)	30.7 (9.2)	30.4 (9.3)	242	32380.00	<b>33258.33</b>
3500 HD 2.3CDTi BiTurbo (145PS) S/S BlueInjection	2661	879	33.2 (8.5)	32.8 (8.6)	32.8 (8.6)	222	33490.00	<b>34368.33</b>
3500 HD 2.3CDTi BiTurbo (163PS) S/S BlueInjection	2661	879	33.2 (8.5)	32.8 (8.6)	32.8 (8.6)	222	34740.00	<b>35618.33</b>
4500 HD 2.3CDTi BiTurbo (130PS) Tacho BlueInjection	2661	1879	N/A	N/A	N/A	N/A	33855.00	<b>34658.33</b>
4500 HD 2.3CDTi BiTurbo (163PS) S/S Tacho BlueInjection	2661	1879	N/A	N/A	N/A	N/A	36215.00	<b>37018.33</b>
<b>L3 H1 RWD CHASSIS CAB TIPPER (EURO VIc)</b>								
3500 HD 2.3CDTi BiTurbo (130PS) BlueInjection	2773	767	29.4 (9.6)	30.7 (9.2)	30.4 (9.3)	242	34080.00	<b>34958.33</b>
3500 HD 2.3CDTi BiTurbo (145PS) S/S BlueInjection	2773	767	33.2 (8.5)	32.8 (8.6)	32.8 (8.6)	222	35190.00	<b>36068.33</b>
4500 HD 2.3CDTi BiTurbo (130PS) Tacho BlueInjection	2773	1617	N/A	N/A	N/A	N/A	35555.00	<b>36358.33</b>
4500 HD 2.3CDTi BiTurbo (163PS) S/S Tacho BlueInjection	2773	1617	N/A	N/A	N/A	N/A	37915.00	<b>38718.33</b>
<b>L3 H1 FWD CREW CAB TIPPER (EURO 6)</b>								
3500 2.3CDTi (130PS) BlueInjection	2511	1029	30.7 (9.2)	38.2 (7.4)	34.9 (8.1)	210	31880.00	<b>32758.33</b>
3500 2.3CDTi BiTurbo (145PS) S/S BlueInjection	2520	1020	36.2 (7.8)	40.4 (7.0)	38.7 (7.3)	189	32990.00	<b>33868.33</b>
<b>L3 H1 RWD CREW CAB TIPPER (EURO VIc)</b>								
4500 HD 2.3CDTi BiTurbo (130PS) Tacho BlueInjection	2830	1710	N/A	N/A	N/A	N/A	35255.00	<b>36058.33</b>
4500 HD 2.3CDTi BiTurbo (163PS) S/S Tacho BlueInjection	2830	1710	N/A	N/A	N/A	N/A	37615.00	<b>38418.33</b>

**Please note:** On-the-road recommended retail prices (RRP) include number plates and delivery to Retailer of £583.33 (exc. VAT), 12 months' Vehicle Excise Duty at £240.00 (£165.00 on 4500kg models) and new vehicle first registration fee of £55.00. Excludes fuel and insurance. S/S = Start/Stop.

Vehicles with BlueInjection technology will need regular AdBlue® top-ups also between servicing requirements. An indicator integrated into the on-board computer will warn you when you need to top up. More information under [www.vauxhall.co.uk/blueinjection](http://www.vauxhall.co.uk/blueinjection). In accordance with regulations R (EC) No. 715/2007 and R (EC) No. 692/2008 (in the versions respectively applicable).

\* = For definitions please refer to Glossary of Terms.

# = Fuel consumption information is official government environmental data, tested in accordance with the relevant EU directive. Official EU-regulated test data is provided for comparison purposes and actual performance will depend on driving style, road conditions and other non-technical factors.

# MOVANO DROPSIDE PRICES

Model	Minimum Mass (kg)*	Payload (kg)*	Fuel economy mpg (litres/100km)#			CO <sub>2</sub> emissions (g/km)#	Price (£) exc. VAT	On-the-road RRP (£) exc. VAT
			Urban driving	Extra-urban driving	Combined figure			
<b>L2 H1 FWD CHASSIS CAB DROPSIDE (EURO 6)</b>								
3500 2.3CDTi (130PS) BlueInjection	2156	1384	31.7 (8.9)	39.8 (7.1)	36.2 (7.8)	204	28680.00	<b>29558.33</b>
3500 2.3CDTi BiTurbo (145PS) S/S BlueInjection	2166	1374	37.2 (7.6)	42.2 (6.7)	40.4 (7.0)	183	29790.00	<b>30668.33</b>
<b>L3 H1 FWD CHASSIS CAB DROPSIDE (EURO 6)</b>								
3500 2.3CDTi (130PS) BlueInjection	2228	1312	31.4 (9.0)	39.2 (7.2)	35.8 (7.9)	207	29680.00	<b>30558.33</b>
3500 2.3CDTi BiTurbo (145PS) S/S BlueInjection	2237	1303	36.2 (7.8)	41.5 (6.8)	39.2 (7.2)	186	30790.00	<b>31668.33</b>
<b>L2 H1 RWD CHASSIS CAB DROPSIDE (EURO VIc)</b>								
3500 2.3CDTi BiTurbo (130PS) BlueInjection	2356	1184	30.4 (9.3)	32.5 (8.7)	31.4 (9.0)	232	29980.00	<b>30858.33</b>
3500 2.3CDTi BiTurbo (145PS) S/S BlueInjection	2356	1184	34.4 (8.2)	34.9 (8.1)	34.4 (8.2)	212	31090.00	<b>31968.33</b>
3500 HD 2.3CDTi BiTurbo (130PS) BlueInjection	2447	1093	29.4 (9.6)	30.7 (9.2)	30.4 (9.3)	242	30595.00	<b>31473.33</b>
3500 HD 2.3CDTi BiTurbo (145PS) S/S BlueInjection	2447	1093	33.2 (8.5)	32.8 (8.6)	32.8 (8.6)	222	31705.00	<b>32583.33</b>
4500 HD 2.3CDTi BiTurbo (130PS) Tacho BlueInjection	2447	2093	N/A	N/A	N/A	N/A	32070.00	<b>32873.33</b>
4500 HD 2.3CDTi BiTurbo (163PS) S/S Tacho BlueInjection	2447	2093	N/A	N/A	N/A	N/A	34430.00	<b>35233.33</b>
<b>L3 H1 RWD CHASSIS CAB DROPSIDE (EURO VIc)</b>								
3500 HD 2.3CDTi BiTurbo (130PS) BlueInjection	2491	1049	29.4 (9.6)	30.7 (9.2)	30.4 (9.3)	242	31580.00	<b>32458.33</b>
3500 HD 2.3CDTi BiTurbo (145PS) S/S BlueInjection	2491	1049	33.2 (8.5)	32.8 (8.6)	32.8 (8.6)	222	32690.00	<b>33568.33</b>
4500 HD 2.3CDTi BiTurbo (130PS) Tacho BlueInjection	2496	2044	N/A	N/A	N/A	N/A	33055.00	<b>33858.33</b>
4500 HD 2.3CDTi BiTurbo (163PS) S/S Tacho BlueInjection	2496	2044	N/A	N/A	N/A	N/A	35415.00	<b>36218.33</b>
<b>L4 H1 RWD CHASSIS CAB DROPSIDE (EURO VIc)</b>								
3500 HD 2.3CDTi BiTurbo (130PS) BlueInjection	2576	964	29.4 (9.6)	30.7 (9.2)	30.4 (9.3)	242	32280.00	<b>33158.33</b>
3500 HD 2.3CDTi BiTurbo (145PS) S/S BlueInjection	2576	964	33.2 (8.5)	32.8 (8.6)	32.8 (8.6)	222	33390.00	<b>34268.33</b>
4500 HD 2.3CDTi BiTurbo (130PS) Tacho BlueInjection	2581	1959	N/A	N/A	N/A	N/A	33755.00	<b>34558.33</b>
4500 HD 2.3CDTi BiTurbo (163PS) S/S Tacho BlueInjection	2581	1959	N/A	N/A	N/A	N/A	36115.00	<b>36918.33</b>

Please note: On-the-road recommended retail prices (RRP) include number plates and delivery to Retailer of £583.33 (exc. VAT), 12 months' Vehicle Excise Duty at £240.00 (£165.00 on 4500kg models) and new vehicle first registration fee of £55.00. Excludes fuel and insurance.

S/S = Start/Stop.

Vehicles with BlueInjection technology will need regular AdBlue® top-ups also between servicing requirements. An indicator integrated into the on-board computer will warn you when you need to top up. More information under [www.vauxhall.co.uk/blueinjection](http://www.vauxhall.co.uk/blueinjection). In accordance with regulations R (EC) No. 715/2007 and R (EC) No. 692/2008 (in the versions respectively applicable).

\* = For definitions please refer to Glossary of Terms.

# = Fuel consumption information is official government environmental data, tested in accordance with the relevant EU directive. Official EU-regulated test data is provided for comparison purposes and actual performance will depend on driving style, road conditions and other non-technical factors.

# MOVANO DROPSIDE PRICES

Model	Minimum Mass (kg)*	Payload (kg)*	Fuel economy mpg (litres/100km)#			CO <sub>2</sub> emissions (g/km)#	Price (£) exc. VAT	On-the-road RRP (£) exc. VAT
			Urban driving	Extra-urban driving	Combined figure			
<b>L2 H1 FWD CREW CAB DROPSIDE (EURO 6)</b>								
3500 2.3CDTi (130PS) BlueInjection	2313	1227	31.4 (9.0)	39.2 (7.2)	35.8 (7.9)	207	29580.00	<b>30458.33</b>
3500 2.3CDTi BiTurbo (145PS) S/S BlueInjection	2322	1218	36.2 (7.8)	41.5 (6.8)	39.2 (7.2)	186	30690.00	<b>31568.33</b>
<b>L3 H1 FWD CREW CAB DROPSIDE (EURO 6)</b>								
3500 2.3CDTi (130PS) BlueInjection	2384	1156	31.4 (9.0)	39.2 (7.2)	35.8 (7.9)	207	30080.00	<b>30958.33</b>
3500 2.3CDTi BiTurbo (145PS) S/S BlueInjection	2393	1147	36.2 (7.8)	41.5 (6.8)	39.2 (7.2)	186	31190.00	<b>32068.33</b>
3500 2.3CDTi BiTurbo (170PS) S/S BlueInjection	2393	1147	36.7 (7.7)	40.4 (7.0)	38.7 (7.3)	189	32440.00	<b>33318.33</b>
<b>L2 H1 RWD CREW CAB DROPSIDE (EURO VIc)</b>								
3500 2.3CDTi BiTurbo (130PS) BlueInjection	2471	1069	30.4 (9.3)	32.5 (8.7)	31.4 (9.0)	232	30880.00	<b>31758.33</b>
3500 2.3CDTi BiTurbo (145PS) S/S BlueInjection	2471	1069	34.4 (8.2)	34.9 (8.1)	34.4 (8.2)	212	31990.00	<b>32868.33</b>
<b>L3 H1 RWD CREW CAB DROPSIDE (EURO VIc)</b>								
4500 HD 2.3CDTi BiTurbo (130PS) Tacho BlueInjection	2642	1898	N/A	N/A	N/A	N/A	33455.00	<b>34258.33</b>
4500 HD 2.3CDTi BiTurbo (163PS) S/S Tacho BlueInjection	2642	1898	N/A	N/A	N/A	N/A	35815.00	<b>36618.33</b>
<b>L4 H1 RWD CREW CAB DROPSIDE (EURO VIc)</b>								
4500 HD 2.3CDTi BiTurbo (130PS) Tacho BlueInjection	2626	1914	N/A	N/A	N/A	N/A	34655.00	<b>35458.33</b>
4500 HD 2.3CDTi BiTurbo (163PS) S/S Tacho BlueInjection	2626	1914	N/A	N/A	N/A	N/A	37015.00	<b>37818.33</b>

**Please note:** On-the-road recommended retail prices (RRP) include number plates and delivery to Retailer of £583.33 (exc. VAT), 12 months' Vehicle Excise Duty at £240.00 (£165.00 on 4500kg models) and new vehicle first registration fee of £55.00. Excludes fuel and insurance. S/S = Start/Stop.

Vehicles with BlueInjection technology will need regular AdBlue® top-ups also between servicing requirements. An indicator integrated into the on-board computer will warn you when you need to top up. More information under [www.vauxhall.co.uk/blueinjection](http://www.vauxhall.co.uk/blueinjection). In accordance with regulations R (EC) No. 715/2007 and R (EC) No. 692/2008 (in the versions respectively applicable).

\* = For definitions please refer to Glossary of Terms.

# = Fuel consumption information is official government environmental data, tested in accordance with the relevant EU directive. Official EU-regulated test data is provided for comparison purposes and actual performance will depend on driving style, road conditions and other non-technical factors.

# MOVANO BOX VAN PRICES

Model	Minimum Mass (kg)*	Payload (kg)*	Fuel economy mpg (litres/100km)#			CO <sub>2</sub> emissions (g/km)#	Price (£) exc. VAT	On-the-road RRP (£) exc. VAT
			Urban driving	Extra-urban driving	Combined figure			
<b>L3 H1 FWD CHASSIS CAB BOX VAN 20 cu.m (EURO 6)</b>								
3500 2.3CDTi (130PS) BlueInjection	2400	1140	30.7 (9.2)	38.2 (7.4)	34.9 (8.1)	210	32910.00	<b>33788.33</b>
3500 2.3CDTi BiTurbo (145PS) S/S BlueInjection	2400	1140	36.2 (7.8)	40.4 (7.0)	38.7 (7.3)	189	34020.00	<b>34898.33</b>
3500 2.3CDTi (170PS) BiTurbo S/S BlueInjection	2400	1140	35.8 (7.9)	39.8 (7.1)	38.2 (7.4)	192	35270.00	<b>36148.33</b>
<b>L3 H1 RWD CHASSIS CAB BOX VAN 20 cu.m (EURO VIc)</b>								
3500 2.3CDTi BiTurbo (130PS) BlueInjection	2560	980	30.4 (9.3)	32.5 (8.7)	31.4 (9.0)	232	35410.00	<b>36288.33</b>
3500 2.3CDTi BiTurbo (145PS) S/S BlueInjection	2560	980	34.4 (8.2)	34.9 (8.1)	34.4 (8.2)	212	36520.00	<b>37398.33</b>
3500 2.3CDTi BiTurbo (163PS) S/S BlueInjection	2560	980	34.4 (8.2)	34.9 (8.1)	34.4 (8.2)	212	37770.00	<b>38648.33</b>
<b>L4 H1 RWD CHASSIS CAB BOX VAN 20 cu.m (EURO VIc)</b>								
3500 HD 2.3CDTi BiTurbo (130PS) BlueInjection	2735	805	29.4 (9.6)	30.7 (9.2)	30.4 (9.3)	242	35660.00	<b>36538.33</b>
3500 HD 2.3CDTi BiTurbo (145PS) S/S BlueInjection	2735	805	33.2 (8.5)	32.8 (8.6)	32.8 (8.6)	222	36770.00	<b>37648.33</b>
4500 HD 2.3CDTi BiTurbo (130PS) Tacho BlueInjection	2735	1805	N/A	N/A	N/A	N/A	37135.00	<b>37938.33</b>
4500 HD 2.3CDTi BiTurbo (163PS) S/S Tacho BlueInjection	2735	1805	N/A	N/A	N/A	N/A	39495.00	<b>40298.33</b>
<b>L4 H1 RWD CHASSIS CAB BOX VAN 22 cu.m (EURO VIc)</b>								
3500 HD 2.3CDTi (130PS) BlueInjection	2760	780	29.4 (9.6)	30.7 (9.2)	30.4 (9.3)	242	35860.00	<b>36738.33</b>
3500 HD 2.3CDTi BiTurbo (145PS) S/S BlueInjection	2760	780	33.2 (8.5)	32.8 (8.6)	32.8 (8.6)	222	36970.00	<b>37848.33</b>

Please note: On-the-road recommended retail prices (RRP) include number plates and delivery to Retailer of £583.33 (exc. VAT), 12 months' Vehicle Excise Duty at £240.00 (£165.00 on 4500kg models) and new vehicle first registration fee of £55.00. Excludes fuel and insurance. S/S = Start/Stop.

Vehicles with BlueInjection technology will need regular AdBlue® top-ups also between servicing requirements. An indicator integrated into the on-board computer will warn you when you need to top up. More information under [www.vauxhall.co.uk/blueinjection](http://www.vauxhall.co.uk/blueinjection). In accordance with regulations R (EC) No. 715/2007 and R (EC) No. 692/2008 (in the versions respectively applicable).

\* = For definitions please refer to Glossary of Terms.

# = Fuel consumption information is official government environmental data, tested in accordance with the relevant EU directive. Official EU-regulated test data is provided for comparison purposes and actual performance will depend on driving style, road conditions and other non-technical factors.

# MOVANO COMBI / MINIBUS PRICES

Model	Minimum Mass (kg)*	Payload (kg)*	Fuel economy mpg (litres/100km)#			CO <sub>2</sub> emissions (g/km)#	Price (£) exc. VAT	On-the-road RRP (£) inc. VAT
			Urban driving	Extra-urban driving	Combined figure			
<b>L1 H1 FWD 9-SEAT COMBI (EURO 6)</b>								
3300 2.3CDTi (110PS) S/S BlueInjection	2074	1141	35.8 (7.9)	45.6 (6.2)	41.5 (6.8)	176	26195.83	<b>32990.00</b>
<b>L2 H2 FWD 9-SEAT COMBI (EURO 6)</b>								
3500 2.3CDTi (110PS) S/S BlueInjection	2184	1231	34.9 (8.1)	44.8 (6.3)	40.9 (6.9)	179	28804.17	<b>36120.00</b>
3500 2.3CDTi BiTurbo (145PS) S/S BlueInjection	2184	1231	37.7 (7.5)	46.3 (6.1)	42.8 (6.6)	173	29066.67	<b>36435.00</b>
3500 2.3CDTi BiTurbo (170PS) S/S BlueInjection	2184	1231	37.7 (7.5)	46.3 (6.1)	42.8 (6.6)	173	30316.67	<b>37935.00</b>
<b>L3 H2 FWD 17-SEAT MINIBUS (EURO VIc)</b>								
3900 2.3CDTi BiTurbo (145PS) S/S Tacho BlueInjection	2660	1340	N/A (M2)	N/A (M2)	N/A (M2)	N/A (M2)	34529.17	<b>42355.00</b>

**Please note:** On-the-road recommended retail prices (RRP) include number plates and delivery to Retailer of £583.33 (exc. VAT), 12 months' Vehicle Excise Duty at £800.00 on Combi and £165.00 on Minibus models and new vehicle first registration fee of £55.00. Excludes fuel and insurance. S/S = Start/Stop.

Vehicles with BlueInjection technology will need regular AdBlue® top-ups also between servicing requirements. An indicator integrated into the on-board computer will warn you when you need to top up. More information under [www.vauxhall.co.uk/blueinjection](http://www.vauxhall.co.uk/blueinjection). In accordance with regulations R (EC) No. 715/2007 and R (EC) No. 692/2008 (in the versions respectively applicable).

\* = For definitions please refer to Glossary of Terms.

# = Fuel consumption information is official government environmental data, tested in accordance with the relevant EU directive. Official EU-regulated test data is provided for comparison purposes and actual performance will depend on driving style, road conditions and other non-technical factors.

# MOVANO TRABUS PRICES/FEATURES

Model	Minimum Mass (kg)*	Payload and Body Allowance (kg)*	Fuel economy mpg (litres/100km)#			CO <sub>2</sub> emissions (g/km)#	Price (£) exc. VAT	On-the-road RRP (£) exc. VAT
			Urban driving	Extra-urban driving	Combined figure			
<b>L2 H2 FWD TRABUS (EURO VIc)</b>								
3900 2.3CDTi BiTurbo (145PS) S/S BlueInjection	2093	1837	N/A (M2)	N/A (M2)	N/A (M2)	N/A (M2)	30640.00	<b>31443.33</b>
<b>L3 H2 FWD TRABUS (EURO VIc)</b>								
3900 2.3CDTi BiTurbo (145PS) S/S BlueInjection	2171	1759	N/A (M2)	N/A (M2)	N/A (M2)	N/A (M2)	31190.00	<b>31993.33</b>

**Please note:** On-the-road recommended retail prices (RRP) include number plates and delivery to Retailer of £583.33 (exc. VAT), 12 months' Vehicle Excise Duty at £165.00 and new vehicle first registration fee of £55.00. Excludes fuel and insurance. S/S = Start/Stop.

Vehicles with BlueInjection technology will need regular AdBlue® top-ups also between servicing requirements. An indicator integrated into the on-board computer will warn you when you need to top up. More information under [www.vauxhall.co.uk/blueinjection](http://www.vauxhall.co.uk/blueinjection). In accordance with regulations R (EC) No. 715/2007 and R (EC) No. 692/2008 (in the versions respectively applicable).

All conversions must follow 'Vauxhall Convertor Requirements' including recommended dimensional data, detailed within Part 1, available at: [www.vauxhall.co.uk/conversiondata](http://www.vauxhall.co.uk/conversiondata). The weight of any fitted conversion body will have to be deducted from these figures to establish actual payload and is subject to correct weight distribution. Variations from the recommended dimensions or weights may affect the vehicle's overall centre of gravity and stability. From 29 April 2013 conversion of N1 vehicles was affected by changes to type approval – for further information refer to the VCA website (N2 vehicles were affected from 29 October 2014). For further information please contact [conversions@vauxhall.co.uk](mailto:conversions@vauxhall.co.uk)

\* = For definitions please refer to Glossary of Terms.

# = Fuel consumption information is official government environmental data, tested in accordance with the relevant EU directive. Official EU-regulated test data is provided for comparison purposes and actual performance will depend on driving style, road conditions and other non-technical factors.

The Vauxhall Trabus is a fully glazed panel van without bulkhead suitable for conversion into a passenger vehicle by a third-party Convertor. The Trabus includes basic Type Approval for registration as a Category M\* Passenger Vehicle and 2nd stage Type Approval must be completed by the Convertor to enable registration. Available in two wheelbases the Trabus is fitted with the highly efficient and economical 2.3CDTi BiTurbo Euro VI engine with Start/Stop. There are no interior seats or internal trim within the load compartment.

#### Movano Trabus feature highlights:

- Type-approved for Euro VI Category M emissions
- Driver's airbag
- Electronic stability programme
- Six-way adjustable driver's seat with armrest
- Dual front passengers' bench seat with dump latch facility
- Pulse cloth trim for front seats
- Digital Tachograph
- 62mph hardcoded Speed Limiter
- Front fog lights
- High beam assist
- Lane departure warning
- Multi-function trip computer
- Bulkhead not fitted
- Digital radio/CD/MP3 CD player/stereo radio/aux-in socket/Bluetooth® connectivity for compatible mobile phones/USB connectivity/integrated display/four 15-watt speakers (CD 16 DAB BT USB)
- No second or third-row seating
- Fixed windows – nearside and offside rear panels
- Selective door locking with three-button key
- Uprated battery (110Ah)
- Glazed rear doors (90°/180° opening)
- Under-floor full-size spare wheel
- Centre wheel covers (full-diameter wheel covers optional)
- Nearside sliding side-access door and opposite panel with fixed windows

\* = M1 or M2 dependent on passenger configuration.

All conversions must follow 'Conversion Requirements' available on: [www.vauxhall.co.uk/conversiondata](http://www.vauxhall.co.uk/conversiondata)

# MOVANO EQUIPMENT / OPTIONS

## SAFETY

	Movano	Combi/ Minibus	Trabus	Price (£) exc. VAT	Total (£) inc. VAT
<b>Airbags:</b>	●	●	●		
<i>Driver's airbag</i>	●	●	●		
<i>Front passengers' airbag:</i>					
• Front passengers' airbag with deactivation switch – Not available with Convenience Pack option.	○	○	○	260.00	<b>312.00</b>
Option code: AK5					
<b>Stability:</b>					
<i>Electronic Stability Programme–plus (ESP–plus) with traction control</i> – Works in conjunction with the vehicle's electronic braking and engine systems to keep the vehicle stable in many different situations. ESP monitors a variety of inputs to determine when the vehicle starts to lose traction, it can then immediately respond by varying the brake pressure between up to three wheels and adjust the engine output to help correct the loss of traction and improve stability.	●	●	●		
<b>Anti-lock braking:</b>					
<i>Four-channel Anti-lock Braking System (ABS) – Prevents the vehicle's wheels from locking up under heavy braking by momentarily reducing brake pressure at the appropriate wheel, ensuring that you can maintain control of the steering.</i>	●	●	●		
<i>Emergency brake assist – When emergency braking is detected the vehicle automatically applies the maximum possible braking assistance.</i>	●	●	●		
<i>Electronic brakeforce distribution – Automatically apportions the optimum braking force to each wheel.</i>	●	●	●		
<i>Hill start assist – Briefly maintains rear brake pressure to stop the vehicle rolling back on an incline.</i>	●	●	●		
<b>Advanced Safety Assist Pack:</b>					
• Front fog lights • High beam headlight assist • Lane departure warning • Multi-function trip computer – Not available with Lighting Pack option. – Standard on Minibus / RWD HD 4500 models.	○	○	●	395.00	<b>474.00</b>
Option code: XYCO					
<b>Bulkhead:</b>					
• Full-height steel bulkhead without window – Standard on Panel Van / optional on Platform Cab models.	○			135.00	
Option code: AX6					
• Full-height ABS plastic bulkhead with window – Doublecab only.	●				
• Full-height steel bulkhead with window – Standard on Chassis / Crew Cab models. Optional on Panel Van / Platform Cab models.	○			50.00	
Option code: AX9					
• Protection grille for bulkhead window	○			410.00	
Option code: XBEO					
<b>ISOFIX child seat fixings:</b>					
• 1 x front row, 2 x second row – Combi models.		●			

## SECURITY

<b>Features:</b>	●	●	●		
• Electronic engine deadlock immobiliser • Steering column lock • Secure fuel filler flap	●	●	●		
• Internal lockable rear and sliding side-access doors • Under-floor spare wheel storage – Wind down only when rear doors opened. – Standard on Panel Van / Doublecab.	●	●	●		
<b>Remote control door locking (features depending on body type):</b>	●	●	●		
• Selective door locking • Two keys with integral remote • Door deadlocks	●	●	●		
• Third key with integral remote	○	○	○	60.00	<b>72.00</b>
Option code: K69					
<b>Security alarm system:</b>					
• Engine compartment protection • Ultrasonic detectors in load area • Siren • Thatcham Category 1 approved (TCL1–101/1103) – Not available on Platform Cab models.	○			305.00	
Option code: UA6					

● = Standard equipment. ○ = Optional at extra cost.



# MOVANO EQUIPMENT / OPTIONS

## COMFORT AND SEATING

	Movano	Combi/ Minibus	Trabus	Price (£) exc. VAT	Total (£) inc. VAT
<b>Comfort:</b> • Height-adjustable steering wheel • Facia-mounted gear lever • Floor-mounted handbrake lever • Pulse cloth seat trim • Vinyl floor covering • Inertia-reel lap and diagonal seatbelts • Height-adjustable outer front seatbelts	●	●	●		
<b>Vinyl seat trim:</b> • Grey vinyl seat trim – Not available with Convenience Pack / Construction Pack / air-suspended driver's seat options / dual front passengers' multi-function office bench seat. – Not available on Minibus models. Option code: TACQ	○	○		50.00	<b>60.00</b>
<b>Driver's seat:</b> • Height • Reach • Backrest recline • Height-adjustable padded head restraint • Driver's seat armrest	●	●	●		
<b>'Comfort' driver's seat:</b> • Lumbar adjustment • Height • Reach • Backrest recline • Height-adjustable padded head restraint • Centre fold-away armrest – Not available with Construction Pack option. L4 R3500 HD Dropside models. Option code: B21	○	○	○	135.00	<b>162.00</b>
<b>Air-suspended driver's seat:</b> • Lumbar adjustment • Height • Reach • Backrest recline • Height-adjustable padded head restraint • Centre fold-away armrest – Not available with vinyl seat trim option. – Not available on L2 Doublecab / Tipper models. Option code: A5Z	○		○	445.00	<b>534.00</b>
<b>Dual front passengers' bench seat:</b> • Fixed position bench seat and backrest • Centre seat features flat-folding backrest with twin drinks holders, flat work surface and storage tray • Height-adjustable outer front padded head restraint • Fixed centre seat padded head restraint	●		●		
<b>Dual front passengers' multi-function office bench seat:</b> • Dual front passengers' bench seat • Centre seat features flat-folding backrest with twin drinks holders, flat work surface and swivelling tray • Underseat storage – Optional on Combi models. Option code: ASY	○	●	○	210.00	<b>252.00</b>
<b>Single front passenger's seat:</b> • Reach • Backrest recline • Height-adjustable padded head restraint – Not available on Minibus or with Convenience Pack option. Please note: On Combi models this option reduces CO <sub>2</sub> emissions which may result in a reduction in Vehicle Excise Duty. Option code: AE1	○	○	○	60.00	<b>72.00</b>
<b>Single 'Comfort' front passenger's seat:</b> • Lumbar adjustment • Reach • Backrest recline • Height-adjustable padded head restraint • Centre fold-away armrest – Only available with driver's comfort / air-suspended driver's seat options. – Not available on Minibus. Please note: On Combi models this option reduces CO <sub>2</sub> emissions which may result in a reduction in Vehicle Excise Duty. Option code: AHZ	○	○	○	60.00	<b>72.00</b>
<b>Convenience Pack:</b> • 'Comfort' driver's seat with armrest and lumbar support • Multi-function office bench seat with folding seat back on centre passenger seat including swivelling work tray and tilt forward seat cushions with underseat storage • Retractable A4 facia document clip • 'One-touch down' facility for driver's electrically operated window • Bulkhead soundproofing (Panel Van only) – Not available on Crew Cab models. Option code: XiC6	○			235.00	
Full-length soft-trimmed headlining		●			
Full-height interior side mouldings		●			
Window blinds – Minibus only. Option code: DED		○		910.00	<b>1092.00</b>

● = Standard equipment. ○ = Optional at extra cost.

# MOVANO EQUIPMENT / OPTIONS

## SEATING – DOUBLECAB

	Movano	Combi/ Minibus	Trabus	Price (£) exc. VAT	Total (£) inc. VAT
<b>Rear seating:</b> • Four-individually contoured rear seats • Inertia-reel lap and diagonal seatbelts • Padded head restraints • Integrated storage nets and cup holders • Full-length tray under rear seat cushion – <i>Standard on Doublecab.</i>	●				
• Side and overhead rear seat storage pockets – <i>Doublecab only.</i>	○			70.00	
				Option code: D29	

## SEATING – COMBI

<b>Rear seating:</b> • Three-passenger, second-row bench seat • Three-passenger, third-row bench seat		●			
--	--	---	--	--	--

## SEATING – MINIBUS

<b>Rear seating:</b> • 14-individual rear passenger seats in staggered layout • Raised seating with illuminated gangway • Floor-mounted seat fixing rails and removable seats – <i>Last two rows of seats. Minibus only.</i>		●			
		○		440.00	<b>528.00</b>
				Option code: ATW	

## CABIN STORAGE

<b>Accessory sockets:</b> • 12-volt accessory socket beside gear lever	●	●	●		
<b>Facia storage:</b> • Driver's coin, ticket and card holder • Driver's oddments storage • Lidded glovebox (11-litre capacity) • Central drinks holder • Front passenger semi-covered document tray	●	●	●		
<b>Front door pockets:</b> • Large door pocket with capacity for a 2-litre drink bottle • Oddments pocket	●	●	●		
<b>Additional storage:</b> • Overhead storage shelf	●	●			
<b>Smoker Pack:</b> • Removable ashtray • Illuminated cigar lighter	○	○	○	50.00	<b>60.00</b>
				Option code: DT4	

● = Standard equipment. ○ = Optional at extra cost.

# MOVANO EQUIPMENT / OPTIONS

## DRIVER ASSISTANCE

	Movano	Combi/ Minibus	Trabus	Price (£) exc. VAT	Total (£) inc. VAT
<b>Windscreen wipers:</b> • Two-speed windscreen wipers • Variable intermittent wipe • Electric screenwash	●	●	●		
<b>Parking assistance:</b> • Rear-view camera – <i>Panel Van / Doublecab / Combi models.</i> Option code: UVC	○	○		760.00	<b>912.00</b>
• Rear parking distance sensors – <i>Not available on Chassis / Crew / Platform Cab models or derivatives.</i> Option code: UD7	○	○	○	275.00	<b>330.00</b>
• Rear-view camera • Rear parking distance sensors – <i>Panel Van / Doublecab / Combi models.</i> Option code: UCI	○	○		1025.00	<b>1230.00</b>
• Nearside blind-spot / junction mirror located in front passenger sunvisor	●	●	●		
<b>Cruise control, speed limiter and multi-function trip computer:</b> • Cruise control • Trip odometer • Vehicle range based on remaining fuel • Average speed • Average fuel economy • Instantaneous fuel economy • Driving time Option code: K34	○	○	○	260.00	<b>312.00</b>
<b>Speed limiter:</b> • Choice of three speeds: 56mph / 62mph / 68mph Option code: (56mph) KYJ – <i>56mph speed limiter standard on RWD HD 4500 models.</i> Option code: (62mph) KYK – <i>62mph speed limiter standard on Minibus / Trabus.</i> Option code: (68mph) KYL	○	○	●	85.00	<b>102.00</b>
Rear reversing lens – <i>Not available on Combi models.</i> Option code: D31		○		60.00	<b>72.00</b>

## DRIVER INFORMATION

<b>Instrumentation:</b> • Speedometer • Rev counter • Digital fuel gauge with low fuel warning light • Coolant temperature gauge with warning light	●	●	●		
<b>ECO features:</b> • Shift-up indicator (manual models) – <i>Indicates when to change gear for optimum fuel economy.</i>	●	●	●		
<b>Driver information display:</b> • Monochrome display located in instrument cluster • Odometer • Service-due indicator • Displays trip computer data (when fitted)	●	●	●		
<b>Central fascia display:</b> • Audio information • Digital clock with automatic RDS time adjustment • Outside air temperature with ice warning function • Additional features and location dependent on infotainment unit (see Audio, Communication and Navigation for details)	●	●	●		
<b>Warning indicators:</b> • Low oil level, low brake fluid, brake pad wear, battery, fuel filter, low AdBlue® level, seatbelt warning and doors open	●	●	●		
<b>Digital tachograph:</b> • CANbus interface • Odometer display is changed from miles to kilometres – <i>Standard on RWD HD 4500 / Minibus / Trabus models.</i> – <i>Not available with pneumatic rear suspension.</i> – <i>Important: The digital tachograph must be specified at time of ordering as it cannot be fitted retrospectively. Option price does not include calibration which must be carried out at an approved tachograph centre within 14 days of the vehicle's registration. Please note: The legislation regarding the use of tachographs is complex and operators should seek independent advice or speak to the Commercial Vehicle specialist at your Vauxhall retailer to ensure compliance. Alternatively your local DVLA office will also be able to provide clarification of the relevant legislation.</i> Option code: TGP	○	○	●	535.00	<b>642.00</b>

● = Standard equipment. ○ = Optional at extra cost.

# MOVANO EQUIPMENT / OPTIONS

## HEATING AND VENTILATION

	Movano	Combi/ Minibus	Trabus	Price (£) exc. VAT	Total (£) inc. VAT
<b>Cab heating:</b> • Four-speed fan • Illuminated controls • Four adjustable facia vents • Windscreen demist vents • Side window demist vents	●	●	●		
<b>Air conditioning:</b> • Air recirculation facility • Pollen filter • Illuminated controls • Chilled glovebox facility – <i>Not available on Minibus models.</i>	○	○	○	700.00	<b>840.00</b>
Option code: C60					
• Air conditioning front and rear		○	○	2210.00	2652.00
Option code: CJ5					
• Additional rear compartment heating – <i>Not available on Combi models.</i>		○		2010.00	2412.00
Option code: C46					
• Additional rear compartment air conditioning and heating – <i>Not available on Combi models.</i>		○	○	4210.00	5052.00
Option code: CAW					
<b>Electronic climate control:</b> • Incorporating air conditioning • LCD temperature display • Automatic air direction and fan speed with manual override • Illuminated controls • Pollen filter • Chilled glovebox facility	○			910.00	
Option code: C61					

● = Standard equipment. ○ = Optional at extra cost.

**Please note:** The air conditioning in vehicles with N1, N2 or M2 type approval relies upon fluorinated greenhouse gases (R134a) for its functioning. The front system contains a quantity of overall 580g of R 134a, which corresponds to a CO<sub>2</sub> equivalent of 0.83 tons. The front and rear system in versions with up to 9-seats contains a quantity of overall 1,100g of R 134a, which corresponds to a CO<sub>2</sub> equivalent of 1.57 tons. The front and rear system in versions with more than 16-seats contains a quantity of overall 1,700g of R 134a, which corresponds to a CO<sub>2</sub> equivalent of 2.43 tons. The global warming potential amounts to 1430. Information acc. to R (EU) No. 517/2014.

# MOVANO EQUIPMENT / OPTIONS

## INFOTAINMENT

	Movano	Combi/ Minibus	Trabus	Price (£) exc. VAT	Total (£) inc. VAT
<b>CD 16 BT USB:</b> <i>Onboard features:</i> • DAB digital radio / AM/FM stereo radio with 18-station presets • CD/MP3 CD player • High-level display • RDS with Traffic Programme • Two 15-watt speakers <i>Media connections:</i> • USB connection with iPod control • Aux-in socket • Bluetooth® audio streaming (A2DP Profile) <i>Mobile phone portal:</i> • Bluetooth® connectivity • Handsfree calls via steering wheel controls • Vehicle microphone • Phone book access – <i>Contacts/last calls/missed calls etc. (features dependent on mobile phone).</i>	●	●	●		
<b>NAVI 50 IntelliLink:</b> <i>Onboard features:</i> • DAB digital radio / AM/FM stereo radio with 18-station presets • 7-inch facia-mounted colour touchscreen • RDS with Traffic Programme • Two 20-watt speakers <i>Navigation features:</i> • Satellite navigation system • 3D street level mapping • Major route mapping for Western Europe <i>Media connections:</i> • USB connection with iPod control • Aux-in socket • Bluetooth® audio streaming (A2DP Profile) <i>Mobile phone portal:</i> • Bluetooth® connectivity • Handsfree calls via steering wheel controls • Vehicle microphone • Phone book access – <i>Contacts/last calls/missed calls etc. are mirrored on IntelliLink's display and are easily navigated using the touchscreen (features dependent on mobile phone).</i> – <i>Not available on Minibus models.</i>	○	○	○	660.00	<b>792.00</b>
Option code: 100					
<b>NAVI 80 IntelliLink:</b> <i>Onboard features:</i> • DAB digital radio / AM/FM stereo radio with 18-station presets • 7-inch facia-mounted colour touchscreen • RDS with Traffic Programme • Two speakers • 20 watts per channel output <i>Navigation features:</i> • Satellite navigation system • TomTom LIVE services • 3D street level mapping • Major route mapping for Western Europe <i>Media connections:</i> • USB connection with iPod control • Aux-in socket • Bluetooth® audio streaming (A2DP Profile) • Integrated voice control <i>Mobile phone portal:</i> • Bluetooth® connectivity • Handsfree calls via steering wheel controls • Vehicle microphone • Phone book access – <i>Contacts/last calls/missed calls etc. are mirrored on IntelliLink's display and are easily navigated using the touchscreen (features dependent on mobile phone).</i> – <i>Not available on Minibus models.</i>	○	○	○	1080.00	<b>1296.00</b>
Option code: 2L9					
<b>Additional features:</b> • Steering column mounted audio controls • Flexible roof-mounted aerial	●	●	●		

● = Standard equipment. ○ = Optional at extra cost.

# MOVANO EQUIPMENT / OPTIONS

## LOAD ACCESS

	Movano	Combi/ Minibus	Trabus	Price (£) exc. VAT	Total (£) inc. VAT
<b>Nearside access:</b>					
<b>Nearside side-access door:</b> • Nearside sliding side-access door • Unglazed – Standard on Panel Van.	●				
<b>Nearside side-access door with fixed windows:</b> • Fixed window to standard nearside side-access door (£165) • Fixed window to opposite offside body panel (£165) – Standard on Doublecab.	▲	●	●	330.00	
<b>Nearside side-access door with sliding windows:</b> • Sliding window to standard nearside side-access door (£335) • Sliding window to opposite offside body panel (£335) – Not available on Minibus models.	▲	▲	▲	670.00	
<b>Offside access:</b>					
<b>Offside side-access door:</b> • Offside sliding side-access door • Unglazed – Panel Van only.	▲			310.00	
<b>Offside side-access door with fixed windows:</b> • Fixed window to standard nearside side-access door (£165) • Offside side-access door (£310) • Fixed window to offside side-access door (£165)	▲			640.00	
<b>Offside side-access door with sliding windows:</b> • Sliding window to standard nearside side-access door (£335) • Offside side-access door (£310) • Sliding window to offside side-access door (£335)	▲			980.00	<b>1176.00</b>
<b>Rear access:</b>					
<b>Rear solid doors:</b> • Twin rear doors • 90°/180° opening • Twin rear doors • 270° opening – Not available on L1 models.	●				
	○			Option code: 7U4 285.00	
<b>Rear glazed doors:</b> • Glazed rear doors • 90°/180° opening • Glazed rear doors • 270° opening – Not available on L1 models.	○	●	●	Option code: J1X 110.00	
	○			Option code: J1T 385.00	
• Heated rear windows – Only available with glazed rear doors.	○	○	○	Option code: C49 110.00	<b>132.00</b>

● = Standard equipment. ○ = Optional at extra cost. ▲ = Please refer to ordering guide.

# MOVANO EQUIPMENT / OPTIONS

## GLAZED PACK

	Movano	Combi/ Minibus	Trabus	Price (£) exc. VAT	Total (£) inc. VAT
<ul style="list-style-type: none"> <li>Fixed window to standard nearside side-access door</li> <li>Fixed window to opposite offside body panel</li> <li>Rear glazed doors</li> <li>Rear glazed side panels</li> </ul>	○	●	●	430.00	
	Option code: A10				

## LOAD RESTRAINT – PANEL VAN

### Load anchorage/net:

<ul style="list-style-type: none"> <li>Fixed floor-mounted load restraint lashing eyes (L1 models x 6, L2/L3 models x 8, L4 models x 10)</li> <li>Nearside/offside rear door column load restraint lashing eyes</li> </ul>	●				
<ul style="list-style-type: none"> <li>Fixed side-mounted anchorage points (x 8) – <i>Not available with grab handle options.</i></li> </ul>	○			85.00	
	Option code: ANY				
<ul style="list-style-type: none"> <li>Load protection net (L2/L3 models only)</li> <li>– <i>Not available on RWD HD 4500 HD models / with floor and roof fixing rail.</i></li> </ul>	○			570.00	
	Option code: XBEC				

### Load fixing rails:

<b>Floor/roof fixing rails (FWD L2 H2/L3 H2 models only):</b>					
<ul style="list-style-type: none"> <li>Two parallel roof rails</li> <li>Two parallel floor rails</li> <li>Anti-slip wooden floor</li> <li>– <i>Not available with resin-coated load floor / load protection net.</i></li> </ul>	L2 ○			1005.00	
	L3 ○			1185.00	
	Option code: XBDB				
<b>Floor fixing rails (FWD L2/L3 models only):</b>					
<ul style="list-style-type: none"> <li>Two parallel floor rails</li> <li>Anti-slip wooden floor</li> <li>– <i>Not available with resin-coated load floor / load protection net.</i></li> </ul>	L2 ○			795.00	
	L3 ○			970.00	
	Option code: XBCE				
<b>Dual side fixing rails – dual height (FWD L2/L3 models only):</b>					
<ul style="list-style-type: none"> <li>Two nearside parallel side rails</li> <li>Two parallel offside side rails</li> <li>Plastic infill protective load lining panels</li> <li>– <i>Not available with half or full-height load lining trim / Glazing Pack.</i></li> </ul>	L2 ○			880.00	
	L3 ○			1100.00	
	Option code: XBCO				
<b>Side fixing rails – mid height (FWD L2/L3 models only):</b>					
<ul style="list-style-type: none"> <li>Single nearside side rail</li> <li>Single offside side rail</li> <li>Plastic infill protective load lining panels</li> <li>– <i>Not available with half or full-height load lining trim / Glazing Pack.</i></li> </ul>	L2 ○			750.00	
	L3 ○			925.00	
	Option code: XBBA				
Adjustable securing lashing eyes for use with fixing rails	○			55.00	
Ratcheted strap for use with fixing rails	○			50.00	
Telescopic blocking bars					
– <i>Only available with floor or side fixing rails.</i>	○			205.00	
	Option code: XBBD				
Adjustable partition wall					
– <i>Only available with floor and roof fixing rails.</i>	○			1205.00	
	Option code: XBBI				

● = Standard equipment. ○ = Optional at extra cost.

# MOVANO EQUIPMENT / OPTIONS

## LOAD PROTECTION – PANEL VAN

	Movano	Combi/ Minibus	Trabus	Price (£) exc. VAT	Total (£) inc. VAT
<b>Load lining:</b>					
Half-height plywood load lining panels	L1/L2 ○			170.00	
	L3 ○			190.00	
	L4 ○			210.00	
	Option code: N18				
• Full-height plywood load lining • Plywood wheel arch protection – Not available with glazed side-access door(s) / Only available with resin-coated plywood load floor covering.	L1 ○			490.00	
	L2 ○			535.00	
	L3 ○			570.00	
	L4 ○			710.00	
	Option code: N20				
Resin-coated plywood load floor covering	L1/L2 ○			330.00	
	L3/L4 ○			370.00	
	Option code: B68				

## ADDITIONAL LOAD AREA FEATURES – PANEL VAN / DOUBLECAB

Two grab handles (side-access and rear doors) – Panel Van only. Not available with side-mounted anchorage points.	Option code: XBBG	○			75.00
Three grab handles (two side-access and rear doors) – Panel Van only. Not available with side-mounted anchorage points.	Option code: XBEJ	○			100.00
Illuminated load area		●			
LED illuminated load area	Option code: XBHN	○			95.00
Glazed load area roof panel – Not available on H3 models.	Option code: 0C6	○			260.00
Two glazed load area roof panels – L2 H2, L3 H2 and L4 H2 Panel Van models.	Option code: 0C7	○			510.00

● = Standard equipment. ○ = Optional at extra cost.



# MOVANO EQUIPMENT / OPTIONS

## EXTERIOR CONVENIENCE / STYLING

	Movano	Combi/ Minibus	Trabus	Price (£) exc. VAT	Total (£) inc. VAT
<b>Exterior features:</b>	●	●	●		
• Integral steps in front bumper • Laminated windscreen • Body side-protection mouldings					
• Front and rear mudflaps	○	○	○	80.00	<b>96.00</b>
Option code: Q8H					
• Rear bumper with integral step	○			260.00	<b>312.00</b>
Option code: VF6					
– Standard on RWD / RWD HD Panel Van / Doublecab models. Optional on FWD Panel Van / Doublecab models.					
<b>Windows:</b>	●	●	●		
• Electrically operated front windows					
• Top opening rear windows – Not available on Combi models. L3 Trabus models only.		○	○	1510.00	<b>1812.00</b>
Option code: AD5					
<b>Door mirrors:</b>	●	●	●		
• Foldable electrically adjustable/heated door mirrors • Wide-angle mirror on driver's side • Integrated side-repeat indicators					
<b>Extendable door mirrors (Chassis, Crew and Platform Cab):</b>	○			85.00	
• Long arm exterior mirrors – Long arm exterior mirrors should be applied to any vehicle with an overall width of 2.17 to 2.35 metres					
Option code: DBE					
<b>Paint finish:</b>	○	○	○		<b>At extra cost</b>
• Special paint					
– Restrictions apply, please consult your Retailer for details.					









## EXTERIOR LIGHTING

<b>Standard lighting:</b>	●	●	●		
• Lights-on audible warning • Manual headlight beam levelling • Twin reversing lights • Hazard warning lights • Rear fog lights					
• Centre rear brake light (excluding Chassis / Crew / Platform Cab models or derivatives) • Side-repeater in exterior mirrors					
• Front fog lights – Standard on 4500 / Minibus models.	○	○	●	105.00	<b>126.00</b>
Option code: T3U					
<b>Lighting Pack:</b>	○	○	●	255.00	<b>306.00</b>
• Static cornering lights • Front fog lights • Automatic lighting control • Rain-sensitive windscreen wipers • Door-to-door illumination					
– Standard on 4500 / Minibus models.					
Option code: HME					

● = Standard equipment. ○ = Optional at extra cost.

# MOVANO OPTIONS

## EXTERIOR COLOURS

		Combi/ Movano Minibus Trabus			Price (£) exc. VAT	Total (£) inc. VAT
	<b>Arctic White (11U)</b> • Solid paint		<b>Signal Blue (GKX)</b> • Solid paint			
	<b>North Sea Blue (24U)</b> • Solid paint		<b>Ink Blue (23U)</b> • Solid paint	●	●	●
	<b>Saffron Yellow (98U)</b> • Solid paint					
	<b>Poppy Red (74U)</b> • Brilliant paint		<b>Mandarin Orange (99U)</b> • Brilliant paint	○	○	○
	<b>Halo Silver (GKY)</b> • Two-coat metallic paint		<b>Ambient Blue (GKW)</b> • Two-coat metallic paint			
	<b>Pearl Black (GUK)</b> • Two-coat metallic paint			○	○	○
					320.00	384.00
					450.00	540.00

● = Standard equipment. ○ = Optional at extra cost.

The colours reproduced may vary slightly from the actual paint colour. As a result they should be used as a guide only. Your Vauxhall Retailer has a comprehensive display of our paint samples. On Cab and Conversion variants the colours illustrated apply to the vehicle cab only.





# MOVANO EQUIPMENT / OPTIONS

## WHEELS AND TYRES

	Movano	Combi/ Minibus	Trabus	Price (£) exc. VAT	Total (£) inc. VAT
<b>FWD 2800 / FWD 3300 models:</b> • 6.5J x 16-inch steel wheels • 215/65 R 16 tyres • Full-size spare wheel • Wheel centre covers	●				
<b>FWD 3500 models:</b> • 6.5J x 16-inch steel wheels • 225/65 R 16 tyres • Full-size spare wheel – <i>Excludes Minibus models.</i> • Wheel centre covers	●	●	●		
<b>RWD 3500 models:</b> • 7J x 16-inch steel wheels • 235/65 R 16 tyres • Full-size spare wheel • Wheel centre covers	●				
<b>RWD HD 3500 / RWD HD 4500 models:</b> • 5.5J x 16-inch steel wheels • 195/75 R 16 tyres • Twin rear wheels • Full-size spare wheel	●				
<b>All-season tyres – Continental Vanco Four Season 2:</b> FWD models: 225/65 R 16 – <i>Not available on FWD 2800 models.</i> RWD models: 235/65 R 16 RWD HD models: 195/75 R 16 Option code: NRK	○	○	○	360.00	<b>432.00</b>
<b>Full-diameter wheel covers:</b> – <i>Not available on RWD HD models.</i> Option code: QP9	○	○	○	60.00	<b>72.00</b>
<b>Tyre inflation kit in lieu of spare wheel:</b> – <i>Not available on RWD / RWD HD models. Standard on Minibus models.</i> Option code: WTC	N/C	N/C	N/C		<b>No-cost option</b>

● = Standard equipment. ○ = Optional at extra cost. N/C = No-cost option.

## TYRE RATINGS

Tyre size	Fuel efficiency group	Wet grip performance	External noise	
			Measured (dB)	Group
195/75 R 16	B	B	72	
215/65 R 16	B	B	71	
225/65 R 16	B-E	B-C	70	
235/65 R 16	C-E	B	70	

Tyre rating according to EU Regulation 1222/2009

# MOVANO EQUIPMENT / OPTIONS

## MECHANICAL

	Movano	Combi/ Minibus	Trabus	Price (£) exc. VAT	Total (£) inc. VAT																		
<b>Transmission:</b> <i>Six-speed manual gearbox:</i> FWD models: • Transverse engine/gearbox • L1/L2/L3 models RWD / RWD HD models: • Longitudinal engine/gearbox • L3/L4 models	●	●	●																				
<i>Tecshift six-speed transmission:</i> – Tecshift transmission adds electronic control for both the clutch and gear selection to the standard six speed transmission. <b>Electronic clutch control</b> – Tecshift automatically operates the clutch, meaning that there is no clutch pedal and the vehicle can be driven by an 'automatic-only' driving licence holder. <b>Electronic gear selection</b> – Tecshift also controls gear selection, leaving the driver with two gear-shifting options – automatic or manual. <b>Automatic mode</b> – The driver selects forward or reverse gear and Tecshift does everything else, just like an automatic gearbox. <b>Manual mode</b> – The driver can change gear sequentially by pushing the lever forward (higher gear) or pulling it backwards (lower gear). A 'kickdown' function – going through two or more gears – is also possible in manual mode.	○			See price pages																			
<b>Steering:</b> • Power-assisted rack and pinion system • Turns lock-to-lock: 3.7 <b>Turning circles:</b> <table border="1"> <thead> <tr> <th></th> <th>Kerb-to-kerb</th> <th>Wall-to-wall</th> </tr> </thead> <tbody> <tr> <td>FWD L1</td> <td>12.0m (39.3ft.)</td> <td>12.5m (41.0ft.)</td> </tr> <tr> <td>FWD / RWD / RWD HD L2</td> <td>13.6m (44.6ft.)</td> <td>14.1m (46.2ft.)</td> </tr> <tr> <td>FWD L3</td> <td>15.7m (51.5ft.)</td> <td>16.2m (53.1ft.)</td> </tr> <tr> <td>RWD / RWD HD L3</td> <td>13.6m (44.6ft.)</td> <td>14.1m (46.2ft.)</td> </tr> <tr> <td>RWD / RWD HD L4</td> <td>15.7m (51.5ft.)</td> <td>16.2m (53.1ft.)</td> </tr> </tbody> </table>		Kerb-to-kerb	Wall-to-wall	FWD L1	12.0m (39.3ft.)	12.5m (41.0ft.)	FWD / RWD / RWD HD L2	13.6m (44.6ft.)	14.1m (46.2ft.)	FWD L3	15.7m (51.5ft.)	16.2m (53.1ft.)	RWD / RWD HD L3	13.6m (44.6ft.)	14.1m (46.2ft.)	RWD / RWD HD L4	15.7m (51.5ft.)	16.2m (53.1ft.)	●	●	●		
	Kerb-to-kerb	Wall-to-wall																					
FWD L1	12.0m (39.3ft.)	12.5m (41.0ft.)																					
FWD / RWD / RWD HD L2	13.6m (44.6ft.)	14.1m (46.2ft.)																					
FWD L3	15.7m (51.5ft.)	16.2m (53.1ft.)																					
RWD / RWD HD L3	13.6m (44.6ft.)	14.1m (46.2ft.)																					
RWD / RWD HD L4	15.7m (51.5ft.)	16.2m (53.1ft.)																					
<b>Brakes:</b> <i>Front ventilated disc brakes:</i> • FWD / RWD / RWD HD: 302mm x 28mm <i>Rear disc brakes:</i> • FWD / RWD: 305mm x 12mm • RWD HD: 305mm x 18mm	●	●	●																				
<b>Power take-off (manual models only):</b> • Engine driven power take-off – Single turbo FWD. Not available on Minibus / Trabus or with air conditioning / electronic climate control options. – BiTurbo FWD and all RWD. Only available with air conditioning / electronic climate control options. – Not available on Minibus models. Option code: V66	○	○		160.00	<b>192.00</b>																		
• Gearbox-driven power take-off – RWD / RWD HD models only. – Not available with increased engine idle speed. Option code: M1F	○			460.00																			
• Increased engine idle speed – Not available with 110PS Start/Stop engines. Option code: UF3	○			60.00																			
<b>Fuel tank:</b> • 80 litres (17.6 gallons) capacity • 105 litres (23.1 gallons) capacity – Not available on Core Conversions (excluding L3 Box) / Minibus models. Option code: NH7	●	●	●	110.00	<b>132.00</b>																		
<b>AdBlue tank:</b> • 22 litres (4.8 gallons) capacity	●	●	●																				

● = Standard equipment. ○ = Optional at extra cost.

# MOVANO EQUIPMENT / OPTIONS

## MECHANICAL

	Movano	Combi/ Minibus	Trabus	Price (£) exc. VAT	Total (£) inc. VAT
<b>Towing:</b> <ul style="list-style-type: none"> <li>• Tow bar with 13-pin electrics (does not suit trailers with LED lights) • Trailer stability programme</li> <li>– Unless specific exemptions apply, vehicles operated with a trailer, where the combined weight of the vehicle, trailer and payload exceeds 3500kg, require a digital tachograph. For trailers with LED lights use genuine Vauxhall Accessory tow bars which also include trailer stability programme. – Not available on Minibus models.</li> </ul>	○	○		385.00	<b>462.00</b>
Option code: VR2 / VTO					
<b>Electrical:</b> <ul style="list-style-type: none"> <li>• 95Ah maintenance-free battery (105Ah on Tecshift models) • 185A alternator</li> <li>• Second battery</li> <li>– Not available with single passenger seat options / Air-suspended driver's seat.</li> </ul>	●	●	●		
Option code: OBC	○	○		485.00	<b>582.00</b>
<b>CANbus interface:</b> Allows the vehicle's electrical systems to integrate with additional equipment. – Standard on RWD HD 4500 models. – Not available on Combi models when front and rear air conditioning is specified or Minibus models.	○	○		135.00	<b>162.00</b>
Option code: KC6					
<b>Six-pin electrical connector for conversions:</b> – Standard on Dropside / Tipper. Not available on Combi models when front and rear air conditioning is specified or Minibus models..	○	○		60.00	<b>72.00</b>
Option code: KPD					
<b>Front suspension:</b> <ul style="list-style-type: none"> <li>• MacPherson type • Independent double wishbones • Coil springs • Telescopic dampers</li> </ul>	●	●	●		
<b>Rear suspension:</b> <ul style="list-style-type: none"> <li>• Tubular axle • Telescopic dampers • Variable rate leaf springs</li> <li>FWD models: • Single leaf springs • Single rear wheels</li> <li>RWD models: • Double leaf springs • Single rear wheels</li> <li>RWD HD models: • Triple leaf springs • Twin rear wheels</li> </ul>	●	●	●		
<b>Pneumatic rear suspension:</b> – Only available with six-pin connector and CANbus. – Only available on FWD 3300 / FWD 3500 L2/L3 models.	○			2010.00	
Option code: F47					
<b>Construction Pack (RWD models only):</b> <ul style="list-style-type: none"> <li>• Air-suspended driver's seat with armrest • Automatic locking rear differential</li> <li>• Tow bar with 13-pin electrics (does not suit trailers with LED lights) • Trailer stability programme – Not available on Tipper / Box Van.</li> <li>For trailers with LED lights use genuine Vauxhall Accessory tow bars which also include trailer stability programme.</li> </ul>	○			1035.00	
Option code: HMG					
<b>Body Conversion Pack A (Chassis and Platform Cab):</b> <ul style="list-style-type: none"> <li>• Extended wiring loom • Six-pin connector for conversions • 16-pin connector for cab-based conversions</li> </ul>	○			95.00	
Option code: XZCM					
<b>Body Conversion Pack B (Crew Cab):</b> <ul style="list-style-type: none"> <li>• Extended wiring loom • Six-pin connector for conversions</li> </ul>	○			60.00	
Option code: XZCN					
<b>Automatic locking rear differential (RWD models only)</b>	○			510.00	
Option code: G94					

● = Standard equipment. ○ = Optional at extra cost.

# MOVANO EQUIPMENT / OPTIONS

## ADDITIONAL FEATURES – TIPPER

		Price (£) exc. VAT	Total (£) inc. VAT
<b>Tipper assembly:</b> <ul style="list-style-type: none"> <li>• Five-stage chrome-plated underfloor ram</li> <li>• Sliding and internal self-lubricating components made of reinforced nylon and Teflon</li> <li>• Anti-vibration Teflon plates on a secondary frame</li> </ul> <b>Tipper deck:</b> <ul style="list-style-type: none"> <li>• Steel platform, powder coated in dark grey</li> <li>• Integrated cabin protection, ladder rack and side under-run protection</li> <li>• 400mm anodised aluminium removable side and rear alloy panels with recessed hinges</li> <li>• Top and bottom hinged rear panel</li> <li>• Recessed side and tailboard operating levers</li> <li>• Removable rear posts</li> <li>• Galvanised fixing bolts</li> <li>• Automatically releasing rear panel during the rear tipping phase</li> <li>• Frame and cross-members in edged galvanised sheet</li> </ul> <b>Electrics:</b> <ul style="list-style-type: none"> <li>• Audible warning during operation</li> <li>• Fused power supply with isolator switch</li> <li>• Electro/hydraulic power pack</li> <li>• Side lights where required</li> <li>• Remote control on wander-lead located behind driver's seat</li> </ul> <b>Exterior:</b> <ul style="list-style-type: none"> <li>• Additional half-height tool box on L3 Chassis Cab Tipper models (2100 x 650 x 750mm)</li> <li>• Rear mudflaps</li> </ul> <b>Load restraint:</b> <ul style="list-style-type: none"> <li>• Eight integrated load lashing points conforming to DIN 75410 standards</li> </ul>	●		
Rear light protection grilles	○	Option code: SCW	160.00

## ADDITIONAL FEATURES – DROPSIDE

<b>Exterior:</b> <ul style="list-style-type: none"> <li>• Plywood load floor with non-slip resin surface coating</li> <li>• Integrated cabin protection, ladder rack and side under-run protection</li> <li>• 400mm anodised aluminium removable side and rear alloy panels with recessed hinges</li> <li>• Removable rear posts</li> <li>• Integrated load lashing rings conforming to DIN 75410 standards</li> <li>• Rear mudguards</li> <li>• Galvanised fixing bolts</li> <li>• Side lights where required</li> <li>• Frame and cross-members in edged galvanised sheet</li> </ul>	●		
Removable rear ladder rack and tool box	○	Option code: K2Z	400.00

## ADDITIONAL FEATURES – BOX VAN

<b>Interior / exterior:</b> <ul style="list-style-type: none"> <li>• Polyester lightweight box with smooth external appearance</li> <li>• Aluminium frame</li> <li>• Long arm exterior mirrors</li> <li>• Side under-run protection</li> <li>• 18mm plywood covered anti-slip floor</li> <li>• Twin rear 270° opening aluminium doors</li> <li>• Folding rear step fitted to offside</li> </ul>	●		
Wind deflector	○	Option code: G7M	485.00
Luton head	○	Option code: Z1D	700.00
Rear roller shutter door	○	Option code: D5W	685.00
Retractable rear step – <i>Optional on L3 Box Van.</i>	○	Option code: VF6	260.00

● = Standard equipment. ○ = Optional at extra cost.

# MOVANO ONE-INVOICE APPROVED CONVERSIONS

## Approved by Vauxhall for the UK Market

- All Approved Conversions are approved by Vauxhall Engineering
- These Conversions will be managed as approved 'Options' and can only be ordered via the M.S.I.T. Special Build Programme (specialbuild@gm.com)
- Warranty of Base Vehicle remains the responsibility of Vauxhall
- Warranty and Servicing of Conversion remains the responsibility of the Converter
- All Approved Conversions are supplied with EC WVTA (European Community Whole Vehicle Type Approval) from long-standing conversion partners

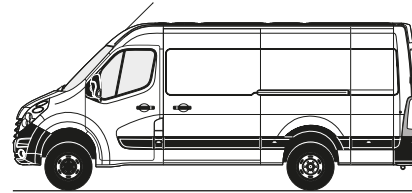
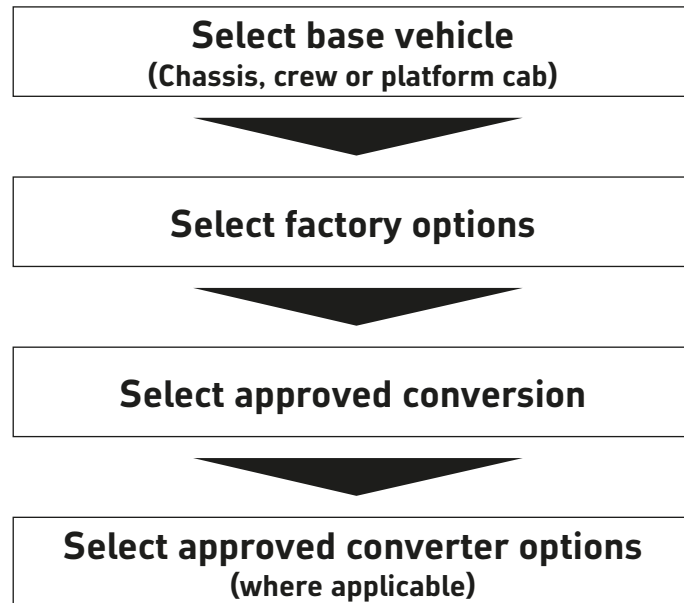

**4WD CONVERSION**

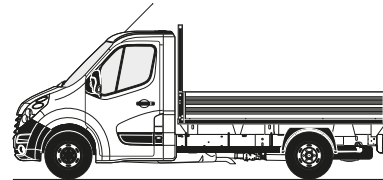

**LIGHTWEIGHT TIPPER**

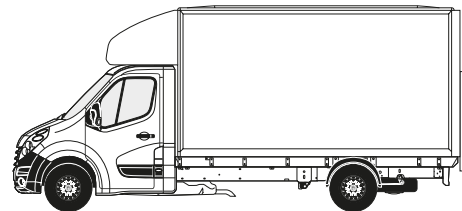

**LUTON BOX VAN**

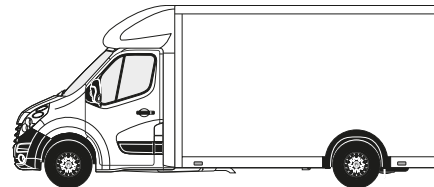

**LOW FLOOR LUTON VAN**

# MOVANO ONE-INVOICE APPROVED CONVERSIONS

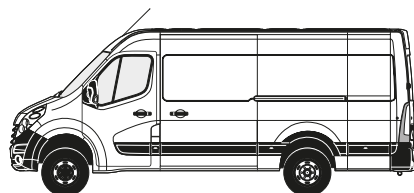

**Price (£)  
exc. VAT**  
**14500.00**

## 4WD CONVERSION BY OBERAIGNER

Type approved numbers: EC WVTA: e11\*2007/46\*1191\*00

- Available on: RWD/RWD HD Panel Van, Doublecab, Tipper, Dropside, Chassis or Crew Cab
- Switchable All-Wheel Drive (AWD) for use under poor road conditions and off-road driving
- Additional weight kept to a minimum by use of lightweight components
- Minimal vehicle lift due to compact AWD system
- Switchable 1:1.42 gearing ratio (Terrain gear) with facia-mounted control panel for AWD system

Requires Automatic locking rear differential factory options.  
AWD drivetrain warranty is limited to 2 years/75,000 miles.

With over 20 years' experience in the design and production of 4X4 conversions, the Oberaigner Group is one of the leading suppliers of off-road vehicles in this sector of the Commercial Vehicle market.

Oberaigner Automotive GmbH  
Email: [cs@oberaigner.com](mailto:cs@oberaigner.com)  
Website: [www.oberaigner.com](http://www.oberaigner.com)  
Tel: +49 38454 3290-280

For further information please use the following website link:

**4WD CONVERSION BY OBERAIGNER**

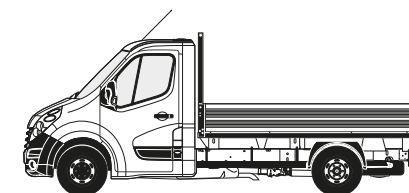

**Price (£)  
exc. VAT**  
**4530.00**

## LIGHTWEIGHT TIPPER BY VFS

Type approved numbers: EC WVTA: e11\*2007/46\*1022\*00

- Available on: L2 H1 Chassis Cab or L3 H1 Crew Cab
- Lightweight, high-strength steel design optimised for UK
- Increased payload and lowered deck height compared to ex-Factory conversion
- Powder-coated and wax injected steel box section construction
- Steel platform, powder coated in dark grey
- Crew cab also available as utility cab for additional security

### Recognised options\*:

Tow bar	<b>425.00</b>
Beacon Pack	<b>150.00</b>
Chevron Pack	<b>250.00</b>
Worklamp Pack	<b>250.00</b>
Utility Cab	<b>1840.00</b>
Lightweight galvanised mesh cage (1.35m high)	<b>2135.00</b>
Lightweight galvanised mesh cage (2.0m high)	<b>2650.00</b>

Tail lift warranty is limited to 12 months.

\* = Further options may be available. Please consult the Converter for further information.

VFS is a wholly owned subsidiary of Scattolini SpA.

VFS (Southampton) Limited  
Email: [sales@vfs.co.uk](mailto:sales@vfs.co.uk)  
Website: [www.vfs.co.uk](http://www.vfs.co.uk)  
Tel: 02380 613612

For further information please use the following website link:

**LIGHTWEIGHT TIPPER BY VFS**



# MOVANO ONE-INVOICE APPROVED CONVERSIONS

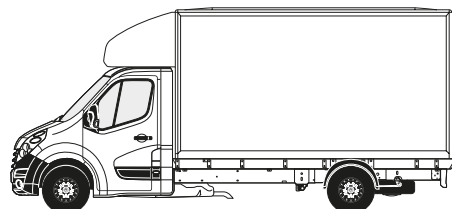

**Price (£)  
exc. VAT**  
**5665.00**

## LUTON BOX BY INGIMEX

Type approved numbers: EC WVTA: e11\*2007/46\*0971\*00

- Available on: L3 H1 F3500/R3500/R4500 Chassis Cab
- 630kg conversion weight for increased payload capacity
- Volume 18cu.m (estimated excluding Luton head)
- Wide lath rear shutter door with slam-shut lock
- Four-tier load restraint system
- One-piece birch plywood load deck

Converter options may be available. Please consult the Converter for further information.

Founded in 1972, Ingimex Limited is the UK's largest manufacturer of light commercial vehicle bodies and the only European light commercial vehicle body manufacturer to fully design, test and manufacture products in house.

Ingimex Limited  
Email: [sales@ingimex.com](mailto:sales@ingimex.com)  
Website: [www.ingimex.com](http://www.ingimex.com)  
Tel: 01952 585833

For further information please use the following website link:

**LUTON BOX BY INGIMEX**

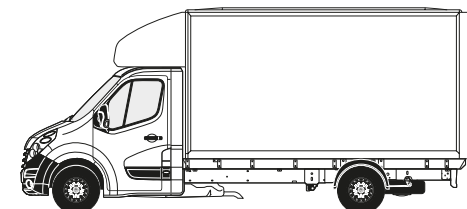

**Price (£)  
exc. VAT**  
**8295.00**

## LUTON BOX WITH TAIL LIFT BY INGIMEX

Type approved numbers: EC WVTA: e11\*2007/46\*0971\*00 (tbc)

- Available on: L3 H1 F3500/R3500/R4500 Chassis Cab
- Ratcliff Palfinger column-type tail lift rated at 500kg
- Volume 18cu.m (estimated excluding Luton head)
- Wide lath rear shutter door with slam-shut lock
- Four-tier load restraint system
- One-piece birch plywood load deck

Converter options may be available. Please consult the Converter for further information.

Founded in 1972, Ingimex Limited is the UK's largest manufacturer of light commercial vehicle bodies and the only European light commercial vehicle body manufacturer to fully design, test and manufacture products in house.

Ingimex Limited  
Email: [sales@ingimex.com](mailto:sales@ingimex.com)  
Website: [www.ingimex.com](http://www.ingimex.com)  
Tel: 01952 585833

For further information please use the following website link:

**LUTON BOX WITH TAIL LIFT BY INGIMEX**

# MOVANO ONE-INVOICE APPROVED CONVERSIONS

---

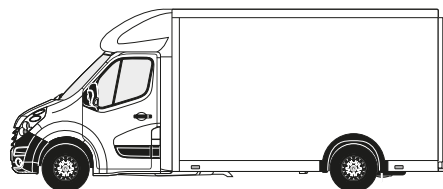

**Price (£)  
exc. VAT**

**8275.00**

---

## **LOW FLOOR LUTON VAN 'KNEEHI' BY TRUCKSMITH**

Type approved numbers: EC WVTA: e11\*2007/46\*0833\*00

- Available on: L3 H1 F3500 Platform Cab
- Payload up to 1295kg
- Volume 18.5cu.m
- Lightweight conversion utilising an anodised aluminium framework and galvanised back frame
- Low loading height
- Four full-length aluminium lashing rails
- 270 degree opening barn doors, with stainless steel fittings and door retainers
- Opalescent roof giving good light to loadspace

Requires full-height steel bulkhead factory option.

Trucksmith is an owner-managed company, established in 1984, designing and building a range of Commercial Vehicle conversions.

Trucksmith Limited

Email: [sales@trucksmith.co.uk](mailto:sales@trucksmith.co.uk)

Websites: [www.trucksmith.co.uk](http://www.trucksmith.co.uk) or [www.kneehi.co.uk](http://www.kneehi.co.uk)

Tel: 01884 33001

Fax: 01884 33004

**For further information please use the following website link:**

**LOW FLOOR LUTON VAN 'KNEEHI' BY TRUCKSMITH**

# RANGE GLOSSARY OF TERMS

## PLATED WEIGHT

The maximum weight to which a vehicle or an axle may be loaded, determined either by the design of the components or by legislation. All commercial vehicles must carry a manufacturer's 'plate' showing the vehicle and axle gross 'plated weights'. It is an offence to drive a vehicle in a condition where any of these weights are exceeded.

## MINIMUM MASS

Minimum Mass ('Mass in running order' on Certificate of Conformity and 'Mass in Service' on V5C form) is defined according to European Type Approval and include all fluids, tools, 90% fuel load and driver (75kg). It is minimum mass for this variant and does not consider local specification/trim or deletable options (specific to Movano). Weights are also subject to manufacturing tolerances (EU Legislation allows 5% tolerance).

## GROSS VEHICLE WEIGHT (GVW)

The total permissible weight of a vehicle including payload and passengers, as shown on the manufacturer's plate.

## GROSS COMBINATION WEIGHT (GCW)

The maximum permissible weight of a vehicle, including payload and passengers, combined with the total weight of any trailer it is towing. The maximum GCW weight limit is quoted on the vehicle plate and must not be exceeded.

## PAYLOAD

The total permissible weight that can be carried without exceeding the vehicle's plated weight. Payload do not include driver but do take into consideration specification/trim level:

- For Combo included are UK specification (Panel Van 15kg; Crew Van 25kg) and also trim (Sportive L1 Panel Van 45kg; Sportive L2 Panel Van 30kg; Sportive Crew Van 20kg; Glazed Crew Van 40kg)
- For Vivaro included are UK specification (15kg) and trim (Sportive Panel Van 30kg; Sportive Doublecab 40kg; Limited Edition NAV Panel Van 45kg and Limited Edition NAV Doublecab 55kg)
- For Movano included are UK specification (10kg) and deletable options such as Bulkhead (25kg); Sliding Doors (30kg each) and Spare Wheel (25kg)

Weights are also subject to manufacturing tolerances (EU Legislation allows 5% tolerance). Payload does not consider any additional options that a customer may order.

## ROOF LOADS

- Corsavan roof load should not exceed 75kg including the weight of the roof rack/carrier
- Combo roof load should not exceed 100kg on H1 models including the weight of the roof rack/carrier. H2 are not permitted to carry roof loads
- Vivaro roof load should not exceed 200kg (150kg on H2 models) including the weight of the roof rack/carrier
- Movano roof load should not exceed 200kg (150kg on H1 models) including the weight of the roof rack/carrier. H3 are not permitted to carry roof loads

## MAXIMUM TOWING WEIGHT

The maximum weight of any trailer and its load which may be towed within the limit of the vehicle's plated Gross Combination Weight (GCW). It is based on the ability of the vehicle – at full GCW – to restart on a 12% gradient, which is approximately 1 in 8.3, at sea level. At altitudes above 1500 metres, the engine output may drop with a corresponding reduction in towing capability. It is the operator's responsibility to ensure that the trailer noseweight does not cause the rear axle plated weight of the towing vehicle to be exceeded.

*Always fit Vauxhall towing attachments and accessories available from your Vauxhall Commercial Vehicle retailer. They are designed specifically for Vauxhall models and carry a 12-month warranty.*

## LIGHT DUTY AND HEAVY DUTY CYCLES

For a Light Duty cycle (EC regulation 715/2007 with designation 'Euro 6') the emissions of the whole vehicle are evaluated whereas for Heavy Duty cycle (EC regulation 595/2009 with designation 'Euro VI') only the engine is bench tested. The requirement of which cycle is necessary is determined by the reference mass of the vehicle. In the case of Vivaro, reference mass calculations dictate that:

- N1 FWD and M1 FWD are approved as Light Duty
- N1 RWD, N2 RWD and M2 FWD are approved as Heavy Duty

When Euro 5 was previously introduced, there was an agreement between Member States and the Commission (Reference TEC 740/2011) that, assuming there was no alteration to the emissions system itself, a multi-stage build vehicle should be covered by the base vehicle emissions approval, irrespective of whether the reference mass had changed. The Department for Transport has confirmed that this interpretation will remain in place for Euro 6/VI.

To illustrate this better – a F3500 L3 H1 (130PS) Vivaro Chassis Cab is type approved as Light Duty (Euro 6). Regardless of any conversion to this vehicle and even if its reference mass transgresses above the 2840kg threshold, then it is still be covered by the original Light Duty cycle emissions. One situation where this may not apply is when a vehicle changes category from N1 (Commercial) to M1 (Passenger) during the process of conversion.

## COMMERCIAL VEHICLE CATEGORIES

### Differences between M1/N1 and M2/N2 (Vehicles with GVW above 3500kg)

#### Category M: Passenger carriers

**Category M1:** Vehicles designed and constructed for the carriage of passengers and comprising no more than eight seats in addition to the driver's seat.

**Category M2:** Vehicles designed and constructed for the carriage of passengers, comprising more than eight seats in addition to the driver's seat, and having a maximum mass not exceeding 5 tonnes.

#### Category N: Goods vehicles

**Category N1:** Vehicles designed and constructed for the carriage of goods and having a maximum mass not exceeding 3.5 tonnes.

**Category N2:** Vehicles designed and constructed for the carriage of goods and having a maximum mass exceeding 3.5 tonnes but not exceeding 12 tonnes.

#### Specific differences, all M2/N2 require the following:

**Speed limiter:** All M2/N2 vehicles are legally required to be speed limited. M2 to 62mph and N2 to 56mph.

**Driver licence:** Commercial vehicles with GVW greater than 3.5 tonnes have different license requirements. For any new drivers C1 category

is necessary. Under some circumstances (social purposes for a non-commercial body) it is possible to drive a minibus without a D1 entitlement (Minibus) however eligibility for this exemption should be confirmed with DVSA.

**Driver CPC:** Driver Certificate of Professional Competence mandates 35 hours of periodic training every 5 years to maintain licence (from September 2014).

**Tachograph:** It is a legal requirement to administer the activities of drivers subject to the EU or AETR drivers' hours rules, and also record the vehicle's speed, distance and time. A Smart Card is required for digital tachograph and these are available from the DVLA. The tachograph of a new vehicle must be calibrated within two weeks of first registration.

**Operator's Licence:** This may also be required to ensure that vehicles are kept safe and in good condition at all times. Specifically for M2, PSV (public service vehicle) operator's licence is required. Exemptions in some circumstances may be permitted but this should always be confirmed with DVSA.

**MOT Testing:** M2/N2 must be tested each year, and vehicle presented with a completed Certificate of Conformity (CoC). This is available from Vauxhall (regdata@gm.com) or from converter in case of second-stage conversion.

# CUSTOMER CARE PRICING AND ADDITIONAL INFORMATION

## Vauxhall on-the-road recommended retail prices (RRP)

To eliminate uncertainty about hidden costs incurred when buying a new commercial vehicle, Vauxhall publishes on-the-road prices and these are shown in the pricing tables within this price guide. The prices shown are manufacturer's recommended retail prices (RRP) unless otherwise stated, exclusive of VAT (currently at a rate of 20% which may be payable). These prices include the recommended cost of number plates, delivery to a Vauxhall Retailer of £583.33 (£700.00 including VAT), 12 months' Government Vehicle Excise Duty\* and the DVLA new vehicle first registration fee of £55.00\*.

Please note: The RRP does not include fuel supplied by the Retailer, motor insurance or any other goods or services supplied by agreement between the Retailer and customer.

## Price protection for all Vauxhalls

Order a new Vauxhall for build in the current model year (as confirmed by your Retailer) for delivery no more than three months in advance and the price you are quoted is the price you pay. This is irrespective of any subsequent price rises between placing your order and delivery of your new commercial vehicle, but you must take delivery as soon as the commercial vehicle is available. General Motors UK Limited is not liable for price adjustments caused by Government changes in the rate of VAT (currently 20%), Vehicle Excise Duty, DVLA new vehicle first registration fee or by any other applicable legislation or regulations.

## Vehicle Excise Duty

The amount of Vehicle Excise Duty (road fund licence) payable on new commercial vehicles varies depending on gross vehicle weight (GVW) and European standard emissions compliance, as shown below\*.

Up to 3500kg GVW	£240.00
Over 3500kg GVW	£165.00

\*Correct at time of publication.

## In the event of an accident...

Vauxhall Accident Management helps keep you mobile following an accident. Benefits include vehicle recovery, Vauxhall-approved repairs and contacting your insurer. For more details, visit [vauxhall.co.uk/AccidentManagement](http://vauxhall.co.uk/AccidentManagement)

## Customer Care Commitment

For added peace of mind, Vauxhall has an innovative Customer Care Commitment\*\* that offers the following:

- Three-year vehicle warranty consisting of a one-year/unlimited mileage manufacturer's warranty and a second and third year manufacturer's warranty with a 60,000 miles (Corsavan and Combo) and 100,000 miles (Vivaro and Movano) limitation
- Vauxhall Assistance for 12 months from first registration
- Six years' body panel anti-perforation warranty

\*\* Warranty is only on vehicles sourced from General Motors UK Limited. Terms and conditions apply - please see your Vauxhall Retailer for details.

## Vauxhall Assistance

Vauxhall Assistance is provided automatically with every new Vauxhall Commercial Vehicle for 12 months from first registration and covers everything from accidents, mechanical breakdown to flat tyres. With Vauxhall Assistance help is literally just a free† phone call away, 24 hours a day, 365 days a year!

† Mobile phone users will be charged at their standard tariff.

## Vauxhall Extended Warranty

For complete peace of mind Vauxhall offers an extended warranty that can be purchased on an annual basis following the expiry of the original new vehicle warranty. It covers most mechanical and electrical components. Terms and conditions apply, for further details please contact your local Vauxhall Retailer.

## Protecting the environment

Our products are increasingly winning environmental awards, both through the use of more recycled materials and by becoming cleaner and more efficient. For information on Vauxhall's efforts to achieve an environmentally sustainable future, including information on Design for Recycling, take-back of End-of-Life Vehicles (ELVs), and the recycling of ELVs, see [www.vauxhall.co.uk/recycling](http://www.vauxhall.co.uk/recycling)

## Vauxhall Service Plan

Vauxhall Retailers offer a great service for owners of all Vauxhall vehicles. Value for money, regular offers and free check-ups, combined with the peace of mind that comes from using Vauxhall-trained technicians and genuine parts, help keep your vehicle in peak condition at all times. Every Vauxhall Retailer supports our customer promise:

### We are Vauxhall experts

- Fully Vauxhall-trained technicians
- We use Vauxhall approved diagnostic equipment and specialist tools
- Full access to Vauxhall repair databases and technical centres

### We are transparent

- Our invoicing will clearly set out the work at the price agreed with no hidden extras

## We are never beaten on price

- We will match any written like for like service/repair quote from a local<sup>††</sup> competitor using genuine repair methods and parts

## We are convenient

- Flexible booking times to suit you
- 'One-stop shop' for every type of Vauxhall service
- While you wait facility on stocked tyres, batteries and exhausts
- Free courtesy vehicle or local collection with annual services and warranty work

## We are thorough

- 25 point safety check with any workshop visit
- No obligation advice on essential and non-essential work
- Free check for safety enhancements and upgrades to your vehicle and software
- Free 'Wash and Vac' with every annual service
- Free fitting of wipers and external bulbs with annual services

†† A radius of five miles/20 minutes from your Vauxhall Retailer.

## Premier Van Centres

To maximise mobility and minimise downtime, our dedicated network of over 100 Premier Van Centres is increasing its emphasis on faster turnaround and fewer vehicle days spent off-road. We're your commercial vehicle 'one-stop shop' with all the specialised equipment, tools and training to support your aftersales needs, using only genuine parts fitted by Vauxhall-trained technicians. What's more, we promise convenience, expertise and value:

- Drop in for a diagnosis, no appointment necessary
- While-you-wait repairs where the parts are on-site
- A 25-point vehicle safety check with every workshop visit
- Access to Class 7 MOT facilities
- Onward mobility and a dedicated Premier Van Helpline - call 0800 026 0034

# CORSAVAN SPECIFICATIONS

## ENGINES

	1.2i (70PS)	1.3CDTi (75PS) Start/Stop	1.3CDTi (95PS) Start/Stop ecoTEC	1.3CDTi (95PS) Start/Stop
Fuel type	Petrol	Diesel	Diesel	Diesel
Capacity	1229cc	1248cc	1248cc	1248cc
Maximum power	70PS (51kW) @ 5600rpm	75PS (55kW) @ 3750rpm	95PS (70kW) @ 3750rpm	95PS (70kW) @ 3750rpm
Maximum torque	115Nm (85 lb.ft.) @ 4000rpm	190Nm (140 lb.ft.) @ 1500-2500rpm	190Nm (140 lb.ft.) @ 1500-3500rpm	210Nm (155 lb.ft.) @ 1500-3000rpm
Configuration		4 cylinders, 4 valves per cylinder, double overhead camshafts		
Fuel/induction system	Naturally aspirated with Variable Valve Timing. Multi-point sequential fuel injection	Turbocharger with intercooler. Common rail fuel injection	Variable geometry turbocharger with intercooler. Common rail fuel injection	
Emission compliance	Euro 6	Euro 6 with Diesel Particulate Filter		
Service interval	20,000 miles or 1-year (whichever occurs sooner)			

## PLATED WEIGHTS AND TOWING DATA KG – CAR-DERIVED VAN

Model		Gross Vehicle Weights (GVW)	Plated weights		Towing weights		Plated Gross Combination Weights (GCW)
			Front axle	Rear axle	Braked	Unbraked	
Corsavan	1.2i	1605	815	820	950	540	2555
	1.3CDTi	1695	905	820	1200	580	2895
	1.3CDTi ecoTEC	1695	905	820	1250	580	2945
	1.3CDTi Sportive	1720	930	820	1250	600	2970
	1.3CDTi ecoTEC Easytronic	1705	915	820	1250	580	2955

Gross plated weights (including axle weights) quoted on the vehicle plate are to UK plated weight specification and must never be exceeded. For further information please see Glossary of Terms.

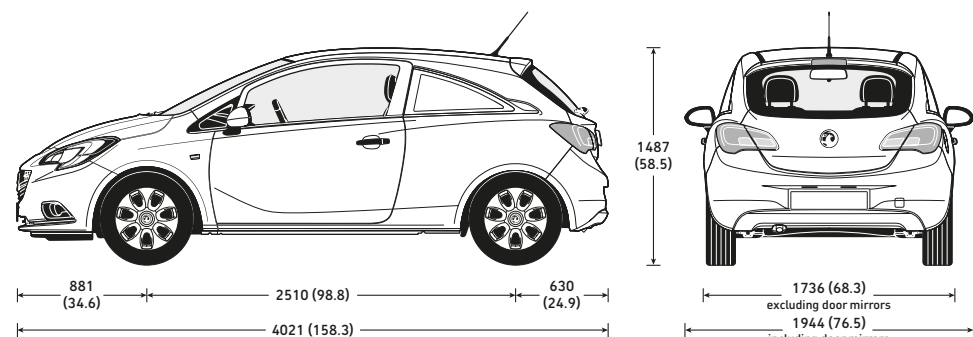

Dimensions mm (inches). Height shown unladen.

### LOADSPACE DIMENSIONS MM (INCHES)

Maximum length	1257 (49.5)
Maximum width	1264 (49.8)
Width between wheel arches	969 (38.1)
Maximum height	921 (36.2)

### LOADSPACE ACCESS MM (INCHES)

Aperture height	650 (25.6)
Aperture width (at floor)	771 (30.3)
Loading height (unladen)	532 (20.9)

### LOADSPACE VOLUMES CU.M (CU.FT.)

All models – ECIE method	0.92 (32.5)
--------------------------	-------------

# COMBO SPECIFICATIONS

## ENGINES

	<b>1.4i 95PS with Start/Stop</b>	<b>1.3CDTi 95PS with or without Start/Stop</b>	<b>1.6CDTi 105PS with or without Start/Stop</b>
Capacity	1368cc	1248cc	1598cc
Maximum power	95PS (70kW) @ 6000rpm	95PS (70kW) @ 3500 – 3750 rpm	105PS (77kW) @ 3500rpm
Maximum torque	127Nm (94 lb.ft.) @ 4500rpm	200Nm (148 lb.ft.) @ 1500rpm	300Nm (221 lb.ft.) @ 1750 – 2000rpm
Configuration	4 cylinders, 4 valves per cylinder, double overhead camshafts		
Fuel/induction system	Multi-point fuel injection	Variable geometry turbocharger with intercooler. Common rail fuel injection	
Emission compliance	Euro 6		
Service interval	18,000 miles or two years (whichever occurs sooner)	20,000 miles or two years (whichever occurs sooner)	

# COMBO PANEL VAN SPECIFICATIONS

L1 H1/H2

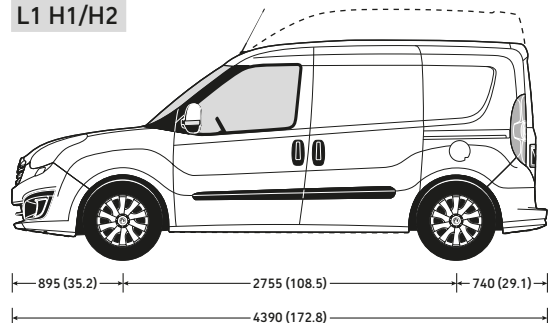

L2 H1/H2

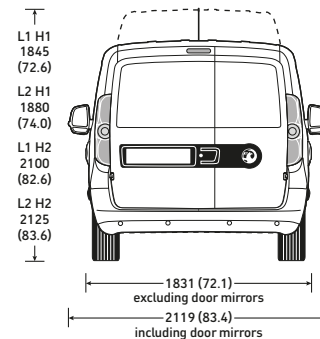
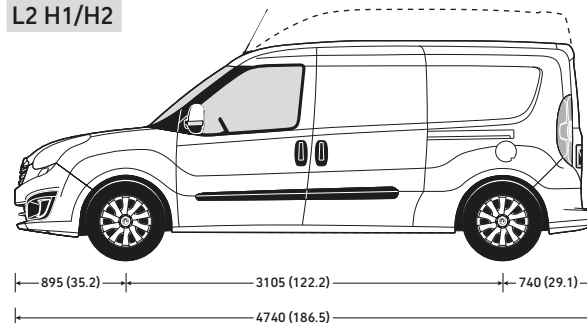

Dimensions mm (inches). Heights shown unladen.

## LOADSPACE DIMENSIONS MM (INCHES) – PANEL VAN

	L1	L2
Maximum length	1820 (71.7)	2170 (85.4)
Maximum width	1714 (67.5)	1714 (67.5)
Width between wheel arches	1230 (48.4)	1230 (48.4)
Maximum height – H1	1305 (51.4)	1305 (51.4)
Maximum height – H2	1550 (61.0)	1550 (61.0)

## LOADSPACE ACCESS MM (INCHES) – PANEL VAN

	L1	L2
Side door aperture height	1175 (46.2)	1175 (46.2)
Side door aperture width	700 (27.5)	700 (27.5)
Rear door aperture height – H1	1250 (49.2)	1250 (49.2)
Rear door aperture height – H2	1455 (57.2)	1455 (57.2)
Rear door aperture width	1231 (48.5)	1231 (48.5)
Loading height (unladen)	545 (21.4)	545 (21.4)

## PLATED WEIGHTS AND TOWING DATA KG – PANEL VAN

Model	Gross Vehicle Weights (GVW)	Plated weights		Towing weights		Plated Gross Combination Weights (GCW)	
		Front axle	Rear axle	Braked	Unbraked		
L1 H1 Panel Van	2000 1.4i	2030	1090	1140	1000	500	3030
	2000 1.3CDTi	2040	1090	1140	1000	500	3040
	2000 1.6CDTi	2098	1090	1140	1300	500	3398
	2300 1.3CDTi	2320	1090	1450	1000	500	3320
	2300 1.6CDTi	2418	1200	1450	1300	500	3500
L2 H1 Panel Van	2300 1.4i	2215	1090	1450	1000	500	3215
	2300 1.3CDTi	2385	1120	1450	1000	500	3385
	2300 1.6CDTi	2458	1200	1450	1300	500	3500
L1 H2 Panel Van	2000 1.6CDTi	2120	1090	1140	1300	500	3420
	2300 1.6CDTi	2428	1200	1450	1300	500	3500
L2 H2 Panel Van	2300 1.6CDTi	2488	1200	1450	1300	500	3500

Gross plated weights (including axle weights) quoted on the vehicle plate are to UK plated weight specification and must never be exceeded. For further information please see Glossary of Terms.

## LOADSPACE VOLUMES CU.M (CU.FT.) – PANEL VAN

	L1	L2
H1 Panel Van	3.4 (121)	4.2 (148)
H2 Panel Van	4.0 (141)	5.0 (177)

# COMBO CREW VAN SPECIFICATIONS

## L1/L2 H1

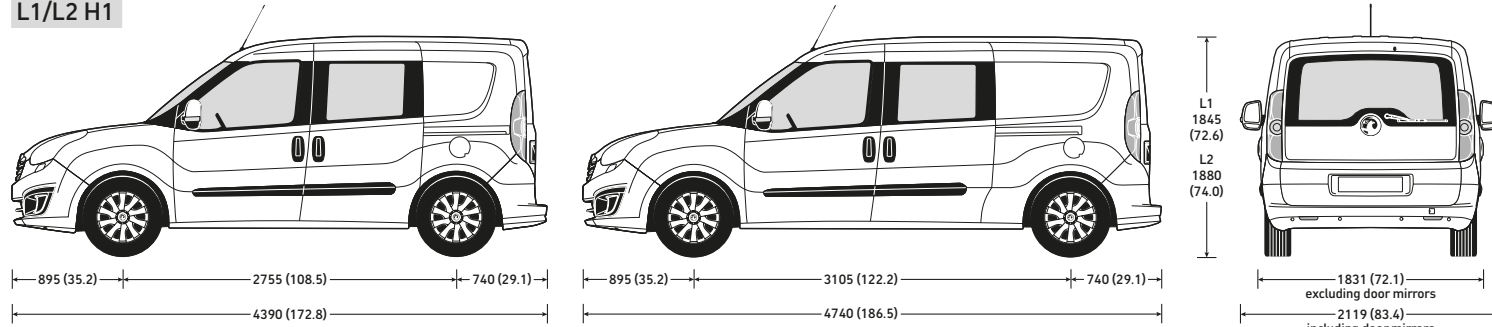

Please note, Glazed Crew Van illustrated. Height shown unladen.

### LOADSPACE DIMENSIONS MM (INCHES) – CREW VAN

	L1	L2
Maximum length – with seats up	991 (39.0)	1341 (52.8)
Maximum length – with seats down	1400 (55.1)	1750 (68.9)
Maximum width	1714 (67.5)	1714 (67.5)
Width between wheel arches	1230 (48.4)	1230 (48.4)
Maximum height	1305 (51.4)	1305 (51.4)

### LOADSPACE ACCESS MM (INCHES) – CREW VAN

	L1	L2
Side door aperture height	1175 (46.2)	1175 (46.2)
Side door aperture width	700 (27.5)	700 (27.5)
Rear door aperture height	1250 (49.2)	1250 (49.2)
Rear door aperture width	1231 (48.5)	1231 (48.5)
Loading height (unladen)	545 (21.4)	545 (21.4)

### PLATED WEIGHTS AND TOWING DATA KG – CREW VAN / COLORADO

Model	Gross Vehicle Weights (GVW)	Plated weights		Towing weights		Plated Gross Combination Weights (GCW)	
		Front axle	Rear axle	Braked	Unbraked		
L1 H1 Crew Van	2300 1.3CDTi	2234	1090	1310	1000	500	3234
	2300 1.6CDTi	2254	1090	1310	1300	500	3398
L2 H1 Crew Van	2300 1.3CDTi	2254	1120	1310	1000	500	3254
	2300 1.6CDTi	2349	1200	1310	1300	500	3500
L2 H1 Colorado	2300 1.3CDTi	2254	1120	1310	1000	500	3254

Gross plated weights (including axle weights) quoted on the vehicle plate are to UK plated weight specification and must never be exceeded. For further information please see Glossary of Terms.

### LOADSPACE VOLUMES CU.M (CU.FT.) – CREW VAN

	L1 H1	L2 H1
Crew Van – with seats up (to top of seats)	0.8 (28.2)	1.0 (35.3)
Crew Van – with seats up (to roof)	1.4 (49.4)	1.9 (67.1)



# VIVARO SPECIFICATIONS

## ENGINES

	<b>1.6CDTi (95PS) BlueInjection with or without Start/Stop</b>	<b>1.6CDTi (120PS) BlueInjection</b>
Capacity	1598cc	1598cc
Maximum power	95PS (70kW) @ 3500rpm	120PS (89kW) @ 3500rpm
Maximum torque	260Nm (192 lb.ft.) @ 1500rpm	300Nm (221 lb.ft.) @ 1750rpm
Configuration	4 cylinders, 4 valves per cylinder, double overhead camshafts	
Fuel/induction system	Variable geometry turbocharger with intercooler. Common rail fuel injection	
Emission compliance	Euro 6	
Service interval	25,000 miles or two-years (whichever occurs sooner)	

	<b>1.6CDTi BiTurbo (125PS) ecoTEC BlueInjection Start/Stop</b>	<b>1.6CDTi BiTurbo (145PS) BlueInjection Start/Stop</b>
Capacity	1598cc	1598cc
Maximum power	125PS (92kW) @ 3500rpm	145PS (107kW) @ 3500rpm
Maximum torque	320Nm (236 lb.ft.) @ 1500rpm	340Nm (251 lb.ft.) @ 1750rpm
Configuration	4 cylinders, 4 valves per cylinder, double overhead camshafts	
Fuel/induction system	Twin variable geometry turbochargers with intercoolers. Common rail fuel injection	
Emission compliance	Euro 6	
Service interval	25,000 miles or two-years (whichever occurs sooner)	

\* = Please note: Vehicles with BlueInjection technology will need regular AdBlue® top-ups also between servicing requirements. An indicator integrated into the onboard computer will warn you when you need to top up. More information under [www.vauxhall.co.uk/blueinjection](http://www.vauxhall.co.uk/blueinjection). In accordance with regulations R (EC) No. 715/2007 and R (EC) No. 692/2008 (in the versions respectively applicable).

# VIVARO PANEL VAN SPECIFICATIONS

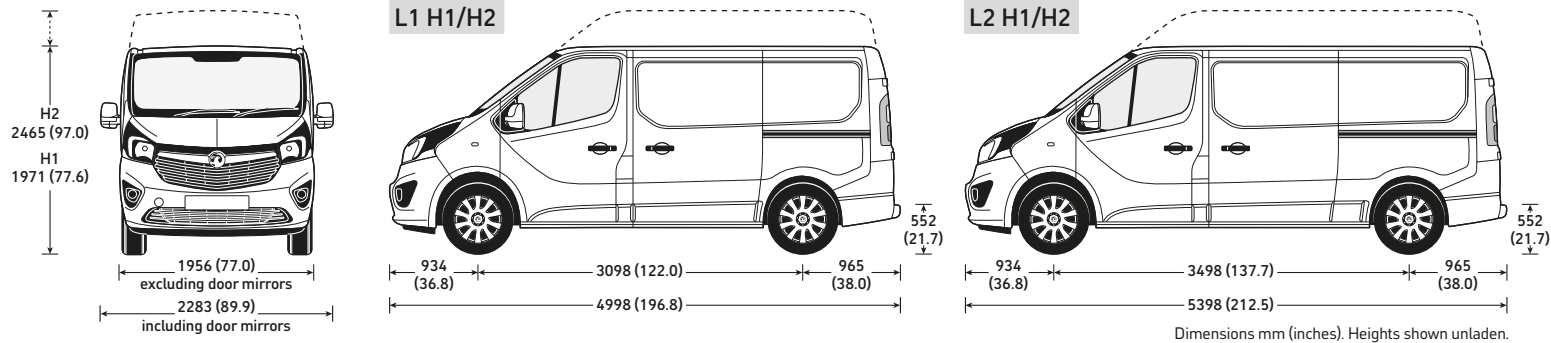

## LOADSPACE DIMENSIONS MM (INCHES) – PANEL VAN

	L1	L2
Maximum length at load floor	2537 (99.9)	2937 (115.6)
Maximum length with load-through facility maximum length to seat – <i>Approximate.</i>	2967 (116.8)	3367 (132.5)
Maximum length with load-through facility maximum length to front footwell – <i>Approximate.</i>	3750 (147.6)	4150 (163.4)
Maximum width	1662 (65.5)	1662 (65.5)
Width between wheel arches	1268 (49.9)	1268 (49.9)
Maximum height - H1	1387 (54.6)	1387 (54.6)
Maximum height - H2	1898 (74.7)	1898 (74.7)

## LOADSPACE ACCESS MM (INCHES) – PANEL VAN

	L1	L2
Side door aperture height	1284 (50.5)	1284 (50.5)
Side door aperture width	1030 (40.5)	1030 (40.5)
Rear door aperture height – H1	1320 (52.0)	1320 (52.0)
Rear door aperture height – H2	1820 (71.6)	1820 (71.6)
Rear door aperture width	1391 (54.8)	1391 (54.8)
Loading height (unladen)	552 (21.7)	552 (21.7)

## PLATED WEIGHTS AND TOWING DATA KG – PANEL VAN

Model		Gross Vehicle Weights (GVW)	Plated weights		Towing weights		Plated Gross Combination Weights (GCW)
			Front axle	Rear axle	Braked	Unbraked	
L1 H1/H2 Panel Van	2700	2800	1585	1650	2000	750	4800
	2700 BiTurbo	2820	1585	1650	2000	750	4820
	2900	2960	1585	1650	2000	750	4960
	2900 BiTurbo	2980	1585	1650	2000	750	4980
L2 H1 Panel Van	2900	3030	1585	1650	2000	750	5030
	2900 BiTurbo	3040	1585	1650	2000	750	5040
L2 H2 Panel Van	2900 BiTurbo	3070	1585	1650	2000	750	5070

Gross plated weights (including axle weights) quoted on the vehicle plate are to UK plated weight specification and must never be exceeded. For further information please see Glossary of Terms.

## LOADSPACE VOLUMES CU.M (CU.FT.) – PANEL VAN

	L1	L2
H1 Panel Van	5.2 (183.6)	6.0 (211.9)
H2 Panel Van	7.2 (254.3)	8.6 (303.7)

# VIVARO DOUBLECAB SPECIFICATIONS

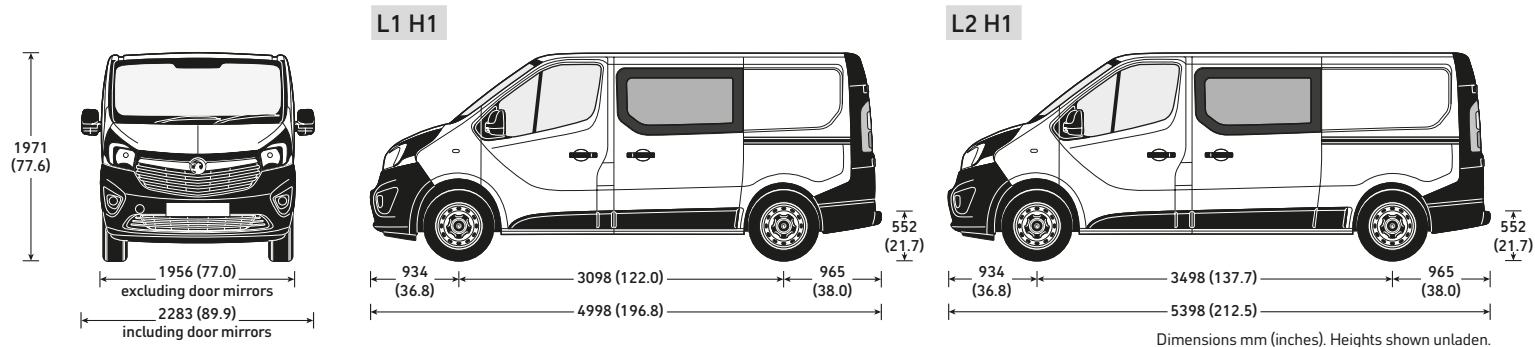

Dimensions mm (inches). Heights shown unladen.

## LOADSPACE DIMENSIONS MM (INCHES) – DOUBLECAB

	L1	L2
Maximum length at load floor	2023 (79.6)	2423 (95.4)
Maximum length behind rear seats	1340 (42.7)	1740 (68.5)
Maximum width	1662 (65.5)	1662 (65.5)
Width between wheel arches	1268 (49.9)	1268 (49.9)
Maximum height	1387 (54.6)	1387 (54.6)

## LOADSPACE ACCESS MM (INCHES) – DOUBLECAB

	L1	L2
Side door aperture height	1284 (50.5)	1284 (50.5)
Side door aperture width	1030 (40.5)	1030 (40.5)
Rear door aperture height	1320 (52.0)	1320 (52.0)
Rear door aperture width	1391 (54.8)	1391 (54.8)
Loading height (unladen)	552 (21.7)	552 (21.7)

## LOADSPACE VOLUMES CU.M (CU.FT.) – DOUBLECAB

	L1	L2
Doublecab	3.2 (113.0)	4.0 (141.3)

## PLATED WEIGHTS AND TOWING DATA KG – DOUBLECAB

Model	Gross Vehicle Weights (GVW)	Plated weights		Towing weights		Plated Gross Combination Weights (GCW)	
		Front axle	Rear axle	Braked	Unbraked		
L1 H1 Doublecab	2900	2834	1585	1650	2000	750	4834
	2900 BiTurbo	2844	1585	1650	2000	750	4844
L2 H1 Doublecab	2900	2940	1585	1650	2000	750	4940
	2900 BiTurbo	2950	1585	1650	2000	750	4950

Gross plated weights (including axle weights) quoted on the vehicle plate are to UK plated weight specification and must never be exceeded. For further information please see Glossary of Terms.

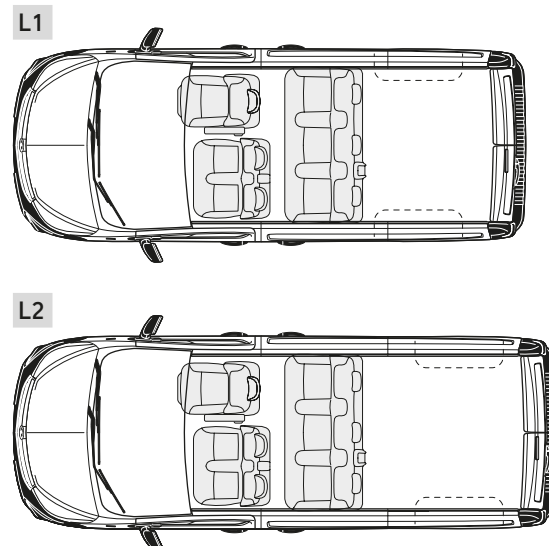

# VIVARO COMBI SPECIFICATIONS

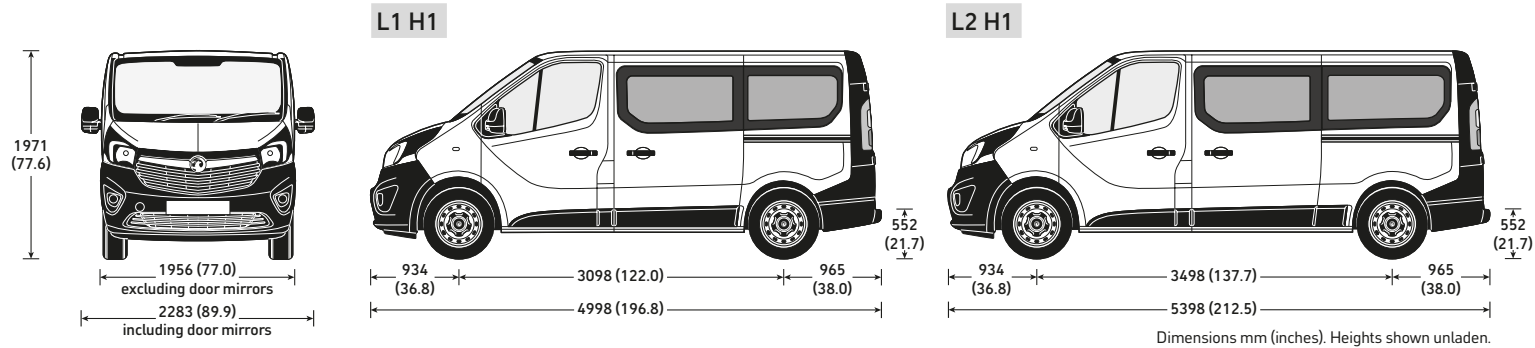

## LOADSPACE DIMENSIONS MM (INCHES) – COMBI

	L1	L2
Maximum length behind rear seats	736 (30.0)	1136 (44.7)
Maximum width	1662 (65.5)	1662 (65.5)
Width between wheel arches	1268 (49.9)	1268 (49.9)
Maximum height	1369 (53.9)	1369 (53.9)

## LOADSPACE ACCESS MM (INCHES) – COMBI

	L1	L2
Side door aperture height	1284 (50.5)	1284 (50.5)
Side door aperture width	1030 (40.5)	1030 (40.5)
Rear door aperture height	1320 (52.0)	1320 (52.0)
Rear door aperture width (at floor)	1391 (54.8)	1391 (54.8)
Loading height (unladen)	552 (21.7)	552 (21.7)

## LOADSPACE VOLUMES CU.M (CU.FT.) – COMBI

	L1	L2
Combi	1.0 (35.3)	1.8 (63.6)
Combi – third-row seats down	2.1 (74.2)	2.9 (102.4)
Combi – third-row seats removed	3.2 (113.0)	4.0 (141.3)

## PLATED WEIGHTS AND TOWING DATA KG – COMBI

Model	Gross Vehicle Weights (GVW)	Plated weights		Towing weights		Plated Gross Combination Weights (GCW)	
		Front axle	Rear axle	Braked	Unbraked		
L1 H1 Combi	2900	2880	1585	1650	2000	750	4880
	2900 BiTurbo	2970	1585	1650	2000	750	4970
L2 H1 Combi	2900	3010	1585	1650	2000	750	5010
	2900 BiTurbo	3020	1585	1650	2000	750	5020

Gross plated weights (including axle weights) quoted on the vehicle plate are to UK plated weight specification and must never be exceeded. For further information please see Glossary of Terms.

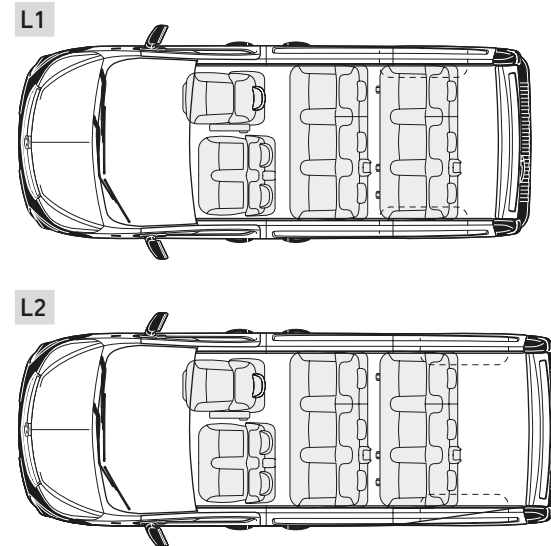

# VIVARO PLATFORM CAB SPECIFICATIONS

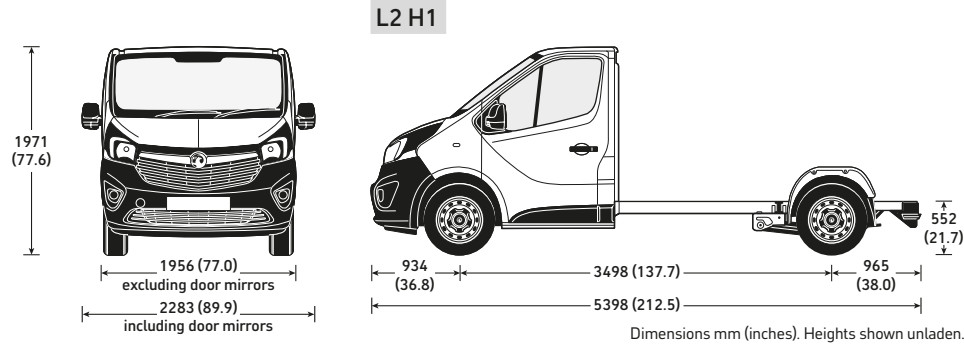

## Platform cabs

Platform cabs are ideal for those conversions requiring a low floor and walk-through access from the cab. The interface panel makes for easy integration of the cab with the conversion body, while an extended-length wiring loom is available to power the rear lights or extended conversions.

All conversions must follow 'Conversion Requirements' guidelines available on: [www.vauxhall.co.uk/conversiondata](http://www.vauxhall.co.uk/conversiondata)

### PLATED WEIGHTS AND TOWING DATA KG – PLATFORM CAB

Model	Gross Vehicle Weights (GVW)	Plated weights		Towing weights		Plated Gross Combination Weights (GCW)	
		Front axle	Rear axle	Braked	Unbraked		
L2 H1 Platform Cab	2900 BiTurbo	3030	1585	1735	2000	750	5030

Gross plated weights (including axle weights) quoted on the vehicle plate are to UK plated weight specification and must never be exceeded. For further information please see Glossary of Terms.

# MOVANO SPECIFICATIONS

## ENGINES

	<b>2.3CDTi (110PS) BlueInjection</b>	<b>2.3CDTi (130PS) BlueInjection</b>	<b>2.3CDTi BiTurbo (130PS) BlueInjection</b>	<b>2.3CDTi BiTurbo (145PS) BlueInjection with Start/Stop</b>
Capacity	2298cc	2298cc	2298cc	2298cc
Maximum power	110PS (81kW) @ 3500rpm	130PS (96kW) @ 3500rpm	130PS (96kW) @ 3500rpm	145PS (107kW) @ 3500rpm
Maximum torque	290Nm (214 lb.ft.) @ 1500rpm	320Nm (236 lb.ft.) @ 1500rpm	330Nm (243 lb.ft.) @ 1500rpm	360Nm (266 lb.ft.) @ 1500rpm
Configuration	4 cylinders, 4 valves per cylinder, double overhead camshafts			
Fuel/induction system	Fixed geometry turbocharger and intercooler. Common rail fuel injection		Twin variable geometry turbochargers and intercoolers. Common rail fuel injection	
Emission compliance	Euro 6	Euro 6	Euro VI	Euro 6 (FWD) / Euro VI (RWD)
Service interval	25,000 miles (20,000 miles on Minibus models) or two years (whichever occurs sooner)			

	<b>2.3CDTi BiTurbo (163PS) BlueInjection with Start/Stop</b>	<b>2.3CDTi BiTurbo (170PS) BlueInjection with Start/Stop</b>
Capacity	2298cc	2298cc
Maximum power	163PS (120kW) @ 3500rpm	170PS (125kW) @ 3500rpm
Maximum torque	360Nm (266 lb.ft.) @ 1500-2750rpm	380Nm (280 lb.ft.) @ 1500rpm
Configuration	4 cylinders, 4 valves per cylinder, double overhead camshafts	
Fuel/induction system	Twin variable geometry turbochargers and intercoolers. Common rail fuel injection	
Emission compliance	Euro VI	Euro 6
Service interval	25,000 miles or two years (whichever occurs sooner)	

Vehicles with BlueInjection technology will need regular AdBlue® top-ups also between servicing requirements. An indicator integrated into the on-board computer will warn you when you need to top up. More information under [www.vauxhall.co.uk/blueinjection](http://www.vauxhall.co.uk/blueinjection). In accordance with regulations R (EC) No. 715/2007 and R (EC) No. 692/2008 (in the versions respectively applicable).

# MOVANO FWD PANEL VAN SPECIFICATIONS

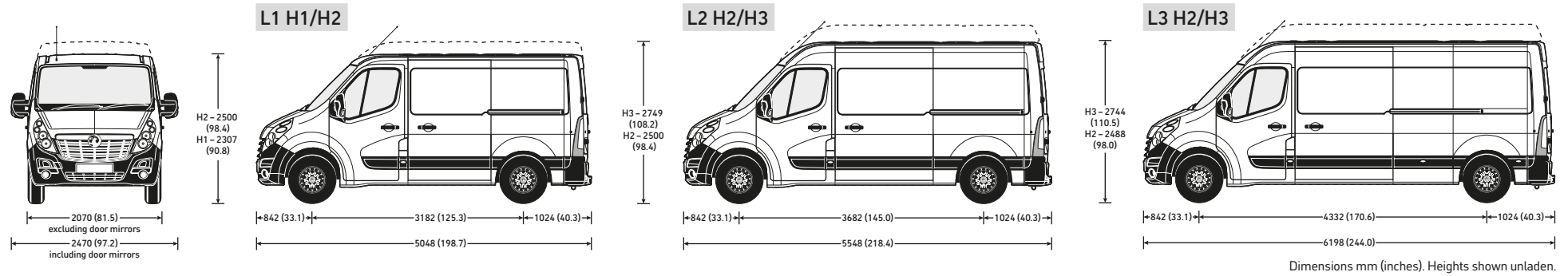

## LOADSPACE DIMENSIONS MM (INCHES) – FWD PANEL VAN

	L1	L2	L3
Maximum length	2583 (101.7)	3083 (121.4)	3733 (147.0)
Maximum width	1765 (69.5)	1765 (69.5)	1765 (69.5)
Width between wheel arches	1380 (54.3)	1380 (54.3)	1380 (54.3)
Maximum height – H1	1700 (66.9)	-	-
Maximum height – H2	1894 (74.6)	1894 (74.6)	1894 (74.6)
Maximum height – H3	-	2144 (84.4)	2144 (84.4)

## LOADSPACE ACCESS MM (INCHES) – FWD PANEL VAN

	L1	L2	L3
Side door aperture height – H1	1581 (62.2)	-	-
Side door aperture height – H2/H3	1780 (70.1)	1780 (70.1)	1780 (70.1)
Side door aperture width	1050 (41.3)	1270 (50.0)	1270 (50.0)
Rear door aperture height – H1	1627 (64.0)	-	-
Rear door aperture height – H2/H3	1820 (71.7)	1820 (71.7)	1820 (71.7)
Rear door aperture width	1577 (62.1)	1577 (62.1)	1577 (62.1)
Loading height (unladen)	563 (22.2)	562 (22.1)	557 (21.9)

## PLATED WEIGHTS AND TOWING DATA KG – PANEL VAN

Model		Gross Vehicle Weights (GVW)	Plated weights		Towing weights		Plated Gross Combination Weights (GCW)
			Front axle	Rear axle	Braked	Unbraked	
L1 H1/H2 Panel Van	F2800	2800	1550	1650	2500	750	5300
	F3300	3300	1650	1900	2500	750	5800
	F3500	3500	1850	2100	2500	750	6000
L2 H2/H3 Panel Van	F3300	3300	1700	1900	2500	750	5800
	F3500	3500	1850	2100	2500	750	6000
L3 H2/H3 Panel Van	F3500	3500	1850	2100	2500	750	6000

Gross plated weights (including axle weights) quoted on the vehicle plate are to UK plated weight specification and must never be exceeded. For further information please see Glossary of Terms.

## LOADSPACE VOLUMES CU.M (CU.FT) – FWD PANEL VAN

	L1 H1	L1 H2	L2 H2	L2 H3	L3 H2	L3 H3
Panel Van – Maximum	7.8 (275)	8.6 (304)	10.8 (381)	12.3 (434)	13.0 (459)	14.8 (523)
-VDA	7.0 (247)	-	9.4 (322)	-	11.3 (399)	-

# MOVANO FWD DOUBLECAB SPECIFICATIONS

L2 H2

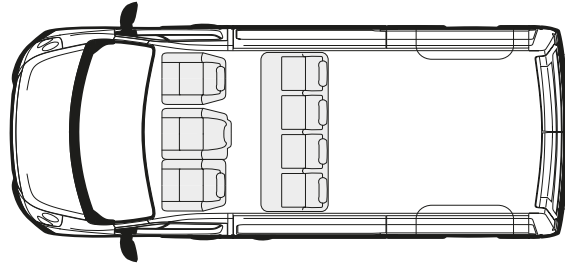

L3 H2

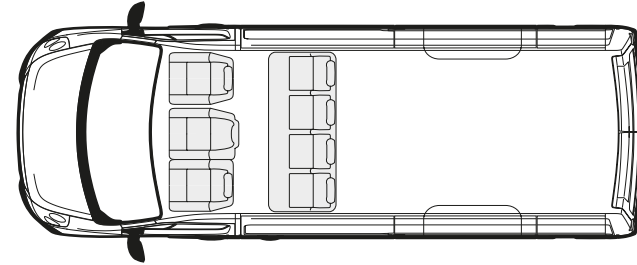

For exterior dimensions see FWD Panel Van.

## LOADSPACE DIMENSIONS MM (INCHES) – FWD DOUBLECAB

	L2	L3
Maximum length at load floor	2175 (85.6)	2825 (111.2)
Maximum length behind rear seats	1990 (78.3)	2640 (103.9)
Maximum width	1765 (69.5)	1765 (69.5)
Width between wheel arches	1380 (54.3)	1380 (54.3)
Maximum height	1894 (74.6)	1894 (74.6)

## LOADSPACE ACCESS MM (INCHES) – FWD DOUBLECAB

	L2	L3
Side door aperture height	1780 (70.1)	1780 (70.1)
Side door aperture width	1270 (50.0)	1270 (50.0)
Rear door aperture height	1820 (71.7)	1820 (71.7)
Rear door aperture width	1577 (62.1)	1577 (62.1)
Loading height (unladen)	562 (22.1)	557 (21.9)

## PLATED WEIGHTS AND TOWING DATA KG – DOUBLECAB

Model	F3500	Gross Vehicle Weights (GVW)	Plated weights		Towing weights		Plated Gross Combination Weights (GCW)
			Front axle	Rear axle	Braked	Unbraked	
L2 H2/L3 H2 Doublecab	F3500	3500	1850	2100	2500	750	6000

Gross plated weights (including axle weights) quoted on the vehicle plate are to UK plated weight specification and must never be exceeded. For further information please see Glossary of Terms.

## LOADSPACE VOLUMES CU.M (CU.FT.) – FWD DOUBLECAB

	L2 H2	L3 H2
Doublecab	6.9 (244)	9.0 (318)



# MOVANO RWD DOUBLECAB SPECIFICATIONS

L3 H2

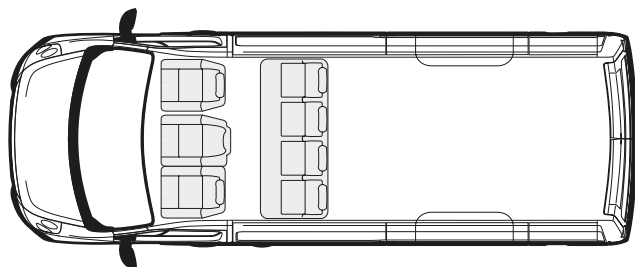

For exterior dimensions see RWD Panel Van.

## LOADSPACE DIMENSIONS MM (INCHES) – RWD DOUBLECAB

	L3
Maximum length at load floor	2825 (111.2)
Maximum length behind rear seats	2640 (103.9)
Maximum width	1765 (69.5)
Width between wheel arches	1380 (54.3)
Maximum height	1798 (70.8)

## LOADSPACE ACCESS MM (INCHES) – RWD DOUBLECAB

	L3
Side door aperture height	1684 (66.3)
Side door aperture width	1270 (50.0)
Rear door aperture height	1724 (67.9)
Rear door aperture width	1577 (62.1)
Loading heights (unladen)	674 (26.5) – 696 (27.4)

## PLATED WEIGHTS AND TOWING DATA KG – DOUBLECAB

Model	Gross Vehicle Weights (GVW)	Plated weights		Towing weights		Plated Gross Combination Weights (GCW)
		Front axle	Rear axle	Braked	Unbraked	
L3 H2 Doublecab	R3500	3500	1850 2300	2500	750	6000

Gross plated weights (including axle weights) quoted on the vehicle plate are to UK plated weight specification and must never be exceeded. For further information please see Glossary of Terms.

## LOADSPACE VOLUMES CU.M (CU.FT.) – RWD DOUBLECAB

	L3 H2
Doublecab	8.4 (297)

# MOVANO RWD PANEL VAN SPECIFICATIONS

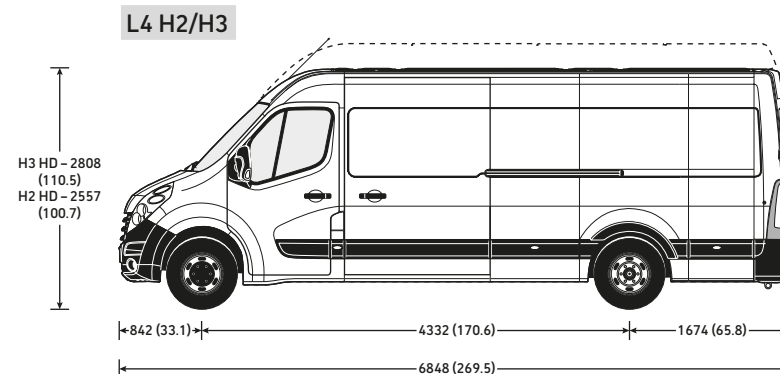
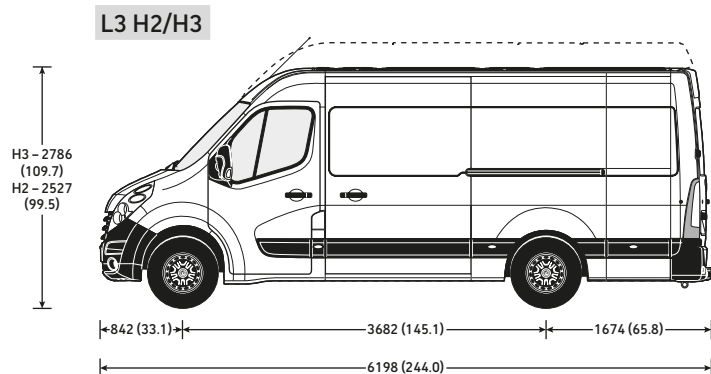

Dimensions mm (inches). Heights shown unladen.

## LOADSPACE DIMENSIONS MM (INCHES) – RWD PANEL VAN

	L3	L4
Maximum length	3733 (147.0)	4383 (172.6)
Maximum width	1765 (69.5)	1765 (69.5)
Width between wheel arches	1380 (54.3)	1380 (54.3)
Maximum height – H2	1798 (70.8)	1798 (70.8)
Maximum height – H3	2048 (80.6)	2048 (80.6)

## LOADSPACE ACCESS MM (INCHES) – RWD PANEL VAN

	L3	L4
Side door aperture height	1684 (66.3)	1684 (66.3)
Side door aperture width	1270 (50.0)	1270 (50.0)
Rear door aperture height	1724 (67.9)	1724 (67.9)
Rear door aperture width	1577 (62.1)	1577 (62.1)
Loading heights (unladen)	696 (27.4) – 724 (28.5)	717 (28.2)

## PLATED WEIGHTS AND TOWING DATA KG – RWD PANEL VAN

Model	R3500	Gross Vehicle Weights (GVW)	Plated weights		Towing weights		Plated Gross Combination Weights (GCW)
			Front axle	Rear axle	Braked	Unbraked	
L3 H2/H3 Panel Van	R3500	3500	1850	2300	2500	750	6000
L4 H2/H3 Panel Van	R3500	3500	1850	2300	2500	750	6000

Gross plated weights (including axle weights) quoted on the vehicle plate are to UK plated weight specification and must never be exceeded. For further information please see Glossary of Terms.

## LOADSPACE VOLUMES CU.M (CU.FT.) – RWD PANEL VAN

	L3 H2	L3 H3	L4 H2	L4 H3
Panel Van – Maximum	12.4 (438)	14.2 (501)	14.9 (526)	17.0 (600)
– VDA	10.9 (385)	12.2 (431)	12.9 (456)	14.1 (498)

# MOVANO RWD HD PANEL VAN SPECIFICATIONS

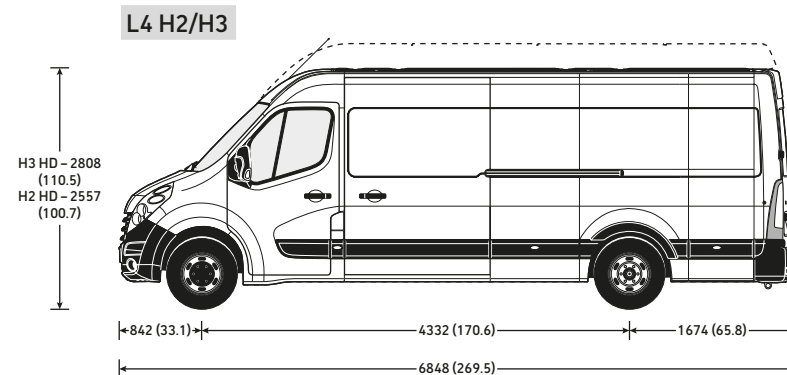
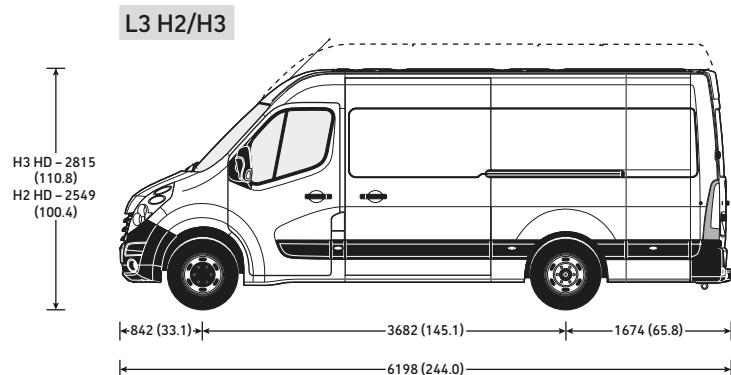

Dimensions mm (inches). Heights shown unladen.

## LOADSPACE DIMENSIONS MM (INCHES) – RWD HD PANEL VAN

	L3	L4
Maximum length	3733 (147.0)	4383 (172.6)
Maximum width	1765 (69.5)	1765 (69.5)
Width between wheel arches	1080 (42.5)	1080 (42.5)
Maximum height – H2	1798 (70.8)	1798 (70.8)
Maximum height – H3	2048 (80.6)	2048 (80.6)

## LOADSPACE ACCESS MM (INCHES) – RWD HD PANEL VAN

	L3	L4
Side door aperture height	1684 (66.3)	1684 (66.3)
Side door aperture width	1270 (50.0)	1270 (50.0)
Rear door aperture height	1724 (67.9)	1724 (67.9)
Rear door aperture width	1577 (62.1)	1577 (62.1)
Loading heights	723 (28.4) – 724 (28.5)	717 (28.2)

## PLATED WEIGHTS AND TOWING DATA KG – RWD HD PANEL VAN

Model		Gross Vehicle Weights (GVW)	Plated weights		Towing weights		Plated Gross Combination Weights (GCW)
			Front axle	Rear axle	Braked	Unbraked	
L3 H2/H3 Panel Van	R3500HD	3500	1850	2800	3000	750	6500
L3 H2/H3 Panel Van	R4500HD	4500	1850	3200	3000	750	7500
L4 H2/H3 Panel Van	R3500HD	3500	1850	2800	3000	750	6500
L4 H2/H3 Panel Van	R4500HD	4500	1850	3200	3000	750	7500

Gross plated weights (including axle weights) quoted on the vehicle plate are to UK plated weight specification and must never be exceeded. For further information please see Glossary of Terms.

## LOADSPACE VOLUMES CU.M (CU.FT.) – RWD HD PANEL VAN

	L3 H2	L3 H3	L4 H2	L4 H3
Panel Van – Maximum	12.4 (438)	14.2 (501)	14.9 (526)	17.0 (600)
– VDA	10.7 (378)	12.0 (424)	12.7 (448)	13.9 (491)

# MOVANO TIPPER / CREW CAB TIPPER SPECIFICATIONS

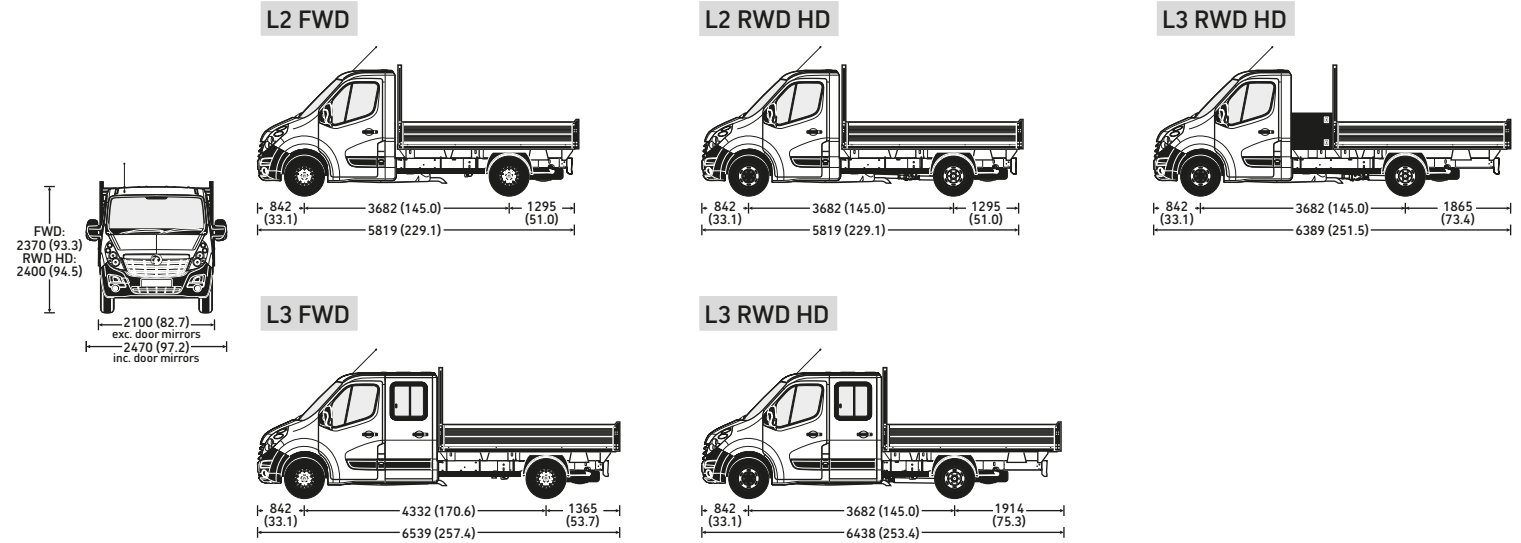

Dimensions mm (inches). Heights shown unladen.

LOADSPACE AREA DIMENSIONS MM (IN) – TIPPER			
	L2 FWD	L2 RWD HD	L3 RWD HD
Maximum length	3205 (126.2)	3205 (126.2)	3105 (122.2)
Maximum width	2040 (80.3)	2040 (80.3)	2040 (80.3)
Body side height	400 (15.7)	400 (15.7)	400 (15.7)
Loading height (unladen)	1090 (42.9)	1090 (42.9)	1090 (42.9)
Load area sq.m (sq.ft.)	6.5 (69.4)	6.5 (69.4)	6.3 (68.2)

LOADSPACE AREA DIMENSIONS MM (IN) – CREW CAB TIPPER		
	L3 FWD	L3 RWD HD
Maximum length	3205 (126.2)	3105 (122.2)
Maximum width	2040 (80.3)	2040 (80.3)
Body side height	400 (15.7)	400 (15.7)
Loading height (unladen)	1090 (42.9)	1090 (42.9)
Load area sq.m (sq.ft.)	6.5 (69.4)	6.3 (68.2)

# MOVANO DROPSIDE SPECIFICATIONS

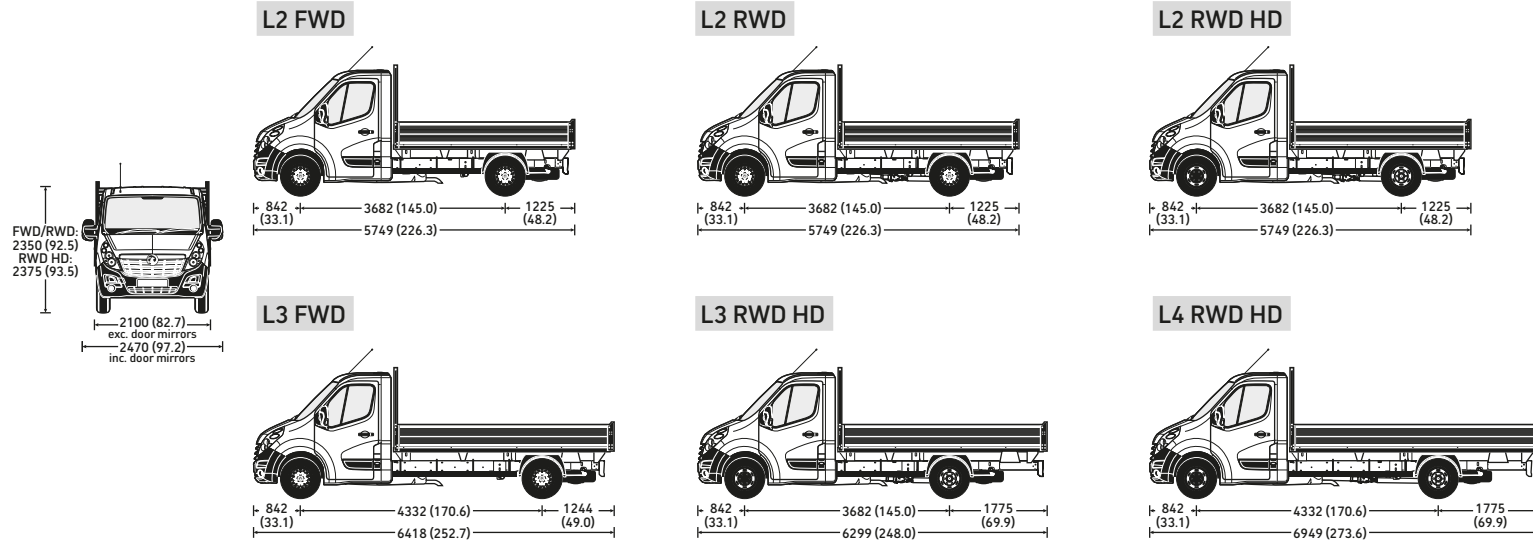

Dimensions mm (inches). Heights shown unladen.

LOADSPACE AREA DIMENSIONS MM (IN) – DROPSIDE					
	L2 FWD	L3 FWD	L2 RWD / RWD HD	L3 RWD HD	L4 RWD HD
Maximum length	3170 (124.8)	3900 (153.5)	3170 (124.8)	3700 (145.7)	4470 (176.0)
Maximum width	2040 (80.3)	2040 (80.3)	2040 (80.3)	2040 (80.3)	2040 (80.3)
Body side height	400 (15.7)	400 (15.7)	400 (15.7)	400 (15.7)	400 (15.7)
Loading height (unladen)	1026 (40.4)	1026 (40.4)	1026 (40.4)	1026 (40.4)	1026 (40.4)
Load area sq.m (sq.ft.)	6.5 (70.0)	7.8 (83.9)	6.5 (70.0)	7.6 (81.8)	8.9 (95.8)

# MOVANO DROPSIDE CREW CAB SPECIFICATIONS

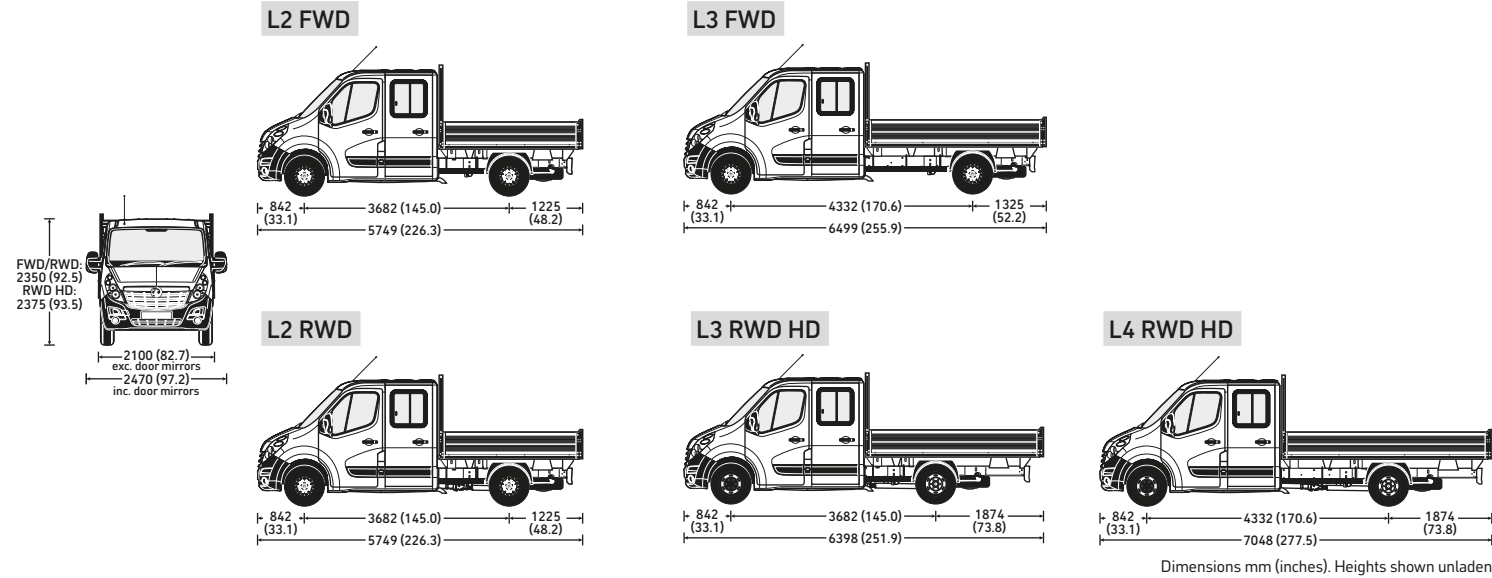

LOADSPACE AREA DIMENSIONS MM (IN) – DROPSIDE CREW CAB					
	L2 FWD	L3 FWD	L2 RWD	L3 RWD HD	L4 RWD HD
Maximum length	2501 (98.5)	3170 (124.8)	2501 (98.5)	3070 (120.9)	3702 (145.7)
Maximum width	2040 (80.3)	2040 (80.3)	2040 (80.3)	2040 (80.3)	2040 (80.3)
Body side height	400 (15.7)	400 (15.7)	400 (15.7)	400 (15.7)	400 (15.7)
Loading height (unladen)	1026 (40.4)	1026 (40.4)	1026 (40.4)	1026 (40.4)	1026 (40.4)
Load area sq.m (sq.ft.)	4.9 (52.7)	6.5 (70.0)	4.9 (52.7)	6.3 (67.8)	7.6 (81.8)

# MOVANO BOX VAN SPECIFICATIONS

**L3 FWD/RWD (20cu.m)**

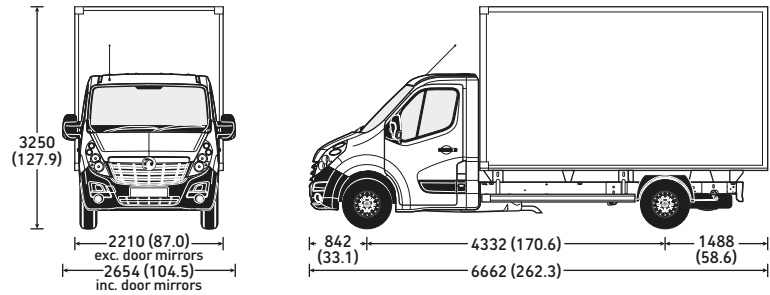

**L4 RWD HD (20cu.m)**

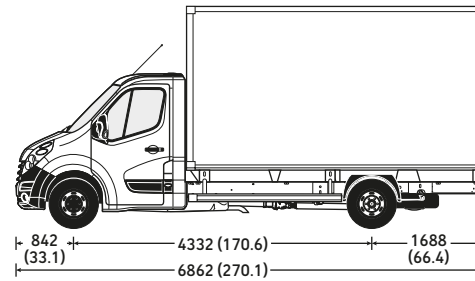

**L4 RWD HD (22cu.m)**

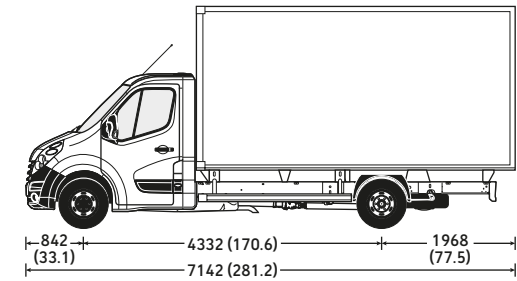

Dimensions mm (inches). Heights shown unladen.

**LOADSPACE DIMENSIONS MM (INCHES) – BOX VAN**

	<b>L3 20cu.m FWD/RWD</b>	<b>L4 20cu.m RWD</b>	<b>L4 22cu.m RWD</b>
Maximum internal length	4100 (161.4)	4300 (169.3)	4580 (180.3)
Maximum internal width	2150 (84.6)	2150 (84.6)	2150 (84.6)
Maximum internal height	2200 (86.6)	2200 (86.6)	2200 (86.6)
Loading height (unladen)	1050 (41.3)	1050 (41.3)	1050 (41.3)

**LOADSPACE VOLUME CU.M (CU.FT.) – BOX VAN**

VDA method	19.4 (685.1)	20.3 (716.9)	21.7 (766.3)
------------	--------------	--------------	--------------

# MOVANO COMBI / MINIBUS SPECIFICATIONS

L1 H1 9-SEAT

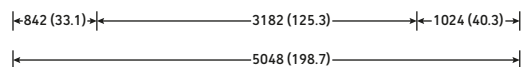
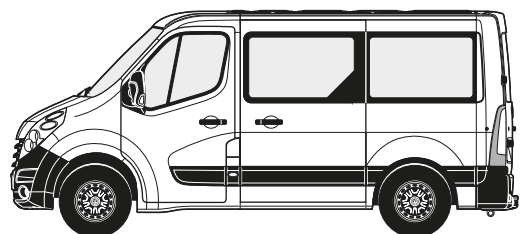

L2 H2 9-SEAT

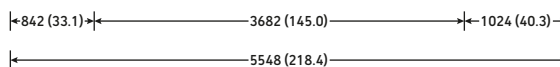
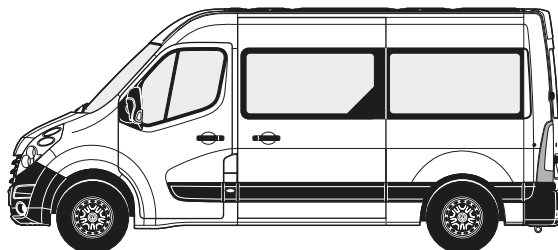

L1 H1 / L2 H2 9-SEAT

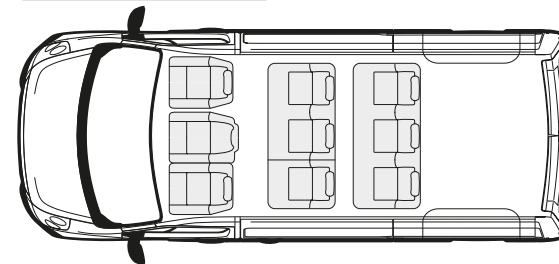

L3 H2 17-SEAT

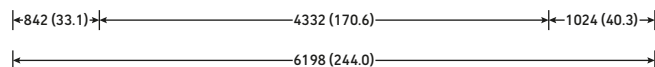
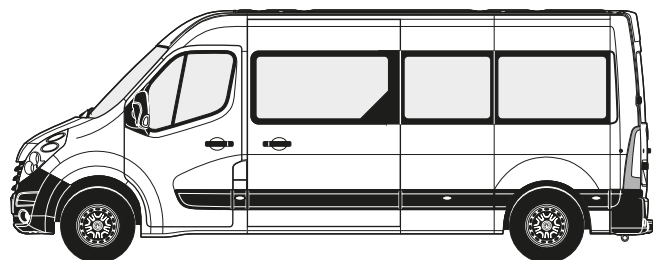

L3 H2 17-SEAT

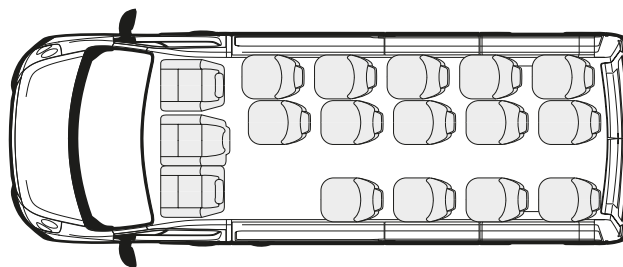

Measurements are shown in millimetres (inches).

## PLATED WEIGHTS AND TOWING DATA KG – COMBI / MINIBUS

Model	Gross Vehicle Weights (GVW)	Plated weights		Towing weights		Plated Gross Combination Weights (GCW)	
		Front axle	Rear axle	Braked	Unbraked		
L1 H1 Combi	F3300	3300	1650	1900	2500	750	5800
L2 H2 Combi	F3500	3500	1850	2100	2500	750	6000
L3 H2 Minibus	F3960	3960	1850	2150	n/a	n/a	n/a

Gross plated weights (including axle weights) quoted on the vehicle plate are to UK plated weight specification and must never be exceeded. For further information please see Glossary of Terms.



# MOVANO CHASSIS CAB SPECIFICATIONS

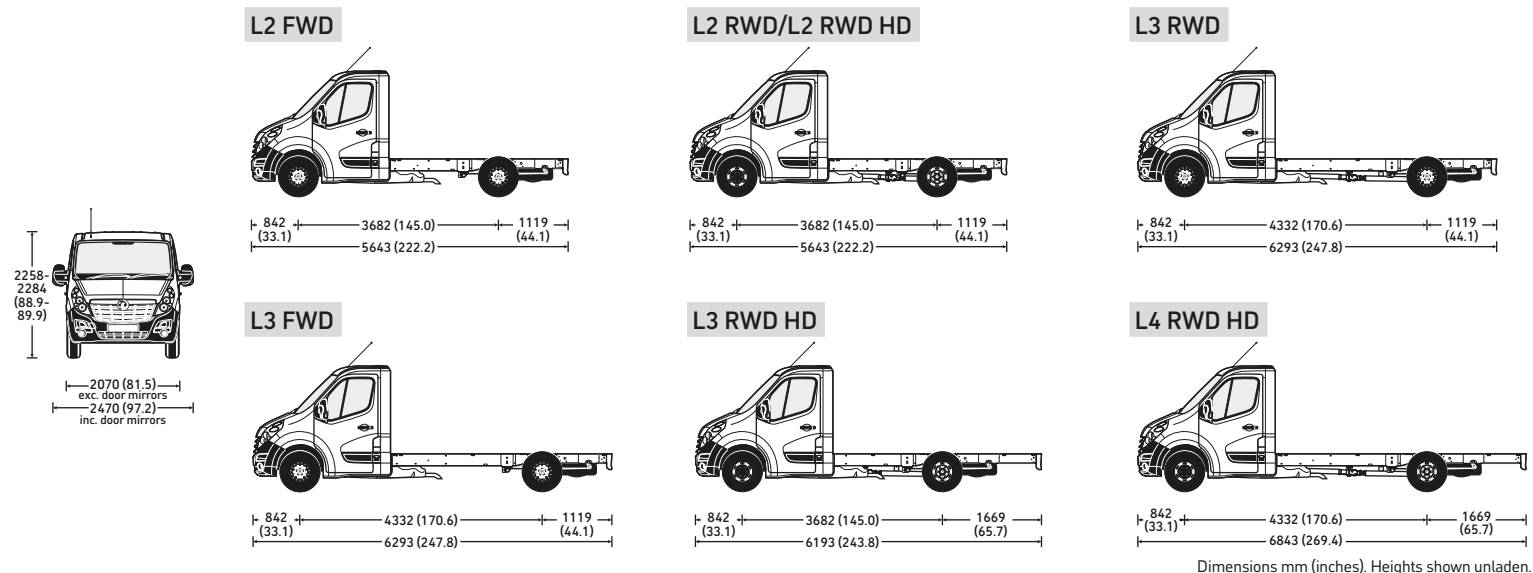

All conversions must follow 'Vauxhall Convertor Requirements' including recommended dimensional data, detailed within Part 1, available at: [www.vauxhall.co.uk/conversiondata](http://www.vauxhall.co.uk/conversiondata). The weight of any fitted conversion body will have to be deducted from these figures to establish actual payload and is subject to correct weight distribution. Variations from the recommended dimensions or weights may affect the vehicle's overall centre of gravity and stability. From 29 April 2013 conversion of N1 vehicles was affected by changes to type approval – for further information refer to the VCA website (N2 vehicles were affected from 29 October 2014). For further information please contact [conversions@vauxhall.co.uk](mailto:conversions@vauxhall.co.uk)

## PLATED WEIGHTS AND TOWING DATA KG – CHASSIS CAB

Model	Gross Vehicle Weights (GVW)	Plated weights		Towing weights		Plated Gross Combination Weights (GCW)	
		Front axle	Rear axle	Braked	Unbraked		
<b>L2 H1/L3 H1/L4 H1</b>	F3500	3500	1850	2100	2500	750	6000
<b>Chassis</b>	R3500	3500	1850	2300	2500	750	6000
	R3500HD	3500	1850	2800	3500	750	7000
	R4500HD	4500	1850	3200	3000	750	7500

Gross plated weights (including axle weights) quoted on the vehicle plate are to UK plated weight specification and must never be exceeded. For further information please see Glossary of Terms.

# MOVANO CHASSIS CREW CAB SPECIFICATIONS

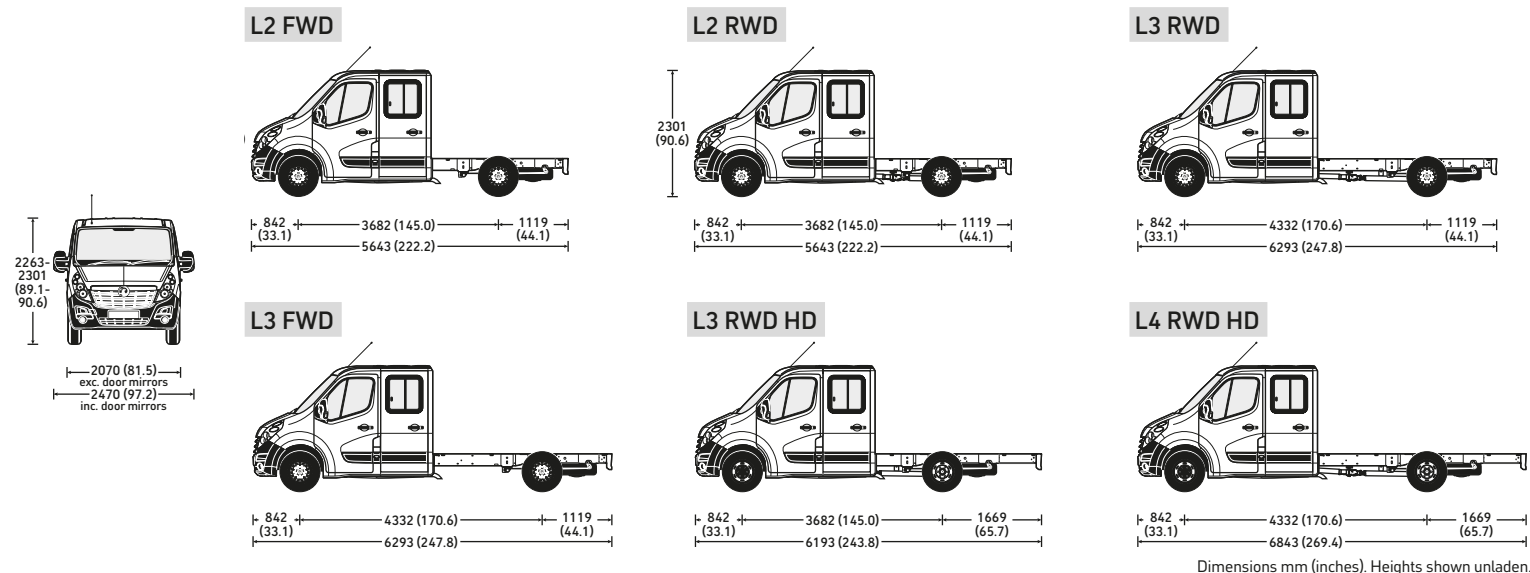

All conversions must follow 'Vauxhall Convertor Requirements' including recommended dimensional data, detailed within Part 1, available at: [www.vauxhall.co.uk/conversiondata](http://www.vauxhall.co.uk/conversiondata). The weight of any fitted conversion body will have to be deducted from these figures to establish actual payload and is subject to correct weight distribution. Variations from the recommended dimensions or weights may affect the vehicle's overall centre of gravity and stability. From 29 April 2013 conversion of N1 vehicles was affected by changes to type approval – for further information refer to the VCA website (N2 vehicles were affected from 29 October 2014). For further information please contact [conversions@vauxhall.co.uk](mailto:conversions@vauxhall.co.uk)

## PLATED WEIGHTS AND TOWING DATA KG – CHASSIS CREW CAB

Model	Gross Vehicle Weights (GVW)	Plated weights		Towing weights		Plated Gross Combination Weights (GCW)
		Front axle	Rear axle	Braked	Unbraked	
L2 H1/L3 H1/L4 H1 Chassis Crew Cab	F3500	3500	1850	2500	750	6000
	R3500	3500	1850	2500	750	6000
	R3500HD	3500	1850	3500	750	7000
	R4500HD	4500	1850	3200	3000	7500

Gross plated weights (including axle weights) quoted on the vehicle plate are to UK plated weight specification and must never be exceeded. For further information please see Glossary of Terms.

# MOVANO PLATFORM CAB SPECIFICATIONS

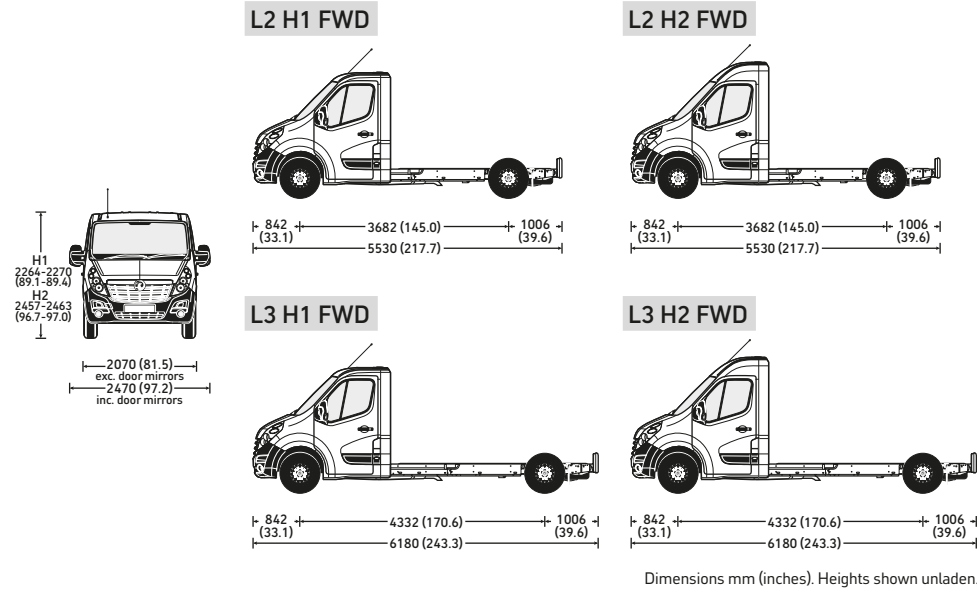

All conversions must follow 'Vauxhall Convertor Requirements' including recommended dimensional data, detailed within Part 1, available at: [www.vauxhall.co.uk/conversiondata](http://www.vauxhall.co.uk/conversiondata). The weight of any fitted conversion body will have to be deducted from these figures to establish actual payload and is subject to correct weight distribution. Variations from the recommended dimensions or weights may affect the vehicle's overall centre of gravity and stability. From 29 April 2013 conversion of N1 vehicles was affected by changes to type approval - for further information refer to the VCA website (N2 vehicles were affected from 29 October 2014). For further information please contact [conversions@vauxhall.co.uk](mailto:conversions@vauxhall.co.uk)

## PLATED WEIGHTS AND TOWING DATA KG - PLATFORM CAB

Model	F3500	Gross Vehicle Weights (GVW)	Plated weights		Towing weights		Plated Gross Combination Weights (GCW)
			Front axle	Rear axle	Braked	Unbraked	
<b>L2 H1/L2 H2/L3 H1/ L3 H2 Platform Cab</b>		3500	1850	2100	2500	750	6000

Gross plated weights (including axle weights) quoted on the vehicle plate are to UK plated weight specification and must never be exceeded. For further information please see Glossary of Terms.

# CORSAVAN ACCESSORIES

	Total (exc. VAT)
<b>INFOTAINMENT</b>	
<b>Sat Nav updates<sup>1</sup></b>	
Please consult your Retailer for latest map updates or visit <a href="http://www.vauxhall.co.uk/accessories">www.vauxhall.co.uk/accessories</a> .	
<small>1 = For use with optional factory-fit satellite navigation systems.</small>	
<b>SAFETY</b>	
Safety pack – first aid kit, warning triangle, hi-visibility vest	£30.00
First aid kit	£12.00
Warning triangle	£14.00
Hi-visibility vest	£7.00
Fire extinguisher – 2kg	£59.00
Temporary tyre inflation kit	£125.00
Tyre sealant	£46.00

	Total (exc. VAT)
<b>PRACTICAL</b>	
Spare bulb kit	£16.00
Stretch tow rope – 3 tonne	£29.00
<b>SECURITY</b>	
Locking wheel bolts – set of four	£36.00
<b>PROTECTION – INTERIOR</b>	
Rubber floor mats – front pair	£41.00
<b>PROTECTION – LOAD AREA</b>	
Hard cargo liner	£172.15
<b>PROTECTION – EXTERIOR</b>	
Mudflaps – set of four <sup>3</sup>	£100.00
Rear parking distance sensors	£265.00
<small>3 = Not available with certain exterior styling accessories.</small>	
<b>ROOF CARRIER SYSTEM</b>	
T-track base carrier – two roof bars	£121.00

**Please note:**

Prices shown are fully fitted and painted where applicable.

All prices are exclusive of VAT.

It is advisable to ensure your insurance policy is adequate to cover additional fitted accessories.

Prices correct at time of publication.

# COMBO ACCESSORIES

	Total (exc. VAT)
<b>SAFETY</b>	
Safety pack – first aid kit, warning triangle, hi-visibility vest	£30.00
First aid kit	£12.00
Warning triangle	£14.00
Hi-visibility vest	£7.00
Fire extinguisher – 2kg	£59.00
Temporary tyre inflation kit	£125.00
Tyre sealant	£46.00
<b>PRACTICAL</b>	
Stretch tow rope – 3 tonne	£29.00
<b>SECURITY</b>	
Security alarm system	
– without pre-installation	£364.00
– with pre-installation	£335.00
Steering wheel security bar	£78.00
Locking wheel bolts – set of four	£41.00
Rear window grilles – rear doors, not tailgate	£131.00
<b>PROTECTION – INTERIOR</b>	
Heavy duty carpet mat	£18.00

	Total (exc. VAT)
<b>PROTECTION – LOAD AREA</b>	
Wooden floor protection	
– L1	£173.00
– L2	£205.00
Cargo liner (rigid)	£67.00
<b>PROTECTION – EXTERIOR</b>	
Mudflaps – rear pair only	£78.00
<b>ROOF CARRIER SYSTEM</b>	
Pair of roof bars (70kg) <sup>1</sup>	£178.00
Three roof bars (100kg) <sup>1</sup>	£282.00
Complete roof rack with spoiler and loading system (L1)	£517.00
Complete roof rack with spoiler and loading system (L2)	£571.00
<small><sup>1</sup> = Can only be used in conjunction with optional factory-fitted roof rails.</small>	
<b>TOWING</b>	
Fixed tow bar with 13-pin electrics	£544.67
Flange tow bar with 13-pin electrics	£550.65
Heavy duty tow bar with 13-pin electrics	£621.00
Removable tow bar with 13-pin electrics	£712.00

	Total (exc. VAT)
<b>INTERIOR STYLING</b>	
Sport pedal covers	£106.00
Leather gear knob / gaiter	
– bordeaux/black or grey/black	from £89.00
<b>EXTERIOR STYLING</b>	
Chromed door mirrors	£70.00

**Please note:**

Prices shown are fully fitted and painted where applicable.  
 All prices are exclusive of VAT.  
 It is advisable to ensure your insurance policy is adequate to cover additional fitted accessories.  
 Prices correct at time of publication.

# VIVARO ACCESSORIES

	Total (exc. VAT)
<b>SAFETY</b>	
Safety pack – first aid kit, warning triangle,	
hi-visibility vest	£30.00
First aid kit	£12.00
Warning triangle	£14.00
Hi-visibility vest	£7.00
Fire extinguisher – 2kg	£58.00
Temporary tyre inflation kit	£125.00
Tyre sealant	£46.00

	Total (exc. VAT)
<b>PRACTICAL</b>	
Spare bulb kit	£16.00
Stretch tow rope – 3 tonne	£29.00

	Total (exc. VAT)
<b>SECURITY</b>	
Security alarm system	£315.00
Rear window grilles for rear doors, not tailgate	£195.00

	Total (exc. VAT)
<b>PROTECTION – LOAD AREA</b>	
Plywood floor panel	from £411.00
Plywood side panel	from £93.00

	Total (exc. VAT)
<b>PROTECTION – EXTERIOR</b>	
Mudflaps – set of four	£123.00
Protective wheel arch mouldings	from £152.00

	Total (exc. VAT)
<b>ROOF CARRIER SYSTEM</b>	
Base carrier	
– H1 aluminium	£134.00
– H2 aluminium	£170.00
– H1 steel (black)	£159.00
– H2 steel (black)	£149.00
L1 H1	
– roof rack tray	from £773.00
– walkway	from £215.00
L2 H1	
– roof rack tray	from £724.00
– walkway	from £252.00
L1 H2	
– roof rack tray	from £874.00
– walkway	from £215.00
L2 H2	
– roof rack tray	from £898.00
– walkway	from £248.00

	Total (exc. VAT)
<b>TOWING<sup>1</sup></b>	
Fixed tow bar with 7-pin electrics	£620.00
Fixed heavy-duty tow bar with 7-pin electrics	£754.00
Removable tow bar with 7-pin electrics	£738.00
Fixed tow bar with 13-pin electrics	£631.20
Fixed heavy-duty tow bar with 13-pin electrics	£682.15
Removable tow bar with 13-pin electrics	£849.00

<sup>1</sup> = Prices for standard vehicles only.

**Please note:**

Prices shown are fully fitted and painted where applicable.

All prices are exclusive of VAT.

It is advisable to ensure your insurance policy is adequate to cover additional fitted accessories.

Prices correct at time of publication.

# MOVANO ACCESSORIES

	Total (exc. VAT)
<b>SAFETY</b>	
Safety pack – first aid kit, warning triangle, hi-visibility vest	£30.00
First aid kit	£12.00
Warning triangle	£14.00
Hi-visibility vest	£7.00
<b>PRACTICAL</b>	
Spare bulb kit	£16.00
Stretch tow rope – 3 tonne	£29.00
Smoker Pack	£44.00
<b>SECURITY</b>	
Steering wheel security bar	£78.00
Rear window grilles – H1, H2, H3	£133.00
Side sliding door (offside) window grille – L2, L3, L4	£134.00
Side sliding door (nearside) window grille – L2, L3, L4	£159.00
<b>PROTECTION</b>	
Carpet front floor mat	£54.00
Anti-slip mat	£76.00
Seat covers – standard (all models)	from £146.00
Seat covers – premium (all models)	£168.00
Mudflaps – set of four	
– L1/L2	from £135.00
Rear parking distance sensor (4 sensors)	£204.00
Rear-view camera	£291.00

	Total (exc. VAT)
<b>ROOF CARRIER SYSTEM</b>	
Base carrier	
– H1	£271.00
– H2	£273.00
L1 H1	
– Aluminium roof rack including roller	£860.00
– Steel walkway	£257.00
L1 H2	
– Aluminium roof rack including roller	£860.00
– Steel walkway	£257.00
L2 H2	
– Aluminium roof rack including roller	£970.00
– Steel walkway	£301.00
L3 H2	
– Aluminium roof rack including roller	£962.00
– Steel walkway	£299.00
L4 H2	
– Aluminium roof rack including roller	£955.00
– Steel walkway	£296.00
<b>TOWING</b>	
Flange tow bar with 13-pin electrics	from £494.00

**Please note:**

Prices shown are fully fitted and painted where applicable.

All prices are exclusive of VAT.

It is advisable to ensure your insurance policy is adequate to cover additional fitted accessories.

Prices correct at time of publication.

### FOR MORE PRODUCT INFORMATION

For a brochure on any Vauxhall model (up to a maximum of three per caller) or location of your nearest Vauxhall Retailer please call **0345 600 1500**. Alternatively, details can be found on our website at [www.vauxhall.co.uk](http://www.vauxhall.co.uk)

### JOIN US ONLINE:



### PROUD SPONSOR OF OUR NATIONAL FOOTBALL TEAMS



Every effort has been made to ensure that the contents of this document were accurate and up-to-date at the time of publication – 1 August 2017. The invoice price, including delivery to Retailer, factory-fitted options, accessories fitted by the Retailer and number plates, is subject to VAT. The right is reserved to alter specifications and prices, and withdraw products from sale, without notice. Please note that Vauxhall Retailers are not the agents of General Motors UK Limited and are not authorised to bind General Motors UK Limited by any specific or implied undertaking or representation. It is advisable to ensure that your motor insurance policy provides adequate cover for additional fitted options and accessories. All rights reserved. No part of this publication may be reproduced in any form or by any means, without the prior written permission of General Motors UK Limited.

General Motors UK Limited t/a Vauxhall, Griffin House, UK1-101-135, Osborne Road, Luton, Bedfordshire, LU1 3YT. [www.vauxhall.co.uk](http://www.vauxhall.co.uk)

©2017 General Motors UK Limited

**COMMERCIAL VEHICLES**  
*The Wheels of Business*



**VAUXHALL**



# COMMERCIAL VEHICLE RANGE PRICE GUIDE



1 August 2017

MY 2017

# Range pricing information

## Contents

Corsavan Prices	3
Corsavan Equipment/Options	4
Combo Prices	14
Combo Equipment/Options	18
Vivaro Prices	27
Vivaro Equipment/Options	31
Movano Prices	44
Movano Equipment/Options	57
Movano One-Invoice Approved Conversions	72
Glossary of Terms	76
Customer Care	77
Corsavan Specifications	78
Combo Specifications	79
Vivaro Specifications	82
Movano Specifications	87
Accessories	101

## Vauxhall on-the-road recommended retail prices (RRP)

To eliminate uncertainty about hidden costs incurred when buying a new commercial vehicle, Vauxhall publishes on-the-road prices and these are shown in the pricing tables within this price guide. The prices shown are manufacturer's recommended retail prices (RRP) unless otherwise stated, exclusive of VAT (currently at a rate of 20% which may be payable). These prices include the recommended cost of number plates, delivery to a Vauxhall Retailer of £583.33 (£700.00 including VAT), 12 months' Government Vehicle Excise Duty\* (shown on each model page) and the DVLA new vehicle first registration fee of £55.00\*.

**Please note:** The RRP does not include fuel supplied by the Retailer, motor insurance or any other goods or services supplied by agreement between the Retailer and customer.

\*Correct at time of publication.

## Price protection for all Vauxhalls

Order a new Vauxhall for build in the current model year (as confirmed by your Retailer) for delivery no more than three months in advance and the price you are quoted is the price you pay. This is irrespective of any subsequent price rises between placing your order and delivery of your new commercial vehicle, but you must take delivery as soon as the commercial vehicle is available. General Motors UK Limited is not liable for price adjustments caused by Government changes in the rate of VAT (currently 20%), Vehicle Excise Duty, DVLA new vehicle first registration fee or by any other applicable legislation or regulations.

\* = Please note that vehicles are limited from stock and that specifications may differ from those described in this Price Guide – consult your Retailer for further details.

# CORSAVAN PRICES

**BEST SMALL DELIVERY VAN**  
 Vauxhall Corsavan  
 1.3CDTi 16v 95PS ecoFLEX  
 Start/Stop



Model	Minimum Mass (kg)*	Payload (kg)*	Fuel economy mpg (litres/100km)#			CO <sub>2</sub> emissions (g/km)#	Price (£) exc. VAT	On-the-road RRP (£) exc. VAT
			Urban driving	Extra-urban driving	Combined figure			
<b>CORSAVAN (EURO 6)</b>								
1.2i (70PS)	1045	560	42.2 (6.7)	61.4 (4.6)	52.3 (5.4)	126	11830.00	<b>12708.33</b>
1.3CDTi (75PS) Start/Stop	1124	571	55.4 (5.1)	83.1 (3.4)	70.6 (4.0)	107	13080.00	<b>13958.33</b>
1.3CDTi (95PS) Start/Stop ecoFLEX	1124	571	68.9 (4.1)	88.3 (3.2)	78.5 (3.6)	94	13530.00	<b>14408.33</b>
1.3CDTi (95PS) Start/Stop ecoFLEX Easytronic	1124	581	70.6 (4.0)	91.1 (3.1)	83.1 (3.4)	91	14066.67	<b>14945.00</b>
<b>CORSAVAN SPORTIVE (EURO 6)</b>								
1.3CDTi (95PS) Start/Stop	1177	543	57.6 (4.9)	78.5 (3.6)	68.9 (4.1)	108	14530.00	<b>15408.33</b>

**Please note:** On-the-road recommended retail prices (RRP) include number plates and delivery to Retailer of £583.33 (exc. VAT), 12 months' Vehicle Excise Duty at £240.00 and new vehicle first registration fee of £55.00. Excludes fuel and insurance.

\* = For definitions please refer to Glossary of Terms.

# = Fuel consumption information is official government environmental data, tested in accordance with the relevant EU directive. Official EU-regulated test data is provided for comparison purposes and actual performance will depend on driving style, road conditions and other non-technical factors.

# CORSAVAN EQUIPMENT / OPTIONS

<b>SAFETY</b>	<b>Corsavan</b>	<b>Sportive</b>	<b>Price (£) exc. VAT</b>
<b>Airbags:</b> <ul style="list-style-type: none"> <li>• Driver's dual-stage airbag</li> <li>• Passenger's dual-stage airbag with deactivation switch</li> <li>• Side-impact airbags</li> <li>• Full-size-curtain airbags</li> </ul>	●	●	
<b>Seating:</b> <ul style="list-style-type: none"> <li>• Height-adjustable seat head restraints</li> <li>• Anti-submarining ramps – <i>Helps prevent occupants sliding underneath the lap belt during a collision.</i></li> </ul>	●	●	
<b>Seatbelts:</b> <ul style="list-style-type: none"> <li>• Inertia-reel lap and diagonal seatbelts</li> <li>• Height-adjustable seatbelts</li> <li>• Seatbelt pretensioner system – <i>Pretensioners tighten the seatbelt in the event of an accident limiting forward movement.</i></li> <li>• Seatbelt force limiters – <i>Reduces potential upper body injuries during a frontal impact.</i></li> <li>• Seatbelt unfastened audible warning and warning light</li> </ul>	●	●	
<b>Body:</b> <ul style="list-style-type: none"> <li>• Pedal release system – <i>Reduces potential injury to the driver's legs and feet during a severe frontal impact.</i></li> <li>• Laminated windscreen</li> <li>• Side-impact protection beams</li> <li>• Reinforced passenger safety cell</li> <li>• Fuel tank located ahead of rear axle</li> </ul>	●	●	
<b>Stability:</b> <i>Electronic Stability Programme-plus (ESP-plus) with traction control – Works in conjunction with the vehicle's electronic braking and engine systems to keep the vehicle stable in many different situations. ESP monitors a variety of inputs to determine when the vehicle starts to lose traction, it can then immediately respond by varying the brake pressure between up to three wheels and adjust the engine output to help correct the loss of traction and improve stability.</i> <i>Drag torque control – Helps maintain stability when suddenly lifting off the accelerator.</i>	●	●	
<b>Tyre pressure:</b> <ul style="list-style-type: none"> <li>• Tyre pressure monitoring system</li> </ul>	●	●	
<b>Braking:</b> <i>Four-channel Anti-lock Braking System (ABS) – Prevents the vehicle's wheels from locking up under heavy braking by momentarily reducing brake pressure at the appropriate wheel, ensuring that you can maintain control of the steering.</i> <i>Emergency brake assist – When emergency braking is detected the vehicle automatically applies the maximum possible braking assistance.</i> <i>Electronic brakeforce distribution – Automatically apportions the optimum braking force to each wheel.</i> <i>Hill start assist – Briefly maintains rear brake pressure to stop the vehicle rolling back on an incline.</i> <i>Cornering brake control / Straight line stability control – Senses the different speeds of each wheel and applies differing braking levels to each one to ensure the whole vehicle remains under control.</i>	●	●	

## SECURITY

<b>Features:</b> <ul style="list-style-type: none"> <li>• Electronic engine deadlock immobiliser</li> <li>• Steering column lock</li> <li>• Electronic theft protection for audio equipment</li> <li>• 'Key left in ignition' audible warning</li> <li>• Visible Vehicle Identification Number (VIN)</li> <li>• Locking wheel bolts for alloy wheels</li> </ul>	●	●	
<b>Remote control door locking (doors, tailgate and fuel flap):</b> <ul style="list-style-type: none"> <li>• Remote control door locking</li> <li>• Two folding keys with integral remote</li> <li>• Door deadlocks</li> </ul>	●	●	

● = Standard equipment.

# CORSAVAN EQUIPMENT / OPTIONS

## COMFORT AND SEATING

	Corsavan	Sportive	Price (£) exc. VAT
<b>Comfort:</b>			
<ul style="list-style-type: none"> <li>Steering column adjustable for reach and rake</li> <li>Leather-covered steering wheel (Sportive models)</li> <li>Floor-mounted handbrake lever</li> <li>Spot Shimmer black cloth seat trim (Standard models)</li> <li>Lace cloth seat trim (Sportive models)</li> <li>Height-adjustable seatbelts</li> </ul>	●	●	
<b>Seating:</b>			
<ul style="list-style-type: none"> <li>Reach</li> <li>Backrest recline</li> <li>Easy-entry seats with memory function</li> </ul>	●	●	
<ul style="list-style-type: none"> <li>Driver's seat height adjuster</li> </ul>	○	●	70.00
<ul style="list-style-type: none"> <li>Sports-style seats</li> </ul>		●	

## INTERIOR CONVENIENCE

<b>Accessory sockets:</b>			
<ul style="list-style-type: none"> <li>Facia-mounted 12-volt accessory socket</li> </ul>	●	●	
<b>Interior:</b>			
<ul style="list-style-type: none"> <li>Storage box on driver's side lower facia</li> <li>Illuminated glovebox with lid</li> <li>Coin holder</li> <li>Drinks holder in centre console</li> <li>Door pockets</li> <li>Dipping rear-view mirror</li> <li>Twin sunvisors, driver's with vanity mirror and cover</li> <li>Chrome-effect door handles and handbrake button</li> <li>Driver and passenger's tiltable assist handles</li> </ul>	●	●	
<ul style="list-style-type: none"> <li>Automatic anti-dazzle rear-view mirror</li> </ul>		●	
<b>Lighting:</b>			
<ul style="list-style-type: none"> <li>Centre fade up/fade down courtesy light</li> <li>Map reading lights</li> </ul>	●	●	
<ul style="list-style-type: none"> <li>Ambient lighting</li> </ul>		●	

● = Standard equipment. ○ = Optional at extra cost.

# CORSAVAN EQUIPMENT / OPTIONS

## DRIVER ASSISTANCE

	Corsavan	Sportive	Price (£) exc. VAT
<p><b>Driving Assistance Pack (deletes City mode steering):</b>  <i>A wide range of class-leading driver assistance and safety features are controlled by the front camera system.</i>  <b>Forward collision alert:</b>  <i>The system warns you when approaching another vehicle too quickly – operates at speeds above 25mph.</i>                      • Visual warnings – projected onto windscreen and shown in the instrument cluster • Audible warning                      • Sensitivity can be adjusted via a steering wheel mounted control  <b>Traffic sign recognition:</b>  <i>Detects and then displays speed limits, reducing uncertainty and the risk of speeding.</i>                      • Recognises different road signs, including temporary speed restrictions • Displays reminder in the instrument cluster  <b>Following distance indicator:</b>  <i>At speeds above 25mph indicates how many seconds you are behind the vehicle in front – helping you maintain a safe distance.</i>                      • Timings are shown in the instrument cluster  <b>Lane departure warning:</b>  <i>If the driver has not actively steered or signalled, the lane departure warning system warns when the car moves outside of lane markings at speeds above 37mph.</i>                      • Warning light in instrument cluster • Audible warning • Facia on/off switch                      – On Corsavan, Driving Assistance Pack is only available in conjunction with optional cruise control.                      Option code: OBG</p>	○	○	<b>1110.00</b>
<p>• Automatic anti-dazzle rear-view mirror</p>		●	
<p>Cruise control, includes leather-covered steering wheel                      Option code: N34</p>	○	●	<b>120.00</b>
<p><b>Speed limiter:</b>                      • Choice of two speeds: 62mph / 68mph – Only available on 1.3CDTi (95PS) manual models.                      Option code: (62mph) KYK                      Option code: (68mph) KYL</p>	○		<b>85.00</b>
<p><b>Windscreen wipers:</b>                      • Two-speed windscreen wipers • Variable intermittent wipe • Electric screenwash • Intermittent rear windows wash/wipe                      • Rain-sensitive windscreen wipers</p>	●	●	
		●	
<p><b>Parking assistance:</b>                      • Rear parking distance sensors • Audible warning • Distance warning graphic showing in driver information display                      Option code: UD7</p>	○	○	<b>260.00</b>
<p>• Rear-view camera • Camera view appears in infotainment screen                      • Rear bumper and one-metre grid lines shown as reference points – Activated when reverse gear selected. Requires rear parking distance sensors and IntelliLink.                      Option code: UVC</p>		○	<b>235.00</b>

● = Standard equipment. ○ = Optional at extra cost.

# CORSAVAN EQUIPMENT / OPTIONS

## DRIVER INFORMATION

	Corsavan	Sportive	Price (£) exc. VAT
<b>Instrumentation:</b> • Speedometer • Rev counter • Fuel gauge with low fuel warning light • Fuel economy gauge • Coolant temperature warning light	●	●	
<b>ECO features:</b> • Shift-up indicator – Indicates when to change gear for optimum fuel economy.	●	●	
<b>Driver information display:</b> • Monochrome display located in instrument cluster • Odometer • Service-due indicator	●	●	
<b>Central fascia display:</b> • Audio information • Digital clock with automatic RDS time adjustment • Outside air temperature with ice warning function • Additional features and location dependent on infotainment unit (see Infotainment for details)	●	●	
<b>Warning indicators:</b> • Low oil level, low brake fluid, brake pad wear, battery, seatbelt warning, doors open, headlight/brake light failure and handbrake on	●	●	

## INFOTAINMENT







<b>CD 30 BT:</b> <i>Onboard features:</i> • CD/MP3 CD player • DAB digital radio • AM/FM stereo radio with 36-station presets • RDS with Traffic Programme • Four speakers • 20 watts per channel output <i>Media connections:</i> • USB connection with iPod control • Aux-in socket <i>Mobile phone portal:</i> • Bluetooth® connectivity • Handsfree calls via steering wheel controls • Vehicle microphone • Phone book access – <i>Contacts/last calls/missed calls etc. (features dependent on mobile phone)</i>	●	●	
<b>R4.0 IntelliLink touchscreen infotainment system:</b> <i>Onboard features:</i> • DAB digital radio • AM/FM stereo radio with 36-station presets • 7-inch fascia-mounted colour touchscreen • RDS with Traffic Programme • Four speakers • 20 watts per channel output <i>Media connections:</i> • USB connection with iPod control • Bluetooth® audio streaming (A2DP Profile) <i>Mobile phone portal:</i> • Bluetooth® connectivity • Handsfree calls via steering wheel controls • Vehicle microphone • Phone book access – <i>Contacts/last calls / missed calls etc. are mirrored on the display and are easily navigated using the touchscreen (features dependent on mobile phone)</i>	○	○	<b>760.00</b>
<b>Additional features:</b> • Steering wheel mounted audio controls • Flexible roof-mounted aerial	●	●	

Option code:  
i0A/U91/U2Q

● = Standard equipment. ○ = Optional at extra cost.

# CORSAVAN EQUIPMENT / OPTIONS

## ONSTAR

		Corsavan	Sportive	Total (£) inc. VAT				
								
Automatic Crash Response	Wi-Fi Hotspot	Smartphone App	Stolen Vehicle Assistance	Vehicle Diagnostics				
<p><b>Vauxhall OnStar – your personal on board assistant*</b></p> <p><i>Many brands talk about innovation as soon as they improve their cup holders but this innovative system, now available on selected models**, is revolutionary: 24/7, 365 days a year, Vauxhall OnStar puts you in touch with a trained advisor, not a machine. With OnStar you have access to a host of innovations, from Vehicle Diagnostics and Smartphone Function to a fully integrated 4G Wi-Fi Hotspot†. In the event of an accident, Vauxhall OnStar even automatically calls for help, for an incomparable feeling of safety.</i></p> <p>* = Includes 12 months of OnStar services from date of first registration and a 3 month/3 GB Wi-Fi free trial period (whichever comes first) effective from the date the customer accepts the nominated network operator Wi-Fi T's&amp;C's. Does not include destination download feature. Theft alert feature only operates on models fitted with security alarm system.</p> <p>** = The OnStar Services require activation and are subject to mobile network coverage and availability. Wi-Fi Hotspot service requires account with nominated network operator.</p> <p>† = 4G is subject to mobile network coverage and availability. Charges apply after the free trial period. The OnStar subscription packages could be different from the services included in the free trial package. Check <a href="http://www.vauxhall.co.uk/onstar">www.vauxhall.co.uk/onstar</a> for terms and conditions, details of availability, coverage and charges.</p>					○	○	<b>360.00</b>	
								
					Option code: UE1			

○ = Optional at extra cost.



# CORSAVAN EQUIPMENT / OPTIONS

## HEATING AND VENTILATION

	Corsavan	Sportive	Price (£) exc. VAT
<b>Air blend heater:</b> • Four-speed fan • Illuminated controls • Four adjustable facia vents • Windscreen demist vents • Side window demist vents	●	●	
<b>Air conditioning:</b> • Air recirculation facility • Cabin particulate filter – <i>Removes dust, airborne particles and pollen</i> • Illuminated controls Option code: C60	○	●	435.00
<b>Electronic climate control:</b> • Incorporating air conditioning • Single-zone control • Six-speed fan • Advanced predictive logic control system using sun sensor • Cabin particulate filter • LCD temperature display • Automatic air direction and fan speed with manual override • Illuminated controls • Pollen filter – <i>On Corsavan, only in conjunction with air conditioning.</i> Option code: C68	○	○	360.00
<b>Winter Pack:</b> • Heated leather-covered steering wheel • Heated seats – <i>On Corsavan, only available in conjunction with cruise control.</i> Option code: OBL	○	○	205.00

## LOAD ACCESS

<b>Rear glazed tailgate:</b> • Heated rear window with wash/wipe facility • Interior tailgate handle	●	●	
---	---	---	--

## LOAD RESTRAINT / PROTECTION

<b>Load anchorage:</b> • Load restraint lashing eyes	●	●	
• Cargo net Option code: BNN	○	○	35.00
• Fixing points for cargo net Option code: V91	○	○	35.00
<b>Load lining:</b> • Half-height plastic side load lining panels	●	●	
<b>Bulkhead:</b> • Half-height steel bulkhead	●	●	
Load area rubber floor mat Option code: BG9	○	○	55.00
Upper load restraint mesh Option code: AP9	○	○	75.00
Load compartment cover Option code: B75	○	○	55.00
Illuminated load area	●	●	

● = Standard equipment. ○ = Optional at extra cost.

**Please note:** The air conditioning in vehicles with N1 type approval relies upon fluorinated greenhouse gases (R134a) for its functioning. The front system contains a quantity of overall 580g of R 134a, which corresponds to a CO<sub>2</sub> equivalent of 0.83 tons. The front and rear system contains a quantity of overall 890g of R 134a, which corresponds to a CO<sub>2</sub> equivalent of 1.27 tons. The global warming potential amounts to 1430. Information acc. to R (EU) No. 517/2014.

# CORSAVAN EQUIPMENT / OPTIONS

## EXTERIOR CONVENIENCE / STYLING

	Corsavan	Sportive	Price (£) exc. VAT
<b>Windows:</b>			
• Heated windscreen	○	●	100.00
• Electrically operated windows • Tinted windows • Heated rear window	●	●	
<b>Door mirrors:</b>			
• Foldable electrically adjustable door mirrors – <i>Heated on Sportive models.</i> • Wide-angle mirror on driver's side	●	●	
• Body colour door mirrors		●	

## EXTERIOR LIGHTING

<b>Standard lighting:</b>		
• Halogen headlights • Welcome lighting • Lights-on audible warning • Electric headlight beam levelling • Reversing lights • Hazard warning lights	●	●
• Rear fog light • Adaptive brake lights • High-level LED centre brake light • Side-repeat indicators • Daytime running lights – <i>LED on Sportive models.</i>		●
• Front fog lights – <i>With chrome-effect surround.</i>		●
Automatic lighting control		●

● = Standard equipment. ○ = Optional at extra cost.

# CORSAVAN EQUIPMENT / OPTIONS

<b>EXTERIOR COLOURS</b>			<b>Corsavan</b>	<b>Sportive</b>	<b>Price (£) exc. VAT</b>	
	<b>Summit White (GAZ)</b> • Solid paint		<b>Royal Blue (GEK)</b> • Solid paint	●	N/C	
	<b>Lava Red (GG7)</b> • Brilliant paint			○	N/C	<b>260.00</b>
	<b>Mineral Black (GB9)</b> • Two-coat metallic paint		<b>Satin Steel Grey (GF6)</b> • Two-coat metallic paint			
	<b>Sovereign Silver (GAN)</b> • Two-coat metallic paint		<b>Quantum Grey (GK3)</b> • Two-coat metallic paint	○	N/C	<b>390.00</b>
	<b>Dark Sea Blue (H07)</b> • Two-coat pearlescent paint					

● = Standard equipment. ○ = Optional at extra cost. N/C = No-cost option.

The colours reproduced may vary slightly from the actual paint colour. As a result they should be used as a guide only. Your Vauxhall Retailer has a comprehensive display of our paint samples.



# CORSAVAN EQUIPMENT / OPTIONS

## WHEELS AND TYRES

	Corsavan	Sportive	Price (£) exc. VAT
Full-size steel spare wheel	●		
Steel space-saver spare wheel		●	
 <b>14-inch steel wheels with flush covers – Petrol models:</b> <ul style="list-style-type: none"> <li>• 185/70 R 14 tyres</li> <li>• Full-size steel spare wheel</li> </ul>	●		
 <b>15-inch steel wheels with flush covers – Diesel models:</b> <ul style="list-style-type: none"> <li>• 185/65 R 15 tyres</li> <li>• Full-size steel spare wheel</li> </ul>	●		
 <b>16-inch alloy wheels:</b> <ul style="list-style-type: none"> <li>• 195/55 R 16 tyres</li> <li>• Steel space-saver spare wheel</li> </ul>		●	
 <b>16-inch black alloy wheels:</b> <ul style="list-style-type: none"> <li>• 195/55 R 16 tyres</li> <li>• Steel space-saver spare wheel</li> </ul>		○	110.00
Option code: RV5			

● = Standard equipment. ○ = Optional at extra cost.

## TYRE RATINGS

Tyre size	Fuel efficiency group	Wet grip performance	External noise	
			Measured (dB)	Group
185/70 R 14	B	B	70	
185/65 R 15	B-C	B	69-70	
195/55 R 16	B-C	B	68-71	

Tyre rating according to EU Regulation 1222/2009

# CORSAVAN EQUIPMENT / OPTIONS

## MECHANICAL

	Corsavan	Sportive	Price (£) exc. VAT	
<b>Standard features:</b> • Front-wheel drive • Transverse engine / gearbox • Gas-pressure dampers • Front anti-roll bar	●	●		
<b>Transmissions:</b> • Five-speed manual gearbox	●			
• Six-speed manual gearbox		●		
• Five-speed Easytronic transmission <i>- Available on 1.3CDTi (95PS) ecoFLEX models</i>	○			See prices page
<b>Steering:</b> • Speed-sensitive electrically assisted power steering – <i>Variable rate on diesel models.</i> • Rack and pinion • City-mode button providing lighter steering at parking speeds – <i>Deleted if Driving Assistance Pack is specified.</i>	●	●		
<b>Turning circle:</b> <b>Kerb-to-kerb</b> All models                      10.6m (34.8ft.)				
<b>Brakes:</b> <i>Front ventilated disc brakes:</i> • 257mm diameter (1.2i models) • 284mm diameter (1.3CDTi models) <i>Rear drum brakes:</i> • 228mm diameter (all models)	●	●		
<b>Fuel tank:</b> • 45 litres (9.9 gallons) capacity	●	●		
<b>Electrical:</b> <i>Maintenance-free battery:</i> • 40Ah (1.2i models) • 60Ah (1.3CDTi models) <i>Alternator:</i> • 130A (1.2i models) • 140A (1.3CDTi models)	●	●		
<b>Front suspension:</b> • Independent lightweight MacPherson struts • Coil springs • Telescopic gas-pressure dampers	●	●		
<b>Rear suspension:</b> • Compound crank • Coil springs • Gas pressure dampers	●	●		

● = Standard equipment. ○ = Optional at extra cost.

# COMBO PANEL VAN PRICES

**BEST SMALL TRADES VAN**  
Vauxhall Combo 1.3CDTi  
2300LH1 95ps Eu6  
ecoFlex S/Stop



Model	Minimum Mass (kg)*	Payload (kg)*	Fuel economy mpg (litres/100km)#			CO <sub>2</sub> emissions (g/km)#	Price (£) exc. VAT	On-the-road RRP (£) exc. VAT
			Urban driving	Extra-urban driving	Combined figure			
<b>L1 H1 PANEL VAN (EURO 6)</b>								
2000 1.4i (95PS) Start/Stop	1355	740	30.7 (9.2)	49.6 (5.7)	40.4 (7.0)	163	14340.00	<b>15218.33</b>
2000 1.3CDTi (95PS)	1365	740	43.5 (6.5)	67.3 (4.2)	56.5 (5.0)	133	15625.00	<b>16503.33</b>
2000 1.3CDTi (95PS) Start/Stop ecoFLEX	1365	740	52.3 (5.4)	68.9 (4.1)	61.4 (4.6)	120	15910.00	<b>16788.33</b>
2000 1.6CDTi (105PS)	1395	768	44.8 (6.3)	64.2 (4.4)	55.4 (5.1)	134	16615.00	<b>17493.33</b>
2000 1.6CDTi (105PS) Start/Stop	1395	768	53.3 (5.3)	68.9 (4.1)	62.8 (4.5)	120	16900.00	<b>17778.33</b>
2300 1.3CDTi (95PS)	1395	990	43.5 (6.5)	67.3 (4.2)	56.5 (5.0)	133	15820.00	<b>16698.33</b>
2300 1.3CDTi (95PS) Start/Stop ecoFLEX	1395	990	52.3 (5.4)	68.9 (4.1)	61.4 (4.6)	120	16105.00	<b>16983.33</b>
2300 1.6CDTi (105PS)	1465	1018	43.5 (6.5)	64.2 (4.4)	54.3 (5.2)	135	16810.00	<b>17688.33</b>
2300 1.6CDTi (105PS) Start/Stop	1465	1018	53.3 (5.3)	67.3 (4.2)	61.4 (4.6)	121	17095.00	<b>17973.33</b>
<b>L1 H1 SPORTIVE PANEL VAN (EURO 6)</b>								
2000 1.3CDTi (95PS)	1365	695	43.5 (6.5)	67.3 (4.2)	56.5 (5.0)	133	16895.00	<b>17773.33</b>
2000 1.3CDTi (95PS) Start/Stop ecoFLEX	1365	695	52.3 (5.4)	68.9 (4.1)	61.4 (4.6)	120	17180.00	<b>18058.33</b>
2000 1.6CDTi (105PS) Start/Stop	1395	723	53.3 (5.3)	68.9 (4.1)	62.8 (4.5)	120	18170.00	<b>19048.33</b>
2300 1.3CDTi (95PS)	1395	945	43.5 (6.5)	67.3 (4.2)	56.5 (5.0)	133	17090.00	<b>17968.33</b>
2300 1.3CDTi (95PS) Start/Stop ecoFLEX	1395	945	52.3 (5.4)	68.9 (4.1)	61.4 (4.6)	120	17375.00	<b>18253.33</b>
2300 1.6CDTi (105PS) Start/Stop	1465	973	53.3 (5.3)	67.3 (4.2)	61.4 (4.6)	121	18365.00	<b>19243.33</b>
<b>L1 H2 PANEL VAN (EURO 6)</b>								
2000 1.6CDTi (105PS) Start/Stop	1445	740	53.3 (5.3)	60.1 (4.7)	57.6 (4.9)	131	17650.00	<b>18528.33</b>
2300 1.6CDTi (105PS) Start/Stop	1475	1018	53.3 (5.3)	60.1 (4.7)	57.6 (4.9)	131	17845.00	<b>18723.33</b>
<b>L1 H2 SPORTIVE PANEL VAN (EURO 6)</b>								
2000 1.6CDTi (105PS) Start/Stop	1445	695	53.3 (5.3)	60.1 (4.7)	57.6 (4.9)	131	18920.00	<b>19798.33</b>
2300 1.6CDTi (105PS) Start/Stop	1475	973	53.3 (5.3)	60.1 (4.7)	57.6 (4.9)	131	19115.00	<b>19993.33</b>

**Please note:** On-the-road recommended retail prices (RRP) include number plates and delivery to Retailer of £583.33 (exc. VAT), 12 months' Vehicle Excise Duty at £240.00 and new vehicle first registration fee of £55.00. Excludes fuel and insurance.

\* = For definitions please refer to Glossary of Terms.

# = Fuel consumption information is official government environmental data, tested in accordance with the relevant EU directive. Official EU-regulated test data is provided for comparison purposes and actual performance will depend on driving style, road conditions and other non-technical factors.

# COMBO PANEL VAN PRICES

**BEST SMALL TRADES VAN**  
Vauxhall Combo 1.3CDTi  
2300LH1 95ps Eu6  
ecoFlex S/Stop



Model	Minimum Mass (kg)*	Payload (kg)*	Fuel economy mpg (litres/100km)#			CO <sub>2</sub> emissions (g/km)#	Price (£) exc. VAT	On-the-road RRP (£) exc. VAT
			Urban driving	Extra-urban driving	Combined figure			
<b>L2 H1 PANEL VAN (EURO 6)</b>								
2300 1.4i (95PS) Start/Stop	1360	920	30.7 (9.2)	49.6 (5.7)	40.4 (7.0)	163	15340.00	<b>16218.33</b>
2300 1.3CDTi (95PS)	1460	990	42.8 (6.6)	65.7 (4.3)	55.4 (5.1)	136	16625.00	<b>17503.33</b>
2300 1.3CDTi (95PS) Start/Stop ecoFLEX	1460	990	51.4 (5.5)	67.3 (4.2)	60.1 (4.7)	123	16910.00	<b>17788.33</b>
2300 1.6CDTi (105PS)	1505	1018	43.5 (6.5)	64.2 (4.4)	54.3 (5.2)	135	17615.00	<b>18493.33</b>
2300 1.6CDTi (105PS) Start/Stop	1505	1018	53.3 (5.3)	67.3 (4.2)	61.4 (4.6)	121	17900.00	<b>18778.33</b>
<b>L2 H1 SPORTIVE PANEL VAN (EURO 6)</b>								
2300 1.3CDTi (95PS)	1460	960	42.8 (6.6)	65.7 (4.3)	55.4 (5.1)	136	17710.00	<b>18588.33</b>
2300 1.3CDTi (95PS) Start/Stop ecoFLEX	1460	960	51.4 (5.5)	67.3 (4.2)	60.1 (4.7)	123	17995.00	<b>18873.33</b>
2300 1.6CDTi (105PS) Start/Stop	1505	988	53.3 (5.3)	67.3 (4.2)	61.4 (4.6)	121	18985.00	<b>19863.33</b>
<b>L2 H2 PANEL VAN (EURO 6)</b>								
2300 1.6CDTi (105PS) Start/Stop	1535	1018	50.4 (5.6)	60.1 (4.7)	56.5 (5.0)	133	18900.00	<b>19778.33</b>

**Please note:** On-the-road recommended retail prices (RRP) include number plates and delivery to Retailer of £583.33 (exc. VAT), 12 months' Vehicle Excise Duty at £240.00 and new vehicle first registration fee of £55.00. Excludes fuel and insurance.

\* = For definitions please refer to Glossary of Terms.

# = Fuel consumption information is official government environmental data, tested in accordance with the relevant EU directive. Official EU-regulated test data is provided for comparison purposes and actual performance will depend on driving style, road conditions and other non-technical factors.

# COMBO CREW VAN PRICES

**BEST SMALL TRADES VAN**  
Vauxhall Combo 1.3CDTi  
2300LH1 95ps Eu6  
ecoFlex S/Stop



Model	Minimum Mass (kg)*	Payload (kg)*	Fuel economy mpg (litres/100km)#			CO <sub>2</sub> emissions (g/km)#	Price (£) exc. VAT	On-the-road RRP (£) exc. VAT
			Urban driving	Extra-urban driving	Combined figure			
<b>L1 H1 CREW VAN (EURO 6)</b>								
2300 1.3CDTi (95PS)	1485	804	42.8 (6.6)	65.7 (4.3)	55.4 (5.1)	136	16620.00	<b>17498.33</b>
2300 1.3CDTi (95PS) Start/Stop ecoFLEX	1485	804	51.4 (5.5)	67.3 (4.2)	60.1 (4.7)	123	16905.00	<b>17783.33</b>
2300 1.6CDTi (105PS)	1505	804	44.1 (6.4)	62.8 (4.5)	54.3 (5.2)	136	17610.00	<b>18488.33</b>
2300 1.6CDTi (105PS) Start/Stop	1505	804	54.3 (5.2)	65.7 (4.3)	61.4 (4.6)	122	17895.00	<b>18773.33</b>
<b>L1 H1 SPORTIVE CREW VAN (EURO 6)</b>								
2300 1.3CDTi (95PS)	1485	784	42.8 (6.6)	65.7 (4.3)	55.4 (5.1)	136	17705.00	<b>18583.33</b>
2300 1.3CDTi (95PS) Start/Stop ecoFLEX	1485	784	51.4 (5.5)	67.3 (4.2)	60.1 (4.7)	123	17990.00	<b>18868.33</b>
2300 1.6CDTi (105PS) Start/Stop	1505	784	54.3 (5.2)	65.7 (4.3)	61.4 (4.6)	122	18980.00	<b>19858.33</b>
<b>L2 H1 CREW VAN (EURO 6)</b>								
2300 1.3CDTi (95PS)	1505	804	42.8 (6.6)	65.7 (4.3)	55.4 (5.1)	136	17425.00	<b>18303.33</b>
2300 1.3CDTi (95PS) Start/Stop ecoFLEX	1505	804	51.4 (5.5)	67.3 (4.2)	60.1 (4.7)	123	17710.00	<b>18588.33</b>
2300 1.6CDTi (105PS)	1600	804	43.5 (6.5)	61.4 (4.6)	53.3 (5.3)	139	18415.00	<b>19293.33</b>
2300 1.6CDTi (105PS) Start/Stop	1600	804	53.3 (5.3)	64.2 (4.4)	60.1 (4.7)	125	18700.00	<b>19578.33</b>
<b>L2 H1 SPORTIVE CREW VAN (EURO 6)</b>								
2300 1.3CDTi (95PS)	1505	784	42.8 (6.6)	65.7 (4.3)	55.4 (5.1)	136	18510.00	<b>19388.33</b>
2300 1.3CDTi (95PS) Start/Stop ecoFLEX	1505	784	51.4 (5.5)	67.3 (4.2)	60.1 (4.7)	123	18795.00	<b>19673.33</b>
2300 1.6CDTi (105PS) Start/Stop	1600	784	53.3 (5.3)	64.2 (4.4)	60.1 (4.7)	125	19785.00	<b>20663.33</b>

Model	Minimum Mass (kg)*	Payload (kg)*	Fuel economy mpg (litres/100km)#			CO <sub>2</sub> emissions (g/km)#	Price (£) exc. VAT	On-the-road RRP (£) inc. VAT
			Urban driving	Extra-urban driving	Combined figure			
<b>L1 H1 GLAZED CREW VAN (EURO 6)</b>								
2300 1.3CDTi (95PS)	1485	764	42.8 (6.6)	65.7 (4.3)	55.4 (5.1)	136	16820.00	<b>21179.00</b>
2300 1.3CDTi (95PS) Start/Stop ecoFLEX	1485	764	51.4 (5.5)	67.3 (4.2)	60.1 (4.7)	123	17105.00	<b>21521.00</b>
2300 1.6CDTi (105PS) Start/Stop	1505	764	54.3 (5.2)	65.7 (4.3)	61.4 (4.6)	122	18095.00	<b>22709.00</b>
<b>L2 H1 GLAZED CREW VAN (EURO 6)</b>								
2300 1.3CDTi (95PS)	1505	764	42.8 (6.6)	65.7 (4.3)	55.4 (5.1)	136	17625.00	<b>22145.00</b>
2300 1.3CDTi (95PS) Start/Stop ecoFLEX	1505	764	51.4 (5.5)	67.3 (4.2)	60.1 (4.7)	123	17910.00	<b>22487.00</b>
2300 1.6CDTi (105PS) Start/Stop	1600	764	53.3 (5.3)	64.2 (4.4)	60.1 (4.7)	125	18900.00	<b>23675.00</b>

**Please note:** On-the-road recommended retail prices (RRP) include number plates and delivery to Retailer of £583.33 (exc. VAT), 12 months' Vehicle Excise Duty at £240.00 and new vehicle first registration fee of £55.00. Excludes fuel and insurance.

\* = For definitions please refer to Glossary of Terms.

# = Fuel consumption information is official government environmental data, tested in accordance with the relevant EU directive. Official EU-regulated test data is provided for comparison purposes and actual performance will depend on driving style, road conditions and other non-technical factors.



# COMBO COLORADO PRICES

Model	Minimum Mass (kg)*	Payload (kg)*	Fuel economy mpg (litres/100km)#			CO <sub>2</sub> emissions (g/km)#	Price (£) exc. VAT	On-the-road RRP (£) inc. VAT
			Urban driving	Extra-urban driving	Combined figure			
<b>L2 H1 COLORADO CREW VAN (EURO 6)</b>								
2300 1.3CDTi (95PS)	1505	814	42.8 (6.6)	65.7 (4.3)	55.4 (5.1)	136	18710.00	<b>23447.00</b>

**Please note:** On-the-road recommended retail prices (RRP) include number plates and delivery to Retailer of £583.33 (exc. VAT), 12 months' Vehicle Excise Duty at £240.00 and new vehicle first registration fee of £55.00. Excludes fuel and insurance.

\* = For definitions please refer to Glossary of Terms.

# = Fuel consumption information is official government environmental data, tested in accordance with the relevant EU directive. Official EU-regulated test data is provided for comparison purposes and actual performance will depend on driving style, road conditions and other non-technical factors.

The Combo Colorado is a fully glazed crew van without bulkhead suitable for conversion into a wheelchair accessible vehicle by a third-party Converter. The Colorado includes basic Type Approval for registration as a Category N\* Commercial Vehicle and 2nd stage Type Approval must be completed by the Converter to enable registration. Available as an L2 H1 the Colorado is fitted with the highly efficient and economical 1.3CDTi (95PS) engine and includes second-row seats and interior trim.

**Feature highlights:**

- Type-approved for Euro 6 Category N\* emissions
- Glazed between C- and D-pillars
- Air conditioning
- Two-coat metallic/Brilliant paint
- Body-coloured mirrors and bumpers
- Height-adjustable driver's seat with armrest and lumbar support
- Nearside and offside side-access doors with sliding windows
- Glazed tailgate with wash/wipe facility

\* = As a Category N Commercial Vehicle, the Colorado is subject to speed restrictions not applicable to a Passenger Vehicle. Please consult the DVSA website for further details.

# COMBO COLORADO OPTIONS

	Colorado	Price (£) exc. VAT
<b>OPTION PACKS</b>		
<b>Driver Pack:</b> • CD/MP3 CD player / stereo radio / Bluetooth® connectivity for compatible mobile phones / aux-in socket / USB connectivity / AM/FM stereo radio with 24 station presets / RDS with Traffic Programme / steering wheel mounted audio controls • Leather-covered steering wheel • Leather-covered gear knob • Pre-installation for TomTom navigation system – <i>Excludes sat nav / cradle. Accessory sat nav and bespoke cradle combination available at extra cost.</i>	○	<b>670.00</b>
	Option code: LPW1	
<b>Smoker Pack:</b> • Removable ashtray • Illuminated cigar lighter	○	<b>55.00</b>
	Option code: DT4	
<b>SAFETY AND SECURITY</b>		
Front passenger's airbag with deactivation switch	○	<b>235.00</b>
	Option code: AK5	
Front passenger's airbag with driver and front passenger's side-impact airbags	○	<b>385.00</b>
	Option code: AJ7	
Active-safety head restraints – <i>Front seats only.</i>	○	<b>45.00</b>
	Option code: AJF	
Alarm pre-installation kit – <i>Accessory alarm available at extra cost.</i>	○	<b>60.00</b>
	Option code: TJD	
Third key	○	<b>60.00</b>
	Option code: KTN	
<b>INTERIOR</b>		
Electronic climate control incorporating air conditioning – <i>Mandates electrically adjustable/heated door mirrors with exterior temperature sensor at extra cost.</i>	○	<b>840.00</b>
	Option code: C68	
Cruise control	○	<b>185.00</b>
	Option code: K34	
<b>CD 50 multimedia:</b> <i>Onboard features:</i> • CD/MP3 CD player • AM/FM stereo radio with 24-station presets • RDS with Traffic Programme • Four speakers • 20 watts per channel output • Steering wheel mounted audio controls <i>Media connections:</i> • USB connection • Aux-in socket <i>Mobile phone portal:</i> • Bluetooth® connectivity • Vehicle microphone	○	<b>495.00</b>
	Option code: UGi	
<b>EXTERIOR</b>		
Front fog lights	○	<b>115.00</b>
	Option code: T3U	
Electrically adjustable/heated door mirrors	○	<b>135.00</b>
	Option code: DL8	
Electrically adjustable/heated door mirrors with exterior temperature sensor	○	<b>195.00</b>
	Option code: UGM	
Glazed asymmetric rear doors – 90°/180° opening	○	<b>155.00</b>
	Option code: J1X	
Rear parking distance sensors	○	<b>205.00</b>
	Option code: UD7	
Brilliant paint (Tomato Red)	N/C	<b>No-cost</b>
	Option code: G6Z	
Two-coat metallic paint – <i>Please see Combo exterior colours.</i>	N/C	<b>No-cost</b>
<b>MECHANICAL</b>		
Uprated alternator	○	<b>55.00</b>
	Option code: KX3	
<b>WHEELS AND TYRES</b>		
16-inch steel wheels with full-diameter wheel trims and 195/60 R 16 tyres	●	
Full-size spare wheel (in lieu of tyre inflation kit)	N/C	<b>No-cost</b>
	Option code: QQ5	

● = Standard equipment. ○ = Optional at extra cost. N/C = No-cost option.

**Please note:** The air conditioning in vehicles with N1 type approval relies upon fluorinated greenhouse gases (R134a) for its functioning. It contains a quantity of overall 450g of R 134a, which corresponds to a CO<sub>2</sub> equivalent of 0.64 tons. The global warming potential amounts to 1430. Information acc. to R (EU) No. 517/2014.

# COMBO EQUIPMENT / OPTIONS

## SAFETY

	Combo	Sportive	Price (£) exc. VAT
<b>Airbags:</b>	●	●	
• Driver's dual-stage airbag			
• Front passenger's airbag with deactivation switch	○	○	235.00
Option code: AK5			
• Front passenger's airbag with deactivation switch • Driver and front passenger's side-impact airbags	○	○	385.00
Option code: AJ7			
<b>Seating:</b>	●	●	
• Height-adjustable head restraints			
• Active safety head restraints – <i>Front seats only.</i>	○	○	45.00
Option code: AJF			
<b>Seatbelts:</b>	●	●	
• Inertia-reel lap and diagonal seatbelts • Height-adjustable front seatbelts • Seatbelt pretensioner system – <i>Pretensioners tighten the seatbelt in the event of an accident limiting forward movement.</i> • Front seatbelt force limiters – <i>Reduces potential upper body injuries during a frontal impact.</i> • Seatbelt unfastened audible warning and warning light			
<b>Body:</b>	●	●	
• Laminated windscreen • Side-impact protection beams • Reinforced passenger safety cell • Fuel tank located ahead of rear axle			
<b>Stability:</b>	●	●	
<i>Electronic Stability Programme-plus (ESP-plus) with traction control – Works in conjunction with the vehicle's electronic braking and engine systems to keep the vehicle stable in many different situations. ESP monitors a variety of inputs to determine when the vehicle starts to lose traction, it can then immediately respond by varying the brake pressure between up to three wheels and adjust the engine output to help correct the loss of traction and improve stability.</i>			
<i>Drag torque control – Helps maintain stability when suddenly lifting off the accelerator.</i>			
<b>Anti-lock braking:</b>	●	●	
<i>Four-channel Anti-lock Braking System (ABS) – Prevents the vehicle's wheels from locking up under heavy braking by momentarily reducing brake pressure at the appropriate wheel, ensuring that you can maintain control of the steering.</i>			
<i>Emergency brake assist – When emergency braking is detected the vehicle automatically applies the maximum possible braking assistance.</i>			
<i>Electronic brakeforce distribution – Automatically apportions the optimum braking force to each wheel.</i>			
<i>Hill start assist – Briefly maintains rear brake pressure to stop the vehicle rolling back on an incline.</i>			
<b>Fire protection system:</b>	●	●	
• Fire protection system • Fuel cut-off			

## SECURITY

<b>Features:</b>	●	●	
• Electronic engine deadlock immobiliser • Steering column lock • Electronic theft protection for audio equipment • 'Key left in ignition' audible warning			
• Lockable glovebox • Lockable fuel filler cap			
<b>Remote control door locking (doors, tailgate and fuel flap):</b>	●	●	
• Remote control door locking • Two folding keys with integral remote • Door deadlocks			
• Alarm pre-installation kit – <i>Accessory alarm available at extra cost.</i>	○	○	60.00
Option code: TJD			
• Third key	○	○	60.00
Option code: KTN			
• Third key with remote control – <i>Panel Vans only.</i>	○	○	85.00
Option code: Z1V			

● = Standard equipment. ○ = Optional at extra cost.

# COMBO EQUIPMENT / OPTIONS

## COMFORT AND SEATING

	Combo	Sportive	Price (£) exc. VAT
<b>Comfort:</b> • Steering column adjustable for reach and rake • Floor-mounted handbrake lever • Cube cloth seat trim • Height-adjustable front seatbelts	●	●	
<b>Seating – Panel Van:</b> • Reach • Backrest recline	●	●	
• Driver's seat height adjuster • Armrest • Lumbar support – <i>Not available with vinyl seat trim.</i>	○	●	Option code: DCW 75.00
• Front passenger's seat with under cushion storage compartment – <i>Panel Van only. Not available with vinyl seat trim.</i>	○	○	Option code: BA8 35.00
<b>Rear seating – Crew Van:</b> • Three passenger rear seat • 'Fold and tumble' facility • 60/40 split seat back and cushion	●	●	
<b>Vinyl seat trim:</b> • Black vinyl seat trim – <i>Base models only. Not available with driver's seat height adjuster or front passenger's seat with under cushion storage compartment.</i>	○		Option code: TAiB 60.00

## INTERIOR CONVENIENCE

<b>Accessory sockets:</b> • Facia-mounted 12-volt accessory socket	●	●	
<b>Interior:</b> • Storage compartment on driver's side facia • Illuminated glovebox with lid • Door storage pockets • Dipping rear-view mirror – <i>When glazed bulkhead and glazed rear doors / tailgate are specified.</i> • Twin sunvisors, front passenger's with vanity mirror • Driver and front passenger's tiltable assist handles • Two coat hooks • Door armrests	●	●	
• Overhead shelf – <i>Standard on H2, Crew Van and Colorado models.</i>	○	●	Option code: VVM 40.00
• Rear side panel storage (fully trimmed L1, part trimmed L2) and 12-volt accessory socket – <i>Crew Van /Colorado models</i>	●	●	
<b>Lighting:</b> • Centre fade up/fade down courtesy light • Illuminated load area	●	●	
<b>Load Compartment Pack:</b> • Overhead shelf • PVC load floor covering • 12-volt accessory socket in load area • Removable load area courtesy light – <i>Panel Van only.</i>	○		Option code: LPVX 130.00
<b>Smoker Pack:</b> • Removable ashtray • Illuminated cigar lighter	○	○	Option code: DT4 55.00

## DRIVER ASSISTANCE

<b>Multi-function trip computer:</b> • Overall distance • Trip distance • Average fuel consumption • Instantaneous fuel consumption • Vehicle range based on remaining fuel • Distance and average speed since last reset	●	●	
<b>Windscreen wipers:</b> • Two-speed windscreen wipers • Variable intermittent wipe • Electric screenwash	●	●	
<b>Parking assistance:</b> • Rear parking distance sensors • Audible warning • Distance warning graphic shown in driver information display	○	○	Option code: UD7 205.00
Cruise control	○	○	Option code: K34 185.00

● = Standard equipment. ○ = Optional at extra cost.

# COMBO EQUIPMENT / OPTIONS

## DRIVER INFORMATION

	Combo	Sportive	Price (£) exc. VAT
<b>Instrumentation:</b> • Speedometer • Rev counter • Trip odometer • Fuel gauge with low fuel warning light • Coolant temperature warning light	●	●	
<b>ECO features:</b> • Shift-up indicator – Indicates when to change gear for optimum fuel economy.	●	●	
<b>Driver information display:</b> • Monochrome display located in instrument cluster • Odometer • Service-due indicator	●	●	
<b>Central fascia display:</b> • Audio information • Digital clock with automatic RDS time adjustment • Outside air temperature with ice warning function • Additional features and location dependent on infotainment unit (see Infotainment for details)	●	●	
<b>Warning indicators:</b> • Low oil level, low brake fluid, brake pad wear, battery, seatbelt reminder, airbag failure / deactivation, charging system and emission control system failure	●	●	
<b>Driver Pack:</b> • CD/MP3 CD player / stereo radio / Bluetooth® connectivity for compatible mobile phones / aux-in socket / USB connectivity / AM/FM stereo radio with 24 station presets / RDS with Traffic Programme / steering wheel mounted audio controls • Leather-covered steering wheel • Leather-covered gear knob • Pre-installation for TomTom navigation system – Excludes sat nav / cradle. Accessory sat nav and bespoke cradle combination available at extra cost. Option code: LPW1	○	○	670.00

## INFOTAINMENT

<b>CD player / stereo radio:</b> <i>Onboard features:</i> • CD player • AM/FM stereo radio with 24-station presets • RDS with Traffic Programme • Four speakers • 20 watts per channel output	●	●	
<b>CD 50 multimedia:</b> <i>Onboard features:</i> • CD/MP3 CD player • AM/FM stereo radio with 24-station presets • RDS with Traffic Programme • Four speakers • 20 watts per channel output • Steering wheel mounted audio controls <i>Media connections:</i> • USB connection • Aux-in socket <i>Mobile phone portal:</i> • Bluetooth® connectivity • Vehicle microphone Option code: UGi	○	○	495.00
<b>Additional features:</b> • Flexible roof-mounted aerial	●	●	

● = Standard equipment. ○ = Optional at extra cost.

# COMBO EQUIPMENT / OPTIONS

## HEATING AND VENTILATION

	Combo	Sportive	Price (£) exc. VAT
<b>Air blend heater:</b> • Four-speed fan • Illuminated controls • Four adjustable facia vents • Windscreen demist vents • Side window demist vents	●	●	
<b>Air conditioning:</b> • Air recirculation facility • Cabin particulate filter – <i>Removes dust, airborne particles and pollen.</i> • Illuminated controls – <i>Standard on Colorado models.</i>	○	●	600.00 Option code: C60
<b>Electronic climate control:</b> • Incorporating air conditioning • Single-zone control • Six-speed fan • Advanced predictive logic control system using sun sensor • Cabin particulate filter • LCD temperature display • Automatic air direction and fan speed with manual override • Illuminated controls • Pollen filter – <i>Mandates electrically adjustable / heated door mirrors with exterior temperature sensor at extra cost.</i>		○	840.00 Option code: C68

## SIDE ACCESS

<b>Nearside access:</b> • Nearside sliding side-access door • Unglazed – <i>Standard on L2 H1 models.</i>	▲	●	255.00
<b>Offside access:</b> • Offside sliding side-access door • Unglazed – <i>Standard on L2 H1 models.</i>		▲	200.00
<b>Nearside and offside access:</b> <i>Side-access doors:</i> • Nearside sliding side-access door • Unglazed • Offside sliding side-access door • Unglazed – <i>Standard on L2 and Crew Van models.</i>	▲		445.00
<i>Side-access panel / doors with fixed windows:</i> • Glazed nearside sliding side-access door • Glazed offside sliding side-access panel / door – <i>Standard on Glazed Crew Van.</i>	▲	▲	300.00
<i>Side-access doors with sliding windows:</i> • Sliding windows to nearside sliding side-access door • Sliding window to offside sliding side-access door – <i>Standard on Glazed Crew Van / Colorado models.</i>	●		

## REAR ACCESS

<b>Rear doors:</b> • Asymmetric rear doors • Unglazed • 90°/180° opening – <i>Not available on Glazed Crew Van / Colorado models.</i>	●	●	
• Asymmetric rear doors • Glazed • 90°/180° opening • Heated windows • Wash/wipe facility – <i>Only available when bulkhead with window is specified. Not available on non-glazed Crew Van.</i>	○	○	155.00 Option code: J1X
<b>Tailgate:</b> • Glazed • Heated window • Wash/wipe facility – <i>H1 models only.</i> – <i>Only available when bulkhead with window is specified. Standard on Glazed Crew Van / Colorado models.</i>	○	○	135.00 Option code: JIU

● = Standard equipment. ○ = Optional at extra cost. ▲ = Please refer to ordering guide.

**Please note:** The air conditioning in vehicles with N1 type approval relies upon fluorinated greenhouse gases (R134a) for its functioning. The front system contains a quantity of overall 580g of R 134a, which corresponds to a CO<sub>2</sub> equivalent of 0.83 tons. The front and rear system contains a quantity of overall 890g of R 134a, which corresponds to a CO<sub>2</sub> equivalent of 1.27 tons. The global warming potential amounts to 1430. Information acc. to R (EU) No. 517/2014.

# COMBO EQUIPMENT / OPTIONS

## LOAD RESTRAINT / PROTECTION

	Combo	Sportive	Price (£) exc. VAT
<b>Load anchorage:</b> • Load restraint lashing eyes – <i>Panel Van -6, Crew Van / Colorado -4.</i>	●	●	
<b>Bulkhead:</b> • Full-height steel bulkhead – <i>Soundproofed on Sportive models. Not available on Crew Van / Colorado models.</i>	●	●	
• Full-height steel bulkhead with window – <i>Only available when glazed rear doors / tailgate are specified. Not available on Crew Van / Colorado models.</i>	○	○	60.00
Option code: AX9			
• Protective ladder frame behind driver – <i>Base Panel Van only. In lieu of full-height steel bulkhead. Only available when Load Compartment Pack is specified.</i>	N/C		No-cost
• Full-width ladder frame bulkhead behind second-row seats – <i>Crew Vans only.</i>	N/C	N/C	No-cost
PVC load floor covering – <i>Not available on Crew Van / Colorado models.</i>	○	●	45.00
Option code: VT9			
Carpeted load floor covering – <i>Crew Van / Colorado models.</i>	●	●	
Internal ladder storage bars – <i>Panel Van only. Not available with Load Compartment Pack or rear roof flap.</i>	○	○	165.00
Option code: SOW			

## EXTERIOR CONVENIENCE / STYLING

Body side-protection mouldings	●	●	
Body colour door mirrors and bumpers		●	
<b>Windows:</b> • Electrically operated front windows • Tinted windows	●	●	
<b>Door mirrors:</b> • Foldable door mirrors • Wide-angle mirror on driver's side	●	●	
• Electrically adjustable / heated door mirrors	○	○	135.00
Option code: DL8			
• Electrically adjustable / heated door mirrors • Exterior temperature sensor	○	○	195.00
Option code: UGM			
<b>Winter Pack:</b> • Headlight washers • Front fog lights • Exterior temperature sensor • Electrically adjustable / heated door mirrors		○	265.00
Option code: LPW0			
Roof rails – <i>H1 Panel Van models only. Not available when the rear roof flap is specified.</i>	○	○	135.00
Option code: E2R			
Rear roof flap – <i>L1 H1 Panel Van models only. Only available when Load Compartment Pack is specified. Not available when roof rails or glazed tailgate options are specified</i>	○	○	410.00
Option code: AD3			









## EXTERIOR LIGHTING

<b>Standard lighting:</b> • Halogen headlights • Daytime running lights • Lights-on audible warning • Electric headlight beam levelling • Reversing light • Hazard warning lights • Rear fog light • High-level LED centre brake light • Side-repeat indicators • Front fog lights	●	●	
Option code: T3U	○	○	115.00

● = Standard equipment. ○ = Optional at extra cost. N/C = No-cost option.

# COMBO EQUIPMENT / OPTIONS

## EXTERIOR COLOURS

		Combo	Sportive	Colorado	Price (£) exc. VAT		
	<b>Polar White (5PU)</b> • Solid paint		<b>Deep Blue (4DU)</b> • Solid paint	●	●	●	
	<b>Tomato Red (G6Z)</b> • Brilliant paint			○	N/C	N/C	260.00
	<b>Magnetic Silver (20U)</b> • Two-coat metallic paint		<b>Ruby Red (4VU)</b> • Two-coat metallic paint				
	<b>Twilight Blue (GTG)</b> • Two-coat metallic paint		<b>Marine Blue (4EU)</b> • Two-coat metallic paint	○	N/C	N/C	390.00
	<b>Midnight Black (3AU)</b> • Two-coat metallic paint		<b>Pepperdust (GJM)</b> • Two-coat metallic paint				

● = Standard equipment. ○ = Optional at extra cost. N/C = No-cost option.

The colours reproduced may vary slightly from the actual paint colour. As a result they should be used as a guide only. Your Vauxhall Retailer has a comprehensive display of our paint samples.



# COMBO EQUIPMENT / OPTIONS

## WHEELS AND TYRES

		Combo	Sportive	Price (£) exc. VAT
	<b>15-inch steel wheels with centre covers – 2000 models (excluding 1.4i).</b> <ul style="list-style-type: none"> <li>• 185/65 R 15 tyres</li> <li>• Tyre inflation kit</li> </ul>	●		
	<b>15-inch steel wheels with full-diameter wheel trims – 2000 models.</b> <ul style="list-style-type: none"> <li>• 185/65 R 15 tyres</li> <li>• Tyre inflation kit</li> </ul>		●	
	<b>16-inch steel wheels with centre covers – 2300 and 1.4i models.</b> <ul style="list-style-type: none"> <li>• 195/65 R 16 tyres</li> <li>• Tyre inflation kit</li> </ul>	●		
	<b>16-inch steel wheels with full-diameter wheel trims – 2300 models.</b> <ul style="list-style-type: none"> <li>• 195/60 R 16 tyres</li> <li>• Tyre inflation kit</li> </ul>		●	
	<b>16-inch alloy wheels</b> <ul style="list-style-type: none"> <li>• 195/60 R 16 tyres</li> <li>• Tyre inflation kit</li> <li>• Locking wheel bolts</li> </ul>		○	405.00
				Option code: NWQ
<b>Winter tyres – Goodyear Ultragrip-7:</b> <ul style="list-style-type: none"> <li>• 195/65 R 15 – 2000 models.</li> <li>• 195/60 R 16 – 2300 models.</li> </ul>		○	○	235.00
Full-size spare wheel in lieu of tyre inflation kit		Option code: PHM		
		Option code: QQ5	N/C	N/C
				No-cost

● = Standard equipment. ○ = Optional at extra cost. N/C = No-cost option.

# COMBO EQUIPMENT / OPTIONS

## MECHANICAL

	Combo	Sportive	Price (£) exc. VAT
<b>Standard features:</b>	●	●	
• Front-wheel drive • Transverse engine / gearbox			
<b>Transmissions:</b>	●	●	
• Five-speed manual gearbox (1.4i / 1.3CDTi models)			
• Six-speed manual gearbox (1.6CDTi models)	●	●	
<b>Steering:</b>			
• Hydraulic power-assisted rack and pinion system • Energy-absorbing steering column			
<b>Turning circle: Kerb-to-kerb</b>	●	●	
L1 11.3m (36.7ft.)			
L2 12.5m (41.0ft.)			
<b>Brakes:</b>			
<i>Front ventilated disc brakes:</i>			
• 284mm diameter (1.3CDTi / 1.6CDTi / 2000 models)			
• 305mm diameter (1.4i / 2300 models)	●	●	
<i>Rear self-adjusting drum brakes:</i>			
• 228mm diameter (1.3CDTi / 1.6CDTi)			
• 254mm diameter (1.4i)			
<b>Fuel tank:</b>	●	●	
• 60 litres (13.2 gallons) capacity			
<b>Electrical:</b>			
<i>Maintenance-free battery:</i>			
• 63Ah (1.4i / 1.3CDTi) • 72Ah (1.6CDTi)	●	●	
<i>Alternator:</i>			
• 105A (1.4i / 1.3CDTi) • 100A (1.6CDTi)			
• 120A – Models with air conditioning.			
• Uprated alternator			
			Option code: KX3
	○	○	<b>55.00</b>
<b>Front suspension:</b>	●	●	
• Independent lightweight MacPherson struts • Coil springs • Telescopic gas-pressure dampers • Anti-roll bar			
<b>Rear suspension:</b>	●	●	
• Independent bi-link suspension • Coil springs • Gas pressure dampers • Anti-roll bar			

● = Standard equipment. ○ = Optional at extra cost.

## TYRE RATINGS

Tyre size	Fuel efficiency group	Wet grip performance	External noise	
			Measured (dB)	Group
185/65 R 15	C-E	A-C	68-69	
195/65 R 15	C-E	C-E	68-70	
195/60 R 16	C-E	B-C	70-72	

Tyre rating according to EU Regulation 1222/2009

# VIVARO PANEL VAN PRICES



Model	Minimum Mass (kg)*	Payload (kg)*	Fuel economy mpg (litres/100km)#			CO <sub>2</sub> emissions (g/km)#	Price (£) exc. VAT	On-the-road RRP (£) exc. VAT
			Urban driving	Extra-urban driving	Combined figure			
<b>L1 H1 PANEL VAN (EURO 6)</b>								
2700 1.6CDTi (95PS) BlueInjection	1800	1060	36.2 (7.8)	48.7 (5.8)	43.4 (6.5)	170	20970.00	<b>21848.33</b>
2700 1.6CDTi (95PS) S/S ecoFLEX BlueInjection	1800	1060	39.2 (7.2)	50.4 (5.6)	46.3 (6.1)	160	21165.00	<b>22043.33</b>
2700 1.6CDTi (120PS) BlueInjection	1800	1060	36.2 (7.8)	48.7 (5.8)	43.4 (6.5)	170	21570.00	<b>22448.33</b>
2700 1.6CDTi BiTurbo (125PS) S/S BlueInjection	1818	1062	40.9 (6.9)	51.4 (5.5)	47.0 (6.0)	155	21970.00	<b>22848.33</b>
2900 1.6CDTi (95PS) BlueInjection	1800	1220	36.2 (7.8)	48.7 (5.8)	43.4 (6.5)	170	21470.00	<b>22348.33</b>
2900 1.6CDTi (95PS) S/S ecoFLEX BlueInjection	1800	1220	39.2 (7.2)	50.4 (5.6)	46.3 (6.1)	160	21665.00	<b>22543.33</b>
2900 1.6CDTi (120PS) BlueInjection	1800	1220	36.2 (7.8)	48.7 (5.8)	43.4 (6.5)	170	22070.00	<b>22948.33</b>
2900 1.6CDTi BiTurbo (125PS) S/S BlueInjection	1818	1222	40.9 (6.9)	51.4 (5.5)	47.0 (6.0)	155	22470.00	<b>23348.33</b>
<b>L1 H1 SPORTIVE PANEL VAN (EURO 6)</b>								
2700 1.6CDTi (120PS) BlueInjection	1800	1030	36.2 (7.8)	48.7 (5.8)	43.4 (6.5)	170	22770.00	<b>23648.33</b>
2700 1.6CDTi BiTurbo (125PS) S/S BlueInjection	1818	1032	40.9 (6.9)	51.4 (5.5)	47.0 (6.0)	155	23170.00	<b>24048.33</b>
2700 1.6CDTi BiTurbo (145PS) S/S BlueInjection	1818	1032	39.8 (7.1)	50.4 (5.6)	46.3 (6.1)	160	23970.00	<b>24848.33</b>
2900 1.6CDTi (120PS) BlueInjection	1800	1190	36.2 (7.8)	48.7 (5.8)	43.4 (6.5)	170	23270.00	<b>24148.33</b>
2900 1.6CDTi BiTurbo (125PS) S/S BlueInjection	1818	1192	40.9 (6.9)	51.4 (5.5)	47.0 (6.0)	155	23670.00	<b>24548.33</b>
2900 1.6CDTi BiTurbo (145PS) S/S BlueInjection	1818	1192	39.8 (7.1)	50.4 (5.6)	46.3 (6.1)	160	24470.00	<b>25348.33</b>
<b>L1 H1 LIMITED EDITION NAV PANEL VAN (EURO 6)</b>								
2700 1.6CDTi BiTurbo (125PS) S/S BlueInjection	1818	1017	40.9 (6.9)	51.4 (5.5)	47.0 (6.0)	155	24370.00	<b>25248.33</b>
2700 1.6CDTi BiTurbo (145PS) S/S BlueInjection	1818	1017	39.8 (7.1)	50.4 (5.6)	46.3 (6.1)	160	25170.00	<b>26048.33</b>
<b>L1 H2 PANEL VAN (EURO 6)</b>								
2900 1.6CDTi BiTurbo (125PS) S/S BlueInjection	1897	1143	38.7 (7.3)	43.5 (6.5)	41.5 (6.8)	175	23870.00	<b>24748.33</b>

**Please note:** On-the-road recommended retail prices (RRP) include number plates and delivery to Retailer of £583.33 (exc. VAT), 12 months' Vehicle Excise Duty at £240.00 and new vehicle first registration fee of £55.00. Excludes fuel and insurance.

S/S = Start/Stop.

Vehicles with BlueInjection technology will need regular AdBlue® top-ups also between servicing requirements. An indicator integrated into the on-board computer will warn you when you need to top up. More information under [www.vauxhall.co.uk/blueinjection](http://www.vauxhall.co.uk/blueinjection). In accordance with regulations R (EC) No. 715/2007 and R (EC) No. 692/2008 (in the versions respectively applicable).

\* = For definitions please refer to Glossary of Terms.

# = Fuel consumption information is official government environmental data, tested in accordance with the relevant EU directive. Official EU-regulated test data is provided for comparison purposes and actual performance will depend on driving style, road conditions and other non-technical factors.

# VIVARO PANEL VAN PRICES



Model	Minimum Mass (kg)*	Payload (kg)*	Fuel economy mpg (litres/100km)#			CO <sub>2</sub> emissions (g/km)#	Price (£) exc. VAT	On-the-road RRP (£) exc. VAT
			Urban driving	Extra-urban driving	Combined figure			
<b>L2 H1 PANEL VAN (EURO 6)</b>								
2900 1.6CDTi (95PS) BlueInjection	1825	1265	35.3 (8.0)	47.0 (6.0)	42.1 (6.7)	174	22270.00	<b>23148.33</b>
2900 1.6CDTi (95PS) S/S ecoFLEX BlueInjection	1825	1265	38.7 (7.3)	48.7 (5.8)	44.8 (6.3)	164	22465.00	<b>23343.33</b>
2900 1.6CDTi (120PS) BlueInjection	1825	1265	35.3 (8.0)	47.0 (6.0)	42.1 (6.7)	174	22870.00	<b>23748.33</b>
2900 1.6CDTi BiTurbo (125PS) S/S BlueInjection	1835	1265	40.3 (7.0)	50.4 (5.6)	46.3 (6.1)	159	23270.00	<b>24148.33</b>
<b>L2 H1 SPORTIVE PANEL VAN (EURO 6)</b>								
2900 1.6CDTi (120PS) BlueInjection	1825	1235	35.3 (8.0)	47.0 (6.0)	42.1 (6.7)	174	24070.00	<b>24948.33</b>
2900 1.6CDTi BiTurbo (125PS) S/S BlueInjection	1835	1235	40.3 (7.0)	50.4 (5.6)	46.3 (6.1)	159	24470.00	<b>25348.33</b>
2900 1.6CDTi BiTurbo (145PS) S/S BlueInjection	1835	1235	39.2 (7.2)	48.7 (5.8)	44.8 (6.3)	164	25270.00	<b>26148.33</b>
<b>L2 H1 LIMITED EDITION NAV PANEL VAN (EURO 6)</b>								
2900 1.6CDTi BiTurbo (125PS) S/S BlueInjection	1835	1220	40.3 (7.0)	50.4 (5.6)	46.3 (6.1)	159	25670.00	<b>26548.33</b>
2900 1.6CDTi BiTurbo (145PS) S/S BlueInjection	1835	1220	39.2 (7.2)	48.7 (5.8)	44.8 (6.3)	164	26470.00	<b>27348.33</b>
<b>L2 H2 PANEL VAN (EURO 6)</b>								
2900 1.6CDTi BiTurbo (125PS) S/S BlueInjection	1945	1185	38.2 (7.4)	42.8 (6.6)	40.9 (6.9)	178	24670.00	<b>25548.33</b>

**Please note:** On-the-road recommended retail prices (RRP) include number plates and delivery to Retailer of £583.33 (exc. VAT), 12 months' Vehicle Excise Duty at £240.00 and new vehicle first registration fee of £55.00. Excludes fuel and insurance.

S/S = Start/Stop.

Vehicles with BlueInjection technology will need regular AdBlue® top-ups also between servicing requirements. An indicator integrated into the on-board computer will warn you when you need to top up. More information under [www.vauxhall.co.uk/blueinjection](http://www.vauxhall.co.uk/blueinjection). In accordance with regulations R (EC) No. 715/2007 and R (EC) No. 692/2008 (in the versions respectively applicable).

\* = For definitions please refer to Glossary of Terms.

# = Fuel consumption information is official government environmental data, tested in accordance with the relevant EU directive. Official EU-regulated test data is provided for comparison purposes and actual performance will depend on driving style, road conditions and other non-technical factors.

# VIVARO DOUBLECAB PRICES



Model	Minimum Mass (kg)*	Payload (kg)*	Fuel economy mpg (litres/100km)#			CO <sub>2</sub> emissions (g/km)#	Price (£) exc. VAT	On-the-road RRP (£) exc. VAT	On-the-road RRP (£) inc. VAT
			Urban driving	Extra-urban driving	Combined figure				
<b>L1 H1 DOUBLECAB (EURO 6)</b>									
2900 1.6CDTi (95PS) BlueInjection	1920	974	35.3 (8.0)	47.0 (6.0)	42.1 (6.7)	174	22970.00	<b>23848.33</b>	<b>28559.00</b>
2900 1.6CDTi (95PS) S/S ecoFLEX BlueInjection	1920	974	38.7 (7.3)	48.7 (5.8)	44.8 (6.3)	164	23165.00	<b>24043.33</b>	<b>28793.00</b>
2900 1.6CDTi (120PS) BlueInjection	1920	974	35.3 (8.0)	47.0 (6.0)	42.1 (6.7)	174	23570.00	<b>24448.33</b>	<b>29279.00</b>
2900 1.6CDTi BiTurbo (125PS) S/S BlueInjection	1930	974	40.3 (7.0)	50.4 (5.6)	46.3 (6.1)	159	23970.00	<b>24848.33</b>	<b>29759.00</b>
<b>L1 H1 SPORTIVE DOUBLECAB (EURO 6)</b>									
2900 1.6CDTi (120PS) BlueInjection	1920	934	35.3 (8.0)	47.0 (6.0)	42.1 (6.7)	174	24920.00	<b>25798.33</b>	<b>30899.00</b>
2900 1.6CDTi BiTurbo (125PS) S/S BlueInjection	1930	934	40.3 (7.0)	50.4 (5.6)	46.3 (6.1)	159	25320.00	<b>26198.33</b>	<b>31379.00</b>
2900 1.6CDTi BiTurbo (145PS) S/S BlueInjection	1930	934	39.2 (7.2)	48.7 (5.8)	44.8 (6.3)	164	26120.00	<b>26998.33</b>	<b>32339.00</b>
<b>L1 H1 LIMITED EDITION NAV DOUBLECAB (EURO 6)</b>									
2900 1.6CDTi BiTurbo (125PS) S/S BlueInjection	1930	919	40.3 (7.0)	50.4 (5.6)	46.3 (6.1)	159	26520.00	<b>27398.33</b>	<b>32819.00</b>
2900 1.6CDTi BiTurbo (145PS) S/S BlueInjection	1930	919	39.2 (7.2)	48.7 (5.8)	44.8 (6.3)	164	27320.00	<b>28198.33</b>	<b>33779.00</b>
<b>L2 H1 DOUBLECAB (EURO 6)</b>									
2900 1.6CDTi (95PS) BlueInjection	1975	1025	35.3 (8.0)	47.0 (6.0)	42.1 (6.7)	174	23770.00	<b>24648.33</b>	<b>29519.00</b>
2900 1.6CDTi (95PS) S/S ecoFLEX BlueInjection	1975	1025	38.7 (7.3)	48.7 (5.8)	44.8 (6.3)	164	23965.00	<b>24843.33</b>	<b>29753.00</b>
2900 1.6CDTi (120PS) BlueInjection	1975	1025	35.3 (8.0)	47.0 (6.0)	42.1 (6.7)	174	24370.00	<b>25248.33</b>	<b>30239.00</b>
2900 1.6CDTi BiTurbo (125PS) S/S BlueInjection	1985	1025	40.3 (7.0)	50.4 (5.6)	46.3 (6.1)	159	24770.00	<b>25648.33</b>	<b>30719.00</b>
<b>L2 H1 SPORTIVE DOUBLECAB (EURO 6)</b>									
2900 1.6CDTi (120PS) BlueInjection	1975	985	35.3 (8.0)	47.0 (6.0)	42.1 (6.7)	174	25720.00	<b>26598.33</b>	<b>31859.00</b>
2900 1.6CDTi BiTurbo (125PS) S/S BlueInjection	1985	985	40.3 (7.0)	50.4 (5.6)	46.3 (6.1)	159	26120.00	<b>26998.33</b>	<b>32339.00</b>
2900 1.6CDTi BiTurbo (145PS) S/S BlueInjection	1985	985	39.2 (7.2)	48.7 (5.8)	44.8 (6.3)	164	26920.00	<b>27798.33</b>	<b>33299.00</b>
<b>L2 H1 LIMITED EDITION NAV DOUBLECAB (EURO 6)</b>									
2900 1.6CDTi BiTurbo (125PS) S/S BlueInjection	1985	970	40.3 (7.0)	50.4 (5.6)	46.3 (6.1)	159	27320.00	<b>28198.33</b>	<b>33779.00</b>
2900 1.6CDTi BiTurbo (145PS) S/S BlueInjection	1985	970	39.2 (7.2)	48.7 (5.8)	44.8 (6.3)	164	28120.00	<b>28998.33</b>	<b>34739.00</b>

**Please note:** On-the-road recommended retail prices (RRP) include number plates and delivery to Retailer of £583.33 (exc. VAT), 12 months' Vehicle Excise Duty at £240.00 and new vehicle first registration fee of £55.00. Excludes fuel and insurance.

S/S = Start/Stop.

Vehicles with BlueInjection technology will need regular AdBlue® top-ups also between servicing requirements. An indicator integrated into the on-board computer will warn you when you need to top up. More information under [www.vauxhall.co.uk/blueinjection](http://www.vauxhall.co.uk/blueinjection). In accordance with regulations R (EC) No. 715/2007 and R (EC) No. 692/2008 (in the versions respectively applicable).

\* = For definitions please refer to Glossary of Terms.

# = Fuel consumption information is official government environmental data, tested in accordance with the relevant EU directive. Official EU-regulated test data is provided for comparison purposes and actual performance will depend on driving style, road conditions and other non-technical factors.

VAT reclaimable status requires a 1-tonne payload for Doublecabs according to HMRC. This payload calculation should take into consideration local UK Specification and Trim Level. Details enabling this determination are shown in the notes immediately below the weight tables shown in brochures and Price Guides. Ordered options may also impact available payload. Regarding VAT reclaimable status it is advisable that customers consult their local HMRC office or visit [www.hmrc.co.uk](http://www.hmrc.co.uk) for further details.

# VIVARO COMBI / PLATFORM CAB PRICES



Model	Minimum Mass (kg)*	Payload (kg)*	Fuel economy mpg (litres/100km)#			CO <sub>2</sub> emissions (g/km)#	Price (£) exc. VAT	On-the-road RRP (£) inc. VAT
			Urban driving	Extra-urban driving	Combined figure			
<b>L1 H1 9-SEAT COMBI (EURO 6)</b>								
2900 1.6CDTi (95PS) S/S ecoFLEX BlueInjection	1872	1068	41.5 (6.8)	52.3 (5.4)	47.1 (6.0)	155	23683.33	<b>29675.00</b>
2900 1.6CDTi BiTurbo (125PS) S/S BlueInjection	1882	1148	44.1 (6.4)	55.4 (5.1)	50.4 (5.6)	145	24516.67	<b>30375.00</b>
<b>L2 H1 9-SEAT COMBI (EURO 6)</b>								
2900 1.6CDTi (95PS) S/S ecoFLEX BlueInjection	1913	1157	41.5 (6.8)	52.3 (5.4)	47.1 (6.0)	155	24483.33	<b>30635.00</b>
2900 1.6CDTi BiTurbo (125PS) S/S BlueInjection	1923	1157	44.1 (6.4)	55.4 (5.1)	50.4 (5.6)	145	25316.67	<b>31335.00</b>

**Please note:** On-the-road recommended retail prices (RRP) include number plates and delivery to Retailer of £583.33 (exc. VAT), 12 months' Vehicle Excise Duty at £200.00 on BiTurbo (125PS) models, £500.00 on (95PS) models and new vehicle first registration fee of £55.00. Excludes fuel and insurance.

S/S = Start/Stop.

Vehicles with BlueInjection technology will need regular AdBlue® top-ups also between servicing requirements. An indicator integrated into the on-board computer will warn you when you need to top up. More information under [www.vauxhall.co.uk/blueinjection](http://www.vauxhall.co.uk/blueinjection). In accordance with regulations R (EC) No. 715/2007 and R (EC) No. 692/2008 (in the versions respectively applicable).

\* = For definitions please refer to Glossary of Terms.

# = Fuel consumption information is official government environmental data, tested in accordance with the relevant EU directive. Official EU-regulated test data is provided for comparison purposes and actual performance will depend on driving style, road conditions and other non-technical factors.

Model	Minimum Mass (kg)*	Payload and Body Allowance (kg)*	Fuel economy mpg (litres/100km)#			CO <sub>2</sub> emissions (g/km)#	Price (£) exc. VAT	On-the-road RRP (£) exc. VAT
			Urban driving	Extra-urban driving	Combined figure			
<b>L2 H1 PLATFORM CAB (EURO 6)</b>								
2900 1.6CDTi BiTurbo (125PS) S/S BlueInjection	1616	1474	37.7 (7.5)	42.2 (6.7)	40.4 (7.0)	181	23170.00	<b>24048.33</b>
2900 1.6CDTi BiTurbo (145PS) S/S BlueInjection	1616	1474	37.7 (7.5)	42.2 (6.7)	40.4 (7.0)	181	23970.00	<b>24848.33</b>

**Please note:** On-the-road recommended retail prices (RRP) include number plates and delivery to Retailer of £583.33 (exc. VAT), 12 months' Vehicle Excise Duty at £240.00 and new vehicle first registration fee of £55.00. Excludes fuel and insurance.

S/S = Start/Stop.

Vehicles with BlueInjection technology will need regular AdBlue® top-ups also between servicing requirements. An indicator integrated into the on-board computer will warn you when you need to top up. More information under [www.vauxhall.co.uk/blueinjection](http://www.vauxhall.co.uk/blueinjection). In accordance with regulations R (EC) No. 715/2007 and R (EC) No. 692/2008 (in the versions respectively applicable).

All conversions must follow 'Vauxhall Converter Requirements' including recommended dimensional data, detailed within Part 1, available at: [www.vauxhall.co.uk/conversiondata](http://www.vauxhall.co.uk/conversiondata). The weight of any fitted conversion body will have to be deducted from these figures to establish actual payload and is subject to correct weight distribution. Variations from the recommended dimensions or weights may affect the vehicle's overall centre of gravity and stability. From 29 April 2013 conversion of N1 vehicles was affected by changes to type approval – for further information refer to the VCA website (N2 vehicles were affected from 29 October 2014). For further information please contact [conversions@vauxhall.co.uk](mailto:conversions@vauxhall.co.uk)

\* = For definitions please refer to Glossary of Terms.

# = Fuel consumption information is official government environmental data, tested in accordance with the relevant EU directive. Official EU-regulated test data is provided for comparison purposes and actual performance will depend on driving style, road conditions and other non-technical factors.

All conversions must follow 'Conversion Requirements' available on: [www.vauxhall.co.uk/conversiondata](http://www.vauxhall.co.uk/conversiondata)

# VIVARO EQUIPMENT / OPTIONS

## SAFETY

	Vivaro	Sportive	Limited Edition	Combi	Price (£) exc. VAT	Total (£) inc. VAT
<b>Airbags:</b>	●	●	●	●		
<i>Driver's airbag</i>	●	●	●	●		
<i>Front passengers' airbag:</i>						
• Front passengers' airbag with deactivation switch Option code: AK5	○	○	○	●	245.00	
• Driver and front passenger's curtain airbags and driver's side-impact airbag Option code: AWH	○	○	○	○	410.00	<b>492.00</b>
• Driver and single front passenger's curtain and side-impact airbags – <i>Mandates single passenger seat.</i> Option code: AYO	○	○	○	○	610.00	<b>732.00</b>
<b>Stability:</b>						
<i>Electronic Stability Programme-plus (ESP-plus) with traction control</i> – Works in conjunction with the vehicle's electronic braking and engine systems to keep the vehicle stable in many different situations. ESP monitors a variety of inputs to determine when the vehicle starts to lose traction, it can then immediately respond by varying the brake pressure between up to three wheels and adjust the engine output to help correct the loss of traction and improve stability.	●	●	●	●		
<b>Tyre pressure:</b>						
• Tyre pressure monitoring system Option code: UJO	○	○	○	●	210.00	
<b>Anti-lock braking:</b>						
<i>Four-channel Anti-lock Braking System (ABS) – Prevents the vehicle's wheels from locking up under heavy braking by momentarily reducing brake pressure at the appropriate wheel, ensuring that you can maintain control of the steering.</i>	●	●	●	●		
<i>Emergency brake assist – When emergency braking is detected the vehicle automatically applies the maximum possible braking assistance.</i>	●	●	●	●		
<i>Electronic brakeforce distribution – Automatically apportions the optimum braking force to each wheel.</i>	●	●	●	●		
<i>Hill start assist – Briefly maintains rear brake pressure to stop the vehicle rolling back on an incline.</i>	●	●	●	●		
<b>Bulkhead:</b>	●					
• Full-height steel bulkhead without window – <i>Optional on Platform Cab models.</i>	●					
• Full-height ABS plastic bulkhead with window – <i>Doublecab only.</i>	●	●	●			
• Full-height steel bulkhead with window Option code: AX9	○				75.00	
• Vertical luggage restraint – <i>Half-height solid with black upper mesh.</i> Option code: AQ2				○		<b>168.00</b>
<b>FlexCargo load-through bulkhead:</b>						
• Dual front passengers' seat with storage, rotating clipboard and fold-flat centre • Load-through bulkhead – <i>Panel Van models only</i> Option code: AYW	○	●	●		265.00	
• Dual front passengers' seat with storage, rotating clipboard and fold-flat centre • Load-through bulkhead with window Option code: AYV	○				330.00	
• Dual front passengers' seat with storage, rotating clipboard and fold-flat centre • Load-through bulkhead with window Option code: AYV		○	○		75.00	

● = Standard equipment. ○ = Optional at extra cost.

# VIVARO EQUIPMENT / OPTIONS

## SECURITY

	Vivaro	Sportive	Limited Edition	Combi	Price (£) exc. VAT	Total (£) inc. VAT
<b>Features:</b>	●	●	●	●		
• Electronic engine deadlock immobiliser • Steering column lock • Secure fuel filler flap	●	●	●	●		
• Internal lockable rear and sliding side-access doors • Anti-theft spare wheel cradle	●	●	●	●		
<b>Remote control door locking (features depending on body type):</b>	●	●	●	●		
• Remote control door locking • Two keys with integral remote • Door deadlocks	●	●	●	●		
• Selective door locking • Two three-button keys with integral remote – <i>Only available with one-touch facility for electrically operated windows.</i>	○	●	●	○	205.00	<b>246.00</b>
Option code: AUX	○	●	●	○		
• Third key with integral remote	○	○	○	○	115.00	<b>138.00</b>
Option code: K69	○	○	○	○		
<b>Keyless entry and start:</b>						
• Keyless entry and start						
– <i>H1 models only.</i>						
– <i>Start/Stop models. Only available with electronic climate control (all models excluding Combi). Adds one-touch facility for electrically operated front-windows.</i>	○	○	○	○	260.00	<b>312.00</b>
Option code: AVT	○	○	○	○		
<b>Security alarm system:</b>						
• Engine compartment protection • Ultrasonic detectors in load area • Siren						
• Thatcham Category 1 approved (TUL3-180/0116)	○	○	○	○	325.00	<b>390.00</b>
– <i>H1 models only.</i>	○	○	○	○		
Option code: XBGY	○	○	○	○		
<b>Luggage cover:</b>						
• Rigid luggage cover • 50kg load – <i>Two-part on L2 models.</i>				○		<b>540.00</b>
Option code: D42				○		

● = Standard equipment. ○ = Optional at extra cost.



# VIVARO EQUIPMENT / OPTIONS

## COMFORT AND SEATING

	Vivaro	Sportive	Limited Edition	Combi	Price (£) exc. VAT	Total (£) inc. VAT
<b>Comfort:</b> <ul style="list-style-type: none"> <li>Height-adjustable steering wheel • Leather-covered steering wheel (Sportive / Limited Edition models)</li> <li>Facia-mounted gear lever • Floor-mounted handbrake lever • Blue Tricess cloth seat trim (Standard models)</li> <li>Black Connect embossed cloth seat trim (Sportive / Limited Edition models) • Vinyl floor covering</li> <li>Inertia-reel lap and diagonal seatbelts • Height-adjustable outer front seatbelts</li> </ul>	●	●	●	●		
<b>Driver's seat:</b> <ul style="list-style-type: none"> <li>Height • Reach • Backrest recline • Driver's active safety head restraint • Height-adjustable padded head restraint</li> <li>Driver's seat armrest</li> </ul>	●	●	●	●		
<b>Dual front passengers' bench seat:</b> <ul style="list-style-type: none"> <li>Fixed position bench seat and backrest • Height-adjustable outer front padded head restraint</li> <li>Fixed centre seat padded head restraint</li> </ul>	●			●		
<b>Dual front passengers' seat with underseat storage</b> <ul style="list-style-type: none"> <li>Fixed position bench seat and backrest • Height-adjustable outer front padded head restraint</li> <li>Fixed centre seat padded head restraint – <i>Doublecab / Combi models.</i></li> </ul> Option code: AGE	○	●	●	○	175.00	<b>210.00</b>
<b>Single front passenger's seat:</b> <ul style="list-style-type: none"> <li>Lumbar adjustment • Height • Reach • Backrest recline • Height-adjustable padded head restraint</li> <li>Armrest – <i>Sportive / Limited Edition models will be supplied with full-height steel bulkhead when this option is specified.</i></li> </ul> Option code: AGD	○	○	○	○	155.00	<b>186.00</b>
<b>Heated front seats:</b> <ul style="list-style-type: none"> <li>Electrically heated driver and single front passenger seats</li> <li>– <i>Only available with either single front passenger seat and curtain airbags / side-impact airbag options</i></li> </ul> Option code: KA1	○	○	○	○	160.00	<b>192.00</b>

## SEATING – DOUBLECAB

<b>Second-row seating:</b> <ul style="list-style-type: none"> <li>Three-individually contoured rear seats • Inertia-reel lap and diagonal seatbelts • Padded head restraints</li> </ul>	●	●	●			
<ul style="list-style-type: none"> <li>Underseat storage • 12-volt accessory socket</li> </ul>		●	●			

## SEATING – COMBI

<b>Second-row seating:</b> <ul style="list-style-type: none"> <li>Three-passenger second-row bench seat • 60/40 split-folding seat back for easier access to third-row bench seat</li> <li>Removable second row bench seats • Inertia-reel lap and diagonal seatbelts</li> </ul>				●		
<b>Third-row seating:</b> <ul style="list-style-type: none"> <li>Three passenger bench seat • Fold and tumble feature for creating extra load area without removing seats</li> <li>Removable rear seats • Inertia-reel lap and diagonal seatbelts</li> </ul>				●		

● = Standard equipment. ○ = Optional at extra cost.

# VIVARO EQUIPMENT / OPTIONS

## CABIN STORAGE

	Vivaro	Sportive	Limited Edition	Combi	Price (£) exc. VAT	Total (£) inc. VAT
<b>Accessory sockets:</b> • Facia-mounted 12-volt accessory socket	●	●	●	●		
<b>Facia storage:</b> • Nine facia storage spaces offering more than 24 litres of storage • Open storage compartment above glovebox (lidded on Sportive / Limited Edition models) • Illuminated glovebox • Three drinks holders • Coin holder	●	●	●	●		
<b>Front door pockets:</b> • Large door pockets with drinks holder	●	●	●	●		
<b>Smoker Pack:</b> • Removable ashtray • Illuminated cigar lighter Option code: DT4	○	○	○	○	55.00	<b>66.00</b>

## DRIVER ASSISTANCE

<b>Windscreen wipers:</b> • Two-speed windscreen wipers • Variable intermittent wipe • Electric screenwash	●	●	●	●		
<b>Multi-function trip computer:</b> • Trip odometer • Vehicle range based on remaining fuel • Average speed • Average fuel economy • Instantaneous fuel economy • Driving time	●	●	●	●		
<b>Parking assistance:</b> • Rear parking distance sensors Option code: UD7	○	●	●	○	235.00	<b>282.00</b>
• Rear-view camera – H1 models only. Not available on Platform Cab models. – Requires Sight and Light Pack (Sportive models). Option code: UDS		○	○		295.00	
• Rear-view camera • Rear parking distance sensors – H1 models only. Not available on Platform Cab models. – Requires Lighting Pack. Option code: UDS	○			○	520.00	<b>624.00</b>
• Nearside blind-spot / junction mirror located in front passenger sunvisor	●	●	●	●		
Cruise control, speed limiter Option code: K34	○	●	●	○	260.00	<b>312.00</b>
<b>Speed limiter:</b> • Choice of three speeds: 56mph / 62mph / 68mph Option code: (56mph) KYJ Option code: (62mph) KYK Option code: (68mph) KYL	○	○	○	○	85.00	<b>102.00</b>

● = Standard equipment. ○ = Optional at extra cost.

# VIVARO EQUIPMENT / OPTIONS

## DRIVER INFORMATION

	Vivaro	Sportive	Limited Edition	Combi	Price (£) exc. VAT	Total (£) inc. VAT
<b>Instrumentation:</b> <ul style="list-style-type: none"> <li>• Speedometer • Rev counter • Fuel gauge with low fuel warning light • Fuel economy gauge • Coolant temperature warning light</li> </ul>	●	●	●	●		
<b>ECO features:</b> <ul style="list-style-type: none"> <li>• Shift-up indicator</li> <li>- Indicates when to change gear for optimum fuel economy.</li> </ul>	●	●	●	●		
<b>Driver information display:</b> <ul style="list-style-type: none"> <li>• Monochrome display located in instrument cluster • Odometer • Service-due indicator • Displays trip computer data</li> </ul>	●	●	●	●		
<b>Central fascia display:</b> <ul style="list-style-type: none"> <li>• Audio information • Digital clock with automatic RDS time adjustment • Outside air temperature with ice warning function • Additional features and location dependent on infotainment unit (see Audio, Communication and Navigation for details)</li> </ul>	●	●	●	●		
<b>Warning indicators:</b> <ul style="list-style-type: none"> <li>• Low oil level, low brake fluid, brake pad wear, battery, fuel filter, low AdBlue® level, seatbelt warning and doors open</li> </ul>	●	●	●	●		
<b>Digital tachograph:</b> <ul style="list-style-type: none"> <li>• Odometer display is changed from miles to kilometres – <i>Digital tachograph only available with R 16 audio unit.</i></li> <li>- <i>Important: The digital tachograph must be specified at time of ordering as it cannot be fitted retrospectively. Option price does not include calibration which must be carried out at an approved tachograph centre within 14 days of the vehicle's registration. Please note: The legislation regarding the use of tachographs is complex and operators should seek independent advice or speak to the Commercial Vehicle specialist at your Vauxhall retailer to ensure compliance. Alternatively your local DVLA office will also be able to provide clarification of the relevant legislation.</i></li> </ul> <p style="text-align: right;">Option code: TGP</p>	○			○	535.00	<b>642.00</b>

## PACKS

<b>Navigation Pack:</b> <ul style="list-style-type: none"> <li>• Satellite navigation – NAVI 50 IntelliLink • Rear parking distance sensors • Rear-view camera • One-touch electrically operated front windows • Three-button key • Selective door locking</li> <li>- <i>H1 models only. Not available on Platform Cab models. Requires Lighting Pack.</i></li> </ul> <p style="text-align: right;">Option code: OEC</p>	○			○	1005.00	<b>1206.00</b>
<b>Navigation Pack:</b> <ul style="list-style-type: none"> <li>• Satellite navigation – NAVI 50 IntelliLink • Rear-view camera – <i>Requires Sight and Light Pack.</i></li> </ul> <p style="text-align: right;">Option code: OEC</p>		○			860.00	

● = Standard equipment. ○ = Optional at extra cost.

# VIVARO EQUIPMENT / OPTIONS

## INFOTAINMENT

	Vivaro	Sportive	Limited Edition	Combi	Price (£) exc. VAT	Total (£) inc. VAT
<b>R 16 BT USB:</b> <i>Onboard features:</i> • DAB digital radio • AM/FM stereo radio with 6-station presets • RDS with Traffic Programme • Two speakers – <i>Four on Combi models</i> • 20 watts per channel output <i>Media connections:</i> • USB connection with iPod control • Aux-in socket • Bluetooth® audio streaming (A2DP Profile) <i>Mobile phone portal:</i> • Bluetooth® connectivity • Handsfree calls via steering wheel controls • Vehicle microphone • Phone book access – <i>Contacts / last calls / missed calls etc. (features dependent on mobile phone).</i>	●	N/C	N/C	●		
<b>CD 18 BT USB:</b> <i>Onboard features:</i> • DAB digital radio • AM/FM stereo radio with 6-station presets • CD/MP3 CD player • RDS with Traffic Programme • Two Speakers – <i>Four on Combi models</i> • 20 watts per channel output <i>Media connections:</i> • USB connection with iPod control • Aux-in socket • Bluetooth® audio streaming (A2DP Profile) <i>Mobile phone portal:</i> • Bluetooth® connectivity • Handsfree calls via steering wheel controls • Vehicle microphone • Phone book access – <i>Contacts / last calls / missed calls etc. (features dependent on mobile phone).</i>	○	●		○	295.00	<b>354.00</b>
<b>NAVI 50 IntelliLink – Not available when tachograph is specified:</b> <i>Onboard features:</i> • DAB digital radio • AM/FM stereo radio with 18-station presets • 7-inch facia-mounted colour touchscreen • RDS with Traffic Programme • Two speakers – <i>Four on Combi models.</i> • 20 watts per channel output <i>Navigation features:</i> • Satellite navigation system • 3D street level mapping • Major route mapping for Western Europe <i>Media connections:</i> • USB connection with iPod control • Aux-in socket • Bluetooth® audio streaming (A2DP Profile) • Siri voice control <i>Mobile phone portal:</i> • Bluetooth® connectivity • Handsfree calls via steering wheel controls • Vehicle microphone • Phone book access – <i>Contacts / last calls / missed calls etc. are mirrored on the display and are easily navigated using the touchscreen (features dependent on mobile phone).</i>	○	○	●	○	660.00	<b>792.00</b>
<b>NAVI 80 IntelliLink – Only available in conjunction with cruise control. Not available when tachograph is specified:</b> <i>Onboard features:</i> • DAB digital radio • AM/FM stereo radio with 18-station presets • 7-inch facia-mounted colour touchscreen • RDS with Traffic Programme • Two speakers – <i>Four on Combi models.</i> • 20 watts per channel output <i>Navigation features:</i> • Satellite navigation system • TomTom LIVE services • 3D street level mapping • Major route mapping for Europe • Traffic Information <i>Media connections:</i> • USB connection with iPod control • Aux-in socket • Bluetooth® audio streaming (A2DP Profile) • Integrated voice control <i>Mobile phone portal:</i> • Bluetooth® connectivity • Handsfree calls via steering wheel controls • Vehicle microphone • Phone book access – <i>Contacts / last calls / missed calls etc. are mirrored on the display and are easily navigated using the touchscreen (features dependent on mobile phone).</i>	○	○	○	○	1060.00	<b>1272.00</b>
<b>Flexdock for smartphone / tablet:</b> • Universal smartphone docking station (up to 4.7-inch)	○	○	●	○	35.00	<b>42.00</b>
• Tablet docking station (up to 4.8 – 10.6 inch) – <i>Only available with R 16 audio unit.</i>	○			○	60.00	<b>72.00</b>
<b>Additional features:</b> • Steering column mounted audio controls • Flexible roof-mounted aerial	●	●	●	●		

● = Standard equipment. ○ = Optional at extra cost. N/C = No-cost option.

# VIVARO EQUIPMENT / OPTIONS

## HEATING AND VENTILATION

	Vivaro	Sportive	Limited Edition	Combi	Price (£) exc. VAT	Total (£) inc. VAT
<b>Cab heating:</b> • Four-speed fan • Illuminated controls • Four adjustable facia vents • Windscreen demist vents • Side window demist vents	●	●	●	●		
<b>Climate and Cruise Pack:</b> • Air conditioning with air recirculation facility (cab only) • CD 18 BT USB audio unit • Cruise control Option code: XAEB	○			○	770.00	<b>924.00</b>
<b>Air conditioning – Cab only:</b> • Air recirculation facility • Pollen filter • Illuminated controls • Chilled glovebox facility Option code: C60	○	●	●	○	640.00	<b>768.00</b>
<b>Electronic climate control:</b> • Incorporating air conditioning • LCD temperature display • Automatic air direction and fan speed with manual override • Illuminated controls • Pollen filter • Chilled glovebox facility – <i>Requires Lighting Pack.</i> Option code: C68	○				890.00	
<b>Electronic climate control:</b> • LCD temperature display • Automatic air direction and fan speed with manual override • Illuminated controls • Pollen filter • Chilled glovebox facility – <i>Requires Sight and Light Pack.</i> Option code: C68		○	○		260.00	
<b>Air conditioning – Cab and saloon:</b> • Air recirculation facility • Pollen filter • Illuminated controls • Chilled glovebox facility • Auxiliary heater Option code: CJ5				○		<b>1272.00</b>
<b>Rear saloon heating:</b> • Fuel-fired – <i>Provides rapid heating of the engine coolant to enable heating of the vehicle interior without the engine running.</i> Option code: K08				○		<b>552.00</b>

● = Standard equipment. ○ = Optional at extra cost.

**Please note:** The air conditioning in vehicles with N1 type approval relies upon fluorinated greenhouse gases (R134a) for its functioning. The front system contains a quantity of overall 580g of R 134a, which corresponds to a CO<sub>2</sub> equivalent of 0.83 tons. The front and rear system contains a quantity of overall 890g of R 134a, which corresponds to a CO<sub>2</sub> equivalent of 1.27 tons. The global warming potential amounts to 1430. Information acc. to R (EU) No. 517/2014.

# VIVARO EQUIPMENT / OPTIONS

## LOAD ACCESS

	Vivaro	Sportive	Limited Edition	Combi	Price (£) exc. VAT	Total (£) inc. VAT
Illuminated load area	●	●	●	●		
<b>Nearside access:</b>						
<i>Nearside side-access door:</i>	●	●	●	●		
• Nearside sliding side-access door • Unglazed						
<b>Offside access – Panel Van only:</b>						
<i>Offside side-access door</i>	▲	▲	▲		270.00	
• Offside sliding side-access door • Unglazed						
<b>Nearside and offside access:</b>						
<i>Side-access doors with fixed windows – Standard on Doublecab:</i>						
• Fixed window to standard nearside side-access door (£55)	▲	▲	▲	●	380.00	
• Offside side-access door (£270)						
• Fixed window to offside side-access door (£55)						
<i>Side-access doors with sliding windows. Panel Van models – Only available with glazed rear doors / tailgate:</i>						
• Sliding window to standard nearside side-access door (£80)	▲	▲	▲		430.00	
• Offside side-access door (£270)						
• Sliding window to offside side-access door (£80)						
<i>Side-access doors with sliding windows – Doublecab / Combi models. Only available with glazed rear doors / tailgate:</i>						
• Sliding window to standard glazed nearside side-access door	▲	▲	▲	▲	60.00	72.00
• Sliding window to standard glazed offside side-access door						
<b>Rear access:</b>						
<i>Rear solid doors:</i>						
• Twin rear doors • 90°/180° opening	●	●	●			
• Twin rear doors • 270° opening						
– Not available on L1 models.					Option code: 7U4	250.00
<i>Rear glazed doors:</i>						
• Glazed rear doors • 90°/180° opening	○	○	○	○	85.00	102.00
– Only available with glazed bulkhead options.					Option code: J1X	
• Glazed rear doors • 270° opening	○	○	○		250.00	
– Not available on L1 models.					Option code: J1T	
• Glazed tailgate	○	○	○	●	120.00	
– Not available on H2 models. Only with glazed bulkhead and heated rear windows with wash/wipe facility options.					Option code: J1U	
• Heated rear windows with wash/wipe facility – Only with glazed rear door and tailgate options.	○	○	○	●	60.00	
					Option code: C25	

● = Standard equipment. ○ = Optional at extra cost. ▲ = Please refer to ordering guide.

# VIVARO EQUIPMENT / OPTIONS

## LOAD RESTRAINT

	Vivaro	Sportive	Limited Edition	Combi	Price (£) exc. VAT	Total (£) inc. VAT
<b>Load anchorage:</b>						
<ul style="list-style-type: none"> <li>Fixed floor-mounted load restraint lashing eyes (Panel Van: L1 x 8, L2 x 10)</li> <li>Load restraint lashing eyes (Panel Van: L1 x 8 / L2 x 10)</li> </ul>	●	●	●			
<b>Loading Pack with cargo lining:</b>						
<ul style="list-style-type: none"> <li>Unglazed steel bulkhead with FlexCargo load-through facility</li> <li>Dual passenger's seat with storage, rotating clipboard, fold-flat centre and load through compatibility</li> <li>Resin-coated plywood load floor covering</li> <li>Half-height plastic load lining panels</li> </ul> Option code: XYA9	○				430.00	
<b>Bott® Vario Racking System – Pack One – H1 Panel Van only</b>						
<i>Offside unit 1525mm wide x 320mm deep x 1000mm high</i>						
<ul style="list-style-type: none"> <li>End frames with corner protection</li> <li>2 x low front shelf with anti-slip mat</li> <li>Base compartment with lashing rail and ratchet strap</li> <li>Resin-coated, non-slip moisture repellent 9mm birch multiplex flooring</li> </ul>	L1 ○	L1 ○	L1 ○		1095.00	
<i>Nearside unit 1025mm wide x 420mm deep x 900mm high</i>						
<ul style="list-style-type: none"> <li>End frames with corner protection</li> <li>1 x low front shelf with anti-slip mat and divider</li> <li>1 x low front shelf</li> <li>Base compartment with lashing rail and ratchet strap</li> <li>Resin-coated, non-slip moisture repellent 9mm birch multiplex flooring</li> </ul> – Not available with floor covering, offside sliding side-access door or tailgate options. Option code: XCAA	L2 ○	L2 ○	L2 ○		1195.00	
<b>Bott® Vario Racking System – Pack Two – H1 Panel Van only</b>						
<i>Offside unit 2050mm wide x 320mm deep x 1000mm high</i>						
<ul style="list-style-type: none"> <li>End frames with corner protection</li> <li>1 x 2000mm wide low front shelf with 2 dividers</li> <li>1 x low front shelf with 4 x Bott storage boxes</li> <li>1 x low front shelf with 7 x Bott storage boxes</li> <li>1 x low front shelf with anti-slip mat</li> <li>1 x low front shelf with anti-slip mat and divider</li> <li>Base compartment with lashing rail and ratchet strap</li> <li>Full-height white plastic load lining</li> <li>Resin-coated, non-slip moisture repellent 9mm birch multiplex flooring</li> </ul>	L1 ○	L1 ○	L1 ○		1495.00	
<i>Nearside unit 1025mm wide x 420mm deep x 900mm high</i>						
<ul style="list-style-type: none"> <li>End frames with corner protection</li> <li>1 x low front shelf with anti-slip mat</li> <li>1 x low front shelf with 7 x Bott storage boxes</li> <li>A4 aluminium document pocket</li> <li>Base compartment with lashing rail and ratchet strap</li> <li>Full-height white plastic load lining</li> <li>Resin-coated, non-slip moisture repellent 9mm birch multiplex flooring</li> </ul> – Not available with load lining, floor covering, offside sliding side-access door or tailgate options. Option code: XBGT	L2 ○	L2 ○	L2 ○		1595.00	
<b>Load lining:</b>						
<ul style="list-style-type: none"> <li>Half-height plastic side load lining panels – Panel Van only.</li> </ul> Option code: B48	○	○	○		90.00	
<ul style="list-style-type: none"> <li>Full-height coated wooden load lining panels – H1 Panel Van only.</li> </ul> Option code: ERK	○	○	○		310.00	
<ul style="list-style-type: none"> <li>Full-height light plastic honeycomb load lining panels – H1 only.</li> </ul> Option code: B6H	○	○	○		305.00	
<ul style="list-style-type: none"> <li>Resin-coated laminate plywood load floor covering – H1 only.</li> </ul> Option code: B68	○	○	○		345.00	
<ul style="list-style-type: none"> <li>Rubber-coated reinforced wooden load floor covering – Panel Van only.</li> </ul> Option code: BIW	○	○	○		345.00	
<ul style="list-style-type: none"> <li>Resin-coated laminate plywood wheel arch protection – H1 only.</li> </ul> Option code: B65	○	○	○		210.00	

● = Standard equipment. ○ = Optional at extra cost.

# VIVARO EQUIPMENT / OPTIONS

## EXTERIOR CONVENIENCE / STYLING

	Vivaro	Sportive	Limited Edition	Combi	Price (£) exc. VAT	Total (£) inc. VAT
<b>Exterior features:</b> • Unique styled graphics – <i>Black or silver dependent on exterior colour. Please see Exterior Colours page.</i>			●			
<b>Appearance Pack One:</b> • Body-colour front bumper • Body-colour rear quarter bumpers – <i>Not available when Ink Blue paint is specified. H2 models are only available when Glacier White or Platinum Silver colours are specified.</i> Option code: 5LK	○			○	310.00	372.00
<b>Appearance Pack Two:</b> • Leather-covered steering wheel • Black Connect embossed cloth seat trim • Chrome instrument surrounds • Lidded storage compartment above glovebox • LED daytime running lights • Front fog lights • Full-diameter wheel trims • Body-colour front bumper • Body-colour rear quarter bumpers – <i>Not available when Ink Blue paint is specified.</i> Option code: XADR				○		1200.00
<b>Windows:</b> • Electrically operated front windows • One-touch facility for electrically operated windows Option code: AXG	●	●	●	●	50.00	60.00
• Dark-tinted rear glazing – <i>H1 models only. Only available with glazed rear doors / tailgate with heated windows and wash / wipe facility.</i> – <i>Excludes Platform Cab.</i> Option code: AJS	○	○	○	○	360.00	432.00
<b>Door mirrors:</b> • Foldable electrically adjustable/heated door mirrors • Wide-angle mirror on driver's side • Electrically adjustable / heated long arm exterior door mirrors – <i>Platform Cab only. Long arm exterior mirrors should be applied to any vehicle with an overall width of 2.17 to 2.35 metres.</i> Option code: DCI	●	●	●	●	170.00	
<b>Paint finish:</b> • Special paint – <i>Restrictions apply, please consult your Retailer for details.</i>	○			○		At extra cost

## GLAZED PACK – PANEL VAN

• Fixed window to standard nearside side-access door • Fixed window to opposite offside side-access door • Rear glazed doors • Rear glazed side panels – <i>Panel Van only. Only available when the offside sliding side-access door is specified.</i> Option code: A10	○	○	○		420.00	
---	---	---	---	--	--------	--

## EXTERIOR LIGHTING

<b>Standard lighting:</b> • Lights-on audible warning • Electric headlight beam levelling • Twin reversing lights • Hazard warning lights • Rear fog lights • High-level brake light • High-level tail lights • Side-repeat indicators • Daytime running lights – <i>LED on Sportive models.</i> • Front fog lights. Option code: T3U	●	●	●	●	105.00	126.00
<b>Lighting Pack:</b> • Static cornering lights • Front fog lights • Automatic lighting control • Rain-sensitive windscreen wipers • Door-to-door illumination Option code: XAEG	○			○	260.00	312.00
<b>Sight and Light Pack:</b> • Automatic lighting control • Rain-sensitive windscreen wipers Option code: 5BT		○	●		245.00	

● = Standard equipment. ○ = Optional at extra cost.



# VIVARO EQUIPMENT / OPTIONS

## EXTERIOR COLOURS





			Vivaro	Sportive	Limited Edition	Combi	Price (£) exc. VAT	Total (£) inc. VAT		
	<b>Glacier White (10U)</b> <ul style="list-style-type: none"> <li>• Solid paint</li> <li>• Black alloy wheels / graphics on Limited Edition models</li> </ul>		<b>Ink Blue (23U)</b> <ul style="list-style-type: none"> <li>• Solid paint</li> <li>• H1 models only</li> <li>• Not available on Sportive / Limited Edition models or when either Appearance Pack is specified</li> </ul>		●	●	●	●		
	<b>Flame Red (79U / 79Z)</b> <ul style="list-style-type: none"> <li>• Brilliant paint</li> <li>• Black or silver alloy wheels / graphics on Limited Edition models</li> </ul>		<b>Iron Grey (10D)</b> <ul style="list-style-type: none"> <li>• Brilliant paint</li> <li>• Silver alloy wheels / graphics on Limited Edition models</li> </ul>		○	N/C	N/C	○	320.00	<b>384.00</b>
	<b>Spring Green (10G / 10Z)</b> <ul style="list-style-type: none"> <li>• Brilliant paint</li> <li>• Black alloy wheels / graphics on Limited Edition models</li> </ul>									
	<b>Panorama Blue (4UU)</b> <ul style="list-style-type: none"> <li>• Two-coat pearlescent paint</li> <li>• Silver alloy wheels / graphics on Limited Edition models</li> </ul>		<b>Midnight Black (92U)</b> <ul style="list-style-type: none"> <li>• Two-coat pearlescent paint</li> <li>• Silver alloy wheels / graphics on Limited Edition models</li> </ul>							
	<b>Cassiopeia Silver (10J)</b> <ul style="list-style-type: none"> <li>• Two-coat pearlescent paint</li> <li>• Silver alloy wheels / graphics on Limited Edition models</li> </ul>		<b>Copper Brown (10K)</b> <ul style="list-style-type: none"> <li>• Two-coat pearlescent paint</li> <li>• Silver alloy wheels / graphics on Limited Edition models</li> </ul>		○	N/C	N/C	○	450.00	<b>540.00</b>
	<b>Jasper Brown (10E)</b> <ul style="list-style-type: none"> <li>• Two-coat pearlescent paint</li> <li>• Silver alloy wheels / graphics on Limited Edition models</li> </ul>		<b>Platinum Silver (10H)</b> <ul style="list-style-type: none"> <li>• Two-coat pearlescent paint</li> <li>• Black alloy wheels / graphics on Limited Edition models</li> </ul>							

● = Standard equipment. ○ = Optional at extra cost. N/C = No-cost option.

The colours reproduced may vary slightly from the actual paint colour. As a result they should be used as a guide only. Your Vauxhall Retailer has a comprehensive display of our paint samples.



# VIVARO EQUIPMENT / OPTIONS

## WHEELS AND TYRES

	Vivaro	Sportive	Limited Edition	Combi	Price (£) exc. VAT	Total (£) inc. VAT
 <p><b>16-inch steel wheels with centre cap:</b></p> <ul style="list-style-type: none"> <li>• 205/65 R 16 tyres (1.6CDTi 95/120/125PS engines)</li> <li>• 215/65 R 16 tyres (1.6CDTi 145PS engines)</li> <li>• Full-size spare wheel</li> </ul>	●			●		
 <p><b>16-inch steel wheels with wheel trims:</b></p> <ul style="list-style-type: none"> <li>• 205/65 R 16 tyres (1.6CDTi 95/120/125PS engines)</li> <li>• 215/65 R 16 tyres (1.6CDTi 145PS engines)</li> <li>• Full-size spare wheel</li> </ul>		●				
 <p><b>17-inch black alloy wheels:</b></p> <ul style="list-style-type: none"> <li>• 215/60 R 17 tyres</li> <li>• 16-inch steel spare wheel</li> <li>– On Limited Edition models, wheel finish dependent on body colour. Please see Exterior Colours page.</li> </ul>			●			
 <p><b>17-inch silver alloy wheels:</b></p> <ul style="list-style-type: none"> <li>• 215/60 R 17 tyres</li> <li>• 16-inch steel spare wheel</li> <li>– Not available on H2 or Platform Cab models.</li> <li>– On Limited Edition models, wheel finish dependent on body colour. Please see Exterior Colours page.</li> </ul>	○	○	●	○	610.00	<b>732.00</b>
						Option code: RS6
<p><b>All-season tyres:</b></p> <ul style="list-style-type: none"> <li>• 205/65 R 16 (All engines)</li> </ul>	○	○		○	215.00	<b>258.00</b>
						Option code: NRK
<p>Tyre inflation kit in lieu of spare wheel – Not available on L2 Combi models.</p>	N/C	N/C	N/C	N/C	<b>No-cost option</b>	
						Option code: WTC

● = Standard equipment. ○ = Optional at extra cost. N/C = No-cost option.

## TYRE RATINGS

Tyre size	Fuel efficiency group	Wet grip performance	External noise	
			Measured (dB)	Group
205/65 R 16	C-E	B-E	71-72	
215/65 R 16	C	B	70	
215/60 R 17	C	B	70	

Tyre rating according to EU Regulation 1222/2009

# VIVARO EQUIPMENT / OPTIONS

## MECHANICAL

	Vivaro	Sportive	Limited Edition	Combi	Price (£) exc. VAT	Total (£) inc. VAT
<b>Transmission:</b> <i>Six-speed manual gearbox:</i> • Front-wheel drive • Transverse engine/gearbox	●	●	●	●		
<b>Steering:</b> • Hydraulic power-assisted rack and pinion system • Energy absorbing steering column <b>Turning circles:</b> <b>Kerb-to-kerb</b> FWD L1                      11.8m (38.7ft.) FWD L2                      13.2m (43.3ft.)	●	●	●	●		
<b>Brakes:</b> <i>Front ventilated disc brakes:</i> • 296mm x 28mm <i>Rear disc brakes:</i> • 280mm x 12mm	●	●	●	●		
<b>Power take-off</b> • Engine driven power take-off • Six-pin / two-pin connector for conversions Option code: V66 Option code: KPD	○	○	○	○	220.00	
<b>Fuel tank:</b> • 80 litres (17.6 gallons) capacity	●	●	●	●		
<b>AdBlue tank:</b> • 22 litres (4.8 gallons) capacity	●	●	●	●		
<b>Towing:</b> • Tow bar with 13-pin electrics • Trailer stability programme <i>- Excludes Platform Cab models. Does not suit trailers with LED lights. For trailers with LED lights use genuine Vauxhall Accessory tow bars which also include trailer stability programme. Unless specific exemptions apply, vehicles operated with a trailer, where the combined weight of the vehicle, trailer and payload exceeds 3500kg, require a digital tachograph.</i> Option code: VR2	○	○	○	○	325.00	<b>390.00</b>
<b>Electrical:</b> • 80Ah maintenance-free battery (70Ah on air conditioned models) • 185A alternator (150A on air conditioned models)	●	●	●	●		
<b>CANbus interface:</b> <i>Allows the vehicle's electrical systems to integrate with additional equipment.</i> Option code: KC6	○	○	○	○	135.00	<b>162.00</b>
Six-pin / two pin electrical connector for conversions Option code: KPD	○	○	○	○	60.00	<b>72.00</b>
<b>Front suspension:</b> • MacPherson type • Independent double wishbones • Coil springs • Gas-pressure dampers	●	●	●	●		
<b>Rear suspension:</b> • Independent four-link, progressive-rate mini-block springs • Gas-pressure dampers	●	●	●	●		

● = Standard equipment. ○ = Optional at extra cost.

# MOVANO PANEL VAN PRICES

**BEST HEAVY VAN**  
Vauxhall Movano 3500  
L2H2 FWD Eu6  
BiTurbo 145ps Eu6



Model	Minimum Mass (kg)*	Payload (kg)*	Fuel economy mpg (litres/100km)#			CO <sub>2</sub> emissions (g/km)#	Price (£) exc. VAT	On-the-road RRP (£) exc. VAT
			Urban driving	Extra-urban driving	Combined figure			
<b>L1 H1 FWD PANEL VAN (EURO 6)</b>								
2800 2.3CDTi (110PS) BlueInjection	1927	858	32.1 (8.8)	40.4 (7.0)	36.7 (7.7)	201	23775.00	<b>24653.33</b>
2800 2.3CDTi (130PS) BlueInjection	1927	858	32.1 (8.8)	40.4 (7.0)	36.7 (7.7)	201	24575.00	<b>25453.33</b>
3300 2.3CDTi (110PS) BlueInjection	1932	1353	32.1 (8.8)	40.4 (7.0)	36.7 (7.7)	201	25025.00	<b>25903.33</b>
3300 2.3CDTi (130PS) BlueInjection	1932	1353	32.1 (8.8)	40.4 (7.0)	36.7 (7.7)	201	25825.00	<b>26703.33</b>
3500 2.3CDTi (110PS) BlueInjection	1937	1548	32.1 (8.8)	40.4 (7.0)	36.7 (7.7)	201	25675.00	<b>26553.33</b>
3500 2.3CDTi (130PS) BlueInjection	1937	1548	32.1 (8.8)	40.4 (7.0)	36.7 (7.7)	201	26475.00	<b>27353.33</b>
3500 2.3CDTi BiTurbo (145PS) S/S BlueInjection	1946	1539	38.2 (7.4)	42.8 (6.6)	40.9 (6.9)	179	27585.00	<b>28463.33</b>
<b>L1 H2 FWD PANEL VAN (EURO 6)</b>								
2800 2.3CDTi (110PS) BlueInjection	1955	830	31.7 (8.9)	39.8 (7.1)	36.2 (7.8)	204	24375.00	<b>25253.33</b>
2800 2.3CDTi (130PS) BlueInjection	1955	830	31.7 (8.9)	39.8 (7.1)	36.2 (7.8)	204	25175.00	<b>26053.33</b>
3300 2.3CDTi (110PS) BlueInjection	1960	1325	31.7 (8.9)	39.8 (7.1)	36.2 (7.8)	204	25625.00	<b>26503.33</b>
3300 2.3CDTi (130PS) BlueInjection	1960	1325	31.7 (8.9)	39.8 (7.1)	36.2 (7.8)	204	26425.00	<b>27303.33</b>
3500 2.3CDTi (110PS) BlueInjection	1965	1520	31.7 (8.9)	39.8 (7.1)	36.2 (7.8)	204	26275.00	<b>27153.33</b>
3500 2.3CDTi (130PS) BlueInjection	1965	1520	31.7 (8.9)	39.8 (7.1)	36.2 (7.8)	204	27075.00	<b>27953.33</b>
3500 2.3CDTi BiTurbo (145PS) S/S BlueInjection	1974	1511	37.2 (7.6)	42.2 (6.7)	40.4 (7.0)	183	28185.00	<b>29063.33</b>
<b>L2 H2 FWD PANEL VAN (EURO 6)</b>								
3300 2.3CDTi (110PS) BlueInjection	2004	1281	31.7 (8.9)	39.8 (7.1)	36.2 (7.8)	204	26980.00	<b>27858.33</b>
3300 2.3CDTi (130PS) BlueInjection	2004	1281	31.7 (8.9)	39.8 (7.1)	36.2 (7.8)	204	27780.00	<b>28658.33</b>
3500 2.3CDTi (110PS) BlueInjection	2009	1476	31.7 (8.9)	39.8 (7.1)	36.2 (7.8)	204	27630.00	<b>28508.33</b>
3500 2.3CDTi (110PS) S/S ecoFLEX BlueInjection	2009	1476	34.9 (8.1)	39.8 (7.1)	37.7 (7.5)	194	27920.00	<b>28798.33</b>
3500 2.3CDTi (130PS) BlueInjection	2009	1476	31.7 (8.9)	39.8 (7.1)	36.2 (7.8)	204	28430.00	<b>29308.33</b>
3500 2.3CDTi BiTurbo (145PS) S/S BlueInjection	2018	1467	37.2 (7.6)	42.2 (6.7)	40.4 (7.0)	183	29540.00	<b>30418.33</b>
3500 2.3CDTi BiTurbo (170PS) S/S Tecshift BlueInjection	2018	1467	36.2 (7.8)	40.9 (6.9)	39.2 (7.2)	187	31665.00	<b>32543.33</b>
<b>L2 H3 FWD PANEL VAN (EURO 6)</b>								
3500 2.3CDTi (110PS) BlueInjection	2050	1435	31.7 (8.9)	39.8 (7.1)	36.2 (7.8)	204	28330.00	<b>29208.33</b>
3500 2.3CDTi (130PS) BlueInjection	2050	1435	31.7 (8.9)	39.8 (7.1)	36.2 (7.8)	204	29130.00	<b>30008.33</b>
3500 2.3CDTi BiTurbo (145PS) S/S BlueInjection	2059	1426	37.2 (7.6)	42.2 (6.7)	40.4 (7.0)	183	30240.00	<b>31118.33</b>
3500 2.3CDTi BiTurbo (170PS) S/S Tecshift BlueInjection	2059	1426	36.2 (7.8)	40.9 (6.9)	39.2 (7.2)	187	32365.00	<b>33243.33</b>

**Please note:** On-the-road recommended retail prices (RRP) include number plates and delivery to Retailer of £583.33 (exc. VAT), 12 months' Vehicle Excise Duty at £240.00 and new vehicle first registration fee of £55.00. Excludes fuel and insurance. S/S = Start/Stop.

Vehicles with BlueInjection technology will need regular AdBlue® top-ups also between servicing requirements. An indicator integrated into the on-board computer will warn you when you need to top up. More information under [www.vauxhall.co.uk/blueinjection](http://www.vauxhall.co.uk/blueinjection). In accordance with regulations R (EC) No. 715/2007 and R (EC) No. 692/2008 (in the versions respectively applicable).

\* = For definitions please refer to Glossary of Terms.

# = Fuel consumption information is official government environmental data, tested in accordance with the relevant EU directive. Official EU-regulated test data is provided for comparison purposes and actual performance will depend on driving style, road conditions and other non-technical factors.

# MOVANO PANEL VAN PRICES

**BEST HEAVY VAN**  
Vauxhall Movano 3500  
L2H2 FWD Eu6  
BiTurbo 145ps Eu6



Model	Minimum Mass (kg)*	Payload (kg)*	Fuel economy mpg (litres/100km)#			CO <sub>2</sub> emissions (g/km)#	Price (£) exc. VAT	On-the-road RRP (£) exc. VAT
			Urban driving	Extra-urban driving	Combined figure			
<b>L3 H2 FWD PANEL VAN (EURO 6)</b>								
3500 2.3CDTi (110PS) BlueInjection	2090	1395	31.4 (9.0)	39.2 (7.2)	35.8 (7.9)	207	28330.00	<b>29208.33</b>
3500 2.3CDTi (110PS) S/S ecoFLEX BlueInjection	2090	1395	34.4 (8.2)	39.2 (7.2)	37.2 (7.6)	197	28620.00	<b>29498.33</b>
3500 2.3CDTi (130PS) BlueInjection	2090	1395	31.4 (9.0)	39.2 (7.2)	35.8 (7.9)	207	29130.00	<b>30008.33</b>
3500 2.3CDTi BiTurbo (145PS) S/S BlueInjection	2099	1386	36.2 (7.8)	41.5 (6.8)	39.2 (7.2)	186	30240.00	<b>31118.33</b>
3500 2.3CDTi BiTurbo (170PS) S/S BlueInjection	2099	1386	36.7 (7.7)	40.4 (7.0)	38.7 (7.3)	189	31490.00	<b>32368.33</b>
3500 2.3CDTi BiTurbo (170PS) S/S Tecshift BlueInjection	2099	1386	35.8 (7.9)	40.4 (7.0)	38.7 (7.3)	189	32365.00	<b>33243.33</b>
<b>L3 H3 FWD PANEL VAN (EURO 6)</b>								
3500 2.3CDTi (110PS) BlueInjection	2130	1355	31.4 (9.0)	39.2 (7.2)	35.8 (7.9)	207	29030.00	<b>29908.33</b>
3500 2.3CDTi (130PS) BlueInjection	2130	1355	31.4 (9.0)	39.2 (7.2)	35.8 (7.9)	207	29830.00	<b>30708.33</b>
3500 2.3CDTi BiTurbo (145PS) S/S BlueInjection	2139	1346	36.2 (7.8)	41.5 (6.8)	39.2 (7.2)	186	30940.00	<b>31818.33</b>
<b>L3 H2 RWD PANEL VAN (EURO VIb data shown. EURO VIc data tba)</b>								
3500 2.3CDTi BiTurbo (130PS) BlueInjection	2356	1129	30.4 (9.3)	32.5 (8.7)	31.4 (9.0)	232	30130.00	<b>31008.33</b>
3500 2.3CDTi BiTurbo (145PS) S/S BlueInjection	2356	1129	34.4 (8.2)	34.9 (8.1)	34.4 (8.2)	212	31240.00	<b>32118.33</b>
3500 HD 2.3CDTi BiTurbo (130PS) BlueInjection	2375	1110	29.4 (9.6)	30.7 (9.2)	30.4 (9.3)	242	30730.00	<b>31608.33</b>
3500 HD 2.3CDTi BiTurbo (145PS) S/S BlueInjection	2375	1110	33.2 (8.5)	32.8 (8.6)	32.8 (8.6)	222	31840.00	<b>32718.33</b>
4500 HD 2.3CDTi BiTurbo (130PS) Tacho BlueInjection	2375	2110	N/A	N/A	N/A	N/A	32205.00	<b>33008.33</b>
4500 HD 2.3CDTi BiTurbo (163PS) S/S Tacho BlueInjection	2375	2110	N/A	N/A	N/A	N/A	34565.00	<b>35368.33</b>
<b>L3 H3 RWD PANEL VAN (EURO VIb data shown. EURO VIc data tba)</b>								
3500 2.3CDTi BiTurbo (130PS) BlueInjection	2356	1129	30.4 (9.3)	32.5 (8.7)	31.4 (9.0)	232	30830.00	<b>31708.33</b>
3500 2.3CDTi BiTurbo (145PS) S/S BlueInjection	2356	1129	34.4 (8.2)	34.9 (8.1)	34.4 (8.2)	212	31940.00	<b>32818.33</b>
3500 HD 2.3CDTi BiTurbo (130PS) BlueInjection	2408	1077	29.4 (9.6)	30.7 (9.2)	30.4 (9.3)	242	31430.00	<b>32308.33</b>
3500 HD 2.3CDTi BiTurbo (145PS) S/S BlueInjection	2408	1077	33.2 (8.5)	32.8 (8.6)	32.8 (8.6)	222	32540.00	<b>33418.33</b>
4500 HD 2.3CDTi BiTurbo (130PS) Tacho BlueInjection	2408	2077	N/A	N/A	N/A	N/A	32905.00	<b>33708.33</b>
4500 HD 2.3CDTi BiTurbo (163PS) S/S Tacho BlueInjection	2408	2077	N/A	N/A	N/A	N/A	35265.00	<b>36068.33</b>

Please note: On-the-road recommended retail prices (RRP) include number plates and delivery to Retailer of £583.33 (exc. VAT), 12 months' Vehicle Excise Duty at £240.00 and new vehicle first registration fee of £55.00. Excludes fuel and insurance. S/S = Start/Stop.

Vehicles with BlueInjection technology will need regular AdBlue® top-ups also between servicing requirements. An indicator integrated into the on-board computer will warn you when you need to top up. More information under [www.vauxhall.co.uk/blueinjection](http://www.vauxhall.co.uk/blueinjection). In accordance with regulations R (EC) No. 715/2007 and R (EC) No. 692/2008 (in the versions respectively applicable).

\* = For definitions please refer to Glossary of Terms.

# = Fuel consumption information is official government environmental data, tested in accordance with the relevant EU directive. Official EU-regulated test data is provided for comparison purposes and actual performance will depend on driving style, road conditions and other non-technical factors.

# MOVANO PANEL VAN PRICES



Model	Minimum Mass (kg)*	Payload (kg)*	Fuel economy mpg (litres/100km)#			CO <sub>2</sub> emissions (g/km)#	Price (£) exc. VAT	On-the-road RRP (£) exc. VAT
			Urban driving	Extra-urban driving	Combined figure			
<b>L4 H2 RWD PANEL VAN (EURO VIb data shown. EURO VIc data tba)</b>								
3500 2.3CDTi BiTurbo (130PS) BlueInjection	2398	1087	30.4 (9.3)	32.5 (8.7)	31.4 (9.0)	232	31030.00	<b>31908.33</b>
3500 2.3CDTi BiTurbo (145PS) S/S BlueInjection	2398	1087	34.4 (8.2)	34.9 (8.1)	34.4 (8.2)	212	32140.00	<b>33018.33</b>
3500 2.3CDTi BiTurbo (163PS) S/S BlueInjection	2398	1087	34.4 (8.2)	34.9 (8.1)	34.4 (8.2)	212	33390.00	<b>34268.33</b>
3500 HD 2.3CDTi BiTurbo (130PS) BlueInjection	2453	1032	29.4 (9.6)	30.7 (9.2)	30.4 (9.3)	242	31630.00	<b>32508.33</b>
3500 HD 2.3CDTi BiTurbo (145PS) S/S BlueInjection	2453	1032	33.2 (8.5)	32.8 (8.6)	32.8 (8.6)	222	32740.00	<b>33618.33</b>
4500 HD 2.3CDTi BiTurbo (130PS) Tacho BlueInjection	2453	2032	N/A	N/A	N/A	N/A	33105.00	<b>33908.33</b>
4500 HD 2.3CDTi BiTurbo (163PS) S/S Tacho BlueInjection	2453	2032	N/A	N/A	N/A	N/A	35465.00	<b>36268.33</b>
<b>L4 H3 RWD PANEL VAN (EURO VIb data shown. EURO VIc data tba)</b>								
3500 2.3CDTi BiTurbo (130PS) BlueInjection	2429	1056	30.4 (9.3)	32.5 (8.7)	31.4 (9.0)	232	31730.00	<b>32608.33</b>
3500 2.3CDTi BiTurbo (145PS) S/S BlueInjection	2429	1056	34.4 (8.2)	34.9 (8.1)	34.4 (8.2)	212	32840.00	<b>33718.33</b>
3500 2.3CDTi BiTurbo (163PS) S/S BlueInjection	2429	1056	34.4 (8.2)	34.9 (8.1)	34.4 (8.2)	212	34090.00	<b>34968.33</b>
3500 HD 2.3CDTi BiTurbo (130PS) BlueInjection	2495	990	29.4 (9.6)	30.7 (9.2)	30.4 (9.3)	242	32330.00	<b>33208.33</b>
3500 HD 2.3CDTi BiTurbo (145PS) S/S BlueInjection	2495	990	33.2 (8.5)	32.8 (8.6)	32.8 (8.6)	222	33440.00	<b>34318.33</b>
4500 HD 2.3CDTi BiTurbo (130PS) Tacho BlueInjection	2495	1990	N/A	N/A	N/A	N/A	33805.00	<b>34608.33</b>
4500 HD 2.3CDTi BiTurbo (163PS) S/S Tacho BlueInjection	2495	1990	N/A	N/A	N/A	N/A	36165.00	<b>36968.33</b>

Please note: On-the-road recommended retail prices (RRP) include number plates and delivery to Retailer of £583.33 (exc. VAT), 12 months' Vehicle Excise Duty at £240.00 and new vehicle first registration fee of £55.00. Excludes fuel and insurance. S/S = Start/Stop.

Vehicles with BlueInjection technology will need regular AdBlue® top-ups also between servicing requirements. An indicator integrated into the on-board computer will warn you when you need to top up. More information under [www.vauxhall.co.uk/blueinjection](http://www.vauxhall.co.uk/blueinjection). In accordance with regulations R (EC) No. 715/2007 and R (EC) No. 692/2008 (in the versions respectively applicable).

\* = For definitions please refer to Glossary of Terms.

# = Fuel consumption information is official government environmental data, tested in accordance with the relevant EU directive. Official EU-regulated test data is provided for comparison purposes and actual performance will depend on driving style, road conditions and other non-technical factors.

# MOVANO DOUBLECAB PRICES

Model	Minimum Mass (kg)*	Payload (kg)*	Fuel economy mpg (litres/100km)#			CO <sub>2</sub> emissions (g/km)#	Price (£) exc. VAT	On-the-road RRP (£) exc. VAT
			Urban driving	Extra-urban driving	Combined figure			
<b>L2 H2 FWD DOUBLECAB (EURO 6)</b>								
3500 2.3CDTi (130PS) BlueInjection	2205	1305	31.7 (8.9)	39.8 (7.1)	36.2 (7.8)	207	30080.00	<b>30958.33</b>
3500 2.3CDTi BiTurbo (145PS) S/S BlueInjection	2205	1305	36.2 (7.8)	41.5 (6.8)	39.2 (7.2)	186	31190.00	<b>32068.33</b>
3500 2.3CDTi BiTurbo (170PS) S/S Tecshift BlueInjection	2205	1305	35.8 (7.9)	40.4 (7.0)	38.7 (7.3)	189	33315.00	<b>34193.33</b>
<b>L3 H2 FWD DOUBLECAB (EURO 6)</b>								
3500 2.3CDTi (130PS) BlueInjection	2286	1224	31.7 (8.9)	39.8 (7.1)	36.2 (7.8)	207	30780.00	<b>31658.33</b>
3500 2.3CDTi BiTurbo (145PS) S/S BlueInjection	2286	1224	36.2 (7.8)	41.5 (6.8)	39.2 (7.2)	186	31890.00	<b>32768.33</b>
3500 2.3CDTi BiTurbo (170PS) S/S Tecshift BlueInjection	2286	1224	35.8 (7.9)	40.4 (7.0)	38.7 (7.3)	189	34015.00	<b>34893.33</b>
<b>L3 H2 RWD DOUBLECAB (EURO VIb data shown. EURO VIc data tba)</b>								
3500 2.3CDTi BiTurbo (130PS) BlueInjection	2459	1051	tba	tba	tba	tba	31780.00	<b>32658.33</b>
3500 2.3CDTi BiTurbo (145PS) S/S BlueInjection	2459	1051	tba	tba	tba	tba	32890.00	<b>33768.33</b>

Please note: On-the-road recommended retail prices (RRP) include number plates and delivery to Retailer of £583.33 (exc. VAT), 12 months' Vehicle Excise Duty at £240.00 and new vehicle first registration fee of £55.00. Excludes fuel and insurance.

S/S = Start/Stop.

Vehicles with BlueInjection technology will need regular AdBlue® top-ups also between servicing requirements. An indicator integrated into the on-board computer will warn you when you need to top up. More information under [www.vauxhall.co.uk/blueinjection](http://www.vauxhall.co.uk/blueinjection). In accordance with regulations R (EC) No. 715/2007 and R (EC) No. 692/2008 (in the versions respectively applicable).

\* = For definitions please refer to Glossary of Terms.

# = Fuel consumption information is official government environmental data, tested in accordance with the relevant EU directive. Official EU-regulated test data is provided for comparison purposes and actual performance will depend on driving style, road conditions and other non-technical factors.

# MOVANO CHASSIS CAB PRICES

Model	Minimum Mass (kg)*	Payload and Body Allowance (kg)*	Fuel economy mpg (litres/100km)#			CO <sub>2</sub> emissions (g/km)#	Price (£) exc. VAT	On-the-road RRP (£) exc. VAT
			Urban driving	Extra-urban driving	Combined figure			
<b>L2 H1 FWD CHASSIS CAB (EURO 6)</b>								
3500 2.3CDTi (110PS) BlueInjection	1784	1756	30.4 (9.3)	37.7 (7.5)	34.4 (8.2)	212	25930.00	<b>26808.33</b>
3500 2.3CDTi (130PS) BlueInjection	1784	1756	30.4 (9.3)	37.7 (7.5)	34.4 (8.2)	212	26730.00	<b>27608.33</b>
3500 2.3CDTi BiTurbo (145PS) S/S BlueInjection	1793	1747	35.8 (7.9)	39.8 (7.1)	38.2 (7.4)	192	27840.00	<b>28718.33</b>
<b>L3 H1 FWD CHASSIS CAB (EURO 6)</b>								
3500 2.3CDTi (110PS) BlueInjection	1810	1730	30.4 (9.3)	37.7 (7.5)	34.4 (8.2)	212	26430.00	<b>27308.33</b>
3500 2.3CDTi (130PS) BlueInjection	1810	1730	30.4 (9.3)	37.7 (7.5)	34.4 (8.2)	212	27230.00	<b>28108.33</b>
3500 2.3CDTi BiTurbo (145PS) S/S BlueInjection	1819	1721	35.8 (7.9)	39.8 (7.1)	38.2 (7.4)	192	28340.00	<b>29218.33</b>
<b>L2 H1 RWD CHASSIS CAB (EURO V1b data shown. EURO V1c data tba)</b>								
3500 2.3CDTi (130PS) BlueInjection	1928	1612	30.4 (9.3)	32.5 (8.7)	31.4 (9.0)	232	27730.00	<b>28608.33</b>
3500 2.3CDTi BiTurbo (145PS) S/S BlueInjection	1928	1612	34.4 (8.2)	34.9 (8.1)	34.4 (8.2)	212	28840.00	<b>29718.33</b>
3500 HD 2.3CDTi (130PS) BlueInjection	2095	1445	29.4 (9.6)	30.7 (9.2)	30.4 (9.3)	242	28345.00	<b>29223.33</b>
3500 HD 2.3CDTi BiTurbo (145PS) S/S BlueInjection	2095	1445	33.2 (8.5)	32.8 (8.6)	32.8 (8.6)	222	29455.00	<b>30333.33</b>
4500 HD 2.3CDTi (130PS) BlueInjection	2095	2445	N/A	N/A	N/A	N/A	29820.00	<b>30623.33</b>
4500 HD 2.3CDTi BiTurbo (163PS) S/S Tacho BlueInjection	2095	2445	N/A	N/A	N/A	N/A	32180.00	<b>32983.33</b>
<b>L3 H1 RWD CHASSIS CAB (EURO V1b data shown. EURO V1c data tba)</b>								
3500 2.3CDTi BiTurbo (130PS) BlueInjection	1979	1561	30.4 (9.3)	32.5 (8.7)	31.4 (9.0)	232	28230.00	<b>29108.33</b>
3500 2.3CDTi BiTurbo (145PS) S/S BlueInjection	1979	1561	34.4 (8.2)	34.9 (8.1)	34.4 (8.2)	212	29340.00	<b>30218.33</b>
3500 HD 2.3CDTi BiTurbo (130PS) BlueInjection	2103	1437	29.4 (9.6)	30.7 (9.2)	30.4 (9.3)	242	28830.00	<b>29708.33</b>
3500 HD 2.3CDTi BiTurbo (145PS) S/S BlueInjection	2103	1437	33.2 (8.5)	32.8 (8.6)	32.8 (8.6)	222	29940.00	<b>30818.33</b>
4500 HD 2.3CDTi BiTurbo (130PS) Tacho BlueInjection	2095	2445	N/A	N/A	N/A	N/A	30305.00	<b>31108.33</b>
4500 HD 2.3CDTi BiTurbo (163PS) S/S Tacho BlueInjection	2095	2445	N/A	N/A	N/A	N/A	32665.00	<b>33468.33</b>
<b>L4 H1 RWD CHASSIS CAB (EURO V1b data shown. EURO V1c data tba)</b>								
3500 HD 2.3CDTi BiTurbo (130PS) BlueInjection	2133	1407	29.4 (9.6)	30.7 (9.2)	30.4 (9.3)	242	29530.00	<b>30408.33</b>
3500 HD 2.3CDTi BiTurbo (145PS) S/S BlueInjection	2133	1407	33.2 (8.5)	32.8 (8.6)	32.8 (8.6)	222	30640.00	<b>31518.33</b>
4500 HD 2.3CDTi BiTurbo (130PS) Tacho BlueInjection	2133	2407	N/A	N/A	N/A	N/A	31005.00	<b>31808.33</b>
4500 HD 2.3CDTi BiTurbo (163PS) S/S Tacho BlueInjection	2133	2407	N/A	N/A	N/A	N/A	33365.00	<b>34168.33</b>

**Please note:** On-the-road recommended retail prices (RRP) include number plates and delivery to Retailer of £583.33 (exc. VAT), 12 months' Vehicle Excise Duty at £240.00 and new vehicle first registration fee of £55.00. Excludes fuel and insurance.

S/S = Start/Stop.

Vehicles with BlueInjection technology will need regular AdBlue® top-ups also between servicing requirements. An indicator integrated into the on-board computer will warn you when you need to top up. More information under [www.vauxhall.co.uk/blueinjection](http://www.vauxhall.co.uk/blueinjection). In accordance with regulations R (EC) No. 715/2007 and R (EC) No. 692/2008 (in the versions respectively applicable).

All conversions must follow 'Vauxhall Converter Requirements' including recommended dimensional data, detailed within Part 1, available at: [www.vauxhall.co.uk/conversiondata](http://www.vauxhall.co.uk/conversiondata). The weight of any fitted conversion body will have to be deducted from these figures to establish actual payload and is subject to correct weight distribution. Variations from the recommended dimensions or weights may affect the vehicle's overall centre of gravity and stability. From 29 April 2013 conversion of N1 vehicles was affected by changes to type approval - for further information refer to the VCA website (N2 vehicles were affected from 29 October 2014). For further information please contact [conversions@vauxhall.co.uk](mailto:conversions@vauxhall.co.uk)

\* = For definitions please refer to Glossary of Terms.

# = Fuel consumption information is official government environmental data, tested in accordance with the relevant EU directive. Official EU-regulated test data is provided for comparison purposes and actual performance will depend on driving style, road conditions and other non-technical factors.

**All conversions must follow 'Conversion Requirements' available on: [www.vauxhall.co.uk/conversiondata](http://www.vauxhall.co.uk/conversiondata)**



# MOVANO CREW CAB PRICES

Model	Minimum Mass (kg)*	Payload and Body Allowance (kg)*	Fuel economy mpg (litres/100km)#			CO <sub>2</sub> emissions (g/km)#	Price (£) exc. VAT	On-the-road RRP (£) exc. VAT
			Urban driving	Extra-urban driving	Combined figure			
<b>L2 H1 FWD CREW CAB (EURO 6)</b>								
3500 2.3CDTi (130PS) BlueInjection	1990	1550	30.4 (9.3)	37.7 (7.5)	34.4 (8.2)	212	27630.00	<b>28508.33</b>
3500 2.3CDTi BiTurbo (145PS) S/S BlueInjection	1999	1541	35.8 (7.9)	39.8 (7.1)	38.2 (7.4)	192	28740.00	<b>29618.33</b>
<b>L3 H1 FWD CREW CAB (EURO 6)</b>								
3500 2.3CDTi (130PS) BlueInjection	2034	1506	30.4 (9.3)	37.7 (7.5)	34.4 (8.2)	212	28130.00	<b>29008.33</b>
3500 2.3CDTi BiTurbo (145PS) S/S BlueInjection	2043	1497	35.8 (7.9)	39.8 (7.1)	38.2 (7.4)	192	29240.00	<b>30118.33</b>
<b>L2 H1 RWD CREW CAB (EURO VIb data shown. EURO VIc data tba)</b>								
3500 2.3CDTi BiTurbo (130PS) BlueInjection	2164	1376	30.4 (9.3)	32.5 (8.7)	31.4 (9.0)	232	28630.00	<b>29508.33</b>
3500 2.3CDTi BiTurbo (145PS) S/S BlueInjection	2164	1376	34.4 (8.2)	34.9 (8.1)	34.4 (8.2)	212	29740.00	<b>30618.33</b>
<b>L3 H1 RWD CREW CAB (EURO VIb data shown. EURO VIc data tba)</b>								
3500 2.3CDTi BiTurbo (130PS) BlueInjection	2197	1343	30.4 (9.3)	32.5 (8.7)	31.4 (9.0)	232	29130.00	<b>30008.33</b>
3500 2.3CDTi BiTurbo (145PS) S/S BlueInjection	2197	1343	34.4 (8.2)	34.9 (8.1)	34.4 (8.2)	212	30240.00	<b>31118.33</b>
3500 HD 2.3CDTi BiTurbo (130PS) BlueInjection	2283	1257	29.4 (9.6)	30.7 (9.2)	30.4 (9.3)	242	29730.00	<b>30608.33</b>
3500 HD 2.3CDTi BiTurbo (145PS) S/S BlueInjection	2283	1257	33.2 (8.5)	32.8 (8.6)	32.8 (8.6)	222	30840.00	<b>31718.33</b>
4500 HD 2.3CDTi BiTurbo (130PS) Tacho BlueInjection	2283	2257	N/A	N/A	N/A	N/A	31205.00	<b>32008.33</b>
4500 HD 2.3CDTi BiTurbo (163PS) S/S Tacho BlueInjection	2283	2257	N/A	N/A	N/A	N/A	33565.00	<b>34368.33</b>
<b>L4 H1 RWD CREW CAB (EURO VIb data shown. EURO VIc data tba)</b>								
3500 HD 2.3CDTi BiTurbo (130PS) BlueInjection	2352	1188	29.4 (9.6)	30.7 (9.2)	30.4 (9.3)	242	30430.00	<b>31308.33</b>
3500 HD 2.3CDTi BiTurbo (145PS) S/S BlueInjection	2352	1188	33.2 (8.5)	32.8 (8.6)	32.8 (8.6)	222	31540.00	<b>32418.33</b>
4500 HD 2.3CDTi BiTurbo (130PS) Tacho BlueInjection	2352	2188	N/A	N/A	N/A	N/A	31905.00	<b>32708.33</b>
4500 HD 2.3CDTi BiTurbo (163PS) S/S Tacho BlueInjection	2352	2188	N/A	N/A	N/A	N/A	34265.00	<b>35068.33</b>

**Please note:** On-the-road recommended retail prices (RRP) include number plates and delivery to Retailer of £583.33 (exc. VAT), 12 months' Vehicle Excise Duty at £240.00 (£165.00 on 4500kg models) and new vehicle first registration fee of £55.00. Excludes fuel and insurance.

S/S = Start/Stop.

Vehicles with BlueInjection technology will need regular AdBlue® top-ups also between servicing requirements. An indicator integrated into the on-board computer will warn you when you need to top up. More information under [www.vauxhall.co.uk/blueinjection](http://www.vauxhall.co.uk/blueinjection). In accordance with regulations R (EC) No. 715/2007 and R (EC) No. 692/2008 (in the versions respectively applicable).

All conversions must follow 'Vauxhall Converter Requirements' including recommended dimensional data, detailed within Part 1, available at: [www.vauxhall.co.uk/conversiondata](http://www.vauxhall.co.uk/conversiondata). The weight of any fitted conversion body will have to be deducted from these figures to establish actual payload and is subject to correct weight distribution. Variations from the recommended dimensions or weights may affect the vehicle's overall centre of gravity and stability. From 29 April 2013 conversion of N1 vehicles was affected by changes to type approval - for further information refer to the VCA website (N2 vehicles were affected from 29 October 2014). For further information please contact [conversions@vauxhall.co.uk](mailto:conversions@vauxhall.co.uk)

\* = For definitions please refer to Glossary of Terms.

# = Fuel consumption information is official government environmental data, tested in accordance with the relevant EU directive. Official EU-regulated test data is provided for comparison purposes and actual performance will depend on driving style, road conditions and other non-technical factors.

All conversions must follow 'Conversion Requirements' available on: [www.vauxhall.co.uk/conversiondata](http://www.vauxhall.co.uk/conversiondata)

# MOVANO PLATFORM CAB PRICES

Model	Minimum Mass (kg)*	Payload and Body Allowance (kg)*	Fuel economy mpg (litres/100km)#			CO <sub>2</sub> emissions (g/km)#	Price (£) exc. VAT	On-the-road RRP (£) exc. VAT
			Urban driving	Extra-urban driving	Combined figure			
<b>L2 H1 FWD PLATFORM CAB (EURO 6)</b>								
3500 2.3CDTi (130PS) BlueInjection	1697	1843	31.4 (9.0)	39.2 (7.2)	35.8 (7.9)	207	26730.00	<b>27608.33</b>
<b>L2 H2 FWD PLATFORM CAB (EURO 6)</b>								
3500 2.3CDTi (130PS) BlueInjection	1711	1829	31.4 (9.0)	39.2 (7.2)	35.8 (7.9)	207	27330.00	<b>28208.33</b>
<b>L3 H1 FWD PLATFORM CAB (EURO 6)</b>								
3500 2.3CDTi (110PS) BlueInjection	1719	1821	31.4 (9.0)	39.2 (7.2)	35.8 (7.9)	207	26430.00	<b>27308.33</b>
3500 2.3CDTi (130PS) BlueInjection	1719	1821	31.4 (9.0)	39.2 (7.2)	35.8 (7.9)	207	27230.00	<b>28108.33</b>
3500 2.3CDTi BiTurbo (145PS) S/S BlueInjection	1728	1812	35.8 (7.9)	39.8 (7.1)	38.2 (7.4)	192	28340.00	<b>29218.33</b>
<b>L3 H2 FWD PLATFORM CAB (EURO 6)</b>								
3500 2.3CDTi (130PS) BlueInjection	1735	1805	30.4 (9.3)	37.7 (7.5)	34.4 (8.2)	212	27830.00	<b>28708.33</b>
3500 2.3CDTi BiTurbo (145PS) S/S BlueInjection	1744	1796	35.8 (7.9)	39.8 (7.1)	38.2 (7.4)	192	28940.00	<b>29818.33</b>

Please note: On-the-road recommended retail prices (RRP) include number plates and delivery to Retailer of £583.33 (exc. VAT), 12 months' Vehicle Excise Duty at £240.00 and new vehicle first registration fee of £55.00. Excludes fuel and insurance. S/S = Start/Stop.

Vehicles with BlueInjection technology will need regular AdBlue® top-ups also between servicing requirements. An indicator integrated into the on-board computer will warn you when you need to top up. More information under [www.vauxhall.co.uk/blueinjection](http://www.vauxhall.co.uk/blueinjection). In accordance with regulations R (EC) No. 715/2007 and R (EC) No. 692/2008 (in the versions respectively applicable).

All conversions must follow 'Vauxhall Converter Requirements' including recommended dimensional data, detailed within Part 1, available at: [www.vauxhall.co.uk/conversiondata](http://www.vauxhall.co.uk/conversiondata). The weight of any fitted conversion body will have to be deducted from these figures to establish actual payload and is subject to correct weight distribution. Variations from the recommended dimensions or weights may affect the vehicle's overall centre of gravity and stability. From 29 April 2013 conversion of N1 vehicles was affected by changes to type approval – for further information refer to the VCA website (N2 vehicles were affected from 29 October 2014). For further information please contact [conversions@vauxhall.co.uk](mailto:conversions@vauxhall.co.uk)

\* = For definitions please refer to Glossary of Terms.

# = Fuel consumption information is official government environmental data, tested in accordance with the relevant EU directive. Official EU-regulated test data is provided for comparison purposes and actual performance will depend on driving style, road conditions and other non-technical factors.

All conversions must follow 'Conversion Requirements' available on: [www.vauxhall.co.uk/conversiondata](http://www.vauxhall.co.uk/conversiondata)

# MOVANO TIPPER PRICES

Model	Minimum Mass (kg)*	Payload (kg)*	Fuel economy mpg (litres/100km)#			CO <sub>2</sub> emissions (g/km)#	Price (£) exc. VAT	On-the-road RRP (£) exc. VAT
			Urban driving	Extra-urban driving	Combined figure			
<b>L2 H1 FWD CHASSIS CAB TIPPER (EURO 6)</b>								
3500 2.3CDTi (130PS) BlueInjection	2381	1159	31.4 (9.0)	39.2 (7.2)	35.8 (7.9)	207	30480.00	<b>31358.33</b>
3500 2.3CDTi BiTurbo (145PS) S/S BlueInjection	2391	1149	36.2 (7.8)	40.4 (7.0)	38.7 (7.3)	189	31590.00	<b>32468.33</b>
3500 2.3CDTi BiTurbo (170PS) S/S BlueInjection	2391	1149	35.8 (7.9)	39.8 (7.1)	38.2 (7.4)	192	32840.00	<b>33718.33</b>
<b>L2 H1 RWD CHASSIS CAB TIPPER (EURO VIb data shown. EURO VIc data tba)</b>								
3500 HD 2.3CDTi BiTurbo (130PS) BlueInjection	2661	879	29.4 (9.6)	30.7 (9.2)	30.4 (9.3)	242	32080.00	<b>32958.33</b>
3500 HD 2.3CDTi BiTurbo (145PS) S/S BlueInjection	2661	879	33.2 (8.5)	32.8 (8.6)	32.8 (8.6)	222	33190.00	<b>34068.33</b>
3500 HD 2.3CDTi BiTurbo (163PS) S/S BlueInjection	2661	879	33.2 (8.5)	32.8 (8.6)	32.8 (8.6)	222	34440.00	<b>35318.33</b>
4500 HD 2.3CDTi BiTurbo (130PS) Tacho BlueInjection	2661	1879	N/A	N/A	N/A	N/A	33555.00	<b>34358.33</b>
4500 HD 2.3CDTi BiTurbo (163PS) S/S Tacho BlueInjection	2661	1879	N/A	N/A	N/A	N/A	35915.00	<b>36718.33</b>
<b>L3 H1 RWD CHASSIS CAB TIPPER (EURO VIb data shown. EURO VIc data tba)</b>								
3500 HD 2.3CDTi BiTurbo (130PS) BlueInjection	2773	767	29.4 (9.6)	30.7 (9.2)	30.4 (9.3)	242	33780.00	<b>34658.33</b>
3500 HD 2.3CDTi BiTurbo (145PS) S/S BlueInjection	2773	767	33.2 (8.5)	32.8 (8.6)	32.8 (8.6)	222	34890.00	<b>35768.33</b>
4500 HD 2.3CDTi BiTurbo (130PS) Tacho BlueInjection	2773	1767	N/A	N/A	N/A	N/A	35255.00	<b>36058.33</b>
4500 HD 2.3CDTi BiTurbo (163PS) S/S Tacho BlueInjection	2773	1767	N/A	N/A	N/A	N/A	37615.00	<b>38418.33</b>
<b>L3 H1 FWD CREW CAB TIPPER (EURO 6)</b>								
3500 2.3CDTi (130PS) BlueInjection	2511	1029	30.7 (9.2)	38.2 (7.4)	34.9 (8.1)	210	31880.00	<b>32758.33</b>
3500 2.3CDTi BiTurbo (145PS) S/S BlueInjection	2520	1020	36.2 (7.8)	40.4 (7.0)	38.7 (7.3)	189	32990.00	<b>33868.33</b>
<b>L3 H1 RWD CREW CAB TIPPER (EURO VIb data shown. EURO VIc data tba)</b>								
4500 HD 2.3CDTi BiTurbo (130PS) Tacho BlueInjection	2830	1560	N/A	N/A	N/A	N/A	34955.00	<b>35758.33</b>
4500 HD 2.3CDTi BiTurbo (163PS) S/S Tacho BlueInjection	2830	1560	N/A	N/A	N/A	N/A	37315.00	<b>38118.33</b>

**Please note:** On-the-road recommended retail prices (RRP) include number plates and delivery to Retailer of £583.33 (exc. VAT), 12 months' Vehicle Excise Duty at £240.00 (£165.00 on 4500kg models) and new vehicle first registration fee of £55.00. Excludes fuel and insurance. S/S = Start/Stop.

Vehicles with BlueInjection technology will need regular AdBlue® top-ups also between servicing requirements. An indicator integrated into the on-board computer will warn you when you need to top up. More information under [www.vauxhall.co.uk/blueinjection](http://www.vauxhall.co.uk/blueinjection). In accordance with regulations R (EC) No. 715/2007 and R (EC) No. 692/2008 (in the versions respectively applicable).

\* = For definitions please refer to Glossary of Terms.

# = Fuel consumption information is official government environmental data, tested in accordance with the relevant EU directive. Official EU-regulated test data is provided for comparison purposes and actual performance will depend on driving style, road conditions and other non-technical factors.

# MOVANO DROPSIDE PRICES

Model	Minimum Mass (kg)*	Payload (kg)*	Fuel economy mpg (litres/100km)#			CO <sub>2</sub> emissions (g/km)#	Price (£) exc. VAT	On-the-road RRP (£) exc. VAT
			Urban driving	Extra-urban driving	Combined figure			
<b>L2 H1 FWD CHASSIS CAB DROPSIDE (EURO 6)</b>								
3500 2.3CDTi (130PS) BlueInjection	2156	1384	31.7 (8.9)	39.8 (7.1)	36.2 (7.8)	204	28680.00	<b>29558.33</b>
3500 2.3CDTi BiTurbo (145PS) S/S BlueInjection	2166	1374	37.2 (7.6)	42.2 (6.7)	40.4 (7.0)	183	29790.00	<b>30668.33</b>
<b>L3 H1 FWD CHASSIS CAB DROPSIDE (EURO 6)</b>								
3500 2.3CDTi (130PS) BlueInjection	2228	1312	31.4 (9.0)	39.2 (7.2)	35.8 (7.9)	207	29680.00	<b>30558.33</b>
3500 2.3CDTi BiTurbo (145PS) S/S BlueInjection	2237	1303	36.2 (7.8)	41.5 (6.8)	39.2 (7.2)	186	30790.00	<b>31668.33</b>
<b>L2 H1 RWD CHASSIS CAB DROPSIDE (EURO VIb data shown. EURO VIc data tba)</b>								
3500 2.3CDTi BiTurbo (130PS) BlueInjection	2354	1186	30.4 (9.3)	32.5 (8.7)	31.4 (9.0)	232	29680.00	<b>30558.33</b>
3500 2.3CDTi BiTurbo (145PS) S/S BlueInjection	2356	1184	34.4 (8.2)	34.9 (8.1)	34.4 (8.2)	212	30790.00	<b>31668.33</b>
3500 HD 2.3CDTi BiTurbo (130PS) BlueInjection	2447	1093	29.4 (9.6)	30.7 (9.2)	30.4 (9.3)	242	30295.00	<b>31173.33</b>
3500 HD 2.3CDTi BiTurbo (145PS) S/S BlueInjection	2447	1093	33.2 (8.5)	32.8 (8.6)	32.8 (8.6)	222	31405.00	<b>32283.33</b>
4500 HD 2.3CDTi BiTurbo (130PS) Tacho BlueInjection	2447	2093	N/A	N/A	N/A	N/A	31770.00	<b>32573.33</b>
4500 HD 2.3CDTi BiTurbo (163PS) S/S Tacho BlueInjection	2447	2093	N/A	N/A	N/A	N/A	34130.00	<b>34933.33</b>
<b>L3 H1 RWD CHASSIS CAB DROPSIDE (EURO VIb data shown. EURO VIc data tba)</b>								
3500 HD 2.3CDTi BiTurbo (130PS) BlueInjection	2491	1049	29.4 (9.6)	30.7 (9.2)	30.4 (9.3)	242	31280.00	<b>32158.33</b>
3500 HD 2.3CDTi BiTurbo (145PS) S/S BlueInjection	2491	1049	33.2 (8.5)	32.8 (8.6)	32.8 (8.6)	222	32390.00	<b>33268.33</b>
4500 HD 2.3CDTi BiTurbo (130PS) Tacho BlueInjection	2496	2044	N/A	N/A	N/A	N/A	32755.00	<b>33558.33</b>
4500 HD 2.3CDTi BiTurbo (163PS) S/S Tacho BlueInjection	2496	2044	N/A	N/A	N/A	N/A	35115.00	<b>35918.33</b>
<b>L4 H1 RWD CHASSIS CAB DROPSIDE (EURO VIb data shown. EURO VIc data tba)</b>								
3500 HD 2.3CDTi BiTurbo (130PS) BlueInjection	2576	964	29.4 (9.6)	30.7 (9.2)	30.4 (9.3)	242	31980.00	<b>32858.33</b>
3500 HD 2.3CDTi BiTurbo (145PS) S/S BlueInjection	2576	964	33.2 (8.5)	32.8 (8.6)	32.8 (8.6)	222	33090.00	<b>33968.33</b>
4500 HD 2.3CDTi BiTurbo (130PS) Tacho BlueInjection	2581	1959	N/A	N/A	N/A	N/A	33455.00	<b>34258.33</b>
4500 HD 2.3CDTi BiTurbo (163PS) S/S Tacho BlueInjection	2581	1959	N/A	N/A	N/A	N/A	35815.00	<b>36618.33</b>

Please note: On-the-road recommended retail prices (RRP) include number plates and delivery to Retailer of £583.33 (exc. VAT), 12 months' Vehicle Excise Duty at £240.00 (£165.00 on 4500kg models) and new vehicle first registration fee of £55.00. Excludes fuel and insurance.

S/S = Start/Stop.

Vehicles with BlueInjection technology will need regular AdBlue® top-ups also between servicing requirements. An indicator integrated into the on-board computer will warn you when you need to top up. More information under [www.vauxhall.co.uk/blueinjection](http://www.vauxhall.co.uk/blueinjection). In accordance with regulations R (EC) No. 715/2007 and R (EC) No. 692/2008 (in the versions respectively applicable).

\* = For definitions please refer to Glossary of Terms.

# = Fuel consumption information is official government environmental data, tested in accordance with the relevant EU directive. Official EU-regulated test data is provided for comparison purposes and actual performance will depend on driving style, road conditions and other non-technical factors.

# MOVANO DROPSIDE PRICES

Model	Minimum Mass (kg)*	Payload (kg)*	Fuel economy mpg (litres/100km)#			CO <sub>2</sub> emissions (g/km)#	Price (£) exc. VAT	On-the-road RRP (£) exc. VAT
			Urban driving	Extra-urban driving	Combined figure			
<b>L2 H1 FWD CREW CAB DROPSIDE (EURO 6)</b>								
3500 2.3CDTi (130PS) BlueInjection	2313	1227	31.4 (9.0)	39.2 (7.2)	35.8 (7.9)	207	29580.00	<b>30458.33</b>
3500 2.3CDTi BiTurbo (145PS) S/S BlueInjection	2322	1218	36.2 (7.8)	41.5 (6.8)	39.2 (7.2)	186	30690.00	<b>31568.33</b>
<b>L3 H1 FWD CREW CAB DROPSIDE (EURO 6)</b>								
3500 2.3CDTi (130PS) BlueInjection	2384	1156	31.4 (9.0)	39.2 (7.2)	35.8 (7.9)	207	30080.00	<b>30958.33</b>
3500 2.3CDTi BiTurbo (145PS) S/S BlueInjection	2393	1147	36.2 (7.8)	41.5 (6.8)	39.2 (7.2)	186	31190.00	<b>32068.33</b>
3500 2.3CDTi BiTurbo (170PS) S/S BlueInjection	2393	1147	36.7 (7.7)	40.4 (7.0)	38.7 (7.3)	189	32440.00	<b>33318.33</b>
<b>L2 H1 RWD CREW CAB DROPSIDE (EURO VIb data shown. EURO VIc data tba)</b>								
3500 2.3CDTi BiTurbo (130PS) BlueInjection	2471	1069	30.4 (9.3)	32.5 (8.7)	31.4 (9.0)	232	30580.00	<b>31458.33</b>
3500 2.3CDTi BiTurbo (145PS) S/S BlueInjection	2471	1069	34.4 (8.2)	34.9 (8.1)	34.4 (8.2)	212	31690.00	<b>32568.33</b>
<b>L3 H1 RWD CREW CAB DROPSIDE (EURO VIb data shown. EURO VIc data tba)</b>								
4500 HD 2.3CDTi BiTurbo (130PS) Tacho BlueInjection	2642	1748	N/A	N/A	N/A	N/A	33155.00	<b>33958.33</b>
4500 HD 2.3CDTi BiTurbo (163PS) S/S Tacho BlueInjection	2642	1748	N/A	N/A	N/A	N/A	35515.00	<b>36318.33</b>
<b>L4 H1 RWD CREW CAB DROPSIDE (EURO VIb data shown. EURO VIc data tba)</b>								
4500 HD 2.3CDTi BiTurbo (130PS) Tacho BlueInjection	2626	1914	N/A	N/A	N/A	N/A	34355.00	<b>35158.33</b>
4500 HD 2.3CDTi BiTurbo (163PS) S/S Tacho BlueInjection	2626	1914	N/A	N/A	N/A	N/A	36715.00	<b>37518.33</b>

Please note: On-the-road recommended retail prices (RRP) include number plates and delivery to Retailer of £583.33 (exc. VAT), 12 months' Vehicle Excise Duty at £240.00 (£165.00 on 4500kg models) and new vehicle first registration fee of £55.00. Excludes fuel and insurance. S/S = Start/Stop.

Vehicles with BlueInjection technology will need regular AdBlue® top-ups also between servicing requirements. An indicator integrated into the on-board computer will warn you when you need to top up. More information under [www.vauxhall.co.uk/blueinjection](http://www.vauxhall.co.uk/blueinjection). In accordance with regulations R (EC) No. 715/2007 and R (EC) No. 692/2008 (in the versions respectively applicable).

\* = For definitions please refer to Glossary of Terms.

# = Fuel consumption information is official government environmental data, tested in accordance with the relevant EU directive. Official EU-regulated test data is provided for comparison purposes and actual performance will depend on driving style, road conditions and other non-technical factors.

# MOVANO BOX VAN PRICES

Model	Minimum Mass (kg)*	Payload (kg)*	Fuel economy mpg (litres/100km)#			CO <sub>2</sub> emissions (g/km)#	Price (£) exc. VAT	On-the-road RRP (£) exc. VAT
			Urban driving	Extra-urban driving	Combined figure			
<b>L3 H1 FWD CHASSIS CAB BOX VAN 20 cu.m (EURO 6)</b>								
3500 2.3CDTi (130PS) BlueInjection	2400	1140	30.7 (9.2)	38.2 (7.4)	34.9 (8.1)	210	32910.00	<b>33788.33</b>
3500 2.3CDTi BiTurbo (145PS) S/S BlueInjection	2400	1140	36.2 (7.8)	40.4 (7.0)	38.7 (7.3)	189	34020.00	<b>34898.33</b>
3500 2.3CDTi (170PS) BiTurbo S/S BlueInjection	2400	1140	35.8 (7.9)	39.8 (7.1)	38.2 (7.4)	192	35270.00	<b>36148.33</b>
<b>L3 H1 RWD CHASSIS CAB BOX VAN 20 cu.m (EURO VIb data shown. EURO VIc data tba)</b>								
3500 2.3CDTi BiTurbo (130PS) BlueInjection	2560	980	30.4 (9.3)	32.5 (8.7)	31.4 (9.0)	232	35110.00	<b>35988.33</b>
3500 2.3CDTi BiTurbo (145PS) S/S BlueInjection	2560	980	34.4 (8.2)	34.9 (8.1)	34.4 (8.2)	212	36220.00	<b>37098.33</b>
3500 2.3CDTi BiTurbo (163PS) S/S BlueInjection	2560	980	34.4 (8.2)	34.9 (8.1)	34.4 (8.2)	212	37470.00	<b>38348.33</b>
<b>L4 H1 RWD CHASSIS CAB BOX VAN 20 cu.m (EURO VIb data shown. EURO VIc data tba)</b>								
3500 HD 2.3CDTi BiTurbo (130PS) BlueInjection	2735	805	29.4 (9.6)	30.7 (9.2)	30.4 (9.3)	242	35360.00	<b>36238.33</b>
3500 HD 2.3CDTi BiTurbo (145PS) S/S BlueInjection	2735	805	33.2 (8.5)	32.8 (8.6)	32.8 (8.6)	222	36470.00	<b>37348.33</b>
4500 HD 2.3CDTi BiTurbo (130PS) Tacho BlueInjection	2760	1805	N/A	N/A	N/A	N/A	36835.00	<b>37638.33</b>
4500 HD 2.3CDTi BiTurbo (163PS) S/S Tacho BlueInjection	2760	1805	N/A	N/A	N/A	N/A	39195.00	<b>39998.33</b>
<b>L4 H1 RWD CHASSIS CAB BOX VAN 22 cu.m (EURO VIb data shown. EURO VIc data tba)</b>								
3500 HD 2.3CDTi (130PS) BlueInjection	2735	780	29.4 (9.6)	30.7 (9.2)	30.4 (9.3)	242	35560.00	<b>36438.33</b>
3500 HD 2.3CDTi BiTurbo (145PS) S/S BlueInjection	2735	780	33.2 (8.5)	32.8 (8.6)	32.8 (8.6)	222	36670.00	<b>37548.33</b>

Please note: On-the-road recommended retail prices (RRP) include number plates and delivery to Retailer of £583.33 (exc. VAT), 12 months' Vehicle Excise Duty at £240.00 (£165.00 on 4500kg models) and new vehicle first registration fee of £55.00. Excludes fuel and insurance. S/S = Start/Stop.

Vehicles with BlueInjection technology will need regular AdBlue® top-ups also between servicing requirements. An indicator integrated into the on-board computer will warn you when you need to top up. More information under [www.vauxhall.co.uk/blueinjection](http://www.vauxhall.co.uk/blueinjection). In accordance with regulations R (EC) No. 715/2007 and R (EC) No. 692/2008 (in the versions respectively applicable).

\* = For definitions please refer to Glossary of Terms.

# = Fuel consumption information is official government environmental data, tested in accordance with the relevant EU directive. Official EU-regulated test data is provided for comparison purposes and actual performance will depend on driving style, road conditions and other non-technical factors.

# MOVANO COMBI / MINIBUS PRICES

Model	Minimum Mass (kg)*	Payload (kg)*	Fuel economy mpg (litres/100km)#			CO <sub>2</sub> emissions (g/km)#	Price (£) exc. VAT	On-the-road RRP (£) inc. VAT
			Urban driving	Extra-urban driving	Combined figure			
<b>L1 H1 FWD 9-SEAT COMBI (EURO 6)</b>								
3300 2.3CDTi (110PS) S/S ecoFLEX BlueInjection	2074	1141	35.8 (7.9)	45.6 (6.2)	41.5 (6.8)	176	26195.83	<b>32990.00</b>
<b>L2 H2 FWD 9-SEAT COMBI (EURO 6)</b>								
3500 2.3CDTi (110PS) S/S ecoFLEX BlueInjection	2184	1231	34.9 (8.1)	44.8 (6.3)	40.9 (6.9)	179	28804.17	<b>36120.00</b>
3500 2.3CDTi BiTurbo (145PS) S/S BlueInjection	2184	1231	37.7 (7.5)	46.3 (6.1)	42.8 (6.6)	173	29066.67	<b>36435.00</b>
3500 2.3CDTi BiTurbo (170PS) S/S BlueInjection	2184	1231	37.7 (7.5)	46.3 (6.1)	42.8 (6.6)	173	30316.67	<b>37935.00</b>
<b>L3 H2 FWD 17-SEAT MINIBUS (EURO VIb data shown. EURO VIc data tba)</b>								
3900 2.3CDTi BiTurbo (145PS) S/S Tacho BlueInjection	2660	1340	N/A (M2)	N/A (M2)	N/A (M2)	N/A (M2)	34529.17	<b>42355.00</b>

**Please note:** On-the-road recommended retail prices (RRP) include number plates and delivery to Retailer of £583.33 (exc. VAT), 12 months' Vehicle Excise Duty at £800.00 on Combi and £165.00 on Minibus models and new vehicle first registration fee of £55.00. Excludes fuel and insurance. S/S = Start/Stop.

Vehicles with BlueInjection technology will need regular AdBlue® top-ups also between servicing requirements. An indicator integrated into the on-board computer will warn you when you need to top up. More information under [www.vauxhall.co.uk/blueinjection](http://www.vauxhall.co.uk/blueinjection). In accordance with regulations R (EC) No. 715/2007 and R (EC) No. 692/2008 (in the versions respectively applicable).

\* = For definitions please refer to Glossary of Terms.

# = Fuel consumption information is official government environmental data, tested in accordance with the relevant EU directive. Official EU-regulated test data is provided for comparison purposes and actual performance will depend on driving style, road conditions and other non-technical factors.

# MOVANO TRABUS PRICES/FEATURES

Model	Minimum Mass (kg)*	Payload and Body Allowance (kg)*	Fuel economy mpg (litres/100km)#			CO <sub>2</sub> emissions (g/km)#	Price (£) exc. VAT	On-the-road RRP (£) exc. VAT
			Urban driving	Extra-urban driving	Combined figure			
<b>L2 H2 FWD TRABUS (EURO VIb data shown. EURO VIc data tba)</b>								
3900 2.3CDTi BiTurbo (145PS) S/S BlueInjection	2093	1837	N/A (M2)	N/A (M2)	N/A (M2)	N/A (M2)	30640.00	<b>31443.33</b>
<b>L3 H2 FWD TRABUS (EURO VIb data shown. EURO VIc data tba)</b>								
3900 2.3CDTi BiTurbo (145PS) S/S BlueInjection	2171	1759	N/A (M2)	N/A (M2)	N/A (M2)	N/A (M2)	31190.00	<b>31993.33</b>

**Please note:** On-the-road recommended retail prices (RRP) include number plates and delivery to Retailer of £583.33 (exc. VAT), 12 months' Vehicle Excise Duty at £165.00 and new vehicle first registration fee of £55.00. Excludes fuel and insurance. S/S = Start/Stop.

Vehicles with BlueInjection technology will need regular AdBlue® top-ups also between servicing requirements. An indicator integrated into the on-board computer will warn you when you need to top up. More information under [www.vauxhall.co.uk/blueinjection](http://www.vauxhall.co.uk/blueinjection). In accordance with regulations R (EC) No. 715/2007 and R (EC) No. 692/2008 (in the versions respectively applicable).

All conversions must follow 'Vauxhall Convertor Requirements' including recommended dimensional data, detailed within Part 1, available at: [www.vauxhall.co.uk/conversiondata](http://www.vauxhall.co.uk/conversiondata). The weight of any fitted conversion body will have to be deducted from these figures to establish actual payload and is subject to correct weight distribution. Variations from the recommended dimensions or weights may affect the vehicle's overall centre of gravity and stability. From 29 April 2013 conversion of N1 vehicles was affected by changes to type approval – for further information refer to the VCA website (N2 vehicles were affected from 29 October 2014). For further information please contact [conversions@vauxhall.co.uk](mailto:conversions@vauxhall.co.uk)

\* = For definitions please refer to Glossary of Terms.

# = Fuel consumption information is official government environmental data, tested in accordance with the relevant EU directive. Official EU-regulated test data is provided for comparison purposes and actual performance will depend on driving style, road conditions and other non-technical factors.

The Vauxhall Trabus is a fully glazed panel van without bulkhead suitable for conversion into a passenger vehicle by a third-party Convertor. The Trabus includes basic Type Approval for registration as a Category M\* Passenger Vehicle and 2nd stage Type Approval must be completed by the Convertor to enable registration. Available in two wheelbases the Trabus is fitted with the highly efficient and economical 2.3CDTi BiTurbo Euro VI engine with Start/Stop. There are no interior seats or internal trim within the load compartment.

#### Movano Trabus feature highlights:

- Type-approved for Euro VI Category M emissions
- Driver's airbag
- Electronic stability programme
- Six-way adjustable driver's seat with armrest
- Dual front passengers' bench seat with dump latch facility
- Pulse cloth trim for front seats
- Digital Tachograph
- 62mph hardcoded Speed Limiter
- Front fog lights
- High beam assist
- Lane departure warning
- Multi-function trip computer
- Bulkhead not fitted
- Digital radio/CD/MP3 CD player/stereo radio/aux-in socket/Bluetooth® connectivity for compatible mobile phones/USB connectivity/integrated display/four 15-watt speakers (CD 16 DAB BT USB)
- No second or third-row seating
- Fixed windows – nearside and offside rear panels
- Selective door locking with three-button key
- Uprated battery (110Ah)
- Glazed rear doors (90°/180° opening)
- Under-floor full-size spare wheel
- Centre wheel covers (full-diameter wheel covers optional)
- Nearside sliding side-access door and opposite panel with fixed windows

\* = M1 or M2 dependent on passenger configuration.

All conversions must follow 'Conversion Requirements' available on: [www.vauxhall.co.uk/conversiondata](http://www.vauxhall.co.uk/conversiondata)



# MOVANO EQUIPMENT / OPTIONS

		Price (£) exc. VAT	Total (£) inc. VAT
<b>SAFETY</b>			
<b>Airbags:</b>			
Driver's airbag	●		
Front passengers' airbag:			
• Front passengers' airbag with deactivation switch – Not available with Convenience Pack option.	○	260.00	312.00
			Option code: AK5
<b>Stability:</b>			
<b>Electronic Stability Programme-plus (ESP-plus) with traction control</b> – Works in conjunction with the vehicle's electronic braking and engine systems to keep the vehicle stable in many different situations. ESP monitors a variety of inputs to determine when the vehicle starts to lose traction, it can then immediately respond by varying the brake pressure between up to three wheels and adjust the engine output to help correct the loss of traction and improve stability.	●		
<b>Anti-lock braking:</b>			
<b>Four-channel Anti-lock Braking System (ABS)</b> – Prevents the vehicle's wheels from locking up under heavy braking by momentarily reducing brake pressure at the appropriate wheel, ensuring that you can maintain control of the steering.	●		
<b>Emergency brake assist</b> – When emergency braking is detected the vehicle automatically applies the maximum possible braking assistance.			
<b>Electronic brakeforce distribution</b> – Automatically apportions the optimum braking force to each wheel.			
<b>Hill start assist</b> – Briefly maintains rear brake pressure to stop the vehicle rolling back on an incline.			
<b>Advanced Safety Assist Pack:</b>			
• Front fog lights • High beam headlight assist • Lane departure warning • Multi-function trip computer – Not available with Lighting Pack option. – Standard on Minibus / Trabus / RWD HD 4500 models.	○	395.00	474.00
			Option code: XYCO
<b>Bulkhead:</b>			
• Full-height steel bulkhead without window – Standard on Panel Van / optional on Platform Cab models.	○	135.00	
			Option code: AX6
• Full-height ABS plastic bulkhead with window – Doublecab only.	●		
Full-height steel bulkhead with window – Standard on Chassis / Crew Cab models. Optional on Panel Van / Platform Cab models.	○	50.00	
			Option code: AX9
Protection grille for bulkhead window	○	305.00	
			Option code: XBEO
<b>SECURITY</b>			
<b>Features:</b>			
• Electronic engine deadlock immobiliser • Steering column lock • Secure fuel filler flap	●		
• Internal lockable rear and sliding side-access doors • Under-floor spare wheel storage – Wind down only when rear doors opened. – Standard on Panel Van / Doublecab.	●		
<b>Remote control door locking (features depending on body type):</b>			
• Selective door locking • Two keys with integral remote • Door deadlocks	●		
• Third key with integral remote	○	60.00	72.00
			Option code: K69
<b>Security alarm system:</b>			
• Engine compartment protection • Ultrasonic detectors in load area • Siren • Thatcham Category 1 approved (TCL1-101/1103) – Not available on Platform Cab / Combi / Minibus / Trabus models.	○	305.00	
			Option code: UA6

● = Standard equipment. ○ = Optional at extra cost.

# MOVANO EQUIPMENT / OPTIONS

## COMFORT AND SEATING

		Price (£) exc. VAT	Total (£) inc. VAT
<b>Comfort:</b> • Height-adjustable steering wheel • Facia-mounted gear lever • Floor-mounted handbrake lever • Pulse cloth seat trim • Vinyl floor covering • Inertia-reel lap and diagonal seatbelts • Height-adjustable outer front seatbelts	●		
<b>Vinyl seat trim:</b> • Grey vinyl seat trim – Not available with Convenience Pack / Construction Pack / air-suspended driver's seat options / dual front passengers' multi-function office bench seat. – Not available on Minibus / Trabus models. Option code: TACQ	N/C		<b>No-cost option</b>
<b>Driver's seat:</b> • Height • Reach • Backrest recline • Height-adjustable padded head restraint • Driver's seat armrest	●		
<b>'Comfort' driver's seat:</b> • Lumbar adjustment • Height • Reach • Backrest recline • Height-adjustable padded head restraint • Centre fold-away armrest – Not available with Construction Pack option. L4 R3500 HD Dropside models. Option code: B21	○	135.00	<b>162.00</b>
<b>Air-suspended driver's seat:</b> • Lumbar adjustment • Height • Reach • Backrest recline • Height-adjustable padded head restraint • Centre fold-away armrest – Not available with vinyl seat trim option. – Not available on L2 Doublecab / Tipper / Combi / Minibus models. Option code: A5Z	○	410.00	<b>492.00</b>
<b>Dual front passengers' bench seat:</b> • Fixed position bench seat and backrest • Centre seat features flat-folding backrest with twin drinks holders, flat work surface and storage tray • Height-adjustable outer front padded head restraint • Fixed centre seat padded head restraint	●		
<b>Single front passenger's seat:</b> • Reach • Backrest recline • Height-adjustable padded head restraint – Not available on Minibus or with Convenience Pack option. Please note: On Combi models this option reduces CO <sub>2</sub> emissions which may result in a reduction in Vehicle Excise Duty. Option code: AE1	N/C		<b>No-cost option</b>
<b>Single 'Comfort' front passenger's seat:</b> • Lumbar adjustment • Reach • Backrest recline • Height-adjustable padded head restraint • Centre fold-away armrest – Only available with driver's comfort / air-suspended driver's seat options. – Not available on Minibus. Please note: On Combi models this option reduces CO <sub>2</sub> emissions which may result in a reduction in Vehicle Excise Duty. Option code: AHZ	○	60.00	<b>72.00</b>
<b>Convenience Pack:</b> • 'Comfort' driver's seat with armrest and lumbar support • Multi-function office bench seat with folding seat back on centre passenger seat including swivelling work tray and tilt forward seat cushions with underseat storage • Retractable A4 facia document clip • 'One-touch down' facility for driver's electrically operated window • Bulkhead soundproofing (Panel Van only) – Not available Crew Van / Combi / Minibus / Trabus models. Option code: XiC6	○	185.00	

## SEATING – DOUBLECAB

<b>Rear seating:</b> • Four-individually contoured rear seats • Inertia-reel lap and diagonal seatbelts • Padded head restraints • Integrated storage nets and cup holders • Full-length tray under rear seat cushion – Standard on Doublecab. • Side and overhead rear seat storage pockets – Doublecab only. Option code: D29	●		
	○	70.00	

● = Standard equipment. ○ = Optional at extra cost. N/C = No-cost option.

# MOVANO EQUIPMENT / OPTIONS

## CABIN STORAGE

		Price (£) exc. VAT	Total (£) inc. VAT
<b>Accessory sockets:</b>	●		
• 12-volt accessory socket beside gear lever			
<b>Facia storage:</b>	●		
• Driver's coin, ticket and card holder • Driver's oddments storage • Lidded glovebox (11-litre capacity) • Central drinks holder			
• Front passenger semi-covered document tray			
<b>Front door pockets:</b>	●		
• Large door pocket with capacity for a 2-litre drink bottle • Oddments pocket			
<b>Additional storage:</b>	●		
• Overhead storage shelf			
<b>Smoker Pack:</b>	○	50.00	<b>60.00</b>
• Removable ashtray • Illuminated cigar lighter			
		Option code: DT4	

## DRIVER ASSISTANCE

<b>Windscreen wipers:</b>	●		
• Two-speed windscreen wipers • Variable intermittent wipe • Electric screenwash			
<b>Parking assistance:</b>			
• Rear-view camera – <i>Panel Van / Doublecab / Combi models.</i>	○	760.00	<b>912.00</b>
		Option code: UVC	
• Rear parking distance sensors – <i>Not available on Chassis / Crew / Platform Cab models or derivatives.</i>	○	275.00	<b>330.00</b>
		Option code: UD7	
• Rear-view camera • Rear parking distance sensors – <i>Panel Van / Doublecab / Combi models.</i>	○	1025.00	<b>1230.00</b>
		Option code: UCI	
• Nearside blind-spot / junction mirror located in front passenger sunvisor	●		
<b>Cruise control, speed limiter and multi-function trip computer:</b>			
• Cruise control • Trip odometer • Vehicle range based on remaining fuel • Average speed • Average fuel economy • Instantaneous fuel economy	○	260.00	<b>312.00</b>
• Driving time			
		Option code: K34	
<b>Speed limiter:</b>			
• Choice of three speeds: 56mph / 62mph / 68mph	○	85.00	<b>102.00</b>
– 56mph speed limiter standard on RWD HD 4500 models.			
– 62mph speed limiter standard on Minibus / Trabus.			
		Option code: (56mph) KYJ	
		Option code: (62mph) KYK	
		Option code: (68mph) KYL	

● = Standard equipment. ○ = Optional at extra cost.

# MOVANO EQUIPMENT / OPTIONS

## DRIVER INFORMATION

		Price (£) exc. VAT	Total (£) inc. VAT
<b>Instrumentation:</b> • Speedometer • Rev counter • Digital fuel gauge with low fuel warning light • Coolant temperature gauge with warning light	●		
<b>ECO features:</b> • Shift-up indicator (manual models) – Indicates when to change gear for optimum fuel economy.	●		
<b>Driver information display:</b> • Monochrome display located in instrument cluster • Odometer • Service-due indicator • Displays trip computer data (when fitted)	●		
<b>Central facia display:</b> • Audio information • Digital clock with automatic RDS time adjustment • Outside air temperature with ice warning function • Additional features and location dependent on infotainment unit (see Audio, Communication and Navigation for details)	●		
<b>Warning indicators:</b> • Low oil level, low brake fluid, brake pad wear, battery, fuel filter, low AdBlue® level, seatbelt warning and doors open	●		
<b>Digital tachograph:</b> • CANbus interface • Odometer display is changed from miles to kilometres – Standard on RWD HD 4500 / Minibus / Trabus models. – Not available with pneumatic rear suspension. – Important: The digital tachograph must be specified at time of ordering as it cannot be fitted retrospectively. Option price does not include calibration which must be carried out at an approved tachograph centre within 14 days of the vehicle's registration. Please note: The legislation regarding the use of tachographs is complex and operators should seek independent advice or speak to the Commercial Vehicle specialist at your Vauxhall retailer to ensure compliance. Alternatively your local DVLA office will also be able to provide clarification of the relevant legislation. Option code: TGP	○	535.00	<b>642.00</b>

## HEATING AND VENTILATION

<b>Cab heating:</b> • Four-speed fan • Illuminated controls • Four adjustable facia vents • Windscreen demist vents • Side window demist vents	●		
<b>Air conditioning:</b> • Air recirculation facility • Pollen filter • Illuminated controls • Chilled glovebox facility – Not available on Minibus models.	○	Option code: C60 610.00	<b>732.00</b>
<b>Electronic climate control:</b> • Incorporating air conditioning • LCD temperature display • Automatic air direction and fan speed with manual override • Illuminated controls • Pollen filter • Chilled glovebox facility – Not available on Combi / Minibus / Trabus models.	○	Option code: C61 910.00	

● = Standard equipment. ○ = Optional at extra cost.

**Please note:** The air conditioning in vehicles with N1, N2 or M2 type approval relies upon fluorinated greenhouse gases (R134a) for its functioning. The front system contains a quantity of overall 580g of R 134a, which corresponds to a CO<sub>2</sub> equivalent of 0.83 tons. The front and rear system in versions with up to 9-seats contains a quantity of overall 1,100g of R 134a, which corresponds to a CO<sub>2</sub> equivalent of 1.57 tons. The front and rear system in versions with more than 16-seats contains a quantity of overall 1,700g of R 134a, which corresponds to a CO<sub>2</sub> equivalent of 2.43 tons. The global warming potential amounts to 1430. Information acc. to R (EU) No. 517/2014.

# MOVANO EQUIPMENT / OPTIONS

## INFOTAINMENT

		Price (£) exc. VAT	Total (£) inc. VAT
<b>CD 16 BT USB:</b> <i>Onboard features:</i> • DAB digital radio / AM/FM stereo radio with 18-station presets • CD/MP3 CD player • High-level display • RDS with Traffic Programme • Two 15-watt speakers <i>Media connections:</i> • USB connection with iPod control • Aux-in socket • Bluetooth® audio streaming (A2DP Profile) <i>Mobile phone portal:</i> • Bluetooth® connectivity • Handsfree calls via steering wheel controls • Vehicle microphone • Phone book access – <i>Contacts/last calls/missed calls etc. (features dependent on mobile phone).</i>	●		
<b>NAVI 50 IntelliLink:</b> <i>Onboard features:</i> • DAB digital radio / AM/FM stereo radio with 18-station presets • 7-inch facia-mounted colour touchscreen • RDS with Traffic Programme • Two 20-watt speakers <i>Navigation features:</i> • Satellite navigation system • 3D street level mapping • Major route mapping for Western Europe <i>Media connections:</i> • USB connection with iPod control • Aux-in socket • Bluetooth® audio streaming (A2DP Profile) <i>Mobile phone portal:</i> • Bluetooth® connectivity • Handsfree calls via steering wheel controls • Vehicle microphone • Phone book access – <i>Contacts/last calls/missed calls etc. are mirrored on IntelliLink's display and are easily navigated using the touchscreen (features dependent on mobile phone).</i> – <i>Not available on Minibus models.</i> Option code: 100	○	660.00	<b>792.00</b>
<b>NAVI 80 IntelliLink:</b> <i>Onboard features:</i> • DAB digital radio / AM/FM stereo radio with 18-station presets • 7-inch facia-mounted colour touchscreen • RDS with Traffic Programme • Two speakers • 20 watts per channel output <i>Navigation features:</i> • Satellite navigation system • TomTom LIVE services • 3D street level mapping • Major route mapping for Western Europe <i>Media connections:</i> • USB connection with iPod control • Aux-in socket • Bluetooth® audio streaming (A2DP Profile) • Integrated voice control <i>Mobile phone portal:</i> • Bluetooth® connectivity • Handsfree calls via steering wheel controls • Vehicle microphone • Phone book access – <i>Contacts/last calls/missed calls etc. are mirrored on IntelliLink's display and are easily navigated using the touchscreen (features dependent on mobile phone).</i> – <i>Not available on Minibus models.</i> Option code: 2L3	○	1060.00	<b>1272.00</b>
<b>Additional features:</b> • Steering column mounted audio controls • Flexible roof-mounted aerial	●		

● = Standard equipment. ○ = Optional at extra cost.

# MOVANO EQUIPMENT / OPTIONS

## LOAD ACCESS – PANEL VAN / DOUBLECAB

		Price (£) exc. VAT	Total (£) inc. VAT
<b>Nearside access:</b>			
<i>Nearside side-access door:</i>	●		
• Nearside sliding side-access door • Unglazed – Standard on Panel Van.			
<i>Nearside side-access door with fixed windows:</i>	▲	330.00	
• Fixed window to standard nearside side-access door (£165) • Fixed window to opposite offside body panel (£165) – Standard on Doublecab.			
<i>Nearside side-access door with sliding windows:</i>	▲	670.00	
• Sliding window to standard nearside side-access door (£335) • Sliding window to opposite offside body panel (£335)			
<b>Offside access:</b>			
<i>Offside side-access door:</i>	▲	310.00	
• Offside sliding side-access door • Unglazed – Panel Van only.			
<i>Offside side-access door with fixed windows:</i>	▲	640.00	
• Fixed window to standard nearside side-access door (£165) • Offside side-access door (£310) • Fixed window to offside side-access door (£165)			
<i>Offside side-access door with sliding windows:</i>	▲	980.00	1176.00
• Sliding window to standard nearside side-access door (£335) • Offside side-access door (£310) • Sliding window to offside side-access door (£335)			
<b>Rear access:</b>			
<i>Rear solid doors:</i>	●		
• Twin rear doors • 90°/180° opening			
• Twin rear doors • 270° opening – Not available on L1 models.	○	285.00	
<i>Rear glazed doors:</i>	○	110.00	
• Glazed rear doors • 90°/180° opening – Standard on Combi/Minibus/Trabus.			
• Glazed rear doors • 270° opening – Not available on L1 models.	○	385.00	
• Heated rear windows – Only available with glazed rear doors.	○	110.00	132.00

● = Standard equipment. ○ = Optional at extra cost. ▲ = Please refer to ordering guide.

# MOVANO EQUIPMENT / OPTIONS

## GLAZED PACK – PANEL VAN

		Price (£) exc. VAT	Total (£) inc. VAT
<ul style="list-style-type: none"> <li>Fixed window to standard nearside side-access door</li> <li>Fixed window to opposite offside body panel</li> <li>Rear glazed doors</li> <li>Rear glazed side panels</li> </ul> – Panel Van only. Standard on Combi / Minibus / Trabus models.	Option code: A10	○	430.00

## LOAD RESTRAINT – PANEL VAN

### Load anchorage/net:

<ul style="list-style-type: none"> <li>Fixed floor-mounted load restraint lashing eyes (L1 models x 6, L2/L3 models x 8, L4 models x 10)</li> <li>Nearside/offside rear door column load restraint lashing eyes</li> </ul>		●	
<ul style="list-style-type: none"> <li>Fixed side-mounted anchorage points (x 8) – Not available with grab handle options.</li> </ul>	Option code: ANY	○	85.00
<ul style="list-style-type: none"> <li>Load protection net (L2/L3 models only)</li> </ul> – Not available on RWD HD 4500 HD models / with floor and roof fixing rail.	Option code: XBEC	○	570.00

### Load fixing rails:

<b>Floor/roof fixing rails (FWD L2 H2/L3 H2 models only):</b>			
<ul style="list-style-type: none"> <li>Two parallel roof rails</li> <li>Two parallel floor rails</li> <li>Anti-slip wooden floor</li> </ul> – Not available with resin-coated load floor / load protection net.	Option code: XBDB	L2 ○ L3 ○	1005.00 1185.00
<b>Floor fixing rails (FWD L2/L3 models only):</b>			
<ul style="list-style-type: none"> <li>Two parallel floor rails</li> <li>Anti-slip wooden floor</li> </ul> – Not available with resin-coated load floor / load protection net.	Option code: XBCE	L2 ○ L3 ○	795.00 970.00
<b>Dual side fixing rails – dual height (FWD L2/L3 models only):</b>			
<ul style="list-style-type: none"> <li>Two nearside parallel side rails</li> <li>Two parallel offside side rails</li> <li>Plastic infill protective load lining panels</li> </ul> – Not available with half or full-height load lining trim / Glazing Pack.	Option code: XBCO	L2 ○ L3 ○	880.00 1100.00
<b>Side fixing rails – mid height (FWD L2/L3 models only):</b>			
<ul style="list-style-type: none"> <li>Single nearside side rail</li> <li>Single offside side rail</li> <li>Plastic infill protective load lining panels</li> </ul> – Not available with half or full-height load lining trim / Glazing Pack.	Option code: XBBA	L2 ○ L3 ○	750.00 925.00
Adjustable securing lashing eyes for use with fixing rails	Option code: XBCI	○	55.00
Ratcheted strap for use with fixing rails	Option code: XBDX	○	50.00
Telescopic blocking bars			
– Only available with floor or side fixing rails.	Option code: XBBD	○	205.00
Adjustable partition wall			
– Only available with floor and roof fixing rails.	Option code: XBBI	○	1205.00

● = Standard equipment. ○ = Optional at extra cost.

# MOVANO EQUIPMENT / OPTIONS

## LOAD PROTECTION – PANEL VAN

		Price (£) exc. VAT	Total (£) inc. VAT
<b>Load lining:</b> Half-height plywood load lining panels	L1/L2 <input type="radio"/>	170.00	
	L3 <input type="radio"/>	190.00	
	Option code: N18 L4 <input type="radio"/>	210.00	
<ul style="list-style-type: none"> <li>• Full-height plywood load lining • Plywood wheel arch protection</li> <li>– Not available with glazed side-access door(s) / Only available with resin-coated plywood load floor covering.</li> </ul>	L1/L2 <input type="radio"/>	450.00	
	Option code: N20 L3/L4 <input type="radio"/>	570.00	
Resin-coated plywood load floor covering	L1/L2 <input type="radio"/>	330.00	
	Option code: B68 L3/L4 <input type="radio"/>	370.00	

## ADDITIONAL LOAD AREA FEATURES – PANEL VAN / DOUBLECAB

Two grab handles (side-access and rear doors) – Panel Van only. Not available with side-mounted anchorage points.	Option code: XBBG	<input type="radio"/>	75.00
Three grab handles (two side-access and rear doors) – Panel Van only. Not available with side-mounted anchorage points.	Option code: XBEJ	<input type="radio"/>	100.00
Illuminated load area		<input checked="" type="radio"/>	
LED illuminated load area	Option code: XBHN	<input type="radio"/>	95.00
Glazed load area roof panel – Not available on H3 models.	Option code: OC6	<input type="radio"/>	260.00
Two glazed load area roof panels – L2 H2, L3 H2 and L4 H2 Panel Van models.	Option code: OC7	<input type="radio"/>	510.00

● = Standard equipment. ○ = Optional at extra cost.



# MOVANO EQUIPMENT / OPTIONS

## EXTERIOR CONVENIENCE / STYLING

		Price (£) exc. VAT	Total (£) inc. VAT
<b>Exterior features:</b>			
<ul style="list-style-type: none"> <li>Integral steps in front bumper</li> <li>Laminated windscreen</li> <li>Body side-protection mouldings</li> </ul>	●		
<ul style="list-style-type: none"> <li>Front and rear mudflaps</li> </ul>	○	60.00	<b>72.00</b>
<ul style="list-style-type: none"> <li>Rear bumper with integral step</li> <li><i>– Standard on RWD / RWD HD Panel Van / Doublecab models. Optional on FWD Panel Van / Doublecab / Combi models.</i></li> </ul>	○	260.00	<b>312.00</b>
<b>Windows:</b>			
<ul style="list-style-type: none"> <li>Electrically operated front windows</li> </ul>	●		
<b>Door mirrors:</b>			
<ul style="list-style-type: none"> <li>Foldable electrically adjustable/heated door mirrors</li> <li>Wide-angle mirror on driver's side</li> <li>Integrated side-repeat indicators</li> </ul>	●		
<b>Extendable door mirrors (Chassis, Crew and Platform Cab):</b>			
<ul style="list-style-type: none"> <li>Long arm exterior mirrors – <i>Long arm exterior mirrors should be applied to any vehicle with an overall width of 2.17 to 2.35 metres</i></li> </ul>	○	85.00	
<b>Paint finish:</b>			
<ul style="list-style-type: none"> <li>Special paint</li> <li><i>– Restrictions apply, please consult your Retailer for details.</i></li> </ul>	○		<b>At extra cost</b>

## EXTERIOR LIGHTING

<b>Standard lighting:</b>			
<ul style="list-style-type: none"> <li>Lights-on audible warning</li> <li>Manual headlight beam levelling</li> <li>Twin reversing lights</li> <li>Hazard warning lights</li> <li>Rear fog lights</li> <li>Centre rear brake light (excluding Chassis / Crew / Platform Cab models or derivatives)</li> <li>Side-repeater in exterior mirrors</li> </ul>	●		
<ul style="list-style-type: none"> <li>Front fog lights – <i>standard on 4500 / Minibus / Trabus models.</i></li> </ul>	○	105.00	<b>126.00</b>
<b>Lighting Pack:</b>			
<ul style="list-style-type: none"> <li>Static cornering lights</li> <li>Front fog lights</li> <li>Automatic lighting control</li> <li>Rain-sensitive windscreen wipers</li> <li>Door-to-door illumination</li> <li><i>– Standard on 4500 / Minibus / Trabus models.</i></li> </ul>	○	255.00	<b>306.00</b>

● = Standard equipment. ○ = Optional at extra cost.

# MOVANO OPTIONS

## EXTERIOR COLOURS

		Price (£) exc. VAT	Total (£) inc. VAT
	<b>Arctic White (11U)</b> • Solid paint	●	
	<b>Mandarin Orange (99U)</b> • Solid paint		
	<b>Saffron Yellow (98U)</b> • Solid paint		
	<b>Signal Blue (GKX)</b> • Solid paint		
	<b>North Sea Blue (24U)</b> • Solid paint		
	<b>Ink Blue (23U)</b> • Solid paint		
	<b>Poppy Red (74U)</b> • Brilliant paint	○	320.00 <b>384.00</b>
	<b>Halo Silver (GKY)</b> • Two-coat metallic paint	○	450.00 <b>540.00</b>
	<b>Pearl Black (GUK)</b> • Two-coat metallic paint		
	<b>Ambient Blue (GKW)</b> • Two-coat metallic paint		

● = Standard equipment. ○ = Optional at extra cost.

The colours reproduced may vary slightly from the actual paint colour. As a result they should be used as a guide only. Your Vauxhall Retailer has a comprehensive display of our paint samples. On Cab and Conversion variants the colours illustrated apply to the vehicle cab only.

# MOVANO EQUIPMENT / OPTIONS

## WHEELS AND TYRES

		Price (£) exc. VAT	Total (£) inc. VAT
<b>FWD 2800 / FWD 3300 models:</b> • 6.5J x 16-inch steel wheels • 215/65 R 16 tyres • Full-size spare wheel • Wheel centre covers	●		
<b>FWD 3500 models:</b> • 6.5J x 16-inch steel wheels • 225/65 R 16 tyres • Full-size spare wheel • Wheel centre covers	●		
<b>RWD 3500 models:</b> • 7J x 16-inch steel wheels • 235/65 R 16 tyres • Full-size spare wheel • Wheel centre covers	●		
<b>RWD HD 3500 / RWD HD 4500 models:</b> • 5.5J x 16-inch steel wheels • 195/75 R 16 tyres • Twin rear wheels • Full-size spare wheel	●		
<b>All-season tyres – Continental Vanco Four Season 2:</b> FWD models: 225/65 R 16 – <i>Not available on FWD 2800 models.</i> RWD models: 235/65 R 16 RWD HD models: 195/75 R 16 Option code: NRK	○	360.00	<b>432.00</b>
<b>Full-diameter wheel covers:</b> – <i>Not available on RWD HD models.</i> Option code: QP9	○	60.00	<b>72.00</b>
<b>Tyre inflation kit in lieu of spare wheel:</b> – <i>Not available on RWD / RWD HD models. Standard on Minibus models.</i> Option code: WTC	N/C		<b>No-cost option</b>

● = Standard equipment. ○ = Optional at extra cost. N/C = No-cost option.

## TYRE RATINGS

Tyre size	Fuel efficiency group	Wet grip performance	External noise	
			Measured (dB)	Group
195/75 R 16	B	B	72	
215/65 R 16	B	B	71	
225/65 R 16	B-E	B-C	70	
235/65 R 16	C-E	B	70	

Tyre rating according to EU Regulation 1222/2009

# MOVANO EQUIPMENT / OPTIONS

		Price (£) exc. VAT	Total (£) inc. VAT																		
<b>MECHANICAL</b>																					
<b>Transmission:</b> <i>Six-speed manual gearbox:</i> FWD models: • Transverse engine/gearbox • L1/L2/L3 models RWD / RWD HD models: • Longitudinal engine/gearbox • L3/L4 models	●																				
<i>Tecshift six-speed transmission:</i> – Tecshift transmission adds electronic control for both the clutch and gear selection to the standard six speed transmission. <b>Electronic clutch control</b> – Tecshift automatically operates the clutch, meaning that there is no clutch pedal and the vehicle can be driven by an 'automatic-only' driving licence holder. <b>Electronic gear selection</b> – Tecshift also controls gear selection, leaving the driver with two gear-shifting options – automatic or manual. <b>Automatic mode</b> – The driver selects forward or reverse gear and Tecshift does everything else, just like an automatic gearbox. <b>Manual mode</b> – The driver can change gear sequentially by pushing the lever forward (higher gear) or pulling it backwards (lower gear). A 'kickdown' function – going through two or more gears – is also possible in manual mode.	○	See price pages																			
<b>Steering:</b> • Power-assisted rack and pinion system • Turns lock-to-lock: 3.7 <b>Turning circles:</b> <table border="1"> <thead> <tr> <th></th> <th>Kerb-to-kerb</th> <th>Wall-to-wall</th> </tr> </thead> <tbody> <tr> <td>FWD L1</td> <td>12.0m (39.3ft.)</td> <td>12.5m (41.0ft.)</td> </tr> <tr> <td>FWD / RWD / RWD HD L2</td> <td>13.6m (44.6ft.)</td> <td>14.1m (46.2ft.)</td> </tr> <tr> <td>FWD L3</td> <td>15.7m (51.5ft.)</td> <td>16.2m (53.1ft.)</td> </tr> <tr> <td>RWD / RWD HD L3</td> <td>13.6m (44.6ft.)</td> <td>14.1m (46.2ft.)</td> </tr> <tr> <td>RWD / RWD HD L4</td> <td>15.7m (51.5ft.)</td> <td>16.2m (53.1ft.)</td> </tr> </tbody> </table>		Kerb-to-kerb	Wall-to-wall	FWD L1	12.0m (39.3ft.)	12.5m (41.0ft.)	FWD / RWD / RWD HD L2	13.6m (44.6ft.)	14.1m (46.2ft.)	FWD L3	15.7m (51.5ft.)	16.2m (53.1ft.)	RWD / RWD HD L3	13.6m (44.6ft.)	14.1m (46.2ft.)	RWD / RWD HD L4	15.7m (51.5ft.)	16.2m (53.1ft.)	●		
	Kerb-to-kerb	Wall-to-wall																			
FWD L1	12.0m (39.3ft.)	12.5m (41.0ft.)																			
FWD / RWD / RWD HD L2	13.6m (44.6ft.)	14.1m (46.2ft.)																			
FWD L3	15.7m (51.5ft.)	16.2m (53.1ft.)																			
RWD / RWD HD L3	13.6m (44.6ft.)	14.1m (46.2ft.)																			
RWD / RWD HD L4	15.7m (51.5ft.)	16.2m (53.1ft.)																			
<b>Brakes:</b> <i>Front ventilated disc brakes:</i> • FWD / RWD / RWD HD: 302mm x 28mm <i>Rear disc brakes:</i> • FWD / RWD: 305mm x 12mm • RWD HD: 305mm x 18mm	●																				
<b>Power take-off (manual models only):</b> • Engine driven power take-off – Single turbo FWD. Not available on Minibus / Trabus or with air conditioning / electronic climate control options. – BiTurbo FWD and all RWD. Only available with air conditioning / electronic climate control options. Option code: V66	○	160.00	192.00																		
• Gearbox-driven power take-off – RWD / RWD HD models only. – Not available with increased engine idle speed. Option code: M1F	○	460.00																			
• Increased engine idle speed – Not available with 110PS Start/Stop engines. Option code: UF3	○	60.00																			
<b>Fuel tank:</b> • 80 litres (17.6 gallons) capacity • 105 litres (23.1 gallons) capacity – Not available on Core Conversions (excluding L3 Box) / Minibus models. Option code: NH7	○	110.00	132.00																		
<b>AdBlue tank:</b> • 22 litres (4.8 gallons) capacity	●																				

● = Standard equipment. ○ = Optional at extra cost.

# MOVANO EQUIPMENT / OPTIONS

		Price (£) exc. VAT	Total (£) inc. VAT
<b>MECHANICAL</b>			
<b>Towing:</b>			
<ul style="list-style-type: none"> <li>Tow bar with 13-pin electrics (does not suit trailers with LED lights) • Trailer stability programme</li> <li>– Unless specific exemptions apply, vehicles operated with a trailer, where the combined weight of the vehicle, trailer and payload exceeds 3500kg, require a digital tachograph. For trailers with LED lights use genuine Vauxhall Accessory tow bars which also include trailer stability programme.</li> </ul>	Option code: VR2 / VTO	385.00	<b>462.00</b>
<b>Electrical:</b>			
<ul style="list-style-type: none"> <li>95Ah maintenance-free battery (105Ah on Tecshift models) • 185A alternator</li> <li>Second battery</li> <li>– Not available with single passenger seat options / Air-suspended driver's seat / Trabus models.</li> </ul>	Option code: OBC	485.00	<b>582.00</b>
<b>CANbus interface:</b>			
<ul style="list-style-type: none"> <li>Allows the vehicle's electrical systems to integrate with additional equipment.</li> <li>– Standard on RWD HD 4500 models.</li> <li>– Not available on Combi models when front and rear air conditioning is specified or Minibus / Trabus models.</li> </ul>	Option code: KC6	135.00	<b>162.00</b>
<b>Six-pin electrical connector for conversions:</b>			
<ul style="list-style-type: none"> <li>– Standard on Dropside / Tipper. Not available on Combi models when front and rear air conditioning is specified or Minibus / Trabus models..</li> </ul>	Option code: KPD	60.00	<b>72.00</b>
<b>Front suspension:</b>			
<ul style="list-style-type: none"> <li>MacPherson type • Independent double wishbones • Coil springs • Telescopic dampers</li> </ul>			
<b>Rear suspension:</b>			
<ul style="list-style-type: none"> <li>Tubular axle • Telescopic dampers • Variable rate leaf springs</li> <li>FWD models: • Single leaf springs • Single rear wheels</li> <li>RWD models: • Double leaf springs • Single rear wheels</li> <li>RWD HD models: • Triple leaf springs • Twin rear wheels</li> </ul>			
<b>Pneumatic rear suspension:</b>			
<ul style="list-style-type: none"> <li>– Only available with six-pin connector and CANbus.</li> <li>– Only available on FWD 3300 / FWD 3500 L2/L3 models.</li> <li>– Not available on Combi / Minibus / Trabus.</li> </ul>	Option code: F47	2010.00	
<b>Construction Pack (RWD models only):</b>			
<ul style="list-style-type: none"> <li>Air-suspended driver's seat with armrest • Automatic locking rear differential</li> <li>Tow bar with 13-pin electrics (does not suit trailers with LED lights) • Trailer stability programme – Not available on Tipper / Box Van.</li> <li>For trailers with LED lights use genuine Vauxhall Accessory tow bars which also include trailer stability programme.</li> </ul>	Option code: HMG	960.00	
<b>Body Conversion Pack A (Chassis and Platform Cab):</b>			
<ul style="list-style-type: none"> <li>Extended wiring loom • Six-pin connector for conversions • 16-pin connector for cab-based conversions</li> </ul>	Option code: XZCM	95.00	
<b>Body Conversion Pack B (Crew Cab):</b>			
<ul style="list-style-type: none"> <li>Extended wiring loom • Six-pin connector for conversions</li> </ul>	Option code: XZCN	60.00	
<b>Automatic locking rear differential (RWD models only)</b>			
	Option code: G94	510.00	

● = Standard equipment. ○ = Optional at extra cost.

# MOVANO EQUIPMENT / OPTIONS

## ADDITIONAL FEATURES – TIPPER

		Price (£) exc. VAT	Total (£) inc. VAT
<b>Tipper assembly:</b> <ul style="list-style-type: none"> <li>• Five-stage chrome-plated underfloor ram</li> <li>• Sliding and internal self-lubricating components made of reinforced nylon and Teflon</li> <li>• Anti-vibration Teflon plates on a secondary frame</li> </ul> <b>Tipper deck:</b> <ul style="list-style-type: none"> <li>• Steel platform, powder coated in dark grey</li> <li>• Integrated cabin protection, ladder rack and side under-run protection</li> <li>• 400mm anodised aluminium removable side and rear alloy panels with recessed hinges</li> <li>• Top and bottom hinged rear panel</li> <li>• Recessed side and tailboard operating levers</li> <li>• Removable rear posts</li> <li>• Galvanised fixing bolts</li> <li>• Automatically releasing rear panel during the rear tipping phase</li> <li>• Frame and cross-members in edged galvanised sheet</li> </ul> <b>Electrics:</b> <ul style="list-style-type: none"> <li>• Audible warning during operation</li> <li>• Fused power supply with isolator switch</li> <li>• Electro/hydraulic power pack</li> <li>• Side lights where required</li> <li>• Remote control on wander-lead located behind driver's seat</li> </ul> <b>Exterior:</b> <ul style="list-style-type: none"> <li>• Additional half-height tool box on L3 Chassis Cab Tipper models (2100 x 650 x 750mm)</li> <li>• Rear mudflaps</li> </ul> <b>Load restraint:</b> <ul style="list-style-type: none"> <li>• Eight integrated load lashing points conforming to DIN 75410 standards</li> </ul>	●		
Rear light protection grilles	○	Option code: SCW	160.00

## ADDITIONAL FEATURES – DROPSIDE

<b>Exterior:</b> <ul style="list-style-type: none"> <li>• Plywood load floor with non-slip resin surface coating</li> <li>• Integrated cabin protection, ladder rack and side under-run protection</li> <li>• 400mm anodised aluminium removable side and rear alloy panels with recessed hinges</li> <li>• Removable rear posts</li> <li>• Integrated load lashing rings conforming to DIN 75410 standards</li> <li>• Rear mudguards</li> <li>• Galvanised fixing bolts</li> <li>• Side lights where required</li> <li>• Frame and cross-members in edged galvanised sheet</li> </ul>	●		
Removable rear ladder rack and tool box	○	Option code: K2Z	400.00

## ADDITIONAL FEATURES – BOX VAN

<b>Interior / exterior:</b> <ul style="list-style-type: none"> <li>• Polyester lightweight box with smooth external appearance</li> <li>• Aluminium frame</li> <li>• Long arm exterior mirrors</li> <li>• Side under-run protection</li> <li>• 18mm plywood covered anti-slip floor</li> <li>• Twin rear 270° opening aluminium doors</li> <li>• Folding rear step fitted to offside</li> </ul>	●		
Wind deflector	○	Option code: G7M	485.00
Luton head	○	Option code: Z1D	600.00
Rear roller shutter door	○	Option code: D5W	605.00
Retractable rear step – <i>Optional on L3 Box Van.</i>	○	Option code: VF6	260.00

● = Standard equipment. ○ = Optional at extra cost.

# MOVANO EQUIPMENT / OPTIONS

## ADDITIONAL FEATURES – COMBI

		Price (£) exc. VAT	Total (£) inc. VAT
<b>Safety:</b> <ul style="list-style-type: none"> <li>• ISOFIX child seat fixings: 1x front row, 2x second row</li> <li>• Tyre pressure monitoring system</li> </ul>			
<b>Interior:</b> <ul style="list-style-type: none"> <li>• Dual front passengers' bench seat</li> <li>• Three passenger second-row bench seat</li> <li>• Pulse cloth seat trim</li> <li>• Full-length soft-trimmed headlining</li> <li>• Full-height interior side mouldings</li> <li>• Load restraint lashing eyes</li> </ul>	●		
<b>Exterior:</b> <ul style="list-style-type: none"> <li>• Nearside sliding side-access door</li> <li>• Glazed side windows and rear doors (90°/180° opening)</li> <li>• Full-size, underfloor mounted, spare wheel</li> </ul>			
Dual front passengers' multi-function office bench seat	Option code: ASY	○	210.00 <b>252.00</b>
Air conditioning front and rear	Option code: CJ5	○	2210.00 <b>2652.00</b>
Sliding windows in nearside sliding access door and opposite panel		▲	670.00 <b>804.00</b>

## ADDITIONAL FEATURES – MINIBUS

<b>Safety:</b> <ul style="list-style-type: none"> <li>• Lane departure warning</li> <li>• Digital tachograph</li> <li>• Speed limiter (62mph)</li> <li>• M1 Type Approval standard for all rear seatbelt anchorages</li> </ul>			
<b>Interior:</b> <ul style="list-style-type: none"> <li>• Dual front passengers' multi-function office bench seat</li> <li>• 14-individual rear passenger seats in staggered layout</li> <li>• Pulse cloth seat trim</li> <li>• Raised seating with illuminated gangway</li> <li>• Slip-resistant floor covering</li> <li>• Individual saloon lighting</li> <li>• Full-length soft-trimmed headlining</li> <li>• Full-height interior side mouldings</li> </ul>	●		
<b>Exterior:</b> <ul style="list-style-type: none"> <li>• High beam headlight assist</li> <li>• Front fog lights</li> <li>• Electrically operated sidestep</li> <li>• Nearside sliding side-access door</li> <li>• Glazed side windows and rear doors (90°/180° opening)</li> <li>• Tyre inflation kit in lieu of spare wheel</li> </ul>			
Rear reversing lens	Option code: D31	○	60.00 <b>72.00</b>
Air conditioning front and rear	Option code: CJ5	○	2210.00 <b>2652.00</b>
Additional rear compartment heating	Option code: C46	○	2010.00 <b>2412.00</b>
Additional rear compartment air conditioning and heating	Option code: CAW	○	4210.00 <b>5052.00</b>
Floor-mounted seat fixing rails and removable seats – <i>Last two rows of seats</i>	Option code: ATW	○	410.00 <b>492.00</b>
Window blinds	Option code: DED	○	910.00 <b>1092.00</b>
Top opening rear side windows	Option code: AD5	○	1510.00 <b>1812.00</b>

● = Standard equipment. ○ = Optional at extra cost. ▲ = Please refer to ordering guide.

# MOVANO ONE-INVOICE APPROVED CONVERSIONS

## Approved by Vauxhall for the UK Market

- All Approved Conversions are approved by Vauxhall Engineering
- These Conversions will be managed as approved 'Options' and can only be ordered via the M.S.I.T. Special Build Programme (specialbuild@gm.com)
- Warranty of Base Vehicle remains the responsibility of Vauxhall
- Warranty and Servicing of Conversion remains the responsibility of the Converter
- All Approved Conversions are supplied with EC WVTA (European Community Whole Vehicle Type Approval) from long-standing conversion partners

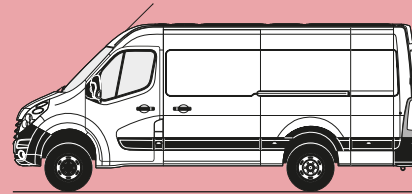
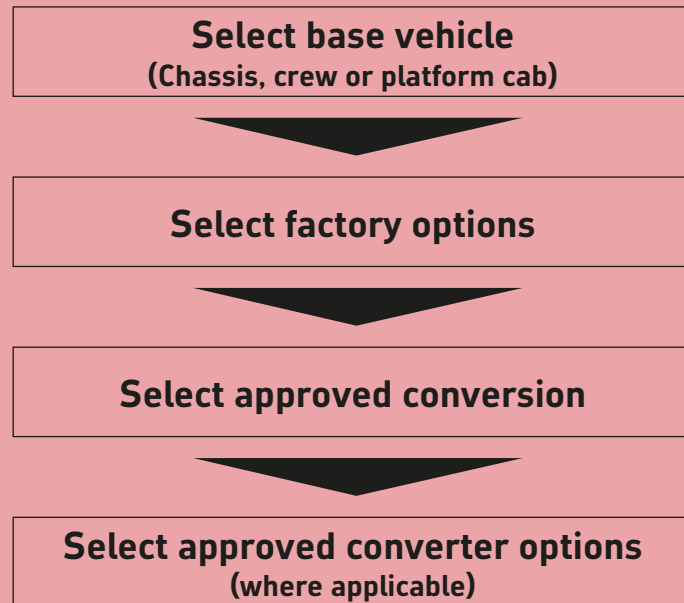

**4WD CONVERSION**

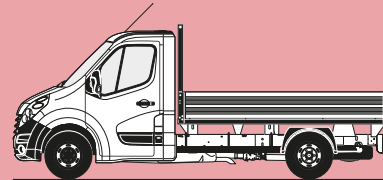

**LIGHTWEIGHT TIPPER**

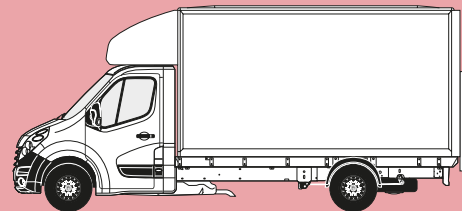

**LUTON BOX VAN**

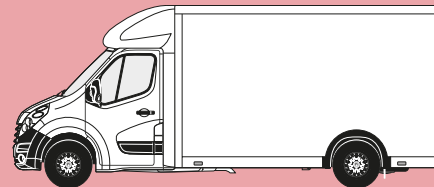

**LOW FLOOR LUTON VAN**



# MOVANO ONE-INVOICE APPROVED CONVERSIONS

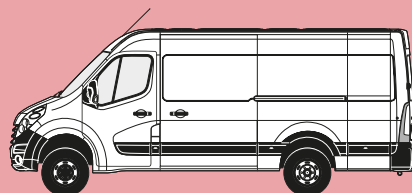

**Price (£)  
exc. VAT**  
**14500.00**

## 4WD CONVERSION BY OBERAIGNER

Type approved numbers: EC WVTA: e11\*2007/46\*1191\*00

- Available on: RWD/RWD HD Panel Van, Doublecab, Tipper, Dropside, Chassis or Crew Cab
- Switchable All-Wheel Drive (AWD) for use under poor road conditions and off-road driving
- Additional weight kept to a minimum by use of lightweight components
- Minimal vehicle lift due to compact AWD system
- Switchable 1:1.42 gearing ratio (Terrain gear) with fascia-mounted control panel for AWD system

Requires Automatic locking rear differential factory options.  
AWD drivetrain warranty is limited to 2 years/75,000 miles.

With over 20 years' experience in the design and production of 4X4 conversions, the Oberaigner Group is one of the leading suppliers of off-road vehicles in this sector of the Commercial Vehicle market.

Oberaigner Automotive GmbH  
Email: [cs@oberaigner.com](mailto:cs@oberaigner.com)  
Website: [www.oberaigner.com](http://www.oberaigner.com)  
Tel: +49 38454 3290-280

For further information please use the following website link:

**4WD CONVERSION BY OBERAIGNER**

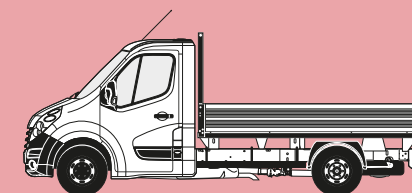

**Price (£)  
exc. VAT**  
**4530.00**

## LIGHTWEIGHT TIPPER BY VFS

Type approved numbers: EC WVTA: e11\*2007/46\*1022\*00

- Available on: L2 H1 Chassis Cab or L3 H1 Crew Cab
- Lightweight, high-strength steel design optimised for UK
- Increased payload and lowered deck height compared to ex-Factory conversion
- Powder-coated and wax injected steel box section construction
- Steel platform, powder coated in dark grey
- Crew cab also available as utility cab for additional security

### Recognised options\*:

Tow bar	<b>425.00</b>
Beacon Pack	<b>150.00</b>
Chevron Pack	<b>250.00</b>
Worklamp Pack	<b>250.00</b>
Utility Cab	<b>1840.00</b>
Lightweight galvanised mesh cage (1.35m high)	<b>2135.00</b>
Lightweight galvanised mesh cage (2.0m high)	<b>2650.00</b>

Tail lift warranty is limited to 12 months.

\* = Further options may be available. Please consult the Converter for further information.

VFS is a wholly owned subsidiary of Scattolini SpA.

VFS (Southampton) Limited  
Email: [sales@vfs.co.uk](mailto:sales@vfs.co.uk)  
Website: [www.vfs.co.uk](http://www.vfs.co.uk)  
Tel: 02380 613612

For further information please use the following website link:

**LIGHTWEIGHT TIPPER BY VFS**

# MOVANO ONE-INVOICE APPROVED CONVERSIONS

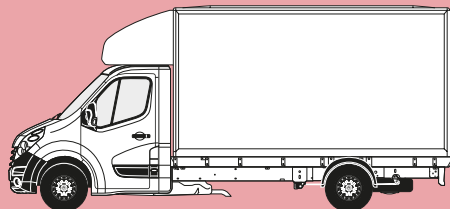

**Price (£)  
exc. VAT**  
**5665.00**

## LUTON BOX BY INGIMEX

Type approved numbers: EC WVTA: e11\*2007/46\*0971\*00

- Available on: L3 H1 F3500/R3500/R4500 Chassis Cab
- 630kg conversion weight for increased payload capacity
- Volume 18cu.m (estimated excluding Luton head)
- Wide lath rear shutter door with slam-shut lock
- Four-tier load restraint system
- One-piece birch plywood load deck

Converter options may be available. Please consult the Converter for further information.

Founded in 1972, Ingimex Limited is the UK's largest manufacturer of light commercial vehicle bodies and the only European light commercial vehicle body manufacturer to fully design, test and manufacture products in house.

Ingimex Limited  
Email: [sales@ingimex.com](mailto:sales@ingimex.com)  
Website: [www.ingimex.com](http://www.ingimex.com)  
Tel: 01952 585833

For further information please use the following website link:

**LUTON BOX BY INGIMEX**

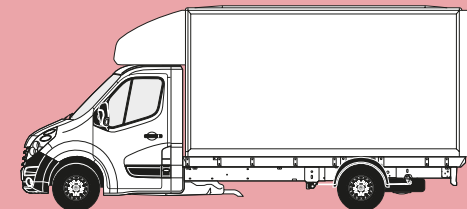

**Price (£)  
exc. VAT**  
**8295.00**

## LUTON BOX WITH TAIL LIFT BY INGIMEX

Type approved numbers: EC WVTA: e11\*2007/46\*0971\*00 (tbc)

- Available on: L3 H1 F3500/R3500/R4500 Chassis Cab
- Ratcliff Palfinger column-type tail lift rated at 500kg
- Volume 18cu.m (estimated excluding Luton head)
- Wide lath rear shutter door with slam-shut lock
- Four-tier load restraint system
- One-piece birch plywood load deck

Converter options may be available. Please consult the Converter for further information.

Founded in 1972, Ingimex Limited is the UK's largest manufacturer of light commercial vehicle bodies and the only European light commercial vehicle body manufacturer to fully design, test and manufacture products in house.

Ingimex Limited  
Email: [sales@ingimex.com](mailto:sales@ingimex.com)  
Website: [www.ingimex.com](http://www.ingimex.com)  
Tel: 01952 585833

For further information please use the following website link:

**LUTON BOX WITH TAIL LIFT BY INGIMEX**

# MOVANO ONE-INVOICE APPROVED CONVERSIONS

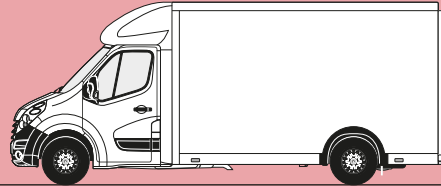

**Price (£)  
exc. VAT**  
**8275.00**

## **LOW FLOOR LUTON VAN 'KNEEHI' BY TRUCKSMITH**

Type approved numbers: EC WVTA: e11\*2007/46\*0833\*00

- Available on: L3 H1 F3500 Platform Cab
- Payload up to 1295kg
- Volume 18.5cu.m
- Lightweight conversion utilising an anodised aluminium framework and galvanised back frame
- Low loading height
- Four full-length aluminium lashing rails
- 270 degree opening barn doors, with stainless steel fittings and door retainers
- Opalescent roof giving good light to loadspace

Requires full-height steel bulkhead factory option.

Trucksmith is an owner-managed company, established in 1984, designing and building a range of Commercial Vehicle conversions.

Trucksmith Limited

Email: [sales@trucksmith.co.uk](mailto:sales@trucksmith.co.uk)

Websites: [www.trucksmith.co.uk](http://www.trucksmith.co.uk) or [www.kneehi.co.uk](http://www.kneehi.co.uk)

Tel: 01884 33001

Fax: 01884 33004

**For further information please use the following website link:**

**LOW FLOOR LUTON VAN 'KNEEHI' BY TRUCKSMITH**

# RANGE GLOSSARY OF TERMS

## PLATED WEIGHT

The maximum weight to which a vehicle or an axle may be loaded, determined either by the design of the components or by legislation. All commercial vehicles must carry a manufacturer's 'plate' showing the vehicle and axle gross 'plated weights'. It is an offence to drive a vehicle in a condition where any of these weights are exceeded.

## MINIMUM MASS

Minimum Mass ('Mass in running order' on Certificate of Conformity and 'Mass in Service' on V5C form) is defined according to European Type Approval and include all fluids, tools, 90% fuel load and driver (75kg). It is minimum mass for this variant and does not consider local specification/trim or deletable options (specific to Movano). Weights are also subject to manufacturing tolerances (EU Legislation allows 5% tolerance).

## GROSS VEHICLE WEIGHT (GVW)

The total permissible weight of a vehicle including payload and passengers, as shown on the manufacturer's plate.

## GROSS COMBINATION WEIGHT (GCW)

The maximum permissible weight of a vehicle, including payload and passengers, combined with the total weight of any trailer it is towing. The maximum GCW weight limit is quoted on the vehicle plate and must not be exceeded.

## PAYLOAD

The total permissible weight that can be carried without exceeding the vehicle's plated weight. Payload do not include driver but do take into consideration specification/trim level:

- For Combo included are UK specification (Panel Van 15kg; Crew Van 25kg) and also trim (Sportive L1 Panel Van 45kg; Sportive L2 Panel Van 30kg; Sportive Crew Van 20kg; Glazed Crew Van 40kg)
- For Vivaro included are UK specification (15kg) and trim (Sportive Panel Van 30kg; Sportive Doublecab 40kg; Limited Edition NAV Panel Van 45kg and Limited Edition NAV Doublecab 55kg)
- For Movano included are UK specification (10kg) and deletable options such as Bulkhead (25kg); Sliding Doors (30kg each) and Spare Wheel (25kg)

Weights are also subject to manufacturing tolerances (EU Legislation allows 5% tolerance). Payload does not consider any additional options that a customer may order.

## ROOF LOADS

- Corsavan roof load should not exceed 75kg including the weight of the roof rack/carrier
- Combo roof load should not exceed 100kg on H1 models including the weight of the roof rack/carrier. H2 are not permitted to carry roof loads
- Vivaro roof load should not exceed 200kg (150kg on H2 models) including the weight of the roof rack/carrier
- Movano roof load should not exceed 200kg (150kg on H1 models) including the weight of the roof rack/carrier. H3 are not permitted to carry roof loads

## MAXIMUM TOWING WEIGHT

The maximum weight of any trailer and its load which may be towed within the limit of the vehicle's plated Gross Combination Weight (GCW). It is based on the ability of the vehicle – at full GCW – to restart on a 12% gradient, which is approximately 1 in 8.3, at sea level. At altitudes above 1500 metres, the engine output may drop with a corresponding reduction in towing capability. It is the operator's responsibility to ensure that the trailer noseweight does not cause the rear axle plated weight of the towing vehicle to be exceeded.

*Always fit Vauxhall towing attachments and accessories available from your Vauxhall Commercial Vehicle retailer. They are designed specifically for Vauxhall models and carry a 12-month warranty.*

## LIGHT DUTY AND HEAVY DUTY CYCLES

For a Light Duty cycle (EC regulation 715/2007 with designation 'Euro 6') the emissions of the whole vehicle are evaluated whereas for Heavy Duty cycle (EC regulation 595/2009 with designation 'Euro VI') only the engine is bench tested. The requirement of which cycle is necessary is determined by the reference mass of the vehicle. In the case of Vivaro, reference mass calculations dictate that:

- N1 FWD and M1 FWD are approved as Light Duty
- N1 RWD, N2 RWD and M2 FWD are approved as Heavy Duty

When Euro 5 was previously introduced, there was an agreement between Member States and the Commission (Reference TEC 740/2011) that, assuming there was no alteration to the emissions system itself, a multi-stage build vehicle should be covered by the base vehicle emissions approval, irrespective of whether the reference mass had changed. The Department for Transport has confirmed that this interpretation will remain in place for Euro 6/VI.

To illustrate this better – a F3500 L3 H1 (130PS) Vivaro Chassis Cab is type approved as Light Duty (Euro 6). Regardless of any conversion to this vehicle and even if its reference mass transgresses above the 2840kg threshold, then it is still be covered by the original Light Duty cycle emissions. One situation where this may not apply is when a vehicle changes category from N1 (Commercial) to M1 (Passenger) during the process of conversion.

## COMMERCIAL VEHICLE CATEGORIES

### Differences between M1/N1 and M2/N2 (Vehicles with GVW above 3500kg)

#### Category M: Passenger carriers

**Category M1:** Vehicles designed and constructed for the carriage of passengers and comprising no more than eight seats in addition to the driver's seat.

**Category M2:** Vehicles designed and constructed for the carriage of passengers, comprising more than eight seats in addition to the driver's seat, and having a maximum mass not exceeding 5 tonnes.

#### Category N: Goods vehicles

**Category N1:** Vehicles designed and constructed for the carriage of goods and having a maximum mass not exceeding 3.5 tonnes.

**Category N2:** Vehicles designed and constructed for the carriage of goods and having a maximum mass exceeding 3.5 tonnes but not exceeding 12 tonnes.

#### Specific differences, all M2/N2 require the following:

**Speed limiter:** All M2/N2 vehicles are legally required to be speed limited. M2 to 62mph and N2 to 56mph.

**Driver licence:** Commercial vehicles with GVW greater than 3.5 tonnes have different license requirements. For any new drivers C1 category

is necessary. Under some circumstances (social purposes for a non-commercial body) it is possible to drive a minibus without a D1 entitlement (Minibus) however eligibility for this exemption should be confirmed with DVSA.

**Driver CPC:** Driver Certificate of Professional Competence mandates 35 hours of periodic training every 5 years to maintain licence (from September 2014).

**Tachograph:** It is a legal requirement to administer the activities of drivers subject to the EU or AETR drivers' hours rules, and also record the vehicle's speed, distance and time. A Smart Card is required for digital tachograph and these are available from the DVLA. The tachograph of a new vehicle must be calibrated within two weeks of first registration.

**Operator's Licence:** This may also be required to ensure that vehicles are kept safe and in good condition at all times. Specifically for M2, PSV (public service vehicle) operator's licence is required. Exemptions in some circumstances may be permitted but this should always be confirmed with DVSA.

**MOT Testing:** M2/N2 must be tested each year, and vehicle presented with a completed Certificate of Conformity (CoC). This is available from Vauxhall (regdata@gm.com) or from converter in case of second-stage conversion.

# CUSTOMER CARE PRICING AND ADDITIONAL INFORMATION

## Vauxhall on-the-road recommended retail prices (RRP)

To eliminate uncertainty about hidden costs incurred when buying a new commercial vehicle, Vauxhall publishes on-the-road prices and these are shown in the pricing tables within this price guide. The prices shown are manufacturer's recommended retail prices (RRP) unless otherwise stated, exclusive of VAT (currently at a rate of 20% which may be payable). These prices include the recommended cost of number plates, delivery to a Vauxhall Retailer of £583.33 (£700.00 including VAT), 12 months' Government Vehicle Excise Duty\* and the DVLA new vehicle first registration fee of £55.00\*.

**Please note: The RRP does not include fuel supplied by the Retailer, motor insurance or any other goods or services supplied by agreement between the Retailer and customer.**

## Price protection for all Vauxhalls

Order a new Vauxhall for build in the current model year (as confirmed by your Retailer) for delivery no more than three months in advance and the price you are quoted is the price you pay. This is irrespective of any subsequent price rises between placing your order and delivery of your new commercial vehicle, but you must take delivery as soon as the commercial vehicle is available. General Motors UK Limited is not liable for price adjustments caused by Government changes in the rate of VAT (currently 20%), Vehicle Excise Duty, DVLA new vehicle first registration fee or by any other applicable legislation or regulations.

## Vehicle Excise Duty

The amount of Vehicle Excise Duty (road fund licence) payable on new commercial vehicles varies depending on gross vehicle weight (GVW) and European standard emissions compliance, as shown below\*.

Up to 3500kg GVW	£240.00
Over 3500kg GVW	£165.00

\*Correct at time of publication.

## In the event of an accident...

Vauxhall Accident Management helps keep you mobile following an accident. Benefits include vehicle recovery, Vauxhall-approved repairs and contacting your insurer. For more details, visit [vauxhall.co.uk/AccidentManagement](http://vauxhall.co.uk/AccidentManagement)

## Customer Care Commitment

For added peace of mind, Vauxhall has an innovative Customer Care Commitment\*\* that offers the following:

- Three-year vehicle warranty consisting of a one-year/unlimited mileage manufacturer's warranty and a second and third year manufacturer's warranty with a 60,000 miles (Corsavan and Combo) and 100,000 miles (Vivaro and Movano) limitation

- Vauxhall Assistance for 12 months from first registration

- Six years' body panel anti-perforation warranty

\*\* Warranty is only on vehicles sourced from General Motors UK Limited. Terms and conditions apply - please see your Vauxhall Retailer for details.

## Vauxhall Assistance

Vauxhall Assistance is provided automatically with every new Vauxhall Commercial Vehicle for 12 months from first registration and covers everything from accidents, mechanical breakdown to flat tyres. With Vauxhall Assistance help is literally just a free† phone call away, 24 hours a day, 365 days a year!

† Mobile phone users will be charged at their standard tariff.

## Vauxhall Extended Warranty

For complete peace of mind Vauxhall offers an extended warranty that can be purchased on an annual basis following the expiry of the original new vehicle warranty. It covers most mechanical and electrical components. Terms and conditions apply, for further details please contact your local Vauxhall Retailer.

## Protecting the environment

Our products are increasingly winning environmental awards, both through the use of more recycled materials and by becoming cleaner and more efficient. For information on Vauxhall's efforts to achieve an environmentally sustainable future, including information on Design for Recycling, take-back of End-of-Life Vehicles (ELVs), and the recycling of ELVs, see [www.vauxhall.co.uk/recycling](http://www.vauxhall.co.uk/recycling)

## Vauxhall Service Plan

Vauxhall Retailers offer a great service for owners of all Vauxhall vehicles. Value for money, regular offers and free check-ups, combined with the peace of mind that comes from using Vauxhall-trained technicians and genuine parts, help keep your vehicle in peak condition at all times. Every Vauxhall Retailer supports our customer promise:

### We are Vauxhall experts

- Fully Vauxhall-trained technicians
- We use Vauxhall approved diagnostic equipment and specialist tools
- Full access to Vauxhall repair databases and technical centres

### We are transparent

- Our invoicing will clearly set out the work at the price agreed with no hidden extras

## We are never beaten on price

- We will match any written like for like service/repair quote from a local<sup>††</sup> competitor using genuine repair methods and parts

## We are convenient

- Flexible booking times to suit you
- 'One-stop shop' for every type of Vauxhall service
- While you wait facility on stocked tyres, batteries and exhausts
- Free courtesy vehicle or local collection with annual services and warranty work

## We are thorough

- 25 point safety check with any workshop visit
- No obligation advice on essential and non-essential work
- Free check for safety enhancements and upgrades to your vehicle and software
- Free 'Wash and Vac' with every annual service
- Free fitting of wipers and external bulbs with annual services

†† A radius of five miles/20 minutes from your Vauxhall Retailer.

## Premier Van Centres

To maximise mobility and minimise downtime, our dedicated network of over 100 Premier Van Centres is increasing its emphasis on faster turnaround and fewer vehicle days spent off-road. We're your commercial vehicle 'one-stop shop' with all the specialised equipment, tools and training to support your aftersales needs, using only genuine parts fitted by Vauxhall-trained technicians. What's more, we promise convenience, expertise and value:

- Drop in for a diagnosis, no appointment necessary
- While-you-wait repairs where the parts are on-site
- A 25-point vehicle safety check with every workshop visit
- Access to Class 7 MOT facilities
- Onward mobility and a dedicated Premier Van Helpline - call 0800 026 0034

# CORSAVAN SPECIFICATIONS

## ENGINES

	1.2i (70PS)	1.3CDTi (75PS) Start/Stop	1.3CDTi (95PS) Start/Stop ecoFLEX	1.3CDTi (95PS) Start/Stop
Fuel type	Petrol	Diesel	Diesel	Diesel
Capacity	1229cc	1248cc	1248cc	1248cc
Maximum power	70PS (51kW) @ 5600rpm	75PS (55kW) @ 3750rpm	95PS (70kW) @ 3750rpm	95PS (70kW) @ 3750rpm
Maximum torque	115Nm (85 lb.ft.) @ 4000rpm	190Nm (140 lb.ft.) @ 1500-2500rpm	190Nm (140 lb.ft.) @ 1500-3500rpm	210Nm (155 lb.ft.) @ 1500-3000rpm
Configuration		4 cylinders, 4 valves per cylinder, double overhead camshafts		
Fuel/induction system	Naturally aspirated with Variable Valve Timing. Multi-point sequential fuel injection	Turbocharger with intercooler. Common rail fuel injection	Variable geometry turbocharger with intercooler. Common rail fuel injection	
Emission compliance	Euro 6	Euro 6 with Diesel Particulate Filter		
Service interval	20,000 miles or 1-year (whichever occurs sooner)			

## PLATED WEIGHTS AND TOWING DATA KG – CAR-DERIVED VAN

Model		Gross Vehicle Weights (GVW)	Plated weights		Towing weights		Plated Gross Combination Weights (GCW)
			Front axle	Rear axle	Braked	Unbraked	
Corsavan	1.2i	1605	815	820	950	540	2555
	1.3CDTi	1695	905	820	1200	580	2895
	1.3CDTi ecoFLEX	1695	905	820	1250	580	2945
	1.3CDTi Sportive	1720	930	820	1250	600	2970
	1.3CDTi ecoFLEX Easytronic	1705	915	820	1250	580	2955

Gross plated weights (including axle weights) quoted on the vehicle plate are to UK plated weight specification and must never be exceeded. For further information please see Glossary of Terms.

## CORSAVAN

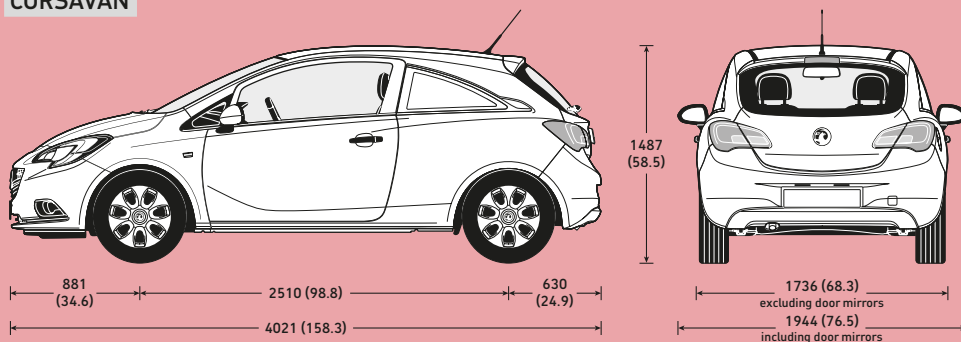

## LOADSPACE DIMENSIONS MM (INCHES)

Maximum length	1257 (49.5)
Maximum width	1264 (49.8)
Width between wheel arches	969 (38.1)
Maximum height	921 (36.2)

## LOADSPACE ACCESS MM (INCHES)

Aperture height	650 (25.6)
Aperture width (at floor)	771 (30.3)
Loading height (unladen)	532 (20.9)

## LOADSPACE VOLUMES CU.M (CU.FT)

All models – ECIE method	0.92 (32.5)
--------------------------	-------------

# COMBO SPECIFICATIONS

## ENGINES

	<b>1.4i 95PS with Start/Stop</b>	<b>1.3CDTi 95PS with or without Start/Stop</b>	<b>1.6CDTi 105PS with or without Start/Stop</b>
Capacity	1368cc	1248cc	1598cc
Maximum power	95PS (70kW) @ 6000rpm	95PS (70kW) @ 3500 – 3750 rpm	105PS (77kW) @ 3500rpm
Maximum torque	127Nm (94 lb.ft.) @ 4500rpm	200Nm (148 lb.ft.) @ 1500rpm	300Nm (221 lb.ft.) @ 1750 – 2000rpm
Configuration	4 cylinders, 4 valves per cylinder, double overhead camshafts		
Fuel/induction system	Multi-point fuel injection	Variable geometry turbocharger with intercooler. Common rail fuel injection	
Emission compliance	Euro 6		
Service interval	18,000 miles or two years (whichever occurs sooner)	20,000 miles or two years (whichever occurs sooner)	

# COMBO PANEL VAN SPECIFICATIONS

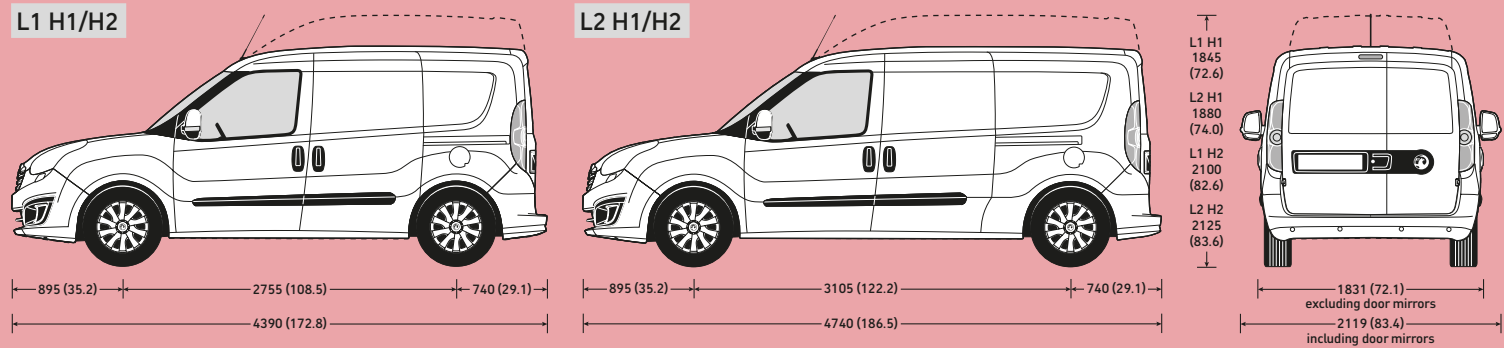

Heights shown unladen.

## LOADSPACE DIMENSIONS MM (INCHES) – PANEL VAN

	L1	L2
Maximum length	1820 (71.7)	2170 (85.4)
Maximum width	1714 (67.5)	1714 (67.5)
Width between wheel arches	1230 (48.4)	1230 (48.4)
Maximum height – H1	1305 (51.4)	1305 (51.4)
Maximum height – H2	1550 (61.0)	1550 (61.0)

## LOADSPACE ACCESS MM (INCHES) – PANEL VAN

	L1	L2
Side door aperture height	1175 (46.2)	1175 (46.2)
Side door aperture width	700 (27.5)	700 (27.5)
Rear door aperture height – H1	1250 (49.2)	1250 (49.2)
Rear door aperture height – H2	1455 (57.2)	1455 (57.2)
Rear door aperture width	1231 (48.5)	1231 (48.5)
Loading height (unladen)	545 (21.4)	545 (21.4)

## PLATED WEIGHTS AND TOWING DATA KG – PANEL VAN

Model	Gross Vehicle Weights (GVW)	Plated weights		Towing weights		Plated Gross Combination Weights (GCW)
		Front axle	Rear axle	Braked	Unbraked	
L1 H1 Panel Van	2000 1.4i	2030	1090	1000	500	3030
	2000 1.3CDTi	2040	1090	1000	500	3040
	2000 1.6CDTi	2098	1090	1300	500	3398
	2300 1.3CDTi	2320	1090	1000	500	3320
	2300 1.6CDTi	2418	1200	1300	500	3500
L2 H1 Panel Van	2300 1.4i	2215	1090	1000	500	3215
	2300 1.3CDTi	2385	1120	1000	500	3385
	2300 1.6CDTi	2458	1200	1300	500	3500
L1 H2 Panel Van	2000 1.6CDTi	2120	1090	1300	500	3420
	2300 1.6CDTi	2428	1200	1300	500	3500
L2 H2 Panel Van	2300 1.6CDTi	2488	1200	1300	500	3500

Gross plated weights (including axle weights) quoted on the vehicle plate are to UK plated weight specification and must never be exceeded. For further information please see Glossary of Terms.

## LOADSPACE VOLUMES CU.M (CU.FT) – PANEL VAN

	L1	L2
H1 Panel Van	3.4 (121)	4.2 (148)
H2 Panel Van	4.0 (141)	5.0 (177)



# COMBO CREW VAN SPECIFICATIONS

## L1/L2 H1

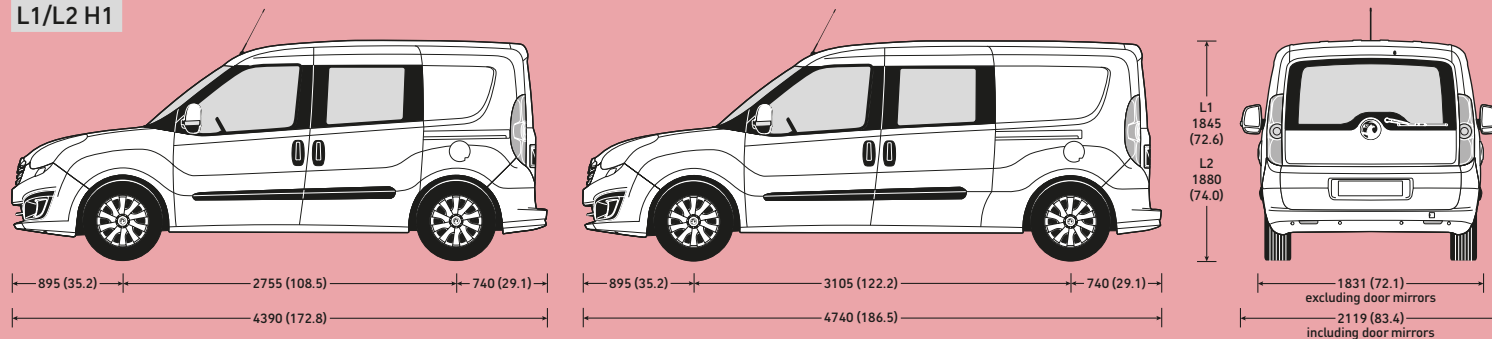

Please note, Glazed Crew Van illustrated. Height shown unladen.

### LOADSPACE DIMENSIONS MM (INCHES) – CREW VAN

	L1	L2
Maximum length – with seats up	991 (39.0)	1341 (52.8)
Maximum length – with seats down	1400 (55.1)	1750 (68.9)
Maximum width	1714 (67.5)	1714 (67.5)
Width between wheel arches	1230 (48.4)	1230 (48.4)
Maximum height	1305 (51.4)	1305 (51.4)

### LOADSPACE ACCESS MM (INCHES) – CREW VAN

	L1	L2
Side door aperture height	1175 (46.2)	1175 (46.2)
Side door aperture width	700 (27.5)	700 (27.5)
Rear door aperture height	1250 (49.2)	1250 (49.2)
Rear door aperture width	1231 (48.5)	1231 (48.5)
Loading height (unladen)	545 (21.4)	545 (21.4)

### LOADSPACE VOLUMES CU.M (CU.FT) – CREW VAN

	L1 H1	L2 H1
Crew Van – with seats up (to top of seats)	0.8 (28.2)	1.0 (35.3)
Crew Van – with seats up (to roof)	1.4 (49.4)	1.9 (67.1)

### PLATED WEIGHTS AND TOWING DATA KG – CREW VAN / COLORADO

Model	Gross Vehicle Weights (GVW)	Plated weights		Towing weights		Plated Gross Combination Weights (GCW)	
		Front axle	Rear axle	Braked	Unbraked		
L1 H1 Crew Van	2300 1.3CDTi	2234	1090	1310	1000	500	3234
	2300 1.6CDTi	2254	1090	1310	1300	500	3398
L2 H1 Crew Van	2300 1.3CDTi	2254	1120	1310	1000	500	3254
	2300 1.6CDTi	2349	1200	1310	1300	500	3500
L2 H1 Colorado	2300 1.3CDTi	2254	1120	1310	1000	500	3254

Gross plated weights (including axle weights) quoted on the vehicle plate are to UK plated weight specification and must never be exceeded. For further information please see Glossary of Terms.

# VIVARO SPECIFICATIONS

## ENGINES

	<b>1.6CDTi (95PS) BlueInjection with or without Start/Stop</b>	<b>1.6CDTi (120PS) BlueInjection</b>
Capacity	1598cc	1598cc
Maximum power	95PS (70kW) @ 3500rpm	120PS (89kW) @ 3500rpm
Maximum torque	260Nm (192 lb.ft.) @ 1500rpm	300Nm (221 lb.ft.) @ 1750rpm
Configuration	4 cylinders, 4 valves per cylinder, double overhead camshafts	
Fuel/induction system	Variable geometry turbocharger with intercooler. Common rail fuel injection	
Emission compliance	Euro 6	
Service interval	25,000 miles or two-years (whichever occurs sooner)	

	<b>1.6CDTi BiTurbo (125PS) BlueInjection Start/Stop</b>	<b>1.6CDTi BiTurbo (145PS) BlueInjection Start/Stop</b>
Capacity	1598cc	1598cc
Maximum power	125PS (92kW) @ 3500rpm	145PS (107kW) @ 3500rpm
Maximum torque	320Nm (236 lb.ft.) @ 1500rpm	340Nm (251 lb.ft.) @ 1750rpm
Configuration	4 cylinders, 4 valves per cylinder, double overhead camshafts	
Fuel/induction system	Twin variable geometry turbochargers with intercoolers. Common rail fuel injection	
Emission compliance	Euro 6	
Service interval	25,000 miles or two-years (whichever occurs sooner)	

\* = Please note: Vehicles with BlueInjection technology will need regular AdBlue® top-ups also between servicing requirements. An indicator integrated into the onboard computer will warn you when you need to top up. More information under [www.vauxhall.co.uk/blueinjection](http://www.vauxhall.co.uk/blueinjection). In accordance with regulations R (EC) No. 715/2007 and R (EC) No. 692/2008 (in the versions respectively applicable).

# VIVARO PANEL VAN SPECIFICATIONS

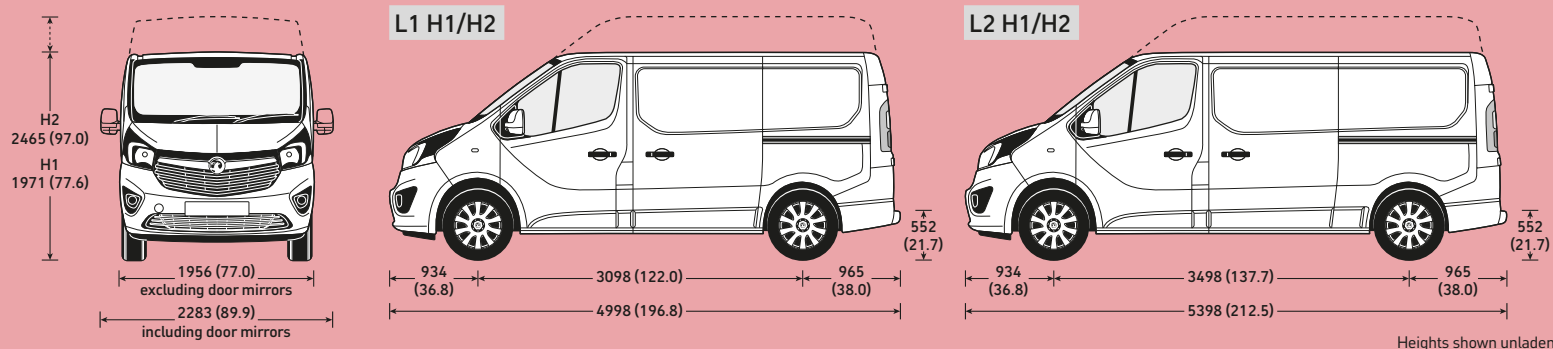

Heights shown unladen

## LOADSPACE DIMENSIONS MM (INCHES) – PANEL VAN

	L1	L2
Maximum length at load floor	2537 (99.9)	2937 (115.6)
Maximum length with load-through facility maximum length to seat – <i>Approximate.</i>	2967 (116.8)	3367 (132.5)
Maximum length with load-through facility maximum length to front footwell – <i>Approximate.</i>	3750 (147.6)	4150 (163.4)
Maximum width	1662 (65.5)	1662 (65.5)
Width between wheel arches	1268 (49.9)	1268 (49.9)
Maximum height - H1	1387 (54.6)	1387 (54.6)
Maximum height - H2	1898 (74.7)	1898 (74.7)

## LOADSPACE ACCESS MM (INCHES) – PANEL VAN

	L1	L2
Side door aperture height	1284 (50.5)	1284 (50.5)
Side door aperture width	1030 (40.5)	1030 (40.5)
Rear door aperture height – H1	1320 (52.0)	1320 (52.0)
Rear door aperture height – H2	1820 (71.6)	1820 (71.6)
Rear door aperture width	1391 (54.8)	1391 (54.8)
Loading height (unladen)	552 (21.7)	552 (21.7)

## PLATED WEIGHTS AND TOWING DATA KG – PANEL VAN

Model		Gross Vehicle Weights (GVW)	Plated weights		Towing weights		Plated Gross Combination Weights (GCW)
			Front axle	Rear axle	Braked	Unbraked	
L1 H1/H2 Panel Van	2700	2800	1585	1650	2000	750	4800
	2700 BiTurbo	2820	1585	1650	2000	750	4820
	2900	2960	1585	1650	2000	750	4960
	2900 BiTurbo	2980	1585	1650	2000	750	4980
L2 H1 Panel Van	2900	3030	1585	1650	2000	750	5030
	2900 BiTurbo	3040	1585	1650	2000	750	5040
L2 H2 Panel Van	2900 BiTurbo	3070	1585	1650	2000	750	5070

Gross plated weights (including axle weights) quoted on the vehicle plate are to UK plated weight specification and must never be exceeded. For further information please see Glossary of Terms.

## LOADSPACE VOLUMES CU.M (CU.FT.) – PANEL VAN

	L1	L2
H1 Panel Van	5.2 (183.6)	6.0 (211.9)
H2 Panel Van	7.2 (254.3)	8.6 (303.7)

# VIVARO DOUBLECAB SPECIFICATIONS

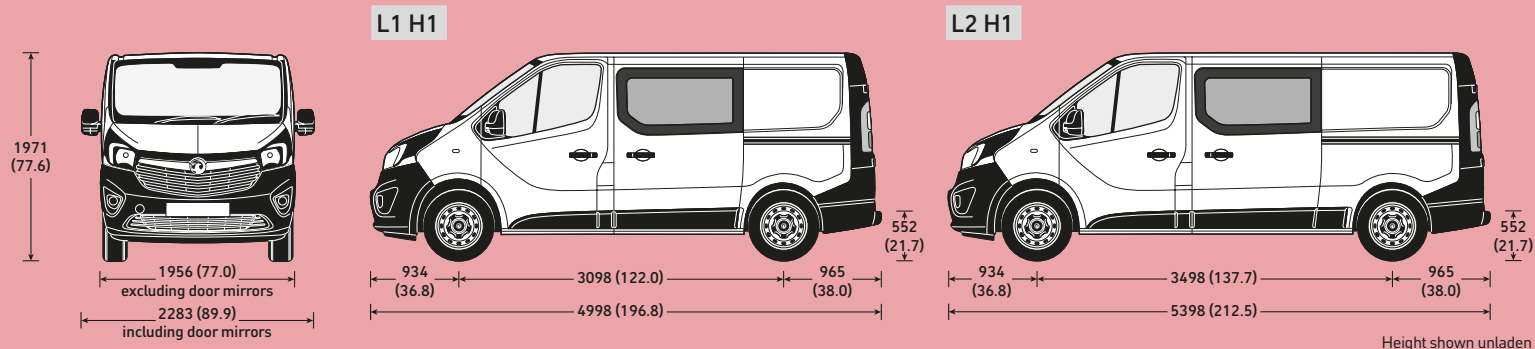

Height shown unladen

## LOADSPACE DIMENSIONS MM (INCHES) – DOUBLECAB

	L1	L2
Maximum length at load floor	2023 (79.6)	2423 (95.4)
Maximum length behind rear seats	1340 (42.7)	1740 (68.5)
Maximum width	1662 (65.5)	1662 (65.5)
Width between wheel arches	1268 (49.9)	1268 (49.9)
Maximum height	1387 (54.6)	1387 (54.6)

## LOADSPACE ACCESS MM (INCHES) – DOUBLECAB

	L1	L2
Side door aperture height	1284 (50.5)	1284 (50.5)
Side door aperture width	1030 (40.5)	1030 (40.5)
Rear door aperture height	1320 (52.0)	1320 (52.0)
Rear door aperture width	1391 (54.8)	1391 (54.8)
Loading height (unladen)	552 (21.7)	552 (21.7)

## LOADSPACE VOLUMES CU.M (CU.FT.) – DOUBLECAB

	L1	L2
Doublecab	3.2 (113.0)	4.0 (141.3)

## PLATED WEIGHTS AND TOWING DATA KG – DOUBLECAB

Model		Gross Vehicle Weights (GVW)	Plated weights		Towing weights		Plated Gross Combination Weights (GCW)
			Front axle	Rear axle	Braked	Unbraked	
L1 H1 Doublecab	2900	2834	1585	1650	2000	750	4834
	2900 BiTurbo	2844	1585	1650	2000	750	4844
L2 H1 Doublecab	2900	2940	1585	1650	2000	750	4940
	2900 BiTurbo	2950	1585	1650	2000	750	4950

Gross plated weights (including axle weights) quoted on the vehicle plate are to UK plated weight specification and must never be exceeded. For further information please see Glossary of Terms.

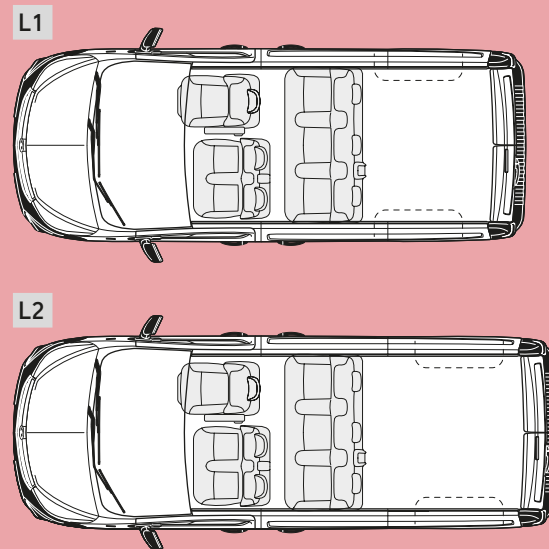

# VIVARO COMBI SPECIFICATIONS

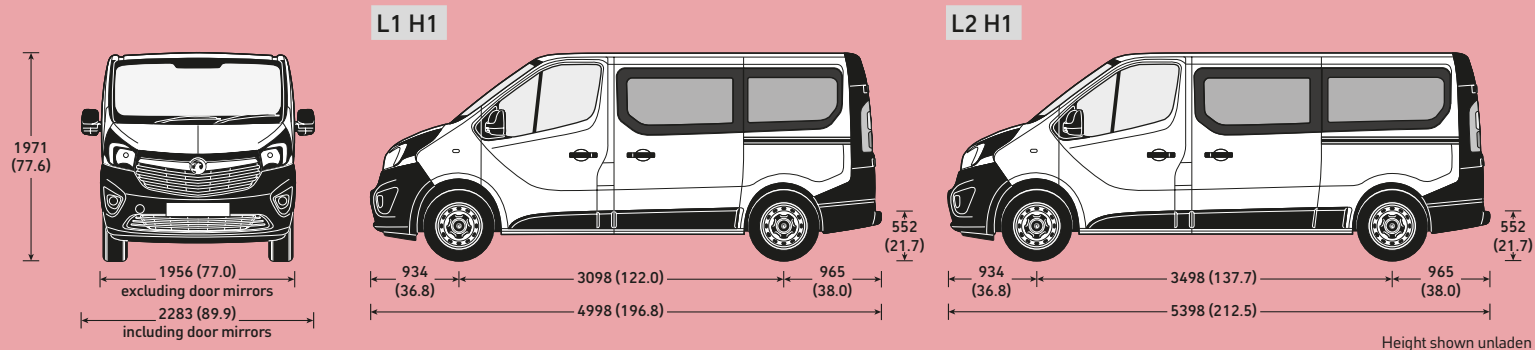

Height shown unladen

## LOADSPACE DIMENSIONS MM (INCHES) – COMBI

	L1	L2
Maximum length behind rear seats	736 (30.0)	1136 (44.7)
Maximum width	1662 (65.5)	1662 (65.5)
Width between wheel arches	1268 (49.9)	1268 (49.9)
Maximum height	1369 (53.9)	1369 (53.9)

## LOADSPACE ACCESS MM (INCHES) – COMBI

	L1	L2
Side door aperture height	1284 (50.5)	1284 (50.5)
Side door aperture width	1030 (40.5)	1030 (40.5)
Rear door aperture height	1320 (52.0)	1320 (52.0)
Rear door aperture width (at floor)	1391 (54.8)	1391 (54.8)
Loading height (unladen)	552 (21.7)	552 (21.7)

## LOADSPACE VOLUMES CU.M (CU.FT.) – COMBI

	L1	L2
Combi	1.0 (35.3)	1.8 (63.6)
Combi – third-row seats down	2.1 (74.2)	2.9 (102.4)
Combi – third-row seats removed	3.2 (113.0)	4.0 (141.3)

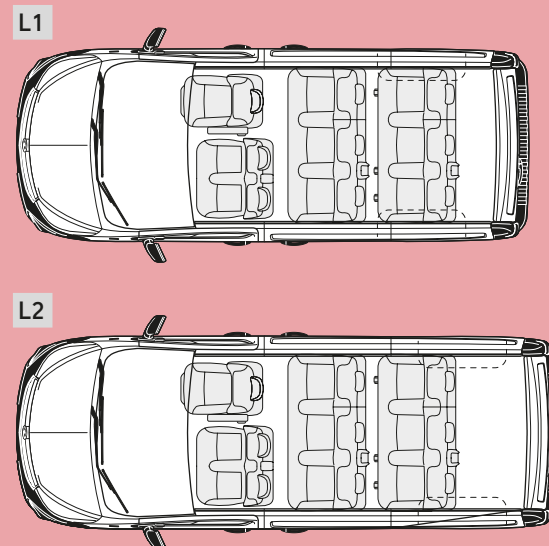

## PLATED WEIGHTS AND TOWING DATA KG – COMBI

Model		Gross Vehicle Weights (GVW)	Plated weights		Towing weights		Plated Gross Combination Weights (GCW)
			Front axle	Rear axle	Braked	Unbraked	
L1 H1 Combi	2900	2880	1585	1650	2000	750	4880
	2900 BiTurbo	2970	1585	1650	2000	750	4970
L2 H1 Combi	2900	3010	1585	1650	2000	750	5010
	2900 BiTurbo	3020	1585	1650	2000	750	5020

Gross plated weights (including axle weights) quoted on the vehicle plate are to UK plated weight specification and must never be exceeded. For further information please see Glossary of Terms.

# VIVARO PLATFORM CAB SPECIFICATIONS

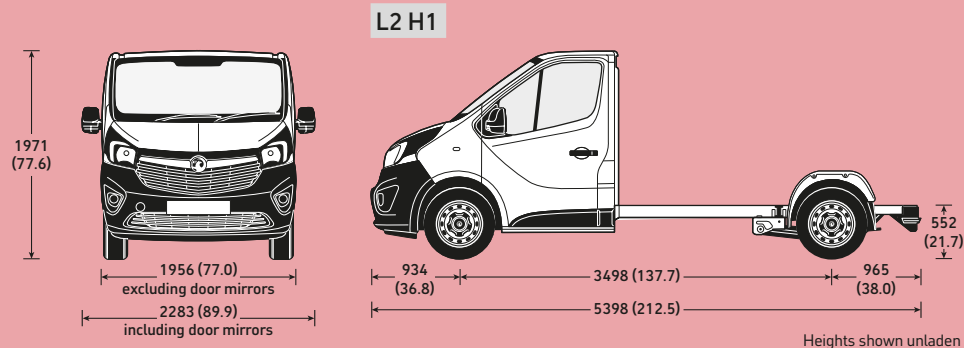

## Platform cabs

Platform cabs are ideal for those conversions requiring a low floor and walk-through access from the cab. The interface panel makes for easy integration of the cab with the conversion body, while an extended-length wiring loom is available to power the rear lights or extended conversions.

All conversions must follow 'Conversion Requirements' guidelines available on: [www.vauxhall.co.uk/conversiondata](http://www.vauxhall.co.uk/conversiondata)

## PLATED WEIGHTS AND TOWING DATA KG – PLATFORM CAB

Model	Gross Vehicle Weights (GVW)	Plated weights		Towing weights		Plated Gross Combination Weights (GCW)	
		Front axle	Rear axle	Braked	Unbraked		
L2 H1 Platform Cab	2900 BiTurbo	3030	1585	1735	2000	750	5030

Gross plated weights (including axle weights) quoted on the vehicle plate are to UK plated weight specification and must never be exceeded. For further information please see Glossary of Terms.

# MOVANO SPECIFICATIONS – Final

## ENGINES

	2.3CDTi (110PS) BlueInjection	2.3CDTi (130PS) BlueInjection	2.3CDTi BiTurbo (130PS) BlueInjection	2.3CDTi BiTurbo (145PS) BlueInjection with Start/Stop
Capacity	2298cc	2298cc	2298cc	2298cc
Maximum power	110PS (81kW) @ 3500rpm	130PS (96kW) @ 3500rpm	130PS (96kW) @ 3500rpm	145PS (107kW) @ 3500rpm
Maximum torque	290Nm (214 lb.ft.) @ 1500rpm	320Nm (236 lb.ft.) @ 1500rpm	330Nm (243 lb.ft.) @ 1500rpm	360Nm (266 lb.ft.) @ 1500rpm
Configuration	4 cylinders, 4 valves per cylinder, double overhead camshafts			
Fuel/induction system	Fixed geometry turbocharger and intercooler. Common rail fuel injection		Twin variable geometry turbochargers and intercoolers. Common rail fuel injection	
Emission compliance	Euro 6	Euro 6	Euro VI	Euro 6 (FWD) / Euro VI (RWD)
Service interval	25,000 miles (20,000 miles on Minibus models) or two years (whichever occurs sooner)			

	2.3CDTi BiTurbo (163PS) BlueInjection with Start/Stop	2.3CDTi BiTurbo (170PS) BlueInjection with Start/Stop
Capacity	2298cc	2298cc
Maximum power	163PS (120kW) @ 3500rpm	170PS (125kW) @ 3500rpm
Maximum torque	360Nm (266 lb.ft.) @ 1500-2750rpm	380Nm (280 lb.ft.) @ 1500rpm
Configuration	4 cylinders, 4 valves per cylinder, double overhead camshafts	
Fuel/induction system	Twin variable geometry turbochargers and intercoolers. Common rail fuel injection	
Emission compliance	Euro VI	Euro 6
Service interval	25,000 miles or two years (whichever occurs sooner)	

Vehicles with BlueInjection technology will need regular AdBlue® top-ups also between servicing requirements. An indicator integrated into the on-board computer will warn you when you need to top up. More information under [www.vauxhall.co.uk/blueinjection](http://www.vauxhall.co.uk/blueinjection). In accordance with regulations R (EC) No. 715/2007 and R (EC) No. 692/2008 (in the versions respectively applicable).

# MOVANO FWD PANEL VAN SPECIFICATIONS – Final

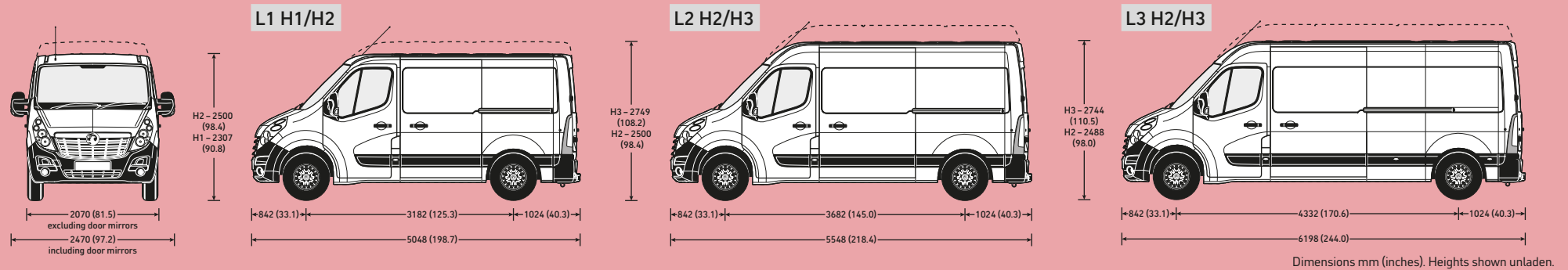

Dimensions mm (inches). Heights shown unladen.

## LOADSPACE DIMENSIONS MM (INCHES) – FWD PANEL VAN

	L1	L2	L3
Maximum length	2583 (101.7)	3083 (121.4)	3733 (147.0)
Maximum width	1765 (69.5)	1765 (69.5)	1765 (69.5)
Width between wheel arches	1380 (54.3)	1380 (54.3)	1380 (54.3)
Maximum height – H1	1700 (66.9)	–	–
Maximum height – H2	1894 (74.6)	1894 (74.6)	1894 (74.6)
Maximum height – H3	–	2144 (84.4)	2144 (84.4)

## LOADSPACE ACCESS MM (INCHES) – FWD PANEL VAN

	L1	L2	L3
Side door aperture height – H1	1581 (62.2)	–	–
Side door aperture height – H2/H3	1780 (70.1)	1780 (70.1)	1780 (70.1)
Side door aperture width	1050 (41.3)	1270 (50.0)	1270 (50.0)
Rear door aperture height – H1	1627 (64.0)	–	–
Rear door aperture height – H2/H3	1820 (71.7)	1820 (71.7)	1820 (71.7)
Rear door aperture width	1577 (62.1)	1577 (62.1)	1577 (62.1)
Loading height (unladen)	563 (22.2)	562 (22.1)	557 (21.9)

## PLATED WEIGHTS AND TOWING DATA KG – PANEL VAN

Model		Gross Vehicle Weights (GVW)	Plated weights		Towing weights		Plated Gross Combination Weights (GCW)
			Front axle	Rear axle	Braked	Unbraked	
L1 H1 Panel Van	F2800	2800	1550	1650	2500	750	5300
	F3300	3300	1650	1900	2500	750	5800
	F3500	3500	1850	2100	2500	750	6000
L1 H2 Panel Van	F2800	2800	1650	1900	2500	750	5300
	F3300	3300	1650	1900	2500	750	5800
	F3500	3500	1850	2100	2500	750	6000
L2 H2/H3 Panel Van	F3300	3300	1650	1900	2500	750	5800
	F3500	3500	1850	2100	2500	750	6000
L3 H2/H3 Panel Van	F3300	3300	1650	1900	2500	750	5800
	F3500	3500	1850	2100	2500	750	6000

Gross plated weights (including axle weights) quoted on the vehicle plate are to UK plated weight specification and must never be exceeded. For further information please see Glossary of Terms.



# MOVANO FWD DOUBLECAB SPECIFICATIONS – Final

L2 H2

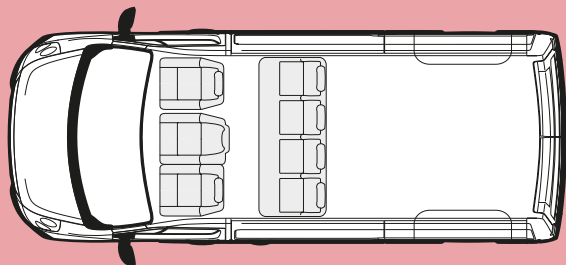

L3 H2

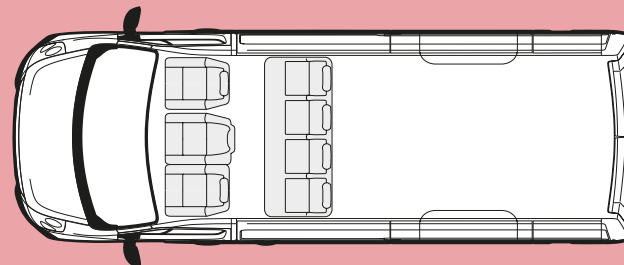

For exterior dimensions see FWD Panel Van.

## LOADSPACE DIMENSIONS MM (INCHES) – FWD DOUBLECAB

	L2	L3
Maximum length at load floor	2175 (85.6)	2825 (111.2)
Maximum length behind rear seats	1990 (78.3)	2640 (103.9)
Maximum width	1765 (69.5)	1765 (69.5)
Width between wheel arches	1380 (54.3)	1380 (54.3)
Maximum height	1894 (74.6)	1894 (74.6)

## LOADSPACE ACCESS MM (INCHES) – FWD DOUBLECAB

	L2	L3
Side door aperture height	1780 (70.1)	1780 (70.1)
Side door aperture width	1270 (50.0)	1270 (50.0)
Rear door aperture height	1820 (71.7)	1820 (71.7)
Rear door aperture width	1577 (62.1)	1577 (62.1)
Loading height (unladen)	562 (22.1)	557 (21.9)

## PLATED WEIGHTS AND TOWING DATA KG – DOUBLECAB

Model	Gross Vehicle Weights (GVW)	Plated weights		Towing weights		Plated Gross Combination Weights (GCW)	
		Front axle	Rear axle	Braked	Unbraked		
L2 H2/L3 H2 Doublecab	F3500	3500	1850	2100	3500	750	6000

Gross plated weights (including axle weights) quoted on the vehicle plate are to UK plated weight specification and must never be exceeded. For further information please see Glossary of Terms.

## LOADSPACE VOLUMES CU.M (CU.FT.) – FWD DOUBLECAB

	L2 H2	L3 H2
Doublecab	6.9 (244)	9.0 (318)

# MOVANO RWD DOUBLECAB SPECIFICATIONS – Provisional

L3 H2

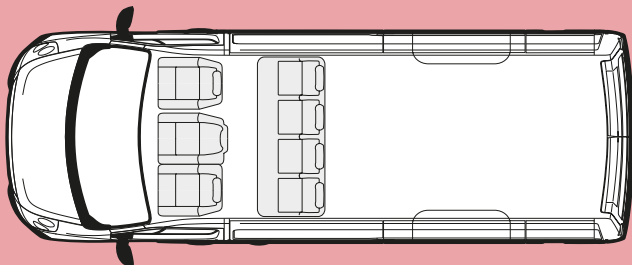

For exterior dimensions see RWD Panel Van.

## LOADSPACE DIMENSIONS MM (INCHES) – RWD DOUBLECAB

	L3
Maximum length at load floor	2825 (111.2)
Maximum length behind rear seats	2640 (103.9)
Maximum width	1765 (69.5)
Width between wheel arches	1380 (54.3)
Maximum height	1798 (70.8)

## LOADSPACE ACCESS MM (INCHES) – RWD DOUBLECAB

	L3
Side door aperture height	1684 (66.3)
Side door aperture width	1270 (50.0)
Rear door aperture height	1724 (67.9)
Rear door aperture width	1577 (62.1)
Loading heights (unladen)	674 (26.5) – 696 (27.4)

## PLATED WEIGHTS AND TOWING DATA KG – DOUBLECAB

Model	Gross Vehicle Weights (GVW)	Plated weights		Towing weights		Plated Gross Combination Weights (GCW)
		Front axle	Rear axle	Braked	Unbraked	
L3 H2 Doublecab	R3500	3500	1850 2300	3500	750	6000

Gross plated weights (including axle weights) quoted on the vehicle plate are to UK plated weight specification and must never be exceeded. For further information please see Glossary of Terms.

## LOADSPACE VOLUMES CU.M (CU.FT.) – RWD DOUBLECAB

	L3 H2
Doublecab	8.4 (297)

# MOVANO RWD PANEL VAN SPECIFICATIONS – Final

**L3 H2/H3**

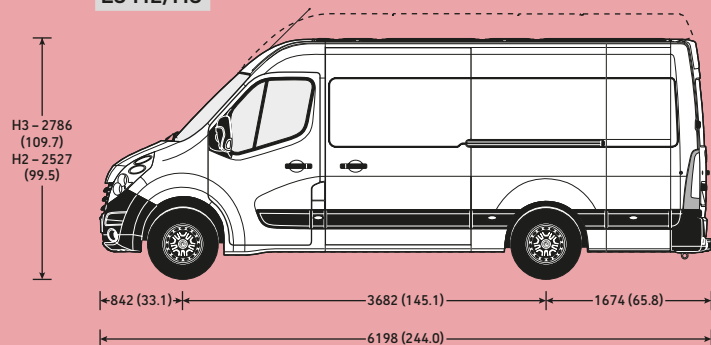

**L4 H2/H3**

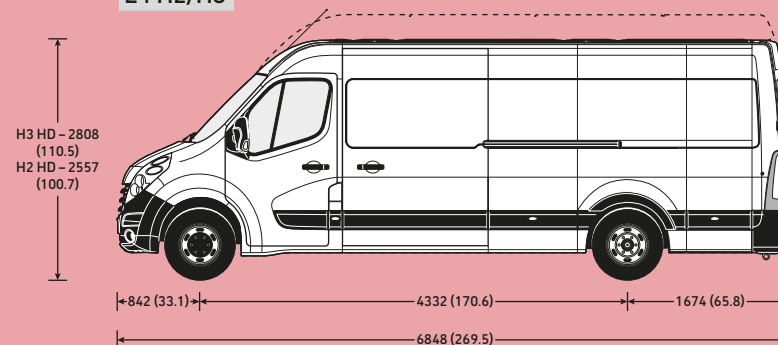

Dimensions mm (inches). Heights shown unladen.

## LOADSPACE DIMENSIONS MM (INCHES) – RWD PANEL VAN

	L3	L4
Maximum length	3733 (147.0)	4383 (172.6)
Maximum width	1765 (69.5)	1765 (69.5)
Width between wheel arches	1380 (54.3)	1380 (54.3)
Maximum height – H2	1798 (70.8)	1798 (70.8)
Maximum height – H3	2048 (80.6)	2048 (80.6)

## LOADSPACE ACCESS MM (INCHES) – RWD PANEL VAN

	L3	L4
Side door aperture height	1684 (66.3)	1684 (66.3)
Side door aperture width	1270 (50.0)	1270 (50.0)
Rear door aperture height	1724 (67.9)	1724 (67.9)
Rear door aperture width	1577 (62.1)	1577 (62.1)
Loading heights (unladen)	696 (27.4) – 724 (28.5)	717 (28.2)

## PLATED WEIGHTS AND TOWING DATA KG – RWD PANEL VAN

Model	R3500	Gross Vehicle Weights (GVW)	Plated weights		Towing weights		Plated Gross Combination Weights (GCW)
			Front axle	Rear axle	Braked	Unbraked	
L3 H2/H3 Panel Van	R3500	3500	1850	2300	2500	750	6000
L4 H2/H3 Panel Van	R3500	3500	1850	2300	2500	750	6000

Gross plated weights (including axle weights) quoted on the vehicle plate are to UK plated weight specification and must never be exceeded. For further information please see Glossary of Terms.

## LOADSPACE VOLUMES CU.M (CU.FT) – RWD PANEL VAN

	L3 H2	L3 H3	L4 H2	L4 H3
Panel Van – Maximum	12.4 (438)	14.2 (501)	14.9 (526)	17.0 (600)
– VDA	10.9 (385)	12.2 (431)	12.9 (456)	14.1 (498)

# MOVANO RWD HD PANEL VAN SPECIFICATIONS – Final

**L3 H2/H3**

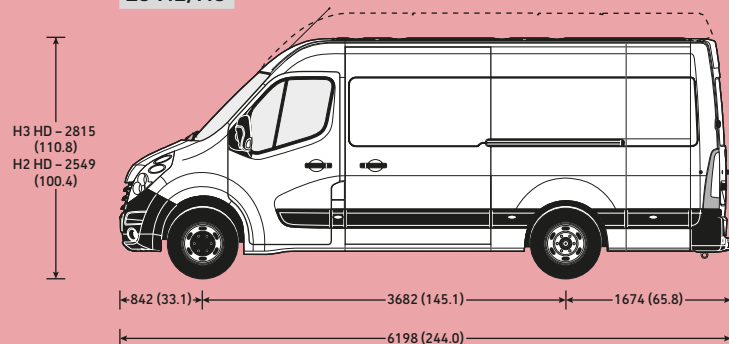

**L4 H2/H3**

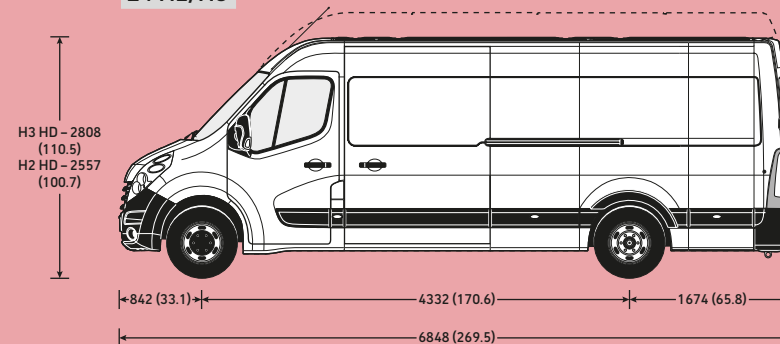

Dimensions mm (inches). Heights shown unladen.

## LOADSPACE DIMENSIONS MM (INCHES) – RWD HD PANEL VAN

	L3	L4
Maximum length	3733 (147.0)	4383 (172.6)
Maximum width	1765 (69.5)	1765 (69.5)
Width between wheel arches	1080 (42.5)	1080 (42.5)
Maximum height – H2	1798 (70.8)	1798 (70.8)
Maximum height – H3	2048 (80.6)	2048 (80.6)

## LOADSPACE ACCESS MM (INCHES) – RWD HD PANEL VAN

	L3	L4
Side door aperture height	1684 (66.3)	1684 (66.3)
Side door aperture width	1270 (50.0)	1270 (50.0)
Rear door aperture height	1724 (67.9)	1724 (67.9)
Rear door aperture width	1577 (62.1)	1577 (62.1)
Loading heights	723 (28.4) – 724 (28.5)	717 (28.2)

## PLATED WEIGHTS AND TOWING DATA KG – RWD HD PANEL VAN

Model		Gross Vehicle Weights (GVW)	Plated weights		Towing weights		Plated Gross Combination Weights (GCW)
			Front axle	Rear axle	Braked	Unbraked	
L3 H2/H3 Panel Van	R3500HD	3500	1850	2800	3000	750	6500
L3 H2/H3 Panel Van	R4500HD	4500	1850	3200	3000	750	7500
L4 H2/H3 Panel Van	R3500HD	3500	1850	2800	3000	750	6500
L4 H2/H3 Panel Van	R4500HD	4500	1850	3200	3000	750	7500

Gross plated weights (including axle weights) quoted on the vehicle plate are to UK plated weight specification and must never be exceeded. For further information please see Glossary of Terms.

## LOADSPACE VOLUMES CU.M (CU.FT.) – RWD HD PANEL VAN

	L3 H2	L3 H3	L4 H2	L4 H3
Panel Van – Maximum	12.4 (438)	14.2 (501)	14.9 (526)	17.0 (600)
– VDA	10.7 (378)	12.0 (424)	12.7 (448)	13.9 (491)

# MOVANO TIPPER / CREW CAB TIPPER SPECIFICATIONS – Final

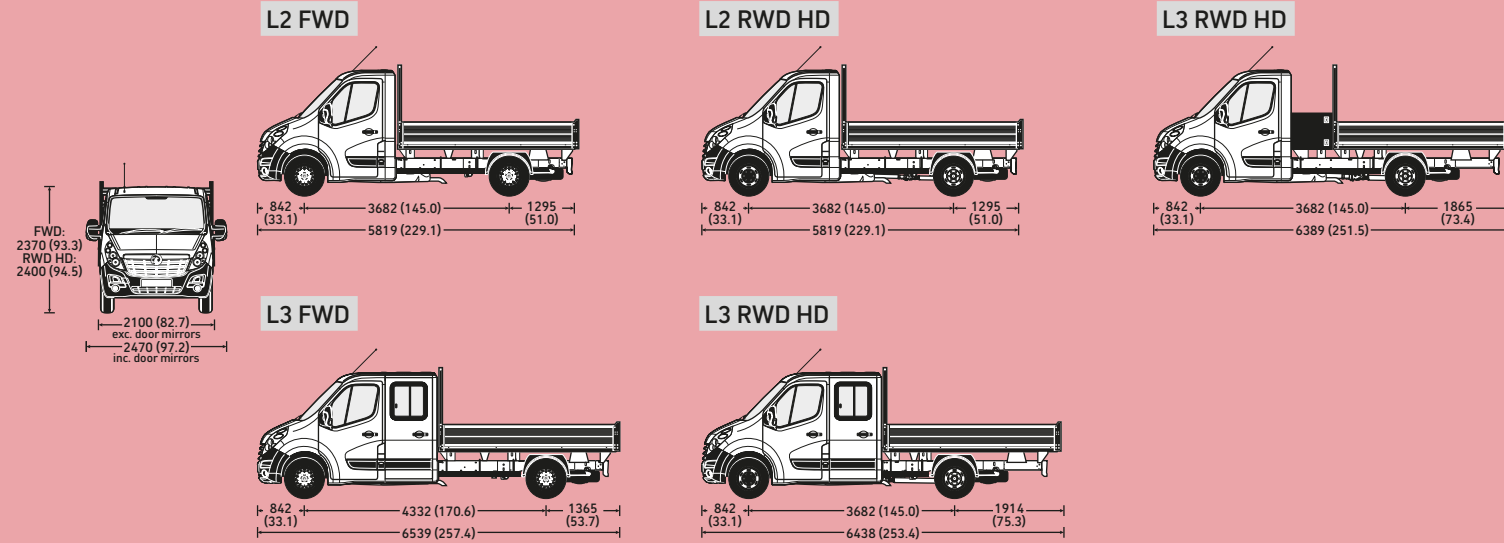

LOADSPACE AREA DIMENSIONS MM (IN) – TIPPER			
	L2 FWD	L2 RWD HD	L3 RWD HD
Maximum length	3205 (126.2)	3205 (126.2)	3105 (122.2)
Maximum width	2040 (80.3)	2040 (80.3)	2040 (80.3)
Body side height	400 (15.7)	400 (15.7)	400 (15.7)
Loading height (unladen)	1090 (42.9)	1090 (42.9)	1090 (42.9)
Load area sq.m (sq.ft.)	6.5 (69.4)	6.5 (69.4)	6.3 (68.2)

LOADSPACE AREA DIMENSIONS MM (IN) – CREW CAB TIPPER		
	L3 FWD	L3 RWD HD
Maximum length	3205 (126.2)	3105 (122.2)
Maximum width	2040 (80.3)	2040 (80.3)
Body side height	400 (15.7)	400 (15.7)
Loading height (unladen)	1090 (42.9)	1090 (42.9)
Load area sq.m (sq.ft.)	6.5 (69.4)	6.3 (68.2)

# MOVANO DROPSIDE SPECIFICATIONS – Final

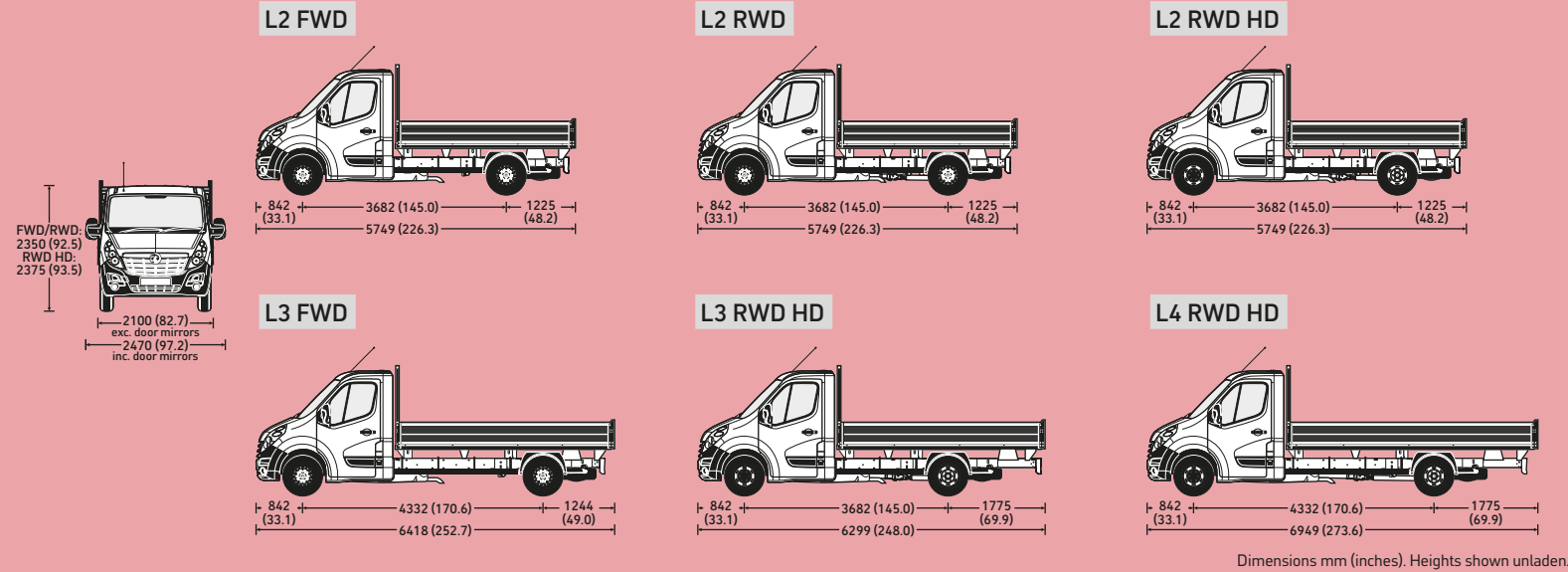

LOADSPACE AREA DIMENSIONS MM (IN) – DROPSIDE					
	L2 FWD	L3 FWD	L2 RWD / RWD HD	L3 RWD HD	L4 RWD HD
Maximum length	3170 (124.8)	3900 (153.5)	3170 (124.8)	3700 (145.7)	4470 (176.0)
Maximum width	2040 (80.3)	2040 (80.3)	2040 (80.3)	2040 (80.3)	2040 (80.3)
Body side height	400 (15.7)	400 (15.7)	400 (15.7)	400 (15.7)	400 (15.7)
Loading height (unladen)	1026 (40.4)	1026 (40.4)	1026 (40.4)	1026 (40.4)	1026 (40.4)
Load area sq.m (sq.ft.)	6.5 (70.0)	7.8 (83.9)	6.5 (70.0)	7.6 (81.8)	8.9 (95.8)

# MOVANO DROPSIDE CREW CAB SPECIFICATIONS – Final

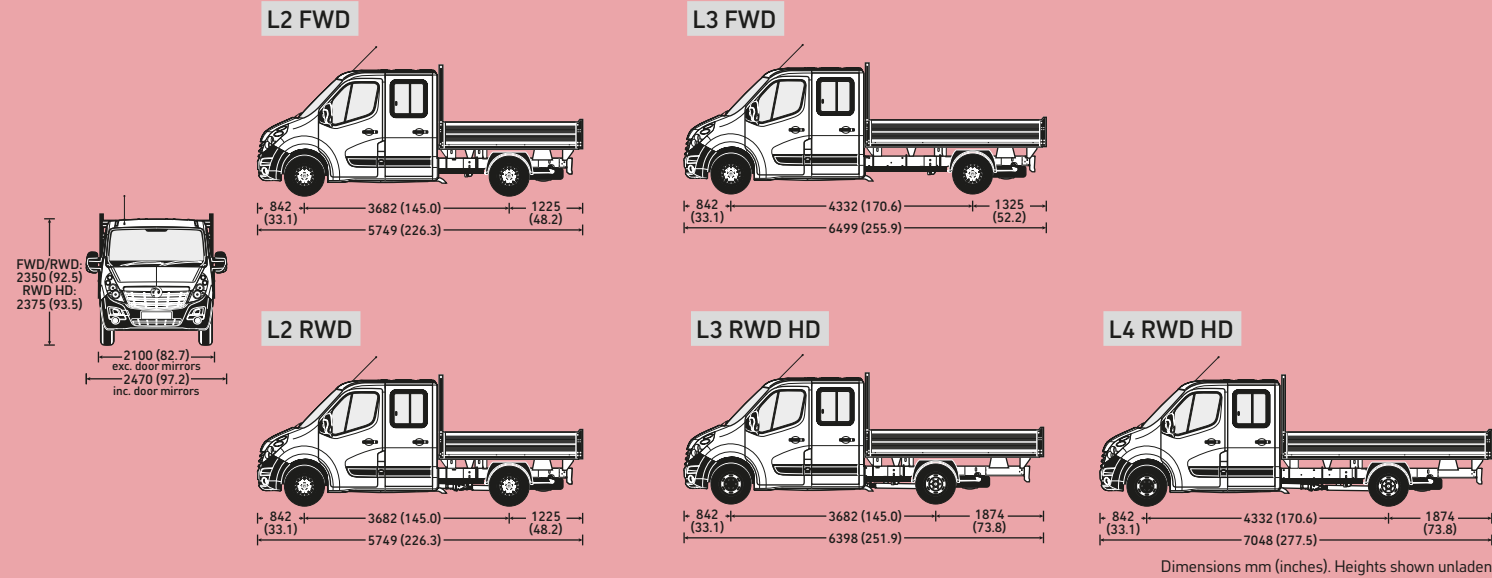

LOADSPACE AREA DIMENSIONS MM (IN) – DROPSIDE CREW CAB					
	L2 FWD	L3 FWD	L2 RWD	L3 RWD HD	L4 RWD HD
Maximum length	2501 (98.5)	3170 (124.8)	2501 (98.5)	3070 (120.9)	3702 (145.7)
Maximum width	2040 (80.3)	2040 (80.3)	2040 (80.3)	2040 (80.3)	2040 (80.3)
Body side height	400 (15.7)	400 (15.7)	400 (15.7)	400 (15.7)	400 (15.7)
Loading height (unladen)	1026 (40.4)	1026 (40.4)	1026 (40.4)	1026 (40.4)	1026 (40.4)
Load area sq.m (sq.ft.)	4.9 (52.7)	6.5 (70.0)	4.9 (52.7)	6.3 (67.8)	7.6 (81.8)

# MOVANO BOX VAN SPECIFICATIONS – Final

**L3 FWD/RWD (20cu.m)**

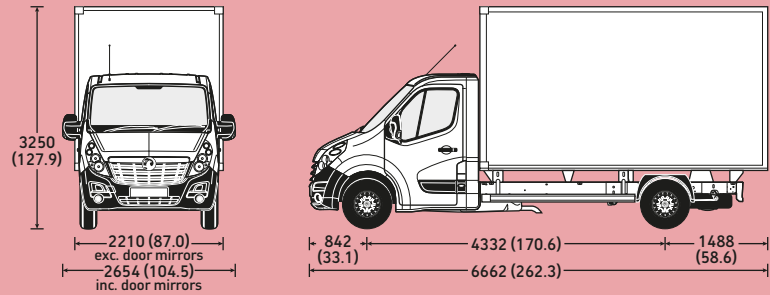

**L4 RWD HD (20cu.m)**

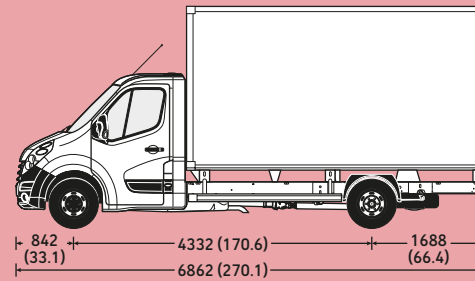

**L4 RWD HD (22cu.m)**

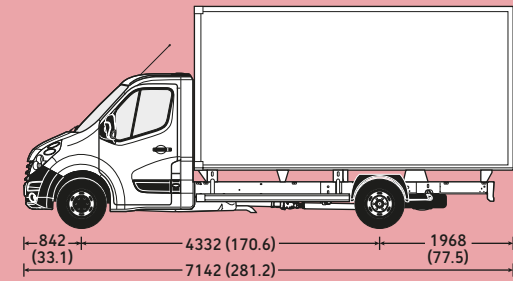

Dimensions mm (inches). Heights shown unladen.

## LOADSPACE DIMENSIONS MM (INCHES) – BOX VAN

	<b>L3 20cu.m FWD/RWD</b>	<b>L4 20cu.m RWD</b>	<b>L4 22cu.m RWD</b>
Maximum internal length	4100 (161.4)	4300 (169.3)	4580 (180.3)
Maximum internal width	2150 (84.6)	2150 (84.6)	2150 (84.6)
Maximum internal height	2200 (86.6)	2200 (86.6)	2200 (86.6)
Loading height (unladen)	1050 (41.3)	1050 (41.3)	1050 (41.3)

## LOADSPACE VOLUME CU.M (CU.FT.) – BOX VAN

VDA method	19.4 (685.1)	20.3 (716.9)	21.7 (766.3)
------------	--------------	--------------	--------------



# MOVANO COMBI / MINIBUS SPECIFICATIONS – Final

L1 H1 9-SEAT

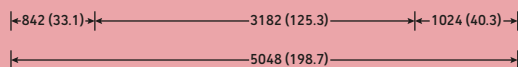
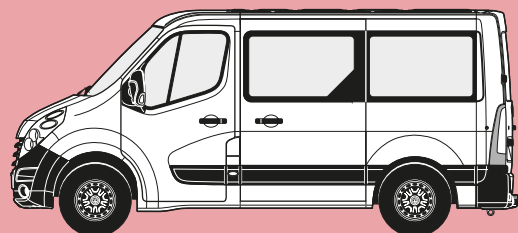

L2 H2 9-SEAT

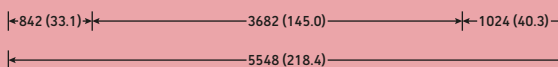
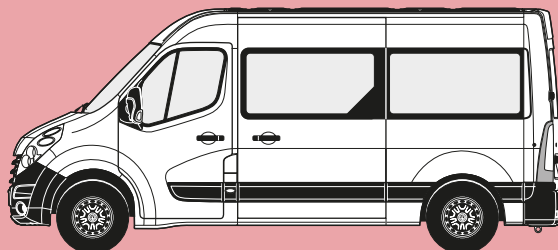

L1 H1 / L2 H2 9-SEAT

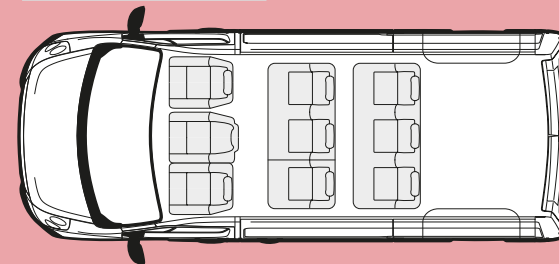

L3 H2 17-SEAT

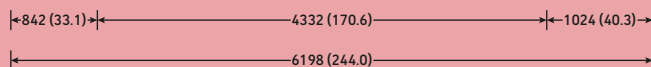
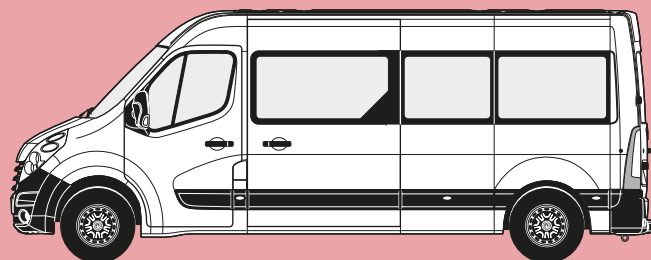

L3 H2 17-SEAT

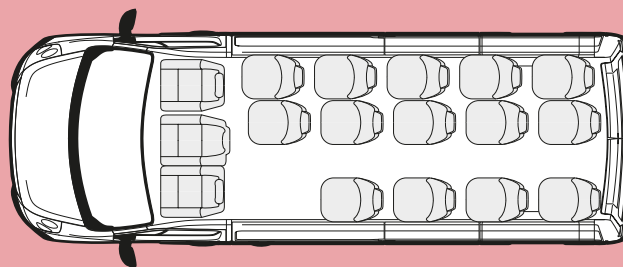

Measurements are shown in millimetres (inches).

## PLATED WEIGHTS AND TOWING DATA KG – COMBI / MINIBUS

Model	Gross Vehicle Weights (GVW)	Plated weights		Towing weights		Plated Gross Combination Weights (GCW)	
		Front axle	Rear axle	Braked	Unbraked		
L1 H1 Combi	F3300	3300	1650	1900	2500	750	5800
L2 H2 Combi	F3500	3500	1850	2100	2500	750	6000
L3 H2 Minibus	F3960	3960	1850	2100	n/a	n/a	n/a

Gross plated weights (including axle weights) quoted on the vehicle plate are to UK plated weight specification and must never be exceeded. For further information please see Glossary of Terms.

# MOVANO CHASSIS CAB SPECIFICATIONS – Final

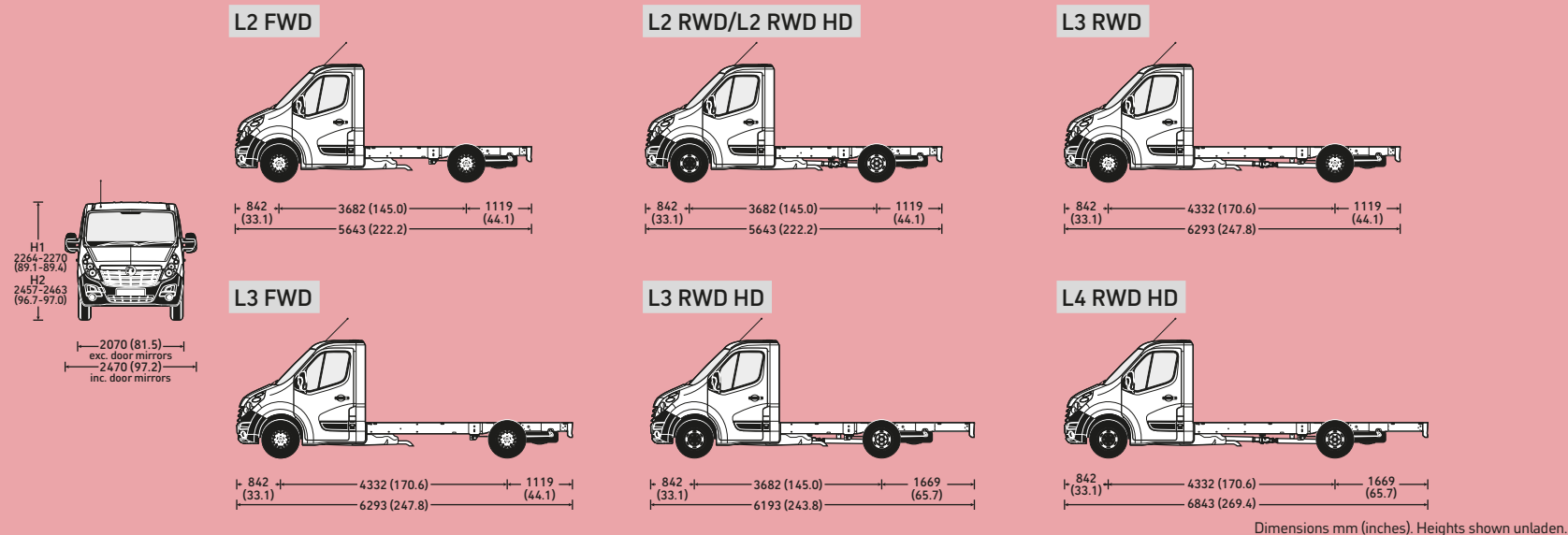

All conversions must follow 'Vauxhall Convertor Requirements' including recommended dimensional data, detailed within Part 1, available at: [www.vauxhall.co.uk/conversiondata](http://www.vauxhall.co.uk/conversiondata). The weight of any fitted conversion body will have to be deducted from these figures to establish actual payload and is subject to correct weight distribution. Variations from the recommended dimensions or weights may affect the vehicle's overall centre of gravity and stability. From 29 April 2013 conversion of N1 vehicles was affected by changes to type approval – for further information refer to the VCA website (N2 vehicles were affected from 29 October 2014). For further information please contact [conversions@vauxhall.co.uk](mailto:conversions@vauxhall.co.uk)

PLATED WEIGHTS AND TOWING DATA KG – CHASSIS CAB							
Model		Gross Vehicle Weights (GVW)	Plated weights		Towing weights		Plated Gross Combination Weights (GCW)
			Front axle	Rear axle	Braked	Unbraked	
L2 H1/L3 H1/L4 H1 Chassis	F3500	3500	1850	2100	2500	750	6000
	R3500	3500	1850	2300	2500	750	6000
	R3500HD	3500	1850	2800	3500	750	7000
	R4500HD	4500	1850	3200	3000	750	7500

Gross plated weights (including axle weights) quoted on the vehicle plate are to UK plated weight specification and must never be exceeded. For further information please see Glossary of Terms.

# MOVANO CHASSIS CREW CAB SPECIFICATIONS – Final

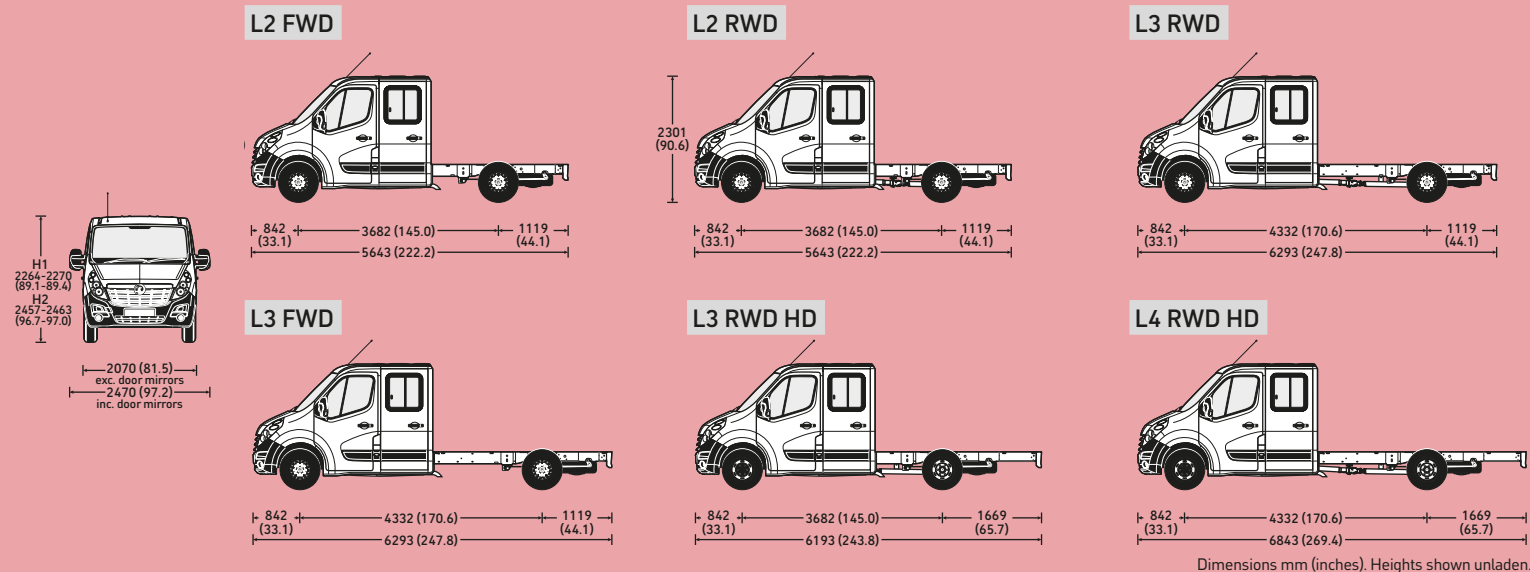

All conversions must follow 'Vauxhall Convertor Requirements' including recommended dimensional data, detailed within Part 1, available at: [www.vauxhall.co.uk/conversiondata](http://www.vauxhall.co.uk/conversiondata). The weight of any fitted conversion body will have to be deducted from these figures to establish actual payload and is subject to correct weight distribution. Variations from the recommended dimensions or weights may affect the vehicle's overall centre of gravity and stability. From 29 April 2013 conversion of N1 vehicles was affected by changes to type approval – for further information refer to the VCA website (N2 vehicles were affected from 29 October 2014). For further information please contact [conversions@vauxhall.co.uk](mailto:conversions@vauxhall.co.uk)

## PLATED WEIGHTS AND TOWING DATA KG – CHASSIS CREW CAB

Model	Gross Vehicle Weights (GVW)	Plated weights		Towing weights		Plated Gross Combination Weights (GCW)	
		Front axle	Rear axle	Braked	Unbraked		
L2 H1/L3 H1/L4 H1 Chassis Crew Cab	F3500	3500	1850	2100	2500	750	6000
	R3500	3500	1850	2300	2500	750	6000
	R3500HD	3500	1850	2800	3500	750	7000
	R4500HD	4500	1850	3200	3000	750	7500

Gross plated weights (including axle weights) quoted on the vehicle plate are to UK plated weight specification and must never be exceeded. For further information please see Glossary of Terms.

# MOVANO PLATFORM CAB SPECIFICATIONS – Final

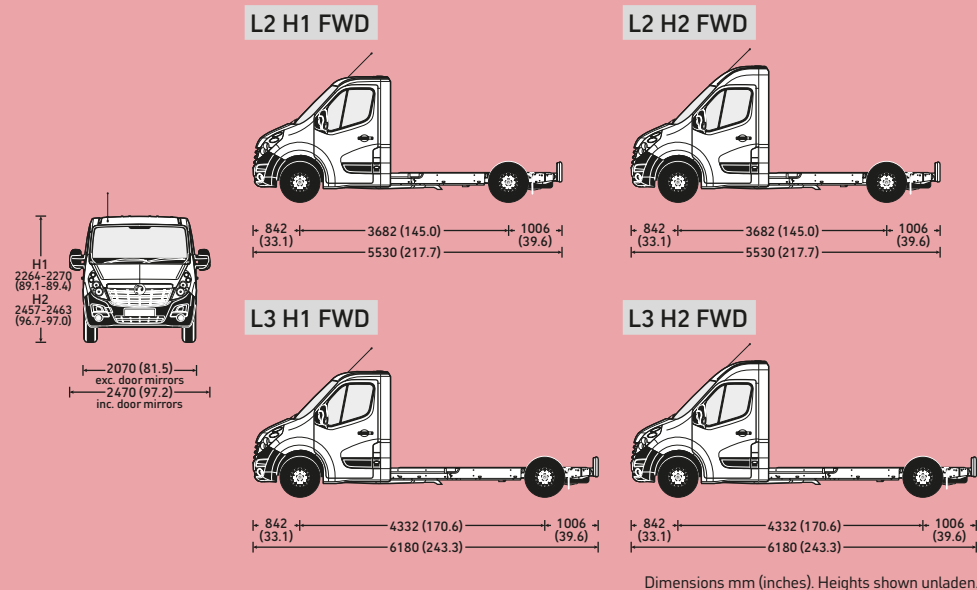

All conversions must follow 'Vauxhall Convertor Requirements' including recommended dimensional data, detailed within Part 1, available at: [www.vauxhall.co.uk/conversiondata](http://www.vauxhall.co.uk/conversiondata). The weight of any fitted conversion body will have to be deducted from these figures to establish actual payload and is subject to correct weight distribution. Variations from the recommended dimensions or weights may affect the vehicle's overall centre of gravity and stability. From 29 April 2013 conversion of N1 vehicles was affected by changes to type approval – for further information refer to the VCA website (N2 vehicles were affected from 29 October 2014). For further information please contact [conversions@vauxhall.co.uk](mailto:conversions@vauxhall.co.uk)

## PLATED WEIGHTS AND TOWING DATA KG – PLATFORM CAB

Model	F3500	Gross Vehicle Weights (GVW)	Plated weights		Towing weights		Plated Gross Combination Weights (GCW)
			Front axle	Rear axle	Braked	Unbraked	
<b>L2 H1/L2 H2/L3 H1/ L3 H2 Platform Cab</b>		3500	1850	2100	2500	750	6000

Gross plated weights (including axle weights) quoted on the vehicle plate are to UK plated weight specification and must never be exceeded. For further information please see Glossary of Terms.

# CORSAVAN ACCESSORIES

## INFOTAINMENT Total (exc. VAT)

### Sat Nav updates<sup>1</sup>

Please consult your Retailer for latest map updates or visit [www.vauxhall.co.uk/accessories](http://www.vauxhall.co.uk/accessories).

<sup>1</sup> = For use with optional factory-fit satellite navigation systems.

## SAFETY

Safety pack – first aid kit, warning triangle, hi-visibility vest	£30.00
First aid kit	£12.00
Warning triangle	£14.00
Hi-visibility vest	£7.00
Fire extinguisher – 2kg	£59.00
Temporary tyre inflation kit	£125.00
Tyre sealant	£46.00

## PRACTICAL Total (exc. VAT)

Spare bulb kit	£16.00
Stretch tow rope – 3 tonne	£29.00

## SECURITY

Locking wheel bolts – set of four	£36.00
-----------------------------------	--------

## PROTECTION – INTERIOR

Rubber floor mats – front pair	£41.00
--------------------------------	--------

## PROTECTION – LOAD AREA

Hard cargo liner	£172.15
------------------	---------

## PROTECTION – EXTERIOR

Mudflaps – set of four <sup>3</sup>	£100.00
Rear parking distance sensors	£265.00

<sup>3</sup> = Not available with certain exterior styling accessories.

## ROOF CARRIER SYSTEM

T-track base carrier – two roof bars	£121.00
--------------------------------------	---------

### Please note:

Prices shown are fully fitted and painted where applicable.

All prices are exclusive of VAT.

It is advisable to ensure your insurance policy is adequate to cover additional fitted accessories.

Prices correct at time of publication.

# COMBO ACCESSORIES

	Total (exc. VAT)
<b>SAFETY</b>	
Safety pack – first aid kit, warning triangle, hi-visibility vest	£30.00
First aid kit	£12.00
Warning triangle	£14.00
Hi-visibility vest	£7.00
Fire extinguisher – 2kg	£59.00
Temporary tyre inflation kit	£125.00
Tyre sealant	£46.00
<b>PRACTICAL</b>	
Stretch tow rope – 3 tonne	£29.00
<b>SECURITY</b>	
Security alarm system	
– without pre-installation	£364.00
– with pre-installation	£335.00
Steering wheel security bar	£78.00
Locking wheel bolts – set of four	£41.00
Rear window grilles – rear doors, not tailgate	£131.00
<b>PROTECTION – INTERIOR</b>	
Heavy duty carpet mat	£18.00

	Total (exc. VAT)
<b>PROTECTION – LOAD AREA</b>	
Wooden floor protection	
– L1	£173.00
– L2	£205.00
Cargo liner (rigid)	£67.00
<b>PROTECTION – EXTERIOR</b>	
Mudflaps – rear pair only	£78.00
<b>ROOF CARRIER SYSTEM</b>	
Pair of roof bars (70kg) <sup>1</sup>	£178.00
Three roof bars (100kg) <sup>1</sup>	£282.00
Complete roof rack with spoiler and loading system (L1)	£517.00
Complete roof rack with spoiler and loading system (L2)	£571.00
<small><sup>1</sup> = Can only be used in conjunction with optional factory-fitted roof rails.</small>	
<b>TOWING</b>	
Fixed tow bar with 13-pin electrics	£544.67
Flange tow bar with 13-pin electrics	£550.65
Heavy duty tow bar with 13-pin electrics	£621.00
Removable tow bar with 13-pin electrics	£712.00

	Total (exc. VAT)
<b>INTERIOR STYLING</b>	
Sport pedal covers	£106.00
Leather gear knob / gaiter	
– bordeaux/black or grey/black	from £89.00
<b>EXTERIOR STYLING</b>	
Chromed door mirrors	£70.00

**Please note:**

Prices shown are fully fitted and painted where applicable.

All prices are exclusive of VAT.

It is advisable to ensure your insurance policy is adequate to cover additional fitted accessories.

Prices correct at time of publication.

# VIVARO ACCESSORIES

	Total (exc. VAT)
<b>SAFETY</b>	
Safety pack – first aid kit, warning triangle,	
hi-visibility vest	£30.00
First aid kit	£12.00
Warning triangle	£14.00
Hi-visibility vest	£7.00
Fire extinguisher – 2kg	£58.00
Temporary tyre inflation kit	£125.00
Tyre sealant	£46.00

	Total (exc. VAT)
<b>PRACTICAL</b>	
Spare bulb kit	£16.00
Stretch tow rope – 3 tonne	£29.00

	Total (exc. VAT)
<b>SECURITY</b>	
Security alarm system	£315.00
Rear window grilles for rear doors, not tailgate	£195.00

	Total (exc. VAT)
<b>PROTECTION – LOAD AREA</b>	
Plywood floor panel	from £411.00
Plywood side panel	from £93.00

	Total (exc. VAT)
<b>PROTECTION – EXTERIOR</b>	
Mudflaps – set of four	£123.00
Protective wheel arch mouldings	from £152.00

	Total (exc. VAT)
<b>ROOF CARRIER SYSTEM</b>	
Base carrier	
– H1 aluminium	£134.00
– H2 aluminium	£170.00
– H1 steel (black)	£159.00
– H2 steel (black)	£149.00
L1 H1	
– roof rack tray	from £773.00
– walkway	from £215.00
L2 H1	
– roof rack tray	from £724.00
– walkway	from £252.00
L1 H2	
– roof rack tray	from £874.00
– walkway	from £215.00
L2 H2	
– roof rack tray	from £898.00
– walkway	from £248.00

	Total (exc. VAT)
<b>TOWING<sup>1</sup></b>	
Fixed tow bar with 7-pin electrics	£620.00
Fixed heavy-duty tow bar with 7-pin electrics	£754.00
Removable tow bar with 7-pin electrics	£738.00
Fixed tow bar with 13-pin electrics	£631.20
Fixed heavy-duty tow bar with 13-pin electrics	£682.15
Removable tow bar with 13-pin electrics	£849.00

<sup>1</sup> = Prices for standard vehicles only.

**Please note:**

Prices shown are fully fitted and painted where applicable.

All prices are exclusive of VAT.

It is advisable to ensure your insurance policy is adequate to cover additional fitted accessories.

Prices correct at time of publication.

# MOVANO ACCESSORIES

	Total (exc. VAT)
<b>SAFETY</b>	
Safety pack – first aid kit, warning triangle, hi-visibility vest	£30.00
First aid kit	£12.00
Warning triangle	£14.00
Hi-visibility vest	£7.00
<b>PRACTICAL</b>	
Spare bulb kit	£16.00
Stretch tow rope – 3 tonne	£29.00
Smoker Pack	£44.00
<b>SECURITY</b>	
Steering wheel security bar	£78.00
Rear window grilles – H1, H2, H3	£133.00
Side sliding door (offside) window grille – L2, L3, L4	£134.00
Side sliding door (nearside) window grille – L2, L3, L4	£159.00
<b>PROTECTION</b>	
Carpet front floor mat	£54.00
Anti-slip mat	£76.00
Seat covers – standard (all models)	from £146.00
Seat covers – premium (all models)	£168.00
Mudflaps – set of four	
– L1/L2	from £135.00
Rear parking distance sensor (4 sensors)	£204.00
Rear-view camera	£291.00

	Total (exc. VAT)
<b>ROOF CARRIER SYSTEM</b>	
Base carrier	
– H1	£271.00
– H2	£273.00
L1 H1	
– Aluminium roof rack including roller	£860.00
– Steel walkway	£257.00
L1 H2	
– Aluminium roof rack including roller	£860.00
– Steel walkway	£257.00
L2 H2	
– Aluminium roof rack including roller	£970.00
– Steel walkway	£301.00
L3 H2	
– Aluminium roof rack including roller	£962.00
– Steel walkway	£299.00
L4 H2	
– Aluminium roof rack including roller	£955.00
– Steel walkway	£296.00

	Total (exc. VAT)
<b>TOWING</b>	
Flange tow bar with 13-pin electrics	from £494.00

**Please note:**

Prices shown are fully fitted and painted where applicable.

All prices are exclusive of VAT.

It is advisable to ensure your insurance policy is adequate to cover additional fitted accessories.

Prices correct at time of publication.



### FOR MORE PRODUCT INFORMATION

For a brochure on any Vauxhall model (up to a maximum of three per caller) or location of your nearest Vauxhall Retailer please call **0345 600 1500**. Alternatively, details can be found on our website at [www.vauxhall.co.uk](http://www.vauxhall.co.uk)

### JOIN US ONLINE:



### PROUD SPONSOR OF OUR NATIONAL FOOTBALL TEAMS



Every effort has been made to ensure that the contents of this document were accurate and up-to-date at the time of publication – 1 August 2017. The invoice price, including delivery to Retailer, factory-fitted options, accessories fitted by the Retailer and number plates, is subject to VAT. The right is reserved to alter specifications and prices, and withdraw products from sale, without notice. Please note that Vauxhall Retailers are not the agents of General Motors UK Limited and are not authorised to bind General Motors UK Limited by any specific or implied undertaking or representation. It is advisable to ensure that your motor insurance policy provides adequate cover for additional fitted options and accessories. All rights reserved. No part of this publication may be reproduced in any form or by any means, without the prior written permission of General Motors UK Limited.

General Motors UK Limited t/a Vauxhall, Griffin House, UK1-101-135, Osborne Road, Luton, Bedfordshire, LU1 3YT. [www.vauxhall.co.uk](http://www.vauxhall.co.uk)

©2017 General Motors UK Limited

**COMMERCIAL VEHICLES**  
*The Wheels of Business*



**VAUXHALL**